

TAIYO RC



6V POWER MINI JET HOVERCRAFT

Powers over land and water on a cushion of air



OWNER'S MANUAL

Important! Please read your Owner's Manual all the way through before operating your hovercraft. Contains important information—keep for future reference.

Safety First

- Adult supervision is recommended.
- Adult supervision strongly recommended, and use extra caution, when playing near water or ice. Do not go onto ice on a lake or other body of water that might be dangerous if it breaks.
- Drive your hovercraft in a safe area away from people, pets, cars, etc. Not in streets, not in darkness!
- Don't touch or try to pick up hovercraft when it is in motion. Wait until it stops completely.
- Keep hair, fingers, face and loose clothing away from top and rear propellers while the hovercraft is switched on or while the transmitter is operating.
- Never block rotation of top lift fan or stick any object through top, bottom or rear grilles.
- Do not drive hovercraft into walls or other hard objects.
- Be a responsible Mini Jet Hovercraft™ operator!

NOTICE: EXOTIC HOVERCRAFT! NOTE SPECIAL OPERATING CONDITIONS

• No wheels	• Rides on cushion of air created by lift fan blowing downward and into air bag "skirt".
• Goes on floor, dirt, pavement, ice, snow	• Needs flat, smooth, clean surface so skirt can "seal" with ground for best results.
• Multi-terrain capable	• Not for use on rough or broken pavement/ground, carpet, rocks, pebbles, grass, decking, hills, inclines or any surface that "lets the air out" or damages skirt.
• Goes on fresh water (pool, pond or lake, not salt/sea/ocean water)	• Pilot must keep craft within radio and battery life range on water to ensure retrieval.
• True amphibious hovercraft	• Not a boat; needs lift fan on with full power and air bag skirt inflated to float properly.
• High-power, double motor design	• Battery life 10-15 minutes between charges, depending on battery.
• Real rubber air bag skirt	• Skirt is durable but can puncture on sharp rocks, sticks.

How it Works

Lift fan/air compressor blows downward, inflating air bag skirt, which seals with the ground and creates a cushion of air under the hovercraft. Propellers at rear of hovercraft provide thrust for movement along the ground.

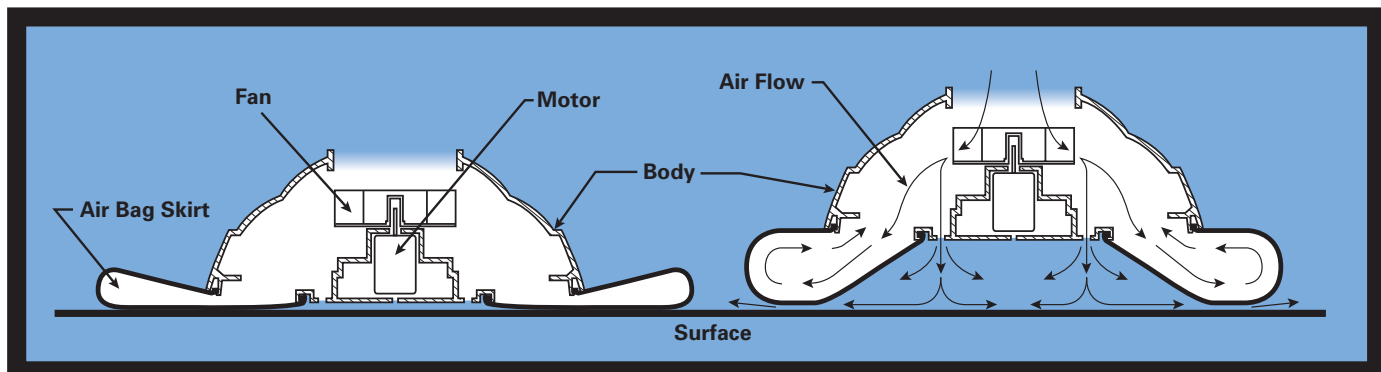

Batteries and Charger

(included)

TAIYO exclusive 6.0-Volt Rechargeable NiMH Battery Pack and Battery Charger for NiMH Battery Packs (This 6.0V NiMH Battery Pack is specially developed for this MINI JET HOVERCRAFT)

One 9-Volt (6F22) Battery for Transmitter (not rechargeable)

Battery Cautions

CAUTION: TO AVOID BATTERY LEAKAGE

1. Make sure the batteries are inserted correctly and follow the toy and battery manufacturer's instructions.
2. Make sure battery polarity (direction) is correct.
3. Use only battery type(s) recommended.
4. Remove rechargeable batteries from the product before charging. Recharge batteries only under adult supervision and follow the battery and charger manufacturers' instructions.

Other Battery Cautions

1. Use caution removing battery from hovercraft after use. Battery may be hot.
2. Never pull the battery pack out of the hovercraft by the wire or plug. Never unplug the battery plug by pulling on the battery.
3. Remove batteries from the product for storage.
4. Do not recharge non-rechargeable batteries.
5. Do not short-circuit battery terminals.
6. Dispose of batteries safely and properly, according to your local requirements.

NOTE: NICKEL METAL HYDRIDE BATTERIES MUST BE RECYCLED OR DISPOSED PROPERLY.

Battery Charging and Care

(Batteries and Charger included)

Hovercraft will not run without a TAIYO exclusive 6.0V rechargeable NiMH battery pack and matching charger, adult supervision of battery charging is recommended.

ADDITIONAL IMPORTANT BATTERY SAFETY INFORMATION

- Regularly examine charger and battery pack for damage, including plugs, casings and all other parts. If damaged, do not use.
- Not a toy—not intended for children under 3 years old.
- Make sure the batteries are inserted with the correct polarity and follow the toy and battery manufacturers' instructions.
- Remove weak or exhausted batteries from the product.
- An adult should help with battery replacement
- Only batteries of the same or equivalent type as recommended in the "Battery Installation" (or replacement) instructions are to be used.
- Non-rechargeable batteries are not to be recharged.
- If removable rechargeable batteries are used, they are only to be charged under adult supervision.
- Rechargeable batteries are to be removed from the product before they are charged.
- If you use a battery charger, it should be examined regularly for damage to the cord, plug, enclosure and other parts. Do not use a damaged battery charger until it has been properly repaired.
- Dispose of batteries safely and properly.



NiMH

THIS PRODUCT USES A NICKEL METAL HYDRIDE BATTERY. MUST BE RECYCLED OR DISPOSED PROPERLY. Contact your local area office of solid waste management or other appropriate local agency for information.

Running and Charging Times

1. NiMH battery packs are not like alkaline batteries. They lose all their power suddenly, not gradually, and hovercraft will stop very soon after slowing down becomes noticeable, with little warning. This is normal, but keep it in mind, especially when operating on water, since you need to get the hovercraft back before the battery power runs out.
2. Typical running time will be between 10 - 15 minutes for a typical freshly charged NiMH battery pack in good condition, but do not rely on this until you observe how long your battery runs in your hovercraft under the conditions you operate in. Running time may vary over life of battery, with the first few charge cycles yielding shorter run times than later charges.

BATTERY CHARGING INSTRUCTIONS

NOTE: "CONDITION" BATTERY PACK FOR BEST RESULTS BY CHARGING ACCORDING TO THESE INSTRUCTIONS ON EVERY CHARGE. ON THE FIRST CHARGE, EXPECT A SHORTER RUN TIME. RUN TIMES WILL INCREASE OVER THE NEXT 6 CHARGES, REACHING SPECIFIED RUN TIMES.

Drain Down — Cool Down — Charge Up

1. After the first charge, for best performance always run the battery pack all the way down before recharging. Run until vehicle wheels/fans/motors slow to a stop.
Note: If you are operating a boat, hovercraft or other water vehicle in water, retrieve the vehicle while battery power is still strong and perform this Drain Down procedure on land. (Don't operate other kinds of vehicles in or near water.)
2. Allow the battery pack to cool before recharging.

Battery Heat

1. Battery gets hot after use! This is normal, but be careful. Wait until battery is cool (20 minutes or more if needed) before charging. Charging batteries when they are hot will severely reduce the number of times they can be recharged.
2. After charging, battery pack will be warm. This is normal.

RECHARGING INSTRUCTIONS

1. Plug wall pack charger into a standard wall outlet.
2. Connect the battery pack plug to the charger plug as shown.
3. Red light on charger will light to show charger is operating. Normal charging time is approximately 4 hours.
4. Unplug charger from wall after 4 hours of charging.
5. After charging, battery pack will feel warm. This is normal.

Rechargeable Battery Tips

1. Don't overcharge the battery pack. Unplug the charger from the wall at the end of the recommended charging time.
2. NiMH battery packs are not like alkaline batteries. They lose all their power suddenly, not gradually, and vehicle will stop very soon after slowing down becomes noticeable, with little warning. This is normal, but keep it in mind, especially when operating on water, since you need to get the vehicle back before the battery power runs out.
3. Store your battery pack discharged.
4. Your battery pack will hold a charge for a shorter time in hot weather. Otherwise, you can charge a battery a day or so in advance of when you want to use it or give it as a gift.
5. It's better to charge for the full 4 hours, even though the vehicle may operate with a partial battery charge.
6. When your battery pack's running time gets shorter and shorter, probably it's getting close to the end of its life and needs to be replaced.

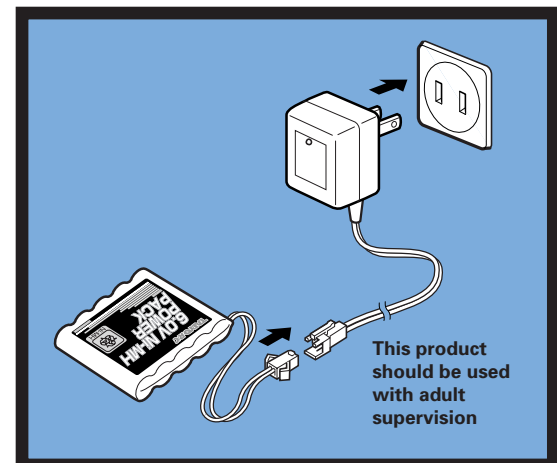

Hovercraft Features

●Hovercraft

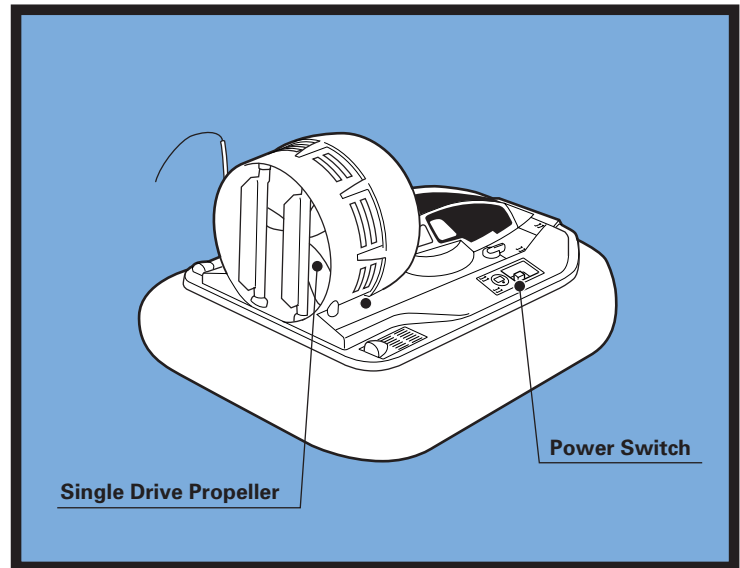
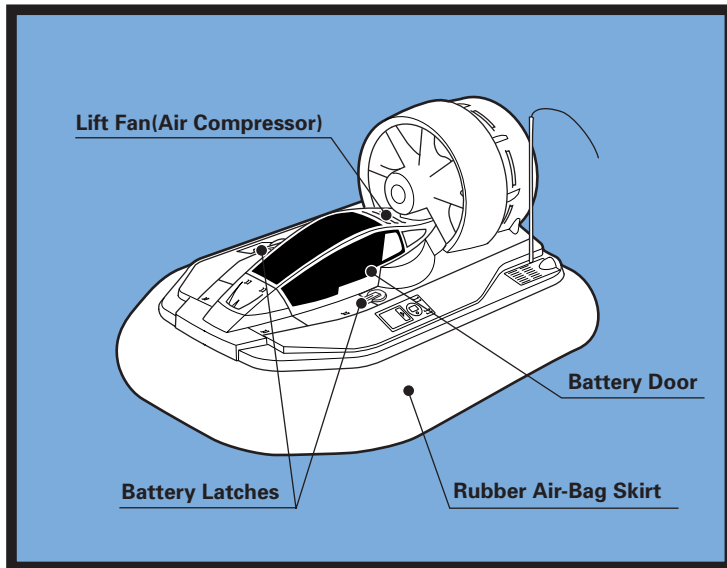

Transmitter Battery Installation

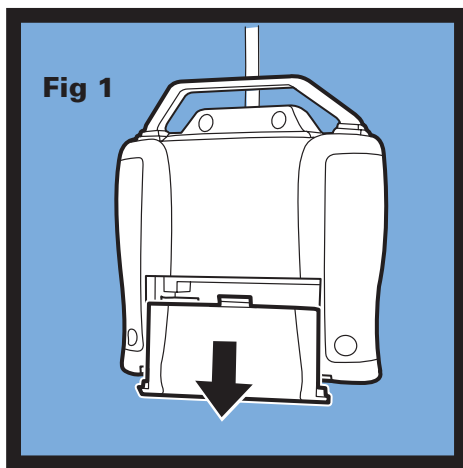

1. Slide open BATTERY DOOR on back of Transmitter.

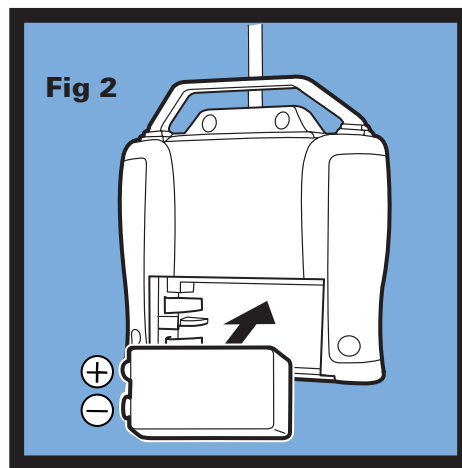

2. Insert a fresh, new 9-VOLT (6F22) BATTERY with the correct polarity (+/-) as shown on the inside of battery compartment.

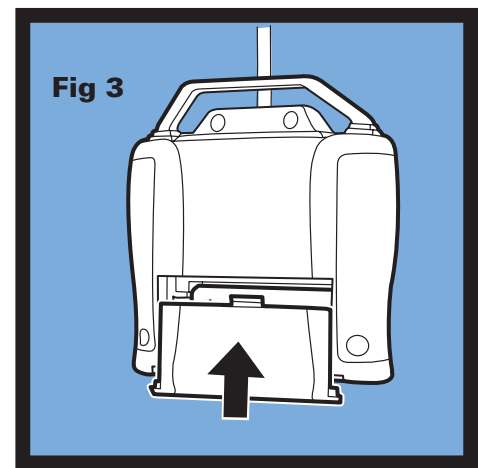

3. Hold battery in place with thumb and replace BATTERY DOOR. (Do the opposite process indicated in 1.)

●Transmitter

The Transmitter does not have ON/OFF switch. The switch will be ON only when the stick is in control. The switch will be OFF after a period of non-use.

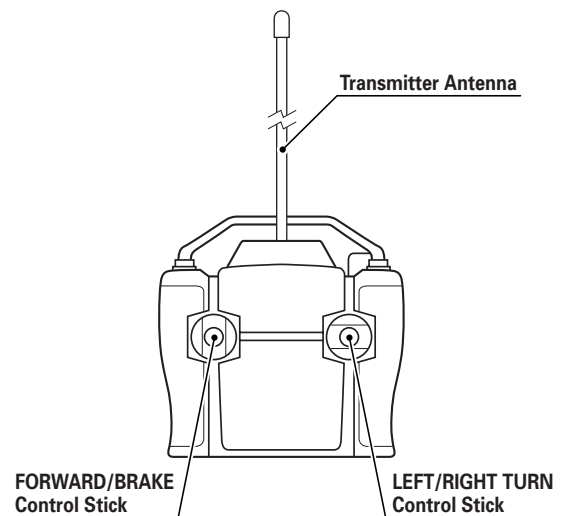

Hovercraft Battery Installation

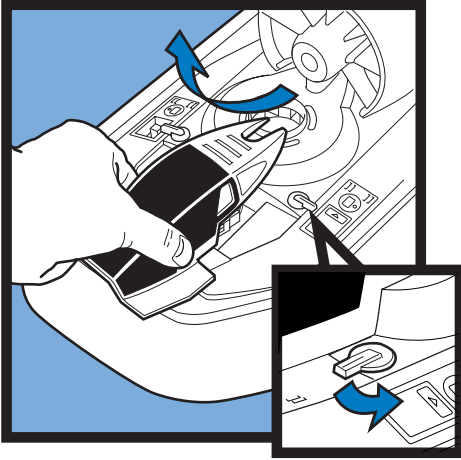

1. Confirm that the main switch is OFF. Turn LATCHES on vehicle BATTERY DOOR, lift door at rear and remove.

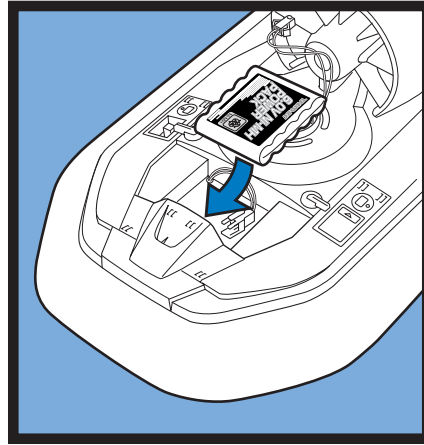

2. Insert fully charged BATTERY PACK into battery compartment as shown. Observe position of wire as shown.

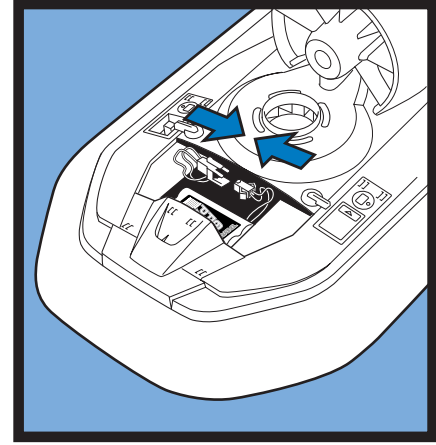

3. Firmly insert BATTERY PLUG all the way into SOCKET as shown. Make sure the "key" (bump) on plug is facing downward to fit into notch in socket.

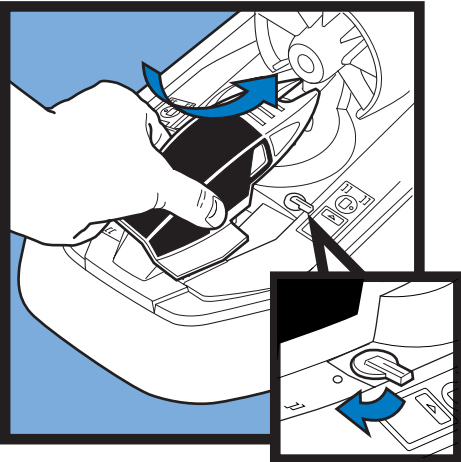

4. Replace BATTERY DOOR by aligning the door and compartment, lowering rear of door into place and turning LATCHES to locked position (Do the opposite process indicated in 1.)

5. Check operation by turning power switch to ON and then OFF again. Power switch is located on the top right of hovercraft. Lift Fan should go ON and OFF. If not, remove and reinsert the battery plug. Turn the power switch OFF to save power while changing battery whenever possible.



Only use exclusive 6.0V rechargeable Ni-MH battery Pack (included) for proper function & safety.

*Check whether the rechargeable batteries are fully charged before insertion.

*For charging process, please read the BATTERY CHARGING INSTRUCTIONS.

How to operate your Hovercraft

●Before operating the hovercraft, turn the switch ON.
(The lift fan will operate and hovercraft will be in lifted position)

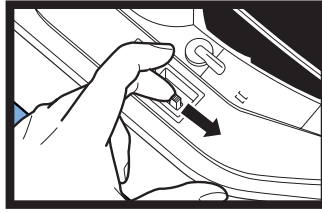

●FORWARD

Push the LEFT stick up. Release to coast.

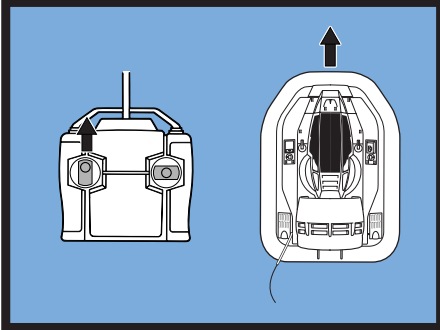

●BRAKING/REVERSE THRUST

Push the LEFT stick down.

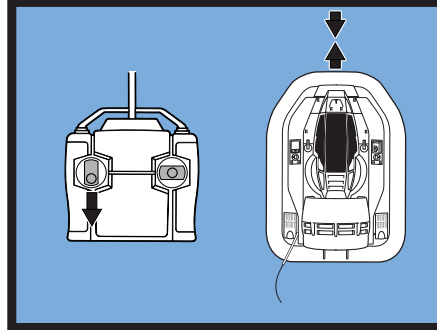

●LEFT TURN

Push the LEFT stick up and turn the RIGHT stick to the left.

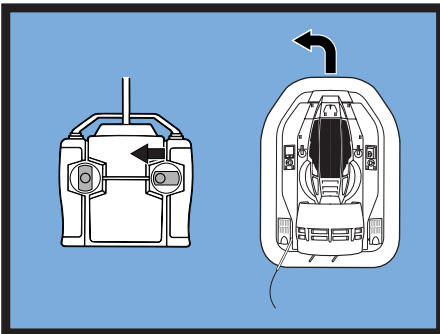

●RIGHT TURN

Push the LEFT stick up and turn the RIGHT stick to the right.

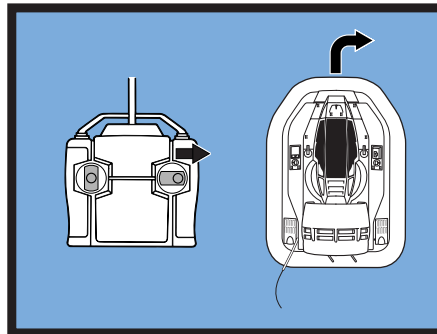

Operating on Water

Fresh water only--not sea or salt water!

CAUTION: ADULT SUPERVISION IS STRONGLY RECOMMENDED WHEN OPERATING ON OR NEAR WATER OR ICE.

Important: Time the use of the hovercraft on water so you can recover it before the battery runs out! Run for only 5 minutes each launch with a freshly charged battery to be sure.

Launching

1. Turn hovercraft power on.
2. Hold hovercraft as shown. Make sure lift fan is at full speed and air bag skirt is fully inflated. Carefully place hovercraft on water. (Fig. 10)
Important: Lift fan must be operating for hovercraft to operate properly. Air bag skirt may fill with water if lift fan is not running.
3. When removing from water, remove battery door and battery pack, hold hovercraft as shown and shake out excess water. (Fig. 11) Dry hovercraft after use with a clean soft cloth.

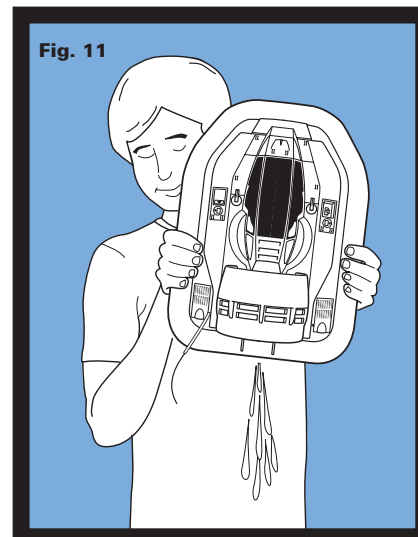
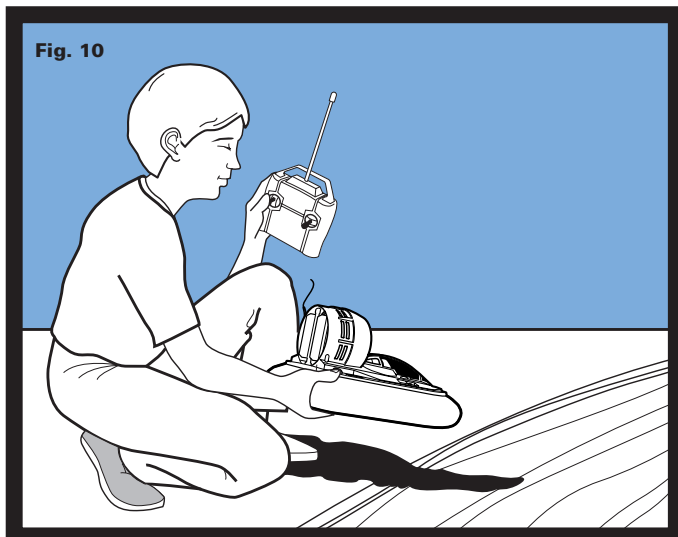

Hovercraft Tips

1. In order to race or operate two hovercrafts together, one must be 27MHz (Silver/Blue) and one must be 40MHz (Silver/Red).
2. Hovercraft are not designed to go up hills or inclines.
3. Water should be calm, without waves, turbulence or strong currents. Do not operate in rivers or streams.
4. Do not operate hovercraft in salt water. Salt will corrode metal parts and void warranty.

Air Bag Skirt Care

1. Do not operate your hovercraft where the surface is with sharp edge, rough surface or high temperature heat to avoid skirt wreck or worn out in order to make Air Bag Skirt last longer.
2. When the Air Bag Skirt has been accidentally wrecked or worn out, do not repair by yourself, because of its particular skirt sealing structure. Please kindly contact the Customer Service Hot Line indicated on the first page of the Manual, or contact the shop where you have purchased.

R/C Facts for Improved Operation

1. When battery start to fully discharge, hovercraft may slow, stop, or refuse to respond to your control. It's time to recharge hovercraft battery or replace transmitter battery. This is absolutely the #1 cause of all problems and questions!
2. Radio frequency interference can interfere with the control of your hovercraft. Buildings, power wires, other R/C transmitters, or CB radio can all cause problems. Pick a place to drive and keep away from these things.
3. Hold Transmitter so antenna points up, not toward the hovercraft. Keep hovercraft within range (about 20 meters) to keep control. If hovercraft goes out of range, try lifting transmitter high into air to increase range for hovercraft recovery.
4. Wipe hovercraft clean and dry after each use, including inside battery compartments.
5. Turn hovercraft power switch off immediately after running. Remove batteries for storing. Keep hovercraft and Transmitter away from heat and direct sunlight and moisture.

Troubleshooting Guide

Don't take your hovercraft back to the store--try solving problems using this valuable guide.

Problem	Probable Cause	Correction
Hovercraft runs slowly, or won't move, or won't steer	<ul style="list-style-type: none">- Batteries dead or low- Batteries installed incorrectly- Loose battery connection- Power switch is off	<ul style="list-style-type: none">- Remove and replace batteries, making sure battery direction (polarity, ⊕/⊖) is correct and battery compartment contacts are clean.- Recharge hovercraft battery. Replace transmitter battery.- Turn on Power switch.
Erratic operation, loss of control, short range	<ul style="list-style-type: none">- Radio interference- Weak Transmitter battery- Weak hovercraft battery	<ul style="list-style-type: none">- Move to another location.- Point antenna up in the air, not at hovercraft. Don't touch antenna.- Recharge 6.0V battery pack or replace 9V (6F22) battery in transmitter.
Hovercraft stops working after going in water or snow	<ul style="list-style-type: none">- Water in battery/electronics/motor areas	<ul style="list-style-type: none">- Turn power switch off IMMEDIATELY, remove all batteries, dry inside and out with clean soft cloth and allow to dry overnight with battery door off.
Battery life is short	<ul style="list-style-type: none">- Battery pack not charged fully- Battery pack charged when hot- Battery pack faulty or worn out	<ul style="list-style-type: none">- Recharge battery pack- Always allow battery pack to cool before charging- Replace battery pack

NOTE:

The manufacturer is not responsible for any radio or TV interference caused by unauthorized modifications to this equipment. Such modifications could void the user's authority to operate the equipment.

PRINTED IN CHINA

©2004 Taiyo Kogyo Co., Ltd. 1-23-17, Higashiyotsugi, Katsushika-ku, Tokyo, Japan All Rights Reserved. Product specifications subject to change. Product may differ from illustrations.