



Using Your Zodiac™ Handheld



POWERED

Copyright

Copyright © 2003, Tapwave, Inc. All rights reserved. Portions copyright © 1996 - 2003, PalmSource, Inc. and its affiliates. All rights reserved. This documentation may be printed and copied solely for use in using the Zodiac handheld. In addition, two (2) copies of this documentation may be made for archival and backup purposes. Except for the foregoing, no part of this documentation may be reproduced or transmitted in any form or by any means or used to make any derivative work (such as translation, transformation or adaptation) without express written consent from Tapwave, Inc. and PalmSource, Inc.

Tapwave, Inc. reserves the right to revise this documentation and to make changes in content from time to time without obligation on the part of Tapwave, Inc. to provide notification of such revision or changes.

TAPWAVE, INC. AND ITS SUPPLIERS MAKE NO REPRESENTATIONS OR WARRANTIES THAT THE DOCUMENTATION IS FREE OF ERRORS OR THAT THE DOCUMENTATION IS SUITABLE FOR YOUR USE. THE DOCUMENTATION IS PROVIDED ON AN "AS IS" BASIS. TAPWAVE, INC. AND ITS SUPPLIERS MAKE NO WARRANTIES, TERMS OR CONDITIONS, EXPRESS OR IMPLIED, EITHER IN FACT OR BY OPERATION OF LAW, STATUTORY OR OTHERWISE, INCLUDING WARRANTIES, TERMS, OR CONDITIONS OF MERCHANTABILITY, FITNESS FOR A PARTICULAR PURPOSE, AND SATISFACTORY QUALITY. TO THE FULL EXTENT ALLOWED BY LAW, TAPWAVE, INC. ALSO EXCLUDES FOR ITSELF AND ITS SUPPLIERS ANY LIABILITY, WHETHER BASED IN CONTRACT OR TORT (INCLUDING NEGLIGENCE), FOR DIRECT, INCIDENTAL, CONSEQUENTIAL, INDIRECT, SPECIAL, OR PUNITIVE DAMAGES OF ANY KIND, OR FOR LOSS OF REVENUE OR PROFITS, LOSS OF BUSINESS, LOSS OF INFORMATION OR DATA, OR OTHER FINANCIAL LOSS ARISING OUT OF OR IN CONNECTION WITH THIS DOCUMENTATION, EVEN IF TAPWAVE, INC. OR ITS SUPPLIERS HAVE BEEN ADVISED OF THE POSSIBILITY OF SUCH DAMAGES.

Tapwave, the stylized Tapwave logo, and Zodiac are trademarks of Tapwave, Inc. in the United States and/or other countries. Palm OS, Graffiti, HotSync, and PalmSource are registered trademarks of PalmSource, Inc. or its affiliates. Palm, the Palm logo, the HotSync logo, Palm Powered, the Palm trade dress, are trademarks of PalmSource, Inc. or its affiliates. All other product and brand names may be trademarks or registered trademarks of their respective owners.

IF THIS DOCUMENTATION IS PROVIDED ON A COMPACT DISC, THE OTHER SOFTWARE AND DOCUMENTATION ON THE COMPACT DISC ARE SUBJECT TO THE LICENSE AGREEMENT ACCOMPANYING THE COMPACT DISC.

MPEG Layer-3 audio decoding technology is licensed from Fraunhofer IIS and Thomson Licensing S.A.

P/N:

Table of Contents

About This Guide	10
1 Introduction to your Zodiac Handheld	11
System requirements	11
Connecting the cable or cradle	12
Charging the battery.	13
Charging tips	14
Battery life	14
Starting your handheld for the first time	15
Palm Desktop software	15
Installing Palm Desktop software	16
Using your handheld with another desktop organizer	17
Zodiac components	17
About the front panel	17
About the back panel	19
Removing the stylus	20
Connecting the headphones	20
Adjusting the screen orientation	21
Adjusting the speaker volume and screen brightness	21
Opening applications	22
Learning to navigate.	23
Status Bar.	24
Input Area	25
Entering data	26
Navigation controls	27
Menus	27
Command toolbar	28
Tips.	29

2 Entering Data in Your Zodiac Handheld	30
Entering data using Graffiti 2 handwriting software	30
Learning to write Graffiti 2 characters	30
General Guidelines for Graffiti 2 Writing	31
Graffiti 2 tips	32
The Graffiti 2 alphabet	33
Writing punctuation marks and other special characters	34
Using Graffiti 2 Gestures	36
Using Graffiti 2 ShortCuts	36
Using the onscreen keyboard	37
Using your computer keyboard	38
Using an external keyboard	39
Importing data	39
3 Managing Applications	41
Using the Home screen	41
Customizing the Home screen display	43
Arranging icons on the radial menus.	43
Organizing applications.	43
Setting Home screen preferences	45
Viewing information on an application	46
Installing add-on applications	47
Removing add-on applications.	48
Removing Palm Desktop software	49
4 Using Music	50
Opening Music	50
Deleting songs	52
Conserving power while playing songs	53
5 Using Photos	54
Opening Photos	54
Setting the slide show interval	56
Deleting pictures	57
Copying pictures	57

6 Playing Games	59
Playing multi-player games	60
7 Using Clock	61
Opening Clock.	61
8 Performing Common Tasks	64
Creating records	64
Editing records	65
Selecting Text.	65
Using the Edit menu	65
Deleting records.	66
Purging records	67
Categorizing records.	67
Moving a record into a category.	68
Displaying a category of records.	68
Adding or editing categories	69
Finding records	70
Finding Address Book records	70
Using the Find dialog box	71
Using Phone Lookup	71
Sorting records	72
Sorting To Do List records	72
Sorting Address Book and Memo Pad records	73
Making records private.	74
Hiding private records.	74
Displaying private records.	75
Attaching notes	75
Deleting a note	76
Choosing fonts	77
9 Using Address Book	78
Opening Address Book.	78
Adding and using Address Book entries	79
Creating an Address Book entry	79
Viewing an address entry	81

Duplicating an entry	81
Selecting different types of phone numbers and addresses	81
Editing Address Book entries	82
Changing Address Book display	83
Adding custom fields at the end of Address Edit screens	83
10 Using Date Book	85
Opening Date Book	85
Scheduling events	86
Scheduling timed events for the current date	87
Scheduling a timed event for another date.	89
Scheduling untimed events	89
Adding Address Book information to an event	90
Rescheduling events	90
Scheduling repeating or continuous events	91
Changing repeating or continuous events	91
Setting the alarm	93
Setting an alarm for an event	93
Snoozing the alarm	94
Setting alarm options	95
Changing the Date Book view	96
Working in Week view.	96
Working in Month view	98
Working in Agenda view	99
Spotting event conflicts	100
Changing the Date Book display	100
Changing the displayed Start and End Times.	101
11 Using Memo Pad	103
Opening Memo Pad	103
Creating memos	104
Reviewing memos	105
Arranging the Memo List.	105

12 Using To Do List	106
Opening To Do List106
Creating To Do List items.107
Setting To Do List priorities.108
Checking off To Do List items.109
Changing priorities and due dates110
Sorting To Do items111
Setting To Do List preferences111
13 Using Calculator	113
Opening Calculator113
Using the Calculator buttons.114
Displaying recent calculations115
14 Setting Preferences	116
Opening the Preferences screens.116
Bluetooth117
Calibration118
Connection118
Date & Time120
Formats122
General123
Graffiti 2.124
Network.124
Network Details.127
Login scripts128
Connecting to your ISP or dial-in service131
Owner.131
Phone.132
ShortCut133
Sound.134
15 Synchronizing Data	136
Performing a cable or cradle HotSync operation136
Selecting HotSync setup options.138
Customizing HotSync application settings139

IR HotSync operations	141
Preparing your computer for infrared communication.	141
Configuring HotSync Manager for infrared communication	143
Performing an IR HotSync operation	143
Returning to using the cradle for HotSync operations	144
Creating a user profile	144
Using a profile for the first-time HotSync operation	145
16 Security	146
Masking and hiding records.	147
Masking private records	147
Hiding private records	147
Assigning and editing passwords	148
Locking your handheld	149
Turning on and unlocking your handheld.	150
Recovering from a forgotten password	150
Deleting a forgotten password	150
17 Using the Attention Manager	151
Insistent alarms.	151
Using the Reminder dialog screen	151
Setting alarm sound effects	152
Using the Reminders list screen	153
Subtle alarms.	154
Understanding the blinking alarm indicator	154
18 Using Expansion Cards	155
Inserting and removing an expansion card	156
Accessing applications on an expansion card	156
Displaying information about applications on an expansion card.	157
Copying an application from an expansion card	158
Beaming or sending applications from an expansion card	159
Deleting applications from an expansion card	160
Using CardInfo	161
Renaming an expansion card.	162
Reformatting an expansion card	162

19 Beaming and Sending Information	163
Creating a business card164
Beaming a record164
Beaming an application165
Receiving beamed information.165
Sending information with Bluetooth communication166
20 Maintaining Your Handheld	167
Upgrade information167
Upgrading your Palm Desktop software168
Maintaining a unique name for each handheld.168
Caring for your Zodiac169
21 Frequently Asked Questions	170
Resetting your handheld.170
Performing a soft reset170
Performing a hard reset171
Installing add-on software171
Troubleshooting TCP/IP connections171
22 Regulatory Information	173
Federal Communication Commission Interference Statement173
Important Note: FCC Radiation Exposure Statement173
Index	174

About This Guide

Welcome to Using Your Zodiac™ Handheld. This guide is designed to help you get up and running quickly on your handheld. It describes all you need to know about how to use your Zodiac handheld and the applications that come with it.

This guide shows you how to:

- Identify all the parts of your handheld
- View and enter data
- Use the applications that come with your handheld
- Use your handheld with your computer
- Personalize your handheld with your own preference settings

After you become familiar with the basic functionality of your Zodiac handheld, you can use this guide as a reference for less common tasks, for maintaining your Zodiac handheld, and as a source of information if you have problems operating it. For additional information visit tapwave.com.

Some of the applications that come with your Zodiac handheld are documented separately. If you do not find information about a particular application in this guide, look for the .pdf file in the folder for that application on the CD that came with your Zodiac handheld or visit tapwave.com.



Introduction to your Zodiac Handheld

Your Zodiac handheld combines a full mobile entertainment experience -- including music, photos, movies, and interactive video games -- with the best organizer tools available.

Using HotSync® technology you can add media to your handheld as well as synchronize (exchange, update, and backup) your personal data.

Your Zodiac handheld gives you everything you need to go, do, and play.

System requirements

To install and operate Palm Desktop software your computer system must meet the following minimum requirements:

- Windows 98 SE/2000 (with service pack 3)/me/XP Home/XP Pro (with administrator rights)
- IBM-compatible Pentium computer or higher
- 40 MB available hard disk space
- CD-ROM drive
- One available USB port

In addition, the following equipment is required for optional connectivity features:

- Internet service provider (ISP)
- Compatible mobile phone



Connecting the cable or cradle

The HotSync cable or cradle that comes with your Zodiac handheld enables you to synchronize the information on your handheld with your computer.

IMPORTANT: If you are upgrading from another Palm Powered™ handheld, follow the instructions on [page 167](#) before connecting the cradle and installing the Palm Desktop software.

- 1. Turn off your computer.**
- 2. Plug the HotSync cable or cradle into a USB port on your computer.**
- 3. Plug the power adapter into a power outlet.**
- 4. Connect the power adapter cable and the HotSync cable.**

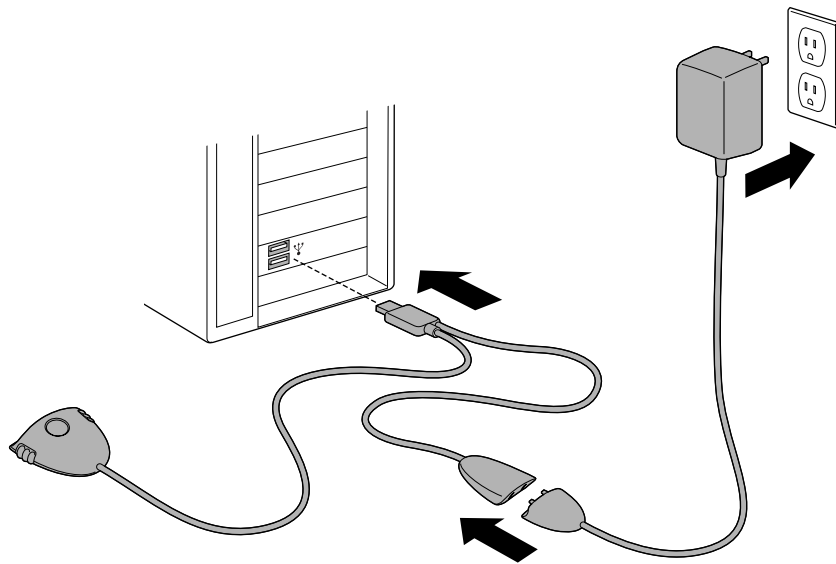



Charging the battery

To use your Zodiac handheld, you must connect it to an AC outlet and charge the battery.

1. Connect your handheld to an AC outlet using one of these three setups:

- **Desktop Setup.** Connect the optional HotSync cradle (sold separately) to the HotSync cable, your computer, and an outlet as described in the cradle instructions, and then insert your handheld in the cradle.
- **Travel Setup.** Connect the HotSync cable to your computer and an outlet as described on [page 12](#), and then connect your handheld to the HotSync cable.
- **Ultra-light Setup.** Connect the power adapter cable to your handheld.

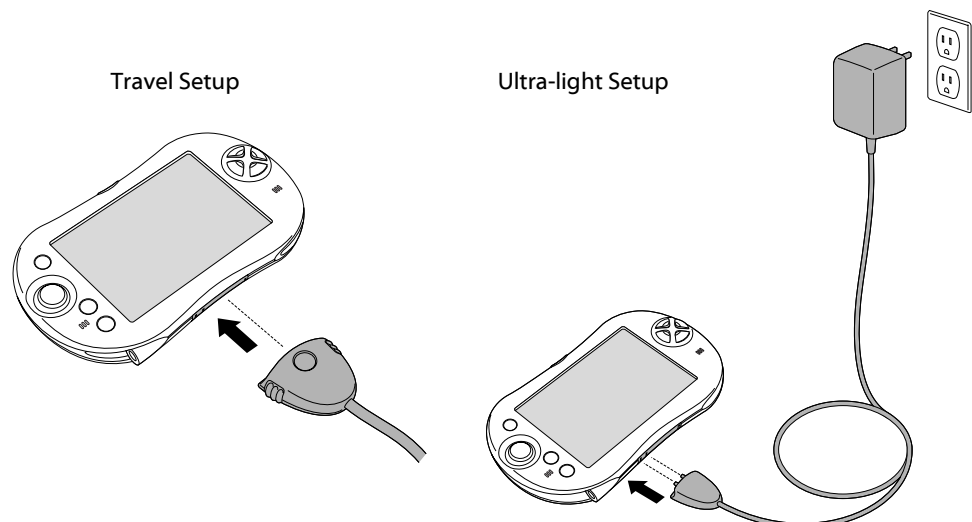

2. Wait approximately 2 hours for the battery to fully charge.

While your handheld charges, the LED repeatedly increases in brightness. When your handheld is fully charged, the LED turns green.

When your handheld needs to be recharged, the LED blinks and turns yellow. When the LED turns red, your battery is extremely low.



Charging tips

- Although you can turn your handheld on while it is charging, your handheld charges more quickly while it is turned off.
- The battery has a built-in sensor to prevent it from overheating. This also means that it stops charging if the environment is too warm.
 - Keep in mind that operating your handheld while charging the battery generates heat.
 - We do not recommend charging your handheld in environments that are over 86 degrees Fahrenheit.
 - If you must charge your handheld in temperatures above 91 degrees Fahrenheit, do not turn it on while it is charging.

Battery life

Extend the life of your battery by following these guidelines:

- Use the lowest brightness setting you find comfortable (see page 21).
- Turn off your handheld as soon as you finish using it. Do not wait for the auto timeout to turn it off.
- Keep the Auto-off after setting in General Preferences set to 30 seconds in case you forget to turn off your handheld.
- Use the headphones when listening to music and videos and keep the volume low. Playing them loudly through the internal speakers will significantly reduce battery life. Playing them loudly through the headphones can permanently damage your hearing.
- Turn off Bluetooth when you're not using it.
- Turn off the Beam Receive setting in General Preferences when you're not using the IR port to receive information from another device.



Starting your handheld for the first time

The first time you start your Zodiac handheld, setup instructions appear on the screen. These instructions guide you through calibrating the touch-screen (also called the digitizer) and the analog controller.

1. **Press the power button** .
2. **Follow the onscreen instructions, tapping the screen and moving the analog controller**  where indicated.

Palm Desktop software

Palm Desktop software includes many of the same applications as your Zodiac handheld: Photos, Music, Address Book, Date Book, To Do List, and Memo Pad. You can use the HotSync feature of this software to load, exchange, and backup files between your handheld and your computer.

It's a good idea to back up your files in case something happens to the data on your Zodiac handheld. Changes you make on your Zodiac handheld or Palm Desktop software appear in both places after you synchronize.

Using the Palm Desktop software, you can do the following:

- Work with your Zodiac handheld applications on your computer to view, enter, and modify files stored on your handheld.
- Back up the files stored on your handheld with HotSync technology and synchronize the files in your Palm Desktop software. Synchronization is a one-step procedure that ensures your data is always safe and up-to-date. See [page 136](#) for more information.
- Load compatible files and applications onto your handheld from your computer.
- Import and export data, so you can easily transfer data from other desktop applications into selected applications. See [page 39](#) for more information.
- Print your Date Book, Address Book, To Do List, and Memo Pad information on any printer.



Installing Palm Desktop software

The following instructions guide you through installing Palm Desktop software so that you can transfer data from your computer to your handheld.

Before you begin, make sure you connected the HotSync cable or cradle to your computer as described on [page 12](#).

After installation, refer to the online Help in Palm Desktop software for information on how to use the software.

IMPORTANT: Do not copy the Palm Desktop software files to your computer's hard disk. You must use the installer to place the files in their proper locations and to decompress the files.

- 1. Exit any open programs, including those that run at startup (such as Microsoft Office), and disable any virus-scanning software.**
- 2. Insert the Palm Desktop software CD into the computer's CD-ROM drive.**

NOTE: If the installation does not begin automatically, click the Windows Start button, choose Run, enter D:\autorun.exe, and then click OK. If necessary, replace D: with the drive letter assigned to your CD-ROM drive.

- 3. Follow the onscreen instructions to complete the installation. When prompted, complete the following steps:**
 - a. Install Palm Desktop software.**
 - b. Select or create a user name.**
 - c. Connect your handheld to the cable or cradle and synchronize.**

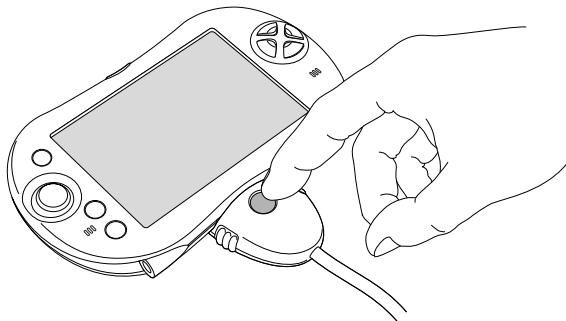

- d. Select free Bonus Software applications for installation.**
- e. Create your FREE tapwave.com account.**



Using your handheld with another desktop organizer

If you prefer to use another desktop organizer, such as Microsoft Outlook, you can use it instead of installing Palm Desktop software. All you need to install are HotSync Manager and the connection software (sold separately) for your desktop organizer, called a conduit, that lets you synchronize the data between your handheld and your desktop organizer.

Zodiac components

About the front panel

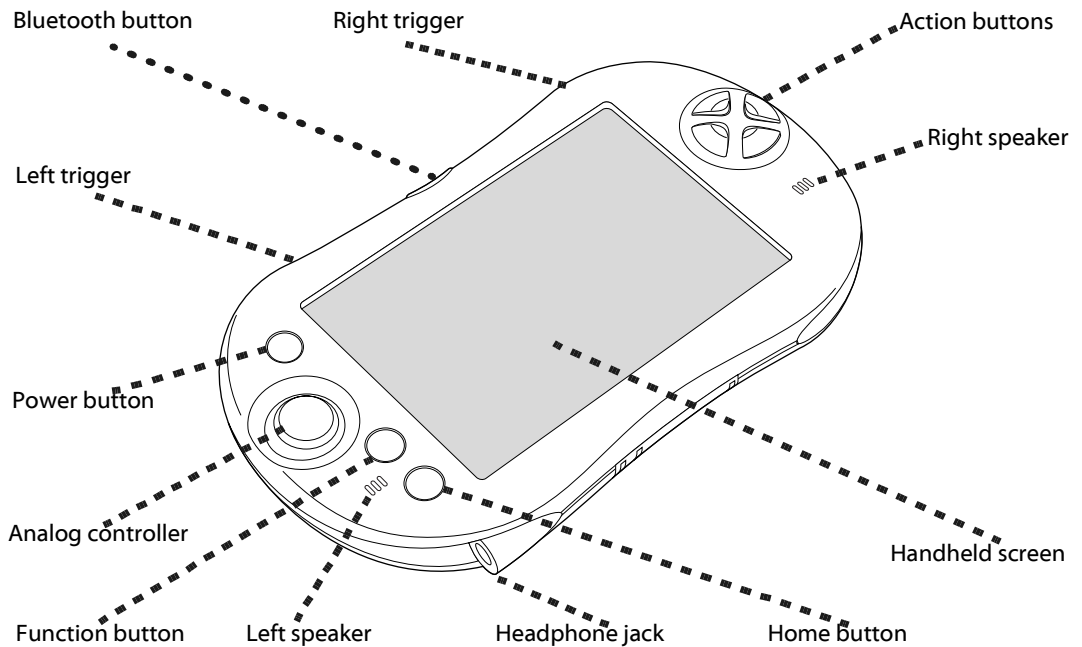

- **Bluetooth button.** Activates the built-in Bluetooth radio so that your Zodiac handheld can communicate with other devices that are enabled with Bluetooth technology. For details, see [page 117](#) and [page 166](#).
- **Trigger buttons.** Performs various actions based on the application.



Introduction to your Zodiac Handheld

Zodiac components

- **Power button.** Turns the handheld on (if it is off) and returns to the last screen that was displayed. Press the power button again to turn the handheld off.

Pressing and holding the power button opens the dialog box where you can adjust the sound volume and screen brightness. For details, see [page 21](#).

The power button also includes an LED that changes color based on the status of the battery.

- **Green.** Appears when your handheld is connected to the cable or cradle and it is fully charged.
 - **Yellow.** Appears when your handheld is charging.
 - **Red.** Appears when your handheld battery is critically low and needs to be charged.
- **Analog controller.** Allows you to navigate through the Home screen and move around within applications. Move it in the direction you want to go, or press it when centered to select an item. For details, see [page 23](#).
 - **Function button.** Performs various actions based on the application. For example, in Date Book you can press this button to change the calendar display format.
 - **Left/Right speakers.** Enables you to listen to music and game sounds without using the headphones.
 - **Headphone jack.** Enables you to connect headphones to your handheld so you can discreetly listen to music and game sounds.
 - **Home button.** Opens the Home screen where you can select a game or application that you want to start. For details, see [page 41](#).
 - **Handheld screen.** Displays the applications and data stored in your handheld. It is touch-sensitive and responds to the stylus.
 - **Action buttons.** Activates various functions based on the application. For example, in a game, these buttons might be used for acceleration, braking, stunts, or weapons, but in the Home screen, these buttons are shortcuts to your favorite games or applications. See [page 45](#) for details on the Enable Quick Launch option to assign your favorite shortcuts to these buttons.



About the back panel

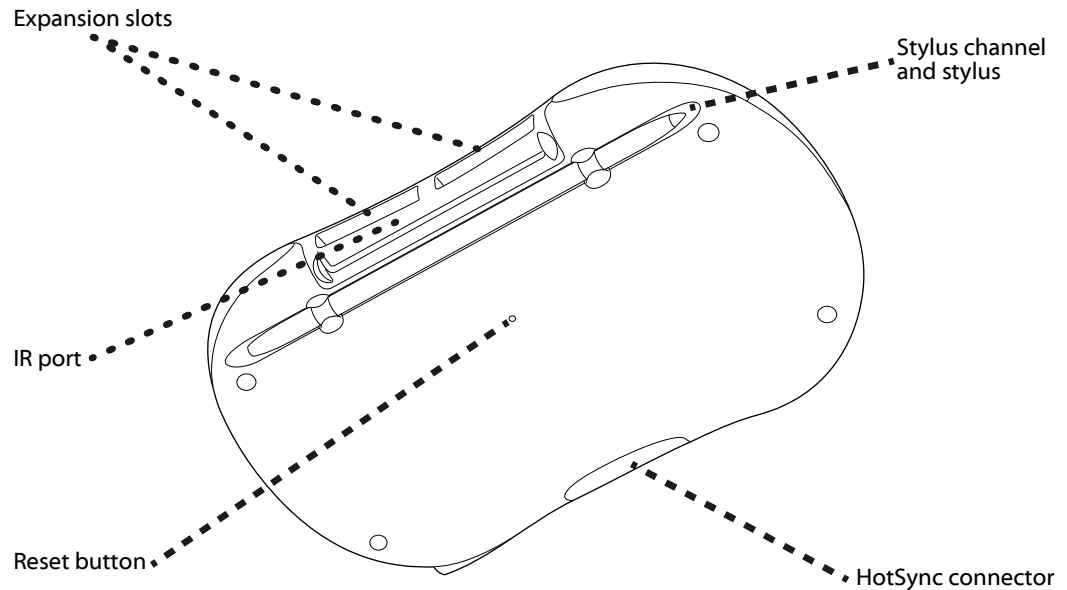

- **Reset button.** Under normal use, you should not have to use the reset button. See [page 170](#) for information on when and how to use the reset button.
- **IR port.** Uses infrared technology to transmit data to and receive data from other devices, see [page 163](#) for details. You can also use the IR port to perform HotSync operations, see [page 141](#) for details.
- **Expansion slots.** Enables you to expand your handheld's storage capacity and capabilities by inserting expansion cards. See [page 155](#) to learn more about using expansion cards.
- **HotSync connector.** Connects your handheld to the cable or cradle, which in turn connects to your computer and the AC adapter. This allows you to recharge your handheld and to synchronize the information between your handheld and your computer using HotSync technology. For more information, see [page 136](#).
- **Stylus channel and stylus.** Holds the stylus when you are not using it. The stylus is the writing instrument you use to enter data on your handheld.



Removing the stylus

To use the stylus, remove it from the channel and hold it as you would a pen or pencil.

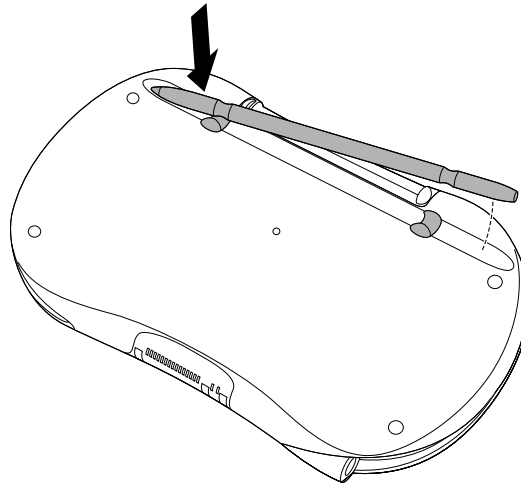

Connecting the headphones

Your Zodiac handheld includes a pair of stereo headphones that you can use while listening to music, playing games, or watching video clips. Using headphones or external speakers instead of the built-in speakers also conserves battery power.

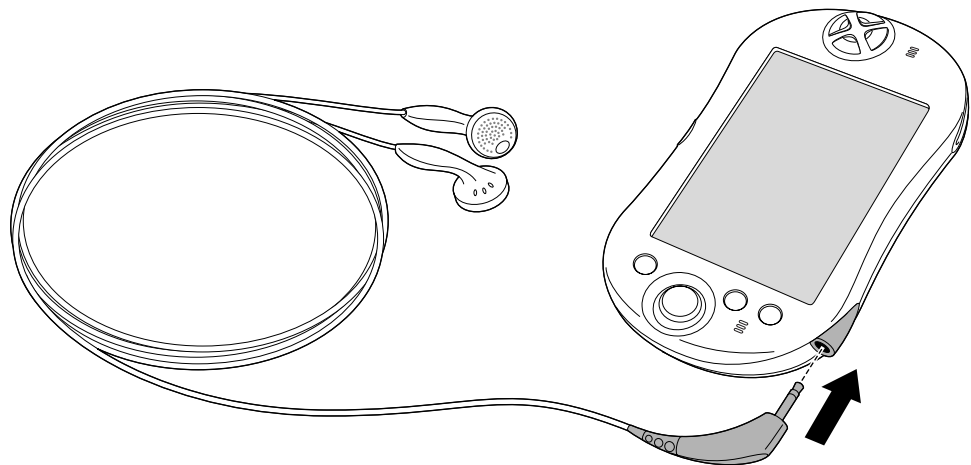

IMPORTANT: When using the headphones, keep the volume soft. Listening to loud volumes through the headphones can permanently damage your hearing.



Adjusting the screen orientation

In many applications you can change the orientation of your Zodiac display by switching between portrait (vertical) and landscape (horizontal) mode.

- Tap the Orientation icon  in the Status Bar to switch between portrait and landscape mode. See [page 24](#) to learn about the Status Bar.

TIP: In landscape mode, you can also choose whether the Status Bar and Input Area appear on the left or right side of the screen. For details, see [page 123](#).

Adjusting the speaker volume and screen brightness

You can quickly adjust the volume level or sound in your applications and the brightness of your screen to make it easy to see in a variety of lighting conditions.

1. Press and hold the power button .

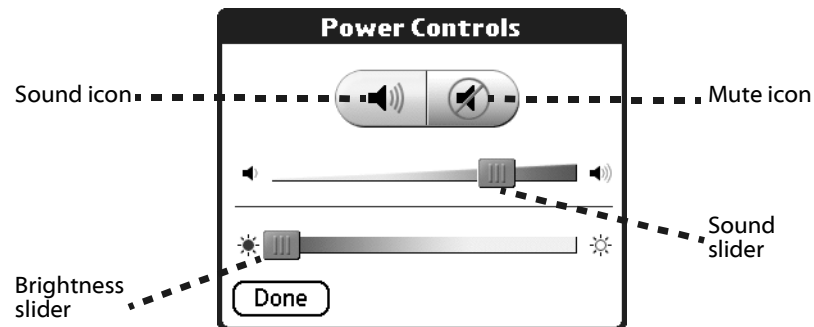

2. Adjust the sound by doing one of the following:

- Tap the Sound icon and drag the slider to adjust the volume level.
- Tap the Mute icon and choose how long the sound remains off.

3. Adjust the brightness by doing one of the following:

- Drag the slider to adjust the brightness.
- Tap to the right or left of the slider to adjust the brightness in small increments.

4. Tap Done.



Opening applications



You can use the Home screen to open any application installed on your handheld. The Home screen displays your user name, the current time, the battery level, a radial menu of your favorite categories, and a list of remaining categories.

You can choose which icons appear on the radial menu and which icons appear on the list. If you have expansion cards inserted in the expansion slots, each card appears as a category.

1. Press the Home button .



2. Open a category by doing one of the following:

- Move the analog controller  in the direction that corresponds to the category you want to open. The placement of the icon on the radial menu corresponds to the directional controls on the analog controller. After you highlight your selection, release the analog controller to open the category.
- Press the Function button to move from the radial menu to the list, and then scroll to a category on the list. With the analog controller  centered, press it to open the category.
- Tap a category icon on the screen.

TIP: To view a list of all your applications, select All from the category list on the right side of the screen.

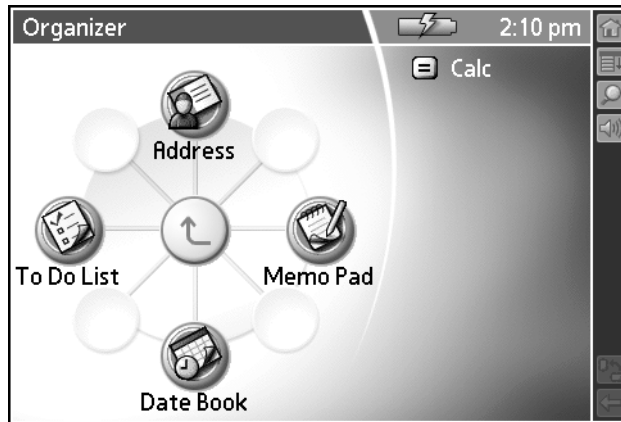

3. Open an application by doing one of the following:

- Move the analog controller ✱ in the direction that corresponds to the application you want to open. The placement of the icon on the radial menu corresponds to the directional controls on the analog controller. After you highlight your selection, release the analog controller to open the application.
- Scroll to an application icon in the All view list (if you already selected the All category). With the analog controller ✱ centered, press it to open the application.
- Press the Function button to move from the radial menu to the list, and then scroll to an application on the list. With the analog controller ✱ centered, press it to open the application.
- Tap an application icon on the screen.

Learning to navigate

Just as you use a mouse pointer to click elements on your computer's screen, you use the stylus to tap elements on your handheld's touch-sensitive screen. Tapping is the basic action used to perform tasks on your handheld. In addition, you can drag the stylus to select text.

IMPORTANT: Always use the point of the stylus for tapping or making strokes on the handheld screen. Do not use a pen, pencil, or any other sharp object to write or tap on the handheld screen, as it may damage the screen. If you misplace your stylus, visit tapwave.com for information on a replacement.



Status Bar

The Status Bar can appear on the far right, on the far left, or at the bottom of your screen. When you tap an element on the Status Bar, it performs the following actions:

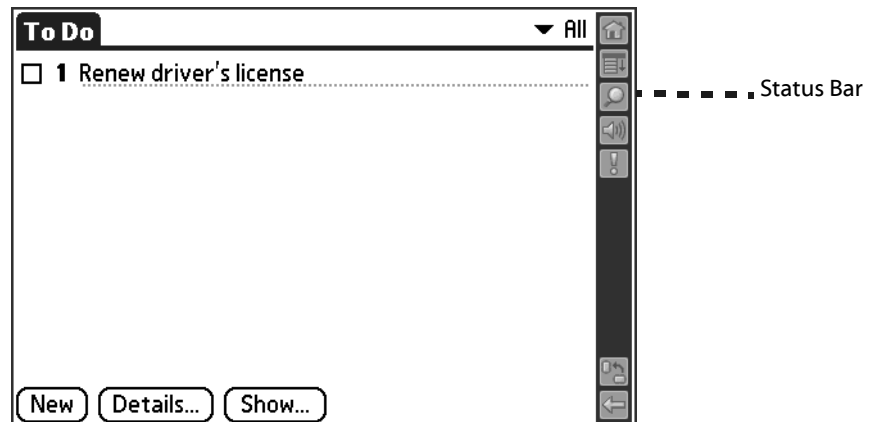

- **Home icon** . Displays the Home screen where you can open applications.
- **Menu icon** . Displays the menu bar where you can choose menu commands.
- **Find icon** . Opens the Find dialog box where you can perform system-wide searches on a text string.
- **Sound icon** . Displays the volume, mute, and brightness controls.
- **Attention icon** . Flashes when you have alerts to review.
- **Orientation icon** . Switches the orientation of the screen display between portrait and landscape mode (when available). In landscape mode, you can also choose whether the Status Bar and Input Area appear on the left or right side of the screen. This option is designed to facilitate left-handed data entry in applications that support this feature. For more information, see [page 123](#).
- **Expand/Collapse icon** . Expands and collapses the Input Area display to provide a larger viewing area while playing games or using applications where data entry is not required. If the application is designed to take advantage of the extra screen space, you can view additional information where the Input Area normally appears.



Input Area

The Input Area enables you to enter data on your handheld using Graffiti® 2 characters or the onscreen keyboard. It includes the following elements:

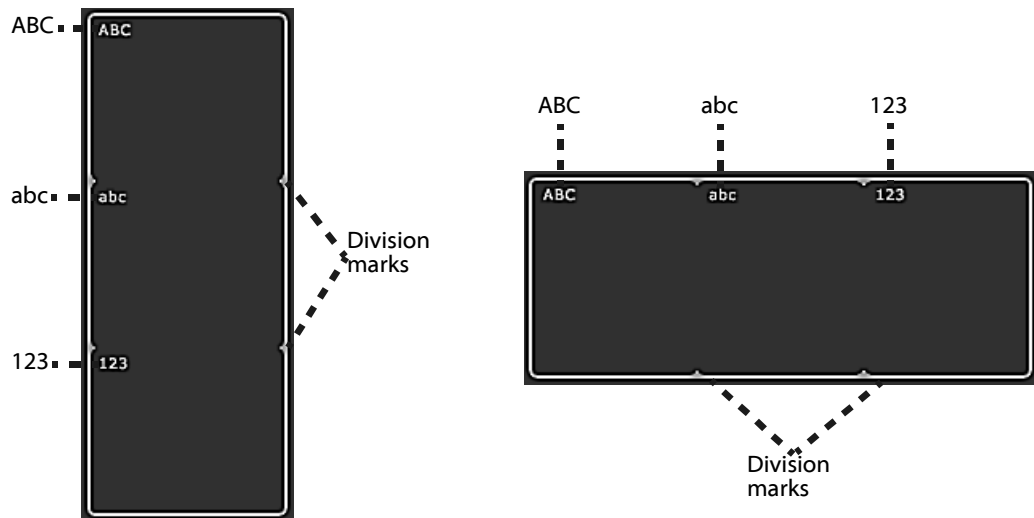

- **Division marks.** Separates the various portions of the Input Area.
- **ABC and abc.** Indicates which type of Graffiti 2 characters (upper or lower case) you can write in this portion of the Input Area. When you tap these icons, the alphabetic onscreen keyboard appears.
- **123.** Indicates that you can write numeric Graffiti 2 characters in this portion of the Input Area. When you tap this icon, the numeric onscreen keyboard appears.

NOTE: The cursor must be in an input field to enter Graffiti 2 characters or open the onscreen keyboard.



Entering data

You can enter text, numbers, and symbols into your Zodiac in four ways:

- Using Graffiti 2 (see [page 30](#))
- Using the onscreen keyboard (see [page 37](#))
- Using an external keyboard (see [page 39](#))
- Entering or importing data in Palm Desktop software, and then synchronizing with your handheld (see [page 38](#))

There are also onscreen controls that enable you to enter data by selecting options:

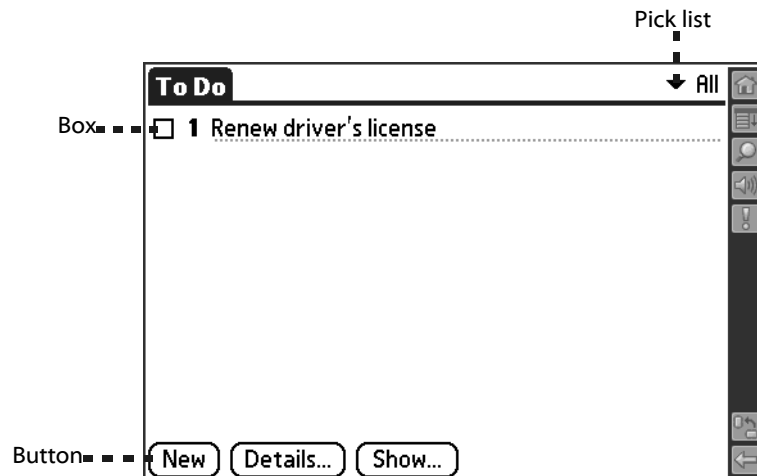

- **Pick list.** Displays a list of choices. Tap the black triangle next to the pick list name to display a list of choices, and then tap an item in the list to select it.
- **Box.** Indicates the state of the corresponding option. A check mark in a box means the option is active. If a box is empty, tapping it inserts a check mark. If a box is checked, tapping it removes the check mark.
- **Button.** Initiates a command when tapped. Buttons, such as New or Done, appear in dialog boxes and at the bottom of application screens.



Navigation controls

Many applications include onscreen controls that enable you to navigate through your data:

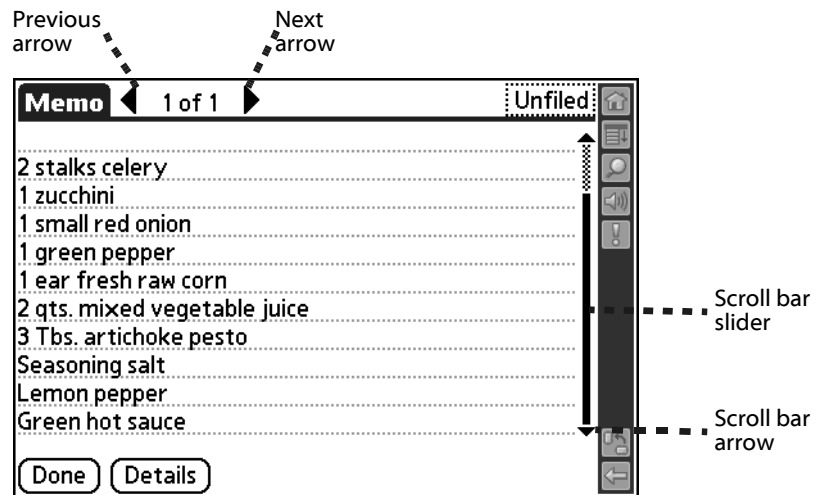

- **Next or previous arrow.** Displays the previous or next page of information.
- **Scroll bar.** Moves through long notes or memos. Tap and hold down the scroll bar slider to scroll through pages; tap the slider arrow at either end to move one line at a time. To scroll to the previous page, tap the scroll bar just above the slider; to scroll to the next page, tap the scroll bar just below the slider. You can also scroll to the previous and next pages by moving the analog controller Up and Down.

Menus

Menus and commands are specific to each application and area within the application. For example, in Memo Pad, the Memo List screen and the Memo screen display different menus.

Some applications or screens do not have menus. Where available, menu commands for each application are described in the corresponding application's chapter, with the exception of the Edit menu. For information on Edit menu commands, see [page 65](#).

1. Tap the Menu icon or the title bar to open the menu bar.

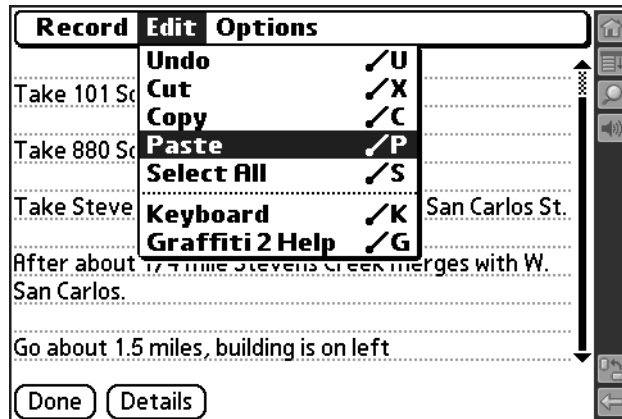

2. Select a command from the menu by tapping it with the stylus or by moving the analog controller * to highlight it and then pressing the analog controller while it is centered.

Command toolbar

The command toolbar enables you to initiate a command by tapping an icon or writing a Graffiti 2 quick stroke instead of using the menus. Most menu commands have an equivalent Graffiti 2 quick stroke, which is similar to keyboard shortcuts used to execute commands on computers.

The Graffiti 2 quick stroke appears next to the command in the menu. To use Graffiti 2 quick strokes, menus must be closed.

1. In the *abc* or *ABC* portions of the Input Area, draw the Graffiti 2 menu command stroke (a diagonal line from the lower-left to upper-right) to display the command toolbar.



2. Within 4 seconds, do one of the following:

- Tap an icon that represents the command you want. The icons vary within each application.
- Enter a Graffiti 2 quick stroke in the Input Area. For example, to choose Select All from the Edit menu, draw the letter S.



TIP: If you wait more than four seconds to draw the quick stroke letter, you need to redraw the menu command stroke to redisplay the command toolbar.

Tips

Many of the dialog boxes that appear on your handheld contain a Tips icon in the upper-right corner. Tips anticipate questions you may have and provide shortcuts for using the dialog box or other useful information.

1. Tap the Tips icon  in the upper-right corner of the dialog box.

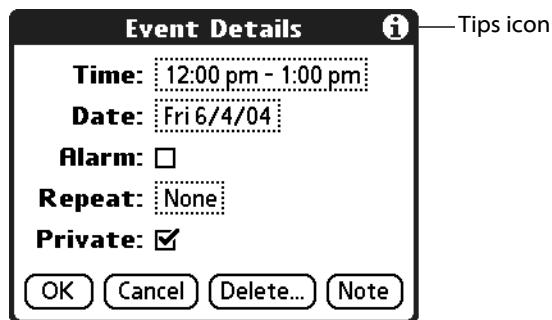

2. Tap Done after reading the tip.



Entering Data in Your Zodiac Handheld

You can enter data into your Zodiac handheld by using the onscreen keyboard, writing with the stylus in the Input Area, using your computer keyboard, using an external keyboard, or by importing data from another application.



Entering data using Graffiti 2 handwriting software

You can use Graffiti 2 strokes to create letters, numbers, punctuation, and symbols. The Graffiti 2 writing strokes include all letters, numbers, and symbols found on a standard keyboard.

Learning to write Graffiti 2 characters

With only a few minutes of practice, you'll find it easy to enter accurate text and numbers using Graffiti 2 writing strokes.

The Graffiti 2 demo shows how to use the handwriting software. The first time you turn on your handheld the Welcome application automatically guides you through the setup process. When you complete setup, you are invited to learn how to use the Graffiti 2 handwriting software.

After you view the Welcome application the first time, a Graffiti 2 Demo icon  appears in the Utilities category on the Home screen. Select this icon to view the demo at any time. You can also select the Welcome icon  in the Utilities category to view the Welcome application again.

TIP: When you reach the Stroke Lookup screen of the demo, use the pick list to view the wide variety of characters that you can make. As you tap a character, an animation of the strokes used to form that character appears.



Entering Data in Your Zodiac Handheld

Entering data using Graffiti 2 handwriting software

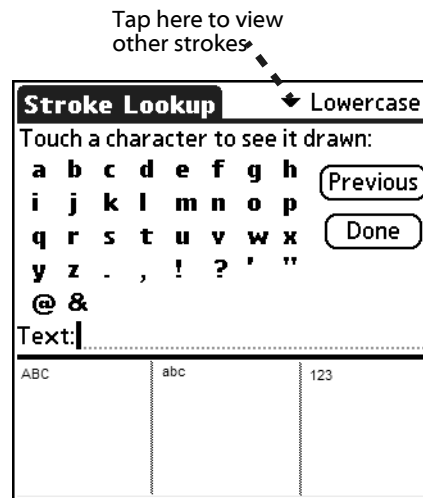

General Guidelines for Graffiti 2 Writing

Follow these guidelines to learn and use Graffiti 2 writing strokes successfully:

- To achieve 100% accuracy, practice drawing characters exactly as they appear in the tables later in this chapter.
- The heavy dot on each shape indicates where to start the stroke. Some characters have similar shapes, but different starting and ending points. Always start the stroke at the heavy dot, but do not draw the heavy dot; (it is there only as a guideline).
- The Graffiti 2 writing strokes for letters closely resemble letters of the standard English alphabet, both uppercase and lowercase. Graffiti 2 includes symbols made with a single stroke and symbols made with multiple strokes.

For multi-stroke characters, a temporary character appears after the first stroke, to show that the stroke was recognized. For example, after the first vertical stroke of "t", a temporary "l" is shown. There is a limited time window, during which you must draw the second stroke. Otherwise the temporary stroke is recorded.

- The Input Area is divided into three parts, one for writing uppercase letters, one for writing lowercase letters, and one for writing numbers. The small marks at the top and bottom of the Input Area define the division lines. To have your handheld recognize uppercase letters, lowercase letters, and numbers, you must begin the strokes in the corresponding portion of the Input Area.



Entering Data in Your Zodiac Handheld

Entering data using Graffiti 2 handwriting software

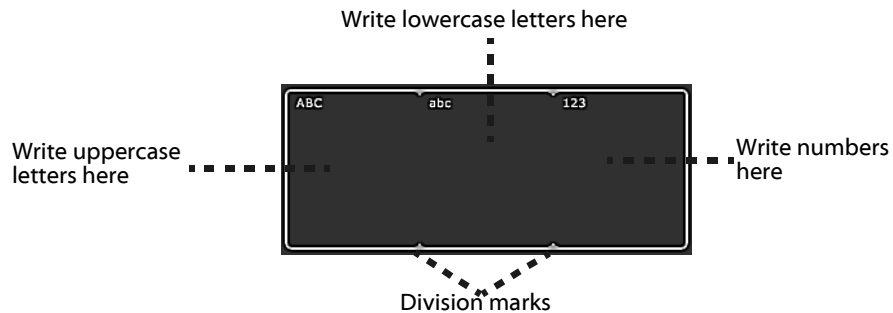

1. Tap the screen where you want to write text, for example, on a line next to a time in Date Book.

NOTE: A blinking cursor must appear onscreen in the entry field before you can begin writing text.

2. Use the tables on the following pages to find the stroke shape for the letter you want to write. For example, the stroke shown below creates the letter A.



You use the same shape to create both the lowercase letter and the uppercase letter.

3. Position the stylus in the appropriate place of the Input Area depending on whether you want to write an uppercase or lowercase letter.
4. Start your stroke at the heavy dot, and draw the stroke shape as it appears in the tables.
5. Lift the stylus from the screen at the end of the stroke shape.
6. Your handheld recognizes your stroke immediately and displays the letter at the insertion point onscreen. As soon as you lift the stylus from the screen, you can begin the stroke for the next character you want to write.

Graffiti 2 tips

When using Graffiti 2 writing, keep the following tips in mind:



Entering Data in Your Zodiac Handheld

Entering data using Graffiti 2 handwriting software

- For greater accuracy, draw letters with large strokes; strokes that nearly fill the Input Area are easily interpreted.
- To delete characters, set the insertion point to the right of the character you want to delete, and draw the Backspace stroke (a line from right to left) in the Input Area.
- Write at natural speed. Writing too slowly can produce errors.
- Do not write at a slant. Keep vertical strokes parallel to the sides of the Input Area.
- When letters and numbers can be written using two different strokes, use the one that's easiest for you.
- Press firmly.
- Some characters can be formed in more than way, and you can choose which method you prefer. See [page 124](#) for details.

The Graffiti 2 alphabet

Draw Graffiti 2 letters according to the following alphabet.

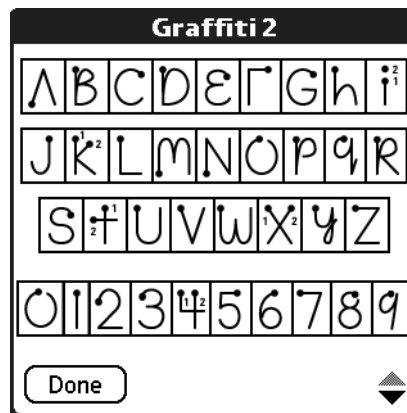



Writing punctuation marks and other special characters

Using Graffiti 2 writing, you can create any punctuation symbol and special character available from a standard keyboard.

- **Punctuation marks.** The period and comma punctuation marks can be written in any portion of the Input Area (the uppercase, lowercase, or number area). Other common punctuation marks can be written only in specific parts of the Input Area. The chart below indicates where the punctuation marks must be drawn (in general, the more frequently used punctuation is on the left side).
 - Characters that appear on the left side of the chart must be drawn in the alphabetic (uppercase or lowercase) portions of the Input Area.
 - Characters that appear on the right side of the chart must be drawn in the number portion of the Input Area.

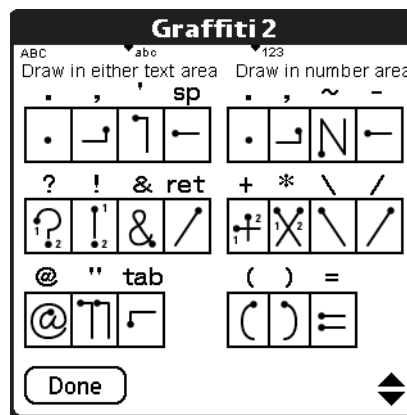

TIP: If you draw the Shift stroke (see [page 34](#)) before entering a punctuation mark, you can enter punctuation strokes anywhere in the Input Area. This requires an additional stroke, but you may find it more convenient, since you don't have to remember on which side of the Input Area to make the punctuation strokes.

- **Symbols and other special characters.** You can write symbols and other special characters using the Shift command. When you make a vertical stroke from the bottom to the top in the Input Area, the Shift indicator arrow appears in the lower right corner of the screen. While this arrow is visible, you can make the characters shown in the illustration below. Once the arrow goes away, the symbol or other special character appears.





Entering Data in Your Zodiac Handheld

Entering data using Graffiti 2 handwriting software

TIP: Using an additional Shift stroke to finish writing the character (as shown in the demo) is optional, but it makes the character appear more quickly.

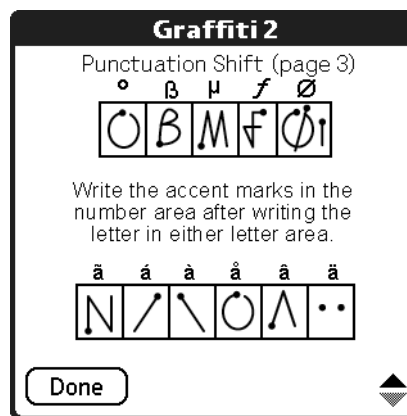
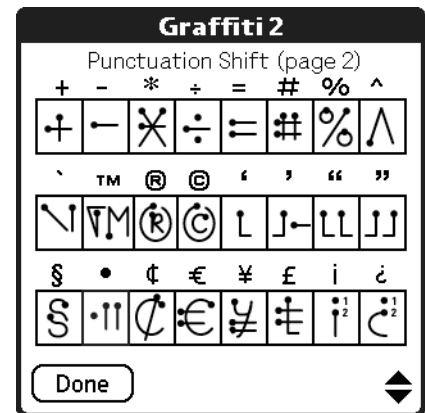
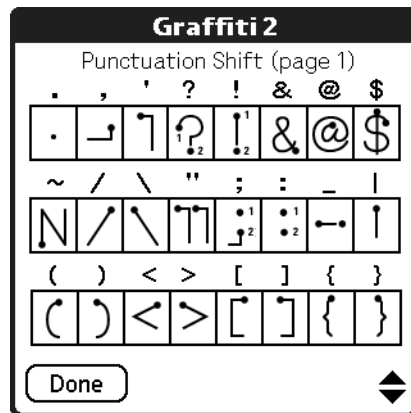
After drawing the Shift stroke, draw punctuation marks, symbols or accent marks using the following strokes:



TIP: Samples of the character strokes are available in the Graffiti 2 Help file. To view the Help file, tap the Menu icon , and from the Edit menu, select Graffiti 2 Help. Note that the accented characters appear on a Punctuation Shift screen, but do not use the Shift command.

- **Accented letters.** When writing letters with accent marks, first write the uppercase or lowercase letter stroke in the appropriate portion of the Input Area. Then quickly write the accent stroke in the number portion of the Input Area, as shown in the illustration above.



Using Graffiti 2 Gestures

Gestures are editing commands, such as cut, paste, and the ShortCut command which is explained in the next section. To use gestures, draw the following strokes:

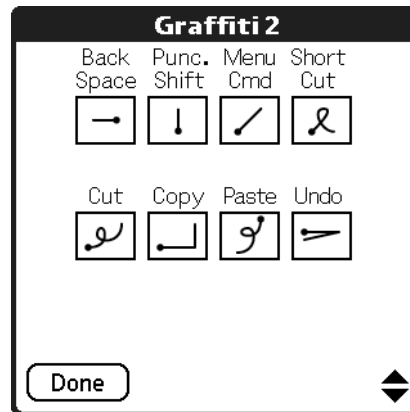

TIP: The Menu command stroke must be drawn in either of the letter portions of the Input Area. The remaining strokes can be drawn anywhere in the Input Area.

Using Graffiti 2 ShortCuts

Graffiti 2 ShortCuts let you quickly and easily enter commonly used words or phrases. ShortCuts are similar to the Glossary or Autotext features of some word processors. Graffiti 2 writing comes with several predefined ShortCuts. You can also create your own for any words, letters, or numbers, see [page 133](#) for details.

Your handheld includes the following predefined Graffiti 2 ShortCuts for common entries:

- br—Breakfast
- di—Dinner
- ds—Date stamp
- dts—Date/time stamp
- lu—Lunch



- me—Meeting
- ts—Time stamp

1. Draw the ShortCut stroke.

2. Draw the ShortCut character(s).

When you draw the ShortCut stroke, the ShortCut symbol appears at the insertion point.

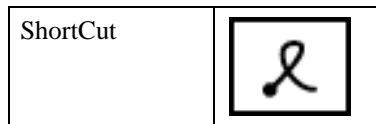

Using the onscreen keyboard

You can open the onscreen keyboard anytime you need to enter text or numbers on your handheld.

1. Open any application (such as Address Book).

2. Tap any record, or tap New.

3. In the Input Area, tap one of the following to display the corresponding onscreen keyboard:

- ABC or abc - display the alphabetic keyboard.
- 123 - displays the numeric keyboard.

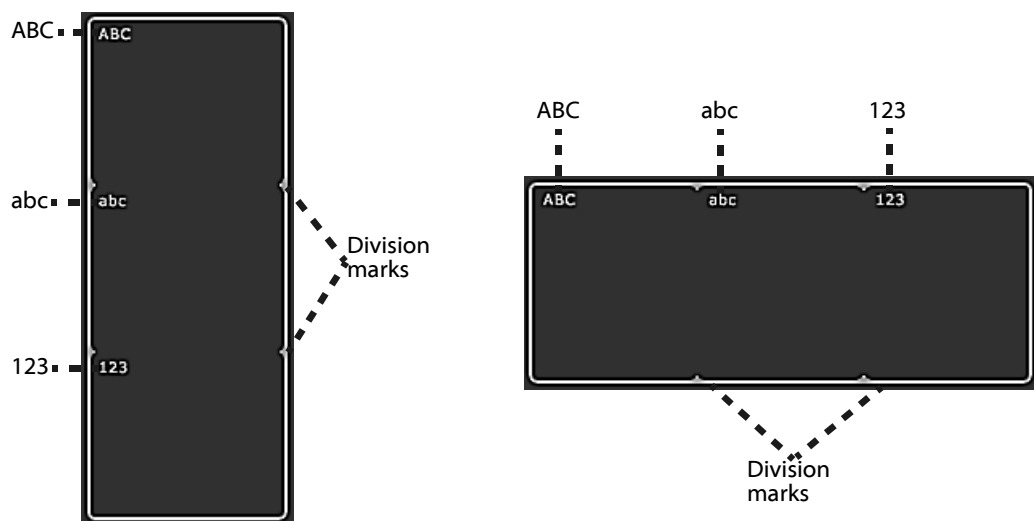



4. To display the international keyboard, open an onscreen keyboard, and then tap Int'l at the bottom of the keyboard display.

TIP: To select any of the three keyboards, tap the Menu icon  and then tap Edit. Tap Keyboard, and then tap the keyboard you want.

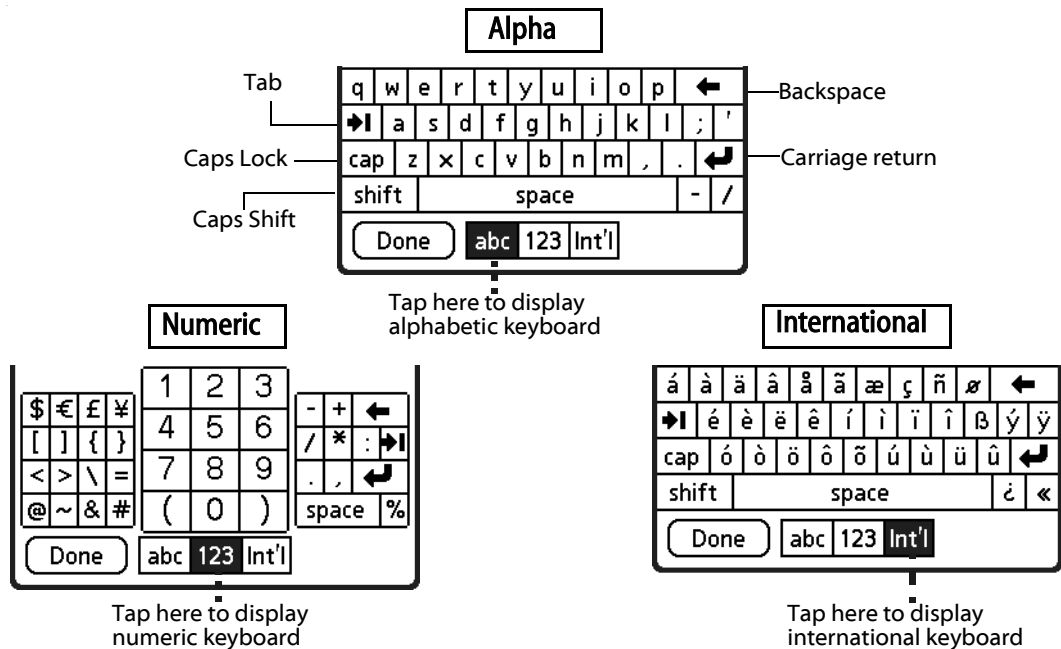

5. Tap the desired characters or numbers; then tap Done to enter the text or numbers.

Using your computer keyboard

At times, you may prefer to use your computer keyboard rather than the onscreen keyboard to enter or modify information on your handheld.

You can enter information from your computer keyboard using Palm™ Desktop software or any supported desktop organizer installed for use with your handheld. You can then perform a HotSync operation to synchronize the information on your computer with the information you entered on your handheld. All the Organizer applications on your handheld are available in Palm Desktop software and in most desktop organizer software.

Refer to Palm Desktop online Help for more information on entering data on your computer.



Using an external keyboard

You can connect an optional external keyboard accessory to the connector on your handheld so you can type data directly into your handheld. External keyboards are very useful for typing large amounts of data quickly and accurately while you are away from your computer.

Importing data

If you have data stored in computer applications such as spreadsheets and databases, or if you want to import data from another device, you can transfer the data to your Zodiac handheld without entering it manually. Save the data in one of the file formats listed below, import it into Palm Desktop software, and then perform a HotSync operation to transfer the data to your handheld.

Palm Desktop software can import data in the following file formats:

- Comma delimited (.csv, .txt): Address Book and Memo Pad only.
- Tab delimited (.tab, .tsv, .txt): Address Book and Memo Pad only.
- CSV (Lotus Organizer 2.x/97 Mapping): Address Book only.
- vCal (.vcs): Date Book only.
- vCard (.vcf): Address Book only.
- Date Book archive (.dba).
- Address Book archive (.aba).
- To Do List archive (.tda).
- Memo Pad archive (.mpa).

Archive formats can only be used with Palm Desktop software. Use the archive file formats to share information with other people who use Palm Powered handhelds or to create a copy of your important Palm Desktop information.

- 1. Open Palm Desktop software.**
- 2. Click the application into which you want to import data.**
- 3. If you are importing records that contain a field with category names, do the following:**



- a. **Select All in the Category box.**
- b. **Make sure that the same categories that appear in the imported file also exist in the application. If the categories do not exist, create them now; otherwise, the records are imported into the Unfiled category.**
- 4. Choose File > Import; then select the file you want to import, and click Open.**
- 5. To import data into the correct Palm Desktop fields, drag fields in the left column so that they are opposite the corresponding imported field on the right.**
- 6. To exclude a field from being imported, uncheck the field's box.**
- 7. Click OK.**
- 8. The imported data is highlighted in the application.**
- 9. To add the imported data to your handheld, perform a HotSync operation.**

See Palm Desktop online Help for more information on importing and exporting data.



Managing Applications

This chapter explains how to switch between applications on your Zodiac handheld, how to personalize application settings, and how to organize applications into related groups.

Using the Home screen

The Home screen enables you to open applications on your handheld. All the applications installed on your handheld are organized into categories which appear in the Home screen. By default the Home screen displays a radial menu and list of your application categories. When you choose a category, the applications in that category appear on the radial menu and in the list.

In addition to providing a way for you to open applications, the Home screen also displays your user name, the battery level, and the current time. When you open a category, the category name replaces your user name.

You can customize the Home screen as described later in this chapter.

1. Press the Home button  or tap the Home icon.





2. Open a category by doing one of the following:

- Move the analog controller ✱ in the direction that corresponds to the category you want to open. The placement of the icons on the radial menu correspond to the directional controls on the analog controller. After you highlight your selection, release the analog controller to open the category.
- Press the Function button to move from the radial menu to the list, then scroll to a category on the list. With the analog controller ✱ centered, press it to open the category.
- Tap a category icon on the screen.

TIP: To view a list of all your applications, select All from the category list on the right side of the screen.



3. Open an application by doing one of the following:

- Move the analog controller ✱ in the direction that corresponds to the application you want to open. The placement of the icons on the radial menu correspond to the directional controls on the analog controller. After you highlight your selection, release the analog controller to open the application.
- Scroll to an application icon in the All view list (if you already selected the All category). With the analog controller ✱ centered, press it to open the application.



- Press the Function button to move from the radial menu to the list, and then scroll to an application on the list. With the analog controller * centered, press it to open the application.
- Tap an application icon on the screen.

Customizing the Home screen display

There are several ways you can customize the Home screen display. You can rearrange the icons on radial menus, move applications to a different category, create new categories, and set display and button preferences.

Arranging icons on the radial menus

Each radial menu can contain up to eight icons. You can move icons to a different spoke on a radial menu, or move them between a radial menu and the corresponding list.

To arrange the radial menus, do any of the following:

- Drag an icon from the list to a spoke on the radial menu. If that spoke is already occupied, the previous occupant moves to the list.
- Drag an icon from one spoke on the radial menu to another spoke. If the new spoke is already occupied, the icons trade places.
- Drag an icon from the radial menu to the list. The spoke remains empty and the icon appears in alphabetical order on the list.

Organizing applications

Your Zodiac handheld supports up to 15 categories. The category feature enables you to organize your applications into logical groups so that you can easily find and open them. You can move applications between categories and add, rename, and delete categories as needed.

Moving applications between categories

1. Press the Home button .
2. Tap your user name in the title bar to open the menus.
3. From the App menu, select Category.

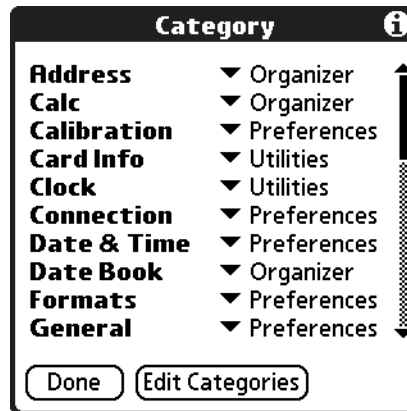

4. From the pick list next to an application, select a different category.
5. Tap Done.

Creating or renaming a category

1. Press the Home button .
2. Tap your user name in the title bar to open the menus.
3. From the App menu, select Category.
4. Tap Edit Categories.



5. Tap New or Rename.
6. Enter the category name, and then tap OK to add or rename the category.
7. Tap OK to close the Edit Categories dialog box.
8. Tap Done.



Deleting a category

1. Press the Home button .
2. Tap your user name in the title bar to open the menus.
3. From the App menu, select Category.
4. Tap Edit Categories.
5. Select a category, and then tap Delete.
6. Tap Yes to confirm deletion.
7. Tap Done.

Setting Home screen preferences

You can use the Home screen Preferences settings to change the background graphic, display all your applications in an alphabetical list, and map applications to the action buttons.

1. Press the Home button .
2. Tap your user name in the title bar to open the menus.
3. From the Options menu, select Preferences.

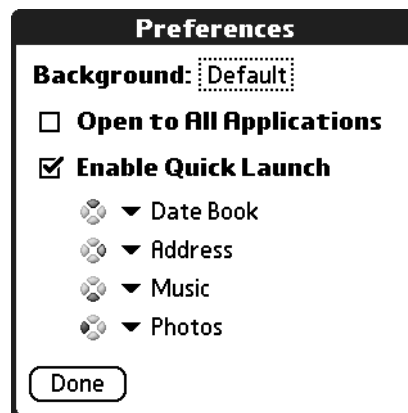

4. Set any of the following options:

- **Background.** Replace the background with any JPEG picture available in the Photos application on your handheld.
- **Open to All Applications.** Display all of your application icons in an alphabetical list (instead of radial menus) whenever you open the Home screen.



- **Enable Quick Launch.** Assign an application to each of the four Action buttons. When you press any of these buttons from the Home screen, the assigned application opens immediately.

5. Tap Done.

Viewing information on an application

You can get information on any application by displaying the Info screen. The Info screen displays the name, version number, size, and number of records associated with each application on your handheld.

1. Press the Home button .
2. Tap your user name in the title bar to open the menus.
3. From the App menu, select Info.

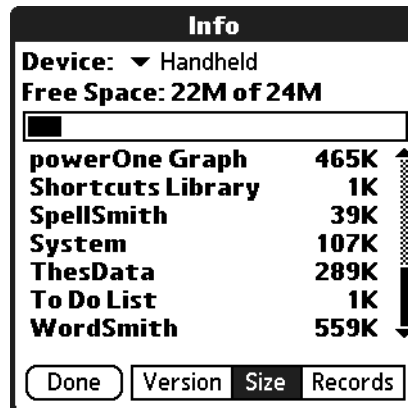

4. From the Device pick list, select Handheld or the name of an expansion card inserted in a slot.
5. Tap Version, Size, Records to view the corresponding information for the selected device.
6. Tap Done.



Installing add-on applications

In addition to the applications that came with your handheld, you can use the Install Tool to install applications (called add-on applications) during a HotSync operation. A variety of third-party games and applications are available for your handheld; for more information visit tapwave.com.

Add-on applications can reside in your handheld's internal memory or on an expansion card. You can remove add-on applications at any time; for more information, see [page 48](#).

There are also several Bonus Software applications included on the CD that came with your handheld. If you did not install these applications when you installed Palm Desktop software, you can install them at any time by choosing the Install Bonus Software option from the CD menu. After you install an application, check the CD for the accompanying documentation.

NOTE: Some add-on applications consist of multiple PRC or PDB files. Check the documentation that came with the application to ensure that you install all required files.

- 1. From your computer, double-click the PRC or PDB file you want to install. The Install Tool window opens and the selected file appears in the list of applications to install.**

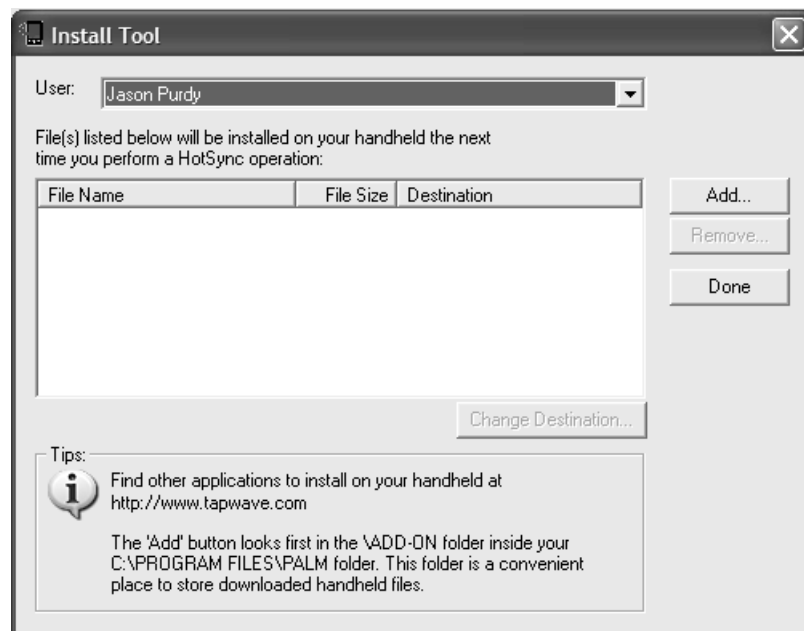



TIP: You can also select the Install Tool dialog box by selecting Install Tool from the Palm Desktop program group, or by clicking the Install icon in Palm Desktop software.

- 2. In the User drop-down list, select the user name that corresponds to your Zodiac handheld.**
- 3. (Optional) Click Change Destination, click the arrows to indicate whether you want to install the application on your handheld or an expansion card, and then click OK.**

TIP: If you decide not to install an application, select it in the list of files in the Palm Install Tool dialog box and click Remove. The application is removed from the dialog box list, but not from your computer.

- 4. Click Done. A message appears to indicate that the application(s) will be installed the next time you perform a HotSync operation.**
- 5. Perform a HotSync operation to install the application(s). For details, see [page 136](#).**

Removing add-on applications

If you run out of memory or no longer need them, you can remove add-on applications, patches, and extensions from your handheld.

You cannot remove the built-in applications that reside in ROM on your handheld.

- 1. Press the Home button .**
- 2. Tap your user name in the title bar to open the menus.**
- 3. From the App menu, select Delete.**

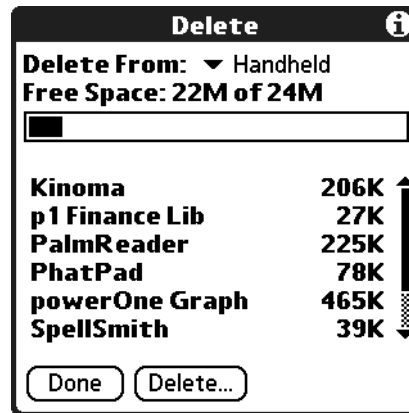

4. From the Delete From pick list, select Handheld.
5. Tap the application you want to remove.
6. Tap Delete.
7. Tap Yes.
8. Tap Done.

The application is deleted. Applications that are loaded in ROM (for example, Memo Pad) cannot be deleted, and are not listed.

Removing Palm Desktop software

If you no longer want to use Palm Desktop software, you can remove it from your computer.

1. From the Windows Start menu, choose Settings > Control Panel.
2. Double-click the Add/Remove Programs icon.
3. On the Install/Uninstall tab, select Palm Desktop software; then click Add/Remove.

NOTE: You must retain the HotSync Manager from the installation CD to synchronize data with another desktop organizer application.





Using Music

Music provides a full-featured mobile MP3 player right on your handheld.

Use Music to:

- Listen to songs and other MP3 files stored on your handheld or an expansion card.
- Upload songs from your computer to your handheld or an expansion card.
- Update a list of songs you created with the Music component in Palm Desktop software.











Opening Music

1. Press the Home button .
2. Select the Media category .
3. Select the Music icon .



- **Previous Track** . Restart the current track, or if the current track has been playing for less than 2 seconds, select the previous track on the song list.



- **Next Track** . Select the next track on the song list.
- **Volume Down** . Lower the speaker or headphone volume level. The volume indicator appears when you tap this button.
- **Volume Up** . Raise the speaker or headphone volume level. The volume indicator appears when you tap this button.
- **Play/Pause** . Start and stop playback of the selected song. When a song is playing, the Pause button appears. When a song is not playing, the Play button appears.
- **Repeat** . Select Repeat replays the entire song list after the last song plays. If Repeat is not selected, your handheld shuts off after the last song.
- **Shuffle** . Select Shuffle to create a randomly ordered song list. Deselect Shuffle to return the songs to their prior order.
- **Handheld** . Select handheld to display songs stored in the internal memory on your handheld. If there are no songs in internal memory, then the button is inactive. You can display songs on your handheld and expansion cards at the same time.
- **Card 1**  or **Card 2** . Select one of the Card buttons to display songs stored on an expansion card that is seated in an expansion slot. If there are no songs on the card seated in the expansion slot, then the button is inactive. You can display songs on your handheld and expansion cards at the same time.
- **Details** . View the following information when available: song title, artist name, album title, progress bar, counter.
- **List** . View the order in which songs will play and the location where the songs are stored. You can drag and drop song titles to arrange them in a particular order, or use the Music application on your computer to create a song list, and then synchronize your handheld with your computer. See the Palm Desktop Online Help for details.

TIP: To scroll through the song list, tap the onscreen scroll arrows or press the blue or green Action buttons. To play a specific song, tap List  and then tap the song title.



Deleting songs

When you delete a song, Music removes the song from your song list and deletes the song file from your handheld or expansion card. If you also have a copy of the song on your computer, it does not delete the copy on your computer.

1. Tap the Menu icon .
2. From the Track menu, select Delete.

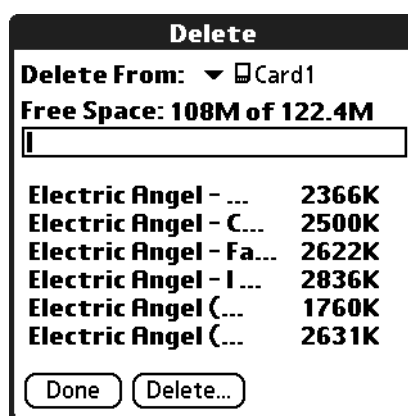

3. From the Delete From pick list, select the location of the song you want to delete.
4. Highlight the song you want to delete, and then tap Delete.
5. Tap Yes to confirm deletion.



Conserving power while playing songs



When your handheld is not plugged into a power outlet, you can put your handheld into a special power-saving *Hold* state to conserve battery power while playing songs. In the Hold state, the screen and backlight turn off while your songs continue to play.

If you forget to put your handheld in the Hold state, it automatically enters this state if the auto-shutoff interval expires while you're listening to a song.

- 1. Tap the Menu icon .**
- 2. From the Options menu, select Hold.**

The LED blinks slowly to indicate that the Hold state is active.

TIP: You can also activate the Hold state by simultaneously pressing the Left and Right Trigger buttons.

- 3. After an hour, an alarm sounds. Tap Yes to keep your handheld in the Hold state. If you do not respond, your handheld shuts off.**
- 4. To return your handheld to the normal operating state, press either the power button  or the Home button .**

TIP: You can also conserve power by listening to music through the headphones or amplified external speakers instead of playing music through the internal speakers.





Using Photos

Photos provides a way to view and manage JPEG pictures files on your handheld.

Use Photos to:











- View individual pictures stored on your handheld or an expansion card.
- View pictures and create slide shows.
- Upload pictures from your computer to your handheld or an expansion card.
- Update a picture list you created with the Photos component in Palm Desktop software.
- Exchange pictures with friends and family. See the section that begins on [page 163](#) for details.

Opening Photos





1. Press the Home button .
2. Select the Media category .
3. Select the Photos icon .





- **Up** . Select the thumbnail above the current picture, or display the previous picture in the sequence.
- **Down** . Select the thumbnail below the current picture, or display the next picture in the sequence.
- **Left** . Select the thumbnail to the left of the current picture, or display the previous picture in the sequence.
- **Right** . Select the thumbnail to the right of the current picture, or display the next picture in the sequence.
- **Full-Screen** . View a full-screen image of the selected picture. To exit Full-Screen mode, tap the screen or press Center.
- **Slide Show** . Begin a slide show. The pictures appear in Full-Screen mode in the same sequence as the picture list. The slide show automatically advances to the next picture after a preset interval.
- **Shuffle** . Select Shuffle to create a randomly ordered picture list and slide show. Deselect Shuffle to return the pictures to their prior order.
- **Handheld** . Select handheld to display pictures stored in the internal memory on your handheld. If there are no pictures in internal memory, then the button is inactive. You can display pictures on your handheld and expansion cards at the same time.
- **Card 1**  or **Card 2** . Select one of the Card buttons to display pictures stored on an expansion card that is seated in an expansion slot. If there are no pictures on the card seated in the expansion slot, then the button is inactive. You can display pictures on your handheld and expansion cards at the same time.
- **Picture List** . Display thumbnail images of all the pictures in the selected locations. View the order in which pictures will appear in a slide show. You can drag and drop pictures to arrange them in a particular order, or use the Photos application on your computer to create a picture list, and then synchronize your handheld with your computer. See the Palm Desktop Online Help for details.



- **Details** . View the selected picture and the following information and controls:
 - **Rotate controls**  . Rotate the picture in 90 degree increments.
 - **Fit controls**  . Choose how the picture fits on the screen.
 - **Title**. View the name of the picture file.
 - **Date/Time**. View the date and time the picture was taken. This may be different from the date associated with the picture file.
 - **Location**. View an icon that indicates where the picture is stored.



Setting the slide show interval

1. From the list or detail view, tap the Menu icon .
2. From the Options menu, select Preferences.

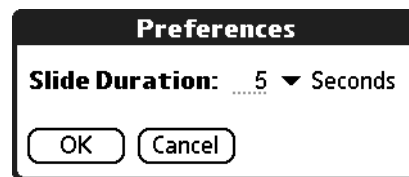

3. From the Slide Duration pick list, select the interval unit: Seconds, Minutes, or Hours.
4. Enter the interval length in the space next to the pick list.
5. Tap OK.



Deleting pictures

When you delete a picture, Photos removes the picture from your picture list and deletes the file from your handheld or expansion card.

IMPORTANT: If you also have a copy of the picture on your computer, deleting the picture from your handheld does NOT delete the copy on your computer.

1. From the list or detail view, tap the Menu icon .
2. From the Image menu, select Delete.



3. Select the picture you want to delete.
4. Tap Delete.
5. Tap Yes to confirm deletion.
6. Repeat steps 3 - 5 to delete other pictures.
7. Tap Done.

Copying pictures

You can copy pictures between your handheld and an expansion card.

1. From the list or detail view, tap the Menu icon .
2. From the Image menu, select Copy.

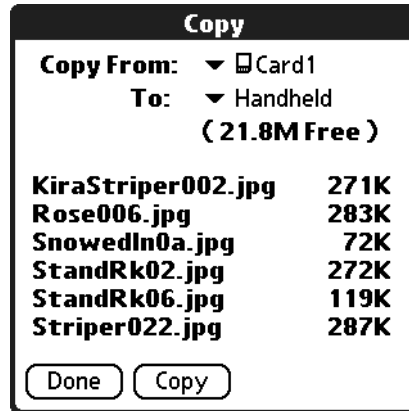

3. From the Copy From pick list, select the location where the picture currently resides.
4. From the Copy To pick list, select the location where you want to place the picture.
5. Select the picture you want to copy.
6. Tap Copy.
7. Repeat steps 3 - 6 to copy other pictures.
8. Tap Done.



Playing Games

Your Zodiac handheld comes with these two great games:

- **Stunt Car Extreme.** Navigate hills, jumps and obstacles in this outrageous 3-D racing game. Select from cockpit or behind the car view, and choose from a quick race or play an entire season in our championship mode. You can even see your stats track by track as you progress in the game.

For complete documentation on this game, look for the .pdf file in the Tapwave Extras\Bonus\Stunt Car Extreme\ folder on the Zodiac CD.

- **Acid Solitaire.** This addictive game offers the best of interactive solitaire for your on-the-go lifestyle. Supporting features such as an easy-to-use drag and drop interface, two play modes, an advanced statistic tracking model that follows eleven different game stats and a sophisticated alert system that notifies you both when you are about to run out of moves and when no moves are remaining. You can even customize your background to have your own unique solitaire experience.

For complete documentation on this game, look for the .pdf file in the Tapwave Extras\Bonus\Acid Solitaire\ folder on the Zodiac CD.



For information about installing additional games, see [page 47](#). To learn about playing games that are stored on expansion cards, see [page 156](#).



Playing multi-player games

The built-in Bluetooth radio provides you with a wireless, multi-player gaming environment. When your handheld is within range of other Zodiac handhelds or other devices enabled with Bluetooth technology that support the game software, you can initiate or join a multi-player game session.

You can initiate a session as follows:

- 1. Launch the game. See [page 41](#) for details.**
- 2. Select multi-player mode as described in the game documentation.**
This should initiate the discovery process on your handheld.
- 3. Instruct all players to press the Bluetooth button  to make their handhelds discoverable.**
When a Zodiac handheld is in this state, the Bluetooth LED flashes.
- 4. When the Discovery Results screen appears, select the players you want to include in the game, and then tap OK.**
This should send an invitation message to the selected players' handhelds.
- 5. Instruct the players to tap Yes to join the game.**
- 6. When the game is over, press and hold the Bluetooth button  to turn off the Bluetooth radio.**

For additional information about using the Bluetooth features of your handheld visit tapwave.com.





Using Clock

Clock provides an easy-to-read time display, an alarm clock, a stopwatch, and a timer.

Use Clock to:

- Set an alarm that is not related to a specific entry on your handheld.
- Determine how long it takes to complete a task or event.
- Receive a notification when the specified time period elapses.

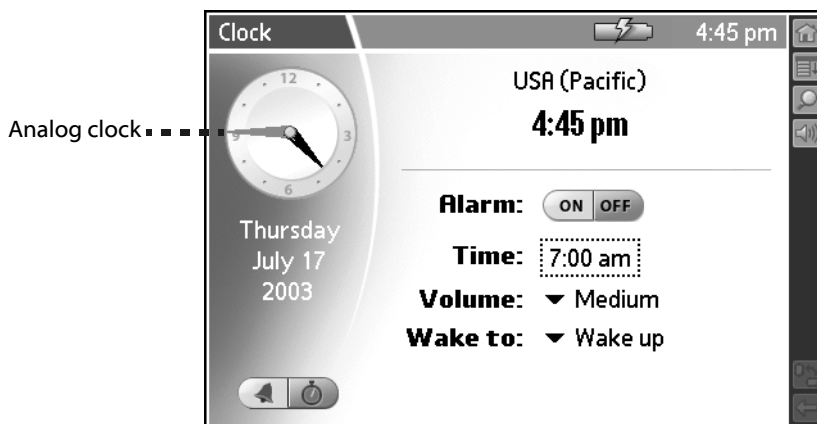

Opening Clock

1. Press the Home button .
2. Select the My Stuff category .
3. Select the Clock icon .



TIP: To set the time and date, select Set Time & Date from the Options menu. To change the time and date format, tap Home , select the Prefs category, and then select Formats.



- **Analog Clock.** View the current time in analog format.
- **Date.** View the current date.
- **Time/Alarm** . View the time in digital format and access the following alarm controls:
 - **Alarm On.** Turn on the alarm and display the alarm controls.
 - **Alarm Off.** Turn off the alarm and hide the alarm controls.
 - **Time.** Set the time when you want the alarm to sound. When you tap this box, a number pad appears. Tap the numbers to select the time you want the alarm to sound, and then tap OK.
 - **Volume.** Select the volume level for the alarm sound. The choices are: Low, Medium, High, and Ascending. The Ascending setting increases from low to high volume over a period of about 20 seconds.
 - **Wake To.** Select the alarm sound. Options include Music, Alarm, Alert, Bird, Concerto, Phone, Sci-fi, and Wake Up. If you select Music, you can select a song from the Music application.
- **Timer/Stopwatch** . Access the following timer and stopwatch controls:



- **Display.** View the time remaining in timer mode, and the elapsed time in stopwatch mode. The time displays in 1/100th of a second increments.
- **Start.** Begin the timer or stopwatch. When you tap this button, it changes to a Stop button.



- **Stop.** Pause the timer or stopwatch. When you tap this button, it changes to a Resume button and a Reset button appears next to the Display. If you are done timing the current task, tap Reset to return the display to all zeros.
- **Resume.** Restart the timer or stopwatch to continue timing a task. When you tap this button it changes to a Stop button.
- **Timer.** Set a timer to notify you know when a particular amount of time has passed. To set the timer, tap the number pad to indicate the time period you want to monitor, such as a 3-minute egg or a half-hour pizza delivery. When the time period elapses, the selected alarm sound plays and a notification screen appears. You can set the timer sound by selecting Preferences from the Options menu.

TIP: You can also stop or resume the timer or stopwatch by pressing the Right Trigger button.



Performing Common Tasks

There are many tasks that are common to the applications found in the Organizer category. These common tasks are described in this section. We use the term *records* as a generic term that refers to an individual item in an application, for example, a single Date Book event, an Address Book entry, a To Do List item, or a Memo Pad memo.

Creating records

You can use the following procedure to create a new record in Date Book, Address Book, To Do List, and Memo Pad.

- 1. Open the application in which you want to create a record.**
- 2. Tap New.**
- 3. (Date Book only) Select start and end times for your appointment and tap OK.**
- 4. Enter text for the record.**

NOTE: The handheld automatically capitalizes the first letter of each field (except numeric and e-mail fields).

- 5. (Optional) Tap Details to select attributes for the record.**
- 6. (Address Book and Memo Pad only) Tap Done.**

Your handheld saves the new record automatically.



Editing records

After you create a record, you can change, delete, or add new information at any time. When the screen is in edit mode, a blinking cursor appears within the information, and the information appears on a dotted line called an edit line. You can then enter text in any of the ways described in the chapter beginning on [page 30](#).

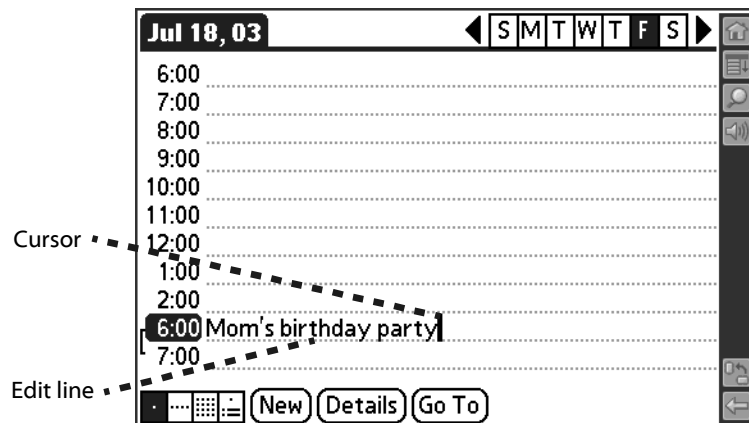

Selecting Text

Select the text you want to edit using one of the following techniques:

- Double-tap a word in a field to select the word.
- Triple-tap any word on a line to select the entire line.
- Drag across a line of text to select some or all of the information, or drag down to select text across multiple lines.

Using the Edit menu

The Edit menu is available from any screen where you enter or edit text. As a general rule, the Edit menu commands affect selected text. Any of the following commands may appear in the Edit menu, depending on the application you're using:

- **Undo.** Reverses the last action taken.
- **Cut.** Removes a selection from its current location to memory. You can then paste the text into another area of the current application or into a different application.



- **Copy.** Copies a selection and moves it to memory. You can paste the selection into another area of the current application or into a different application.
- **Paste.** Inserts a selection from memory into an area you select. Paste produces no result if you have not used the Cut or Copy commands.
- **Select All.** Selects all the text in the current record or screen.
- **Keyboard.** Opens the onscreen keyboard. Tap Done to close the keyboard.
- **Graffiti 2 Help.** Opens the Graffiti 2 character stroke screen.

Deleting records

You can delete records in any of the Organizer applications.

1. Select the record you want to delete.

2. Do one of the following:

- From the Record menu, select Delete. The Delete command differs depending on the application you're using, for example, Delete Event appears in the Record menu in Date Book, and Delete Item appears in To Do List.
- In the Details dialog box of the application, tap Delete, and then tap OK.
- Delete the text of the record.

NOTE: In Date Book, deleting the text of a repeating event deletes all instances of the event.

- In the Input Area, drag a diagonal line from the lower left to upper right to display the Command toolbar; then tap the Delete icon or draw a Graffiti 2 *D* in the text area.



A confirmation dialog box appears.



- 3. To archive a copy of the deleted file on your PC during the next HotSync operation, check the Save Archive box.**
- 4. Tap OK to delete the record.**

Purging records

Over time, as you use Date Book and To Do List, you may accumulate records that are no longer useful. For example, events that occurred months ago remain in Date Book, and completed To Do List items remain in the list.

Outdated records take up memory on your handheld, so it's a good idea to remove them by using Purge. If you think Date Book or To Do List records might prove useful later, you can purge them from your handheld and save them in an archive file.

Purging is not available in Address Book or Memo Pad; delete records from these applications manually.

- 1. Open the application from which you want to purge records.**
- 2. Tap the Menu icon .**
- 3. From the Record menu, select Purge.**
- 4. From the confirmation dialog box, do the following:**
 - **Date Book.** Select an option from the Delete Events Older Than pick list —1 week, 2 weeks, 3 weeks or 1 month.
 - **Date Book and To Do list.** Check the Save Archive Copy on PC box to save a copy of purged records in an archive file on your desktop. The records are transferred the next time you perform a HotSync operation.
- 5. Tap OK.**

Categorizing records

You can categorize records in Address Book, To Do List, and Memo Pad for easy retrieval (Date Book does not have categories). When you create a record, it is automatically assigned to the current category. For example, if you are in the All category, the record goes in the Unfiled category. A record can remain unfiled or it can be assigned to a category at any time.



Each application has a default set of categories:

- Address Book includes a Business, Personal, and QuickList category.
- To Do List includes a Business, Personal, and All category.
- Memo Pad includes a Business, Personal, and All category.

You can rename or delete the default categories, and you can create new categories. Each application can have up to 15 categories.

Moving a record into a category

1. **Select the record you want to categorize.**
2. **Tap Details (from the Address View screen, tap Edit first).**
3. **From the Category pick list, select the desired category.**
4. **Tap OK.**

Displaying a category of records

1. **Open one of the following applications: Address Book, To Do List, or Memo Pad application.**
2. **From the pick list in the upper-right corner, select the category you want to display.**

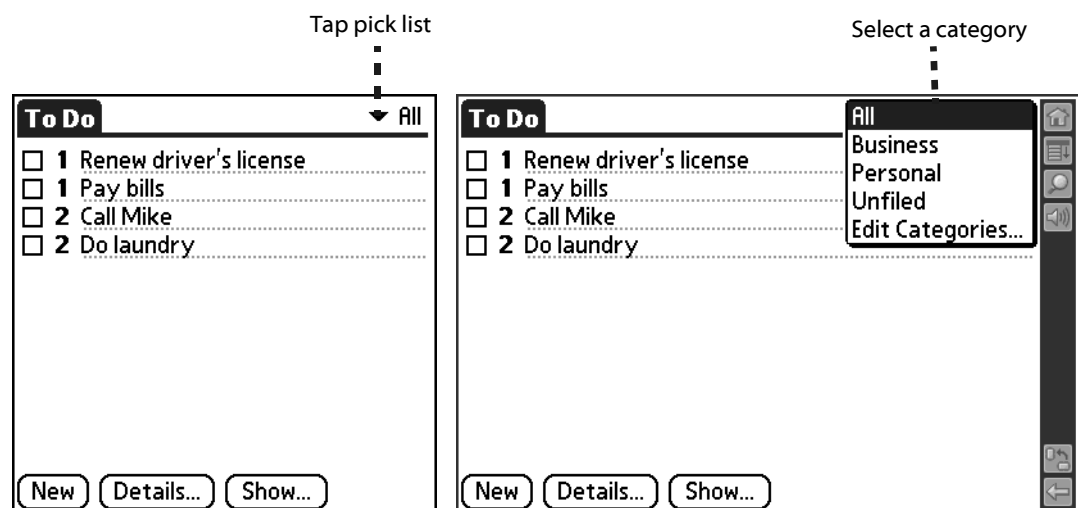



Adding or editing categories

1. In Address Book, To Do List, or Memo Pad application, choose from the following options:

- From the pick list in the upper-right corner, select Edit Categories.

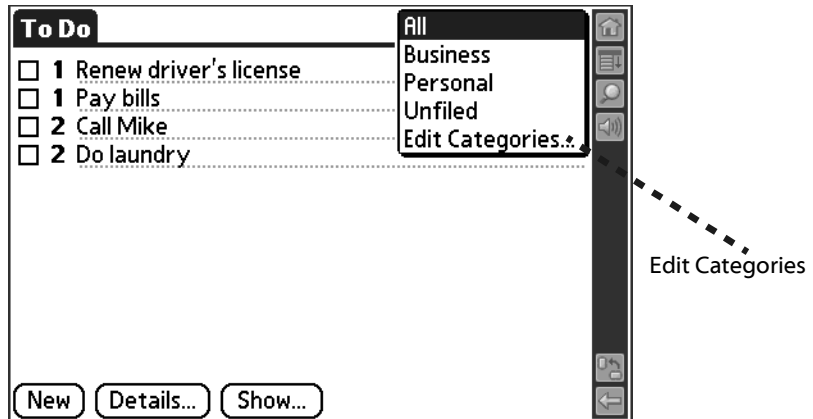

- In Address Book, select a record, tap Edit, and then tap Details. From the Category pick list, select Edit Categories.
- In Memo Pad and To Do List, select a record from the list, and tap Details. From the Category pick list, select Edit Categories.

2. Select any of the following options:



- To create a new category, tap New, and enter a new name in the Input Area. Tap OK.
- To rename a category, tap it in the list to select it. Tap Rename, enter a new name in the Input Area, and tap OK.



TIP: You can move records from multiple categories into a single category by renaming all discrete categories with a single category name.

- To delete a category, tap it in the list to select it. Tap Delete.

3. Tap OK.

Finding records

Your handheld provides several ways to find information:

- In all applications, starting with the current application, you can use the Find dialog box to locate the selected text.
- In Date Book, To Do List, and Memo Pad, you can use Phone Lookup to display the Address List screen and add the information from this list to a record.
- In Address Book, you can use the Look Up option to enter the first few letters of a name to scroll immediately to that name.

Finding Address Book records

1. Do one of the following:

- From the Address screen, enter the first few letters of the name you want to locate.

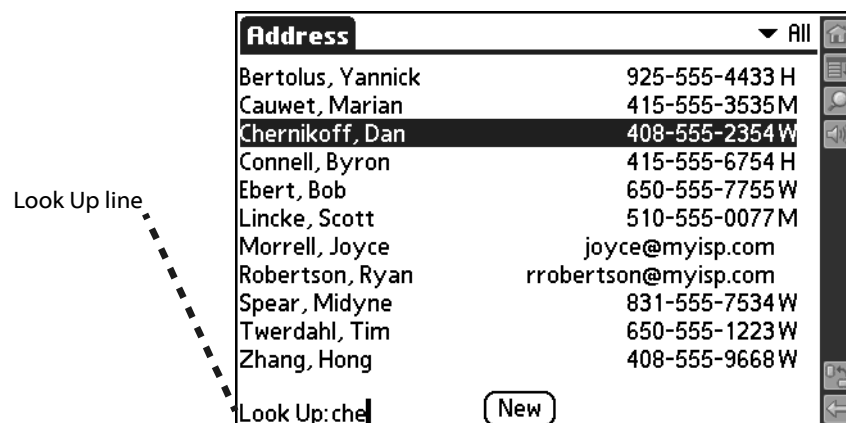

- Move the analog controller * to scroll to a name. Holding down the analog controller accelerates scrolling.



Using the Find dialog box

The Find dialog box helps you locate text in any or all applications. For example, if the text "dog" appears in Address Book and Date Book, the Find dialog box displays both occurrences.

1. Tap the Find icon.
2. Enter the text you want to find; then tap OK.

Note that the Find option is not case sensitive; searching for "davidson" also finds "Davidson."

TIP: Select text in an application before tapping Find to automatically place the text in the Find dialog box.

Find searches for the text in all records and all notes within all applications.

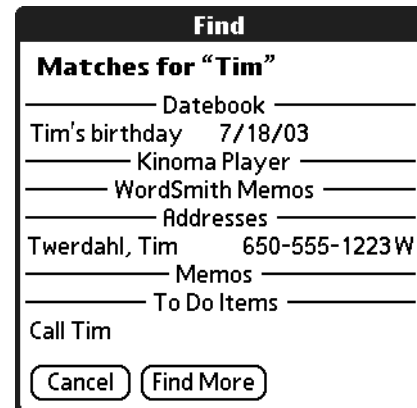
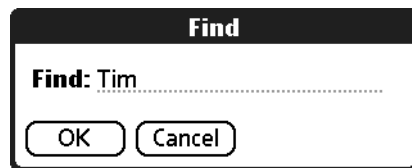

As your handheld searches for the text, you can tap Stop to stop the search at any time. To continue the search after tapping Stop, tap Find More.

NOTE: Find locates all matches that begin with the supplied text. It does not find words where the supplied text appears in the middle or at the end of a word.

Using Phone Lookup

The Phone Lookup option lets you add a telephone number from the Address list to an entry in another application. For example, you can add your dentist's telephone number to your dental appointment date in Date Book.



1. In **Date Book, To Do List, or Memo Pad**, display the record in which you want to insert a phone number.
2. Tap the **Menu icon** .
3. From the **Options menu**, select **Phone Lookup**.

Lookup	
Bertolus, Yannick	925-555-4433 H
Cauwet, Marian	415-555-3535 M
Chernikoff, Dan	408-555-2354 W
Connell, Byron	415-555-6754 H
Ebert, Bob	650-555-7755 W
Lincke, Scott	510-555-0077 M
Morrell, Joyce	joyce@myisp.com E
Robertson, Ryan	rroberts@myisp.... E
Spear, Midyne	831-555-7534 H
Twerdahl, Tim	650-555-1223 W
Zhang, Hong	408-555-9668 W

Look Up: |

4. Select a record or write the first few letters of the name you want to add. Tap **Add** to add the information to the record.

NOTE: You can also search based on selected text. Drag to highlight the text, then follow step 3 above. When the search is complete, the name and phone number of the candidate replaces the selected text.

Sorting records

You can sort lists of records in various ways, depending on the application. Sorting is available in applications that display lists—in Address Book, To Do List, and Memo Pad.

Sorting To Do List records

1. Open the application to display the list screen.
2. Tap **Show**.

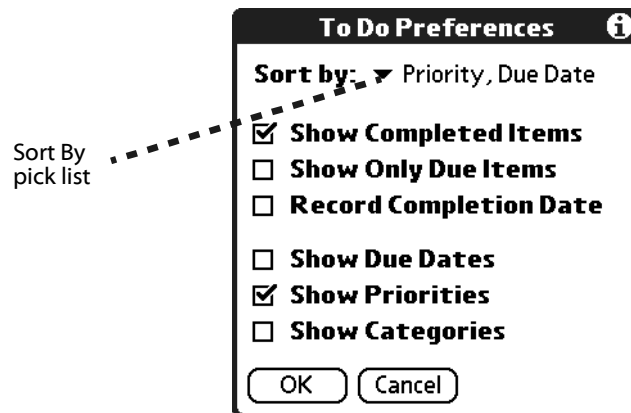

3. From the Sort By pick list, select an option.
4. Tap OK.

Sorting Address Book and Memo Pad records

1. Open the application to display the list screen.
2. Tap the Menu icon .
3. From the Options menu, select Preferences.

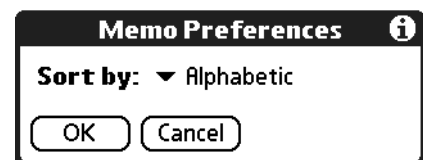
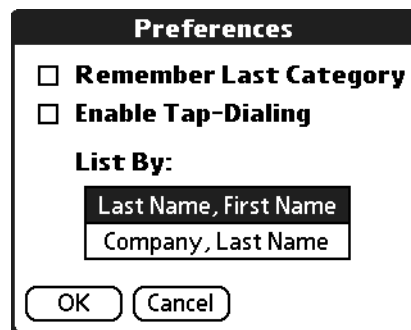

4. In the Preferences dialog box, tap the option you want, and then tap OK to sort the list.

TIP: You can also manually arrange the Memo list by tapping and dragging a memo to a new location in the list. To display the list of your memos on your computer as you arranged them manually on your handheld, open Memo Pad in Palm Desktop software click List By, and select Order on Handheld.



Making records private

In most applications (except Mail), you can make individual records private. Private records can be either masked or hidden. Private records remain visible and accessible until you select a security setting to Hide records. Private record names are covered with a gray bar when the security setting is set to Mask records.

If you assigned a password to your handheld, you must enter it before private records are displayed. For more information, see [page 148](#).

1. In your application, do one of the following:

- Create a new record and tap Edit, and then tap Details.
- Select an existing record, and tap Details.

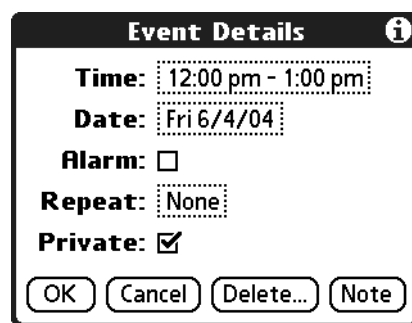

2. Check the Private box. Tap OK.



3. At the alert in the Private Records dialog box, tap OK.

Hiding private records

1. Do one of the following:

- Press the Home button , select the Utilities category, and then select Security.
- From within an application, tap the Menu icon , and from the Options menu, select Security.
- From within any application, draw the Menu command stroke to bring up the Command Bar and tap the padlock icon.



2. From the Current Privacy pick list in the Change Security dialog box, select Hide Records.



3. Tap OK.

Displaying private records

1. Do one of the following:

- Press the Home button , select the Utilities category, and then select Security.
- From within an application, tap the Menu icon , and from the Options menu, select Security.
- From within any application, draw the Menu command stroke to bring up the Command Bar and tap the padlock icon.

2. From the Current Privacy pick list, select Show Records.



3. If you assigned a password, enter it.

4. Tap OK.

Attaching notes

You can attach notes to records in all the Organizer applications except Memo Pad. A note can be up to several thousand characters long.

1. Display the entry to which you want to add a note.
2. (Address Book only) Tap Edit.
3. Tap Details.



Performing Common Tasks

Attaching notes

4. Tap Note.
5. Enter the desired note.
6. Tap Done.

A note icon appears to the right of any item containing a note. To review or edit a note, tap the note icon.

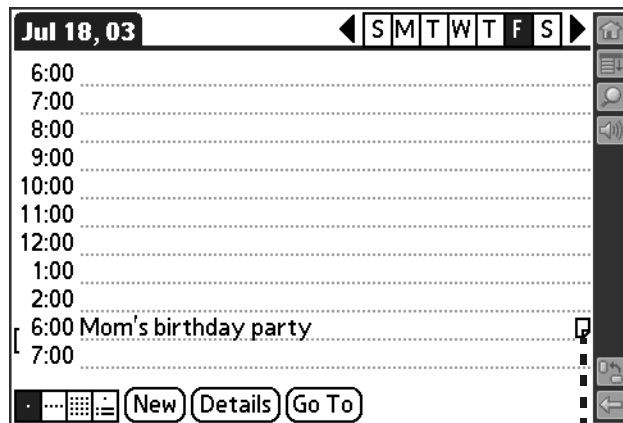

Note icon

Deleting a note

1. Tap the note icon.
2. Tap Delete.
3. Tap Yes.



Choosing fonts

You can change the font style in all the Organizer applications. You can also choose a different font style for each application.

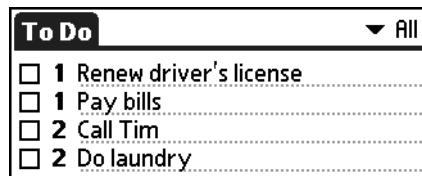

Small font

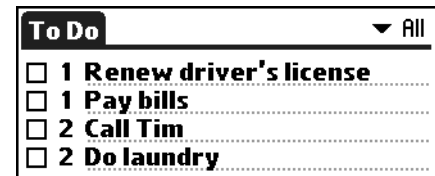

Small bold font

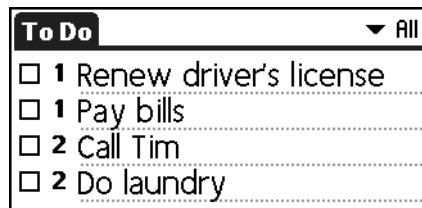

Large font

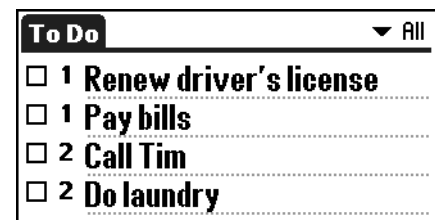

Large bold font

1. Open an application.
2. Tap the Menu icon .
3. From the Options menu, select Font.

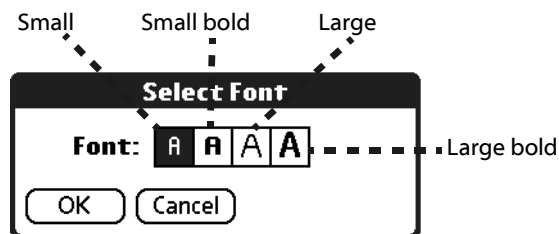

4. Tap the font style you want.
5. Tap OK.





Using Address Book

Address Book lets you keep names, addresses, telephone numbers, and other information about your personal or business contacts.

Use Address Book to:

- Quickly enter, look up, or duplicate names, addresses, phone numbers, and other information.
- Enter up to five phone numbers (home, work, fax, mobile, and so on) or e-mail addresses for each name.
- Define which phone number appears in the Address List for each Address Book entry.
- Attach a note to each Address Book entry, in which you can enter additional information about the entry.
- Assign Address Book entries to categories so that you can organize and view them in logical groups.

Opening Address Book

1. Press the Home button .
2. Select the Organizer category .
3. Select the Address icon .

Address Book opens to display the list of all your records.

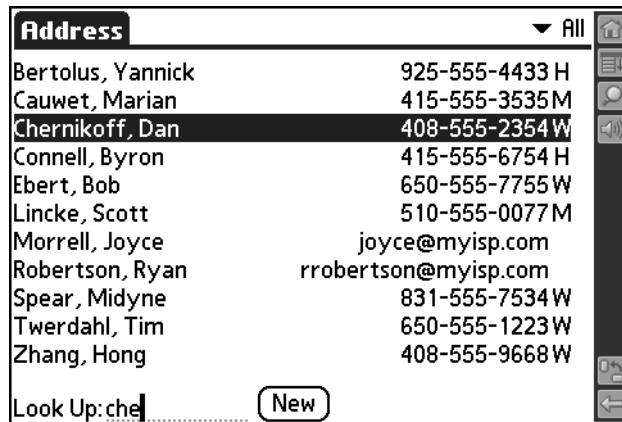

Adding and using Address Book entries

Address Book stores name and address information about people or businesses.

Creating an Address Book entry

A record in Address Book is called an entry. You can create entries on your handheld, or you can use Palm Desktop software to create entries on your computer and then download them to your handheld with your next HotSync operation.

Palm Desktop software also has data import capabilities that let you load database files into Address Book on your handheld. See [page 39](#) and Palm Desktop online Help for more information.

- 1. Open Address Book.**
- 2. Tap New.**



Using Address Book

Adding and using Address Book entries

Cursor at Last name

Address Edit Unfiled

Last name: _____

First name: _____

Title: _____

Company: _____

▼ Work: _____

▼ Home: _____

▼ Fax: _____

▼ Other: _____

▼ E-mail: _____

Address: _____

Done Details... Note

3. Enter the last name of the person you want to add to your Address Book.
4. Tap the First Name field and enter the person's first name.
5. Tap any field and enter any other information that you want to include in the entry.

NOTE: If you plan to sort entries by company name, be sure to enter a company name.

6. Tap the scroll arrows to move to the next page of information.
7. To attach a note to an entry, tap Note. Enter the note, and then tap Done.
8. After you finish entering information, tap Done.

Address Edit Business

Last name: **McGilvray**

First name: **Mitzi**

Title: _____

Company: **Tapwave**

▼ Work: **650-555-2692**

▼ Home: _____

▼ Fax: _____

▼ Other: _____

▼ E-mail: **mcgil@tapwave.com**

Done Details... Note

Tap here to assign entry to a category

TIP: To create an entry that always appears at the top of the Address List, begin the Last name or Company field with a symbol, as in *If Found Call.* This entry can contain contact information in case you lose your handheld.



Viewing an address entry

1. Tap the address entry in Address List view.

The entry appears in Address view.



2. Tap Done after you finish viewing the entry.

Duplicating an entry

You can duplicate existing entries, which can be helpful when you want to enter multiple people from a single organization. When you duplicate an entry, the word *Copy* appears next to the name in the First Name field.

1. In Address Book, tap a name you want to duplicate.
2. Tap the Menu icon
3. From the Record menu, select Duplicate Record.
4. Edit the record as necessary.

Selecting different types of phone numbers and addresses

You can select the types of phone numbers or e-mail addresses that an Address Book entry displays. Any changes you make apply only to the current entry.

1. In the Address list, tap the entry you want to change.
2. Tap Edit.
3. From the pick list next to any label you want to change, select a new label.



Address Edit Business

Last name: **McGilvray**

First name: **Mitzi**

Title:

Company: **Tapwave**

Work <: **650-555-2692**

Home >:

Fax <:

Other <:

E-mail >:

Main >: **mcgil@tapwave.com**

Pager

Mobile

Details... Note

Editing Address Book entries

You can change the type of information that appears in the Address List screen, categorize an entry, and hide an entry for security reasons. You can also delete entries.

1. Tap the entry that you want to change in the Address list.
2. Tap Edit.
3. Tap Details.

Address Entry Details i

Show in List: ▼ Work

Category: ▼ Business

Private:

OK Cancel Delete... Note

4. In the Address Entry Details dialog box, set any of the following:
 - **Show in List.** Select which information you want to appear in the Address List screen. Options are Work, Home, Fax, Other, and E-mail.
 - **Category.** Select the category you want to assign to the entry.
 - **Private.** Hide the entry when Security is turned on.
 - **Note.** Attach a note, such as driving directions, to the entry.
5. Tap OK.



Changing Address Book display

You can change how Address Book lists are sorted and you can add custom fields for entering additional information, using preferences. You can also have Address Book display the last category you selected each time you return to the application.

1. In the Address list or in Address view, tap the Menu icon .
2. From the Options menu, select Preferences.

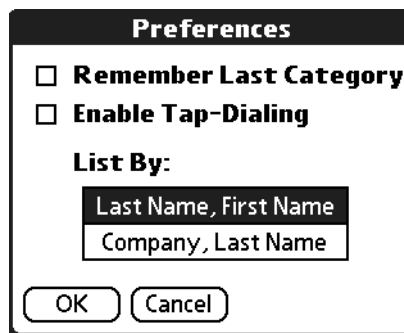

3. From the Address Book Preferences dialog box, select from the following options:
 - **Remember last category.** Display the most recently viewed category the next time you open Address Book.
 - **Last Name, First Name.** Sort the Address list alphabetically by an individual's last name and then first name.
 - **Company, Last Name.** Sort the Address list alphabetically by the company name, and then an individual's last name.
4. Tap OK.

Adding custom fields at the end of Address Edit screens

1. In the Address list or in Address view, tap the Menu icon .
2. From the Options menu, select Rename Custom Fields.



Using Address Book

Adding custom fields at the end of Address Edit screens

Rename Custom Fields

**Create your own field names
by editing the text on the
lines below:**

Custom 1

Custom 2

Custom 3

Custom 4

- 3. In the Input Area, rename the fields to identify the information you'll enter in them. The names you give the custom fields appear in all entries, at the end of the Address Edit screen.**
- 4. Tap OK in the Rename Custom Fields dialog box.**
- 5. Tap Done.**





Using Date Book

Date Book lets you quickly and easily schedule appointments or any activity associated with a date or date and time. When you open Date Book, the current date and a list of times for a standard business day are displayed.

Use Date Book to:

- Schedule events: timed events, which have both times and dates; untimed events, for example, birthdays or anniversaries; repeating events, such as a weekly meeting held on the same day at the same time; continuous events, such as a vacation or three-day conference; and all day events, which reflect the default hours of a day as set by the user.
- Display your schedule in different ways: by Day, Week, Month, or Agenda view.
- Set an alarm to sound minutes, hours, or days before a scheduled appointment.
- Attach notes to events to describe or clarify Date Book entries.
- Rearrange or delete events from your schedule.

Opening Date Book

1. Press the Home button .
2. Select the Organizer category .
3. Select the Date Book icon .

Date Book opens to today's schedule. The date appears in the top left corner of the screen.

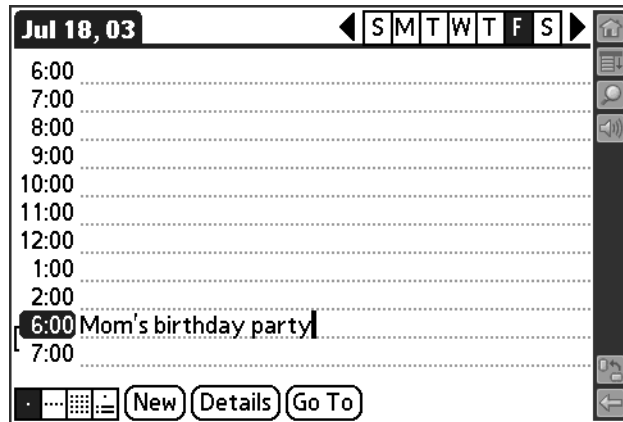

Scheduling events

An entry in Date Book is called an event. When you schedule an event, its description appears on the time line, and its duration is set to 1 hour by default. You can easily change the start time and duration for any event. You can schedule the following types of events in Date Book:

- *Timed* events, such as meetings, that have a specific date and a specific start and end time.
- *Untimed* events, such as birthdays, holidays, and anniversaries. These events occur on a particular date but have no specific start or end times; they appear at the top of the list of times marked with a diamond. You can schedule more than one untimed event on the same date.
- *Repeating* events, such as a weekly meeting that is held on the same day at the same time each week.
- *Continuous* events, such as a vacation or three-day conference.
- *All day* events, which reflect the default length of the day.



Scheduling timed events for the current date

1. Open Date Book to today's schedule. The Day view displays the current date and a list of times for a normal day.
2. With the current day selected, tap the line next to the time that corresponds to the start of the event.

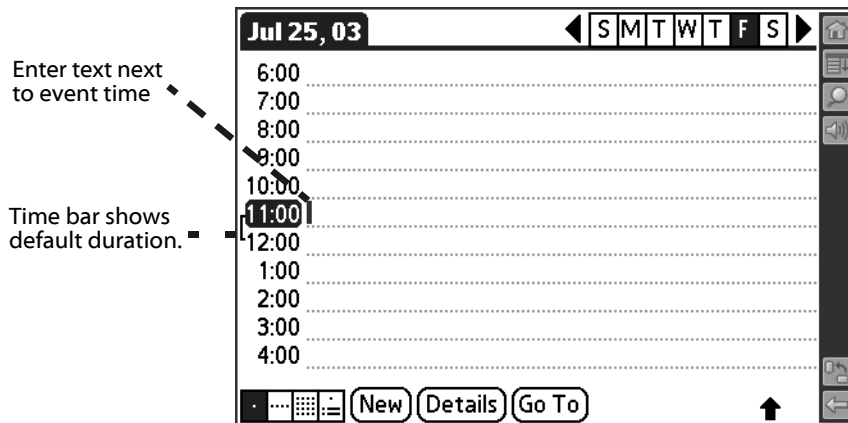

3. Enter a description of the event, up to 255 characters in length.
4. Set the event's duration:

- If the event is 1-hour long, skip to the end of this procedure.
- If the event is longer or shorter than an hour, tap directly on the time to open the Set Time dialog box.

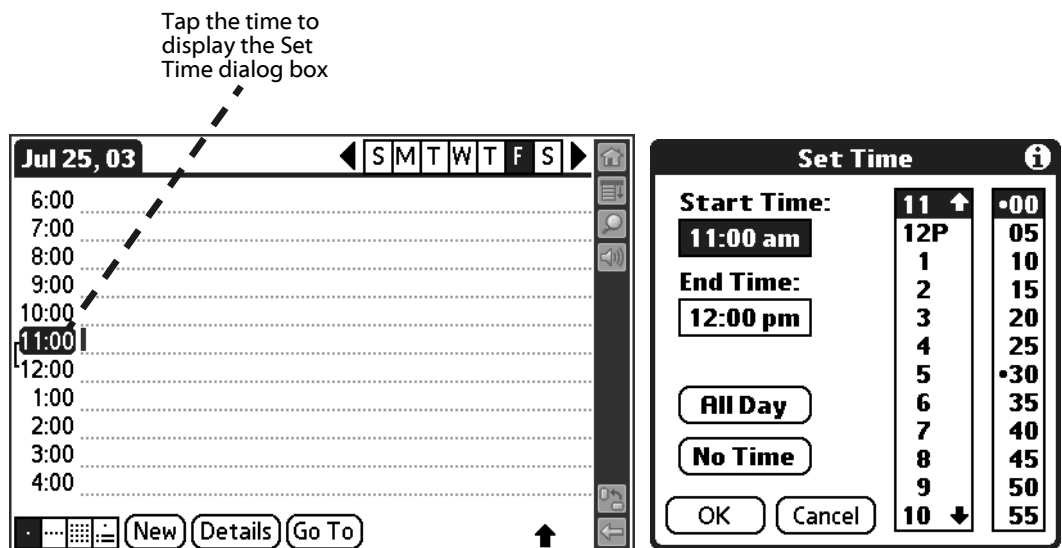



TIP: You can open the Set Time dialog box (to select a start time) by making sure no event is selected, and then writing a number in the number portion of the Input Area.

5. Set the duration of the event in either of the following ways:

- Tap the time columns in the Set Time dialog box to set the Start Time; Tap End Time; then tap the time columns to set the End Time.
- Tap All Day if the event lasts all day. The default hours of a standard business day are set by the user, and may be changed using Date Book Preferences. For details, see [page 101](#).

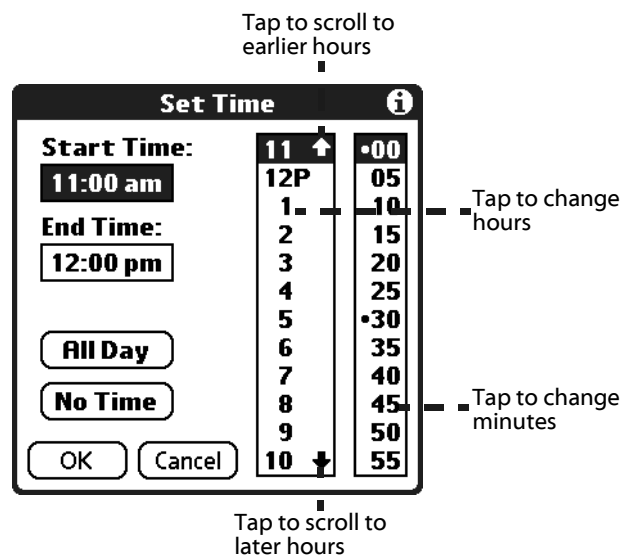

6. Tap OK.



Scheduling a timed event for another date

1. Select the date you want in one of the following ways:

- Tap the desired day of the week in the date bar at the top of the screen. If necessary, tap the scroll arrows in the upper-right corner to move to the next or previous week.
- Move the analog controller * to scroll between days. Move Left to display the previous day and Right to display the next day.
- Tap Go To at the bottom of the screen to open the Go to Date dialog box. Select a date by tapping a year, month, and day in the calendar.

2. After locating the desired date, follow the steps for scheduling an event for the current day.

Scheduling untimed events

You can schedule untimed events for any date. Untimed events appear at the top of the list of times marked with a diamond.

1. Select the event date you want (see [page 86](#)).
2. Tap New.
3. In the Set Time dialog box, tap No Time.

NOTE: You can tap OK instead but make sure nothing is entered for start or end time.

The 'Set Time' dialog box features a central list of times from 6:00 to 5:55. The list is flanked by up and down arrows. To the left of the list are two input fields labeled 'Start Time:' and 'End Time:'. Below these fields are three buttons: 'All Day', 'No Time', and 'OK'. At the bottom right is a 'Cancel' button. An information icon (i) is located in the top right corner of the dialog box.



TIP: You can create a new untimed event by making sure no event is selected and then writing letters in the Input Area. When you start writing, the untimed event appears at the top of the screen

4. Enter a description of the event.

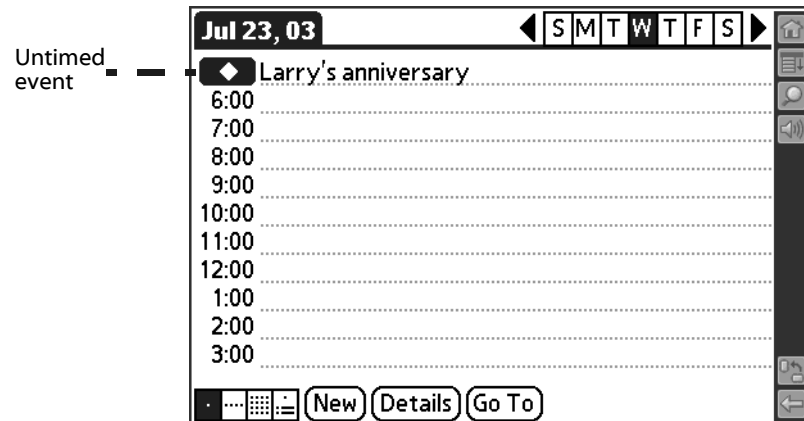

5. Tap a blank area on the screen to deselect the untimed event.

NOTE: If you create a timed event and later want to make it an untimed event, tap directly on the event time in Date Book, tap No Time, and then tap OK.

Adding Address Book information to an event

You can add a name, address, and telephone number to an event using the Phone Lookup option. For instructions, see [page 71](#).

Rescheduling events

You reschedule events using the Details option in Date Book. You can also use the Details option to convert untimed events into timed events.

1. Tap the event you want to reschedule.
2. Tap Details.
3. To change the time, tap the Time box, select a new time, and then tap OK.
4. To change the date, tap the Date box, select a new date, and then tap OK.



Scheduling repeating or continuous events

The Repeat function lets you schedule events that recur at regular intervals or extend over a period of consecutive days. Repeating events include a birthday and a weekly guitar lesson that falls on the same day of the week and the same time of day. Continuous events might include a business trip or a vacation.

1. Tap the event (be sure to tap the event and not the time next to the event). Typically, a continuous event is an untimed event.
2. Tap Details.
3. Tap the Repeat box to open the Change Repeat dialog box.

The 'Event Details' dialog box shows fields for Time (12:00 pm - 1:00 pm), Date (Fri 6/4/04), Alarm (checkbox), Repeat (None), and Private (checkbox). It has buttons for OK, Cancel, Delete..., and Note.

Tap the Repeat box.

The 'Change Repeat' dialog box has tabs for None, Day, Week, Month, and Year. It shows 'Every: 1 Week(s)', 'End on: No End Date', and 'Repeat on: S M T W T F S'. A summary box says 'Every week on Wednesday'. It has buttons for OK and Cancel.

4. Tap Day, Week, Month, or Year to set how often the event repeats. For a continuous event, tap Day.
5. Enter a number that corresponds to how often you want the event to repeat on the Every line.
6. For example, if you select Month and enter the number 2, the event repeats every other month.
7. To set an end date for the repeating or continuous event, select Choose Date from the End On pick list. Use the date picker to select an end date.
8. Tap OK. An icon that represents a repeating event appears to the far right on the event line.

Changing repeating or continuous events

When changes are made to a repeating or continuous event you have the option of applying the change to just the current event, the current event and



all future occurrences of this event, or all occurrences of this event - past, present, and future.

1. **Select the event you want to change and tap Details.**
2. **Change the event and tap OK. The Repeating Event screen opens.**

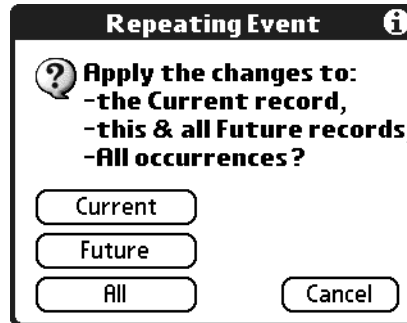

3. **Select one of the following options:**

- **Current.** Edit a single occurrence of this event.
- **Future.** Edit the current event and all future occurrences of this event.
- **All.** Edit all past, current, and future occurrences of this event.

The event is changed and you are returned to the day view where you started. These steps apply to all changes and deletions you make to repeating or continuous events.

Tips for scheduling repeating or continuous events

Keep the following in mind when scheduling repeating or continuous events:

- If you change the start date of a repeating event, your handheld calculates the number of days you moved the event. Your handheld then automatically changes the end date to maintain the duration of the repeating event.
- If you change the repeat interval (e.g., daily to weekly) of a repeating event, past occurrences (prior to the day on which you change the setting) are not changed, and your handheld creates a new repeating event.
- If you change the date of an occurrence of a repeating event (e.g., from January 14 to January 15) and apply the change to all occurrences, the new date becomes the start date of the repeating event. Your handheld adjusts the end date to maintain the duration of the event.



- If you change other repeat settings (for example, time, alarm, private) of a repeating event and apply the change to all occurrences, your handheld creates a new event. The start date of this new event is the day on which the setting is changed. Past occurrences (prior to the day of the change) are not changed.
- If you apply a change to a single occurrence of a repeating event (e.g., time), that occurrence no longer shows the Repeat icon.

Setting the alarm

The Alarm setting lets you set an audible alarm for events in your Date Book, and display a reminder message on-screen. For untimed events, only the reminder message appears.

Setting an alarm for an event

You can set an alarm for minutes, hours, or days before an event. When you set an alarm, an Alarm icon appears to the far right of the event with the alarm.

You can also set a silent alarm for untimed events that displays a reminder message on-screen before the day of the event. The alarm triggers at the specified period of minutes, hours, or days before midnight of the day on which the untimed event begins.

For example, you set a 5-minute alarm for an untimed event that occurs on February 4. The reminder message appears at 11:55 p.m. on the night of February 3. The reminder remains onscreen until you turn on your handheld and tap OK to turn off the reminder.

- 1. Tap the event to which you want to assign an alarm.**
- 2. Tap Details.**
- 3. Check the Alarm box.**

The default setting, 5 Minutes, appears.

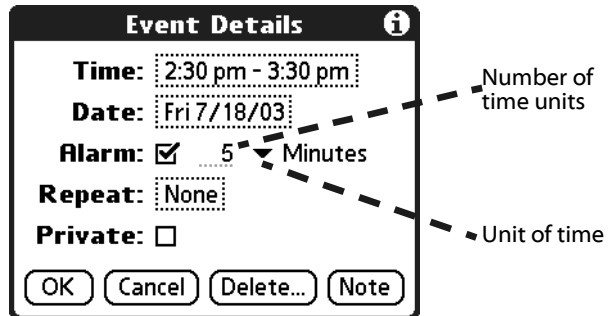

4. Set the alarm time:

- Enter any number from 0 to 99 (inclusive) as the number of time units.
- From the pick list, select the time unit --Minutes, Hours, or Days.

5. Tap OK.

Once an alarm goes off, you can tap the Snooze option to dismiss the alarm for a 5-minute period.

Snoozing the alarm

When the alarm dialog box appears, tap Snooze to delay the alarm for a preset five-minute period.

Each time you tap Snooze, the alarm dismisses for an additional 5-minute period.

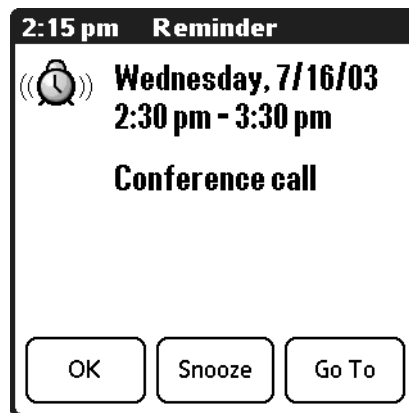



Setting alarm options

You can set the alarm to go off automatically for each new event using preferences. You can also set a tone for the alarm and the number of times the alarm sounds.

1. In Date Book, tap the Menu icon .
2. From the Options menu, select Preferences.

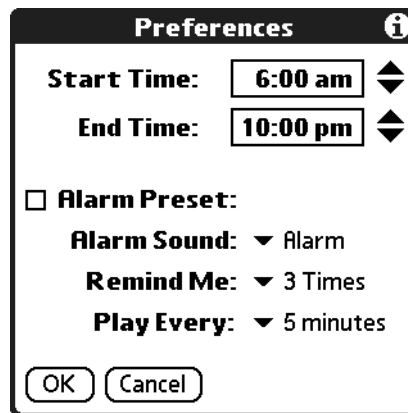

3. Select from the following options:

- **Alarm Preset.** Set an alarm for each new event automatically. The silent alarm for untimed events is defined by minutes, days, or hours before midnight of the date of the event.
- **Alarm Sound.** Select the tone of the alarm. Options include Alarm, Alert, Bird, Concerto, Phone, Sci-fi, and Wake Up.
- **Remind Me.** Define how many times the alarm sounds—once, twice, three, five, or ten times.
- **Play Every.** Set how often the alarm sounds—every 1, 5, 10, or 30 minutes.

4. Tap OK.



Changing the Date Book view

Date Book includes four views for displaying your appointments: day view, week view, month view, and agenda view.

- Tap a view icon in the lower-left corner of the Date Book screen.

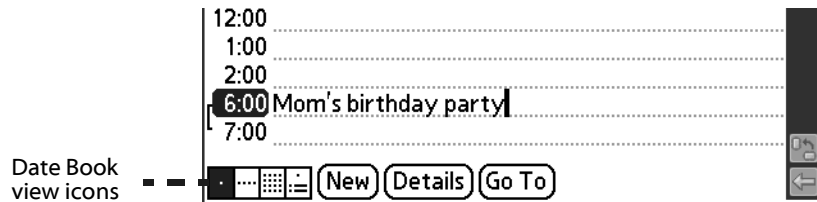

- Press the Function button to scroll between views.
- Tap and hold down the stylus on the date in the date bar to display the time (when you release the stylus, the menu bar appears).

Working in Week view

Week view displays a calendar of your events for an entire week. This view lets you quickly review your appointments and available time slots. In addition, the graphical display helps you spot overlaps and conflicts in your schedule.

Displaying the Week view

- Tap the Week view icon .

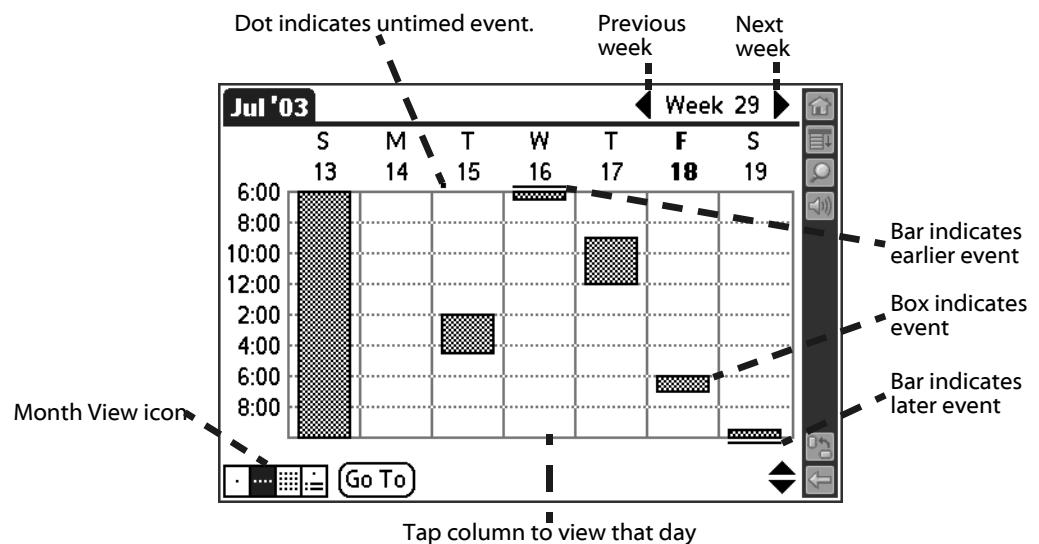

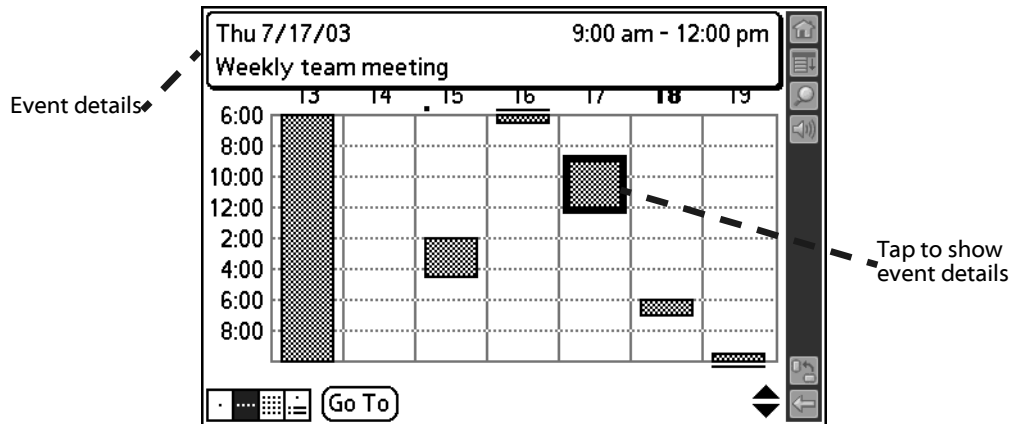

Tips for using Week view

Keep the following points in mind when using Week view:

- Tap a specific day to display that day in Day view.
- Tap an event to display a description of the event at the top of the screen.
- Tap the scroll arrows in the upper-right corner or move the analog controller \ast Right or Left to scroll forward or backward a week at a time.
- To reschedule an event while in Week view, tap and drag the event to a different time or day.
- Tap a blank time on any day to move to that day and have the time selected for a new event.
- Tap any day or date that appears at the top of the Week view to move directly to that day without selecting an event.
- The Week view displays the time span defined by the Start Time and End Time in Date Book Preferences. If you have an event before or after this time span, a bar appears at the top or bottom of that day's column. Use the onscreen scroll arrows to scroll to the event.



Working in Month view

The Month view screen shows which days have events scheduled. Dots and lines in the Month view indicate events, repeating events, and untimed events.

Displaying the Month view

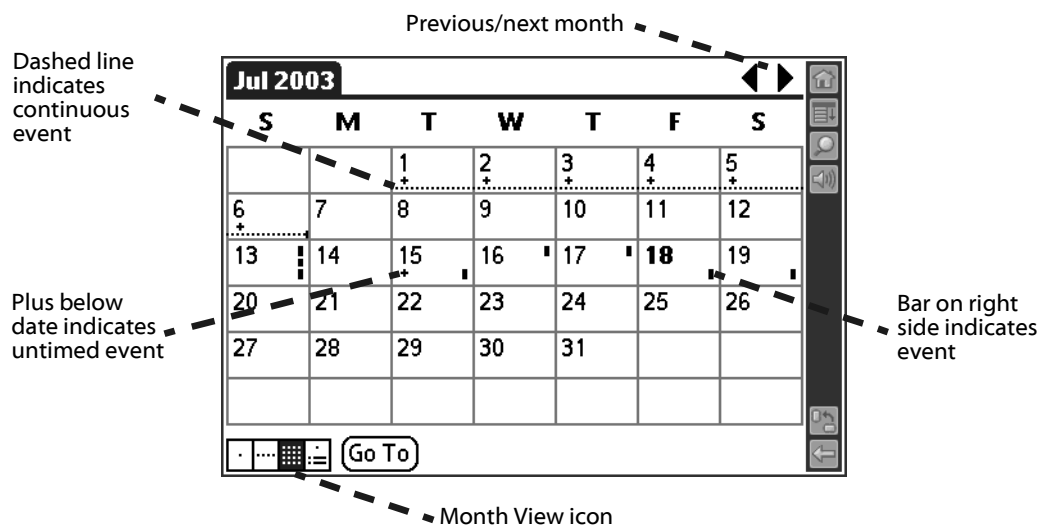

- Tap the Month view icon .



You can control the dots and lines that appear in the Month View. See [page 100](#) for more information.

Tips for using Month view

Keep the following points in mind when using the Month view:

- Tap a day in the Month view to display that day in the Day view.
- Tap the scroll arrows in the upper-right corner to move forward or backward a month, or when no date is selected, move the analog controller  Left to display the previous month and Right to display the next month.
- Move the analog controller  to scroll between days and months. When a date is selected, move Left to display the previous day and Right to display the next day.
- Tap Go To to open the date selector and select a different month.



Working in Agenda view

The Agenda view lets you view appointments, untimed events, and To Do List items in a single screen. Although it is primarily a viewing option, you can also use the Agenda view to check off completed To Do List items. To go to a Day View of any event on the Agenda view screen, simply tap the desired event.

Displaying the Agenda View

- Tap the Agenda view icon .

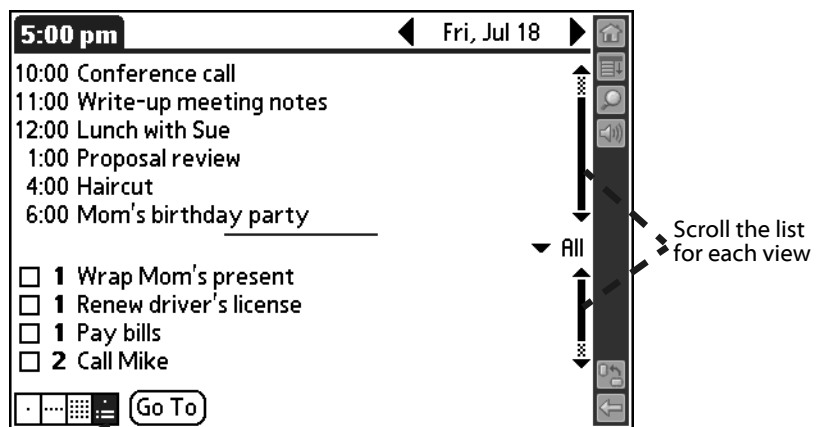

Agenda view icon

Tips for using Agenda view

- Tap the scroll arrows in the upper-right corner or move the analog controller  Right or Left to scroll forward or backward a day at a time or to display more To Do items.
- Tap any appointment while in Agenda view to display the Day View of the appointment.
- Check off completed To Do List items in the Agenda view, or tap a description of an item to go directly into To Do List.
- You can change the category of To Do items shown. From the pick list, select the new category. See the chapter that begins on [page 106](#) for more information on To Do items.



Spotting event conflicts

With the ability to define specific start and end times for any event, it is possible to schedule events that overlap (an event that starts before a previous event finishes).

An event conflict (time overlap) appears in the Week view as overlapping time bars and in the Day view as overlapping brackets to the left of the conflicting times.

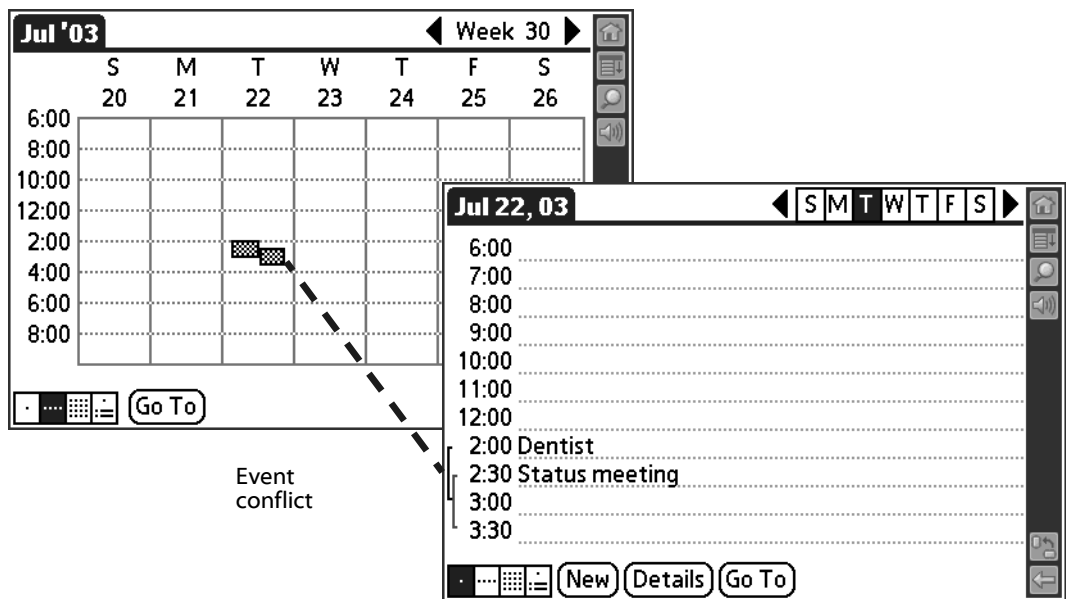

Changing the Date Book display

In Day or Month view, you can change which events appear in Date Book. In Day view, you can display time bars that highlight event conflicts.

1. In Day view or Month view, tap the Menu icon .
2. From the Options menu, select Display Options.



3. For Day view, select from the following options:

- **Show Time Bars.** Display time bars showing the duration of an event and any event conflicts.
- **Compress Day View.** Display start and end times for each event, but no blank time slots at the bottom of the screen, to minimize scrolling. Clear the option to display all time slots.

4. For Month view, select from the following options.

- **Show Timed Events.** Display time bars for events.
- **Show Untimed Events.** Display plus symbols for untimed events.
- **Show Daily Repeating Evts.** Display dashed lines for continuous events.

5. Tap OK.

Changing the displayed Start and End Times

You can change the preferences used for new entries. Preferences include display starting time, display ending time, and alarm characteristics. See [page 95](#) for more information on alarm preferences.

- 1. In Date Book, tap the Menu icon .**
- 2. From the Options menu, select Preferences.**

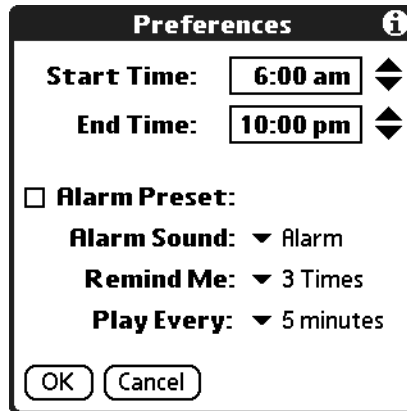

The Start and End Time are used by the various Date Book screens. The Day view schedules events to start and end at these times when the All Day option is selected. The Week view displays the time span defined by the Start Time and End Time.

- 3. Tap Start Time and use the scroll arrows to select a new start time for Date Book screens. Repeat the step to set a new end time. If the time slots you select do not fit on one screen, you can tap the scroll arrows to scroll up and down.**
- 4. Tap OK.**





Using Memo Pad

Memo Pad provides a place to take notes that are not associated with records in your other applications.

Use Memo Pad to:

- Take notes or write any kind of message on your handheld.
- Assign memos to categories so that you can organize and view them in logical groups.
- Write down phone numbers and other types of information. Later, you can copy and paste this information into other applications.

Opening Memo Pad

1. Press the Home button .
2. Select the Organizer category .
3. Select the Memo Pad icon .

Memo Pad opens to display the last Memo Pad screen that you viewed.

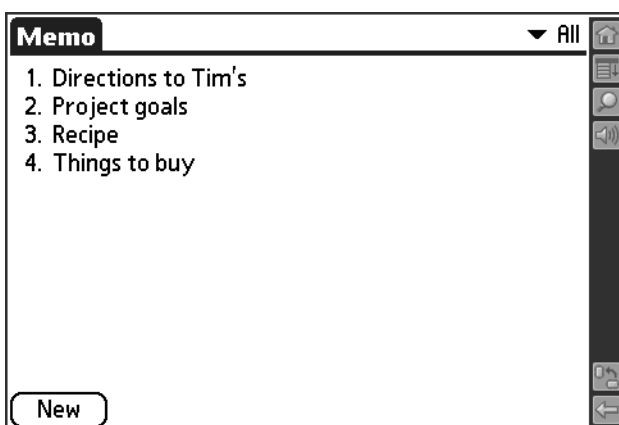



Creating memos

A record in Memo Pad is called a *memo*. A memo can contain up to 4,000 characters. The number of memos you can store is limited only by the memory available on your handheld.

When you create a new memo, you can add information to it from Address Book, such as a phone number or address, using the Phone Lookup option. For details, see [page 71](#).

1. **Open Memo Pad.**
2. **Tap New.**

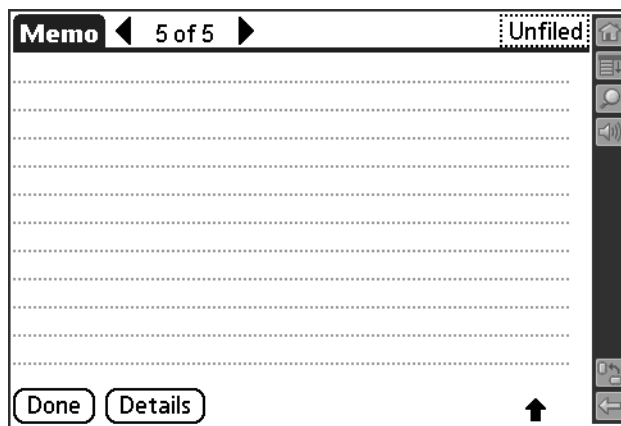

TIP: You can also create a new memo by beginning to write in the Input Area in the Memo List screen. The first letter is automatically capitalized and begins your new memo.

3. **Enter the text you want to appear in the memo. Use the carriage return stroke to move down to new lines in the memo.**
4. **Tap Done.**

You can categorize memos and sort them by categories. See the sections that begin on [page 67](#) and [page 72](#) for more information.



Reviewing memos

The Memo List displays the first line of a memo. This makes it easy to locate and review your memos. You can easily sort memos in the Memo List or move through memos using Memo options.

1. In the Memo List, tap the text of the memo.

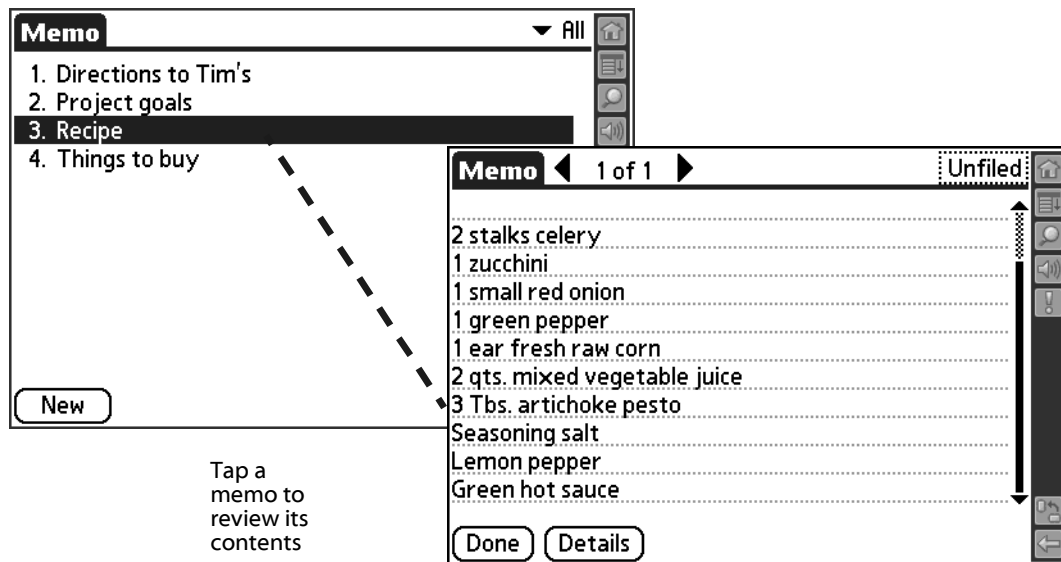

2. Review or edit the text in the memo.
3. Tap Done.

Arranging the Memo List

1. In the Memo List, tap the Menu icon .
2. From the Options menu, select Preferences.

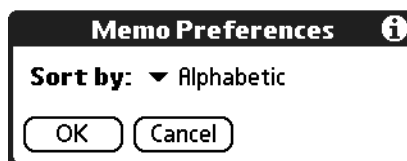

3. Select one of the following options:
 - **Manual.** Sort new memos in the sequence in which you create them.
 - **Alphabetical.** Sort new and existing memos in numerical and then alphabetical sequence.
4. Tap OK.





Using To Do List

To Do List is a convenient place to create reminders and prioritize the things that you have to do.

Use To Do List to:

- Make a quick and convenient list of things to do.
- Assign a priority level to each task.
- Assign a due date for any or all of your To Do List items.
- Assign To Do List items to categories so that you can organize and view them in logical groups (see [page 67](#)).
- Sort your To Do List items either by due date, priority level, or category.
- Attach notes to individual To Do List items for a description or clarification of the task (see [page 75](#)).

Opening To Do List

1. Press the Home button .
2. Select the Organizer category .
3. Select the To Do List icon .

To Do List opens to display the category of items you last viewed.

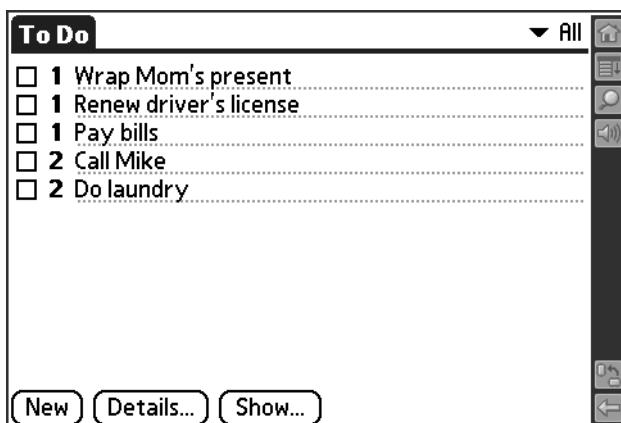



Creating To Do List items

A To Do List item is a reminder of some task that you have to complete. A record in To Do List is called an *item*.

1. Open To Do List.
2. Tap New.

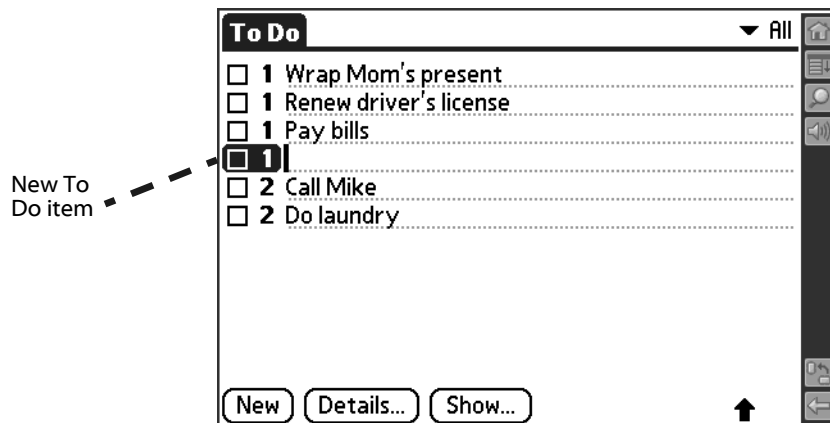

3. Enter the text of the To Do List item. The text can be longer than one line.

TIP: You can add a name, address, and phone number to a To Do List item using the Phone Lookup option. For more information, see [page 71](#).

4. Tap anywhere onscreen to deselect the To Do List item.

TIP: If no To Do List item is currently selected, writing in the Input Area automatically creates a new item.



Setting To Do List priorities

You can set priorities for tasks in your To Do List according to their importance or urgency. By default, items appear by priority and due date, with 1 as the highest priority. Changing an item's priority may move its position in the list.

New To Do List items automatically have a priority of 1. If you select another item first, before creating a new item, the item you create appears beneath the selected item with the same priority as the selected item.

1. If priorities aren't visible in To Do List, tap **Show** at the bottom of the list, tap **Show Priorities**, and tap **OK**.
2. Tap the **Priority** number on the left side of the To Do List item.

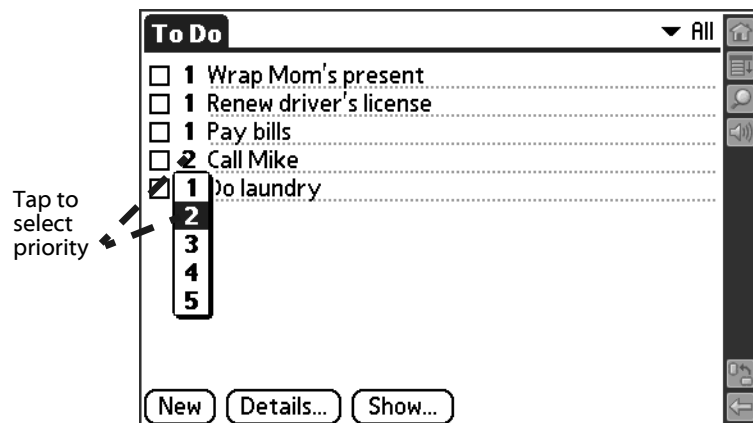

3. Tap the **Priority** number that you want to set. 1 is the most important and 5 is the least important.



Checking off To Do List items

You can check off a To Do List item to indicate that you've completed it.

1. In To Do List, tap Show.

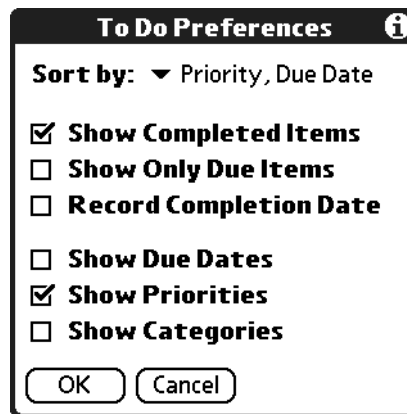

2. Check the Show Completed Items box.

NOTE: If you uncheck this setting, your To Do items disappear from the list when you complete (check) them. Items that no longer appear on the list because Show Completed Items is turned off have not been deleted. They are still in the memory of your handheld. You must purge completed items to remove them from memory.

3. Check the box on the left side of the item.

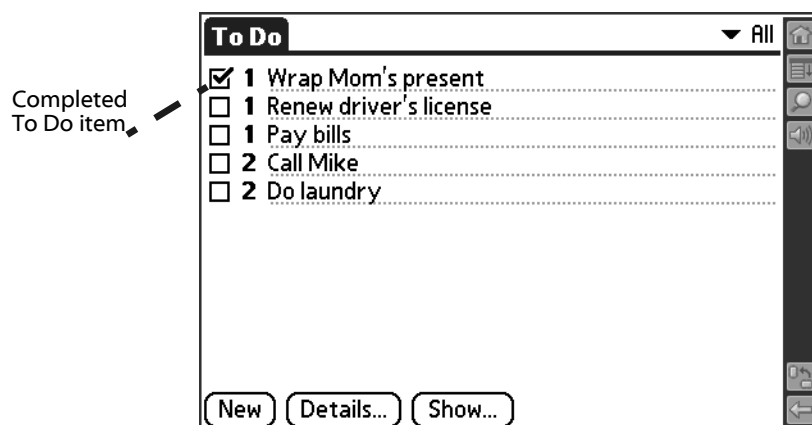



Changing priorities and due dates

You can change To Do List to display the due date assigned to an item, change its priority, and assign a category to the task with the To Do Item Details dialog box.

You can then sort To Do List items by priority, due date, or category.

- 1. In To Do List, tap the item that you want to change.**
- 2. Tap Details.**

To Do Item Details ⓘ

Priority: 1 2 3 4 5

Category: ▼ Unfiled

Due Date: ▼ No Date

Private:

OK Cancel Delete... Note

- 3. From the Due Date pick list, select the date that you want to assign the item. Options are Today, Tomorrow, One Week from the current date, No Date (removes the due date from the item), or Choose Date (displays a dialog box for you to select a date).**
- 4. Tap Private to hide this item when Security is turned on.**
For more information on hiding private records, see [page 74](#).
- 5. Tap OK.**

TIP: If you turn on the Show Due Dates option in the To Do Preferences dialog box, you can tap directly on the due date in To Do List to open the pick list shown in step 2.



Sorting To Do items

1. In To Do List, tap Show.

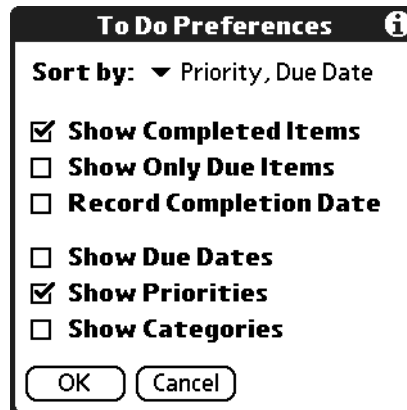

2. From the Sort By pick list, select an option:

- **Priority, Due Date.** Sort items by priority first, and then due date.
- **Due Date, Priority.** Sort items by due date first, and then priority.
- **Category, Priority.** Sort items by category first, and then priority.
- **Priority, Category.** Sort items by priority first, and then category.

3. Tap OK.

Setting To Do List preferences

You can have To Do List display completed items and their completion dates, as well as due items and their due dates.



1. In To Do List, tap Show.



2. In the To Do Preferences dialog box, choose from the following settings:

- **Show Completed Items.** Display your completed items in To Do List. If this box is unchecked, completed To Do items disappear from the list, but are kept in the memory of your handheld. You must purge completed items to remove them from memory.
- **Show Only Due Items.** Show only the items that are currently due, past due, or have no due date specified. When this box is checked, items that are not yet due do not appear in the list until their due date.
- **Record Completion Date.** Replace the due date with the actual completion date (when you check the item). If you do not assign a due date, the completion date still records when you complete the item.
- **Show Due Dates.** Display the due dates for items in To Do List, and display an exclamation mark next to items that remain incomplete after the due date passes.
- **Show Priorities.** Display the item priority to the left of each item in To Do List.
- **Show Categories.** Display the category to which the item is assigned to the right of each item in To Do List.

3. Tap OK.





Using Calculator

Calculator lets you perform general mathematical functions, such as addition, subtraction, multiplication, and division.

Use Calculator to:

- Perform basic calculations.
- Store and retrieve values.
- Display the last series of calculations, which is useful for confirming a series of “chain” calculations.

Opening Calculator



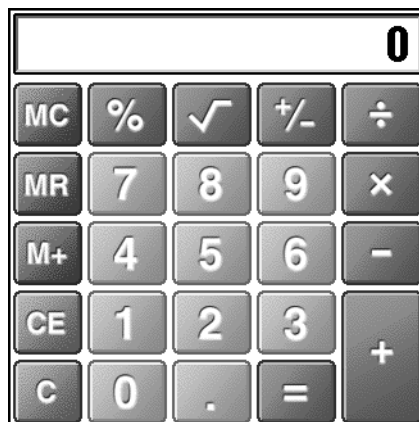



1. Press the Home button .
2. Select the Organizer category .
3. Select the Calculator icon .





Using the Calculator buttons

Calculator includes several buttons to help you perform calculations.

-  **CE** Clears the last number you entered. Use this button if you make a mistake while entering a number in the middle of a calculation. This button enables you to re-enter the number without starting the calculation over.
-  **C** Clears the entire calculation and enables you to begin a fresh calculation.
-  **+/-** Toggles the current number between a negative and positive value. If you want to enter a negative number, enter the number first and then press the +/- button.
-  **M+** Places the current number in memory. Each new number you enter with the M+ button is added to the total stored in memory. The number that you add can be either a calculated value or entered by pressing the number buttons. Pressing this button has no effect on the current calculation (or series of calculations); it merely places the value into memory until it is recalled.
-  **MR** Recalls the stored value from memory and inserts it in the current calculation.
-  **MC** Clears any value stored in Calculator's memory.



Displaying recent calculations

The Recent Calculations command lets you review the last series of calculations and helps you confirm a chain of calculations.

1. In Calculator, tap the Menu icon
2. From the Options menu, select Recent Calculations.

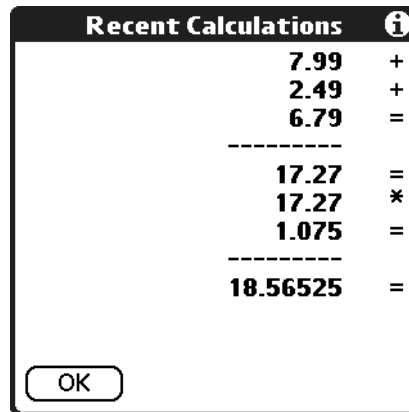

3. After you finish reviewing the calculations, tap OK.



Setting Preferences

The Preferences screens enable you to customize your handheld in a variety of ways. Your handheld includes the following Preferences screens:

- Bluetooth
- Calibration
- Connection
- Date & Time
- Formats
- General
- Graffiti 2
- Network
- Owner
- Phone
- ShortCuts
- Sound

Opening the Preferences screens

1. Press the Home button .
2. Select the Prefs category .
3. Select the Preferences screen you want to view.



Bluetooth

The built-in Bluetooth radio enables you to play multi-player games and exchange data with other devices enabled with Bluetooth technology. The Bluetooth Preferences settings control the built-in Bluetooth radio, and include the following:

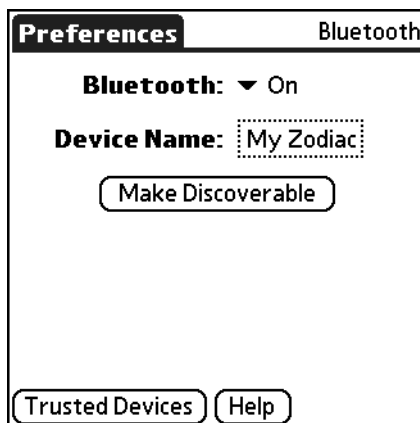

- **Bluetooth.** Turn the Bluetooth radio on and off. You can also turn this option on by pressing the Bluetooth button .
- **Device Name.** Assign a name to your handheld for Bluetooth communication. By default the device name is the same as your HotSync user name.
- **Make/End Discoverable.** Indicate whether you want your handheld to automatically connect with devices with which you have previously formed a trusted pair. You can still refuse invitations from unrecognized devices.
- **Trusted Devices.** Create a *buddy* list of Bluetooth devices from which your handheld should automatically accept communications. For each device you must enter an identical passkey on both devices. If a device without a recognized passkey attempts to communicate with your handheld, it goes through the discovery and authentication process, and you can choose to accept or reject the communication.

For additional information about using the Bluetooth features of your handheld visit tapwave.com.



Calibration

The Calibration Preferences screen enables you to calibrate your handheld so that it accurately interprets taps on the touch-screen and movements of the analog controller ✱. If you tap an option on the screen and it activates a different option, or if you move the analog controller and the insertion point moves in the wrong direction, you need to calibrate. To calibrate the screen or analog controller, simply follow the onscreen instructions and tap the targets or move the analog controller as indicated.

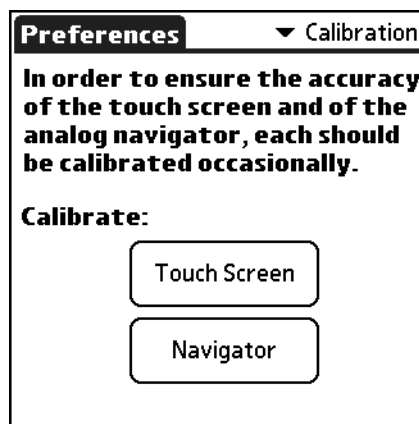

Connection

The Connection Preferences screen allows you to create configurations that enable your handheld to use a PC, modem, or GSM mobile phone to communicate with remote devices such as your ISP or a remote computer---provided the appropriate hardware is available. The Connection Preferences screen displays a list of available configurations which is based on the software installed on your handheld. If necessary you can use the buttons at the bottom of the screen to add, modify, or delete configurations.

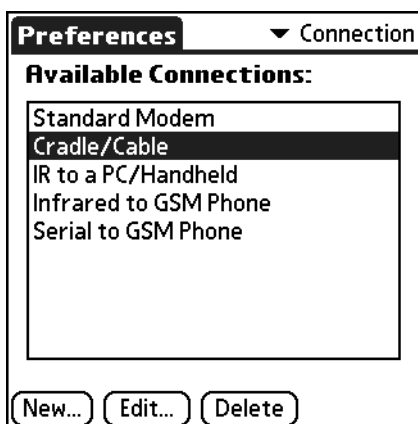

When you create or modify Connection Preferences, you are presented with the following choices:

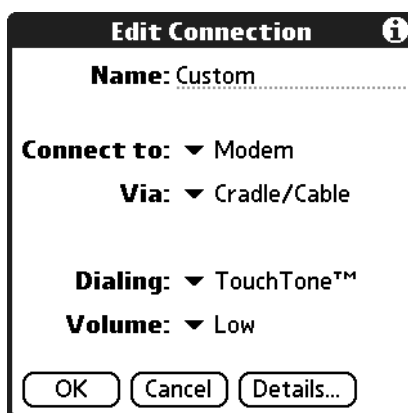

- **Name.** Assign or modify the configuration name. This is the label that appears in the list in the Connection Preferences screen.
- **Connect to.** Select the type of device to which you want to connect your handheld. The choices are: PC, Modem, Phone, and Local Network.
- **Via.** Select the method you are using to connect your handheld and the selected device. The choices are: Cradle/Cable, Infrared, and Bluetooth.
- **Dialing (modem only).** Indicate whether to use Touchtone or Rotary dialing tones. Select Rotary only if your telephone service does not support TouchTone dialing.
- **Volume (modem only).** Indicate how loud you want the dialing tones.



- **Model (phone only).** Select the model of your phone. If your phone does not appear in the list, select Standard GSM, or install a phone driver.
- **Details.** Provides access to the following additional settings:

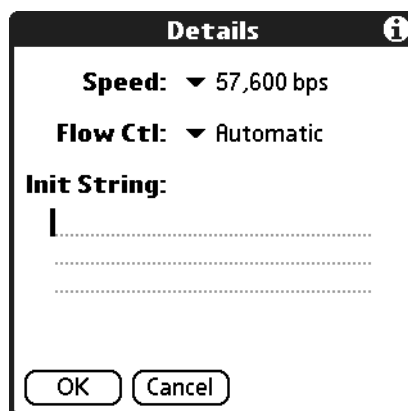

- **Speed.** Select the maximum speed for your modem to communicate with your handheld. This setting does *not* control the speed at which your modem communicates with your telephone service.
- **Flow Ctl (Flow Control).** Select a connection option. Options are Automatic, On (Xon), or Off (Xoff).
- **Init String (modem and phone only).** Enter or edit text to change the modem or phone setup string.

Date & Time

The Date & Time Preferences screen is where you set the date, time, time zone, and Daylight Savings time for your handheld. These settings are used in all the applications on your handheld which respect the system calendar and clock.

The Date & Time Preferences screen includes the following settings:



Preferences ▼ Date & Time

Set Date: 7/21/03

Set Time: 11:02 am

Set Time Zone: USA (Pacific)

Daylight Saving: ▼ Off

- **Set Date.** Set the system calendar by selecting the current date.
 - **Year.** Tap the arrows at the top of the Set Date Screen to select the current year.
 - **Month.** Tap the box for the current month.
 - **Date.** Tap the number for the current date.
 - **Today.** Tap this button to accept your date selection.
- **Set Time.** Set the system clock by selecting the current time.
 - **Hour.** Tap the hour box and then tap the arrows to change the hour.
 - **Minutes.** Tap each minute number, and then tap the arrows to change the number.
 - **AM/PM.** Tap the boxes to choose the AM or PM suffix.

NOTE: To display time based on a 24-hour clock, change the time format. See [page 122](#).

- **Set Time Zone.** Select the time zone for the system clock. Choose the time zone from the list that corresponds to where you are. When you travel, use this dialog to change time zones. If you're not sure what time zone you are in, find out what time it is, and select the time zone which shows the correct new time.



Country	GMT +/-
United Kingdom	0:00
USA (Hawaii)	-10:00
USA (Alaska)	-9:00
USA (Pacific)	-8:00
USA (Mountain)	-7:00
USA (Central)	-6:00
USA (Eastern)	-5:00

Current Time: 11:05 am Mon
New Time: 11:05 am Mon

OK Cancel

- **Daylight Saving.** Indicate whether Daylight Saving is currently applicable in your area.

Formats

The Formats Preferences screen enables you to choose a default country for your handheld and to set default formats for times, dates, and numbers. These formats apply to all the dates, times, and numbers in all the applications on your handheld. The Formats Preferences screen includes the following settings:

Preferences ▼ Formats

Preset to: United States

Time: ▼ HH:MM am/pm
11:08 am

Date: ▼ M/D/Y
7/21/03
Jul 21, 2003

Week starts: ▼ Sunday

Numbers: ▼ 1,000.00

- **Preset To.** Select a country name. When you select a country, the other settings adjust as well. For example, if you select Germany, time is expressed using a 24-hour clock and the starting day of the week is Monday; if you select the United States, time is expressed using a 12-hour clock with an AM or PM suffix and the starting day of the week is



Sunday. You can, however, customize the individual settings regardless of which country you select.

- **Time.** Select a format. *H* is hour and *M* is minute.
- **Date.** Select a format. *D* is day, *M* is month, and *Y* is year.
- **Week starts.** Select Sunday or Monday as the first day of the week.
- **Numbers.** Select the decimal point and thousands separator.

General

The General Preferences screen enables you to adjust various settings in order to save battery power when your handheld is not connected to a power outlet, and to set the position of the Input Area. The General Preferences screen includes the following settings:

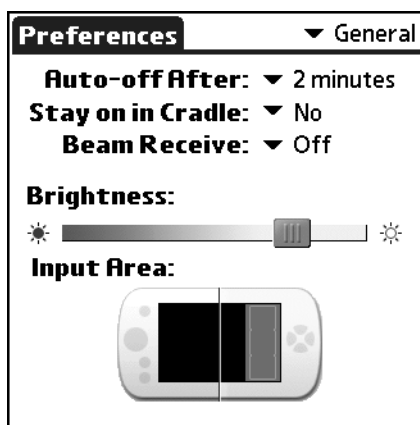

- **Auto-off after.** Set when your handheld automatically shuts off. After the selected period of inactivity, the power and backlight turn off to conserve battery power. If you find that your handheld shuts itself off before you finish reviewing the information on the screen, increase this setting.
- **Stay on in Cradle.** Determine whether to keep your handheld on while it is connected to the HotSync cable or cradle and a power outlet. Choosing Off causes your handheld to shut off after the Auto-off interval (also set on this screen) expires.
- **Beam Receive.** Indicate whether you want to prohibit anyone from beaming information to your handheld. If you disable beaming, it saves a little battery power. By default, Beam Receive is enabled.



- **Brightness.** Adjust the brightness of the display by dragging the slider on the screen.
- **Input Area Position.** Indicate whether you want the Status Bar and Input Area to appear on the left or right side of the screen when the display is in landscape mode. This option is designed to facilitate left-handed data entry.

TIP: Tap the Orientation icon in the Status Bar to switch between portrait (horizontal) and landscape (vertical) mode.

Graffiti 2

The Graffiti 2 Preferences provides alternate strokes for making the T, P, Y, and \$ characters. For example, you may want to form the letter T by using strokes similar to a space and an L. But if this technique is difficult to control, you can turn off this option. You can set preferences by tapping the characters that appear on the following Graffiti 2 Preferences screen.

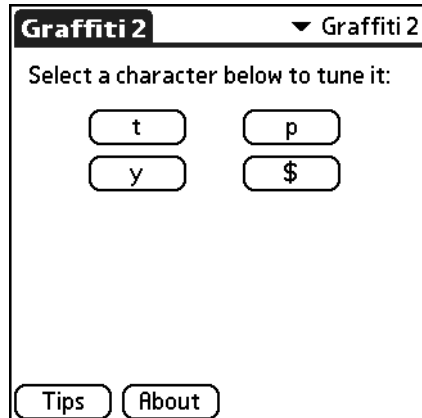

Network

Network Preferences let you set a password, telephone number, DNS number, IP address, as well as create a login script for remote connections. You can use a preset service template for your ISP or dial-in server, and edit, save, and reuse settings. Or you can create your own service template.



To use the TCP/IP software included in the handheld operating system for remote connections, you must set Network Preferences, as well as Connection Preferences.

The Network Preferences screen includes the following settings:

Preferences ▼ Network

▼ **Service:** AT&T WorldNet

User Name: username@worldnet.att.net

Password: -Prompt-

Connection: ▼ Standard Modem

Phone: Tap to enter phone

Details... Connect

- **Service.** Select a predefined service template you want to use. If you use one of the predefined service templates, you probably only need to enter your user name and telephone number. If the service template you want does not appear on the list, you can create your own service templates from scratch or duplicate existing templates and edit the information using the New and Duplicate commands on the Service menu.
- **User Name.** Enter the name you use when logging in to your ISP or dial-in server. Do not enter spaces unless your dial-in server accepts them.
- **Password.** Indicate whether to save your password as part of the template.
 - **Prompt.** If you're concerned about security and want to be prompted for your password when logging in to your ISP or dial-up server, do not enter anything. Leave "Prompt" in the Password field.
 - **Assigned.** If you do not want to be prompted for a password during login, tap the Password field and enter your password. "Assigned" appears in the Password field.
- **Connection.** Select a configuration. The list includes the configurations displayed on the Connection Preferences screen.



- **Phone.** Enter the phone number you use to reach your ISP or dial-in server. When you tap the Phone field, you have the following additional options:

The image shows a 'Phone Setup' dialog box with a title bar containing an information icon. The dialog contains the following fields and options:

- Phone #:** A text field with a cursor and a dotted line indicating input.
- Dial prefix:** A checkbox followed by a text field containing '9' and a dotted line.
- Disable call waiting:** A checkbox followed by a text field containing '1170' and a dotted line.
- Use calling card:** A checkbox followed by a text field containing three commas and a dotted line.

At the bottom of the dialog are two buttons: 'OK' and 'Cancel'.

- **Dial prefix.** Indicate whether you need to enter a prefix before dialing the telephone number to access an outside line. For example, many offices require that you dial “9” to dial a number outside the building. If you need to use a prefix, check the Dial Prefix box, and enter the prefix.
- **Disable call waiting.** Toggle call waiting on and off. Call Waiting can end your network session if you receive a call while you are connected. To turn off Call Waiting, check the Disable call waiting box, and enter the code to turn off Call Waiting. If you don’t know the code, contact your local telephone company for the appropriate code.
- **Use calling card.** Indicate whether you want to put the charges for the phone call on a calling card. To activate this option, check the Use Calling Card box, and then on the Use Calling Card line, enter three commas followed by your calling card number. Each comma delays transmission of your calling card number for two seconds, to compensate for the delay before the number is entered.

NOTE: MCI customers must enter the calling card number in the Phone # field, and the phone number in the Use Calling Card field.



Network Details

The Details dialog box enables you to select TCP/IP settings. When you tap the Details button, you have the following additional options:

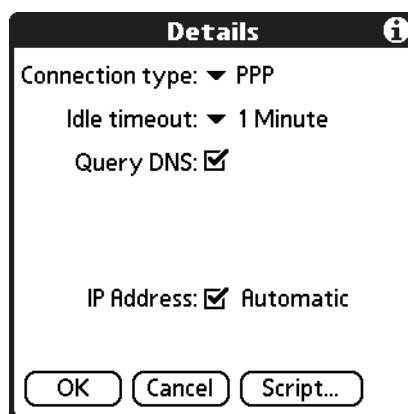

- **Connection type.** Select the connection protocol you want to use for this service template:
 - **PPP for Point-to-Point protocol.** Select this type if you're unsure which you need. If PPP doesn't work, ask your ISP or your system administrator for the correct connection type.
 - **SLIP.** Select this type for Serial Line Internet protocol connections.
 - **CSLIP.** Select this type for Compressed Serial Line Internet protocol connections.
- **Idle timeout.** Specify how long your handheld waits to drop your connection when you exit a TCP/IP application. Options include Immediate, 1 minute, 2 minutes, 3 minutes, or Never (until the power is off or your handheld times out).
- **Query DNS.** Indicate whether a DNS number is required. The Internet uses the Domain Naming System (DNS) to translate the names of host computers into IP addresses. A DNS number (or IP address) identifies a specific server that handles the translation services. Anyone who logs onto the Internet must have a unique identifier—an IP address. This IP address can be either temporary—assigned automatically each time you log on—or permanent. Not all systems require that you enter a DNS number; check with your system administrator to see if it is required.



To enter a DNS number, uncheck the Query DNS box (the Primary and Secondary DNS fields appear). In the Primary DNS number field, tap the space to the left of the first period in the Primary DNS field and enter the first section of the IP address using a number only, from 0 to 255; repeat the step for the remaining sections of the field. Use the same technique to enter the Secondary DNS number.

- **IP Address Automatic.** Indicate whether your server's IP address is temporary or permanent. If your IP address is automatic and temporary, make sure that the IP Address box is checked. If your IP address is permanently assigned, uncheck the IP Address box. In the permanent IP address field, tap the space to the left of the first period, and enter the first section of the IP address using a number only, from 0 to 255. Repeat the step for the remaining sections of the field.

Login scripts

A login script is a series of commands that automates logging into your ISP or remote server.

You can create login script files by selecting commands in the Login Script dialog box. Some commands, such as Send, require additional information and have a parameter field to add the necessary data.

You can also use non-ASCII and literal characters in your login script. See [page 130](#) for more information.

1. **With a service template selected in the Network Preferences screen, tap Details.**
2. **In the Details dialog box, tap Script.**

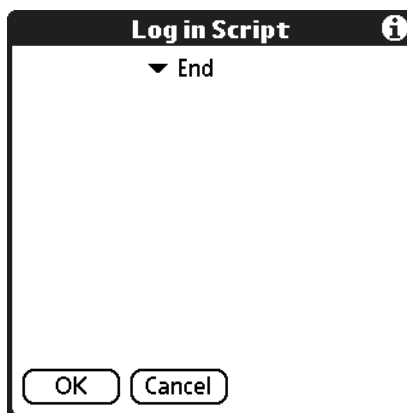



3. From the End pick list on the Login Script screen, select any of the following commands and enter additional information if a field appears:

- **Wait For.** Instruct your handheld to wait for specific characters from the TCP/IP server before executing the next command.
- **Wait For Prompt.** Instruct your handheld to use a dynamically generated challenge-response value from the server. You must enter the challenge value into your token card. This generates a response value which you must enter on your handheld. This command requires two arguments that are separated by a vertical bar (|).
- **Send.** Transmit specific characters to the TCP/IP server to which you are connecting.
- **Send CR.** Transmit a carriage return or LF character to the TCP/IP server to which you are connecting.
- **Send User ID.** Transmit the User ID information entered in the User ID field of the Network Preferences screen.
- **Send Password.** Transmit the password entered in the Password field of the Network Preferences screen. If you did not enter a password, this command prompts you to enter one. The Password command is usually followed by a Send CR command.
- **Delay.** Instruct your handheld to wait a specific number of seconds before executing the next command in the login script.
- **Get IP (for SLIP connections).** Read an IP address and use it as the IP address for your handheld.
- **Prompt.** Open a dialog box that prompts you to enter text of some kind (for example, a password or a security code).
- **End.** Identify the last line in the login script.

4. Repeat steps 2 and 3 to complete the login script.

5. Tap OK, and then tap OK in the Details dialog box.



Non-ASCII characters

If you know how to write custom scripts with non-ASCII characters, you can incorporate the caret (^char) character, carriage returns and line feeds, and literal characters in your custom login scripts.

- Use the caret (^ char) character to transmit ASCII command characters. If you send ^char, and the ASCII value of char is between @ and _, then the character is automatically translated to a single-byte value between 0 and 31.

For example, ^M is converted to a carriage return. If char is a value between a and z, then the character sequence is translated to a single-byte value between 1 and 26. If char is any other value, then the character sequence is not subject to any special processing. Thus, the string "Joe^M" transmits *Joe*, followed by a carriage return.

- You can include carriage return and line feed commands as part of the login script, when entered in the following format:

<cr>Sends or receives a carriage return

<lf>Sends or receives a line feed

For example, the string "waitfor Joe<cr><lf>" waits to receive *Joe*, followed by a carriage return and line feed from the remote computer, before executing the next command in the script.

- You can use the backslash (\) character to specify that the next character be transmitted as a literal character, and not be subject to any special processing ordinarily associated with that character. For example:

\^Includes a caret as part of the string

\<Includes a < as part of the string

\\Includes a backslash as part of the string



Connecting to your ISP or dial-in service

After you set Connection and Network Preferences, you can easily connect to your ISP or dial-in server.

You can make the connection using either Network Preferences commands or a third-party application. Connecting to an ISP requires a third-party application, such as a Web browser or news reader. For information on third-party applications that support TCP/IP, check the Web site tapwave.com.

- 1. From the Network Preferences screen, tap Connect to dial the current service and display the Service Connection Progress messages.**
- 2. To see expanded Service Connection Progress messages, press Down during login.**
- 3. Tap Disconnect to terminate the connection between your handheld and your service.**

Owner

Use Owner Preferences to record a name, company name, phone number, or any other identification information you want to include on your handheld.

If you use Security to turn off and lock your handheld with a password, the information that you enter in Owner Preferences appears the next time you turn on your handheld.

NOTE: If you assign a password to your handheld using Security, you must tap Unlock and enter your password to change the information on the Owner Preferences screen.

Preferences	▼ Owner
This handheld computer is owned by:	
Midyne Spear
Creative Spearit
P.O. Box 65
Bonny Doon, CA 95060
831-555-7534
.....
.....



Phone

Use the Phone Preferences screen to pick a connection profile. These settings are used by SMS and a variety of third-party applications.

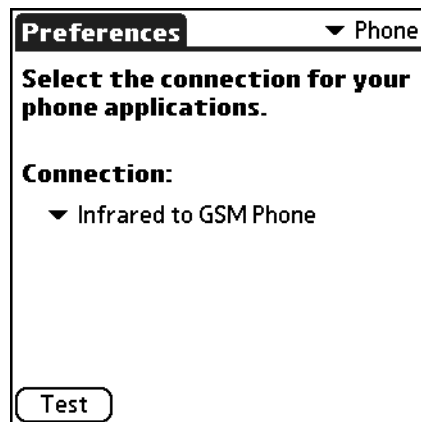

- **Connection.** Select a Connection configuration for applications that require a phone connection. Select Infrared to GSM Phone or Serial to GSM Phone according to your hardware setup. The details of your connection should already be set up, in the Connection Preferences. However, you can edit information from this pick list if necessary.

If no connection methods are available, then --None-- appears in the pick list. This means that no phone drivers exist on your handheld. In this case you must install the phone driver on your computer and synchronize with your handheld.

If your phone is enabled and connected, you can test the connection by tapping the Test button. This initiates a simple query of the phone to make sure the connection is working and the correct phone is being used.



ShortCut

ShortCut Preferences enable you to create ShortCuts for up to 45 characters. For example, you could create a ShortCut for your name or for the header of a memo. All ShortCuts you create appear on the list in the ShortCut Preferences screen, are available in any of your handheld applications, and are backed up on your computer when you perform a HotSync operation.

The ShortCuts Preferences screen includes the following options:

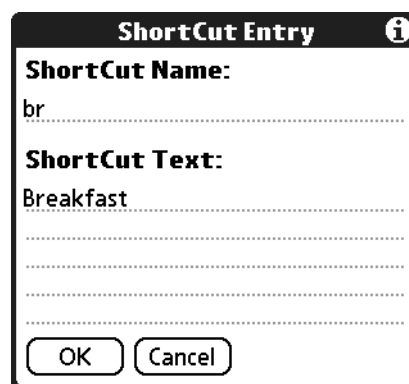
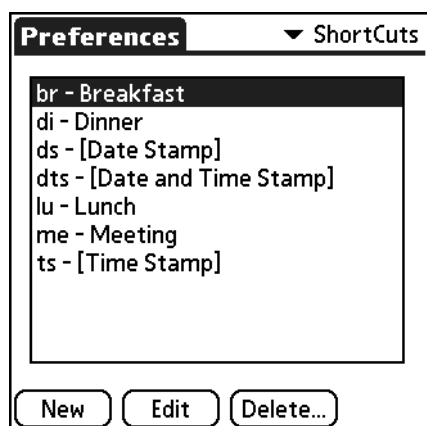

- **New.** Define a new shortcut.
 - **ShortCut Name.** Enter the letters you want to use to activate the ShortCut.
 - **ShortCut Text.** Enter the text that you want to appear when you write the ShortCut characters.

TIP: You can add a space character after the last word in your ShortCut text so that a space automatically follows the ShortCut text.

- **Edit.** Modify an existing ShortCut. From the ShortCut Preferences screen, tap the ShortCut you want to edit, tap Edit, and then enter your changes.
- **Delete.** Remove a ShortCut. From the ShortCut Preferences screen, tap the ShortCut you want to delete and then tap Delete.



Sound

The Sound Preferences enable you to adjust the sound and alarm settings using the following settings:

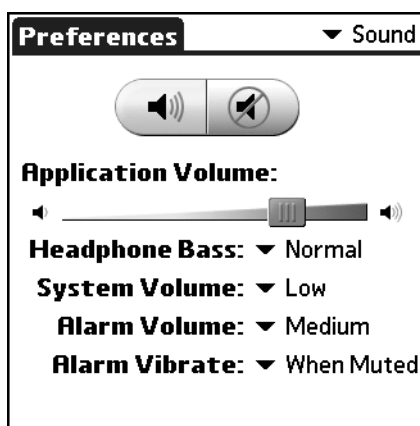

- Turn all sounds on or mute all sounds. When sound is on, you have the following options:
 - **Application Volume.** Adjust the volume level for the sounds in your applications by dragging the slider or tapping to the right or left of the slider to move it in small increments. Some older Palm OS® games may not respond to this setting.
 - **Headphone Bass.** Set the bass level for sounds in your applications. The choices are: Normal or Boost.
 - **System Volume.** Set the volume level for system sounds. The System Volume level is relative to the Application Volume level. As you increase or decrease the Application Volume level the System Volume level follows. Turning off the System Volume also turns off the chime tones during HotSync operations. The choices are: Off, Low, Medium, or High.
 - **Alarm Volume.** Set the volume level for alarm sounds. The choices are: Off, Low, Medium, or High.
 - **Alarm Vibrate.** Turn the vibrate option On or Off. When you enable the Alarm Vibrate setting, your handheld vibrates to notify you of alarms. This is useful when you want the Alarm Sound off, but still want to be notified of alarms.



When sound is muted, you have the following options:

- **Mute Until.** Choose how long you want sounds to remain off. The choices vary based on the current time.
- **Always Vibrate when Muted.** Indicate whether you want to automatically activate the Alarm Vibrate option each time you mute all sound.



Synchronizing Data

HotSync technology lets you synchronize—exchange and update—data between your Zodiac handheld and Palm Desktop software or another desktop organizer application such as Microsoft Outlook.

The HotSync process automatically synchronizes data between your handheld and Palm Desktop software. Changes you make on your handheld or in Palm Desktop software appear in both places after a HotSync operation. HotSync technology synchronizes only the needed portions of files, thus reducing synchronization time.

You can synchronize your data by connecting your handheld to your computer with the HotSync cable or cradle. If your computer is configured for infrared communication, you can also use the IR port on your handheld to perform HotSync operations. This chapter describes how to select HotSync options and perform a HotSync operation via the cable/cradle or infrared communication.

If you are a System Administrator preparing several handhelds for a group of users, you may want to create a user profile. See [page 144](#) before performing the following steps.

Performing a cable or cradle HotSync operation

The following steps assume that you have already installed the Palm Desktop software. If you have not installed this software, see [page 16](#) for instructions.

- 1. Connect your handheld to the HotSync cable or cradle.**



Synchronizing Data

Performing a cable or cradle HotSync operation

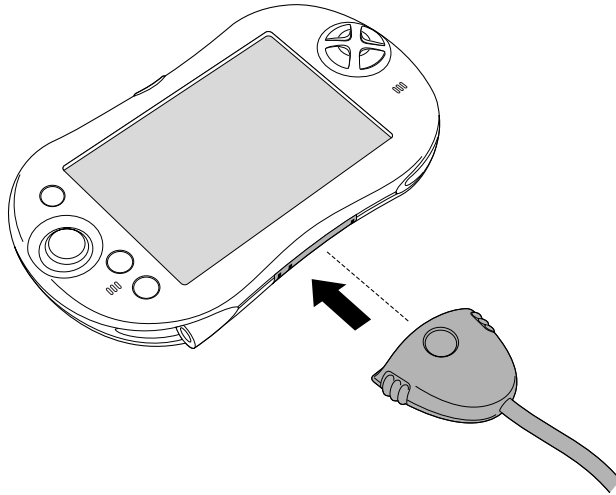

The bottom edge of the handheld should align smoothly with the cable or cradle when it is properly connected.

2. Make sure the HotSync Manager software is running.

If it is running, the HotSync icon ™ appears in the Windows system tray. If HotSync Manager is not running, click the Start button on the Windows desktop and choose Programs. Navigate to the Palm Desktop software program group and choose HotSync Manager. Alternatively, you can start the Palm Desktop software which automatically opens HotSync Manager.

3. Press the HotSync button on the cradle.

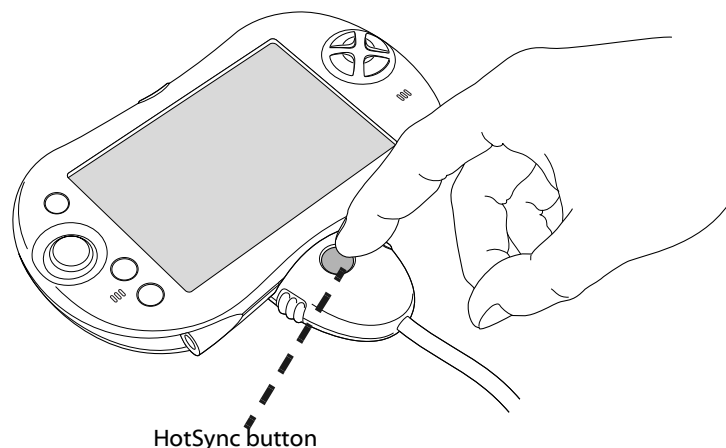



4. If prompted, select the user name you entered when you installed Palm Desktop software. The HotSync Progress dialog box appears and synchronization begins.

Every handheld should have a unique name. To prevent loss of a user's records, never try to synchronize more than one handheld to the same user name.

5. Wait for a message on your handheld indicating that the process is complete.

When the HotSync process is complete, you can remove your handheld from the HotSync cable or cradle.

Selecting HotSync setup options

You can choose when you want HotSync Manager to run. If necessary, you can adjust the other HotSync settings as well.

1. Click the HotSync Manager icon  in the Windows system tray.
2. Choose Setup.
3. Click the General tab, and select one of the following options:

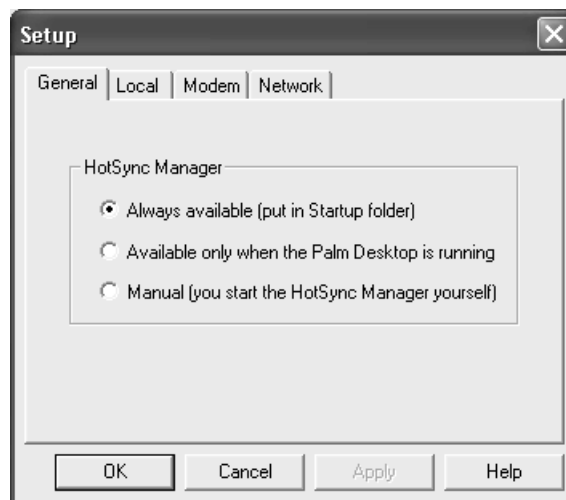

- **Always Available.** Add HotSync Manager to the Startup folder and constantly monitors the communication port for synchronization requests from your handheld. With this option, HotSync Manager synchronizes data even when Palm Desktop software is not running.



- **Available Only When Palm Desktop software Is Running.** Start HotSync Manager and monitors requests automatically when you open Palm Desktop software.
- **Manual.** Monitor requests only when you select HotSync Manager from the Start menu.

If you're not sure which option to use, keep the default setting, Always Available.

4. Click OK.

Customizing HotSync application settings

For each application, you can define a set of options that determines how records are handled during synchronization. These options are called a "conduit." By default, a HotSync operation synchronizes all files between the handheld and Palm Desktop software.

In general, you should leave the settings to synchronize all files. The only reason you might want to change these settings is to overwrite data on either your handheld or Palm Desktop software, or to avoid synchronizing a particular type of file because you don't use it.

In addition to the conduits for Date Book, Address Book, To Do List, Memo Pad, Photos, and Music, Palm Desktop software includes High Score, System, and Install conduits. The High Score conduit synchronizes the high score database with the Tournament Zone on the Tapwave web site. The System conduit backs up the system information stored on your handheld, including Graffiti 2 ShortCuts. The Install conduit installs applications on your handheld.

1. Click the HotSync icon  in the Windows system tray (bottom-right corner of the taskbar).

TIP: You can also click the HotSync command on the Palm Desktop software menu bar.

2. From the HotSync Manager menu, choose Custom.

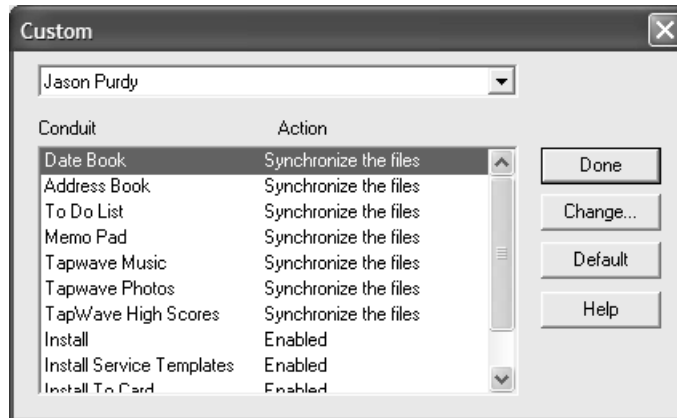

3. Select the appropriate user name from the list.
4. Select an application in the Conduit list. Click Change.

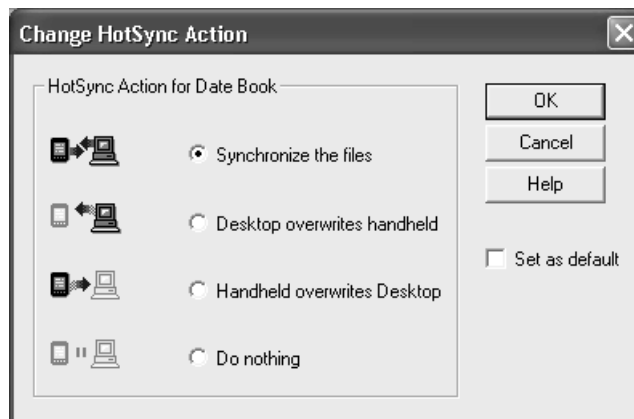

5. Click the direction in which you want to write data, or click Do Nothing to skip data transfer for an application.
6. Choose how long the setting remains in effect:
 - To affect only the next HotSync operation, deselect Set As Default. Thereafter, the HotSync Actions revert to their default settings.
 - To use a new setting as the default, select the Set As Default option. Thereafter, whatever you selected as the default setting is used when you click the Default button in the Custom dialog.
7. Click OK.
8. Repeat steps 4 - 7 to change conduit settings for other applications.
9. Click Done to activate your settings.



IR HotSync operations

Your organizer is equipped with an infrared (IR) port that supports the IrCOMM implementation of the standards for infrared communication established by the Infrared Data Association (IrDA). This means that you can beam data to any other device that supports the IrCOMM implementation of the IrDA standards. Most importantly, you can use the IR port to perform HotSync operations without a HotSync cable or cradle. This is very useful if you travel with an infrared-enabled laptop. You simply enable infrared communication on your laptop and handheld, and then follow the steps on [page 143](#).

Preparing your computer for infrared communication

Before you can perform a HotSync operation using the IR port, the computer you want to synchronize with must meet the following requirements:

- The computer must support the IrCOMM implementation of the IrDA standards.
- The computer must have an enabled infrared port built-in, or an enabled infrared device attached to the computer.

Desktop computers are likely to require an infrared device attached to a physical serial port. Laptops are likely to have a built-in IR port. Your computer must also have an installed infrared driver.

- 1. In the Windows taskbar click Start, choose Settings, and then choose Control Panel.**
- 2. Double-click Infrared.**
- 3. Click the Options tab.**
- 4. Select Enable infrared communication.**

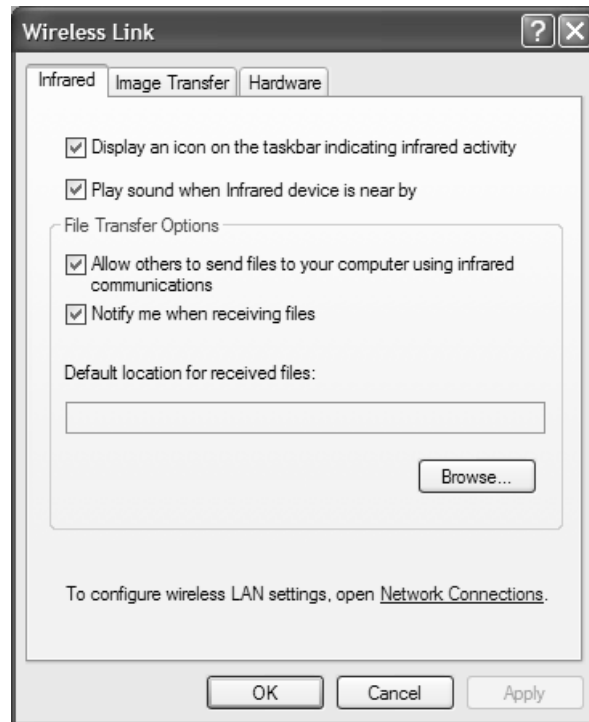

The COM port displayed in the drop-down box is the port where your infrared device is attached. It should be different from any port used by HotSync Manager.

- 5. Make a note of which port is listed as “Providing application support.” You need this information to configure HotSync Manager for infrared communication. This port is the simulated port. It is the channel through which the actual infrared communication takes place between your computer and your handheld.**
- 6. Uncheck all other boxes in the Options tab.**
- 7. Click Apply and OK.**



Configuring HotSync Manager for infrared communication

Next you need to go to HotSync Manager and specify the that the infrared port should be used for the HotSync operation.

1. Click the HotSync Manager icon in the Windows system tray.
2. Make sure Local is checked on the menu.
3. Choose Setup.
4. Click the Local tab.

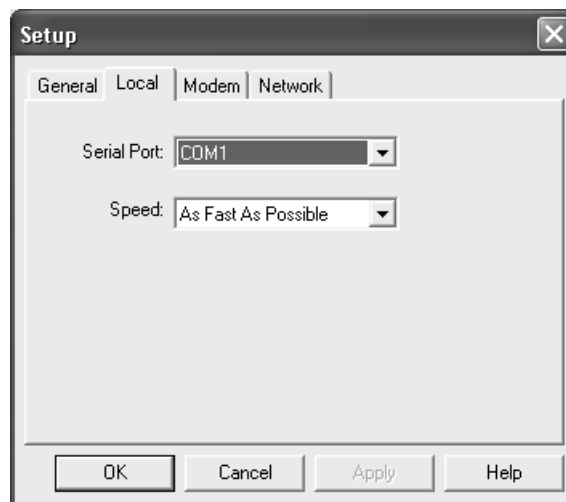

5. In the Serial Port drop-down box, select the COM port that was given as the simulated port in the Options tab of the Infrared Monitor.
6. Click OK.

Performing an IR HotSync operation

After you complete the steps to prepare for an IR HotSync operation it is easy to perform the actual operation.

1. Press the Home button .
2. Select the Utilities category .
3. Select the HotSync icon .
4. Tap Local.
5. From the pick list below the HotSync icon, select IR to a PC/Handheld.

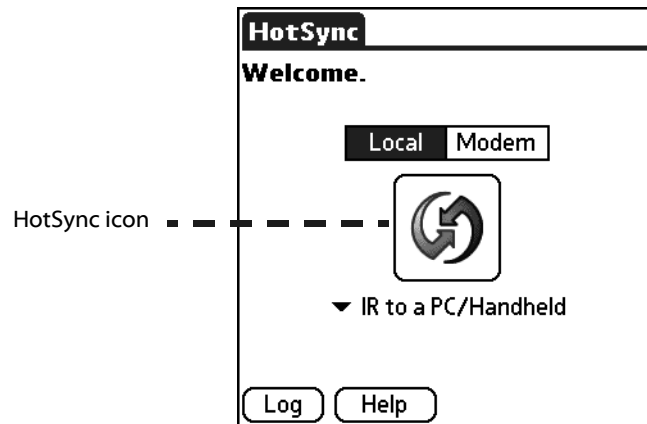

- 6. Position the IR port of your organizer within a couple of inches of the infrared port of your computer.**
- 7. Tap the HotSync icon to start the IR HotSync operation.**

Returning to using the cradle for HotSync operations

It's easy to return to using the cradle for HotSync operations.

The next time you want to perform a HotSync operation just press the HotSync button on the cradle. You can leave the HotSync application on your handheld set to perform IR HotSync operations and still use the cradle. This is useful if you perform HotSync operations with both your desktop computer and a laptop that you travel with. When you travel you don't have to carry a cradle or cable. When you are in the office just place your organizer in the cradle and press the HotSync button.

Creating a user profile

You can create a user profile to load data into an handheld without associating that data with a user name. This feature lets System Administrators configure several handhelds with specific information (such as a company phone list) before distributing them to their actual users.

The User Profile feature is designed only for the first-time HotSync operation, before you assign a User ID to a particular handheld.

- 1. Open Palm Desktop software.**
- 2. From the Tools menu, choose Users.**

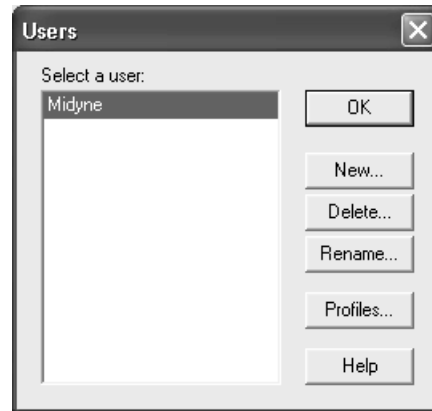

3. Click Profiles.

4. Click New. Enter a unique name for the profile and click OK.

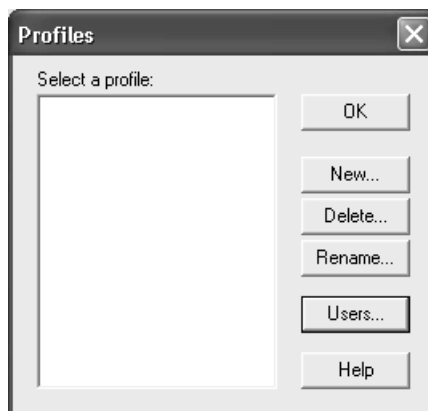

5. Click OK to return to Palm Desktop software.

6. Select the profile from the User list and create the data for the profile (for example, company phone list, and so on).

Using a profile for the first-time HotSync operation

1. Place the new handheld in the cradle.

2. Press the HotSync button on the cradle.

3. Click Profiles.

4. Select the profile that you want to load on the handheld, and click OK.

5. Click Yes to transfer all the profile data to the handheld.

The next time you perform a HotSync operation, Palm Desktop software prompts you to assign a user name to the handheld.



Security

Your handheld includes a Security application that lets you set options to protect entries from unauthorized users in a variety of ways:

Security application lets you:



- Mask or hide entries you have defined as private. The Mask option displays a gray bar over private records, and the Hide option completely removes (hides) private records.
- Assign a password to viewing options to enhance security. Assigning a password requires you to enter a password before private entries can be viewed; not assigning a password lets you view private entries when you Show Records from the Security dialog box.
- Lock and turn off your handheld so that a password must be entered before you can use your handheld again.
- Hide records that you have defined as private, with or without a password. Without a password, private records are hidden until you set Security to display them; with a password, you must enter the password to view the private entries.



Masking and hiding records

You can mask or hide private records. When you mask private records, a visual placeholder appears where the record would normally be displayed; when you hide records, they are not visible anywhere in the list.



Masking private records

1. **Make sure that the record or records you want to mask are defined as private. To make a record private, select the record, tap Edit, tap Details, and then check the Private box.**
2. **Press the Home button .**
3. **Select the Utilities category .**
4. **Select Security .**
5. **From the Current Privacy pick list, select Mask Records.**



6. **Open one of the Organizer applications and view a record. Records marked as private are masked with a gray bar.**

Hiding private records

1. **Make sure that the record or records you want to hide are defined as private. To make a record private, select the record, tap Edit, tap Details, and then check the Private box.**
2. **Press the Home button .**
3. **Select the Utilities category .**



4. Select Security .
5. From the Current Privacy pick list, select Hide Records.



6. When you return to the Organizer applications, records marked as private are not included in the display.

Note that you can mask or hide records without assigning a password, or you can assign a password if you want records to remain masked or hidden until a password is entered.

Assigning and editing passwords

You can assign a password to protect your private records and to lock your handheld.

Once you define a password, you can change or delete it at any time. You must enter the current password before you can change or delete it.

If you've forgotten your password, you can delete it, see [page 150](#).

1. Press the Home button .
2. Select the Utilities category .
3. Select Security .
4. Tap the Password box.



Password

Enter a password:
|.....

Hint:
.....

If you assign a password, you must enter it to show private records.

OK Cancel

5. Enter a password—either the one you want to assign or your current password if you want to change or delete it—and tap **OK**
6. Choose from the following options:
 - To assign a password, enter the password again to verify it, and tap **OK**.
 - To change your password, enter a new password and tap **OK**.
 - To delete your password, enter your current password. Tap **OK**, and then tap **Unassign**.

Locking your handheld

You can turn off and lock your handheld with a password to protect information. You must then enter the password when you turn on your handheld to gain access to the information on it.

If you forget the password, you must perform a hard reset to resume using your handheld. Performing a hard reset deletes all the records in your handheld; however, you can restore all synchronized data at the next HotSync operation. See [page 171](#) for more information.

1. Assign a password, as described on [page 148](#).

A password is required before using the Turn Off & Lock option.

2. Tap **Lock & Turn Off**. The **System Lockout** dialog box appears.

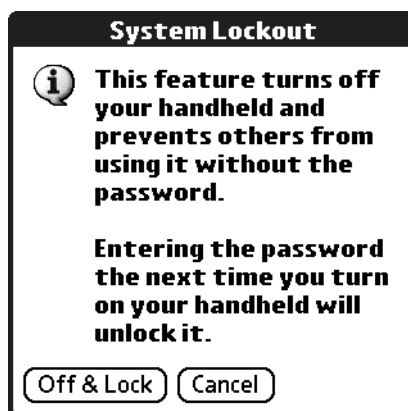

3. Tap **Off & Lock**. Your handheld turns off and locks.

Turning on and unlocking your handheld



1. Turn on your handheld.
2. Enter your password at the prompt, and then tap **OK**.

Recovering from a forgotten password

If the **Off & Lock** option is not active, and you forget your password, you can delete the forgotten password from your handheld. Deleting a forgotten password also deletes all entries and files marked as **Private**.

IMPORTANT: If you synchronize with your computer before deleting a forgotten password, your handheld restores private entries the next time you perform a HotSync operation, but does not restore the forgotten password.

Deleting a forgotten password

1. Press the Home button .
2. Select the Utilities category .
3. Select Security .
4. Tap the password box.
5. Tap **Lost Password**.
6. A message appears; tap **Yes** to delete the forgotten password.

Using the Attention Manager

Many applications (such as Date Book and Clock) want to get your attention with some sort of alarm. Attention Manager provides a way for you to conveniently manage all of these notifications in one place. Appointments and messages can stack up while you are away from your handheld. You can then use Attention Manager to view them from a single list and selectively dismiss or follow up on each alarm.

Alarms request your attention at two different levels: insistent and subtle. This chapter describes both types of requests.

Insistent alarms

Insistent applications open a Reminders dialog screen, and may play a sound, flash an LED, or vibrate, depending on your hardware configuration. Alarms continue until you snooze or dismiss them. If the sound can be interrupted, you can tap anywhere on the screen, or push any button to silence it. Attention Manager opens immediately when new insistent alarms are posted.

Using the Reminder dialog screen

The Reminder dialog screen has three buttons for responding to an alarm:

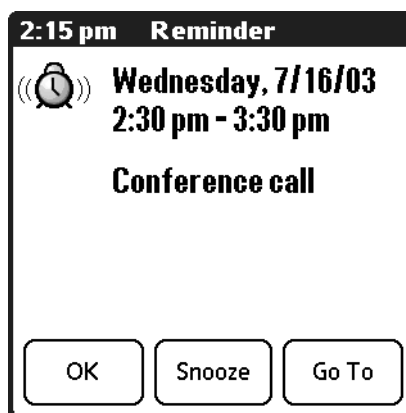

- **OK:** Makes the reminder go away, with no further notification.



- **Snooze:** Switches to the application that was running when the alarm went off, and returns to the Reminder dialog screen after five minutes. You can go back to the Reminder dialog screen right away by tapping the blinking indicator in the upper left corner of the screen. For more information on the blinking indicator, see [page 154](#).
- **Go To:** Switches to the application that created the alarm, and shows the record that caused the alarm, although you may have to navigate within the application. There is no further notification.

Setting alarm sound effects

Some applications allow you to set the tune or sound effect to use, and how many times to play it, with a pause in between. For example, to set alarm preferences for Date Book, do the following:

1. In **Date Book**, tap the **Menu icon** .
2. From the **Options menu**, select **Preferences**.

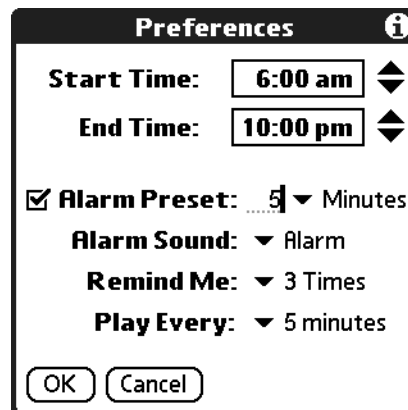

3. Check the **Alarm Preset** box, if you want alarms to sound, then select the following from the pick lists:

- **Alarm Preset.** Indicate how soon you want the alarm to sound before the event.
- **Alarm Sound.** Choose the alarm tune or sound effect (for example, Bird or Concerto).
- **Remind Me.** Specify how many times the alarm repeats before it stops.
- **Play Every.** Set the pause between each time the alarm sounds.

For information on setting the alarm volume level and vibrate option, see [page 134](#).



Using the Reminders list screen

The Reminders dialog screen changes to a list of items that require your attention under two insistent alarm conditions:

- When a second application attempts to get your attention and the first has not been dismissed or snoozed.
- When a first application makes a second attempt and the first has not been dismissed or snoozed.

Each reminder lists the date and time of the alarm. Depending on the application displaying the reminder, you may see an icon representing the application, and up to two lines of text.

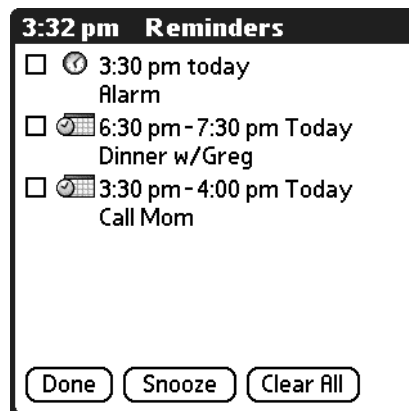

Tapping the text or icon jumps to that item and deletes the event from the Reminders list screen.

Checking a box clears that item, similar to a To Do list item. The Attention Manager draws a line through the text lines, pause for a moment, and then remove the item from the list, although the original data remains in the application.

The Reminders list screen displays three buttons that you can use to respond to the items in the list:

- **Done:** If the Reminders list appeared because of more than one insistent alarm, tapping Done closes the Reminders list screen, although the events remain in the application that created them. The Reminders list screen does not appear again, unless you tap the blinking alarm indicator in the menu bar.



If the Reminders list appeared after you tapped the Snooze button, then tapped the blinking alarm indicator, then tapped the Done button, the reminder continues to snooze.

For more detail, see the next section.

- **Snooze:** Put the Reminders list screen to sleep for five minutes. After this time interval, the Reminders list screen appears again. You can go directly to the Reminders list screen without waiting, by tapping the blinking alarm indicator. For more detail about the blinking indicator, see [page 154](#).
- **Clear All.** Remove all of the items from the list, but does not close the Reminders screen. Tap this button to erase a list of events that have passed.

Subtle alarms

Some applications provide a visual, and optionally audible indication, but do not otherwise disrupt your work flow. Subtle alarms do not display a Reminders screen. Instead, a blinking indicator flashes (in applications that support it) when an alarm is present.

Understanding the blinking alarm indicator

In applications that allow it, a blinking alarm indicator appears in the Status Bar under the following conditions:



- While viewing a Reminders dialog screen, you tap the Done or the Snooze button.
- A subtle alarm is present.

The indicator appears in two different states:

- **Off.** The indicator is not shown at all when the list is empty.
- **Blinking.** When there is an item in the list, then the “exclamation point” indicator blinks on and off until you empty the list.

Tapping the indicator opens the Attention Manager in list mode, even if there is only one item.



Using Expansion Cards

Zodiac lets you add expansion cards to your handheld. Use expansion cards to:

- Expand your handheld's storage capacity
- Share files with other people
- Backup your data

IMPORTANT: On your handheld, expansion slot 1 (left) is compatible with Secure Digital (SD) and MultiMedia (MMC) expansion cards. Expansion slot 2 (right) also supports SDIO expansion cards. Remember to use slot 2 for SDIO cards.

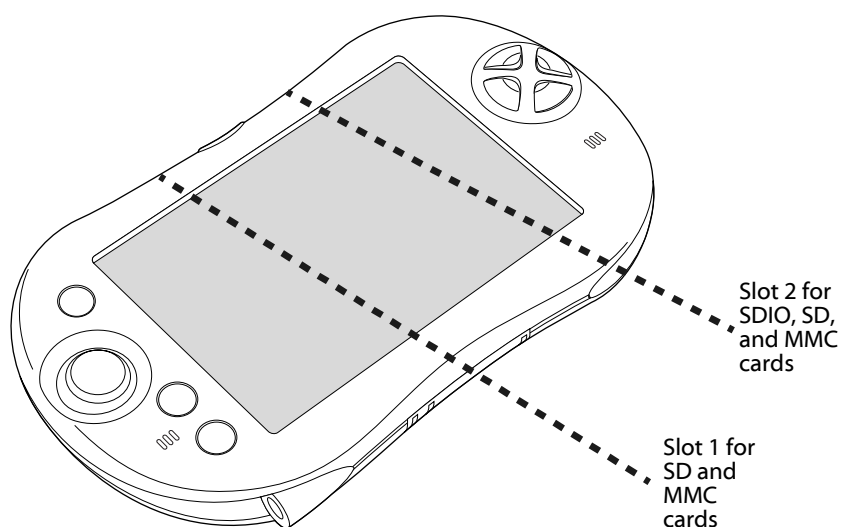



Inserting and removing an expansion card

1. Hold the expansion card with the label facing you and the notch in the lower-left corner.
2. Hold your handheld with the screen facing you.
3. Slide the expansion card into the slot until you feel it click into place.

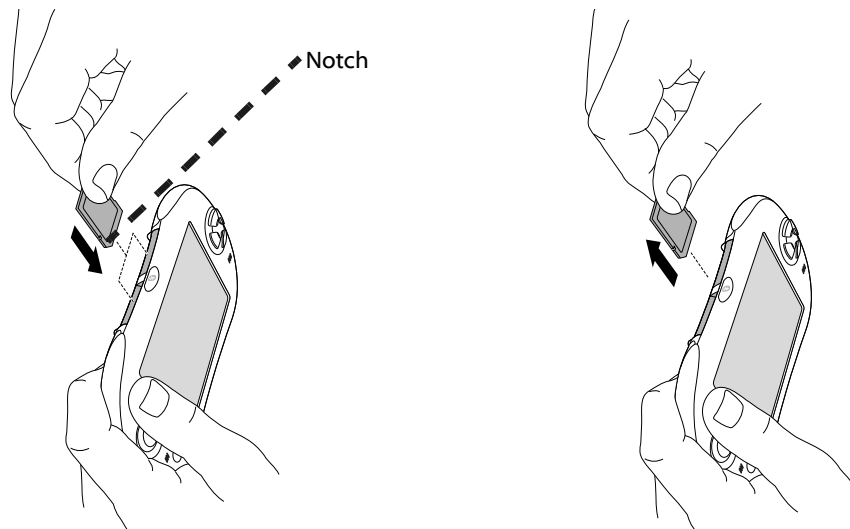

4. When you're done using the card, gently press the top of the card to release it from the slot and lift it out of the slot.

Accessing applications on an expansion card

When an expansion card is inserted, the card automatically appears as a new Home category. This category is assigned the name of the expansion card volume; for example, the name "Card 1" is used throughout this section.

1. **Insert an expansion card into an expansion slot.**

NOTE: If the Home screen does not appear, press the Home button  and select the card name, such as Card 1.



Using Expansion Cards

Displaying information about applications on an expansion card



The applications on the card appear on the Home screen.

2. Select the application that you want to launch.

The selected application is loaded into memory and launched. If the application is already resident in main memory, it is not copied again, just launched.

Displaying information about applications on an expansion card

1. Insert an expansion card into an expansion slot.
2. Press the Home button .
3. Select the card name, such as Card 1.
4. Tap the card name in the title bar to open the menus.
5. From the App menu, select Info.
6. From the Device pick list, select the card name. The screen displays the size of the applications on the card.

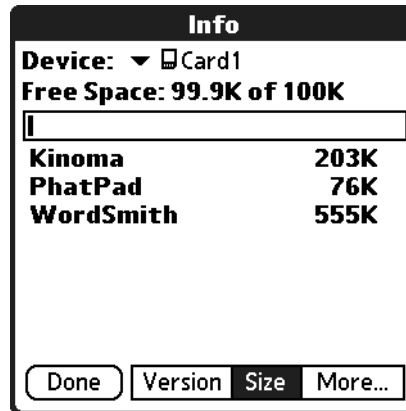

7. To display the application version, tap **Version**.

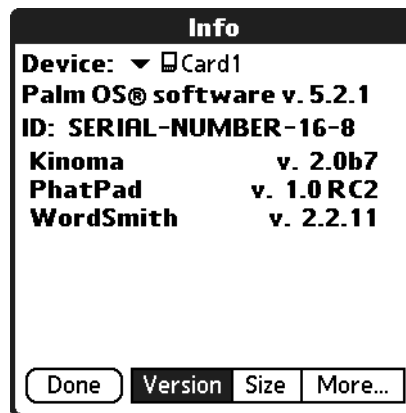

TIP: When you tap More, you access the CardInfo application, described in the section that begins on [page 161](#).

Copying an application from an expansion card

You can copy applications from an expansion card to any of the following:

- Another expansion cards
- Your handheld
- Your desktop software



Using Expansion Cards

Beaming or sending applications from an expansion card

1. Insert an expansion card into an expansion slot.
2. Press the Home button .
3. Select the card name, such as Card 1.
4. Tap the card name in the title bar to open the menus.
5. From the App menu, select Copy.

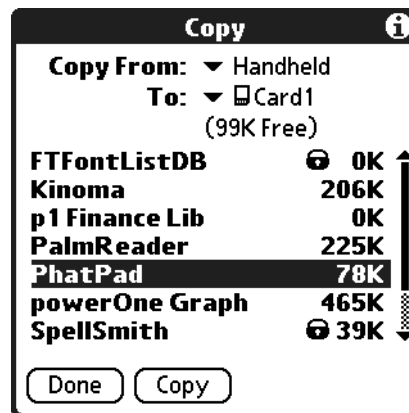

6. From the Copy From and To pick lists, select the source and the destination.
7. Select the application and then tap Copy.
The application is copied to the selected destination.

TIP: Some applications and databases are copy-protected and cannot be copied. These are listed with a lock icon next to them.

Beaming or sending applications from an expansion card

1. Insert an expansion card into an expansion slot.
2. Press the Home button .
3. Select the card name, such as Card 1.
4. Tap the card name in the title bar to open the menus.
5. From the App menu, select Beam or select Send.

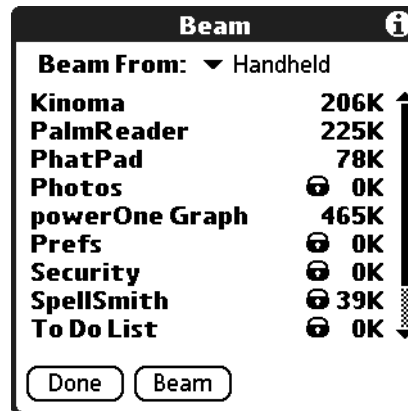

6. From the Beam From (or Send From) pick list, select the card name.
7. Select the application you want to beam or send, then tap Beam or tap Send.

The application is beamed or sent to the other handheld.

TIP: Some applications and databases are copy-protected and cannot be beamed. These appear with a lock icon next to them.

Deleting applications from an expansion card

1. Insert an expansion card into an expansion slot.
2. Press the Home button .
3. Select the card name, such as Card 1.
4. Tap your user name in the title bar to open the menus.
5. From the App menu, select Delete.





6. From the Delete From pick list, select the card name, such as Card 1.

7. Highlight the application you want to delete, then tap Done.

The application is deleted. Applications that are loaded in ROM (for example, Memo Pad) cannot be deleted, and are not listed.

Using CardInfo

The CardInfo application displays summary information for each known directory type found on an expansion card.

1. Insert an expansion card into an expansion slot.

2. If the Home screen does not appear, press the Home button .

3. Select the Utilities category .

4. Select the CardInfo icon .

5. From the Card pick list, select the card name, such as Card 1.

The CardInfo screen displays information about the expansion card seated in the expansion slot.

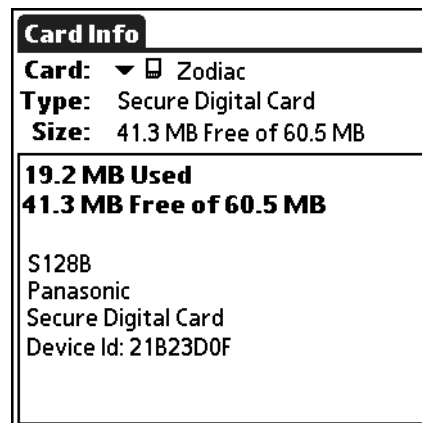



Renaming an expansion card

1. Open Card Info.
2. Tap the Menu icon .
3. From the Card menu, select Rename Card.

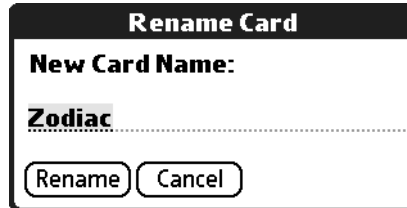

4. Enter the new name in the Rename Card dialog box.
5. Tap Rename.

Reformatting an expansion card

1. Open Card Info.
2. Tap the Menu icon .
3. From the Card menu, select Format Card.



4. Tap OK.

IMPORTANT: Reformatting an expansion card erases all of its data.



Beaming and Sending Information

Your Zodiac handheld is equipped with an IR (infrared) port that you can use to beam information to another Palm OS device that's close by and also has an IR port. The IR port is located at the top of the handheld, behind the small dark shield.

Your handheld is also equipped with a Bluetooth radio. If you are within range of other devices that are enabled with Bluetooth technology, you can use Bluetooth communication to send them information. The Bluetooth button  is located on the top of your handheld.

Additionally, if you install the optional SMS software from the CD that came with your handheld and you have a compatible mobile phone, you can use SMS technology to send information as well.

You can beam or send the following information between Palm Powered handhelds and other compatible devices:

- The record currently displayed in Photos, Date Book, Address Book, To Do List, or Memo Pad.
- All records of the category currently displayed in the Photos, Address Book, To Do List, or Memo Pad applications.
- A special Address Book record that you designate as your business card, containing information you want to exchange with business contacts.
- An application installed in your handheld's internal memory or on an expansion card seated in one of expansion slots.

NOTE: To prevent music piracy, you cannot beam or send songs from the Music application.



For best results while beaming, Zodiac handhelds should be within one foot of each other, and the path between the two handhelds must be clear of obstacles. Beaming distance to other Palm OS devices may be different.

TIP: You can also perform HotSync operations using the IR port. See [page 141](#) for more information.

Creating a business card

1. In the **Address List**, create a new entry or select an entry that contains the information you want on your business card. See [page 79](#) for more information.
2. In **Address view**, tap the **Menu icon** .
3. From the **Record menu**, select **Select Business Card**.
4. At the prompt, tap **Yes**.

Beaming a record

1. Locate the record, business card, or category you want to beam.
2. Tap the **Menu icon** .
3. From the **Record menu**, select the appropriate command:
 - **Beam.** Beams an individual item.
 - **Beam Business Card.** Beams the record defined as your business card. In Address Book only.
 - **Beam Category.** Beams all records assigned to the selected category.

TIP: You can use the Graffiti 2 Command stroke /B to beam the current entry.

4. When the **Beam Status dialog box** appears, point the IR port directly at the IR port of the receiving handheld.

When the **Beam Status dialog box** indicates that the transfer is complete, you can resume working on your handheld.

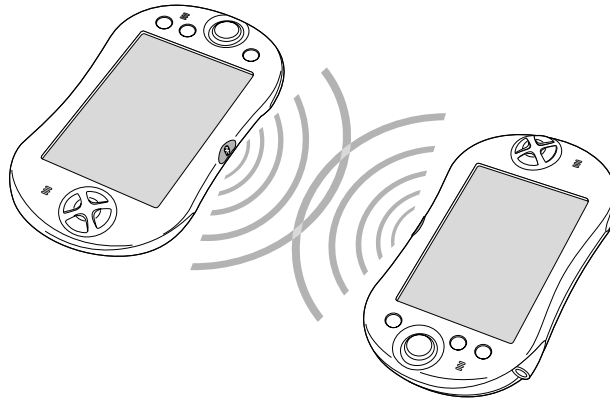

Beaming an application

1. Press the Home button .
2. Tap the left side of the title bar to access the menus.
3. From the App menu, select Beam.
4. Select the application you want to transfer, and tap Beam.

NOTE: Some applications are copy-protected and cannot be beamed, as indicated by a lock icon.

5. When the Beam Status dialog box appears, point the IR port directly at the IR port of the receiving handheld.

When the Beam Status dialog box indicates that the transfer is complete, you can resume working on your handheld.

Receiving beamed information



To receive beamed information the Beam Receive option in General Preferences must be turned on. See [page 123](#) for details.

1. Turn on your handheld.
2. Point the IR port directly at the IR port of the transmitting handheld to open the Beam Status dialog box.
3. Tap Yes.



4. Wait for the Beam Status dialog box to indicate that the transfer is complete, and then tap OK to display the new entry.
5. Incoming records are placed in the Unfiled category.

Sending information with Bluetooth communication

1. If the Bluetooth radio is off, press the Bluetooth button  to turn it on. The blue LED turns on or flashes when the radio is on.
2. Display the desired Date Book, Address Book, To Do List, or Memo Pad record you want to send.
3. Tap the Menu icon .
4. From the Record menu, select the Send command. The command names vary based on the application (Event, Address, Category, Item, etc.).
5. Wait for the Discovery Results screen to appear.

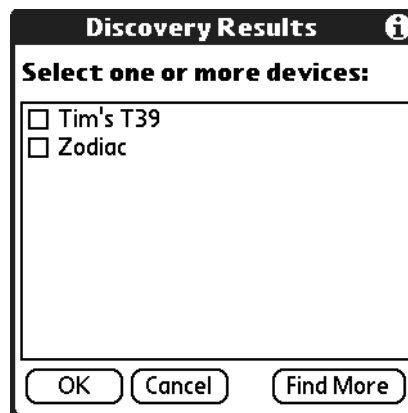

6. Select the recipient's user name from the list. If the name does not appear in the list, and the device is within range, tap Find More.
7. Tap OK.



Maintaining Your Handheld

Upgrade information

If you already own a Palm OS handheld, Tapwave recommends that you install the version of Palm Desktop software that comes with your new Zodiac handheld into the same folder as your current Palm Desktop software. All of your data is preserved when you install the new version in the same folder as the previous version. If you use another desktop organizer application, such as Microsoft Outlook, you still must install the most recent HotSync Manager and conduit software for your desktop organizer from the Palm Desktop software CD that came with your new handheld.

You can perform HotSync operations on your new handheld in exactly the same way as you did on your old handheld, allowing you to quickly synchronize your existing data with your new handheld. Just remember to synchronize your old handheld with Palm Desktop software before you synchronize with your new handheld, so you have the latest information. When you synchronize your new handheld for the first time, select the Desktop Overwrites Handheld option for all the conduits. For more information on conduit settings, see [page 139](#).

NOTE: If you used security features (for example, password protection) on your previous Palm OS handheld, you must upgrade to the most current desktop. The method of storing passwords has changed with the latest release of the desktop. Therefore, you must upgrade to synchronize your password-protected information.



Upgrading your Palm Desktop software

To upgrade your handheld, follow the steps below:

- 1. Synchronize your old handheld with your old Palm Desktop software to ensure that the latest information from your handheld is on your desktop computer.**
- 2. (Optional) To prevent data loss, go to the folder that stores Palm Desktop software, copy the folder and its contents, rename it (for example, Palm Backup), and store the copy outside the Palm Desktop software folder.**
- 3. Follow the installation instructions on [page 13](#), and make sure you install the new software in the same folder as the old software.**
- 4. To prepare for the first HotSync operation with your new handheld and new Palm Desktop software, go to HotSync Manager and choose Custom.**

NOTE: Select your user name, if it does not already appear in the box.

- 5. For all conduits, click Change, and select the Desktop overwrites handheld option. Then click Done. See [page 139](#) for more information.**
- 6. Connect your new handheld to the cable or cradle and press the HotSync button. If the Select User dialog box appears, select your user name.**

NOTE: If you customized the modem setup on your old handheld, you must re-enter the modem initialization string. Any passwords you select on your old handheld are not restored during this HotSync operation. Records you previously marked Private remain marked Private, but you need to reenter a password on your new handheld.

- 7. Perform a soft reset after completing the upgrade process (see [page 170](#)).**

Maintaining a unique name for each handheld

After you complete the upgrade process described in the previous section, you have two handhelds with the same name. However, to prevent complications and unexpected results during HotSync operations, each handheld must have a unique name. Therefore, we strongly recommend that you perform a hard reset on your old handheld as discussed in the next section.



Caring for your Zodiac

Your Zodiac is a delicate portable electronic device and it should be handled with the same care you give to other delicate devices such as a digital camera, cell phone, etc. Please observe the following recommendations:

- If your handheld's case gets a little soiled, clean it with a damp cloth. Do *not* wash or submerge your handheld in any liquid.
- Do *not* subject your handheld to unnecessary environmental stresses, including:
 - Dropping your handheld
 - Stepping on your handheld
 - Sitting on your handheld
 - Getting your handheld wet
 - Using your handheld in sand storms
 - Operating your handheld in extremely cold or hot temperatures
- As with any other electronic device, try not to subject your handheld to unnecessary static electricity. Static electricity in any electronic device can prematurely destroy that device. Your handheld is designed to tolerate a given amount of static electricity. Here are some suggestions to minimize damage from static electricity:
 - Before you pick up your handheld, discharge yourself of static charges by touching any large surface (preferably metal).
 - If you are using the optional cradle, discharge yourself of static charges by touching any large surface (preferably metal) prior to placing your handheld in the cradle. This is especially important in very dry environments where static charges can easily accumulate.



Frequently Asked Questions

Resetting your handheld

You may have to perform a reset if your handheld no longer responds to the buttons on the screen.

Performing a soft reset

A soft reset allows your handheld to get a fresh start, similar to rebooting a PC. All records and entries are retained after a soft reset.

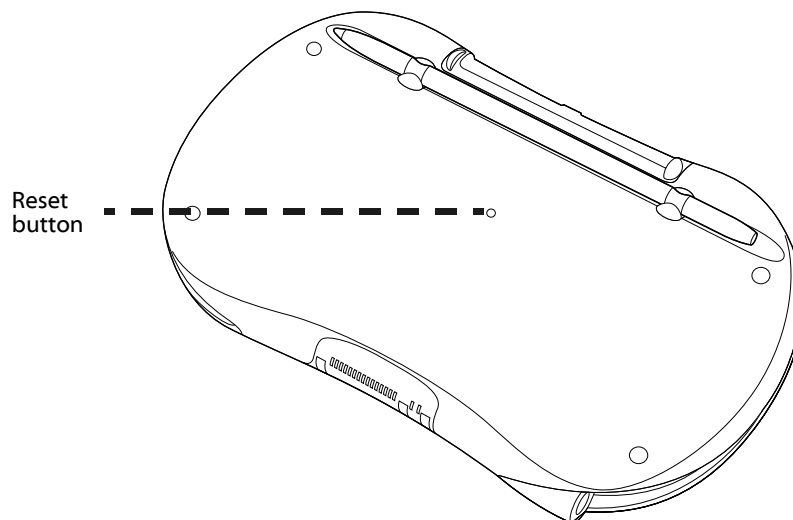

To perform a soft reset, use the tip of your stylus (or another object *without* a sharp tip such as an unfolded paper clip) to lightly press the reset button inside the hole on the back panel of your handheld.





Performing a hard reset

A hard reset erases all records and entries stored in your handheld. Never perform a hard reset unless a soft reset does not correct your problem. When you perform your next HotSync operation, you can restore any data that you previously synchronized to your computer. To perform a hard reset, do the following:

1. **Hold down the power button  on the front of your handheld.**
2. **While holding down the power button , use the tip of your stylus to gently press and release the reset button.**
3. **Release the power button.**
4. **When a message appears on the handheld screen warning that all data stored on the handheld is about to be erased, do one of the following:**
 - Complete the hard reset by pressing the Function button on the front panel of the handheld. The Digitizer screen appears.
 - Press the Home button  to perform a soft reset.

NOTE: When you perform a hard reset, the current date and time are retained. Formats, Preferences, and other settings are restored to their factory default settings.

Installing add-on software

Make sure the file you are trying to install is not a compressed file, such as a ZIP or SIT file. If the application is compressed, you must decompress the before installing it.

Troubleshooting TCP/IP connections

If you have problems connecting to a network using TCP/IP, you can display information to troubleshoot the problem. You can display expanded Service Connection Progress messages. You can also display the Network Log to see all communication between your modem and dial-in server during login. This information can help your ISP or your System Administrator identify where and why the login communication fails.



In addition, check with your system administrator whether a DNS number is required. If a number is required but not entered, the connection may fail. If a DNS number is required but not entered, logging on to your network may appear successful. However, the connection fails if you try to use an application or look up information. See [page 127](#) for information on entering a DNS number.

Viewing progress messages during login

- 1. In the Network Preferences screen, tap Connect. See [page 131](#) for more information on connecting to your ISP or dial-in service.**
- 2. To see expanded Service Connection Progress messages, move the analog controller  Down during login.**

Viewing the Network Log

- 1. In the Network Preferences screen, tap the Menu icon .**
- 2. From the Options menu, select View Log.**
- 3. Tap the Up and Down arrows of the scroll bar to see the entire Network Log.**
- 4. Tap Done.**

For additional troubleshooting information, and answers to frequently asked questions, visit tapwave.com.

Regulatory Information

Federal Communication Commission Interference Statement

This equipment has been tested and found to comply with the limits for a Class B digital device, pursuant to Part 15 of the FCC Rules. These limits are designed to provide reasonable protection against harmful interference in a residential installation. This equipment generates, uses and can radiate radio frequency energy and, if not installed and used in accordance with the instructions, may cause harmful interference to radio communications. However, there is no guarantee that interference will not occur in a particular installation. If this equipment does cause harmful interference to radio or television reception, which can be determined by turning the equipment off and on, the user is encouraged to try to correct the interference by one of the following measures:

- Reorient or relocate the receiving antenna.
- Increase the separation between the equipment and receiver.
- Connect the equipment into an outlet on a circuit different from that to which the receiver is connected.
- Consult the dealer or an experienced radio/TV technician for help.

This device complies with Part 15 of the FCC Rules. Operation is subject to the following two conditions: (1) This device may not cause harmful interference, and (2) this device must accept any interference received, including interference that may cause undesired operation.

FCC Caution: Any changes or modifications not expressly approved by the party responsible for compliance could void the user's authority to operate this equipment.

Important Note: FCC Radiation Exposure Statement

This equipment complies with FCC radiation exposure limits set forth for an uncontrolled environment. End users must follow the specific operating instructions for satisfying RF exposure compliance.

This transmitter must not be co-located or operating in conjunction with any other antenna or transmitter.

Index

Numerics

24-hour clock 122

A

accented characters 35

access restrictions 146

accounts 16

Acid Solitaire 59

Action buttons 18

activities 85

adding

 categories 44, 69

 expansion cards 155

add-on applications 47, 48, 171

Address Book

See also Organizer applications

 adding custom fields 83

 adding entries to events from 90

 adding notes 75

 categorizing records for 67

 creating records for 64, 79–80

 default categories for 68

 deleting records from 67

 duplicating entries for 81

 editing categories for 69

 editing entries 81, 82

 finding records 70

 opening 78

 overview 78, 79

 setting preferences for 83

 sorting records in 73, 83

 viewing entries 81

Address Entry Details dialog 82

Address icon 78

Address List view 81, 82

addressing e-mail 81

adjusting

 screen orientation 21

 volume 21, 51, 134

Agenda view 99

Agenda view icon 99

alarm clock 61

Alarm icon 93

Alarm Preset check box 152

Alarm Vibrate setting 134

alarms

 accessing 62

 adjusting volume for 62, 134

 delaying 94

 responding to 151

 selecting sounds for 62, 95, 152

 setting 93

 specifying duration for 95

 specifying preferences for 95

 specifying repeat intervals for 152

 types described 151, 154

alerts 24

See also alarms; reminders

All Day button 88

All view list 22

alphabet 33

alphabetic keyboard 37

alternate writing strokes 124

analog clock 62

analog controller 15, 18

 calibrating 118

application buttons 26

applications

See also Organizer applications

 adding add-on 47, 171

 beaming 159, 165

 common tasks for 64

 connecting to 132

 copying 16, 158

 creating categories for 43, 44

 default categories for 68

 deleting 48, 160

 displaying information about 157

 documentation for 10

 getting information on 46

 importing from 39

 installing 139

 launching from expansion cards 156

 locating text in 71, 72

 managing 41

 navigating through 27

 opening 22, 23, 42

 shortcuts for 46

organizing 43
running 15
Applications Launcher. *See* Home screen
applying fonts 77
appointments 85, 96, 151
archives 67
arranging icons 43
Ascending setting 62
Attention icon 24
Attention Manager 151–154
audible alarms 154
Auto-off after setting 14, 123
Autotext features 36

B

back panel 19
Background preference 45
backgrounds 45
backing up data 155
backing up files 15
backing up shortcuts 139
Backspace stroke 33
battery 13–14
 extending life of 14, 53, 123
Beam command 159
Beam Receive setting 14, 123, 165
Beam Status dialog 164, 165
beaming
 applications 165
 from expansion cards 159
 individual records 164
 infrared communications and 141
 overview 163
 tips for 164
 turning off 123
blinking alarm indicator 154
blinking cursor 32
Bluetooth button 17, 117
Bluetooth radio
 playing multi-player games from 60
 sending information with 163, 166
 setting preferences 117
 turning on/off 14, 117
boilerplates. *See* shortcuts

Bonus Software applications 16, 47
Box control 26
brightness control 21, 24, 124
buddy lists 117
built-in applications 48
 See also Organizer applications
business cards 164
buttons
 application 26
 back panel 19
 Calculator 114
 front panel 17
 not responding 170

C

calculations
 displaying 115
 performing 113, 114
 storing in memory 114
Calculator 113–115
 buttons described 114
Calculator icon 113
calendar 96, 120, 121
 See also Date Book
calibrating touch-screen 15, 118
Calibration Preferences screen 118
call waiting 126
calling cards 126
capitalization 64
CardInfo application 161
categories
 assigning records to 67, 68
 assigning to addresses 82
 assigning To Do items to 112
 attaching notes to 103
 changing 69
 creating 44, 69
 default application 68
 deleting 45, 70
 displaying 68, 83
 organizing applications in 43
 renaming 44, 69
 selecting 41
 viewing most recent 83
Category command 43, 44, 45

Category View
 opening 43
 removing categories from 45, 70
 selecting categories in 22, 42

Change Repeat dialog box 91

Change Security dialog 74

changes, undoing 65

changing
 addresses 81
 categories 69
 date/time formats 61
 passwords 148, 149
 records 65
 scheduled events 89, 90, 91
 screen orientation 21
 shortcuts 133
 To Do priorities 110

character sets 25, 30

characters
 deleting 33
 drawing accented 35
 shortcuts for entering 36
 writing special 33, 34–35, 130

charging battery 13–14

chime tones 134

clock 120, 121, 122

Clock application 61–63

Clock icon 61

COM port 142

command toolbar 28

communications 118, 136, 141

company names 80, 83, 131

company phone lists 144

Compress Day View option 101

conduit (defined) 139

configurations 118, 132, 143
 multiple handsets 144

conflicting events 100

Connection Preferences screen 118–120

connection protocol 127

connection software 17

connections
 automatic 117
 external keyboards 39
 requirements for 11
 selecting configurations for 132
 selecting network 125
 setting device type for 119
 setting ISP 131
 setting preferences 118–120
 setting up HotSync 12
 setting up remote 124, 128
 terminating 131
 testing 132
 troubleshooting 171–172

conserving battery power 14, 53, 123

contact information 80, 131

contacts. *See* Address Book

continuous events
 changing 91
 defined 86
 scheduling 85, 91, 92

controller. *See* analog controller

Copy command 66, 159

Copy dialog box 159

copying
 applications 16, 158
 photos 57
 text 66

correcting interference 173

country information 122

CPUs 19, 38, 118, 144
 system requirements for 11

cradle 12, 123, 144, 169

creating
 business cards 164
 categories 44, 69
 login scripts 128
 memos 104
 records 64
 shortcuts 133
 song lists 51
 untimed events 90
 user profiles 144–145

current dates 62, 121

customizing
 handheld device 116
 Home screen 43
 HotSync Manager 139–140

Cut command 65

D

data

- backing up 155
- editing 36
- entering 26, 30, 39
 - shortcuts for 36, 133
- importing 39
- overwriting 139
- paging through 27
- preserving 15, 167
- restoring 171
- selecting all 66
- synchronizing 38, 136, 150
- transferring 163

databases 39, 139, 159, 160

Date & Time Preferences screen 120–122

Date Book

- See also* Organizer applications
- adding addresses to events from 90
- changing views 96, 100
- creating records for 64
- displaying conflicting events 100
- finding records in 70, 72
- opening 85
- overview 85
- purging records from 67
- removing repeating events 66
- rescheduling events for 90, 91
- scheduling events 86–90, 91
 - tips for 92
- setting alarms for 93, 95, 152
- setting preferences for 101

Date Book icon 85

date formats 61, 123

dates

- displaying current 62
- displaying photo 56
- selecting event 89, 92
- setting 61, 110, 121
- shortcuts for entering 36
- sorting on 111

day events 86

Day view 87

- setting display options for 100, 101

Daylight Saving option 122

defaults 68, 122, 171

Delete command 66, 160

Delete dialog box 49, 161

deleting

- applications 48, 160
- categories 45, 70
- characters 33
- events 153
- notes 76
- Palm Desktop software 49
- passwords 148, 149, 150
- pictures 57
- records 66, 67
- repeating events 66
- shortcuts 133
- songs 52
- text 65

desktop organizers 17, 38, 167

Desktop Overwrites Handheld option 167

desktop setup 13

desktop software. *See* Palm Desktop

Details dialog 120, 127

dialing mode 119

dialing preferences 119, 126

dialog boxes 29

dial-up connections 118, 119, 120, 131

digitizer 15

Discovery Results screen 166

Display Options command 100

Display Options dialog 101

displaying

- addresses 81
- applications 22
- appointments 96
- calculations 115
- categories 68, 83
- conflicting events 100
- current date 62
- Home screen 24
- international keyboard 38
- memos 105
- menus 43
- onscreen keyboard 37
- photos 55
- priorities 108, 112
- private records 74, 75, 82
- song lists 51

- tips 29
- videos 14
- DNS numbers 127, 128
- documentation 10
- Domain Naming System (DNS) 127
- downloading records 79
- drivers 132
- due dates 110, 112
- Duplicate Record command 81

E

- Edit Categories dialog 44, 45
- Edit Categories option 69
- edit line 65
- Edit menu 65
- edit mode 65
- editing 65, 81, 82, 133
 - See also* changing
- editing commands 36
- e-mail 81
- Enable infrared communication option 141
- Enable Quick Launch preference 46
- End Time setting 102
- entering data 26, 30, 39
 - shortcuts for 36
- entering passwords 74, 131
- escape characters 130
- events
 - adding addresses to 90
 - changing preferences for 101
 - creating untimed 90
 - deleting 153
 - displaying conflicting 100
 - displaying time bars for 101
 - entering descriptions for 87, 90
 - rescheduling 89, 90, 91
 - scheduling 86–90, 91
 - tips for 92
 - setting alarms for 93, 95
 - setting duration for 86, 87, 88
 - types described 85
- Expand/Collapse icon 24
- expansion cards
 - accessing applications on 156
 - adding 155

- beaming from 159
- copying from 158
- copying pictures to 57
- displaying information for 157, 161
- reformatting 162
- removing songs from 52
- renaming 162
- viewing songs on 51
- expansion slots 19
- extending battery life 14, 53, 123
- external keyboards 39

F

- FAQs 170
- file formats 39
- files
 - backing up 15
 - caution for copying 16
 - importing from 39
 - sharing 155
 - synchronizing 139
- Find dialog box 71
- Find icon 24
- finding records 70–72
- Font command 77
- fonts 77
- forgetting passwords 150
- Format Card command 162
- formats 39, 61
 - specifying default 122
- Formats Preferences screen 122–123
- formatting expansion cards 162
- freeing memory 48
- front panel 17
- Full-Screen mode 55
- Function button 18

G

- games
 - adjusting volume for 134
 - installing third-party 47
 - playing 59
- General Preferences screen 123–124
- gestures 36

Go to Date dialog box 89
Graffiti 2 area. *See* Input Area
Graffiti 2 demo 30
Graffiti 2 Help command 66
Graffiti 2 Help file 35
Graffiti 2 Preferences screen 124
Graffiti 2 ShortCuts 36
 backing up 139
Graffiti handwriting software 30–37
 editing commands for 36
 tips for 32
grouping applications 43

H

handheld screen. *See* touch-screen
handwriting software 30–37
 editing commands for 36
 tips for 32
hard resets 149, 171
Headphone Bass setting 134
headphones 14, 20
help 16, 29
Hide Records setting 148
hiding records 74, 147
High Score Service conduits 139
Hold command 53
Hold state 53
Home button 18, 24, 156
Home category 156
Home screen
 customizing 43
 displaying menus in 43
 managing applications from 41–43
 opening 24
 overview 22
 setting preferences for 45
horizontal orientation (screen) 21, 24
HotSync button 137
HotSync cables 12, 123
HotSync command 139
HotSync connector 19
HotSync Manager
 configuring for infrared devices 143
 customizing 139–140

desktop organizers and 17, 49
running 137, 138
HotSync operations
 creating user profiles for 144–145
 disabling chime tones for 134
 initializing 136
 IR ports and 141
 multiple devices and 168
 performing 38, 136–138, 141, 144
 setting defaults for 140
 setting options for 138–139
 setting up connections for 12
 upgrades and 167
HotSync technology 11, 136

I

icons 22, 43
 displaying alphabetical list of 45
idle 127
image files 54, 56
importing data 39
Info command 46, 157
Info dialog box 157
Info screen 46
infrared communications 136, 141
infrared devices 142, 143
Input Area 24, 25, 124
 entering data in 31
Input Area Position setting 124
insistent alarms 151, 153
Install conduits 139
Install Tool dialog 47, 48
installation
 applications 47, 139, 171
 caution for 173
 Palm Desktop 16, 167
 system requirements for 11
installer 16
interference 173
international keyboard 38
Internet
 connecting to 118, 127, 131
 creating login scripts for 128
 creating service templates for 125
IP addresses 127, 128

-
- IR port
 - beaming from 163, 164, 165
 - location of 19
 - performing HotSync operations with 136, 141–144
 - ISPs 118, 125, 131
 - creating login scripts for 128
 - J**
 - joystick. *See* analog controller
 - K**
 - keyboard
 - connecting to external 39
 - entering data from 25, 38
 - opening onscreen 37, 66
 - Keyboard command 66
 - keyboard shortcuts 28
 - L**
 - landscape orientation 21, 24
 - laptops 141, 144
 - launching applications 157
 - LED display 13
 - lines, selecting entire 65
 - locating records 70–72
 - Lock & Turn Off option 149
 - lock icons 159, 160, 165
 - locking handheld device 148, 149
 - Login Script dialog 128
 - login scripts 128–130
 - Look Up option 70
 - Lost Password setting 150
 - lowercase letters 31
 - M**
 - macros. *See* shortcuts
 - maintenance 169
 - Mask records setting 74, 147
 - mathematical calculator 113
 - Media category icon 54
 - meetings 85
 - Memo List 104, 105
 - Memo Pad 103–105
 - See also* Organizer applications
 - categorizing records for 67
 - creating records for 64
 - default categories for 68
 - deleting records from 67
 - editing categories for 69
 - finding records in 70, 72
 - manually arranging records in 73
 - reviewing entries in 105
 - setting preferences for 105
 - sorting records in 73
 - Memo Pad icon 103
 - memory 48, 67, 104
 - memory cards. *See* expansion cards
 - memos 103, 104, 105
 - sorting 105
 - menu bar 24
 - Menu command stroke 36
 - Menu icon 24
 - menus
 - arranging icons on 22, 43
 - choosing commands 27, 28
 - displaying 24, 43
 - messages 103, 151
 - Microsoft Outlook 17, 136
 - mobile phones 118, 163
 - modems 118, 119, 120
 - Month view 98
 - setting display options for 100, 101
 - Month view icon 98
 - moving
 - applications 43
 - icons 43
 - MP3 files. *See* Music application
 - MP3 player 50
 - multi-player games 60
 - multi-stroke characters 31
 - music, listening to 14
 - Music application
 - beaming from 163
 - creating song lists for 51
 - removing songs from 52
 - running 50–52
 - Music icon 50

Mute icon 21, 24
My Stuff category 61

N

naming
 categories 44, 69
 handheld device 168
 user profiles 145
navigating 23, 27
navigational controls 27
Navigator. *See* analog controller
Network Log 172
Network Preferences screen 124–131
networks
 connecting to 119, 125, 127
 setting login scripts for 128–130
 setting preferences for 124
 troubleshooting connections for 172
new lines 104
news readers 131
non-ASCII characters 130
note icon 76
notes 75, 76, 103
 See also Memo Pad
notifications 151
numbers
 entering 30, 31, 37
 formatting 123
 shortcuts for 36
 tips for writing 33
numeric keyboard 37

O

online help 16
onscreen keyboard 25, 37–38
 opening 66
Open to All Applications preference 45
opening
 Address Book 78
 applications 22, 23, 42
 shortcuts for 46
 Calculator 113
 Category View 43
 Clock application 61

Date Book 85
Home screen 24, 156
Info screen 46
Memo Pad 103
onscreen keyboard 37, 66
Photos application 54
Stroke Lookup screen 66
To Do List 106
options 45, 101, 138, 146
Organizer applications 38, 64, 75
 changing font styles for 77
organizing applications 43
orientation (screen) 21
Orientation icon 21, 24
outdated records 67
Outlook 17, 136
overlapping events 100
overwriting data 139
Owner Preferences screen 131

P

paging through data 27
Palm Desktop
 compatibility with 15
 importing from 39
 installing 11, 16, 167
 removing 49
 synchronizing with 136, 139
 upgrades and 167
Palm OS devices 163
Palm Powered handheld devices 163
passkeys 117
passwords
 entering 74, 131
 recovering 150
 saving 125
 setting 148, 149
 upgrades and 167
Paste command 66
PCs 19, 38, 118, 144
 system requirements for 11
pen. *See* stylus
personal information 80, 131
phone book. *See* Address Book
phone drivers 132

phone lists 144
Phone Lookup command 72
Phone Lookup option 71, 90, 104, 107
phone numbers. *See* telephone numbers
Phone Preferences screen 132
Photos application 54–58
 ordering pictures in 55
Photos icon 54
Pick list control 26
picture lists 55, 57
pictures
 copying 57
 deleting 57
 managing 54
 rotating 56
 viewing location of 56
PIM. *See* Organizer applications
Play/Pause button 51
playback 51
playing games 59
portrait orientation 21
ports 19, 136, 142
Power button 18
preferences 45, 116
Preferences command 45
Prefs category 116
preserving data 15, 167
printing 15
prioritizing To Do items 108, 110
Private check box 74
private records 74, 75, 110, 147
 caution for deleting passwords and 150
profiles 136, 144, 145
 naming 145
progress messages 172
punctuation marks 34
Purge command 67
purging records 67, 109

Q

Quick Launch 46
quick strokes 28

R

radial menu 22, 43
radiation exposure 173
radio. *See* Bluetooth radio
rearranging icons 43
reboots 149, 170, 171
receiving information 14
Recent Calculations command 115
recharging battery 13
Record Completion Date option 112
records
 assigning passwords to 148
 attaching notes 75
 beaming 164
 categorizing 67–68
 caution for deleting passwords and 150
 creating 64
 defined 64
 deleting 66
 displaying private 74, 75, 82
 downloading 79
 duplicating 81
 editing 65
 finding 70–72
 hiding 74, 147
 manually arranging 73
 marking as private 74, 110
 purging 67, 109
 receiving 166
 saving 67
 sorting 72–73
recovering passwords 150
recurring events. *See* repeating events
reminders
 creating 106
 responding to 151, 153
 setting alarms for 93, 95
 viewing 153
Reminders dialog box 151, 153
 closing temporarily 154
remote computers 118
remote connections 124, 128, 171
removing. *See* deleting
Rename Card command 162
Rename Custom Fields command 83

Rename Custom Fields dialog 84

renaming

- categories 44, 69
- expansion cards 162

Repeat button 51

Repeat check box 91

repeat intervals 92, 152

Repeating Event dialog 92

repeating events

- changing 91
- defined 86
- displaying 101
- removing 66
- scheduling 85, 91, 92

replacing stylus 23

replaying songs 50, 51

rescheduling events 89, 90, 91

Reset button 19, 170

resets 149, 170, 171

responding to alarms 151

responding to reminders 153

restoring data 171

restricting access 146

Rotate icon. *See* Orientation icon

rotating photos 56

S

Save Archive check box 67

Save Archive Copy on PC check box 67

saving

- passwords 125
- records 67

schedules 85, 100

scheduling events 86–90, 91

- tips for 92

screen

- adjusting brightness 21, 124
- adjusting orientation of 21
- calibrating 15, 118
- described 18
- enlarging 24
- navigating through 23
- replacing backgrounds for 45
- restrictions for 23

scroll bar slider 27

scrolling 27, 51, 70

Search icon. *See* Find icon

searches, halting 71

searching 24, 70, 72

security 74, 125, 131, 167

Security application 146–150

Security command 74, 75

security options 146

Select All command 66

Select Business Card command 164

Send command 159

sending information 163, 166

See also beaming

Service Connection Progress messages 131, 172

service templates 125, 127, 128

Set Time & Date command 61

Set Time dialog 87, 88, 89

setting

- alarms 93, 95
- passwords 148, 149
- preferences 45, 116

setup instructions 15

sharing files 155

Shift command 34, 35

Shift indicator arrow 34

Shift stroke 34, 35

ShortCut Preferences screen 133

ShortCut symbol 37

shortcuts 28, 29, 36

- backing up 139
- creating 133

Show Categories option 112

Show Completed Items option 109, 112

Show Daily Repeating Evts option 101

Show Due Dates option 110, 112

Show Only Due Items option 112

Show Priorities option 108, 112

Show Records option 75

Show Time Bars option 101

Show Timed Events option 101

Show Untimed Events option 101

Shuffle button 51, 55

silent alarms 93

Slide Duration pick list 56

slide shows 55, 56
slider arrows 27
SMS software 163
Snooze button 94, 152, 154
soft resets 170
song list
 creating 51
 removing songs from 52
 scrolling through 51
songs
 assigning to alarms 62
 deleting 52
 replaying 50, 51
 selecting 51
sorting
 addresses 83
 memos 105
 records 72–73
 To Do List items 111
Sound icon 21, 24
Sound Preferences screen 134–135
sound tracks 50
sounds
 disabling 134
 interrupting 151
 setting for alarms 62, 95, 152
speakers 14, 18, 21, 51
special characters 34–35, 130
spreadsheets 39
start dates (events) 92
Start Time setting 102
start times (events) 88, 101
starting Zodiac handheld 15
static electricity 169
Status Bar 24, 124
Stay on in Cradle setting 123
stopwatch 61, 62, 63
storage 155
storing songs 51
Stroke Lookup screen 30, 66
Stunt Car Extreme 59
stylus 19, 20, 23
 replacing 23
stylus channel 19
subtle alarms 154

symbols 30, 31, 34
synchronizing data 38, 136, 150
 See also HotSync operations
System conduits 139
System Lockout dialog 149, 150
system requirements 11
system sounds 134

T

tapping 23
Tapwave web site 139
tasks. *See* To Do List
TCP/IP settings 127, 131
TCP/IP software 125
telephone numbers
 See also Address Book
 adding to phone lists 144
 dialing 126
 entering 71, 131
 selecting 81
 temporarily storing 103
telephones
 selecting model 120
 setting modem connections for 119–120
 setting network connections for 126
templates. *See* shortcuts
testing connections 132
text
 editing 36
 entering 30, 31, 37, 107
 creating shortcuts for 133
 locating 71, 72
 replacing 72
 selecting 65, 66
 temporarily storing 103
third-party applications 47
thumbnails 55
time 61, 87, 121
 See also clock
time bars 101
time formats 61, 123
time zones 121
timed events
 changing to untimed 90
 defined 86

- displaying 101
- scheduling 85, 87, 89
- timeouts 127
- timer 61, 62, 63
- timestamps 37, 56
- Tips icon 29
- To Do Item Details dialog 110
- To Do List
 - See also* Organizer applications
 - categorizing records for 67
 - checking completed items 99, 109
 - creating items for 64, 107, 108
 - default categories for 68
 - displaying items 112
 - editing categories for 69
 - finding records in 70, 72
 - hiding items in 110
 - opening 106
 - overview 106
 - purging records from 67, 109
 - setting preferences 111–112
 - setting priorities 108, 110
 - sorting items 72, 111
- To Do List icon 106
- To Do Preferences dialog 112
- toolbar 28
 - See also* Status Bar
- touch-screen
 - adjusting brightness 21, 124
 - adjusting orientation of 21
 - calibrating 15, 118
 - described 18
 - enlarging 24
 - navigating through 23
 - replacing backgrounds for 45
 - restrictions for 23
- transferring data 163
 - See also* beaming
- travel setup 13
- Trigger buttons 17
- troubleshooting 170
- turning off handheld device 14, 18, 123
- turning on Zodiac handheld 18

U

- ultra-light setup 13
- unauthorized users 146
- Undo command 65
- Unfiled category 67, 166
- uninstalling desktop software 49
- unlocking handheld device 150
- untimed events
 - defined 86
 - displaying 101
 - scheduling 85, 89
 - setting silent alarms for 93
- upgrades 12, 167–168
- uppercase letters 31
- user accounts 16
- user names 16, 125, 131
- user profiles
 - creating 144–145
 - multiple handhelds and 136
 - selecting 145
- Users command 144
- Utilities category 161

V

- Version button 158
- vertical orientation (screen) 21
- vibrating alarms 134
- videos 14
- viewing
 - addresses 81
 - applications 22
 - appointments 96
 - calculations 115
 - categories 68
 - conflicting events 100
 - current date 62
 - Home screen 24
 - international keyboard 38
 - memos 105
 - menus 43
 - onscreen keyboard 37
 - photos 55
 - priorities 108, 112
 - private records 74, 75, 82
 - song lists 51

- tips 29
- videos 14
- visual alarms 154
- volume
 - adjusting 21, 51, 134
 - caution for 14, 20
 - setting alarm 62, 134
- volume control 24

W

- Web browsers 131
- web site (Tapwave) 139
- Week view 96–97
- Week view icon 96
- weekly events 85
- Welcome application 30
- Windows system requirements 11
- writing area. *See* Input Area
- writing strokes
 - demo for 30
 - enabling alternate 124
 - guidelines for 31
 - special characters and 34

- tips for 33

Z

- Zodiac handheld
 - adding expansion cards for 155
 - components described 17–19
 - configuring 118, 144
 - connecting to 125
 - customizing 116
 - deleting applications from 160
 - installing applications for 139
 - locking/unlocking 148, 149, 150
 - maintaining 169
 - overview 11
 - providing contact information for 80
 - resetting 149, 170, 171
 - running multiple 168
 - selecting user profiles for 145
 - setting idle timeout for 127
 - setting up 13, 15
 - starting 15
 - supported file formats for 39
 - turning off 14, 18, 123
 - upgrading 12, 167–168