

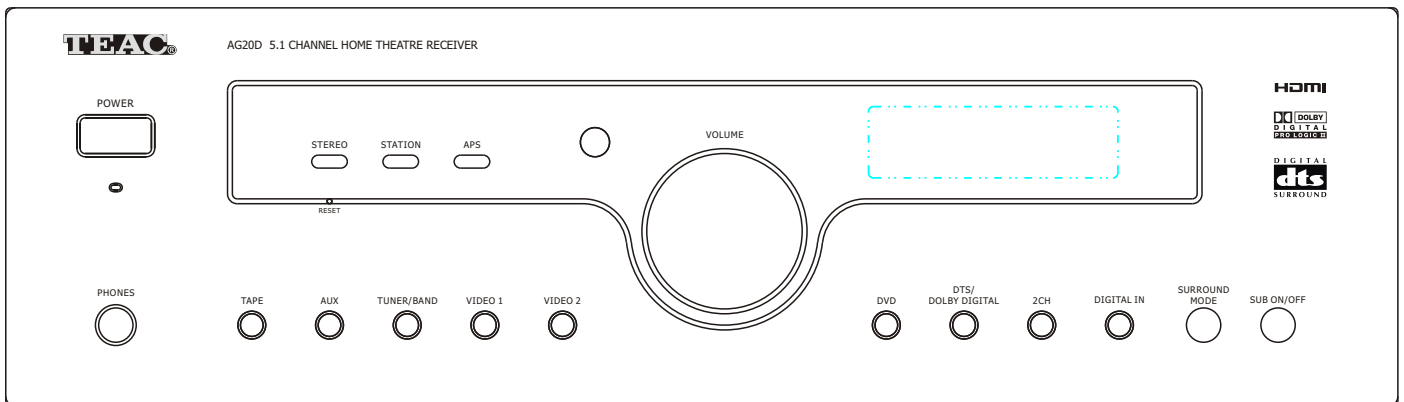

# TEAC AG20D

5.1 CHANNEL HOME THEATRE RECEIVER



## USER MANUAL

# IMPORTANT!

WARRANTY INFORMATION INSIDE. PLEASE READ

[WWW.teac.com.au](http://WWW.teac.com.au)

# TEAC WARRANTY REGISTRATION

Please read this warranty card.  
Keep your purchase receipt to enable you to proceed quickly in the event of a Warranty Service.

## Warranty Terms & Conditions

1. TEAC warrants to the original retail purchaser only, that this product is free from defects in material and workmanship under normal domestic use and authorises free service during the warranty period at any TEAC Authorised Service Centre only. TEAC warranty only applies to products purchased, used and serviced in Australia.
2. Subject to the terms herein, this warranty effectively covers the equipment as specified in the Warranty Periods Table below from the date of purchase.

TEAC PRODUCT	WARRANTY PERIOD
Plasma TV 106 cm and above	1 Year (In-Home Service Available)
LCD Televisions 59cm and above	1 Year (In-Home Service Available)
Televisions – 59cm and above	1 Year (In-Home Service Available)
All Televisions under 59 cm	1 Year (No In-Home Service)
Digital Set Top Boxes & Module	1 Year (No In-Home Service)
VCR	1 Year (No In-Home Service)
DVD & Module	1 Year (No In-Home Service)
DVD Recorder & PVR Module	1 Year (No In-Home Service)
Audio Systems	1 Year (No In-Home Service)

3. In home service will only be provided as part of this warranty if all the following conditions are met;
  - a) The product as indicated in the Warranty Period Table.
  - b) The product is within the warranty period.
  - c) The product is located within the normal service area of the local TEAC Authorised Service Centre.

In any other situation or circumstance, where an in home service call is made, a service fee will be charged by the Service Provider including a travel fee if outside normal service area.

If TEAC determines that the product is not repairable on site, TEAC can complete the repair by taking the product to a TEAC Authorised Service Centre.

Where in-home service is not available, the purchaser is required to send the product to the nearest TEAC Authorised Service Centre for repair. In this event, a copy of this warranty card and a copy of your receipt of purchase must be enclosed to be a valid warranty. Such equipment or part must be sent freight prepaid to your nearest TEAC Authorised Service Centre. After the repair, the product will be available for collection by or return to the purchaser at purchaser's cost. The warranty does not cover freight or insurance. In all cases of transit damage or lost, a claim must be filed against the carrier by the purchaser, even if shipment is arranged by TEAC. TEAC in-home service may also be available at a fee upon request.

4. Accessories, Remote, including power adaptors, AV box, TV tuners, etc, are warranted to be defect free for 1 year.
5. Replacement of spare parts under normal usage; except cabinet, front panel, knob, removable accessories, battery, consumable, AC cord, connecting cord and other accessories, are warranted as specified in Warranty Periods Table, and will be repaired or replaced at the sole judgement of TEAC.
6. The warranties hereby conferred do not extend to, and exclude, any cost associated with the installation, de-installation or re-installation of a product (be it in-home or otherwise), including costs related to the mounting, demounting or remounting of any screen, (and any other ancillary activities), delivery, handling, freighting, transportation or insurance of the product or any part thereof or replacement of and do not extend to, and exclude, any damage or loss occurring by reason of, during, associated with, or related to such installation, de-installation, re-installation or transit.
7. Normal customer maintenance as described in the owner's manual is not covered by this warranty (such as cleaning VCR heads etc.)
8. Service will be provided only during normal business hours and under safety conditions and circumstances.

9. This warranty does not apply to equipment showing abuse, damage or that it may have been tampered with, altered or repaired outside any TEAC Authorised Service Centre. If so, the warranty will be void.  
**\*Your nearest Authorised TEAC Service Centre is listed in your Owners Manual**
10. No one is authorised to assume any liability on behalf of TEAC or impose any obligation on it, in connection with the sale of any equipment other than as stated in this warranty and outlined above.
11. In no event will TEAC be responsible or liable for indirect or consequential damages from interrupted operations or other causes.
12. Warranty is not transferable to any subsequent purchaser if the product is sold during the warranty period,

*\* Extended promotional warranty may apply to certain products (for more info please contact: [service@teac.com.au](mailto:service@teac.com.au))  
In home service administration fee is applied after 1<sup>st</sup> year of warranty.*



## WARRANTY PROCEDURES

Please keep this information for your own records.

Please refer to the owner's manual to ensure that you have followed the correct installation and operating procedures.

1. Read owner's manual carefully
2. If you require Warranty Service, please contact the TEAC Authorised Service Centre
3. Please have your purchase receipt as your proof of purchase and the following details completed for a valid Warranty.

Owner's Name

---

Owner's Address

---

Postcode

---

Model Name/No.

---

Serial No.

---

Dealer's Name

---

Dealer's Address

---

Postcode

---

4. Please ensure that your product is packed appropriately upon return to the service centre.

If you have any other queries regarding service or warranty please contact the TEAC Customer Care Centre below:



[service@teac.com.au](mailto:service@teac.com.au)

[www.teac.com.au](http://www.teac.com.au)

1800 656 700



## CONTENTS

SAFETY INFORMATION.....	1
IMPORTANT SAFETY INSTRUCTIONS .....	2
BEFORE USE .....	4
CONNECTION .....	5
REMOTE CONTROL UNIT .....	10
FRONT PANEL INFORMATION .....	11
REAR PANEL INFORMATION .....	12
REMOTE CONTROL INFORMATION .....	13
BASIC OPERATION .....	15
SPEAKER CONFIGURATION, DELAY TIME & DYNAMIC RANGE CONTROL .....	17
TEST TONE, LFE TRIMMER & CHANNEL SELECT .....	18
AVAILABLE SURROUND MODE .....	19
TROUBLESHOOTING .....	20
SPECIFICATIONS .....	21
Complete Service Agent list.....	22

Thank you for purchasing our AV Receiver. This unit is precision engineered to provide you with years of trouble free service. Please read the following pages of the User's Manual to ensure correct operation of the unit.

Prepare to enjoy surround sound the way it should be!

## SAFETY INFORMATION

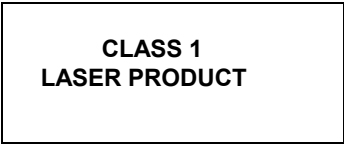
	<p><b>Caution:</b></p> <ul style="list-style-type: none"> <li>- To reduce the risk of electric shock, do not remove Cover (or back)</li> <li>- No user-serviceable parts inside.</li> <li>- Refer servicing to qualified service personnel.</li> <li>- Do not expose this appliance to rain or moisture</li> </ul>
	<p>This lightning flash with arrowhead symbol, within an equilateral triangle is intended to alert the user to the presence of uninstalled “dangerous voltage” within the product’s enclosure that may be of sufficient magnitude to constitute a risk of electric shock to persons.</p>
	<p>The exclamation point within an equilateral triangle is intended to alert the user to the presence of important operating and maintenance (servicing) instructions in the literature accompanying the appliance.</p>
	<p>The marking of products using lasers (except for some areas). The label is attached to the rear panel and says that the component uses beams that have been classified as Class 1, which means the unit is utilizing laser beams that are of weaker class. There is no danger of hazardous radiation outside the unit</p>

### ACCESSORIES

1. RCA cord (yellow color).
2. Remote control.
3. Battery AAA x 2 for Remote control
4. Instruction Manual.

## IMPORTANT SAFETY INSTRUCTIONS

### CAUTION: READ THIS BEFORE OPERATING YOUR UNIT.

1. **READ AND FOLLOW INSTRUCTIONS:** All the safety and operation instructions should be read before the product is operated. Follow all operation instructions within this manual.
2. **RETAIN THESE INSTRUCTIONS:** The safety and operation instructions should be retained for future reference.
3. **HEED WARNINGS:** Comply with all warnings on the product and in the operation instructions.
4. **CLEANING:** Unplug this product from the wall outlet before cleaning. Do not use liquid cleaners or aerosol cleaners. Use a damp cloth for cleaning.
5. **GROUNDING OR POLARIZATION:** This product may be equipped with a polarized alternating current line plug (a plug having one pin wider than the other). This plug will fit into the power outlet only one way. This is a safety feature. If you are unable to insert the plug fully into the outlet, try reversing the plug. If the plug should still fail to fit, contact your electrician since it is likely you have an out of safe wall socket. Never force the plug into the socket.

6. **OVERLOADING:** Do not overload wall outlets or extension cords as this can result in the risk of fire or electric shock. Overloaded AC outlets, extension cords, frayed power cables, damaged or cracked wire insulation, and broken plugs are dangerous. They may result in electric shock or fire hazard. Periodically examine the power cable - if its appearance indicates damage or deteriorated receptacles have it replaced by your service technician.

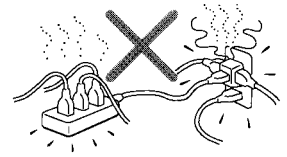

7. **POWER SOURCES:** This product should be operated only from the type of power source indicated on the rear panel label. If you are not sure of the type of power supply to your home, consult your product dealer or local power company. For products intend to be operated from battery power, or other sources, refer to the operation instructions.

8. **ACCESSORIES:** Do not place this product on an unstable surface or support. The product may fall, causing serious injury to a child or adult as well as serious damage to the product. Any mounting of the product should follow the manufacturer's instructions and use a mounting accessory recommended by the manufacturer. A product and cart combination should be moved with care. Quick stops, excessive force, and uneven surfaces may cause the product and cart combination to overturn.



9. **OUTDOOR ANTENNA GROUNDING:** If an outside antenna or cable system is connected to the product, be sure the antenna or cable system is grounded so as to provide some protection against voltage surges and built-up static charges. The example below is for reference only. Correct grounding should always be installed by an electrician.

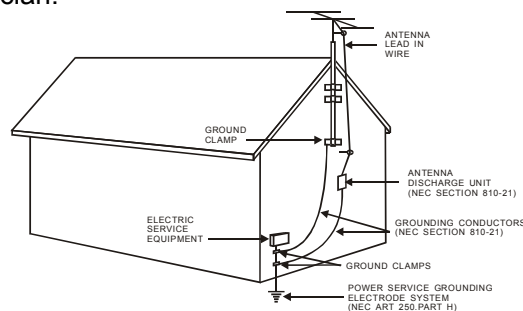





10. **POWER CABLE PROTECTION:** The power supply cables should be routed so that they are not likely to be walked on or pinched by items placed upon or against them, paying particular attention to cables at plugs and the point where they exit from the product.
11. **ATTACHMENTS:** Do not use unauthorized attachments as they may cause faults with the unit.
12. **CONDITIONS REQUIREING SERVICE:** Unplug this product from the wall outlet and refer servicing to qualified service personnel under the following conditions:
  - a) If the unit exhibits sudden unusual operation or unusual display characteristics.

## IMPORTANT SAFETY INSTRUCTIONS

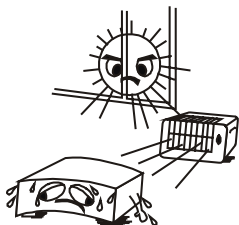
- b) If liquid has been spilled, or objects have fallen into the product.
  - c) If the product has been exposed to rain or water.
  - d) If the product does not operate normally by following the operation instructions, adjusting only those controls that are covered by the operation instructions. (**NOTE:** improper adjustment of other controls may result in damage and will often require extensive work by a qualified technician to restore the product to its normal operation).
  - e) If the product has been dropped or damaged in any way.
  - f) If the product exhibits a distinct change in performance.
13. **SERVICING:** Do not attempt to service this product yourself as opening or removing covers may expose you to dangerous voltage and may damage precision components. Refer all servicing to qualified service personnel.
14. **LIGHTNING:** For added protection during a lightning storm, or when the unit is left unattended and unused for long period of time, unplug it from the wall outlet and disconnect the antenna or cable system. This will prevent damage to the product due to lightning and power line surges.
15. **REPLACEMENT PARTS:** Should replacement parts be required, have the service technician verify that the replacement parts he uses have the same safety characteristics as the original parts. Use of unauthorized replacements parts can cause fire or electric shock.
16. **SAFETY CHECK:** Upon completion of any service or repairs to this product, ask the service technician to perform safety checks recommended by the manufacturer to determine that the product is in a safe operating condition.
17. **HEAT DISPERSAL:** Leave at least 10 cm of space between the top, back and sides of the unit and the wall or other electrical components.

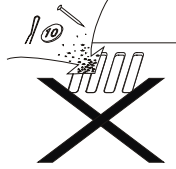
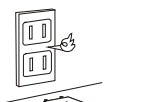
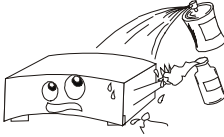
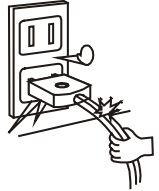
## 18. NOTES ON USE

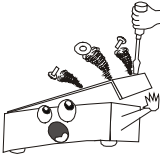
 <ul style="list-style-type: none"> <li>• Avoid high temperatures Allow for sufficient heat dispersion when installed on a rack.</li> </ul>	 <ul style="list-style-type: none"> <li>• Keep the set free from moisture, water, and dust.</li> </ul>	 <ul style="list-style-type: none"> <li>• Do not let foreign objects in the set.</li> </ul>
	 <ul style="list-style-type: none"> <li>• Unplug the power cord when not using the set for long periods of time</li> </ul>	 <ul style="list-style-type: none"> <li>• Do not let insecticides, benzene, and thinner come in contact with the set.</li> </ul>
 <ul style="list-style-type: none"> <li>• Handle the power cord carefully. Hold the plug when unplugging the cord.</li> </ul>	 <p>*(For sets with ventilation holes)</p> <ul style="list-style-type: none"> <li>• Do not obstruct the ventilation holes</li> </ul>	 <ul style="list-style-type: none"> <li>• Never disassemble or modify the set in any way.</li> </ul>



## BEFORE USE

### Read this before operation

1. Choose the installation location of your unit carefully. Avoid placing it in direct sunlight or close to a source of heat. Also avoid locations subject to vibrations and excessive dust, cold or moisture.
2. Do not cover the ventilation holes. Make sure there is enough space above and beside this unit (about 4 inches). Do not place a CD player or other equipment on top of this unit.
3. Do not open the cabinet as this might result in damage to the circuitry or electrical shock. If a foreign object falls into the unit, contact your dealer.
4. When removing the power plug from the wall outlet, always pull directly on the plug, never on the cord.
5. Do not attempt to clean the unit with chemical solvents as this might damage the finish. Use a clean, damp cloth only.
6. Keep this manual in a safe place for future reference.

### Back-up Memory Function

This is the function that preserves the preset memory and most-recent memory function. In the event of a power failure, or if the power cord of this unit is disconnected from the electric outlet, the back-up memory will preserve the preset memory and most-recent memory functions for approximately 1 week. If the power supply is interrupted for 7 days or longer, the memory settings will be erased.

#### When to use **RESET** switch

1. When this system is subjected to an electric shock.
2. When the power is irregular.

In this case, try the following:

Switch the **POWER** on, press the **RESET** button on the front panel for more than 3 seconds.

**Note:** If the **RESET** button is pressed for more than 3 seconds, all the memory will be erased.

### Before Connection

#### Caution

- Disconnect all equipment from the power source before making any connections.
- Read instructions of each component you intend to use with this unit.
- Be sure to insert each plug securely. To prevent hum and noise, do not bundle the connection cords with power cord or speaker cord.

### Speaker Connections

#### Caution:

- To avoid damaging the speakers with a sudden high-level signal, be sure to switch the power off before connecting the speakers.
- Check the impedance of your speakers. Connect speaker with an impedance of 6 ohms or more.
- The amplifier's red speaker terminals are the + (positive) terminals and the black terminals are the - (negative) terminals.
- The + side of the speaker cable is marked to make it distinguishable from the - side of the cable. Connect this marked side to the red + terminals and the unmarked side is the black terminal.
- Prepare the speaker cords for connection by stripping off approximately 10 mm or less (no more as this could cause a short-circuit) of the outer insulation.
- Twist the wires tightly together so that they are not straggly.

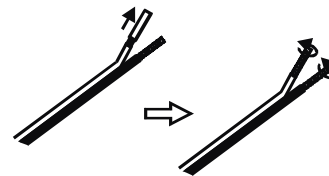

#### How to connect

Red: positive (+)  
Black: negative (-)

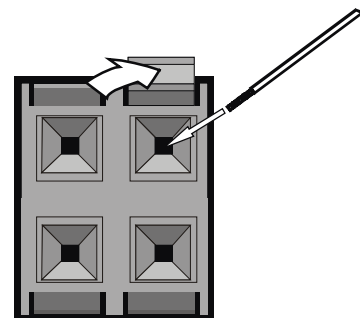

1. Press down the lever at the antenna terminal.
2. Insert the exposed wire into the terminal hole
3. Release the lever.

## CONNECTION

### FM INDOOR ANTENNA

If you live reasonably close to a transmitter and want to use the provided lead-type FM antenna, you will have to connect it direct to the "FM 75" socket. Fit the metal sleeve of the lead-type antenna over the core (center) conductor of the (FM 75) socket, extend the lead and fix it to a window frame or wall with thumbtacks, or the like, where reception is best. Lead-type FM 75 Antenna provided.

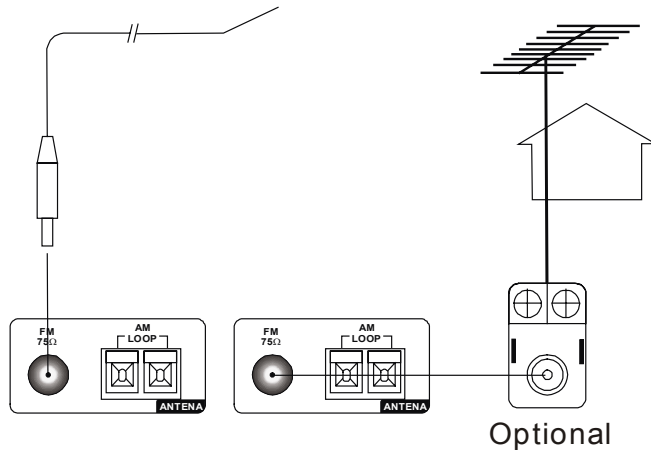

### OUTDOOR FM ANTENNA (75)

#### FM OUTDOOR ANTENNA

In an area where FM signals are weak, it will be necessary to use a 75 unbalanced-type outdoor FM antenna using the optional matching transformer, as shown. Generally, a 3-element antenna will be sufficient: if you live in an area where the FM signals are particularly weak, it may be necessary to use one with 5 or more elements. Connect the coaxial cable of the antenna to the matching transformer as shown. After completing connection, plug the transformer into the "FM 75" socket.

#### How to connect a coaxial cable to the matching transformer

- Strip the cable and dress it as shown.

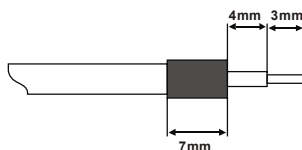

- Press both side tabs outward to remove the cover.

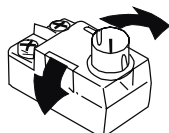

- Wrap the core conductor around the central metal fixture as shown.

- Crimp the jagged metal fixtures so they hold the braided portion using pliers, etc.

- Put the cover back in place.

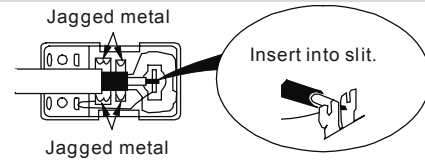

### AM INDOOR LOOP ANTENNA

- To stand the antenna on a flat surface, fix the claw to the slot.

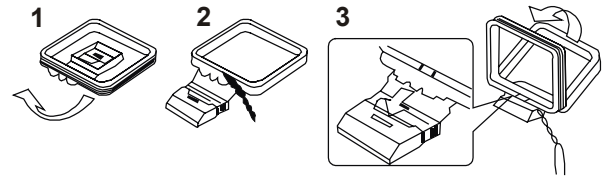

- The high performance AM loop antenna provided with this unit is sufficient for good reception in most areas.

- Connect the loop antenna's wires to the AM antenna terminals as shown.

- Place the antenna on a shelf or hang it on a window frame, etc, in the direction which gives the best reception and as far away as possible from the entire system, speaker cords and the power cords, to prevent unwanted noise.

### AM Loop Antenna (provided)

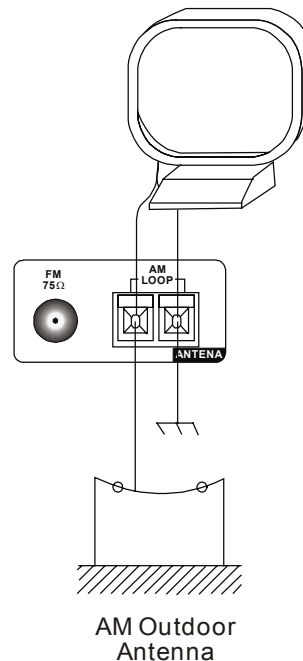

### AM Outdoor Antenna

If the AM loop antenna provided does not deliver sufficient reception (because you are too far from the transmitter or in a concrete building, etc.), it may be necessary to use an outdoor AM antenna.

Use an insulated wire more than 15 ft (5m) long, strip one end, and connect this to the terminal as shown. The antenna wire should be strung outdoors or indoors near a window. For better reception, connect the GND terminal to a reliable ground.

**Note:** When connecting an outdoor AM antenna, do not disconnect the AM loop antenna.

## CONNECTION

### Speaker layout example when using surround mode

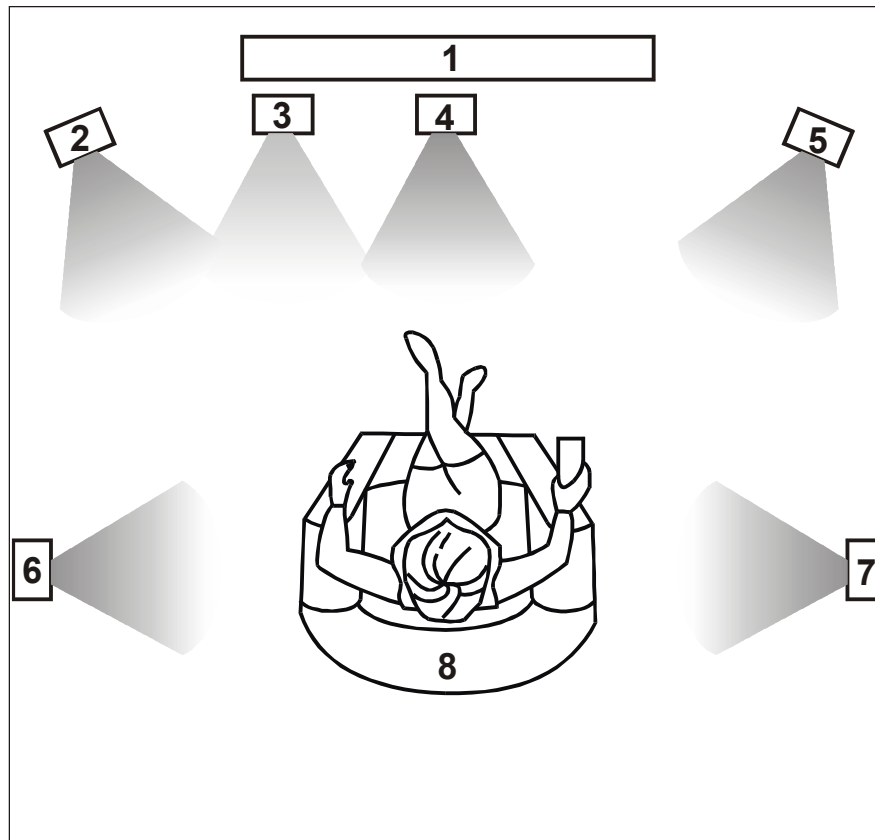

- |                           |                        |                          |
|---------------------------|------------------------|--------------------------|
| 1. TV or Screen           | 2. Front Left Speaker  | 3. Subwoofer             |
| 4. Center Speaker         | 5. Front Right Speaker | 6. Surround Left Speaker |
| 7. Surround Right Speaker | 8. Listening Position  |                          |

#### Standard speaker setup for surround sound

- **Front Right and Left speakers**  
These are the main speakers providing the front stereo effect of the sound image.
- **Centre speaker**  
This produces a rich sound image by serving as a centre sound source for the front right and left speakers thus enhancing the sonic movement.
- **Surround Right and Left speakers**  
These add three-dimensional sonic movement and produce environmental sound associated with the background and effect sounds for each scene.
- **Subwoofer**  
Required to add powerful and heavy bass.

#### Speaker placement

Ideal speaker placement varies depending on the size, shape of your room and the wall coverings. Here is a typical example of speaker placement and recommendations as shown.

#### Important points regarding speaker placement

##### **Front Right and Left speakers and Centre speaker**

- Place these three speakers all at the same height.
- Place each speaker so that it is aimed at the location of the listener's ears when at the listening position.
- Try to place all the front speakers at the same distance from the listening position.

##### **Surround Left and Right speakers**

- Place these speakers so that their height is 3 feet (1 meter) higher than that of the listener's ears.

##### **Subwoofer**

Ideally a subwoofer should always be located in front of the listening position between the Front Left and Right speakers. Since all rooms vary, experiment with the placement of your subwoofer for the best overall sound image (placing a subwoofer in the corner of a room often helps to disperse the sound).

# CONNECTION

## SPEAKER CONNECTION

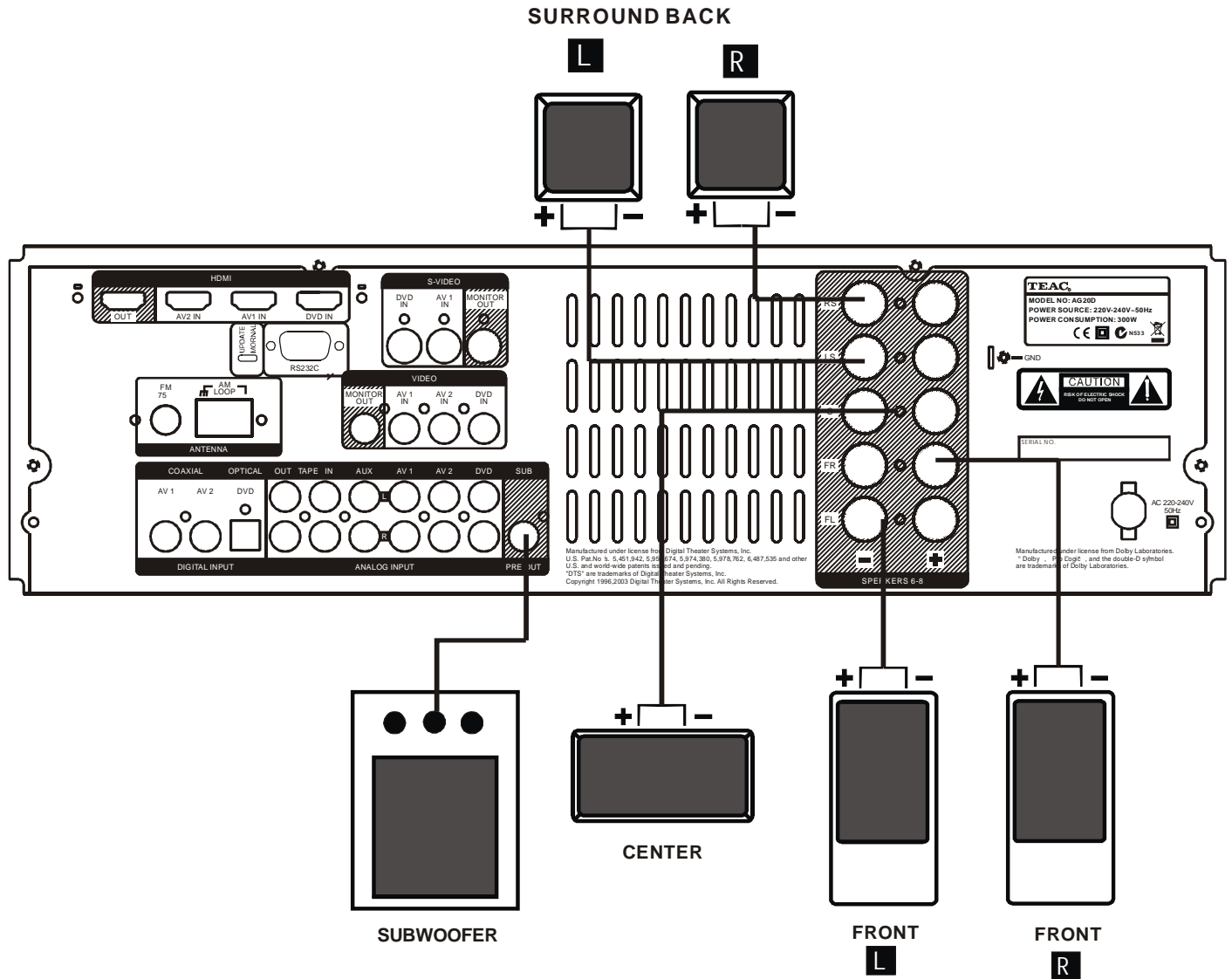

### Power cord (AC)

- Be sure to connect the power cord to an AC outlet, which supplies the correct voltage.
- Hold the power plug when plugging or unplugging the power cord.
- When connecting this AV receiver up to your TV, or other components, make sure that all components are switched off and unplugged from main AC power.

### Subwoofer Out

Use this jack to connect an active subwoofer.

## CONNECTION

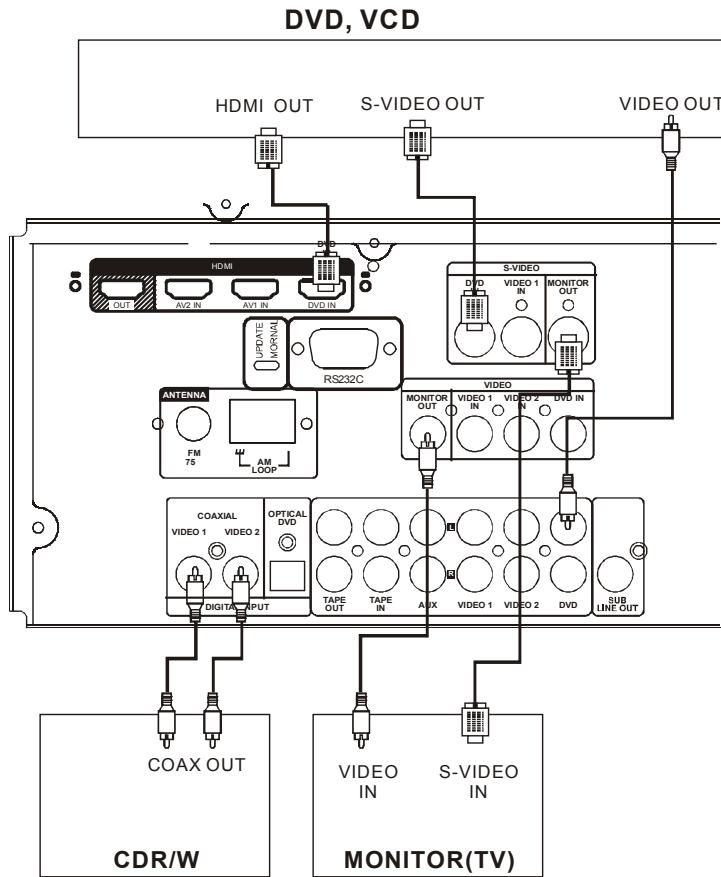

When connecting video components such as DVD players, cable boxes, satellite receivers and television/plasmas, you can use different types of cables depending on how the video component is equipped.

### Video connections:

If the video component is equipped with S-VIDEO jacks, it is recommended to connect to your unit or directly to the television monitor using an S-VIDEO cable. S-VIDEO cables provide better picture clarity and resolution. If the video component is not equipped with an S-VIDEO jack, use a conventional RCA or RCA composite cable to connect to your unit or connect it directly to the television. The illustration here shows how to connect video components to your unit.

### Note:

When connecting more than one video component to your unit (i.e. VCR and DVD player) it is easier to use either all S-VIDEO cables or all RCA to RCA composite cables. This allows both video signals (DVD and VCR) to be sent through your unit to the TV monitor using just one video input on the TV

(S-Video or RCA). Regardless of the video component being played DVD or VCR, the picture will always appear on the same video input of the monitor.

If you use both S-Video and RCA composite cables to connect different video components to your unit, you must also use both S-Video and RCA composite cables to connect the TV monitor to your unit. For example, if you connect a DVD player to your unit using S-Video cable and a VCR using an RCA to RCA composite cable, you must also connect the TV to your unit using both types of cables. This requires an S-Video cable from the S-Video monitor out jack on your unit to an S-Video input on the TV (i.e. Video 1). In addition, you must use an RCA composite cable from the composite video monitor out jack on your unit to an RCA composite video input on the TV but not the same input used for the S-Video cable (i.e. Video 2). Using this type of dual cable video connection, you will need to switch the TV video input source from TV to Video 1 to Video 2 depending on the video source being played-TV, DVD or VCR.

## CONNECTION

### Audio connections:

Some video components are equipped with special digital audio outputs (e.g. DVD players). If your video component is equipped with a digital audio output, it is recommended that you connect to your unit using a digital cable. Digital audio cables are required to use the DTS and Dolby Digital surround sound modes. If you do not use digital connections, your unit will only operate in Dolby PRO LOGICII, MUSIC, THEATER, HALL and 5 Stereo surround modes. There are two types of digital cables-coaxial (75 ohm) and optical. Your unit is equipped with both types of digital inputs. These inputs are labelled COAXIAL IN and OPTICAL IN on the rear of the unit. Connect the video component outputs to any one of the two digital inputs on your unit. If the video component is not equipped with a digital output, use a dual RCA to RCA composite audio cable to connect to your unit. Make sure to connect:

**White plug to white jack (L: left)**  
**Red plug to red jack (R: right)**

### Note:

When an optical cable is used, remove the protection caps from the component and your unit before attempting to insert the optical cable. If not using an optical cable or if the cable is removed, always re-install the protection caps to prevent dirt and dust from entering the inputs. If using a coaxial digital cable, leave the protection caps in both the video component and your unit.

### CD, TAPE jacks

Connect the component with RCA to RCA cords. Make sure to connect:

**White plug to white jack (L: left)**  
**Red plug to red jack (R: right)**

### DIGITAL IN/OUT terminals

If the CD player or MD player has digital outputs, connect the component with coaxial cables or optical cables.

**DIGITAL IN to DIGITAL OUT (CD, etc.)**  
**DIGITAL OUT to DIGITAL IN (MD, etc.)**

Connect to any one of the DIGITAL IN terminals. When using DIGITAL OPTICAL IN terminals, remove the caps from the terminals. When you do not use them, leave the caps in place. To record digitally, connect the source (CD player, etc.) to DIGITAL IN and the recorder (MD, etc.) to DIGITAL OUT.

## REMOTE CONTROL UNIT

By using the provided remote control unit, this unit can be controlled from your listening position. To use the remote control unit, point it at the REMOTE SENSOR window of this unit.

### Notes:

- Even if the remote control unit is operated within the effective range, remote control operation may be impossible if there are any obstacles between the unit and the remote control.
- If the remote control unit is operated near other appliance which generate infrared rays, or if other remote control devices using infrared rays are used near the unit, it may operate incorrectly.
- The power is turned on/off (standby) by pressing the POWER button on the remote control unit in standby mode.

### Precautions concerning batteries

- Be sure to insert the batteries with correct positive+ and negative – polarities.
- Use batteries of the same type. Never use different types of batteries together.
- Rechargeable and non-rechargeable batteries can be used. Refer to the precautions on their labels.
- When the remote control unit is not to be used for a long time (more than a month), remove the batteries from the remote control unit to prevent them from leaking. If they leak, wipe away the liquid inside the battery compartment and replace the batteries with new ones.
- Do not heat or disassemble batteries and never dispose of old batteries by throwing them in a fire.

## BATTERY INSTALLATION

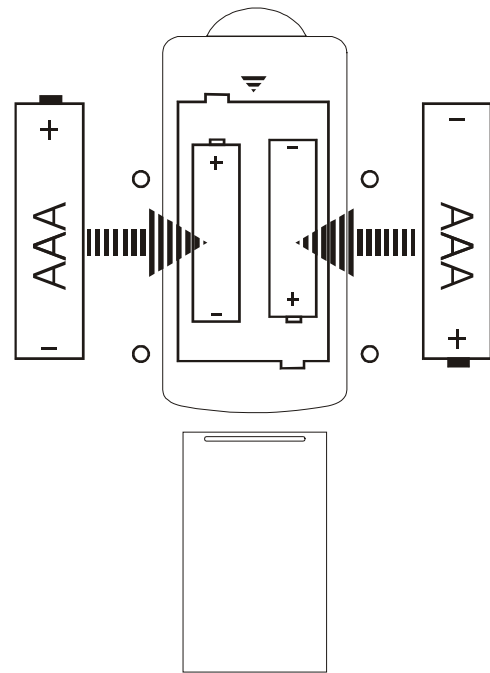

1. Remove the battery compartment cover.
2. Insert two “AAA” dry batteries. Make sure that the batteries are inserted with their positive “+” and negative “-” poles positioned correctly.
3. Close the cover until it clicks.  
If the distance required between the remote control unit and main unit decreases, the batteries are exhausted. In this case, replace the batteries with new ones.

# FRONT PANEL INFORMATION

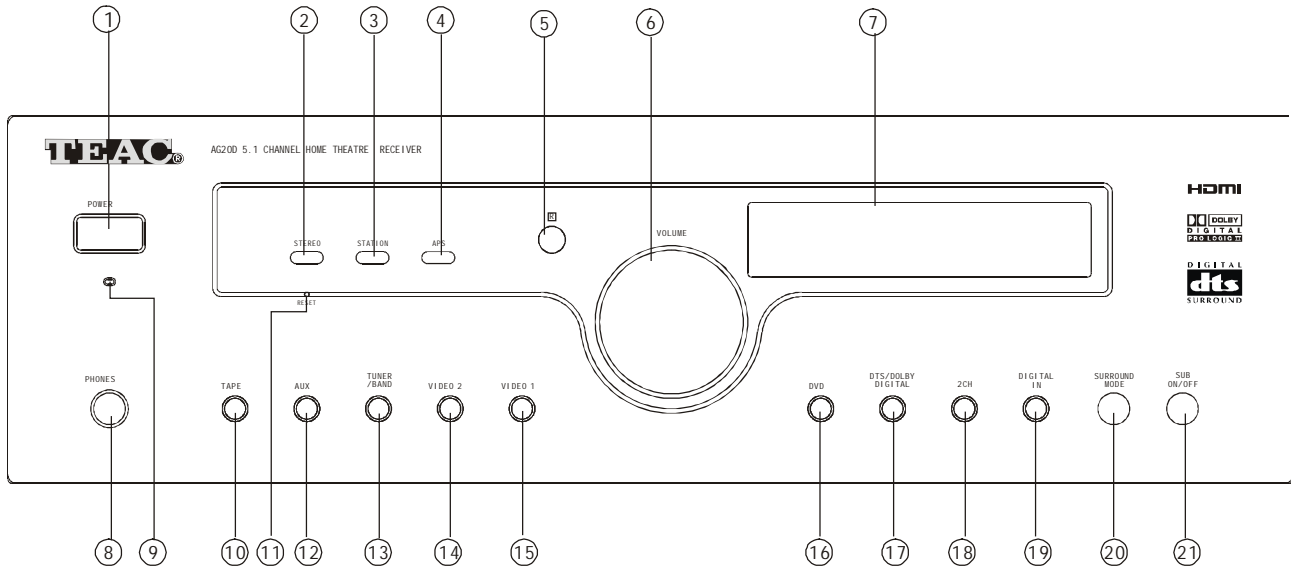

<b>1. POWER</b>	Turns the unit on/off.	<b>12. AUX</b>	Press this button to select AUX.
<b>2. STEREO</b>	Press this button to alternate between Stereo and Mono mode when listen to FM broadcast.	<b>13. TUNER/BAND</b>	Press this button to select the TUNER. Press again to select FM and AM.
<b>3. STATION</b>	When using the Tuner press this button to select a preset channel.	<b>14. VIDEO 2</b>	Press this button to select VIDEO 2.
<b>4. APS</b>	Allocates and memorizes radio stations automatically. ( <b>Note:</b> Hold this button down for more than 3 seconds to activate)	<b>15. VIDEO 1</b>	Press this button to select VIDEO 1.
<b>5. REMOTE SENSOR</b>		<b>16. DVD</b>	Press this button to select DVD.
<b>6. VOLUME</b>	To decrease or increase the Master Volume.	<b>17. DTS/DOLBY DIGITAL</b>	When playing 5.1CH source, and while you are enjoying Stereo, press this button to playback source in DTS/DOLBY DIGITAL.
<b>7. VFD DISPLAY UNIT</b>	Informs you of selected inputs and system state.	<b>18. 2CH</b>	Select STEREO mode ( <b>Note:</b> only Front Left & Front Right and Woofer speakers are activated).
<b>8. PHONES</b>	Jack for stereo headphones.	<b>19. DIGITAL IN</b>	Press this button when using a source connected by a DIGITAL IN. Press it to select : DVD COA. DVD OPT, VIDEO 1 OPT and VIDEO 2 OPT, or when using an analog source.
<b>9. STANDBY INDICATOR</b>		<b>20. SURROUND MODE</b>	Select surround modes: MOVIE and MUSIC.
<b>10. TAPE</b>	Press this button to select TAPE.	<b>21. SUB ON/OFF</b>	Press this button to turn on/off the subwoofer.
<b>11. RESET</b>	To reset the whole system to factory defaults.		



## REAR PANEL INFORMATION

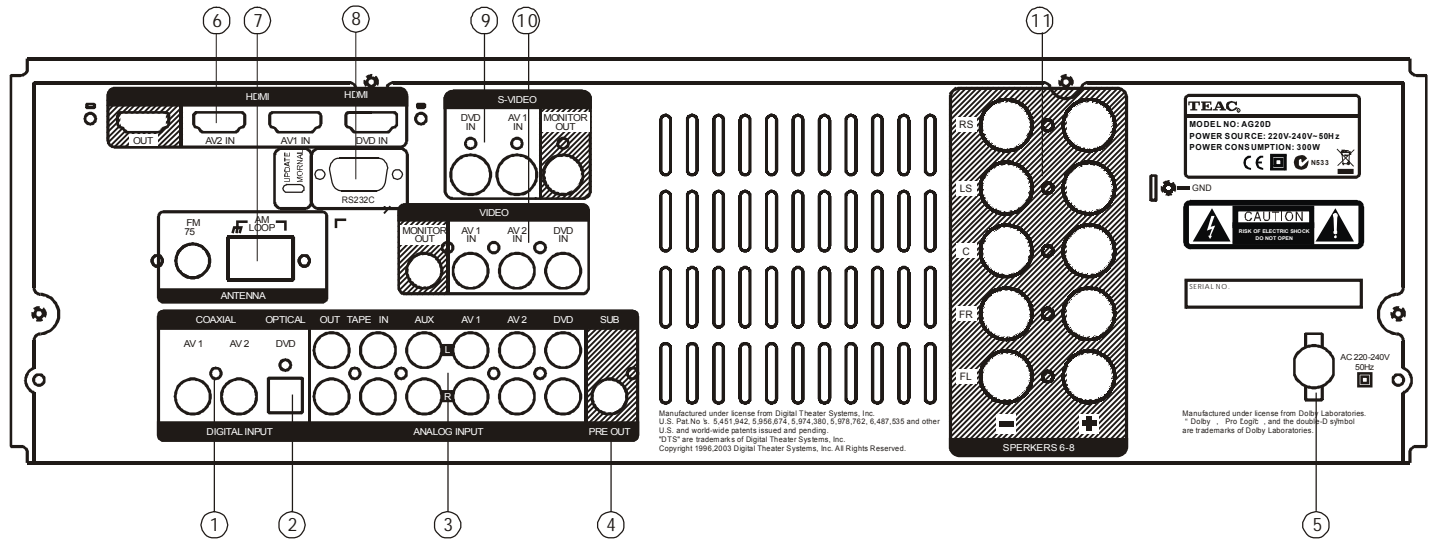

### 1. COAX. IN

Digital audio input for connection to the digital output of another DVD/Decoder/Games Console.

### 2. DIGITAL INPUT

Optical audio input for connection to the optical output of another DVD/Decoder/Games Console.

### 3. ANALOGUE AUDIO IN/OUT terminals

### 4. SUB LINE OUT

Pre-out for an active subwoofer.

### 5. AC CORD

Connect to the AC mains socket.

### 6. HDMI PORT

For connection to the equipment with HDMI output.

### 7. ANTENNA terminal

Connect to the AM indoor loop antenna/Lead-type FM antenna.

### 8. RS232 port

### 9. S-VIDEO IN/OUT terminals

- DVD S-VIDEO IN: Connect an S-VIDEO cable to the S-VIDEO output terminal of a DVD player.
- VIDEO-S IN: For connection of S-VIDEO cable to the output terminal of an external player.
- VIDEO-S OUT: For connection of S-VIDEO cable to the input terminal of an external player.

### 10. VIDEO IN/OUT terminals:

- VIDEO OUT: Use an RCA composite cable to connect to the TV set.
- V1/V2 IN: Connect RCA composite cables to the line outputs of external players.
- DVD IN: Using an RCA composite cable to the line output of a DVD.

### 11. SPEAKERS

External speakers power output. (Refer to Speaker Connection section)

# REMOTE CONTROL INFORMATION

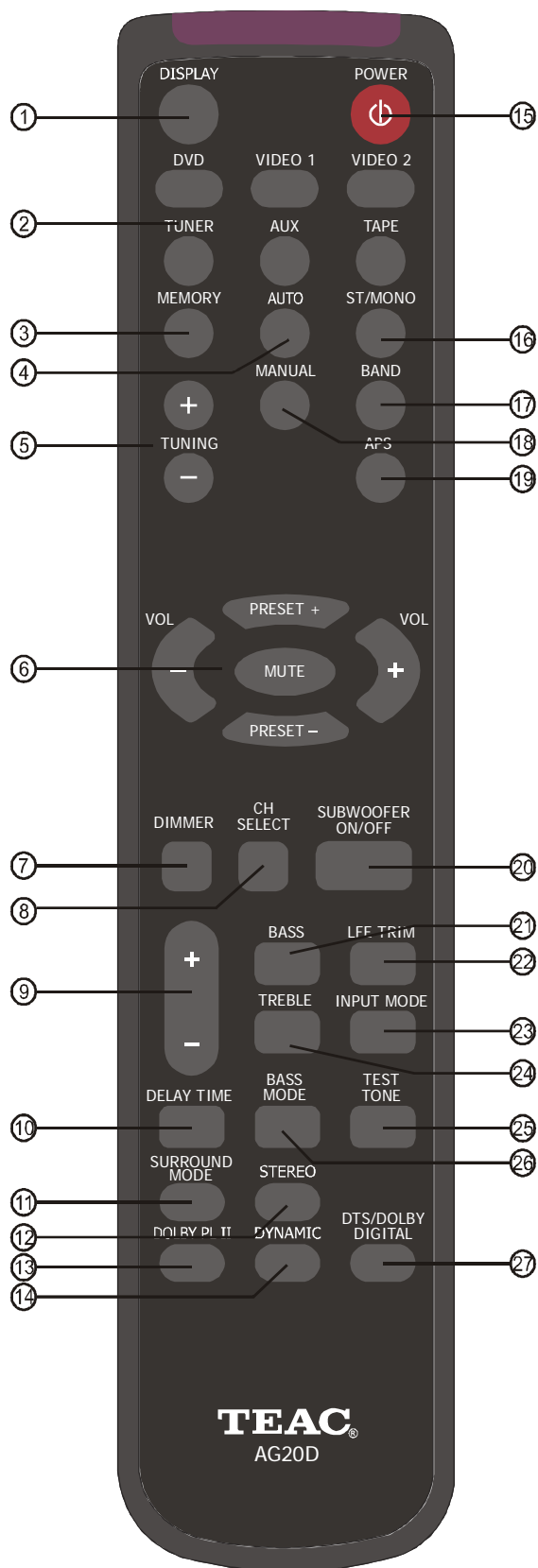

## REMOTE CONTROL INFORMATION

### 1. Display

Press this button to display the state of input source. And when listening to the FM broadcasting with RDS, press this button to show PS, PTY, RT and RT.

### 2. Input Source

Choose the input as your desire, you can choose DVD VIDEO1 VIDEO2 TUNER AUX and TAPE

**3. Memory:** Press it to store the broadcast station as a preset.

### 4. Auto

This button is used to select AUTO tuning for AM and FM stations.

### 5. Tuning +/-

Tuner frequency up and down..

### 6. Cursor

- Vol +/-: decrease or increase the volume.

- Preset +/-: Press these buttons to select a preset channel during the tuner mode.

- Mute: Press this button to mute the sound, push again to cancel the mute function.

### 7. Dimmer

Press this button to set the brightness of the front panel display.

### 8. CH Select

Select channels by pushing this button, then use volume key to balance speakers.

### 9. +/-

These keys are used for SPK SETUP and DELAY TIME, Treble and Bass adjustment.

### 10. Delay Time

Press this button to set the delay time for the Dolby digital/Dolby Pro Logic modes.

### 11. Surround Mode

Select surround modes: MOVIE and MUSIC.

### 12. Stereo

With the unit in the STEREO mode, only front left and front right speakers and Woofer are working.

### 13. Dolby PL II

When receiving Analog/digital PCM signal or 2CH Pro Logic, turn on this button then the playing is under analog 5.1CH state.

### 14. Dynamic

Press this button repeatedly to reach your desired compression dynamic range.

### 15. Power

Push this button to turn the unit into standby mode, push it again to turn off the unit.

### 16. ST/Mono

Press this button to alternate between Stereo and Mono mode when listen to FM broadcast.

### 17. Band

Press this button to alternate between FM and AM.

### 18. Manual

This button is used to select MANUAL tuning for AM and FM stations.

### 19. APS

Allocates and memorizes radio stations automatically. (**Note:** Hold this button down for more than 3 seconds to activate)

**20. SUB Woofer On/Off:** Push this button to turn on or off the subwoofer output.

### 21. Bass

Press this button for **Bass** adjustment, then press +/- key to adjust the level.

### 22. LFE Trim

Under the Pro Logic 5.1CH or DTS 5.1CH mode, press this button and adjust the volume to set the Low Frequency output level

### 23. Input Mode

Select Coaxial, Optical or Analog Input mode in DVD, AV1 and AV2.

### 24. Treble

Press this button for **Treble** adjustment, then press +/- key to adjust the level.

### 25. Test Tone

To balance speakers in Dolby Digital or Dolby Pro Logic mode.

### 26. Bass Mode

Press this button to set the delay time for the Dolby digital/Dolby Pro Logic modes.

Select one of the two preset speaker configuration according to your speakers. (refer to page 17)

### 27. DTS/Dolby Digital

When playing 5.1CH source, and while you are enjoying Stereo, push this button to playback source in DTS/DOLBY DIGITAL.

## BASIC OPERATION

### BASIC OPERATION 1

1. Press the **POWER** button to put this unit into Standby Mode.
2. Press one of the source buttons to activate the unit.
3. Select the desired source by pressing **DVD, VIDEO 1, VIDEO 2, TUNER, AUX or TAPE**.  
If you have selected DVD, VIDEO 1, VIDEO 2 (not TUNER, AUX or TAPE), press **INPUT MODE, SURROUND MODE, DTS/DOLBY DIGITAL, STEREO, DOLBY PROLOGIC II** or **DIGITAL IN** in accordance with the type of signal you are receiving and the sound output you require (for example, Dolby Pro Logic II if the DVD movie is an older "classic" and only recorded in stereo).
4. Play the source, and gradually turn up the volume to the required level with the **VOLUME** control.

### BASIC OPERATION 2

#### A. POWER button

Press this button to turn this unit into standby mode, then the STANDBY indicator lights up, press one of the source buttons to activate this unit, the standby indicator goes out when this unit is turned on.

#### B. SURROUND MODE

This mode is used to achieve a realistic sound field with a "three-dimension", giving the sense of distance, movement and relative position, creating a real and powerful sense of presence.

#### C. STEREO

In the STEREO mode, only the Front Left and Front Right speakers and Subwoofer are activated.

#### D. DOLBY PRO LOGIC II

Pro Logic II uses a directional emphasis circuit to decode five output channels (Front Left & Front Right, Centre and Surround) from a stereo audio channel.

#### E. DTS/DOLBY DIGITAL

When playing 5.1CH source, and while you are enjoying Stereo, press this button to playback source in DTS/DOLBY DIGITAL.

#### F. PHONES jack

For private listening, insert your headphones (1/4 -inch plug) into the PHONES jack. The centre and surround speakers will be cut automatically.

**Note:** When using headphone, the audio output will automatically down mix to STEREO.

## BASIC OPERATION

### PLAYING VIDEO SOURCES

1. Select DVD, VIDEO1, VIDEO 2 by pressing the corresponding button.
2. Play the sound source corresponding to the source selected (for example, if you have selected DVD, press PLAY on your DVD player).
3. The picture from the video source will be transmitted to the TV and the sound from the video source will be heard from the speakers.

### THE RADIO OPERATIONS

#### Automatic Tuning

1. Press the **POWER** button, then press the **TUNER** button to turn ON this unit.
2. Select TUNER mode by pressing the **TUNER** button.
3. Select the appropriate frequency band (FM or MW) by pressing the **TUNER** button again.
3. Press the **AUTO/MANUAL** button on the remote to activate automatic selection. (**Note:** default mode is Manual selection) "Auto" now appears on the display.
4. Press the **TUNING +/-** on the remote to select the station you want to listen to. When a station is tuned in, the tuning process will stop automatically. (Automatic station selection)
5. Press **TUNING +/-** on the remote again to select another channel.

#### MANUAL TUNING

Use this function for selecting stations which cannot be tuned automatically due to a weak signal

To tune a channel manually:

Skip step 4 in the above procedures. Each time the **TUNING +/-** button is pressed momentarily (0.5 second or less), the frequency changes by a fixed increment (FM: 50 kHz increments, MW: 9 kHz increments).

#### FM Modes Available:

Press the **STEREO** button to alternate between Stereo mode and Mono mode.

**Stereo:** FM stereo broadcasts are received in stereo and the "∞" indicator lights on the display.

**Mono:** Use to compensate for weak FM stereo reception. Reception will now be forced to monaural, reducing unwanted noise.

#### PRESET TUNING

This facility is used to store FM and MW stations from channels 1 to 15 respectively.

##### Automatic Memory Presetting:

1. Select TUNER mode by pressing the **TUNER** button.
2. Select MW or FM by pressing the **TUNER** button again.
3. Press the **APS** button.  
The 15 best-reception stations in your area will be automatically stored.

##### Manual Memory Presetting

1. Select TUNER mode by pressing the **TUNER** button.
2. Select MW or FM by pressing the **TUNER** button again.
3. Press the **TUNING +/-** button on the remote to select a station you want to preset.
4. Press the **MEMORY** on the remote button briefly.
5. While the "MEM" indicator is lit, press **TUNING +/-** button to select a preset station. The station number will be displayed on the screen.
6. Press the **MEMORY** button again.

To store more stations, repeat steps 3 to 6.

#### How to select preset stations

Ensure you are in TUNER mode and press the **STATION** button to select a preset radio station.

# SPEAKER CONFIGURATION, DELAY TIME & DYNAMIC RANGE CONTROL

## SPEAKER CONFIGURATION

It is important to configure your speakers correctly in order to get the most from your AV Receiver. This versatile AV Receiver provides the flexibility to experience multi-channel surround sound without a center speaker. However, for best results with Dolby Pro Logic II, DTS and Dolby Digital decoding, at least 5 speakers (Left, Center, Right, Left Rear and Right Rear) should be used. (**Note:** As with all surround sound configurations, we recommend the use of a Subwoofer speaker to fully experience the Low Frequency Effect encoded into most of today's DVD movies).

## BASS MODE

There are 2 preset speaker configurations based on the size of your speakers.  
Default is Mode 1.

	Front L & R	Center	Rear L & R	Sub-Woofer
<b>Mode1</b>	Small	Small	Small	On
<b>Mode2</b>	Large	Small	Small	On

Press **BASS MODE** to select one of the 2 modes according to your speaker's size.  
(**Note:** Large speakers can fully reproduce low frequencies of below 80Hz. Small speaker cannot reproduce low frequencies of below 80Hz with sufficient volume. Refer to your speaker specifications to select the correct size).

## DELAY TIME

The delay time can be individually set for the Dolby Digital/Dolby Pro Logic II modes using the DELAY (CENTER/REAR) buttons.  
When you adjust the delay time in the Dolby Digital mode, an additional 15 ms is automatically added to the surround channels in the Dolby Pro Logic mode. The current setting is shown on the display.



1. Press "**DELAY TIME**" on the remote control repeatedly, the corresponding speaker appears on the display: **S** → **C**
2. Press **+/-** button to set the time delay.

## Delay Time Setting Adjustable Range

### DOLBY DIGITAL MODES:

0-15 ms in 5 ms step (S-Delay)

0-5 ms in 1 ms step (C-Delay)

### DOLBY PRO LOGIC II MODE:

10-25 ms in 5 ms step (S-Delay)

In the surround modes, the sound from the speakers should be delayed slightly, relative to that from the front speakers.

The optimum delay time will depend on acoustic properties, whether the walls and furnishings reflect or absorb sound, etc.

It is recommended that you try different delay times to obtain the best effect. The delay is digitally synthesized.

For the highest sound quality with minimum noise and distortion, the delay time can be set independently for each surround mode using the DELAY TIME buttons, with the current setting shown in the display.

## DYNAMIC RANGE CONTROL

This button controls the compression range of sound track. If the compression is large (DRC = 4/4), the sound effect is retarded to a certain range. As a result, sound effect is not as excited as normal range (DRC = 0/4). It is useful when you want to movies at the late night.

- Press **DYNAMIC** on remote control repeatedly until the desired compression range reached.

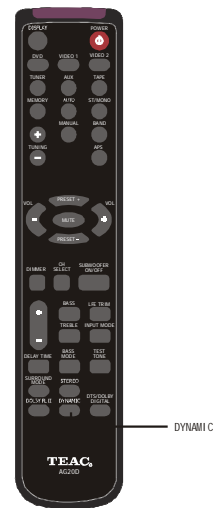

**DRC=0/4**

**DRC=1/4**

**DRC=2/4**

**DRC=3/4**

**DRC=4/4**

**No Compression**

**Greatest Compression**

### Note:

1. The Dynamic Range Control state will resume to normal if you do not press it after 5 seconds.
2. Dynamic Range Compression is not possible with DTS sources.

# TEST TONE, LFE TRIMMER & CHANNEL SELECT

## TEST TONE

### Speaker Level balance Adjustment

The test tone function is useful to adjust the relative volume between speakers in DOLBY DIGITAL or DOLBY PRO LOGIC II mode.

Once the balance is set, you don't have to change the balance as long as the speakers aren't moved.

1. Adjust the **MASTER VOLUME** to the normal listening level. (Half of max. Volume is recommended)
2. Press the **TEST TONE** button (on the remote control) in DTS, Dolby Digital or Dolby PRO LOGIC II mode.

The test tone is emitted from each speaker each time you press "**TEST TONE**".

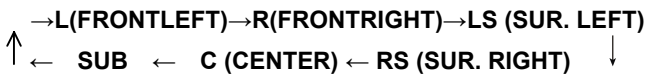
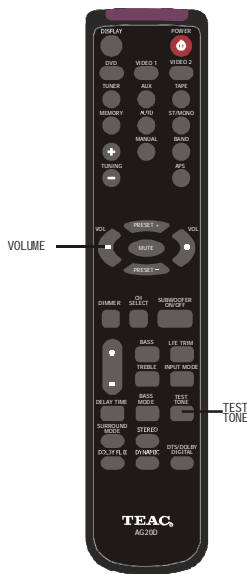

3. Select a speaker by pressing the "**TEST TONE**" button and adjust the level by pressing the **MASTER VOLUME** button.

The level of each speaker can be adjusted in 1 dB step from -10 dB to +10 dB.

4. When the setting is finished, press the TEST TONE button to stop the test tone. (**Note:** You must keep press **TEST TONE** until one complete cycle is finished.)

## LOW FREQUENCY EFFECT

### LFE (LOW FREQUENCY EFFECT) MIX LEVEL (LFE MIX) initial setting: 0 dB

Under COAX./OPT mode, when playing a Dolby Digital or DTS 5.1CH signal, LFE will appear on the display. Press the **LFE** key on the remote and press the **VOL +/-** button to adjust the level between 0dB to -10dB. (**Note:** The **LFE** adjustment function will resume to normal, if the **VOL +/-** button is not pressed within 5 seconds.)

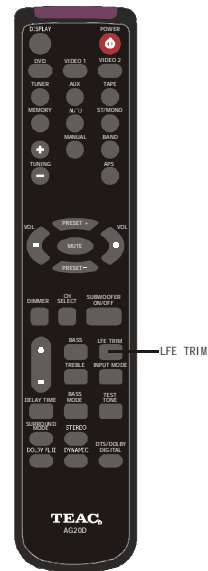

## CHANNEL SELECT

### Balancing volume between speakers in 5.1 channel mode when using the 5.1 analogue inputs.

As the Dolby Digital signal is decoded in the external source, sometimes, you may have to balance volume between speakers due to the location of speakers. In this case:

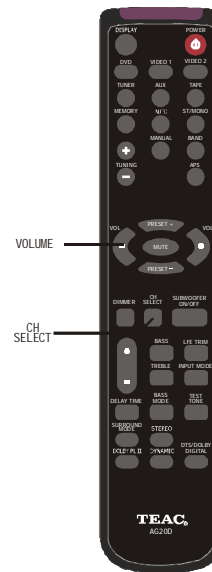

1. Press "**CH SELECT**" on the remote, the following loop will appear on the display:

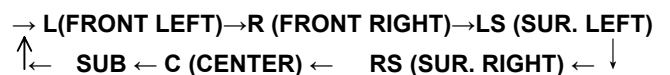

2. Adjust the **Master Volume** to balance all speakers. The level of each speaker can be adjusted in 1 dB steps from -10 dB to +10 dB.

(**Note:** If the **Master Volume** is not adjusted for 5 seconds in Channel Trimmer state, it returns to normal state.)

## AVAILABLE SURROUND MODE

### SURROUND MODE

The surround modes create a "live" atmosphere such as that experienced in movie theaters, discos, stadiums and concert halls. Select the appropriate surround mode according to the program source. (**Note:** Surround speakers are needed for DTS/DOLBY DIGITAL Dolby Pro Logic II surround modes to function).

It is recommended to use a Center speaker when operating this unit in DTS/DOLBY DIGITAL/Dolby Pro Logic II surround modes. The

DOLBY DIGITAL button can be pressed when you are using either an Optical or Coaxial cable as the input connection because these cables transmit the required encoded digital data.

**Manufactured under license from Dolby Laboratories. "Dolby", "Pro Logic" and the double-D symbol are trademarks of Dolby Laboratories**

The DOLBY PRO LOGIC and DTS buttons can be pressed when you are operating in **Analog Mode**.

When a Dolby Digital format signal is input, the surround mode automatically switches to the DOLBY DIGITAL mode.

### DTS DIGITAL SURROUND MODE

This unit is provided with the following Surround modes allowing you to enjoy 5.1 (or 6) discrete channels of high quality digital audio from DTS program sources bearing the **DTS** trademark such as discs, DVDs and compact discs, etc. DTS Digital Surround delivers up to 6 channels of transparent audio (which means identical to the original masters) and results in exceptional clarity within a genuine 360 degree sound field. The term DTS is a trademark of DTS Technology, LLC. Manufactured under license from DTS Technology, LLC. (**Note:** DTS program sources should be played back in DTS mode).



**"DTS", and "DTS Digital Surround" are trademarks of Digital Theater Systems, Inc.**

### DOLBY DIGITAL MODE



The Dolby Digital surround format lets you enjoy up to 5.1 channels of digital surround sound from a Dolby Digital program source. If you connect a DVD player or an LD player equipped with a DOLBY DIGITAL output to the DIGITAL (Dolby Digital)/DTS/PCM DIGITAL IN jack (Optical or Coaxial digital IN) on your AV Receiver and play DVD or laser discs with the Dolby Digital trademark, you will experience exceptional sound quality, great spatial accuracy, and improved dynamic range. This is because Dolby Digital delivers 5 totally discrete, full frequency audio channels (Front Left Right, Center, Surround Left and Right), plus a "0.1" channel called LFE (Low frequency-only effects channel).

Dolby Digital is a system developed by Dolby laboratories that transmits 5.1 digital signals, The surround system developed for movie theaters using this system is called "Dolby SR-D (Surround Digital)". Because each channel is completely independent, a realistic sound field with a "three-dimensions" feel is achieved which gives the sound a sense of distance, movement and relative position, creating a real and powerful sense of presence. Some Dolby Digital programs carry information that allow you to compress the dynamic range of sound track, without degrading the sound quality, for softer sound effects when watching movies late at night.



## TROUBLESHOOTING

To determine a problem with your AV Receiver, always check the most obvious possible causes first. If a problem still exists after having checked the possible causes below, consult your nearest dealer.

Problem	Probable Cause	Suggestion
<b>Amplifier</b>		
When listening to the music in stereo, Left/Right speakers are reversed.	Incorrect speaker connections.	Check and reconnect the speakers to the correct output on the AVR-618 rear panel.
Low hum or buzzing sound	The power cable of a fluorescent light is installed near this product or speaker cables running over other power cables.	Place this product as far as possible from electric devices which emit electrical interference.
Sound is only heard from one channel	One of the input cables is disconnected or the BALANCE control is set incorrectly.	Connect the input cables securely And check the BALANCE control.
Sound cuts off when listening to the music or no sound even though power is ON.	Speaker impedance is less than prescribed for this unit.	After turning off the power and then turning it on again, reduce the volume or change to the correct 6 ohm speakers.
Low bass response.	Speaker polarity (+/-) is reversed.	Check all speakers for correct polarity.
<b>Tuner</b>		
A hissing noise is heard when listening to the broadcast in stereo, but not heard when listening in Mono.	White noise may be heard because the method used for modulation of FM stereo broadcasts which is different to that used for monaural broadcasts.	Try reducing the treble sound by adjusting the treble controls.
White noise is excessive in both stereo and monaural broadcasts.	Poor location and/or direction of the antenna or the transmitter station is too far away.	Set the <b>FM</b> mode to monaural by pressing the STEREO/MONO button. ( <b>Note:</b> that the broadcast will then be heard in Mono).
Sound is distorted and/or the volume level is low.	Broadcast signals are receiving interference.	If an indoor antenna is being used, change to an outdoor antenna
Excessive distortion in Stereo mode.	Weak signal.	Try using an antenna with more elements.
<b>Surround Effects</b> (Important) The Centre and Rear speakers only operate when the unit is set to a Surround Sound mode and the source material being played is recorded or broadcast in Dolby Digital, DTS or Dolby Pro Logic surround sound. Stereo broadcasts or recordings will produce some rear channel effects when played in a surround mode. However, mono sources will not produce sound from the rear speakers.		
No sound from the rear speakers	SURROUND ON/OFF button is set to OFF. Source being played is not recorded or broadcast in surround sound or stereo. One or more of the rear speakers is not connected properly.	Set SURROUND ON/OFF to the desired surround sound mode. Use a surround or stereo source. Check all rear speaker cables for good connections.
No sound from the Centre speaker	SURROUND mode is not set to DOLBY DIGITAL, DTS or DOLBY PRO LOGIC.	Set the SURROUND mode to DOLBY DIGITAL, DTS or DOLBY PRO LOGIC.
<b>Remote Control Unit</b>		
Remote control not working	The batteries are exhausted. The remote control unit is too far from this unit or out of the effective range	Replace with new batteries. Operate the Remote Control unit within the effective range

## SPECIFICATIONS

### AUDIO SECTION

Rated Power Output	FRONT	50W + 50W
	CENTER	50W
	REAR	50W + 50W
Output Terminals	FRONT	6 - 8 ohms
	CENTER	6 - 8 ohms
	REAR	6 - 8 ohms
Total Harmonic Distortion Less than 0.05% at 1/2 rated power output		

### LINE INPUT

Input Sensitivity/Impedance	150mV/47k $\Omega$
Frequency Response	20Hz~20KHz +0.5/-1dB
Tone Control Range	BASS $\pm$ 6dB
	TREBLE $\pm$ 6dB
Signal-Noise Ratio	75dB

### WOOFER OUTPUT

Rated Output/Impedance	150mV/10/k $\Omega$
Frequency Response	10Hz~300Hz $\pm$ 3dB

### FM TUNER SECTION

Frequency Range	87.5~108MHz
Sensitivity	14dB (5 $\mu$ V)
Antenna Terminal	75 ohm (unbalanced)

### MW TUNER SECTION

Frequency Range	522~1629KHz (Europe) 9KHz step
	530~1710KHz (US) 10KHz step
Sensitivity	68dB/M
Signal-to-Noise Range	30dB
Antenna	Loop Antenna

### VIDEO SECTION

Standard Video Jacks	
Input and Output	
Level/Impedance	1 Vpp/75 $\Omega$

### GENERAL

Power Supply	AC 220V-2400V~50Hz
Power consumption	200Watts
Dimensions	430 (W) x 265 (D) x 136 (H) mm
Weight	7kg

\* Design and specifications are subject to change without notice.

# TEAC®

## Service Providers in Australia

please contact one of the following service providers in your area if you require service for your product.

	<i>Name</i>	<i>Address</i>	<i>Service area</i>	<i>P C</i>	<i>Phone</i>	<i>Fax</i>
<b>ACT</b>	Associated Electronics	7 Molonglo Mall	CANBERRA	2609	(02)62 80 4698	(02)62 80 5437
	<i>Name</i>	<i>Address</i>	<i>Service area</i>	<i>P C</i>	<i>Phone</i>	<i>Fax</i>
<b>NSW</b>	B & H Electronics	466 David Street	ALBURY	2640	(02)60 41 3911	(02)60 21 7455
	Border Video & TV Service	Shop 3, 339 Urana Road	ALBURY	2641	(02)60 40 2229	(02)60 40 2184
	Bourkes Video & Tv Service	111 Danger Street	ARMIDALE	2350	(02)67 71 1513	(02)67 71 1696
	Nichols Electronics	Shop 4/70 River Street	BALLINA	2478	(02)66 86 9422	(02)66 81 4999
	Baytech Electronics	Shop 3, 270 Beach Road	BATEMANS BAY	2536	(02)44 72 7023	(02)44 72 7354
	Sapphire Electronics	U5B/85 Bega Street	BEGA	2550	(02)64 92 2522	(02)64 93 2062
	Lawson Radio & TV	298 Great Western Highway	BLUE MOUNTAINS	2783	(02)47 59 1254	(02)47 59 2312
	Visual Audio Services	510 Chapple Street - PO BOX 76	BROKEN HILL	2880	(08)80 87 4055	(08)80 87 4055
	T K Electronics	Unit 2 10 O'Hart Close	CHARMHAVEN	2263	(02) 43 92 0828	(02)43 93 1018
	TV Technologies	20 Marcia Street	COFFS HARBOUR	2450	(02)66 51 7366	(02)66 50 0152
	Coogee Electronic Service	261 Arden Street	COOGEE	2034	(02)93 15 8566	(02)66 50 0152
	Electronics 2000	Shop 3/190 Sharp Street	COOMA	2630	(02)64 52 4179	(02)64 52 4179
	Lachlan Valley TV	49 Vaux Street	COWRA	2794	(02)63 42 2189	(02)63 42 2189
	Greg's TV	2 Bingalong Street	DALMENY	2546	(02)44 76 7544	(02)44 76 7544
	Deniliquin Hi-Tech	44 Hardinge Street	DENILQUIN	2710	(03)58 81 1444	(03)58 81 1444
	Western Electronic Service	437 Hopkins Parade	DUBBO	2830	(02)68 82 3905	(02)68 82 3870
	Con Carr Retravision	126-128 Murray Street	FINLEY	2713	(03)58 83 1611	(03)58 83 2114
	Forbes TV & Video Repairs	132 Rankin Street	FORBES	2871	(02)68 52 2921	(02)68 52 2921
	Forster Electronic Services	Shop 15, Forster Tower, Wallis Street	FORSTER	2428	(02)65 54 5352	(02)65 54 5352
	V.J. & C.M. Davey TV &	137 Meade Street	GLEN INNES	2370	(02)67 32 2260	(02)67 32 2260
	Ray White Television Repairs	2 Taylor Street	GOULBURN	2580	(02)48 22 4050	
	Repairs & Spares	140 Fitzroy Street	GRAFTON	2460	(02)66 42 1911	(02)66 43 3961
	Griffith Home Appliance	94-98 Yambil Street	GRIFFITH	2680	(02)69 62 1826	
	S & K Electronics	111 Banna Avenue	GRIFFITH	2680	(02)69 62 2847	(02)69 64 7774
	Ron Burns Electrical	8 Hillcrest Road	GUNNEDAH	2380	(02)67 42 3299	
	Tele – Fridge Electronics	82 Conadilly Street	GUNNEDAH	2380	(02)67 42 0022	(02)67 42 3878
	Inverlec Electronics	Shop 1,20 Glen Innes Road	INVERELL	2360	(02)67 22 4522	(02)67 22 4522
	<b>Maxwell Electronics</b>	<b>106 Bath Road</b>	<b>KIRRAWEE</b>	<b>2232</b>	<b>(02)95 42 300</b>	<b>(02)95 42 3377</b>
	AVL Electronics	2/87 Bold Street	LAURIETON	2443	(02)65 59 6330	(02)65 59 6330
	Leeton Appliances	99 Grevillia Street	LEETON	2705	(02)69 53 4151	(02)69 53 4151
	Hans Electronic Services	147 Magellan Street	LISMORE	2480	(02)66 21 9311	(02)66 21 9711
	Robert Peatfield	2 West Street	MACKSVILLE	2447	(02)65 68 2867	(02)65 68 2867
	Mullumbimby TV Service	Shop 3 97-99 Stuart Street	MULLUMBIMBY	2482	(02)66 84 2335	(02)66 84 3554
	John Rice TV Service	13 Park Avenue	MURWILLUMBAH	2484	(02)66 72 3292	(02)66 72 3292
	Kaputar TV Service	27 Maitland Street	NARRABRI	2390	(02)67 92 1017	(02)67 92 1017
	Newcastle Quickfix/ J P Electronics	Shop 5, 468 Pacific Hwy	NEWCASTLE	2280	(02)49 45 4699	(02)49 45 5696
	<i>Name</i>	<i>Address</i>	<i>Service area</i>	<i>P C</i>	<i>Phone</i>	<i>Fax</i>
<b>NSW</b>	Videotel	Unit 1/17 Quinns Lane	SOUTH NOWRA	2541	(02)44 21 5250	(02)44 23 3280
	Ideal Electronics	145 Woodward Street	ORANGE	2800	(02)63 62 8270	(02)63 62 8270
	Parkes Sight 'n' Sound	67 Clarinda Street	PARKES	2870	(02)68 62 4475	(02)68 63 4209
	Vickery Sound	171 Brisbane Water Drive	POINT CLARE	2250	(02)43 23 3623	(02)43 23 1581
	Quickfix Repairs	118 Stafford Street	PENRITH	2750	(02)47 22 8550	(02)47 22 9949
	BJRAE Electronics	2/199 Adelaide Street	RAYMOND TCE	2324	(02)49 87 7032	(02)49 87 6194
	<b>QQ Electronics Pty Ltd</b>	<b>Unit 5, 14-38 Bellona Avenue</b>	<b>REGENTS PARK</b>	<b>2143</b>	<b>1300 883 229</b>	<b>(02)97 38 1311</b>
	Quickfix Repairs	Shop 17 West Market Street	RICHMOND	2754	(02)45 78 2111	(02)45 78 2021
	Tech 1 Electronic Repairs	Shop1/12 Sunset Ave	SHELL HARBOUR	2528	(02)42 97 5397	(02)42 97 5398
	Cherries Electronics	Unit 3, 8 Walter Street	SINGLETON	2330	(02)65 71 2488	(02)65 71 2488
	Vidotel Video, TV & Monitor	232 Marius Street	TAMWORTH	2340	(02)67 61 3788	(02)67 61 3388
	Peel Television Service	1 Macquarie Street	TAMWORTH	2340	(02)67 66 3928	(02)67 66 9932
	Colour Fix TV & Video Service	172 Bridge Street	TAMWORTH	2340	(02)67 65 5539	(02)65 62 0561
	Hawkins Electronic Service	94 Manning Street	TAREE	2430	(02)65 52 2288	(02)65 52 4059
	Household Electronics	3/39 Shearwater Drive	TAYLORS BEACH	2316	(02)49 84 2060	(02)49 19 0355
	That Repair Shop	122 Fitzmaurice Street	WAGGA WAGGA	2650	(02)69 21 5200	(02)69 25 9491
	Schuberts Electronics	53 Hastings Street	WAUCHOPE	2446	(02)65 85 1533	(02)65 85 3816
	ILLAWARRA Electronics Solution	Shop 3, 60 Lakeside Drive	WOLLONGONG	2530	(02)42 61 9234	(02)42 61 9227
	United Television Service Pty Ltd	390 Keira Street	WOLLONGONG	2500	(02)42 28 4555	(02)42 26 3453

	<i>Name</i>	<i>Address</i>	<i>Service area</i>	<i>P C</i>	<i>Phone</i>	<i>Fax</i>
<b>QLD</b>	McMahon Electrical Traders	23 Mabel Street	ATHERTON		4883 (07)40 91 1788	(07)40 91 1741
	Beerwah Electronics	Peachester Road	BEERWAH		4519 (07)54 94 0466	(07)54 94 0416
	BTronics	Shop 1/176 Callide Street	BILOELA		4715 (07)49 92 6566	(07)49 92 5266
	Bremer Television Service	36 Station Road	BOOVAL		4304 (07)32 82 3593	(07)32 82 1214
	Bowen Retravision (Northern Elect)	40 Bowen Street	BOWEN		4805 (07)47 86 1633	(07)47 86 2257
	<b>Telefix</b>	<b>Unit 9, 19 Lensworth Street</b>	<b>COOPERS PLAINS</b>		<b>4108 (07)33 23 2700</b>	<b>(07)33 23 2730</b>
	Nielsons Radio & TV Service	68 Gavin Street	BUNDABERG		4670 (07)41 53 1377	(07)41 53 1534
	A1 Sound & TV Service	14 Gloucester Road	BUDERIM		4556 (07)54 45 4777	(07)54 45 1311
	Caboolture Video & Microwave	4/125 Morayfield Road	CABOOLTURE		4510 (07)54 95 3477	(07)54 95 3477
	Digital TV Service	197 Lyons Street	CAIRNS		4870 (07)40 51 1711	(07)40 51 1771
	Garrows Video & TV Service	4/74 Omrah Avenue	CALOUNDRA		4551 (07)54 91 3238	(07)54 91 7457
	Charleville Radio & TV	14 Wills Street	CHARLEVILLE		4470 (07)46 54 1633	(07)46 54 2266
	Jab Electronics	Cnr. Ruby & Egerton Streets	EMERALD		4720 (07)49 87 7770	(07)49 87 7772
	Precise Electronics	1 / 4 Northview Street	GOLD COAST		4218 (07)55 75 1377	(07)55 72 4689
	Ready Electronics	Shop 3/1 Tibbing Street	GOLD COAST		4211 (07)55 96 6359	(07)55 02 2734
	Tweed Television	Shop 3/12 Machinery Drive	GOLD COAST		2486 (07)55 24 4483	
	Gympie Electronic Service	18 Barter Street	GYMPIE		4570 (07)54 82 7888	(07)54 83 7811
	Lloyd Lawrence Electronics	5 Torquay Road	HERVEY BAY		4655 (07)41 24 3787	(07)41 24 3787
	Professional VCR Sales Service	90 Mourilyan Road	INNISFAIL		4860 (07)40 61 4720	(07)40 61 4720
	Dunstans SBTV	37 Kingaroy Street	KINGAROY		4619 (07)41 62 1547	(07)41 62 2343
	Nev Robert Electronics	31 Hart Street	MACKAY		4740 (07)49 57 6498	(07)49 51 3737
	Sunland TV Service	Unit 5 Centre One, Norval Court	MAROOCHYDORE		4558 (07)54 43 6444	(07)54 43 6464
	<b>Telefix</b>	<b>Unit 1, 96 Aerodrome Road</b>	<b>MAROOCHYDORE</b>		<b>4558 (07)33 23 2700</b>	<b>(07)33 23 2730</b>
	Sunland TV Service	Shop 4, 54 Rene Street	NOOSAVILLE		4566 (07)54 74 2101	
	Cumners Electronics	Shop 4, 131 Old Pacific Highway	OXENFORD		4210 (07)55 73 5250	(07)55 73 5403
	N & M TV & Video Service	50 Shiert Street	PITTSWORTH		4356 (07)46 93 2886	(07)46 93 2886
	C.Q. Video & TV Service	227 Berserker Street	ROCKHAMPTON		4701 (07)49 28 8811	(07)49 28 2698
	Matthew's TV & Video Service	176 Main Street	ROCKHAMPTON		4701 (07)49 28 5377	(07)49 28 5608
	Top Beat Entertainment & Elec	97A Folkestone Street	STANTHORPE		4380 (07)46 81 0681	(07)46 81 0682
	T.I. TV Repairs	11 Summer Street	THURSDAY ISLAND		4875 (07)40 90 2139	(07)40 69 2577
	Clark & Webb TV & Radio	14 Grange Street	TOOWOOMBA		4350 (07)46 32 7290	(07)46 32 9244
	Downs Radio & TV Service (DR TV)	35 Dent Street	TOOWOOMBA		4350 (07)46 32 1044	(07)46 32 1224
	Townsville Electronics	197 Ingham Road	TOWNSVILLE		4810 (07)47 75 7774	(07)47 79 6867
Top Beat Entertainment & Electrical	46 Wood Street	WARWICK		4370 (07)46 61 2690		

	<i>Name</i>	<i>Address</i>	<i>Service area</i>	<i>P C</i>	<i>Phone</i>	<i>Fax</i>
<b>NT</b>	Electrovision Services	65 Smith Street	ALICE SPRINGS		870 (08)89 52 7355	(08)89 53 1810
	The Television Workshop	Shop 4 Elder St Centre	ALICE SPRINGS		870 (08)89 52 8555	(08)89 52 5557
	Dartronix	Shop 2, 291 Trower Road	DARWIN		810 (08)89 45 7799	(08)89 45 7733
	New Age Electronics	Unit 1/21 Delatour Street	DARWIN		810 (08)89 48 1755	(08)89 48 1766
	Eletech Service	13 Sandalwood Ave	NHULUNBUY		880 (08)89 87 3828	(08)89 87 3828

	<i>Name</i>	<i>Address</i>	<i>Service area</i>	<i>P C</i>	<i>Phone</i>	<i>Fax</i>
<b>SA</b>	<b>TCS (Total Care Services)</b>	<b>62 Leader Street</b>	<b>ADELAIDE</b>		<b>5035 (08)83 51 1044</b>	<b>(08)83 51 1043</b>
	E.K. Dunstan & Co	255 Main Street	CLARE		5453 (08)88 42 2144	(08)88 42 3942
	Peter's Electronics	25 Lorna Street	LOXTON		5333 (08)85 84 6920	(08)85 84 6920
	Gambier Sound& Vision Repairs	16-18 Watson Tce	MT GAMBIER		5290 (08)87 23 3955	(08)87 23 3855
	Portside Technologies	28 Hallet Place	PORT LINCOLN		5606 (08)86 82 1500	
	Pirie Antenna & TV	283B Senate Road	PORT PIRIE		5540 (08)86 32 2565	(08)86 33 0091
	Riverland Electronics Services	113 Renmark Avenue	RENMARK		5341 (08)85 86 5600	(08)85 86 5533
	Victor Electronic Service	44 Torrens Street	VICTOR HARBOR		5211 (08)85 52 1471	(08)85 52 1098
	Eyre Electronics	15B Forsyth Street	WHYALLA		5600 (08)86 45 4764	(08)86 45 5576

	<i>Name</i>	<i>Address</i>	<i>Service area</i>	<i>P C</i>	<i>Phone</i>	<i>Fax</i>
<b>TAS</b>	Somerset Electronics	16 Douglas Street	EAST DEVONPORT		7310 (03)64 27 0016	
	D.J. Hingston	95 James Road	DEVONPORT		7310 (03)64 27 2145	(03)64 27 2145
	Integrated Components	54A Albert Road	HOBART		7009 (03)62 78 1932	(03)62 78 8387
	K.T. National Electronics	1 Hobart Road	LAUNCESTON		7249 (03)63 44 5665	(03)63 43 0466

	<i>Name</i>	<i>Address</i>	<i>Service area</i>	<i>P C</i>	<i>Phone</i>	<i>Fax</i>
<b>VIC</b>	Border Video & TV Service	362 Griffith Road	ALBURY	2641	(02)60 40 2229	(02)60 40 2184
	Greene's Television Services	149 Hummfray Street	BALLARAT	3350	(03)53 32 6256	(03)53 32 7597
	Ted Rivett Services	145 Creswick Road	BALLARAT	3550	(03)53 32 6371	(03)53 33 4002
	Proud's Hi Fi	78- 80 Pall Mall	BENDIGO	3550	(03)54 42 2722	(03)54 42 2522
	All – Tronics	11 Edward Street	BENDIGO	3550	(03)54 42 7000	(03)54 41 7502
	<b>Sound &amp; Vision TV Service</b>	<b>4 Terracotta Drive</b>	<b>BLACKBURN</b>	<b>3130</b>	<b>(03)9878 7144</b>	<b>(03)98 78 7344</b>
	B M Tronics	197 Murray Street	COLAC	3250	(03)52 32 1504	(03)52 32 1935
	Badrocks Video & Hifi Service	22/24 Barrumundi Avenue	COWES	3922	(03)59 52 1752	(03)59 52 1795
	T & C Electronics Service	31 Pegleg Road	EAGLEHAWK	3556	(03)54 46 3000	(03)54 46 3022
	Echuca TV & Video Service	1/7 Mitchell Street	ECHUCA	3564	(03)54 80 7874	
	Central Appliance Service	222 Moorabool Street	GEEELONG	3200	(03)52 22 1418	(03)52 22 1418
	RTD Services Pty Ltd	25-29 Fairlie Street	GEEELONG	3215	(03)52 78 9766	(03)52 78 3545
	Linke Electrical Repairs	82 Lonsdale Street	HAMILTON	3300	(03)55 72 5788	(03)55 72 4090
	Frank Ritchie Electrical P/L	9 Victoria Street	KERANG	3579	(03)54 52 2908	(03)54 52 2908
	Harold Hurren	26 Fitzroy Street	KILMORE	3764	(03)57 82 1327	(03)57 82 1487
	Soundwave Electronics	2B Holt Street	LEONGATHA	3953	(03)56 62 3665	(03)56 62 3665
	Peninsula VCR Repairs	1/8 Virginia Street	MELBOURNE	3931	(03)59 75 0800	(03)59 76 2300
	Ferguson Electronics	116 Orange Avenue	MILDURA	3500	(03)50 23 5846	(03)50 21 2690
	Bensi TV Electrical Pty. Ltd.	128 Nicholson Street	ORBOST	3888	(03)51 54 1454	(03)51 54 1344
	G & R Video & TV Services Pty.	24 Dunkirk Avenue	SHEPPARTON	3630	(03)58 21 0258	(03)58 21 8187
	Swantronics	45 Campbell Street	SWAN HILL	3585	(03)50 33 1633	(03)50 33 1287
	Earl & Becker	4-26 Shakespeare Street	TRARALGON	3844	(03)51 74 8454	(03)51 74 8454
	BM Tronics	459 Raglan Parade	WARRNAMBOOL	3280	(03)55 61 6622	(03)55 62 8388
	Tellycare (Nugents)	105 Queen Street	WARRAGUL	3820	(03)56 22 1102	(03)56 22 1102
	John B. Electronics	Shop 94 High Street	WODONGA	3690	(02)60 56 1066	(02)60 56 2443

	<i>Name</i>	<i>Address</i>	<i>Service area</i>	<i>P C</i>	<i>Phone</i>	<i>Fax</i>
<b>WA</b>	AB Video	50 Cockburn Road	ALBANY	6330	(08)98 42 1270	(08)98 42 2728
	Albany TV Service	Shop 8 35-37 Campbell Road	ALBANY	6330	(08)98 41 1573	(08)98 42 5958
	Camtec Bunbury	1/31 Denning Road	BUNBURY	6230	(08)97 91 7277	(08)97 91 7377
	Excel Electronics	3 Newman Court	BROOME	6725	(08)91 44 1266	(08)91 44 1266
	Eclipse Kimberley	Unit 4, 20 Hunter Street	BROOME	6725	(08)91 92 2832	(08)92 92 8069
	Elricks TV Service	62 Spencer Street	BUNBURY	6230	(08)97 21 4047	(08)97 21 1161
	Busselton TV & Video	65B Strelley Street	BUSSELTON	6280	(08)97 54 4457	(08)97 54 4824
	Electronic Plus	Unit 3/11 Egan Street	CARNARVON	6701	(08)99 41 3690	(08)99 41 3660
	Esperance Communications	33 Norseman Road	ESPERANCE	6450	(08)90 71 3344	(08)90 71 4545
	Bird Electronics	14 Abraham Street	GERALDTON	6530	(08)99 64 1631	(08)99 21 7584
	Geraldton Radio & TV Service	26 Anzac Terrace	GERALDTON	6530	(08)99 64 2777	(08)99 64 2776
	Oz West Electronics	6/200 Winton Road	JOONDALUP	6027	(08)93 00 1066	
	Printek Electronics	1 Lesueur Drive	JURIEN BAY	6516	(08)96 52 1664	(08)96 52 1664
	Kalgoorlie Electronics	395 Hannan Street	KALGOORLIE	6430	(08)90 21 1420	(08)90 21 1420
	J & P Electronics	3/88 Albany Hwy	KOJONUP	6395	(08)98 31 1991	(08)98 31 1991
	Tuckerbox Retravision	White Gum Street/P.O. BOX 941	KUNUNNURRA	6743	(08)91 68 1100	(08)91 68 2491
	Waytec Electronics	Unit 3, 10 Thornborough Road	MANDURAH	6210	(08)95 82 0882	(08)95 82 0352
	Manjimup TV Service	88 Giblett Street / P.O. BOX 370	MANJUMUP	6258	(08)97 71 1598	(08)97 72 4025
	Chris's TV & Satellite	66 Barrack Street	MERREDIN	6415	(08)90 41 1484	(08)90 41 1484
	G & J Suckling Radio & TV	1 Hale Street	NARROGIN	6312	(08)98 81 2148	(08)98 81 3129
	Proton	21A Charles Street	NORTHAM	6401	(08)96 22 3168	(08)96 22 3168
	<b>TEAC Perth Service Centre</b>	<b>273 Great Eastern Highway</b>	<b>PERTH</b>	<b>6104</b>	<b>(08)94 79 6499</b>	<b>(08)94 79 6544</b>
	Charles Hunt Electronics	25 Brodie Court	ROCKINGHAM	6171	(08)63 63 5593	(08)95 24 2890
	S & R TV Service	Unit 7/42 Crompton Road	ROCKINGHAM	6168	(08)95 92 1130	(08)95 92 3685

**TEAC<sup>®</sup>**

**TEAC CUSTOMER CARE CENTRE (TCCC)**

**Free call: 1800 656 700**

**Between Monday to Friday – EST 9AM to 5PM**