



TXF-150

FM TRANSMITTER

**Operating
Manual**

Introduction

You've already unpacked it, haven't you? You've unpacked it and plugged it in and turned it on and fiddled with the knobs. No? Okay, good. Please take a few minutes to read the manual and familiarize yourself with your new Technalogix FM power amplifier or transmitter.

We believe that this user manual, the Quickstart package (Final Inspection Report, Wiring Hookup, and Block Diagram), and of course our equipment, should be everything you need to get on the air with a superb audio signal. We understand that a capable and confident user will get the most out of our product and we have made every attempt to educate readers of all technical levels. If there is something that is not clear, or you require further information, please do not hesitate to contact us and we'll be glad to help out.

Technalogix Ltd.
#4, 8021 Edgar Industrial Place
Red Deer, Alberta, Canada
T4P 3R3
Phone: 403.347.5400
Fax: 403.347.7444
URL: www.technalogix.ca
Email: technical@technalogix.ca
sales@technalogix.ca

All information that is specific to your unit is contained within the Quickstart package (Final Inspection Report, Wiring Hookup, and Block Diagram) included in the shipped equipment container. This Quickstart package summarizes performance specifications, provides wiring hookup details, and outlines specific components found in the system.

We truly appreciate that you have chosen us as your RF equipment supplier. Happy transmission!

General Safeguards

This section is written as a general guide to keep all five fingers on your hand and is intended for those having previous knowledge and experience with these kinds of equipment. It is not intended to contain a complete statement of all safety precautions, which should be observed by personnel using this or other electronic equipment.

Documentation

Read, retain and follow instructions before operating the equipment. There is a lot of useful information in the manual, and besides, we spent a lot of time writing it!

Environment

To reduce the risk of fire or electric shock, do not expose this equipment to rain, moisture, or rye and sodas at the company Christmas party. Refer all servicing to qualified service personnel.

Servicing

Do not attempt to service this equipment yourself as opening or removing covers can result in a warm tingly feeling and will void the warranty. Refer all servicing to qualified service personnel.

Safety and First Aid

Personnel engaged in the installation, operation, maintenance, or servicing of electronic equipment are exposed to the hazard of high voltage. It is imperative that all safety regulations and precautions are consistently observed. Knowledge of first aid procedures is recommended. The following information is presented as a reference only. The user should ensure that they are trained in proper first aid and the necessary precautions, which may not be contained in this manual, are followed.

- At all times, avoid placing any part of the body in series between ground and circuit points, whether power is on or off.
- Dangerous voltage may be present in equipment even though power is off. Do not open the cabinet. Refer servicing to qualified service personnel.
- It is the duty of all personnel to be prepared to give adequate emergency first aid treatment and thereby prevent avoidable loss of life.
- There are three principle degrees of burns, recognizable as follows:
 - a first-degree burn reddens the skin.
 - a second-degree burn blisters the skin.
 - a third degree burn chars the flesh and frequently places the victim in a state of shock accompanied by respiratory paralysis.
- Respiratory paralysis can cause death by suffocation within seconds. It is imperative that the approved methods of artificial respiration are initiated immediately and continue until the victim's breathing is normal.
- A muscular spasm of unconsciousness may render the victim unable to break free of the electric power. If this is the case, turn the power off immediately. Do not touch the victim or you may share the same predicament!
- If the power cannot be turned off immediately, very carefully loop a dry rope, article of clothing, length of strong cloth or a rolled-up newspaper around the victim and pull the victim free of the power source. Carefully avoid touching the victim or clothing.
- Once free of the power source, the victim must be placed in a reclining position and covered with a blanket or newspapers to keep warm. At the first opportunity, enlist help in summoning a doctor. If a doctor cannot be summoned, transport the victim to the doctor or a hospital. Be sure the victim is kept well covered and warm while awaiting professional treatment.

Operating Safeguards

Load Impedance

It is a known fact that our FM equipment enjoys 50-ohm load impedances. So much so, that it is imperative you maintain 50-ohm impedances throughout your system. In return, your equipment will provide you with maximum power transfer to the antenna and decreased reflected power heading back towards the amplifier pallets, reducing the amount of magic smoke that gets let out of the equipment. Before anything is turned on, ensure that there is a 50-ohm path from the output of each stage to the input of the next, all the way to the antenna.

Operating Warnings

Our FM equipment is designed to reliably generate a specific RF output power level. Failing to adhere to overdriven amplifier, high reflected power, and high temperature, and other warnings can decrease the reliability of your system, and frankly, makes our repair department busy and grumpy. If you need to transmit to a little larger coverage, you are better off increasing antenna gain, and more importantly, antenna height above average terrain. On FM broadcast frequencies, insufficient antenna height puts an upper limit on your range, regardless of power levels, as the distance from your antenna to the radio horizon is limited.

Terms of Sale

Sales by Technalogix Ltd. (“Seller”) are made only on terms which are contained in this policy. Seller hereby gives notice of its objection to any different/additional terms and conditions. All sales are expressly conditional upon Buyers’ assent to the terms and conditions set forth below. These terms and conditions may be modified/ supplemented only by written document signed by authorized representative of the Seller. These terms and conditions supersede any prior and/or contemporaneous agreements/correspondence between Buyer and Seller. Any order received and accepted by Seller shall be construed as acceptance of Seller’s offer to sell its products to the Buyer in accordance with terms and conditions of sale set forth herein. No waiver, whether express or implied, by Seller of any of the terms or conditions hereof shall be deemed a continuing waiver or trade custom between parties, but shall apply solely to the instance to which the waiver is directed.

Ordering Information

All orders must be in writing and/or accompanied by a Purchase Order. A minimum down payment is required with all orders. No orders are considered an order until the payment has been made.

Pricing Policy

All prices are FOB shipping point and prices do not include freight, handling, and insurance. All prices published/quoted by Seller may be changed at any time without notice. Unless otherwise specified, written quotations expire 30 days from date issued and subject to change/termination by notice during this period.

Taxes

Prices for all products do not include any sales, use, excise or other taxes. Buyer agrees to pay all applicable taxes, duties and other fees on product and services ordered. If Buyer claims an exemption from any tax, Buyer shall submit to Seller the appropriate exemption certificates.

Shipping

Shipping is the responsibility of the Buyer. This includes all freight, customs and brokerage charges, duties, and insurance.

Terms of Payment

Seller will provide credit terms to Buyer at its discretion. Such terms are subject to change at all times. If credit is provided, Seller will invoice Buyer on the date the product is ordered. Such invoices will be due and payable net thirty (30) days from the date of invoice, subject to credit is not established or maintained, terms shall be net cash on or prior to the Delivery Date. Seller reserves the right, at its sole discretion at any time to revoke any credit previously extended. Past due accounts shall be charged two percent (2%) per month, or the highest rate permitted by Alberta law, whichever is less, and will be added to the outstanding balance. In the event Buyer defaults on the payment, Buyer shall be liable for all collection costs, including reasonable attorney's fees and costs. Non-payment of past due accounts will result in a lien against parts and all subsequent assemblies or products that our components are in. Goods remain the property of Seller until invoice is paid in full.

Changes and Cancellation

Purchase orders that have been accepted by Seller may not be changed/cancelled, in whole or part, without written Seller consent. All changes must be included in change order reflecting purchase order and submitted to the Seller. All other changes will not be accepted/acknowledged. Changes may affect delivery dates. Expenses incurred because of changes shall be charged to Buyer. Buyer will be liable for Seller's costs incurred, plus a reasonable profit, for the portion of work terminated, in accordance with generally accepted accounting principles, together with cancellation charges. Orders for standard product may be changed by Buyer, with no penalty to Buyer, provided that Buyer provides Seller notification at least 30 days prior to scheduled ship date. Order changes received within 30 days of scheduled ship date may be subject to an order change charge; a schedule detailing these charges will be forwarded to Buyer when Buyer's change order is acknowledged. In no event can any aspect of the order be changed after the product shipment has occurred. Custom orders may be cancelled by Buyer, provided that Buyer pays Seller for completed work allocated to Buyer's order at time of termination of the work at selling price and all costs for work-in-progress and costs resulting from cancellation and reasonable profit therein. Specific cancellation charges dependent on the type of custom product ordered. A schedule detailing these charges will be forwarded to Buyer when Buyer's cancellation fee of up to 100% of the order, depending on the stage of completion of the order at the date the cancellation or revised is accepted.

Custom Products Policy

Custom items are not returnable. Items other than “off the shelf” products are considered custom and are products/materials which have been altered, amended and customized to your order, and not resalable.

Returns

Product return without written authorization by Seller will not be accepted. Returns accepted only with a valid Return Material Authorization (RMA). To receive authorization for product return, call Seller. There is a standard 25% restocking cost assessed on most returns. All returned products (non-repair) must be unused, and in original condition. No refund/credit given for damaged products. We do not accept postage-due/ C.O.D. packages at any time.

Excusable Delay

Seller shall not be liable for any loss or damage resulting from any delay in delivery or failure to deliver which is due to any cause beyond Seller’s control, including, without limitation, acts of nature, unavailability of supplies or sources of energy, riots, wars, fires, floods, epidemics, lockouts, strikes and slowdowns, delays in delivery by supplies, or acts or omissions of the Buyer. The Buyer shall be liable for stage charges, including but not limited to all third party costs and expenses incurred by Seller, in holding or storing products for the Buyer or at the Buyer’s request.

Assignment

Buyer shall not assign any duties nor assign any order or any interest therein without written consent of the Seller. Any such actual or attempted assignment shall entitle Seller to cancel the order upon written notice to the Buyer.

Installation

Seller assumes no obligation to install any product sold to place any products in working order at Buyer’s premises and not responsible for freight damage.

Validity of Separate Clauses

If any provisions of this agreement shall be held invalid, illegal, or unenforceable, the validity, legality or enforceability of the remaining provisions shall not be affected or impaired thereby.

Warranty

Technalogix products have been completely tested and found to meet specifications and be in proper operating condition. Technalogix-manufactured products are warranted to be free from defects in materials and workmanship for a period of two years from the date of shipment. Products sold through, but not directly manufactured by Technalogix, carry the original manufacturer's warranty. Seller will not be liable for damages of whatever nature arising out of or in connection with the equipment or its use thereof. Technalogix does not assume responsibility for injury or damage resulting from the practices of untrained or unqualified personnel in the handling of this equipment and does not include misuse, neglect or accident, incorrect wiring and/or improper installation, unauthorized repairs, modifications or use in violation of instructions issued by Seller, incidental or consequential damages as a result of any defect, reshipment cost or insurance of the unit or replacement units or parts, acts of nature, damages due to AC or DC power supplied by customer to power the equipment (see installation recommendation for surge protection), or acts of terrorism. Seller agrees, at our option, to remedy warranted defects or furnish a new part in exchange for any part of unit which, under normal installation, use and service, becomes defective. The user pays for transportation costs to and from repair facility. If you require on-site service, the cost to you will be \$800.00 US per 8-hour day plus air fare, meals, and transportation charges for personnel and equipment.

Principle of Operation

The internal FM exciter found inside FM transmitter enclosures accepts analog, digital or MPX audio signals and modulates them onto an FM carrier. The analog signal can be either mono or stereo (both included as standard), while the digital inputs are accepted on AES3, S/PDIF optical (Toslink), or S/PDIF coaxial inputs. Also included on the Exciter circuit board are amplifier stages to increase the modulated level from a few dBm up to several watts.

The RF power amplifier is designed to take a modulated FM carrier from the Exciter (typically less than 30-watts depending on transmitter power level), and amplifies the carrier to a level that is suitable for transmission through an antenna, cavity, or alternative load. The power amplifier feeds this load through an inline wattmeter and transmission line. For broadcast and over-the-air amplifier systems, the pattern of the antenna then dictates the range and coverage area.

The amplification is accomplished by one or many amplifier pallets internal to the power amplifier system. If there is more than one amplifier pallet stage, then the first pallet acts as a driver feeding Intermediate Power Amplifiers (IPAs) and/or final stage pallets. If multiple final pallets are required, then a splitter and combiner are also required before and after the final stages.

Technalogix manufactures FM amplifiers and transmission systems suitable for 88.0 to 108.0 MHz. Custom frequencies are available upon request if you require carriers outside this range, including audio for VHF applications and other unique requirements.

The RF amplifiers utilize readily available RF components wherever possible, thus enhancing the serviceability of the equipment. The amplifier modules are stable for high reliability and long service life and feature ultra linear amplification and individual channel RF output filtering, unless ordered otherwise.

The Block Diagram is included with the Quickstart package to illustrate the specific component flow of the RF amplifier system and to provide specific configuration and model information.

Installation

This section contains installation recommendations, unpacking, inspection, and installation instructions for the power amplifier or transmitter. We are sure that you are chomping at the bit to install your new system, so we recommend that you read the following sections very carefully.

Building Recommendations

The quality of the building is of great importance if you are to expect long life and continued performance from the power amplifier or transmitter. The building must be clean, dry, temperature controlled and secure. Don't forget to allow space in the building for any additional racks to house test equipment, a workbench area, line regulating transformers, ladders, equipment and parts storage, first aid kit, emergency generator if used, as well as heating and cooling devices that may be unique to your installation. A beer fridge is optional. A sloping roof will tend to develop leaks less rapidly. The building should be well roofed with good material. The cooling load will be lowered with reflective or light colored roofing material.

Electrical Service Recommendations

Technalogix recommends that a qualified, licensed local electrician be consulted for the required electrical service. We suggest local electricians because:

- The personnel knows the local codes
- The personnel can be on site readily
- You are apt to get better overall support if you give what business you can to local suppliers

Technalogix recommends that proper AC line conditioning and surge suppression be provided on the primary AC input to the power amplifier or transmitter. If DC is used as a source, a DC-DC converter is recommended to provide isolation between the supply and the load. All electrical service should be installed with your national electrical code in your area, any applicable provincial or state codes, and good engineering practice. Special consideration should be given to lightning protection of all systems in view of the vulnerability of many sites to lightning. Lightning arrestors are recommended in the service entrance. Gas Discharge Tubes (GDT) may help in preventing lightning, which was forecast for another day, from creating a bad day. Straight and short grounds are recommended. The electrical serviced must be well grounded. Do not connect the unit to an open delta primary power supply, as voltage fluctuations could harm the unit. Branch your circuits. Do not allow your lights, your workbench plugs, and your transmitting or translating equipment to operate on one circuit breaker. Each amplifier or transmitter should have its own circuit breaker, so a failure in one does not shut off the whole installation.

Antenna and Tower Recommendations (if applicable)

Your preliminary engineering workgroup should establish your antenna and tower requirements, if applicable, both for receiving and transmitting antennas. Construction of sturdy, high quality antenna/tower systems will pay off in terms of coverage of your service area, the overall quality and saleability of your radiated signal, and reduced maintenance expenses. Technalogix provides complete turnkey antenna systems if needed. If your site is serving as a translator, your receiving antenna should be in line of sight to the originating station all year round. The foliage will change with season. Transmitting antennas can enhance or seriously impair the amplifier or transmitter output.

The selection, routing, and length of coaxial cable are extremely important in the installation. If there is a 3 dB line loss in the cable between your unit's output and the transmitting antenna, the unit will only deliver half power. Buy the best cable you can obtain, route it via the shortest way to the antenna, and keep it straight. Do not form it into sharp bends on its way. Do not use any more cable fittings for the installation than absolutely necessary. All cautions here apply equally to all coaxial cables in the system - input and output.

Pay attention to radial ice accumulation when designing the transmission system. It is not uncommon for at least an inch of ice to build up on a tower or antenna in some locations. This in turn significantly increases the weight, cross section, and wind loading of the system, not to mention creating issues from reflective power.

Attaching the transmission line to the tower is crucial to maintain a safe and reliable operation. Nylon wire ties and electrical tape will breakdown in the sunlight and ultimately fail, creating a potentially dangerous situation. It is important to use proper clamps and hoisting grips and also ensure that the transmission line is grounded to the tower in several locations. When high currents flow through the tower in the event of lightning strikes, some of that current will flow through the outer conductors of the transmission lines. Due to the resistance difference between the steel tower and copper transmission line, a significant voltage can be developed, often resulting in arcing between the outer jacket and outer conductor, thus pitting the conductor.

Preventative maintenance is crucial in ensuring that safety is maintained. Specifically, check that transmission line grounds are tight and are not missing any hardware. Frequently inspect support clamps or spring hangers. Consider investing in an ice break, if you haven't already done so, as shards of falling ice can damage the transmission line – and if it is going to happen, it will happen at an important time. Check the tower light photocells and conduit.

The better-known tower manufacturers offer complete technical and safety documentation with their towers. Be sure that you have this information as it regards wind loading, guying, etc. The best-designed antenna system will function poorly if shortcuts and compromises are used during installation. Follow the manufacturer's instructions exactly, along with any engineering data prepared for the site. Be absolutely safe and certain about this aspect as human lives may be at stake.

Shelter Security

The FCC requires that the equipment be secure from entry or control by unauthorized persons, and that any hazardous voltages or other dangers (including most tower bases) be protected by locks or fences as necessary to protect personnel and prevent unauthorized tampering or operation. Security of the building further implies that it be secure from wildlife. Use sturdy construction materials, including sheet metal if necessary. Holes around conduit, cable, and other similar entry points should be stuffed with steel wool and caulked to prevent entry of wildlife. Other features of security for your shelter may include its location with respect to the prevailing wind conditions. Locations leeward of some natural topographical feature will prevent wind damage and snowdrifts. Check the soil runoff conditions that may slow or hasten wind or water erosion and other concerns that may be unique to your location.

Heating and Cooling Requirements

The environment's temperature will contribute greatly to the length of the power amplifier's or transmitter's life. Technalogix recommends that the building's filtered air intake must have capacity for all air-flow in the building plus an additional 20%. Keep the intake below the roofline to avoid intake of solar heated air. Please ensure that the intake and exhaust areas are on the same side of the building to avoid pressure differentials during windy conditions. Also, do not position intake near exhaust's preheated air. If air conditioning is required to cool the shelter, discuss the situation with a qualified HVAC technician. Under average conditions, 12,000 BTUs will cool approximately 500 square feet to a comfortable level.

The fans internal to the enclosures help cool the components. The specific fan voltages and part numbers are listed in the Block Diagram included with the Quickstart package.

Unpacking and Inspection

Check the outside of the container. Carefully open the container and remove the power amplifier or transmitter and any accessories. Retain all packing material that can be reassembled in the event that the equipment must be returned to the factory.

Exercise care in handling equipment during inspection to prevent damage due to rough or careless handling.

Visually inspect the enclosure of the power amplifier or transmitter for damage that may have occurred during shipment. Check for evidence of water damage, bent or warped chassis, loose screws or nuts, or extraneous packing material in connectors or fan failures. Inspect all connectors for bent connector pins. If the equipment is damaged, a claim should be filed with the carrier once the extent of the damage is assessed. Technalogix cannot stress too strongly the importance of immediate careful inspection of the equipment and subsequent immediate filing of the necessary claims against the carrier if necessary. If possible, inspect the equipment in the presence of the delivery person. If the equipment is damaged, the carrier is your first area of recourse. If the equipment is damaged and must be returned to the factory, phone for a return authorization number. Claims for loss or damage may not be withheld from any payment to Technalogix, nor may any payment due be withheld pending the outcome thereof. Technalogix cannot guarantee the carrier's performance.

Panel Connections

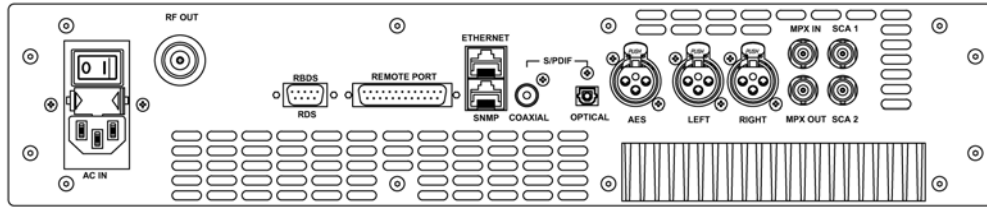

- AC IN:** Single phase AC input to feed internal AC/DC switching power supplies. Check with factory as not all power supplies are universal 110/220V.
- RF OUT:** FM modulated RF carrier output (N female or 7-16 DIN female)
- RBDS/RDS:** Configuration and control of RBDS/RDS encoder in transmitter accomplished through RS232 (female) connector.
- REMOTE PORT:** Parallel parameter interface (DB25 female)
- ETHERNET:** Remote control and monitoring via Ethernet (RJ45 jack)
- SNMP:** Simple Network Management Protocol (SNMP) remote control and monitoring (RJ45)
- S/PDIF COAX:** Digital audio input, Sony/Phillips Digital Interface, coaxial (RCA female)
- S/PDIF OPTICAL:** Digital audio input, Sony/Phillips Digital Interface, optical (Toslink female)
- AES (digital):** Digital audio input, AES/EBU professional audio interface (XLR female)
- LEFT (analog):** Analog audio input, left channel, (XLR female)
- RIGHT (analog):** Analog audio input, right channel, (XLR female). For Mono operation, use the Right input.
- MPX IN:** External MPX input. Used when external stereo encoders or processors present. (BNC female)
- MPX OUT:** MPX output signal from exciter. Used for external processing. (BNC female)
- SCA1/SCA2:** Input connection from SCA generator or source, intended for 60 to 99 kHz. Typically modulated to 10%, or 7.5 kHz deviation.

Initial Hook Up

1. Ensure that the antenna has been swept and, ideally, has a return loss of greater than 20dB (VSWR = 1.2:1). This should be done before connecting the antenna cable to the system's output. The power amplifier's control system allows the user to change the VSWR trip point up to a maximum level of 1.8:1, unless a custom VSWR protection system has been requested. Strive for the lowest possible return loss to maximize transmission distance and improve operating performance. Unless requested otherwise at the time of purchase, VSWR levels between the trip point set by the user and 1.8:1 (or custom VSWR trip point) will cause a fold back in power. VSWR levels past 1.8:1 (or custom VSWR trip point) will cause the system to shut down or fold back with attenuation to avoid damage.
2. Place the amplifier in its permanent location near a receptacle supplying the required AC or DC mains voltage.
3. Place an appropriate AC or DC power line protector, conditioner, and/or surge suppressor across the supply line. This small investment is highly recommended to protect the equipment from power surges and spikes (not covered by warranty).
4. Install a lightning surge arrestor or Gas Discharge Tube (GDT) on the coax near the antenna to protect the amplifier. This small investment is highly recommended to protect the equipment from lightning (not covered by warranty).
5. Connect the transmitting antenna cable to the RF OUT female connector on the PA enclosure's RF output. On units that have a separate filter or filter/power supply enclosure after the power amplifier enclosure, ensure to connect the transmitting antenna cable on the last enclosure in the chain to the RF Out and connect the RF coaxial between the power amplifier and the second enclosure in the chain. The system must be loaded into a 50-ohm load before any power is turned on for over-the-air systems. The Wiring Hookup is included in the Quickstart package included in shipping and visually summarizes the aforementioned information.

6. Connect the desired audio source connection, analog mono or stereo, digital audio, or MPX. Subcarrier signals can be connected to the SCA1 or SCA2 BNC connectors.
7. Connect additional control/monitoring cables if desired. SNMP or Ethernet should be connected to the lower RJ45 on the back panel. Remote port connections are made to the DB25 connector and the internal RDS is controlled by RS232 on the DB9 connector.

At this stage, the system is set up and ready to do a preliminary start up, as outlined in the “Operating Procedure” section.

Operating Procedure

Assuming the previous installation instructions have been completed and cautions noted, and the power amplifier is ready to receive a properly modulated RF signal, proceed with the following steps to place the system in operation. The power amplifier has been factory aligned for a specific frequency (per system specification), signal levels and optimum performance.



IT IS HIGHLY RECOMMENDED THAT YOU RUN YOUR SYSTEM INTO A DUMMY LOAD BEFORE INSTALLING TO MAKE SURE THERE ARE NO DAMAGES CAUSED IN SHIPPING AND THE UNIT IS RUNNING PROPERLY

1. Verify that all control and RF cables are tight and properly seated in or on the mating connector.
2. Plug in the desired audio source: analog (left and right for stereo), digital or MPX. For mono audio use the Right XLR input.
3. With the power amplifier loaded into the antenna, cavity, alternative load, or dummy load power up the amplifier by turning on power supply either via the ON/OFF switch on the back of the power amplifier.
4. Verify that the power amplifier fans are all on. The power amplifier fans are powered via DC voltage so this is an indication that the power supply is started and running. There may be fans installed in the filter or power supply enclosures, if applicable.
5. The internal soft start circuitry will turn the bias voltages off until the power supply to the amplifier pallets is fully stable. The front display indicates when the soft start is running with either a displayed message when an LCD option is installed or via maximum attenuation when a touch screen option is installed. Once complete, the Forward and Reflected Power, Power Supply, and Temperature readings will appear on the display. Deviation is shown on the FM screen.
6. Adjust RF output power on the power amplifier to about 10% of rated forward power. The output power level is adjusted from the power amplifier's RF Levels screen. Then turn the carrier on, the Carrier On/Off is in the top right corner of the touch display on all screens. If the unit contains more than one final amplifier pallet (illustrated in your Block Diagram included in the Quickstart package), ensure that the final pallet currents on the multiple finals all match within 10% of each other. With multiple finals, the final pallet currents should always match within this range under all operating conditions.



Front panel readings will vary slightly upon turn on. Steady state parameters can be taken after approximately one hour.

7. Ideally, the RFL Power should read zero. However, should a high VSWR be detected, the system will automatically fold back. Under normal conditions, a well installed and setup system should indicate RFL power less than 3% of FWD power.
8. Adjust RF output power on the power amplifier to desired level. The output power level can be adjusted from the power amplifier's RF Levels screen. Keep in mind that the system will fold back or shut down (depending on severity) should the forward RF output power level exceed the trip overdrive point.



Pease note that 100% should be the maximum FWD power. Typically, customers run the systems at 90% to avoid occasional AC power line spikes or transients from tripping the shutdowns. The difference of 10% will provide a marginal difference in range (tower height will have a much more significant effect on range in the case of over-the-air) or cavity excitation.

9. Verify that the power supply reads correctly (see supplied final inspection sheet for factory settings of power supply levels) on the display of the power amplifier. You should see no more than 3% fluctuations in DC supply voltage, and even less with a properly conditioned AC source to the power supply.
10. Look at the transmitted output using suitable test equipment. If the output quality is unsatisfactory, check the input signals, connections to the antenna system, antenna and transmission line VSWR, and the physical condition of the antenna.
11. Select the appropriate input from the FM Controls screen on the front panel.
12. Adjust the attenuation for the input if needed from the Audio Levels screen on the front panel. Check the modulation level on the main RF Display or FM display on the front panel.
13. After warm up, compare the temperature of the equipment from the front display to the temperature recorded in the final inspection sheet, included in shipping. Assuming ambient temperatures are close (our factory is typically around 18 to 25°C), your temperature reading should be very close to the factory reading. Use your temperature measurement as a method to monitor fan performance (though on higher power units, fan current is also monitored). A fan failure or air blockage will show an increase in temperature, assuming ambient temperature is not varying.

For FM broadcast applications, if the quality of transmission is unsatisfactory, the difficulty is often with the receiving antenna or with obstructions in the path between the amplifier/antenna and receiver. There is also a troubleshooting section located later in this manual.

At this time, Technalogix recommends that you document your measurements to use as a reference over time. The measurements can be made either from the front display, or remotely via the Remote Port (DB25), Ethernet (lower RJ45), or SNMP (lower RJ45), whose operation is explained in the Monitor and Control System sections.

Monitor and Control System

Control System Overview

The control system is used for a variety of functions, the most important of which is ensuring that the amplifier or transmitter continues to operate in a safe manner. The control system also allows the user to monitor and control the amplifier or transmitter from both the front panel and remotely through the parallel port, Ethernet, or SNMP access port.

The control system is comprised of three modules. These modules work together to provide all the functions of the control system and include: Display Interface, Exciter (in the case of a transmitter), and Temperature Sensor modules. The operation of each module is outlined in the following sections and illustrated in the following block diagram. Multiple revisions of the modules may be included. Specific revision numbers of the modules are listed on the Final Inspection Report included in the Quickstart Package and also in the Versions screen if the touchscreen option was ordered.

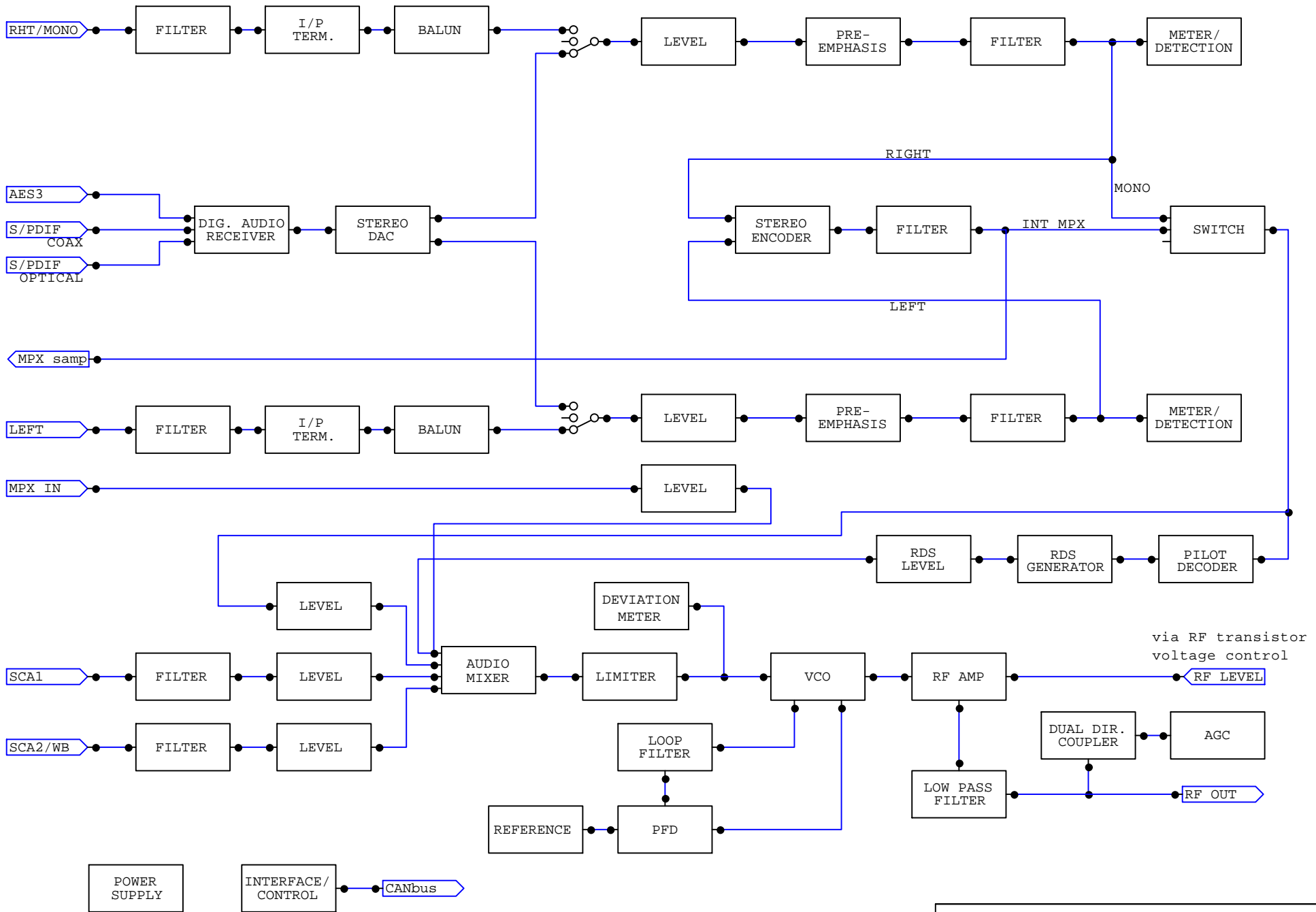

Display Interface Module REV 1.02 (ASY 016) Touchscreen Option

The primary function of the Display Interface module is, as the name suggests, providing the display and user interface for the control system. This circuit board is mounted behind the front panel of the power amplifier enclosure(s) in the amplifier system, near the 4.3" touchscreen or OLED display. All switch/settings and user interface is handled through the resistive touchscreen. The touchscreen on the front panel is connected to the Display Interface PCB through a cable.

These components provide the user with the ability to monitor the following power amplifier or transmitter parameters from the front panel:

- Forward (incident) power at the power amplifier or transmitter output.
- Reflected (reverse) power at the power amplifier or transmitter output.
- DC voltage of the power amplifier's or transmitter's power supply.
- DC current in the power amplifier or transmitter.
- Temperature of the heat sink of the power amplifier or transmitter.
- The time since the amplifier or transmitter was last shut down.
- History of faults and events.
- Indication if there is attenuation added to the front end of the power amplifier or transmitter indicating fold back in RF power (indicates amount of attenuation).
- Settings to change the VSWR trip point shutdown between 1.1:1 and 1.8:1.
- Settings to change the RF power units between % power (maximum of 110%) or watts.
- Summary of PCB modules and assembly numbers specific to the power amplifier or transmitter.

A block diagram of the Display Interface PCB follows:

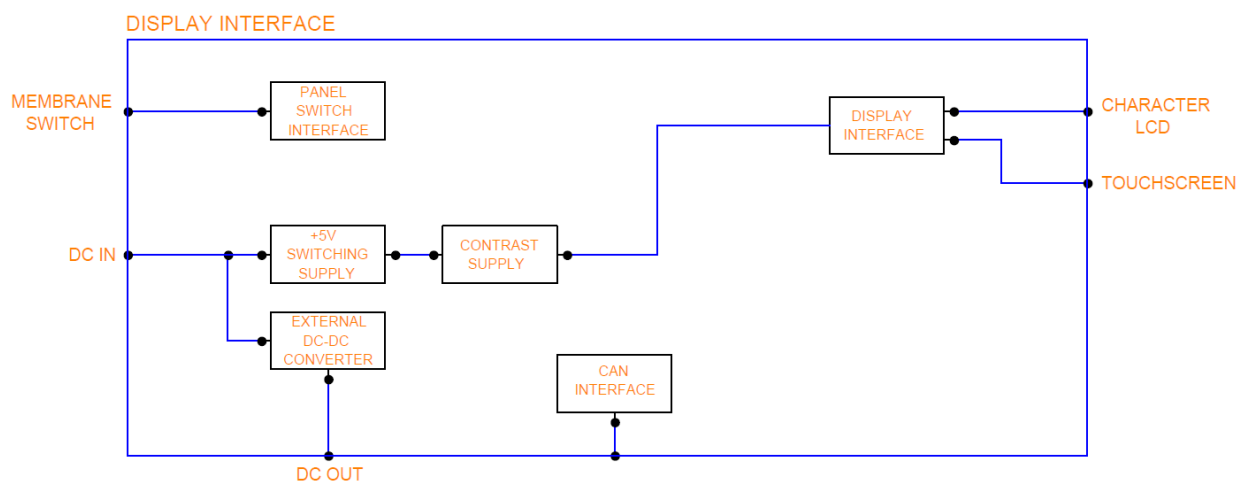

The hardware of the Display Interface module is based around microcontroller (U101). This part interfaces directly with the touchscreen to provide output and receive input from the user. It also communicates with the RF board (and DC Distribution Module, if installed) over a Controller Area Network (CAN) bus. This communication is facilitated by U103, and passes through a CAT5 cable attached to connector J104 and J105. The communication link with the RF module allows the Display Interface Module to receive information about the forward power, reflected power, and temperature of the amplifier/transmitter, as well as relay commands from the user to the rest of the system. If the DC Distribution Module is installed (on higher power systems with multiple pallets), then the Display Interface receives DC currents from the DC Distribution via the same CAN bus.

Other elements of the Display Interface module are also controlled by the microcontroller. A buzzer (BZ101) and software status LED (D101), which flashes when the software / microcontroller is running, are all controlled through a buffer (U102). DC supply enters through connector J103, which powers the PCB and also the optional DC-DC converter (based around U111), if populated. The PCB voltage is regulated at +5V by U106 and associated circuitry. The touchscreen interfaces to the Display Interface via connector J107.

The fuses on the Display Interface are all resettable. F102 protects the +5V line while F101 protects the DC-DC converter, if installed.

Main Screens

From each of the two main screens, the RF and the FM main screen, all of the system's main parameters can be viewed at a quick glance. To toggle between these two screens, simply touch:

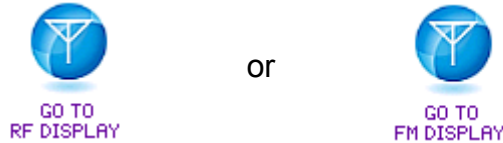

For the Main RF and Main FM screen, there are three common components between each screen:

Level Bars: The four level bars show real time system performance and help illustrate any transient changes that occur. Some of the units of measure can be adjusted in Settings Menu described later in this section.

Summary Bar: The summary bar at the bottom of the screen will stay in place no matter what screen is being viewed to allow for an operating summary at any time, as described below:

SYSTEM SETTINGS	FWD (%) 98	RFL (%) 0	TEMP (C) 20	DC (V) 24	AGC (%) 100	FREQ 103.0
-----------------	---------------	--------------	----------------	--------------	----------------	---------------

SYSTEM SETTINGS

Toggles between Main Screens and Menu Screen for settings. The menu screen has additional settings and monitoring over the Main Screen, and is illustrated in the next section.

FWD (%)
87

Forward RF power level in % or watts. Mimics data from level bar. Overdrive protection starts at 110% where the power amplifier/transmitter folds back power by adding attenuation to the input until a safe level obtained. System continually checks power level and tries to bring RF power level back to where it was when fault occurred. If overdrive occurs, a warning is displayed in red text near the top of the touchscreen and the event recorder logs the event.

RFL (C)
2

Reflected RF power level in % or watts. Mimics data from level bar. The VSWR fault occurs when the measured VSWR of system exceeds the user-defined VSWR trip point found in the RF Levels Menu (described later in section). If VSWR exceeds the shutdown level, but is below 1.8:1 (or a custom VSWR protection point), then attenuation is added to the amplifier/transmitter input until a safe level is reached. If the measured VSWR exceeds 1.8:1 (or a custom VSWR trip point), then the RF carrier is turned off to protect the amplifier/transmitter chain. Then the system will continually check to see if it is safe to come back on. This scheme helps ensure that the system stays on air as long as possible before doing a complete shutdown. If high reflected occurs, a warning is displayed in red text near the top of the touchscreen and the event recorder logs the event.

TEMP (C)
23

Temperature from sensor mounted on heat sink surface. Shutdown trip point is factory set at a predetermined level to keep the amplifier/transmitter pallets safe. Should a fan fail inside the power amplifier/transmitter enclosure, or air conditioning fails inside the broadcast facility causing the temperature to exceed the trip point, the control system will lower forward RF power until a safe level of measured temperature is achieved. The system will continually try and bring the RF power back to the same level when the fault occurred if it is safe to do so, a warning is displayed in red text near the top of the touchscreen, and the event recorder logs the event.

ATTEN
0

RF output power is determined largely in part by the amount of attenuation that the control system places on the input of the power amplifier/transmitter. Whether a fault occurs and attenuation gets added or the user requests a change in RF power level via the web/SNMP/Remote Port interface, the attenuation section of the summary bar conveys important operating information. If the user requests a change in forward power level via the web interface, SNMP monitoring and control, or simply via the Remote Port connector on the back of the enclosure, and an asterisk (*) is placed next to the attenuation value in the summary bar. This informs the user whether or not the attenuation was added due to a fault or simply because it was requested.



The AGC sets the desired output power level. This is set on the RF Levels screen where it can be increased or decreased by +-1% or +-10% increments. The current AGC setting is shown in the RF Levels screen and on the bottom banner. The display can be changed to show in Watts rather than percent but the step size for setting the AGC will still be in increments of 1 or 10%.

Carrier Switch: From any screen, the FM amplifier or transmitter carrier can be turned on or off to facilitate adjustments, settings, and testing/troubleshooting. To toggle carrier states, simply touch the switch icon:



The same result occurs by turning on or off the system via the web or SNMP interface, or through controlling of the Remote Port. A quick beep from the on-board buzzer signifies that the response has been taken. The power supplies and fan will remain active while the carrier is turned off via this switch.

If additional screens, details, and settings are required, several additional screens can be accessed through the SYSTEM SETTINGS button described later in this section.

Main RF Screen

The Main RF Screen summarizes key parameters for the RF carrier of the FM signal, as illustrated below:

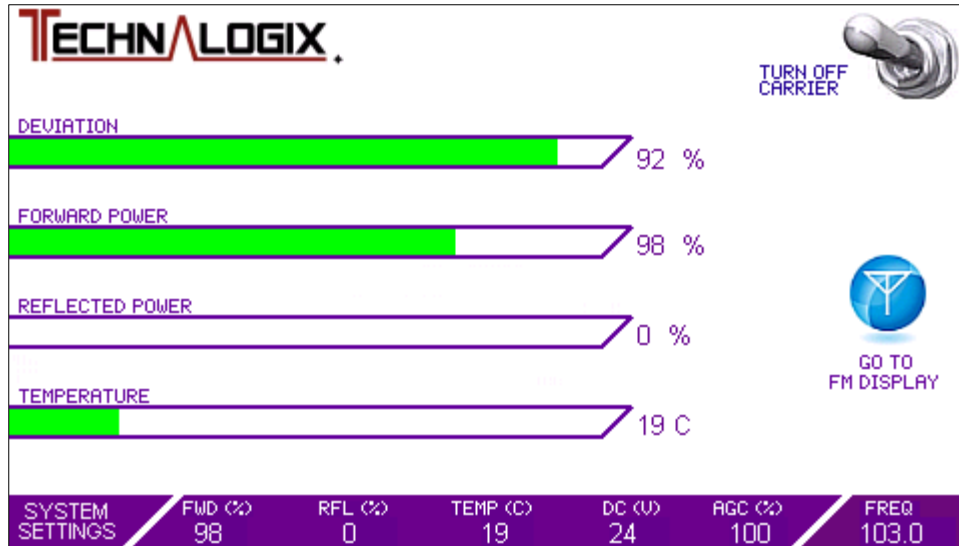

FORWARD POWER: This is the power heading out of the power amplifier or transmitter to the antenna or load, measured in watts or scaled percentage, depending on how the units are set in the Settings Screen).

REFLECTED POWER: This is the power coming back in to the power amplifier or transmitter from the antenna or load, measured in watts or scaled percentage, depending on how the units are set in the Settings Screen). As there is no internal circulator or isolator installed within the enclosure, it is important to minimize VSWR with a good quality antenna installed using proper broadcast techniques. Ice build-up on the antenna and damages to 50 ohm transmission line can also generate damaging reflected power.

TEMPERATURE: The temperature is measured on top of the heatsink near the final transistors and displayed here. User can toggle between Celsius and Fahrenheit from the Settings Screen. In the event that this temperature exceeds the factory set trip point, the RF carrier level will fold back to protect the unit. Common causes for high temperatures can include failed internal fans or air conditioning in the broadcast facility or a blocked fan.

DC VOLTAGE: The switching power supply DC output voltage is displayed here.

If additional screens, details, and settings are required, several additional screens can be accessed through the SYSTEM SETTINGS button described later in this section.

Main FM Screen

The Main FM Screen summarizes key parameters for the audio that resides on the RF carrier of the FM signal, as illustrated below:

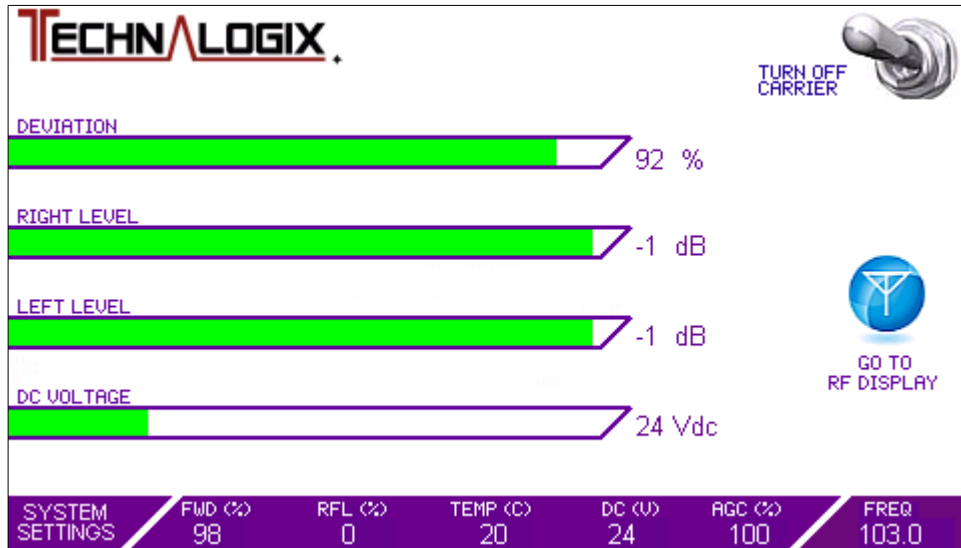

DEVIATION: The maximum frequency excursion from the carrier center frequency is illustrated on this level bar. Typical maximum deviation, required by Industry Canada or FCC, is 75 kHz to avoid bleeding into adjacent channel bands of 200kHz bandwidths. 100% represents a full 75 kHz deviation.

RIGHT LEVEL: Right level bar represents the audio level on the right audio input channel.

LEFT LEVEL: Left level bar represents the audio level on the left audio input channel.

DC VOLTAGE: The switching power supply DC output voltage is displayed here.

If additional screens, details, and settings are required, several additional screens can be accessed through the SYSTEM SETTINGS button described later in this section.

Menu Screen

The menu screen allows the user to dive into further details of the power amplifier or transmitter operation. Pressing the BACK TO MAIN button will toggle between the Main Screens and the Menu Screen. The Menu Screen is shown below:



Each of the menu icons on the Menu Screen allow the user to take additional readings or make settings that are not provided from the Main RF and FM Screens. Any changes to settings will be stored in non-volatile memory.

While the user is in the sub menu screens (anything besides the Main Screens), full monitoring and protection is taking place. This means that as a user makes a change to a setting or parameter that jeopardizes the power amplifier or transmitter, the control system will provide protection, display the fault in red text near the top of the touchscreen, and stay in the current menu.

The individual menu screens will now be covered.



RF Levels Screen

This screen allows the user to change settings to the RF levels, including the Forward RF level (the reflected (VSWR) trip point is changed from the Settings screen. From the RF Levels screen, the user can also toggle between AGC and Manual mode. The RF Levels Screen is displayed below:

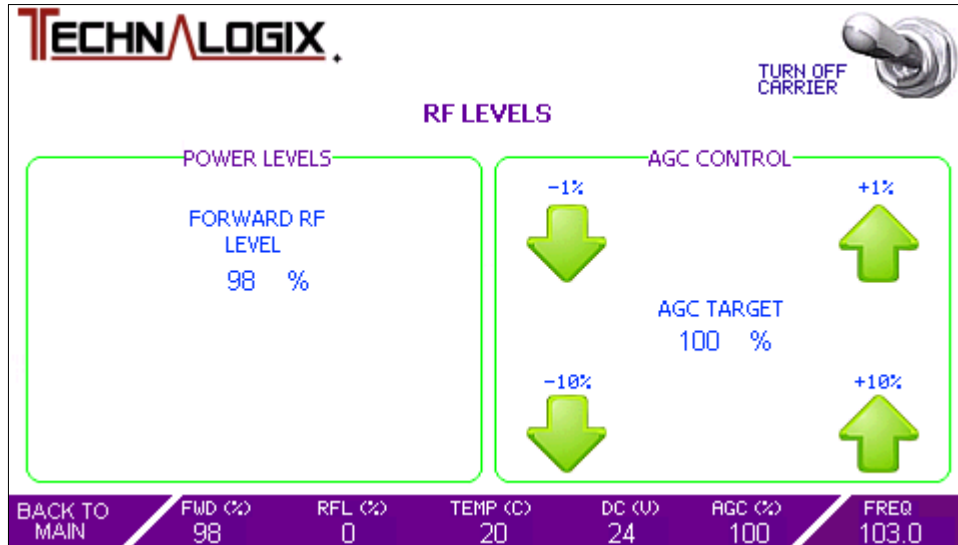

To adjust Forward RF Level:

Press the up or down arrows (in either 1 or 10% increments or decrements) until the desired Forward RF level is reached. If the adjusted level exceeds 110%, the protection will kick in and the system will fold back the RF power to a safe level. There may be a residual amount of Forward RF power even at 0% setting, but it should be insignificant.



Power Supplies Screen

This screen allows the user to view individual voltage and current readings. The Power Supplies Screen is displayed below:

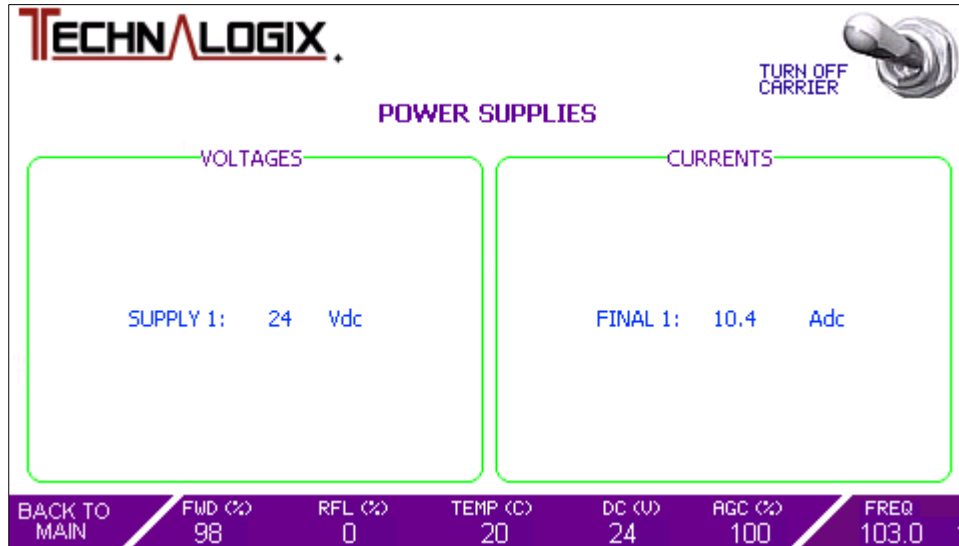

DC supply voltages are nominally 24, 30, or 48Vdc depending on the system. Readings of this voltage in the Power Supplies Screen, and on the summary bar at the bottom of the touchscreen, should not vary more than +/- 2%.

If multiple amplifier pallets are included in the amplifier chain, then the individual currents will all be displayed in the Currents section of the screen. In the case of multiple pallets in the chain, typically the user should see matching of the final pallets to within approximately 10%. Anything outside this range is usually a sign that there may be an issue. Transistor device could be the culprit, or the tragic spilt-drink-on-amplifier incident. Our team would be glad to walk you through any troubleshooting issues or questions you may have.



FM Controls Screen

The FM Controls Screen allows a user to setup audio inputs and FM settings. As fun as fooling around with the smallest screwdriver you own in the back of a dark rack sounds, all of these settings can be done from the front touch screen.

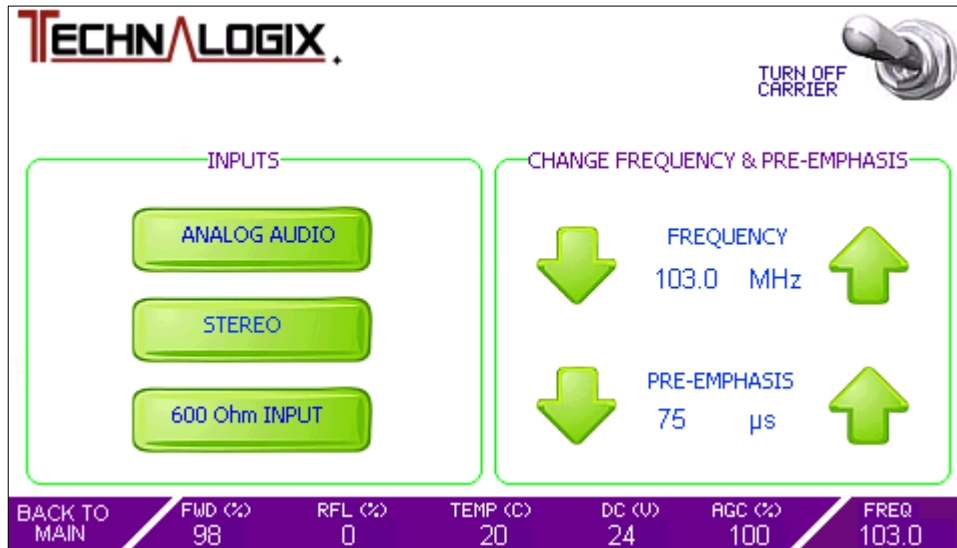

Audio Source: As Technalogix FM transmitters include analog and digital audio inputs as standard, the user can change audio input sources on the fly and can switch between analog and digital audio sources. When digital audio is selected, the Mono/Stereo selection icon changes to allow selection between the various digital audio inputs (Toslink optical, coax, AES).

Mono/Stereo: All Technalogix FM transmitters have a stereo encoder built in to the exciter circuit board. The user can switch between Mono and Stereo option by simply touching this icon on the touch screen.

Input Impedance: When analog audio input is selected as a source, the user can adjust the input impedance of the exciter in the transmitter between 600 and 10k ohms.

Frequency: With the exciter being agile, the user can change frequency from the front touch screen. The step size is 100 kHz. At the lower and upper frequency limits of the FM band, the frequency will wrap back around.

Pre-Emphasis: Pre-emphasis adds a boost to high frequencies in the FM signal to increase the signal above the noise floor. The FM signal then is de-emphasized at the radio receiver end. Users can change the amount of pre-emphasis to suit their location and receivers. A lower pre-emphasis, say 50 us versus 75 us, is a lighter boost, but also increases high frequency headroom. Setting the pre-emphasis to 0 us turn off the pre-emphasis. Standard North American pre-emphasis is set to 75 us on the transmitter side, while most of the rest of the world incorporates 50 us.



History Screen

The History Screen provides a summary of the most recent events that have occurred in the power amplifier or transmitter. An event can either be a fault or simply an action like turning on or off the carrier. The format of the History Screen is illustrated below:

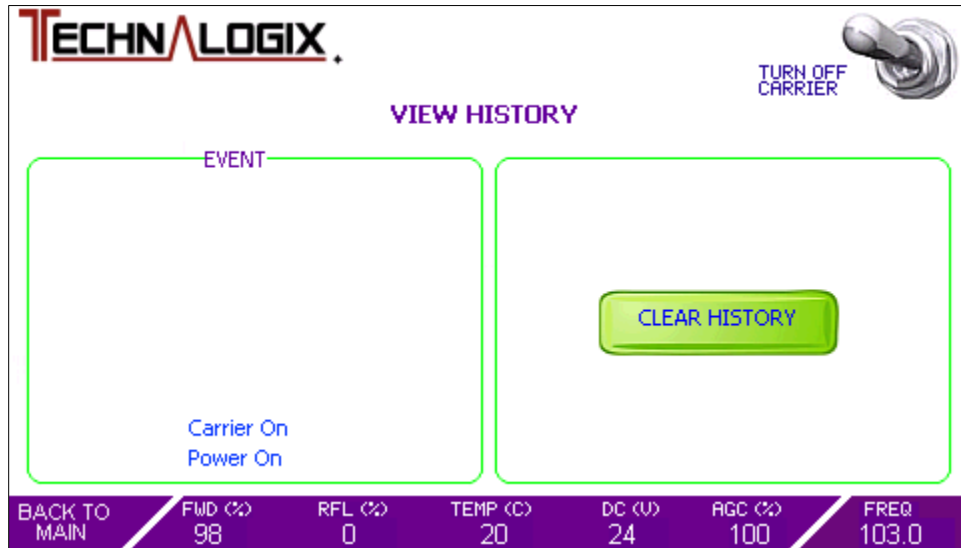

Ten of the most recent events are displayed on the History Screen. As more events occur, the earliest recorded event gets displaced on the screen.

The user can clear the history screen by pressing the CLEAR HISTORY. Users will find this screen useful in correlating events in the power amplifier or transmitter with external events like weather and changes to the broadcast facility's environment.

The events are recorded in non-volatile memory so they are safe in the event of a power outage or pesky lightning-strike-wins-fight-with-power-supply.



Audio Levels Screen

The Audio Levels Screen allows the user to tweak audio input levels all from the front touch screen.

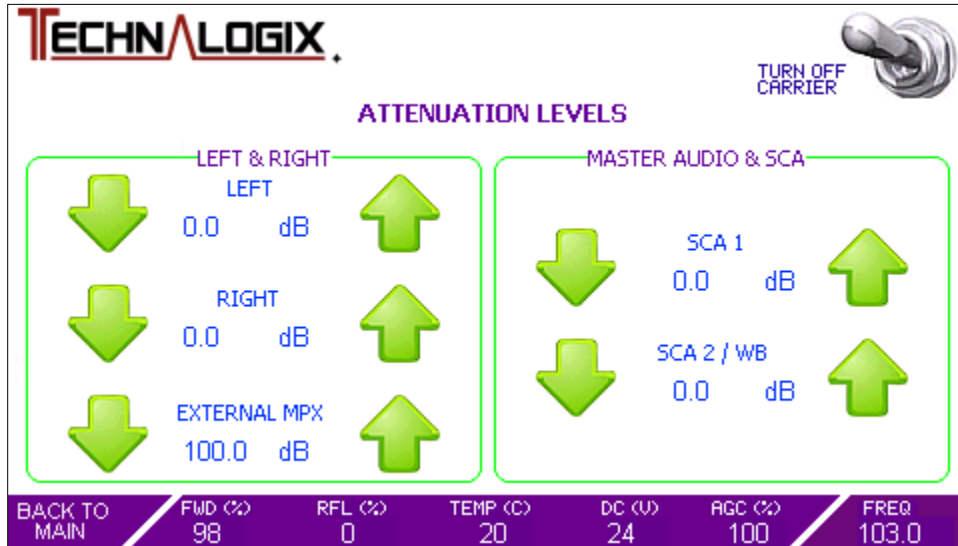

Step sizes will vary from 0.5 dB up to 2.0 dB depending on the current audio, MPX, and SCA input levels.

Attenuation levels of 100 dB indicate that attenuation is at maximum for that particular input signal.



Version Screen

The Version Screen contains no user-settable items, but is intended as an identification screen to the user. It also helps Technalogix maintain its unmatched service reputation by allowing our technicians and Service team to know exactly what versions of PCBs are inside a customer's unit, even several years down the road. The versions can then be correlated to factory documentation. In addition, current government certification numbers are included for Industry Canada and FCC. Please contact Technalogix if you require copies of the actual grants, or visit:

FCC: <https://fjallfoss.fcc.gov/oetcf/eas/reports/GenericSearch.cfm>
(grantee code QH5)

Ind. Canada: <http://www.ic.gc.ca/app/sitt/reletel/srch/nwRdSrch.do?lang=eng>
(company 3803)

Finally, general information is included in the Version Screen for users who may not be familiar with the equipment and do not want to venture into the dusty abyss behind the rack or cabinet searching for tiny ID tags. The Version Screen is illustrated below:

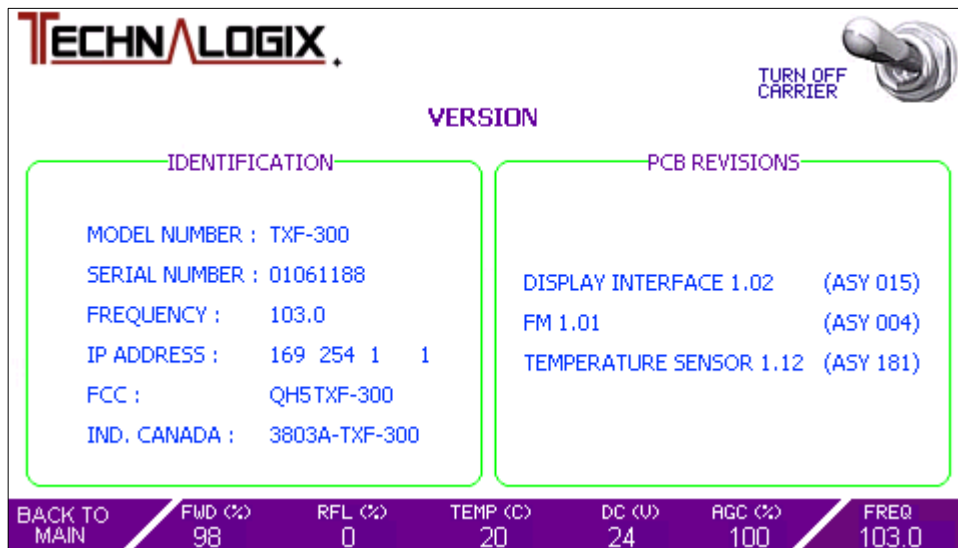



Contact Screen

The Contact Screen provides an easy means for the user to get in touch with Technalogix for anything. Whether they have a technical or installation question or simply want to chat about how gosh darn cool our equipment is, Technalogix welcomes questions, feedback, and contact.

If you are in the area, please feel free to stop by to tour the facility, test drive some state of the art products, or get a refresher on some training.

TECHNALOGIX

CONTACT

TURN OFF CARRIER

www.technalogix.com

#4, 8021 Edgar Industrial Place, Red Deer, AB, T4P 3R3

SALES: sales@technalogix.ca
SUPPORT: technical@technalogix.ca

ph: 403-347-5400

BACK TO MAIN	FWD (◁) 98	RFL (▷) 0	TEMP (C) 20	DC (V) 25	AGC (◁) 100	FREQ 103.0
--------------	------------	-----------	-------------	-----------	-------------	------------



Settings Screen

“You say tomato...”

The Settings Screen allows the user to modify some of their preferences on how information is displayed on the touchscreen, as seen in the figure below:

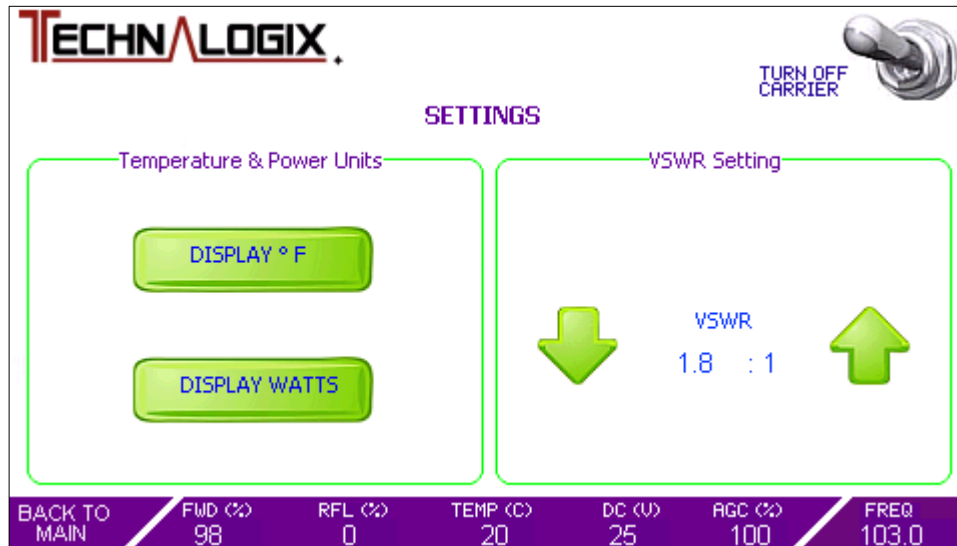

Pressing the DISPLAY ° F button will convert all temperature readings to degrees Fahrenheit from Celsius (and vice versa). Temperature protection trip points are factory set.

Similarly, the user can switch between watts or percentage for their RF power readings. When in percentage mode, the power amplifier or transmitter is designed for a maximum operating power of 100% with overdrive protection typically at 110%.

To change the VSWR Shutdown Trip Point:

Use the up and down arrows to set the VSWR shutdown trip point to between 1.1:1 and the factory determined upper limit. If a measured VSWR is found above the set trip point, but below the factory determined upper limit, then the system will fold back the forward power to a safe level. If the measured VSWR exceeds the factory determined upper limit, then the carrier will be initially turned right off.

Technalogix may have provided custom firmware with the amplifier or transmitter that may deviate from the above operation. Please consult factory for any client-ordered custom settings.



FM Exciter Module
REV 1.01 (ASY 0070)

The FM Exciter module accepts analog and digital audio inputs, processes the audio, and then modulates the audio onto an FM carrier in the range of 87.5 to 108.0 MHz. This modulated signal is then fed into a small gain stage before passing the signal off to the final gain amplifier stage(s).

Analog input can be balanced or unbalanced, though the former will provide a higher quality signal. Digital audio can be sourced from AES, S/PDIF optical (Toslink), or S/PDIF coaxial.

The following pages illustrate the schematics of the FM Exciter module.

Temperature Sensor Module REV 1.13 (ASY 0183)

The Temperature Sensor module is a small board mounted to the main heatsink of the amplifier/transmitter. The main purpose of the temperature sensor module is to take temperature readings of the heatsink. The following is a block diagram of the Temperature Sensor module:

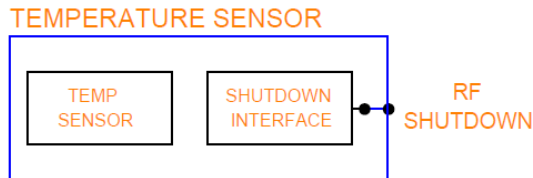

The temperature sensor IC is U701 which, after it has taken a reading, relays the digital information to the RF PCB module through J700. Also passing through J700 is a driver disable signal coming from the RF PCB module. The Temperature Sensor module simply takes this signal and passes it through to a pad, where a wire connects it to the driver or first gain stage pallet.

In custom applications, there may be multiple temperature sensors installed onto a heatsink or throughout the system.

Web Interface

To access the Technalogix Adrenaline Web Interface, a series of four simple steps are required:

1. Connect power amplifier/transmitter to your network/PC
2. Open web browser for monitor and control
3. Optimize user parameters

The following pages will describe each step in detail. Descriptions specific to the user's computer, router, or network setup are limited due to the differences in the multitude of networking equipment.

1. *Connect Power Amplifier/Transmitter to your Network/PC*

Connect an Ethernet cable from the RJ45 port (labelled ETH / SNMP – use bottom connector) on the back panel of the power amplifier or transmitter to your network's Ethernet connection. Most new computers can do this with a standard Ethernet cable but older network cards may require a crossover Ethernet cable.

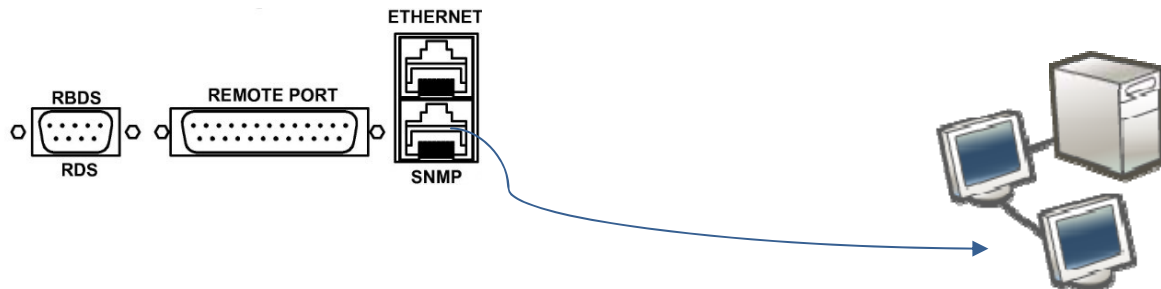

If preferred in place of the touch screen, a computer can be plugged directly into the Ethernet port on the power amplifier/transmitter to directly access the on-board web interface.

Turn on the power amplifier or transmitter to establish communication between the power amplifier and the network.

The Adrenaline control system in the power amplifier or transmitter will source an internal IP from your router or you can set this manually (see Optimize User Parameter section).

2. Open web browser for monitor and control

The default internal address is <http://adrenaline/index.htm>. Type this default internal address into the URL address bar of your favorite web browser. The web pages cannot be accessed until you have established basic communication with the power amplifier or transmitter (turned on).

2.1 Web Page Password Protection

After entering the above internal address into a web browser, you will be asked for a password. Initially, please use the following:

username: admin
password: admin

The password can later be changed (see Optimize User Parameter section).

2.2 Main Page Description

After entering the login information, the main page is then shown on the browser, as illustrated below for either single amplifier systems or multiple amplifier systems that are combined:

The screenshot displays the Technalogix Broadcast Web Interface. At the top, the Technalogix logo is visible with the tagline 'The company that can'. Below the logo, the text 'BROADCAST WEB INTERFACE' is displayed. A navigation bar contains links for 'Main', 'Network Configuration', 'SNMP Configuration', and 'Password Configuration'. The main content area shows the following information:

Model Number: TXF-300
Serial Number: 12345678

Status Flags:	Performance:	Control:																																										
<ul style="list-style-type: none">CarrierRF OverdriveVSWRPallet VoltageRF In LevelTemperature	<table><tr><td>Forward RF Level</td><td>99</td><td>% FS</td><td>Deviation</td><td>0</td><td>%</td></tr><tr><td>Reflected RF Level</td><td>0</td><td>% FS</td><td>Right Level</td><td>-60.0</td><td>dB</td></tr><tr><td>DC Pallet Voltage</td><td>24</td><td>Volts</td><td>Left Level</td><td>-60.0</td><td>dB</td></tr><tr><td>Temperature</td><td>20</td><td>Celsius</td><td>Frequency</td><td>98.0</td><td>MHz</td></tr><tr><td>Current</td><td>0.0</td><td>A</td><td>Pre-emphasis</td><td>75</td><td>µs</td></tr><tr><td>VSWR Trip Point</td><td>1.8</td><td>-</td><td></td><td></td><td></td></tr><tr><td>AGC Set Point</td><td>100</td><td>% FS</td><td></td><td></td><td></td></tr></table>	Forward RF Level	99	% FS	Deviation	0	%	Reflected RF Level	0	% FS	Right Level	-60.0	dB	DC Pallet Voltage	24	Volts	Left Level	-60.0	dB	Temperature	20	Celsius	Frequency	98.0	MHz	Current	0.0	A	Pre-emphasis	75	µs	VSWR Trip Point	1.8	-				AGC Set Point	100	% FS				<ul style="list-style-type: none">TURN CARRIER OFFAGC TARGET +1AGC TARGET -1AGC TARGET +10AGC TARGET -10VSWR [] []FREQUENCY [] []ANALOGMONOPRE-EMPHASISRESET
Forward RF Level	99	% FS	Deviation	0	%																																							
Reflected RF Level	0	% FS	Right Level	-60.0	dB																																							
DC Pallet Voltage	24	Volts	Left Level	-60.0	dB																																							
Temperature	20	Celsius	Frequency	98.0	MHz																																							
Current	0.0	A	Pre-emphasis	75	µs																																							
VSWR Trip Point	1.8	-																																										
AGC Set Point	100	% FS																																										

Copyright 2009 Technalogix Ltd.
www.technalogix.ca

The model number and serial number of the unit are displayed in the top left of the browser screen.

The Status Flags section provides the user with feedback from the system. Specifically, there are status flags for:

- RF Carrier is on or off
- Forward RF in Overdrive (>110% Full Scale (FS))
- High VSWR
- Pallet Voltage Supply Good
- RF In Level Good
- High Temperature

The Performance section provides the user with specific parameters and measurements in the system. Measurements that can be viewed from the Performance box are:

- Forward RF Levels as a % of Full Scale (FS)
- Reflected RF Levels as a % of FS
- DC Supply Voltage in volts
- Temperature in °C
- Current of pallet(s) in A_{dc}
- VSWR Trip Point Limit
- AGC measured against 100% FS
- Deviation
- Right Level/Left Level input attenuation
- Frequency in MHz
- Pre-Emphasis, selectable between 0, 25, 50, or 75 us

The Control section of the web interface screen allows the user to control functions inside the equipment, including:

- Turn Carrier On/Off - Turn the Carrier on/off
- AGC - Increase the Carrier by removing attenuation (steps of 1 or 10 dB)
- VSWR $\uparrow\downarrow$ - Increase or Decrease the VSWR Trip point by 0.1 between 1.1:1 and factory determined limit.
- Frequency $\uparrow\downarrow$ - Increase or Decrease the FM carrier frequency (MHz)
- Analog/Digital – Toggle between analog or digital audio inputs
- Mono/Stereo – Toggle between mono or stereo
- Pre-Emphasis – Toggle between no added emphasis, or 25, 50, or 75 us emphasis
- Reset - Forces the system to reboot

3. Optimize user parameters

Also on the main web Ethernet page, along the top, are links to the other user parameter pages:

- Main – Returns to Main Index page
- Network Configuration
- SNMP Configuration
- Password Configuration

The following sections describe the user parameter pages in detail.

3.1 Network Configuration

The Network Configuration page allows the administrator to optimize the network settings to best suit their application.

Technalogix Web Interface - Mozilla Firefox

File Edit View History Bookmarks Tools Help

http://adrenaline/protect/config.htm

Technalogix Web Interface

TECHNLOGIX
The company that can.

BROADCAST WEB INTERFACE

[Main](#) [Network Configuration](#) [SNMP Configuration](#) [Password Configuration](#)

Board Configuration

This page allows the configuration of the board's network settings.

CAUTION: Incorrect settings may cause the board to lose network connectivity. Recovery options will be provided on the next page.

Enter the new settings for the board below:

Host Name:

HTTP Port:

Warning: Changing Port will cause lost of ethernet conection. Use only if Port 80 is disabled by your ISP.

Port forwarding will be required. Internal network can be addressed via http://adrenaline:81

Enable DHCP

IP Address:

Gateway:

Subnet Mask:

Primary DNS:

Secondary DNS:

Copyright 2009 Technalogix Ltd.
www.technalogix.ca

Done

3.1.1 Host Name

The Host Name shows the current webpage name (default is ADRENALINE). Enter a new name here if you wish to change this.

For example entering YourCompany will make the web address:

<http://yourcompany/index.htm>

3.1.2 HTTP Port

The HTTP Port shows the current port used for internet access, 80 or 81. Port 80 is the default and is the accepted standard. Port 81 is available because some internet providers block access to port 80 unless you pay more.



Be very careful changing HTTP ports as it can be difficult to go back to an original port.

You can force a web browser to use port 81 by address to:

<http://adrenaline:81/index.htm>

To use this with an internet address will require port forwarding. Consult your routers manual to set this up.

3.1.3 IP Addressing

With DHCP enabled the system will automatically try to find a router and acquire an IP address. If you want to set this manually, uncheck the Enable DHCP box and enter it below then click Save Config.

To view the webpage from the internet rather than an internal network you need an external IP address, generally provided by your internet provider. Note that you can only have one web server using the same port. With this, anyone can access the system over the internet with something like:

<http://www.yourcompanywebaddress.com/adrenaline>

3.2 SNMP Configuration

3.2.1 SNMP Communities

The SNMP Configuration page allows you to set the SNMP communities. Set these to limit access to the system via SNMP.

Default communities are	READ:	public read
	WRITE:	private write public

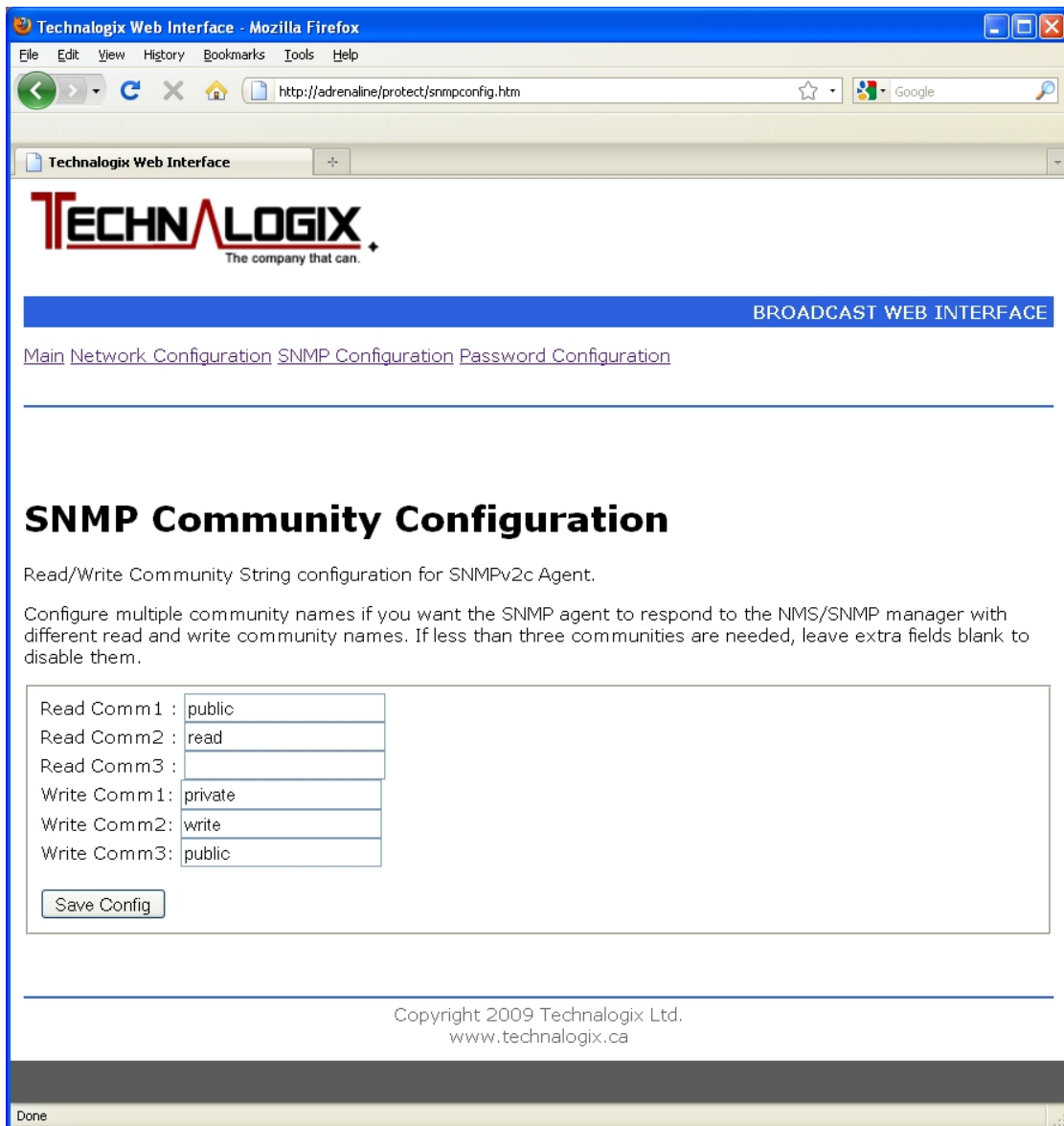

3.2.2 SNMP Management Information Base (MIB)

The Technalogix.mib file allows access to the following data via the SNMP protocol:

Read Only

Pallet Supply Voltage	- voltage level (Vdc)
Temperature	- temperature in (°C)
48V Current	- current on high voltage bus (Adc)
Attenuation	- attenuation level
Reflected Level	- reflected level as % rated full scale
Forward Level	- forward level as % rated full scale
RF Input Level	- input level as % rated full scale
Deviation	- modulation level as %
Left Level	- left audio input level shown as dB
Right Level	- right audio input level shown as dB
Serial Number	
Model Number	
SNMP Error Flag	- error flag, also for trap (see below)
VSWR Flag	- error flag for high VSWR
Overdrive	- error flag for overdrive
Temperature Flag	- error flag for high temperature
Preemphasis	- 0,25,50 or 75 us

Read/Write

Reset	- 1 Reset System, 0 Normal
Carrier On	- 1 Carrier On, 0 Carrier Off
Carrier Up	- 1 Increase Carrier Level for AGC target 1%
Carrier Down	- 1 Decrease Carrier Level for AGC target 1%
VSWR Trip point	- 1-8 for 1.1:1 – 1.8:1
Frequency	- 880 – 1080 for 88.0 to 108.0 MHz
Change Preemphasis	- rotate through 0,25,50, and 75
AGC Setpoint	- set target output power 0-100% rated power
Analog/Digital	- 1 Analog audio input, 2 Digital audio input
Digital Input	- 1 AES 2 SPDIF 3 TOSLINK
Analog Input	- 1 Mono 2 Stereo 3 MPX
Left Attenuation	- 0 – 79 dB Attenuation (shows 100dB when channel disabled)
Right Attenuation	- 0 – 79 dB Attenuation (shows 100dB when channel disabled)
MPX Attenuation	- 0 – 79 dB Attenuation (shows 100dB when channel disabled)
SCA1 Attenuation	- 0 – 79 dB Attenuation
SCA2 Attenuation	- 0 – 79 dB Attenuation

Read and Write communities can be set from the web interface, as described earlier in this section.

3.2.3 SNMP Traps

To enable the SNMP traps, within the MIB browser that you choose:

- Set enable traps to 1 (or yes, depending on MIB browser).
- Set the IP address to that of the receiving computer.
- Set the community to one of the read communities set above.

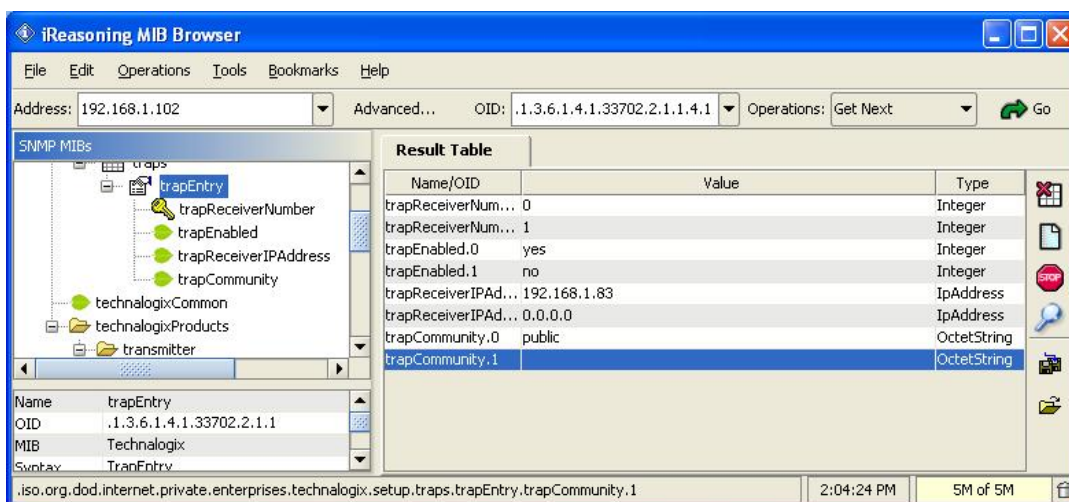
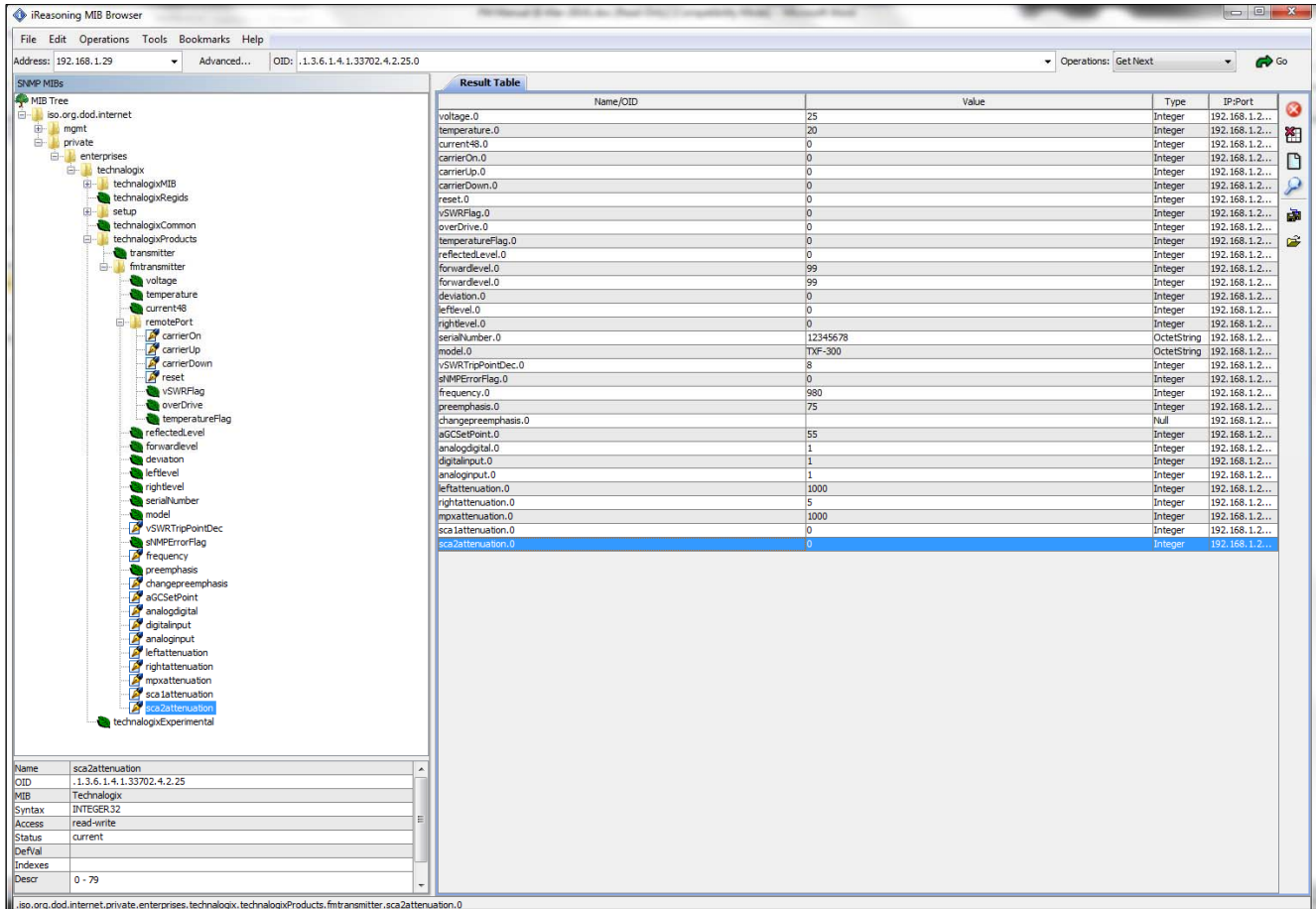

Ensure that your receiver's port is set to 162

The system will generate a general trap on any error flag and send an 8-bit value indicating the type of error, as follows:

- Bit 0(LSB) Overdrive
- Bit 1 High VSWR
- Bit 2 High Temperature
- Bit 3 High Speed Hardware Shutdown
- Bit 4(MSB) High Input Level

As an example, the following is a screen shot of a high temperature fault (Value 4).

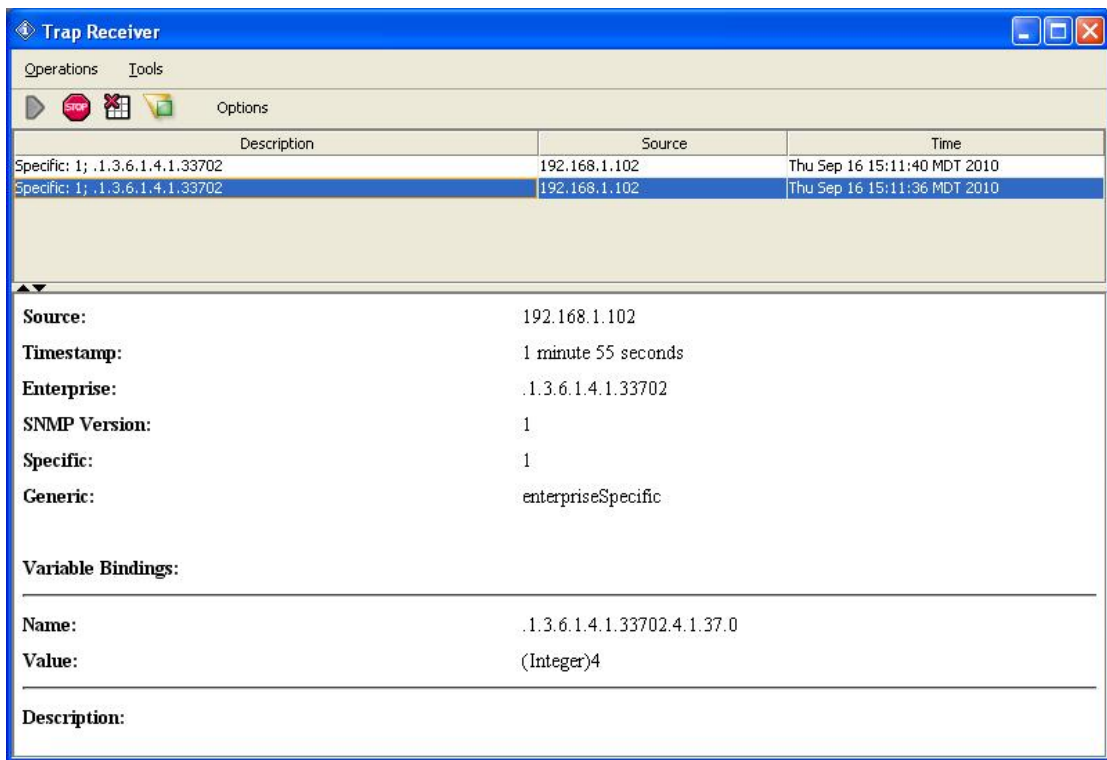

3.3 Password Configuration

This page allows the setting of the web browser's User or Admin password, as illustrated below.

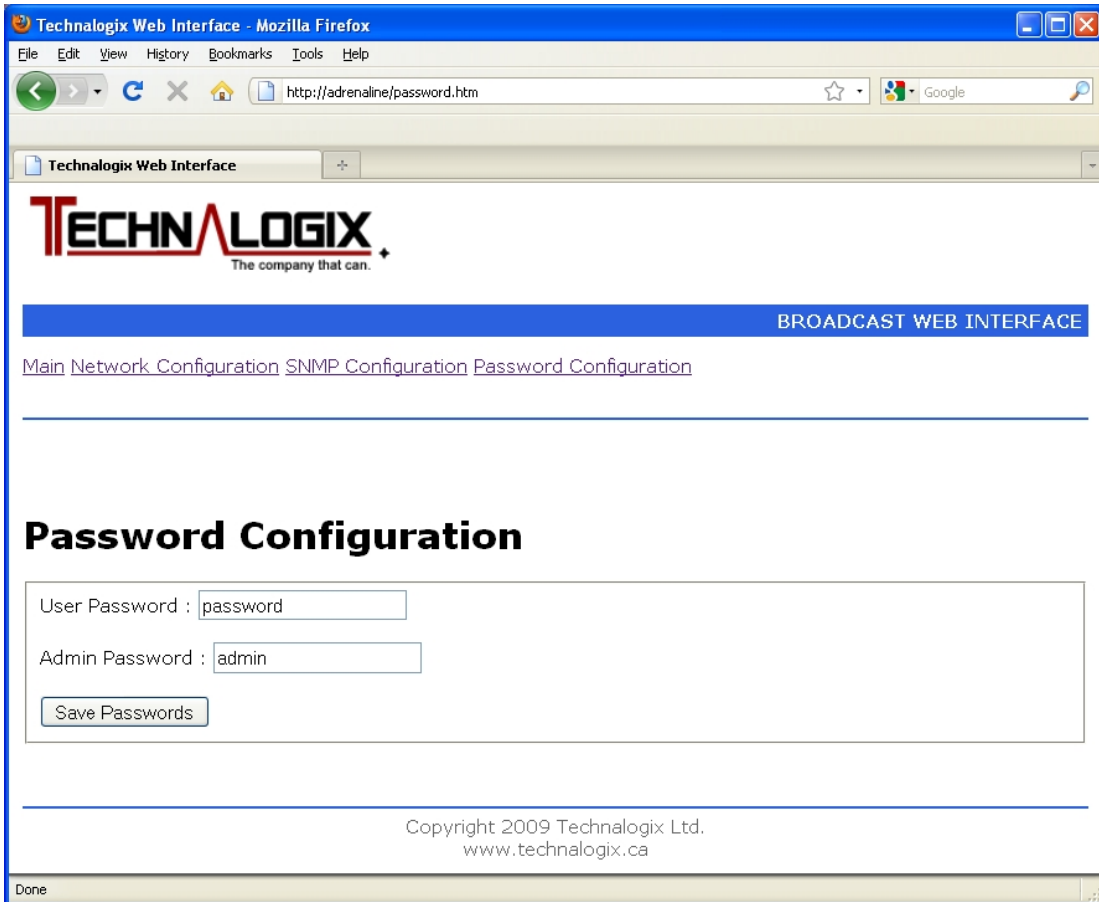

The User account allows access only to the main page. The Admin account allows access to the main and all the configuration pages.

Passwords are to be a maximum of 7 characters long. Don't forget your password. Resetting passwords isn't as fun as it sounds and may cause loss of all settings.

Remote Control (via DB25)

An additional option for remote control of the power amplifier/transmitter is through the DB25 connector found on the back panel of the power amplifier/transmitter, as illustrated below:

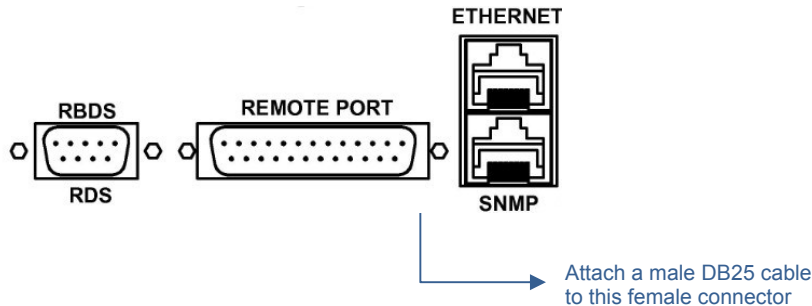

The overall functions of each pin on the Remote Port are indicated in the following DB25 pinout:

Pin Number	Description
1	Ground
2	Forward power sample ¹
3	Reflected power sample ¹
4	Carrier off ²
5	Carrier on ²
6 ³	Increase carrier level 1%, if AGC on ²
7 ³	Decrease carrier level 1%, if AGC on ²
8	Do not use
9	Reset ²
10	Do not use
11	High temperature flag ²
12	High VSWR flag ²
13	Amplifier overdriven flag ²
14	Do not use
15	+3.3Vdc (for testing only, do not load)
16	Ground
17	Ground
18-25	Do not use

- Notes:
1. Analog output with voltage ranging from 0 to 3.3Vdc.
 2. Open collector configuration on RF 1.04 and later. On RF 1.04 and later, ground to activate input control on inputs; ground indicates fault occurrence on fault outputs. On RF 1.03 and earlier, the inputs are TTL digital inputs, active on rising edge and the outputs are active high.
 3. If AGC off, these pins turn on AGC to the current FWD level, +/- 1%.

In addition to the DB25 parallel data connector, the user may chose to remotely control the RF amplifier/transmitter via an optional Ethernet web server or through an optional Simple Network Managed Protocol (SNMP) interface, described later in this section.

RBDS and RDS

Radio Broadcast Data System (RBDS) is commonly used for FM broadcast in North America, while the Radio Data System (RDS) is implemented in Europe. In 1998, the two standards were largely unified. Both systems are implemented as standard features on Technalogix FM transmitters, including the control, generator, and interface.

RDS uses a subcarrier to embed the FM signal with information. This can be used to transmit time, station identification, programming information and more.

To control the RBDS/RDS connect to the DB9 on the back of the unit using a RS232 connection. A USB-to-RS232 or Ethernet-to-RS232 convertor can be used instead (not included with transmitter).

To interface with the RBDS/RDS you need to install the Magic RDS software. Magic RDS software is found at http://www.pira.cz/rds/MagicRDS_Setup.exe.

General operating questions are answered here:
http://www.pira.cz/rds/show.asp?art=magic_rds_how_to.

The RBDS/RDS subcarrier level can be adjusted using R108 on the FM Exciter 1.01 circuit board. It should be set between 1.5 and 10% modulation. It is recommended to turn to 0% if not RBDS/RDS is not being used to provide the maximum available modulation for the audio signal.

RF Components

FM Amplifier Pallets

The following is a summary of the typical FM amplifier pallets used in Technalogix power amplifiers and transmitters out of the many pallets that have been designed for production or custom applications. The exact bias and drain currents of your system are found in the Final Inspection Report supplied in the Quickstart package. Output power levels are absolute maximum levels. Technalogix operates the pallets at reduced levels to improve performance and increase reliability.

PB1A-50-1000-1042H



Typical gain	21.5 dB
P _{out} max (NTSC)	1 W peak sync
P _{out} max (8VSB)	0.4 W rms
P _{out} max (DVB-T)	0.25 W
P _{in} max	15 dBm
Frequency	50 – 1000 MHz
I _D max	0.47 Adc
V _D	24 Vdc

PB1000F-88-108-188XR



Typical gain	25 dB
P _{out} max (FM)	1050 W peak saturated at 50V
P _{out} max (DVB-T)	400 W
Frequency	87.5 – 108.1 MHz
I _D max	28 Adc
V _D	48 Vdc

PB1200F-86-110-574-25



Typical gain	25 dB
P _{out} max (FM)	1050 W peak saturated at 50V
P _{out} max (DVB-T)	400 W
Frequency	87.5 – 108.1 MHz
I _D max	28 Adc
V _D	48 Vdc

PB1200F-86-110-574-49



Minimum	25 dB
P _{out} max (FM)	1200 W peak saturated at 50V
Frequency	87.5 – 108.1 MHz
I _D max	32-36 Adc
V _D	32-50 Vdc

PB25C-86-110-xxx



Typical gain	40 dB
P _{out} max (8VSB)	25 W rms
Frequency	88 – 108 MHz
P _{in} max	10 dBm
I _D max	1.6 Adc
V _D	28 Vdc

PB1200C-86-110-574



Typical gain	25 dB
P _{out} min (FM)	1125 W (w/ 3.5 W input)
Frequency	86 – 110 MHz
P _{in} max	10 dBm
I _D typ	32 - 36 Adc
V _D	32 - 50 Vdc

Splitter/Combiner

If used, the splitter and combiner are used to split the RF signal into, and combine the amplified RF signal out of the final amplifier pallets, within an amplifier/transmitter enclosure. The splitter and combiner can be 2-, 3-, or 4-way depending on how many final pallets are used. Most designs are based on the simple isolated Wilkinson combiner design. Due to its electrical and mechanical symmetry, the Wilkinson design's performance over moderate bandwidths is superior to other types.

2-, 3-Way:

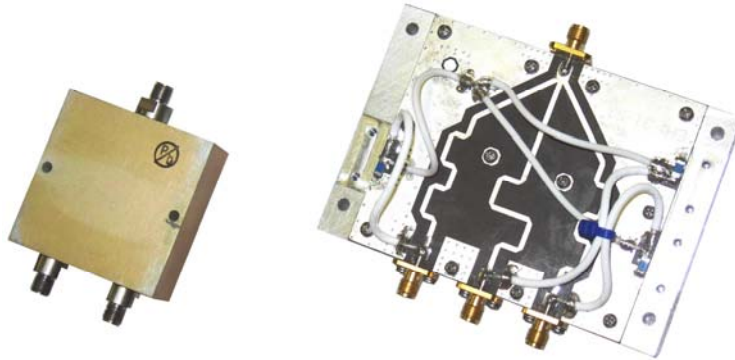

4-Way:

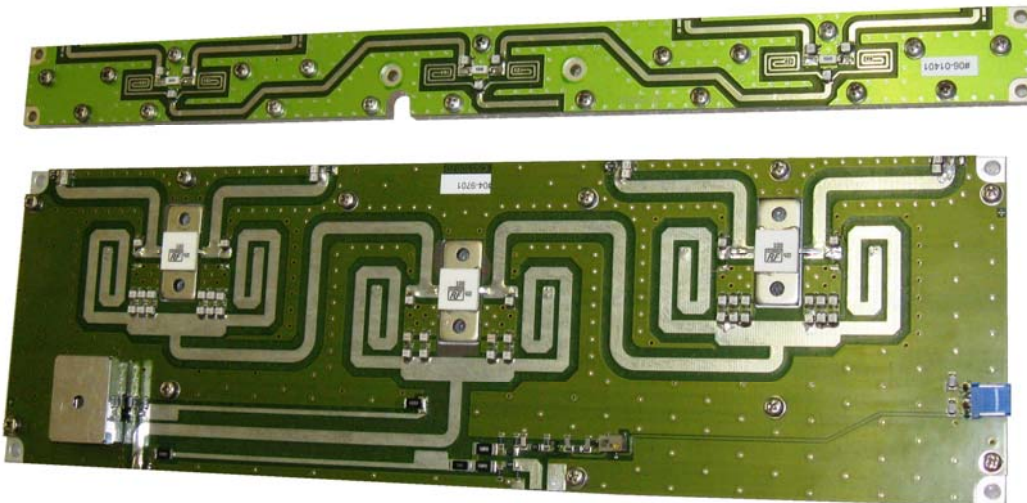

Directional Coupler

The dual directional coupler provides RF samples proportional to forward and reflected RF power to be converted to DC voltages for monitoring. These analog voltages are converted for processing using analog-to-digital converters and provide the control system with valuable data for monitoring purposes. Output power should be set following the operating procedure found elsewhere in this manual. The directional coupler uses Type N connectors on lower power systems and 7-16 DIN connectors are used for increased power handling capability. Other connectors are available upon request – this connector is typically the RF output connector on the back panel of the enclosure. On higher power systems, high power handling connectors are used, especially in the overall output combiner. On lower power systems, the coupler is typically based on microstrip architecture on the exciter circuit board.

Frequency Range	41 – 100 MHz (option A) 162 – 254 MHz (option B) 470 – 862 MHz (option C)
Max Output Power	2 kW DTV (3 kW ATV)
Coupling	-36 to -60 dB (on any channel)
Coupling variation	< ±0.15 dB 162 – 254 MHz < ±0.15 dB 470 – 862 MHz
Return Loss	> 30 dB (VSWR < 1.07)
Directivity	> 30 dB
Environmental Conditions	-5 to +55 °C (+23 to +131 °F)
Connectors	N, 7-16DIN, EIA 7/8" (dependent on power level)



Frequency Range	41 – 100 MHz (option A) 162 – 254 MHz (option B) 470 – 862 MHz (option C)
Max Output Power	20 kW DTV (30 kW ATV)
Coupling	-48 to -72 dB (on any channel)
Coupling variation	< ±0.15 dB 162 – 254 MHz < ±0.15 dB 470 – 862 MHz
Return Loss	> 30 dB (VSWR < 1.07)
Directivity	> 30 dB
Environmental Conditions	-5 to +55 °C (+23 to +131 °F)
Connectors	EIA 1-5/8" or 3-1/8" (dependent on power level)

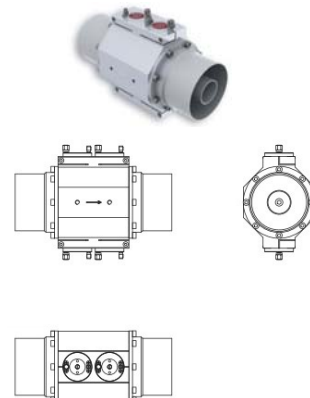

Filter

Our passive 50 ohm lowpass FM filters reject (and in some cases, absorb) spurious and harmonic output products and passes the modulated FM output carrier to the antenna or load.

150W LPF, no coupler



Frequency Range	86 – 110 MHz
Input Power (max)	150 W continuous
Insertion Loss (max)	< 0.3 dB
Insertion Loss (typ)	< 0.25 dB
Return Loss (max)	> 25 dB
Return Loss (typ)	> 28 dB
Rejection at 176 MHz	> -45 dB

250W LPF, no coupler



Frequency Range	86 – 110 MHz
Input Power (max)	250 W continuous
Insertion Loss (max)	< 0.3 dB
Insertion Loss (typ)	< 0.25 dB
Return Loss (max)	> 25 dB
Return Loss (typ)	> 28 dB
Rejection at 176 MHz	> -45 dB

800W LPF, no coupler



Frequency Range	86 – 110 MHz
Input Power (max)	800 W continuous
Insertion Loss (max)	< 0.25 dB
Insertion Loss (typ)	< 0.2 dB
Return Loss (max)	> 25 dB
Return Loss (typ)	> 28 dB
Rejection at 176 MHz	> -60 dB

1,200W LPF, with coupler



Frequency Range	86 – 110 MHz
Input Power (max)	1,200 W continuous
Insertion Loss (max)	< 0.2 dB
Insertion Loss (typ)	< 0.15 dB
Return Loss (max)	> 25 dB
Return Loss (typ)	> 30 dB
Rejection at 176 MHz	> -47 dB
Directivity (min)	25 dB

1,500W LPF, absorbing, no coupler



Frequency Range	87.5 - 108 MHz
Input Power (max)	1,500 W continuous
Insertion Loss (typ)	< 0.1 dB
Return Loss (typ)	> 30 dB
Rejection at 176 MHz	> 10 dB return loss

1,500W LPF, with coupler



Frequency Range	86 – 110 MHz
Input Power (max)	1,500 W continuous
Order	9 th order Chebyshev
Insertion Loss (max)	< 0.2 dB
Insertion Loss (typ)	< 0.15 dB
Return Loss (max)	> 25 dB
Return Loss (typ)	> 30 dB
Rejection at 176 MHz	> -47 dB
Directivity (min)	20 dB

1,500W LPF, with -50dB coupler

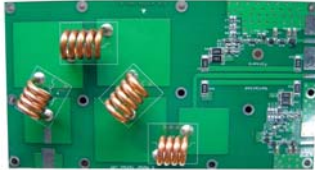

Frequency Range	86 – 110 MHz
Input Power (max)	1,500 W continuous
Order	9 th order Chebyshev
Insertion Loss (max)	< 0.12 dB
Insertion Loss (typ)	< 0.1 dB
Return Loss (max)	> 28 dB
Return Loss (typ)	> 33 dB
Rejection at 176 MHz	> -47 dB
Directivity (min)	20 dB

2,000W LPF, no coupler

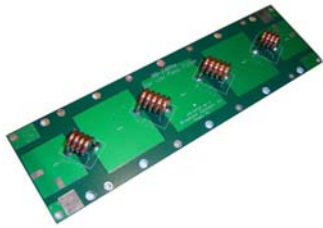

Frequency Range	86 – 110 MHz
Input Power (max)	2,000 W continuous
Order	9 th order Chebyshev
Insertion Loss (max)	< 0.12 dB
Insertion Loss (typ)	< 0.1 dB
Return Loss (max)	> 23 dB
Return Loss (typ)	> 25 dB
Rejection at 176 MHz	> -45 dB

3,600W LPF, with coupler



Frequency Range	MHz
Input Power (max)	3,600 W continuous
Order	9 th order Chebyshev
Insertion Loss (max)	< dB
Insertion Loss (typ)	< dB
Return Loss (max)	> dB
Return Loss (typ)	> dB
Rejection at 176 MHz	> dB
Directivity (min)	> - dB

Power Supply Components

Switching AC-DC power supplies are used to power the amplifier pallets, the control circuits, and all of the fans. The DC system voltage is set at either 24, 30, or 48Vdc nominally, depending on the system. All fans run off this same DC supply. The specific DC system voltage is found in the Final Inspection Report, and the model and number of power supplies, is documented in the Block Diagram supplied in the Quickstart package.

AC is fed into the power supply enclosure via a filtered AC entry and then through a circuit breaker/switch. Specific AC current draw is documented in the Final Inspection Report supplied in the Quickstart package. AC is then converted to DC using one or more AC-DC switching power supplies.

The following is the switching power supply data sheet(s) used to convert the AC to DC for the internal amplifier or transmitter components.



■ Features :

- AC input active surge current limiting
- AC input range selected by switch
- Protections: Short circuit / Overload / Over voltage / Over temperature
- Forced air cooling by built-in DC fan
- Built-in remote sense function
- LED indicator for power on
- UL approved
- Low cost, high reliability
- 100% full load burn-in test
- 2 years warranty



SPECIFICATION

MODEL	SE-450-3.3	SE-450-5	SE-450-12	SE-450-15	SE-450-24	SE-450-36	SE-450-48	
OUTPUT	DC VOLTAGE	3.3V	5V	12V	15V	24V	36V	48V
	RATED CURRENT	75A	75A	37.5A	30A	18.8A	12.5A	9.4A
	CURRENT RANGE	0 ~ 75A	0 ~ 75A	0 ~ 37.5A	0 ~ 30A	0 ~ 18.8A	0 ~ 12.5A	0 ~ 9.4A
	RATED POWER	247.5W	375W	450W	450W	451.2W	450W	451.2W
	RIPPLE & NOISE (max.) Note.2	200mVp-p	200mVp-p	200mVp-p	200mVp-p	200mVp-p	200mVp-p	200mVp-p
	VOLTAGE ADJ. RANGE	2.97 ~ 3.63V	4.5 ~ 5.5V	10.8 ~ 13.5V	13.5 ~ 16.5V	21.6 ~ 28.5V	32.4 ~ 39.6V	43.2 ~ 52.8V
	VOLTAGE TOLERANCE Note.3	±3.0%	±3.0%	±1.0%	±1.0%	±1.5%	±1.0%	±1.0%
	LINE REGULATION	±0.5%	±0.5%	±0.3%	±0.3%	±0.2%	±0.2%	±0.2%
	LOAD REGULATION	±2.0%	±2.0%	±0.5%	±0.5%	±0.5%	±0.5%	±0.5%
	SETUP, RISE TIME	1500ms, 50ms/230VAC 1500ms, 50ms/115VAC at full load						
HOLD UP TIME (Typ.)	16ms/230VAC 12ms/115VAC at full load							
INPUT	VOLTAGE RANGE	90 ~ 132VAC / 180 ~ 264VAC selected by switch 254 ~ 370VDC						
	FREQUENCY RANGE	47 ~ 63Hz						
	EFFICIENCY (Typ.)	74%	78%	83%	84%	86%	86%	88%
	AC CURRENT (Typ.)	10A/115VAC 6A/230VAC						
	INRUSH CURRENT (Typ.)	35A/115VAC 55A/230VAC						
	LEAKAGE CURRENT	<2.5mA / 240VAC						
PROTECTION	OVERLOAD	105 ~ 150% rated output power Protection type : Shut down o/p voltage, re-power on to recovery						
	OVER VOLTAGE	3.8 ~ 4.6V	5.75 ~ 6.75V	13.8 ~ 16.2V	18 ~ 21V	32 ~ 36V	45 ~ 52V	57.6 ~ 67.2V
	OVER TEMPERATURE	80°C±5°C(3.3 ~ 12V), 90°C±5°C(15 ~ 48V) (TSW1) detect on heatsink of power transistor Protection type : Shut down o/p voltage, recovers automatically after temperature goes down						
ENVIRONMENT	WORKING TEMP.	-10 ~ +60°C (Refer to output load derating curve)						
	WORKING HUMIDITY	20 ~ 90% RH non-condensing						
	STORAGE TEMP., HUMIDITY	-40 ~ +85°C, 10 ~ 95% RH						
	TEMP. COEFFICIENT	±0.05%/°C (0 ~ 50°C)						
	VIBRATION	10 ~ 500Hz, 2G 10min./1cycle, 60min. each along X, Y, Z axes						
SAFETY & EMC	SAFETY STANDARDS	UL60950-1 approved						
	WITHSTAND VOLTAGE	I/P-O/P:3KVAC I/P-FG:1.5KVAC O/P-FG:0.5KVAC						
	ISOLATION RESISTANCE	I/P-O/P, I/P-FG, O/P-FG:100M Ohms / 500VDC / 25°C/ 70% RH						
OTHERS	MTBF	200K hrs min. MIL-HDBK-217F (25°C)						
	DIMENSION	225*124*50mm (L*W*H)						
	PACKING	1.25Kg;12PCS/16Kg/1CUFT						
NOTE	1. All parameters NOT specially mentioned are measured at 230VAC input, rated load and 25°C of ambient temperature. 2. Ripple & noise are measured at 20MHz of bandwidth by using a 12" twisted pair-wire terminated with a 0.1uf & 47uf parallel capacitor. 3. Tolerance : includes set up tolerance, line regulation and load regulation.							

Mechanical Specification

Case No. 986 Unit:mm

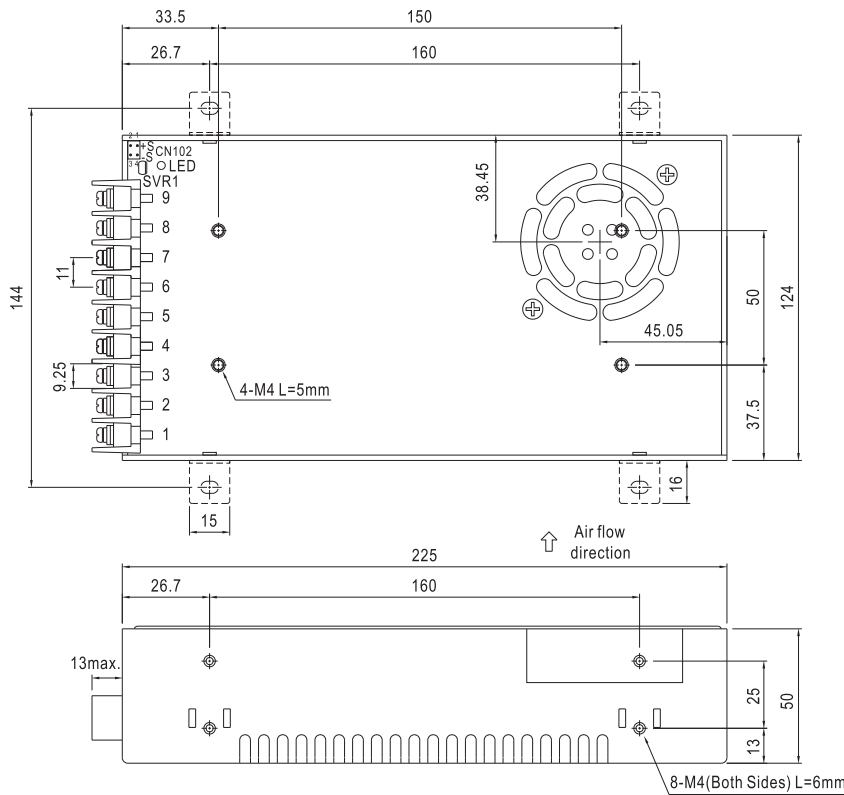

CN102:Remote Sense

Pin No.	Assignment
1,2	RS+
3,4	RS-

Terminal Pin No. Assignment :

Pin No.	Assignment	Pin No.	Assignment
1	AC/L	4~6	DC OUTPUT -V
2	AC/N	7~9	DC OUTPUT +V
3	FG \perp		

Block Diagram

fosc : 100KHz

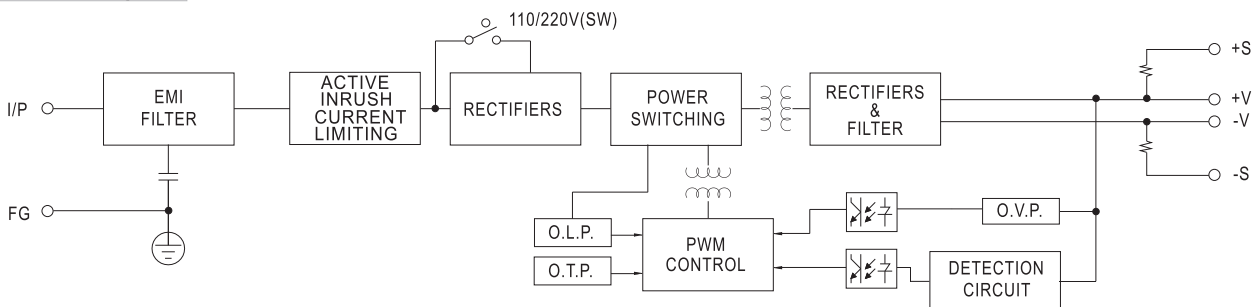

Derating Curve

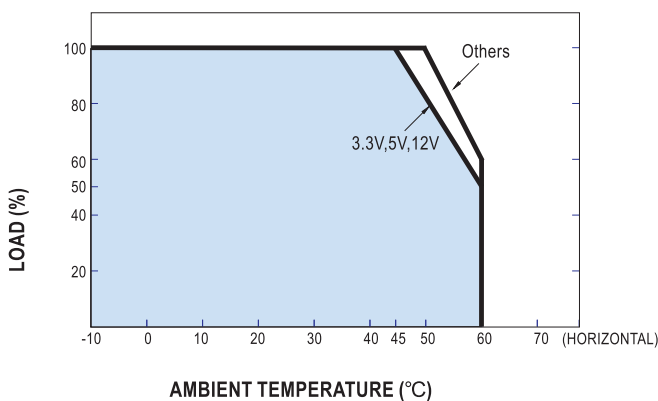

Static Characteristics

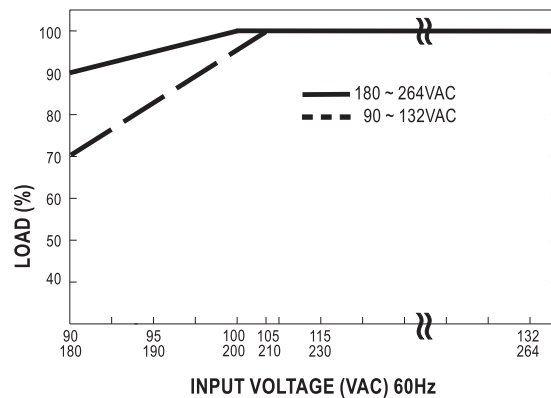

Maintenance

If your unit employs a filter on the air inlet for the fans, the filter should be cleaned every 30 days. If the equipment is operated in a severe dust environment, the filters on the inlet fan may need to be cleaned more regularly. Turn the system off and unplug all of the AC inlet cords. The filter can be lifted off the fan and cleaned using an air compressor at low pressure. While the filter is out, clean the fan blades themselves with a small brush. The fans themselves do not need lubrication.

The interior of the cabinets should be cleaned and inspected annually. Turn the system off and unplug all of the AC inlet cords. Remove the top lid by unscrewing the 6-32 machine screws.



Use extreme caution when working near the AC input terminal. The power amplifier/transmitter and power supply store hazardous capacitances and voltages.

Using either compressed air or a brush with soft bristles, loosen accumulated dust and dirt and then vacuum the interior of the cabinet. Complete a visual inspection of the interior, making sure there are no loose connections or discolorations on any components from heat. Nothing inside the power amplifier or transmitter enclosure exceeds a temperature that is not comfortable to the touch under normal operating conditions (unless it is RF!), so any signs of discoloration indicate potential damage.

All modular components inside the enclosure are attached to aluminium mounting plates for easy removal and replacement. Ensure that plates are secured and the mounting hardware is tight.

Troubleshooting

The first and most important aspect of troubleshooting anything is to be systematic. Note where you have looked and what you found.

Look first for the obvious.

- Make a physical inspection of the entire facility. Are all necessary connections properly made? Do you see any signs of obvious damage within the equipment?
- Is the AC power 'ON' to the site and the equipment? (Check fuses and circuit breakers if necessary.)
- Are all the switches in the correct operating position?
- Is the input signal present and at the correct level?
- Check display readings for presence of forward and reflected power and DC supply levels.

The following flowcharts are an aid in determining the fault if some aspect of the system is not operating.

AC-DC Power Supply (PSU) Troubleshooting

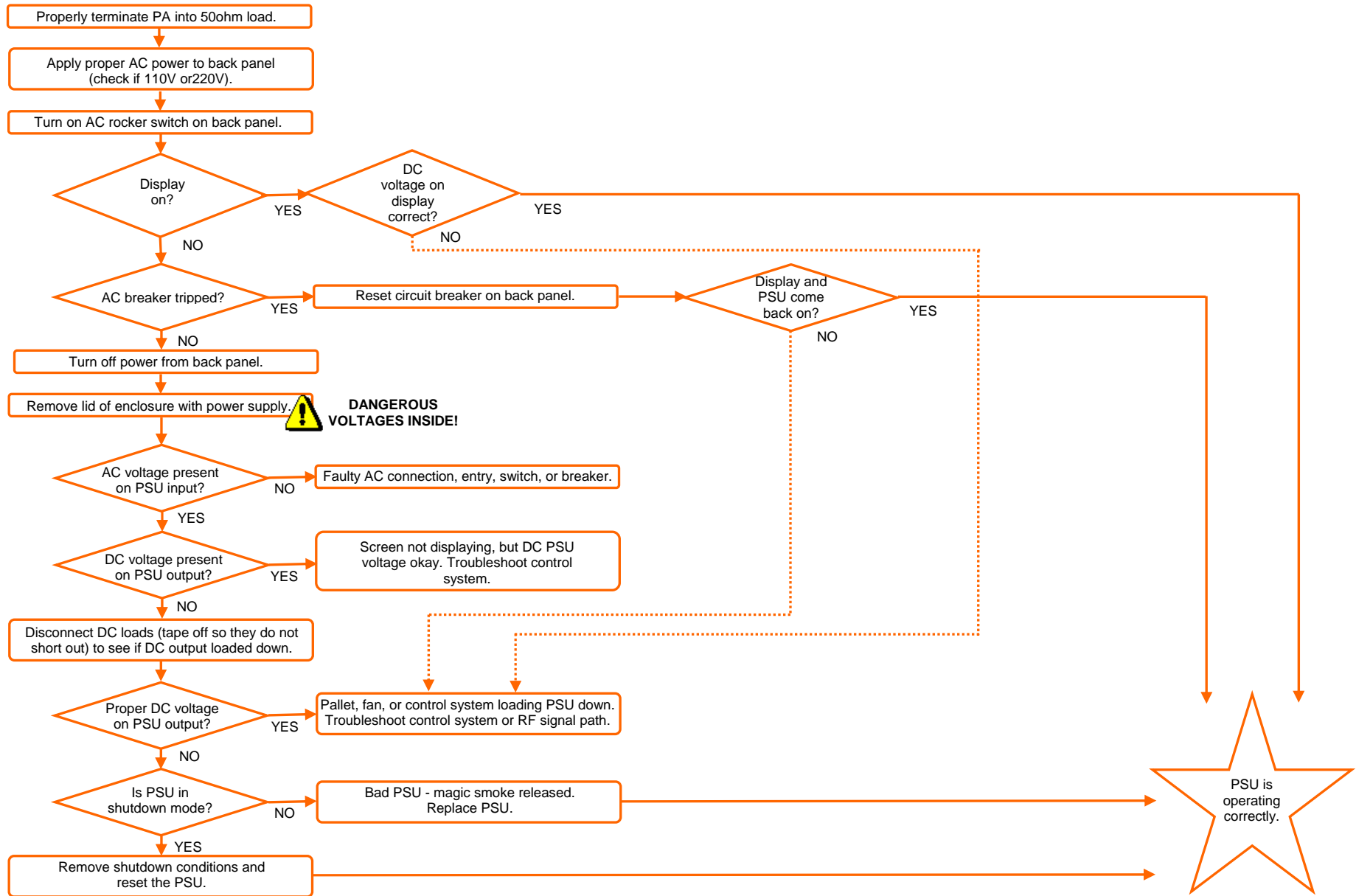

Control System (Adrenaline) Troubleshooting (1 of 2)

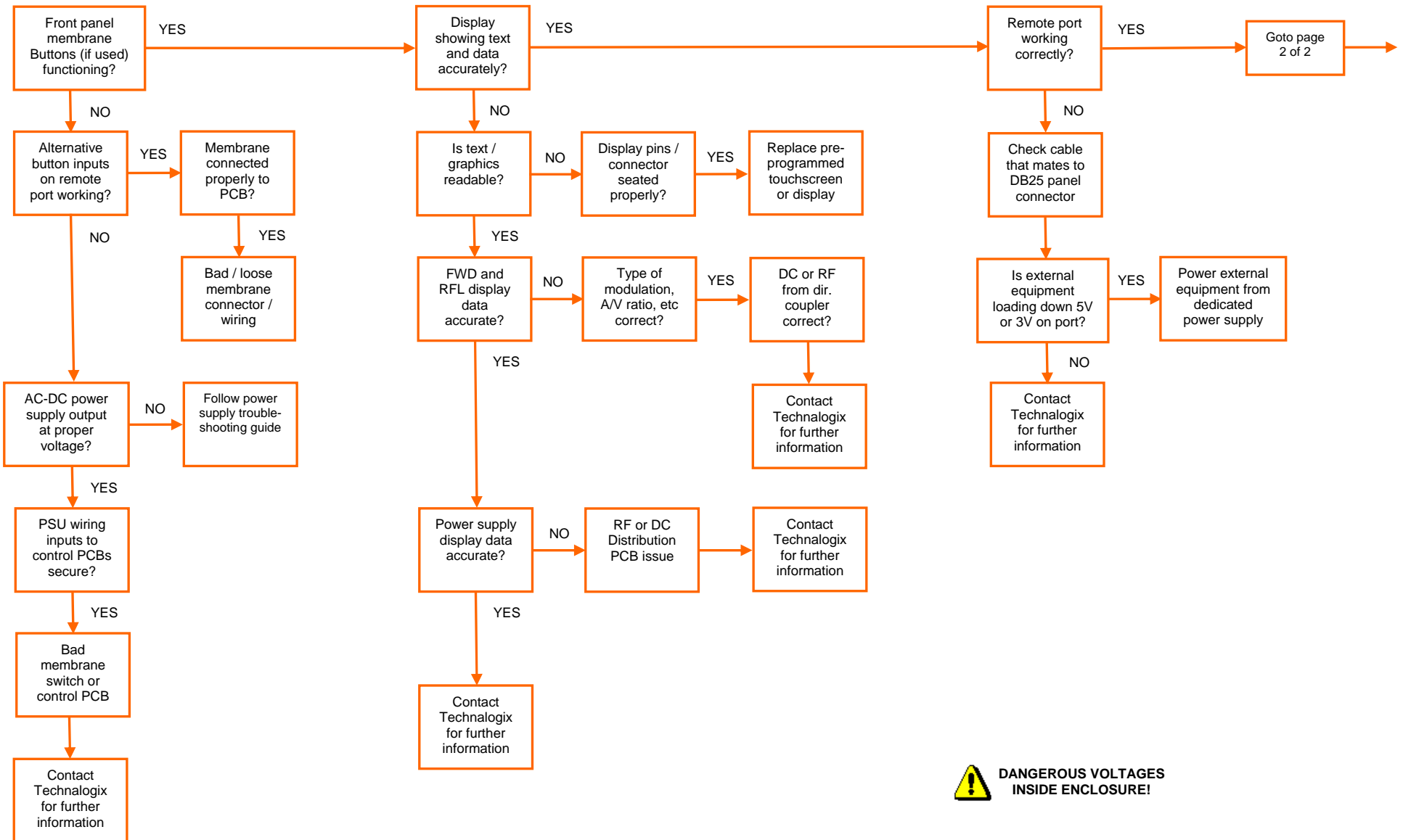

 **DANGEROUS VOLTAGES
INSIDE ENCLOSURE!**

Last Updated: 29-Aug-2011

Control System (Adrenaline) Troubleshooting (2 of 2)

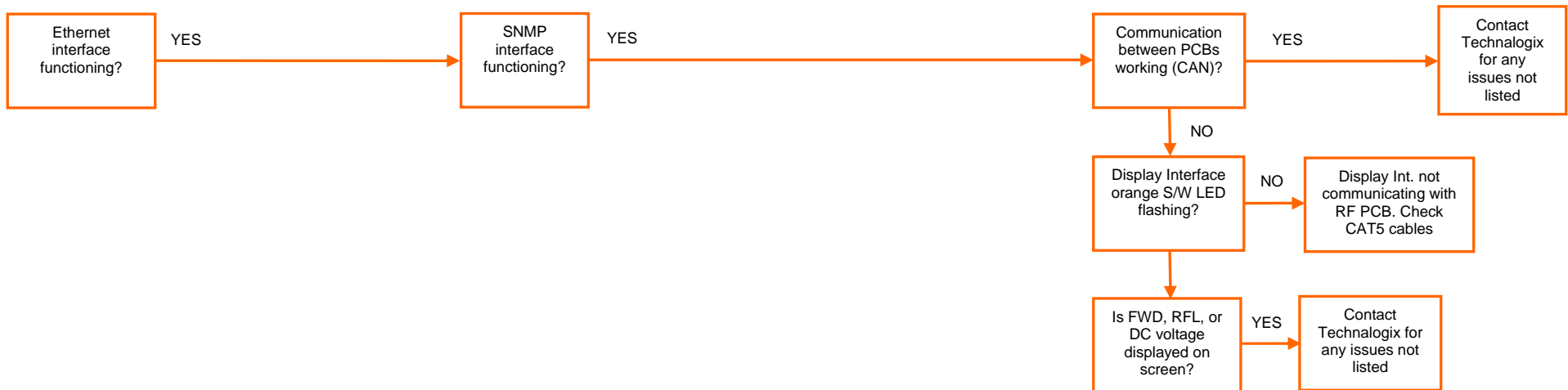

Last Updated: 29-Aug-2011

**Thank you
for choosing
Technalogix Ltd.**

If there is anything we can do to help in your success, please do not hesitate to contact us. We also welcome suggestions for product improvements or feature enhancements, as long as it is not a built in coffee maker.

TECHN\LOGIX.