

RCA

SATELLITE RECEIVER

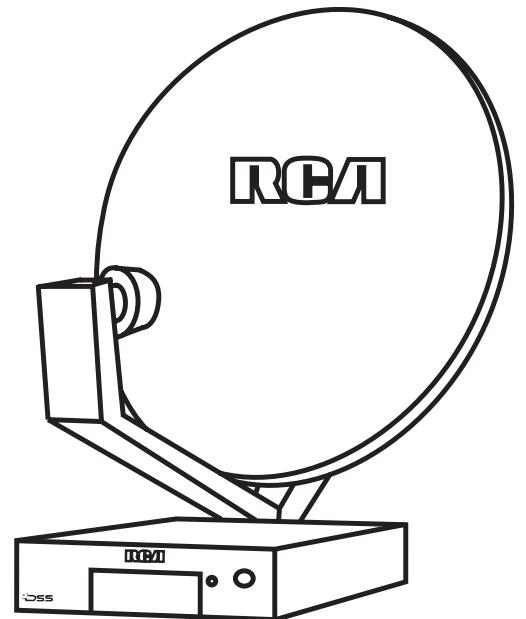

USER'S GUIDE

SAFETY INFORMATION

WARNING

To reduce risk of fire or shock hazard, do not expose this receiver to rain or moisture.

WARNING

RISK OF ELECTRIC SHOCK
DO NOT OPEN



This symbol indicates "dangerous voltage" inside the product that presents a risk of electric shock or personal injury.



This symbol indicates important instructions accompanying the product.

TO REDUCE THE RISK OF ELECTRIC SHOCK, DO NOT REMOVE COVER (OR BACK). NO USER SERVICEABLE PARTS INSIDE. REFER SERVICING TO QUALIFIED SERVICE PERSONNEL.

Cautions

Do not stack electronic components or other objects on top of the Receiver. The slots on top of the receiver must be left uncovered to allow proper airflow to the unit. Blocking the airflow to the unit could impair performance or damage your receiver and other components.

Do not stack the receiver on top of a "hot component" such as an audio power amplifier.

FCC Regulations state that unauthorized changes or modifications to this equipment may void the user's authority to operate it.

The RF remote control complies with part 15 of the FCC Rules. Operation is subject to the following two conditions: 1) The RF remote control may not cause harmful interference and; 2) The RF remote control must accept any interference received, including interference that may cause undesired operation.

Note to Cable TV Installer:

This reminder is provided to call your attention to Article 820-40 of the National Electrical Code (Section 54 of the Canadian Electrical Code, Part 1) which provides guidelines for proper grounding and, in particular, specifies that the cable ground shall be connected to the grounding system of the building as close to the point of cable entry as practical.

Note to Satellite Dish Installer:

This reminder is provided to call your attention to Article 810 and in particular article 810-15 of the National Electrical Code which covers proper installation and grounding of television receiving equipment as well as to article 820-40 of the National Electrical Code which specifies that the satellite dish cable ground shall be connected to the grounding system of the building as close to the point of cable entry as practical.

IMPORTANT NOTICE:

This device incorporates an anticopy process technology that is protected by U.S. patents and other intellectual property rights. The anticopy process is licensed for non-commercial, home use only. Reverse engineering or disassembly is prohibited.

Care and Cleaning:

Use a soft cloth or dusting attachment of your vacuum cleaner to dust your receiver. Remove dust from the ventilation holes on the top and bottom.

Plastic surfaces are easily scratched and can be marred by alcohol and various solvents. Avoid excessive use of oil-based furniture polishes since the materials used in the cabinet will accumulate more dust. A non-abrasive, anti-static cleaner/polisher is recommended.

TABLE OF CONTENTS

Setup and Connections	3
Step 1: Unpack the DSS® System	4
Step 2: Connect Your Receiver to Your TV and Other Devices	4
Things to Know Before Connecting Components	4
Jacks and Cables	5
Back of the Receiver	6
Basic Connection	7
Advanced Connection	8
Step 3: Connect the VCR Controller	9
Locating the VCR's Infrared Remote Control Sensor	9
Selecting a VCR Type	9
Step 4: Find the Video Input Channel on Your TV	11
Step 5: Interactive Setup	12
Step 6: Place Batteries in the Remote Control	12
STEP 7: Plug in and Turn on the System	12
Step 8: Order DSS® Programming	13
Using the Remote	15
Remote Control Buttons	16
The Point and Select Method	18
Programming the Remote Control	19
TV Codes	21
VCR Codes	22
Cable Box Codes	23
Program Guides	25
Bringing Up the Program Guides	26
Anatomy of a Program Guide	26
The Channel Banner	27
Using the GUIDE Button	28
Getting Around in the Guides	28
Tuning to a Program	29
Additional Program Guides	30
Sorting the Guides	32
The Menu System	39
Using the Menu System	40
Back and Help	40
Menu Descriptions	41
The Program Guide	42
The Mailbox	43
How to Tell When You Have Mail	43
Checking Your Mail	43

TABLE OF CONTENTS

Pay-Per-View Programs	44
Purchasing and Previewing	44
Tuning to a PPV Program	44
Using the Purchases Menu	47
Reviewing and Canceling an Upcoming Purchase	47
Spending Limits	48
Timers Feature	49
Profiles	51
Creating a Profile Channel List	52
Setting the Ratings Limit	53
Viewing Hours	54
Setting Up Spending Limits	54
Locking a User's Profile	55
Locking the System	56
Choosing Your Profile	57
Options	57
Look and Feel	58
System Options	59
Audio Language	60
Alternate Data	60
The Dish Pointing Menu Screen	61
Using the On-Screen Signal Meter	62
Home Control	63
Edit Fetch Menu	65
Customizing the Fetch Menu	66
Customizing the FETCH Button	66
Troubleshooting	69
Appendix A: Warranty Information	74
Appendix B: FCC Regulations	75
Appendix C: Accessories	76
Appendix C: Accessories	77
Index	78

DSS® is a registered trademark of DIRECTV, Inc., a unit of Hughes Electronics Corp.

StarSight-Licensed: The manufacture and sale of the television schedule feature of this product was licensed under one or more of the following patents of StarSight Telecast, Inc.; U.S. Patent Nos. 4,706,121; 4,977,455; 5,151,789; 5,335,277; and 5,353,121.

SETUP AND CONNECTIONS

GETTING STARTED

This manual is designed to get you started quickly. The first three sections of the manual introduce you to your DSS® system, and show you how to use the on-screen guides and menus.

In *Setup and Connections*, you'll learn:

- different ways to connect the receiver to your TV
- how to connect the VCR controller
- how to order programming
- how to program the remote control

Using the Remote defines the buttons of the remote and how to program it to control other components.

Program Guides details the items and features associated with the different guides.

THE REST OF THE MANUAL

The rest of the book includes menu information, troubleshooting information—such as running a system test—and an index.

1 SETUP AND CONNECTIONS



2 USING THE REMOTE



3 PROGRAM GUIDES



4 THE MENU SYSTEM



5 TROUBLESHOOTING

SETUP AND CONNECTIONS

STEP 1: UNPACK THE DSS® SYSTEM

Make sure to locate the remote control and the VCR controller.

STEP 2: CONNECT YOUR RECEIVER TO YOUR TV AND OTHER DEVICES

During the satellite dish antenna installation, the receiver may have been connected to your TV with just a coaxial cable for the system test. Depending on what components you have, another connection may provide better picture and audio quality. The following sections provide cable and connection information to help you decide what connection is best for you.

THINGS TO KNOW BEFORE CONNECTING COMPONENTS

Protect Your Components from Power Surges

- Connect all components before plugging any power cords into the wall outlet.
- Always turn off the receiver, TV and other components before you connect or disconnect any cables.

Position Cables Correctly to Avoid Audio Hum or Interference

- Insert all cable plugs firmly into their jacks.
- Place the audio/video cables to the sides of the TV's back panel instead of straight down the middle after you connect your components.
- Try not to coil any twin-lead cables and keep them away from the audio/video cables as much as possible.
- Make sure all antennas and cables are properly grounded. Refer to the Safety Tips sheet packed with your unit.

Protect Your Components from Overheating

- Do not block ventilation holes in any of the components. Arrange the components so that air can circulate freely.
- Do not stack components.
- Allow adequate ventilation when placing your components in a stand.
- Place an amplifier or receiver on the top shelf of the stand so heated air rising from it will not flow around other components.

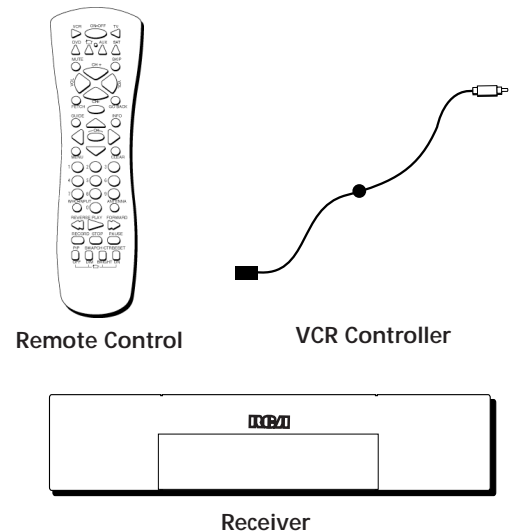

SETUP AND CONNECTIONS

JACKS AND CABLES

S-Video Jack and Cable

The S-Video jack provides the best picture quality for your satellite system.

This jack is available on many TVs and is used in conjunction with audio cables to connect the receiver to your TV. Remember also to connect the left and right audio cables because the S-Video jack carries only the picture signal, not the sound.

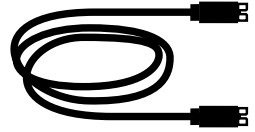

Audio/Video Jacks and Cables (RCA-type)

The audio/video jacks provide very good picture and stereo sound quality, and should be used if your TV has no S-Video jack.

These jacks are used for most audio/video connections between components. The receiver audio/video jacks are color coded (yellow for video, red for right audio, and white for left audio). If your TV has only one input for audio (mono), connect it to the right (red) audio jack on the receiver.

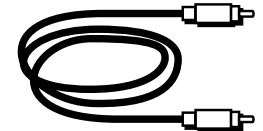

RF Jacks and Coaxial Cables (F-type)

The RF jacks provide good picture and mono sound quality, and are to be used if audio/video connections are not available for your TV.

These jacks are required for antenna or cable-TV connections. The RF jacks on the receiver are labeled IN FROM ANT and OUT TO TV. The coaxial cable supplied with your DSS® system is used to connect the RF jacks between the receiver and your TV's antenna input.

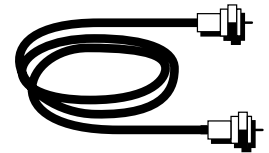

VCR Controller Jack and Cable

The VCR controller cable plugs into a jack on the receiver's back panel. The other end of the cable affixes to your VCR's remote sensor.



VCR Controller Jack

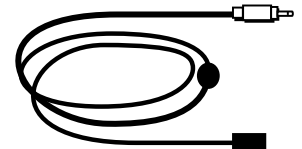

SETUP AND CONNECTIONS

BACK OF THE RECEIVER

The diagram below describes each of the back panel jacks found on your receiver. When connecting A/V cables, be sure to connect corresponding **OUTPUTS** and **INPUTS** (Video to Video, Right Audio to Right Audio, etc.).

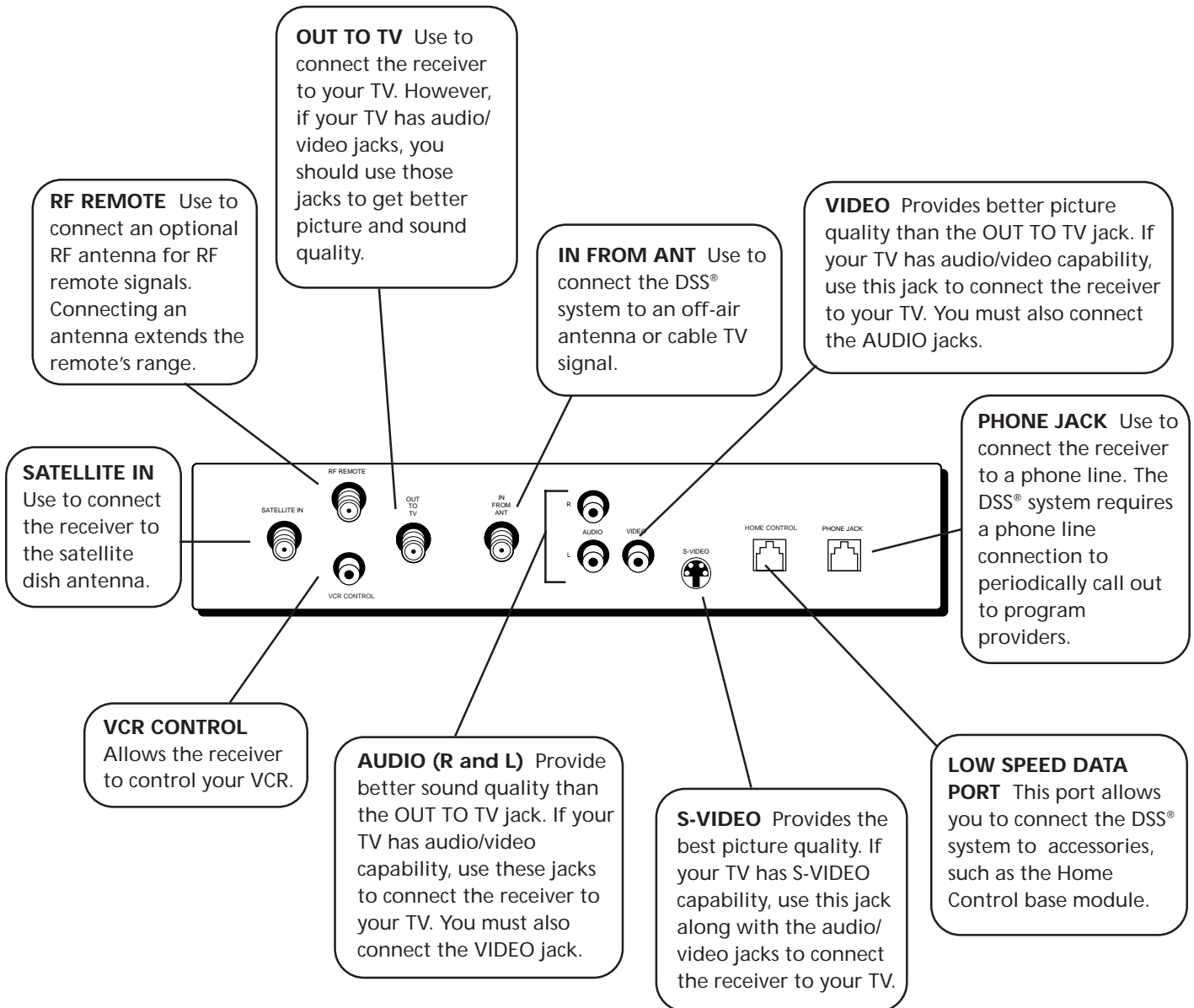

SETUP AND CONNECTIONS

BASIC CONNECTION

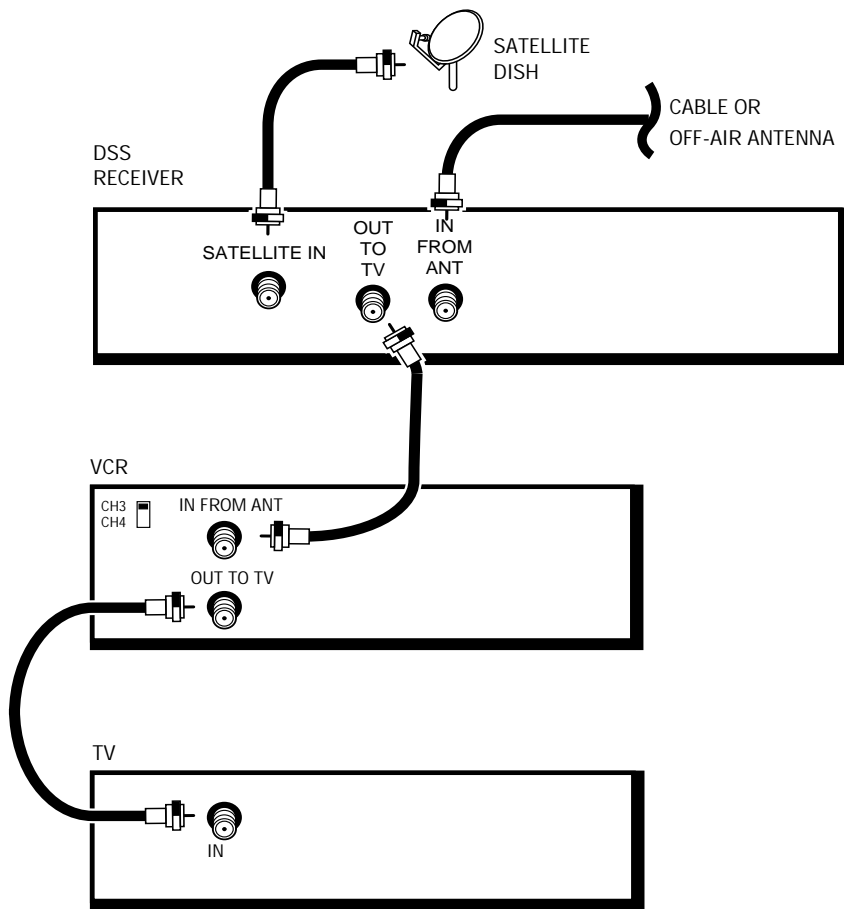

How to View Your Components

To watch the satellite receiver in this connection, tune the TV to either CH 3 or 4. (The default is CH 3. You may change the output channel to 4 by choosing *Systems Options* from the Main menu and selecting *Output Channel*.)

To record DSS® programming, tune the receiver to the desired channel and set your VCR to record on channel 3 or 4.

To view VCR recordings, tune the TV to the VCR output channel (usually CH 3 or 4) and set your VCR to play. If your VCR is a brand other than RCA, GE, or ProScan, you may need to program the remote to control the VCR. See the next section, *Programming the Remote*.

CAUTION

Do not stack electronic components or other objects on top of the receiver. See *Safety Information*, inside front cover.

SETUP AND CONNECTIONS

ADVANCED CONNECTION

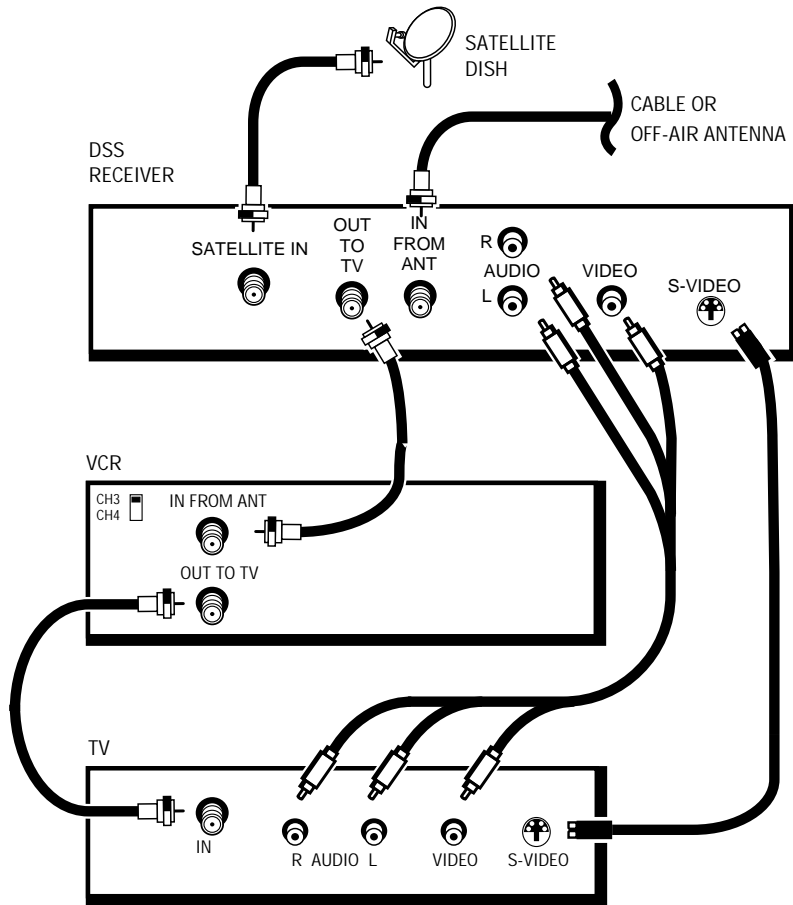

How to View Your Components

To watch the satellite receiver in this connection, tune the TV to the video input channel. (To find your TV's video input channel, follow Step 3 on the next page). Then tune the receiver to the desired channel.

To record DSS® programming, tune the receiver to the desired channel. Then set your VCR to record on channel 3 or 4.

To view VCR recordings, tune the TV to the VCR output channel (usually channel 3 or 4) and set your VCR to play. If your VCR is a brand other than RCA, GE, or ProScan, you may need to program the remote to control the VCR. See the next section, Programming the Remote.

CAUTION
Do not stack electronic components or other objects on top of the receiver. See Safety Information, inside front cover.

SETUP AND CONNECTIONS

STEP 3: CONNECT THE VCR CONTROLLER

In order for the receiver and VCR to communicate, you need to attach the VCR Controller to the back of the receiver.

1. Plug the VCR Controller into the VCR CONTROL jack on the back of the receiver.
2. Affix the other end to the remote sensor on your VCR.

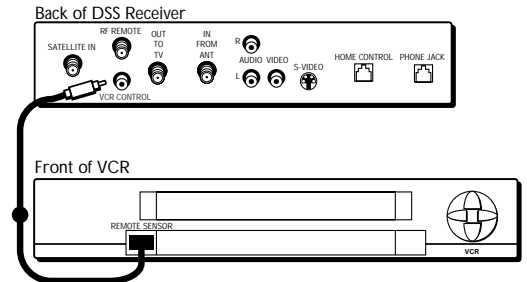

LOCATING THE VCR'S INFRARED REMOTE CONTROL SENSOR

The VCR Controller must be affixed directly over the infrared remote sensor on your VCR.

Some VCRs have a label that identifies the infrared remote sensor, and others do not. If the IR sensor is labeled on your VCR, affix the VCR controller directly over the sensor.

For VCRs that do not label the remote sensor, you need to use the VCR's remote to locate the sensor before affixing the VCR controller.

1. Hold the VCR's remote control so that it is touching the front of the VCR.
2. Slowly move the remote over the front of the VCR while pressing the remote power button on and off.
3. When your VCR turns off or on, you have located the sensor.

To test the VCR controller, use a piece of clear tape to temporarily attach the VCR controller to the spot where you think the sensor is located, and then follow the steps described under "Selecting a VCR Type."

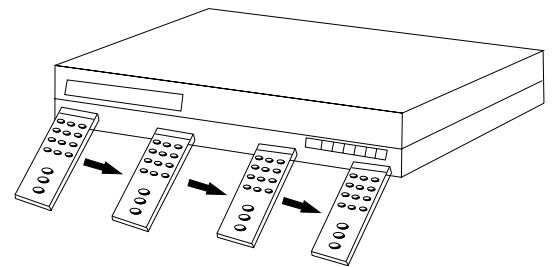

SELECTING A VCR TYPE

You need to tell the receiver which VCR brand you are using.

1. Press MENU on the remote to bring up the Main menu.
2. Point to *Options* and press OK.
3. Point to *System Options* and press OK.
4. Point to *Set VCR Type* and press OK.

If the Main menu doesn't appear when you press MENU, the remote might not be in DSS® mode. Try pressing the SAT button on the remote, and then MENU.

SETUP AND CONNECTIONS



The Set VCR Type screen lets you enter a code for your VCR.

5. Use the arrows or digit keys to input the correct code for your VCR brand. The VCR codes are located in the "Using the Remote" section of this book.
6. Follow the on-screen instructions to ensure that you are using the correct code. If the VCR automatically stops, then you know that the receiver and the VCR are communicating.

 - Some VCR brands may not be capable of being controlled by the receiver.

SETUP AND CONNECTIONS

STEP 4: FIND THE VIDEO INPUT CHANNEL ON YOUR TV

- Note: You do not have to complete this step if you used the basic connection.

If you used the advanced connection, you must tune your TV to the Video Input Channel to see the DSS® screens. Since there are so many brands and models of TVs, there are just as many ways to access a TV's Line Input Channel. Below are some things you can try.

- If your TV brand is RCA, GE, or ProScan, press VCR on the remote that came with your receiver. Then press the WHO•INPUT button on the remote.
- If your TV brand is not RCA, GE, or ProScan, consult your TV Owner's Manual.

If you cannot find your TV Owner's Manual, you will have to investigate. You might access the TV's Video Input Channel by:

- pressing a button on the remote
- finding it through the TV's menu system
- tuning directly to it by pressing a specific channel number
- going through all channels in the list by pressing the channel up or down buttons on the TV

Below are lists of some of the different ways manufacturers label the Video Input Channel.

Video Channel Variations

Button/switch on the TV	Button on the TV Remote	Channel #
VIDEO	VID 1	00
SIGNAL	LINE	90
VID 1	VID	91
VID 2	VIDEO	92
S-VID	S-VID	VID 1
S-VIDEO	INPUT	VID 2
	SOURCE	
	AUX	

Signal Flow

The whole idea of choosing a Line Input Channel or Video Input Channel can be explained by Signal Flow (the way the signal flows through your components and ends up as a picture on your TV screen).

To learn more about how signal flow works, see the example in the Troubleshooting section.

SETUP AND CONNECTIONS

STEP 5: INTERACTIVE SETUP

If you self-installed your satellite dish antenna, you may have already used the interactive setup to find the dish pointing coordinates, acquire and fine-tune the signal, and run a system test.

If you need to run the interactive setup again, select *Options* from the Main menu, then select *Interactive Setup*.

If you just want to check your dish pointing coordinates, or run the signal strength meter, select *Dish Pointing* from the Main menu.

STEP 6: PLACE BATTERIES IN THE REMOTE CONTROL

Follow these steps whenever you need to install or change the batteries in your digital satellite receiver's remote.

1. Remove the cover from the battery compartment.
2. Insert batteries in the battery compartment, matching the + and – end of each battery.
3. Replace the cover.

STEP 7: PLUG IN AND TURN ON THE SYSTEM

Plug the end into the wall outlet, matching the wide blade of the plug with the wide slot in the outlet. Be sure to insert the plug completely.

To turn on the system, press the SAT button on the remote or on the ON•OFF button on the front panel. If your TV brand is RCA, GE, or ProScan, press the TV button on the remote to turn on the TV. If your TV brand is not RCA, GE, or ProScan, see the next section, *Using the Remote*, for details on how to use the remote to control your TV.

SETUP AND CONNECTIONS

STEP 8: ORDER DSS® PROGRAMMING

After you have installed your system, you should contact the service providers, DIRECTV and USSB to receive DSS® programming.

Programming with DIRECTV: Call 1-800-347-3288

Programming with USSB: Call 1-800-204-USSB

When you order programming, you need to know your Access Card number. To get the number, select *Options* from the Main menu, then *System Options*, and then select *System Test*.

Wait for the system to run all of its tests. The Access Card number is displayed at the end of the system test.

Write the Access Card number in the space below for easy reference:

SETUP AND CONNECTIONS

USING THE REMOTE

HOW TO USE YOUR UNIVERSAL REMOTE

This section defines the buttons of the remote and how to program it to control other components.

The universal remote can be programmed to control most brands of remote controllable VCRs, satellite receivers, and cable boxes. If you have an RCA, GE, or ProScan component, you probably don't need to program it at all.

1 SETUP AND CONNECTIONS



2 USING THE REMOTE



3 PROGRAM GUIDES



4 THE MENU SYSTEM



5 TROUBLESHOOTING

USING THE REMOTE

REMOTE CONTROL BUTTONS

ON•OFF Turns the device you are controlling on or off.

VCR Tells the remote to control the VCR.

TV Tells the remote to control the TV.

DVD Tells the remote to control the DVD player.

HOUSE ICON Tells the remote to control the home devices.

AUX Tells the remote to control other components, such as a cable box or laser disc player.

SAT Tells the remote to control the receiver.

MUTE Reduces the TV's volume to its minimum level. Press again to restore the volume.

SKIP This key is not used by the receiver.

CHAN UP/DOWN Use to scan up and down through the channels in the current channel list. If you are in the program guide or menu system, use the CHAN UP/DOWN buttons to page up and down a screen at a time.

VOL UP/DOWN Adjusts the audio volume.

FETCH Either brings up the Fetch menu or tells the receiver to take the action you programmed it to take.

GO BACK Moves you back and forth between your last two selected channels. In the menu system, returns you to the previous screen.

GUIDE Brings up the on-screen program guide. Press the GUIDE button several times to toggle through the different types of guides.

INFO Brings up the on-screen channel banner. Press again to get program details.

ARROWS Use the navigation arrows to move the on-screen highlight up, down, left, or right. Using the arrows to highlight a menu item is also called "pointing."

OK Selects a highlighted choice if you are already in the menu system.

MENU Displays the Main Menu.

CLEAR Removes the on screen displays and return to normal viewing.

DIGIT KEYS (0 - 9) Use the digit keys to tune directly to a channel. If you are in the menu system, use the digit keys to enter numbers for the time, date, channel and passwords.

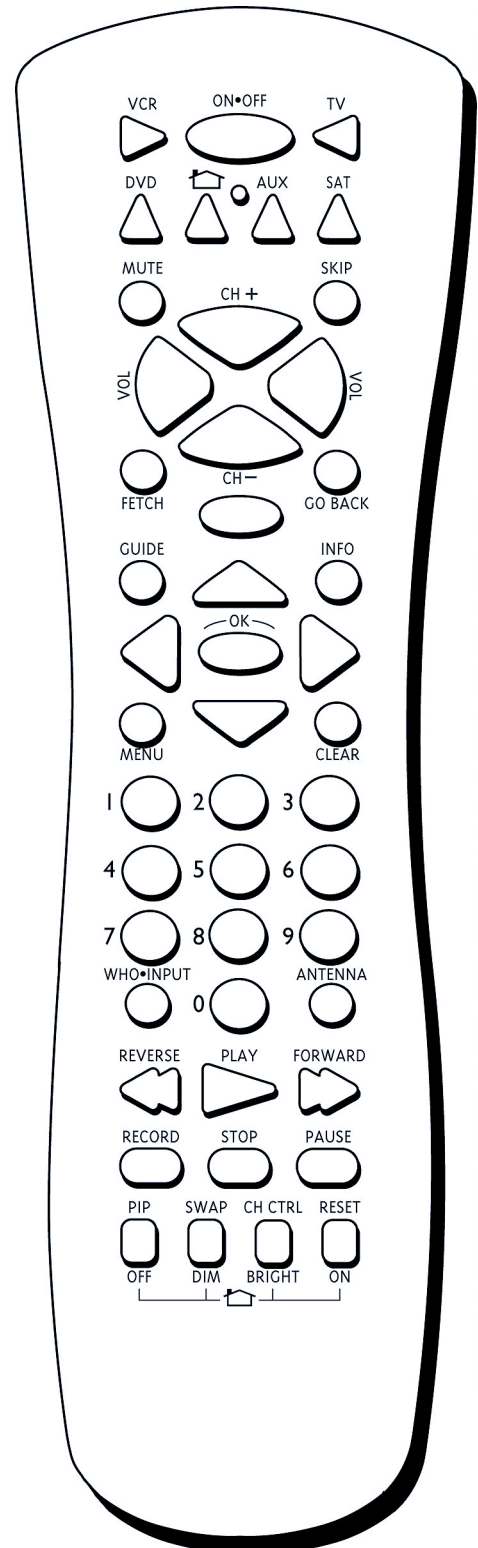

USING THE REMOTE

WHO•INPUT Press the WHO button one or more times to toggle through your user profiles.

ANTENNA Lets you switch the source of the video signal from satellite signals to an off-air antenna or cable signal when using the OUT TO TV jack.

TRANSPORT KEYS (REVERSE, PLAY, FORWARD, RECORD, STOP, PAUSE) Use when controlling an auxillary device, such as a VCR or Laserdisc player. Note that the RECORD button is used to schedule a timer recording when using the program guide.

PIP OFF Controls the display of the PIP window when in TV mode. When in home control mode, turns off the selected device.

SWAP DIM When in TV mode, controls the display of the PIP window. When in home control mode, dims the selected device.

CH CTRL BRIGHT When in TV mode, controls the channels. When in home control mode, brightens the selected device.

RESET ON When in TV mode, returns the video settings to the default. When in home control mode, turns on the selected device.

USING THE REMOTE

THE POINT AND SELECT METHOD

Point and Select is the two-step method you use to navigate through the menu system and program guides. Once you know how to point and select, you can explore the on-line menus.

1. POINT

You point by pressing the arrow keys on the remote. Pressing the arrow keys moves the on-screen highlight to different items in the program guide and the menu screens. Pressing an arrow once moves the highlight one space in the direction of the arrow.

For example, to point down (that is, to move the highlight toward the bottom of the screen), press the down arrow. To point right, press the right arrow.

2. SELECT

Once you have pointed to an item on the screen, select it by pressing the OK button on the remote. Selecting an item tells the menu system to go ahead and make the change you have indicated.

For example, the instructions in the User's Manual might tell you to Point to the *Back* button and press OK.

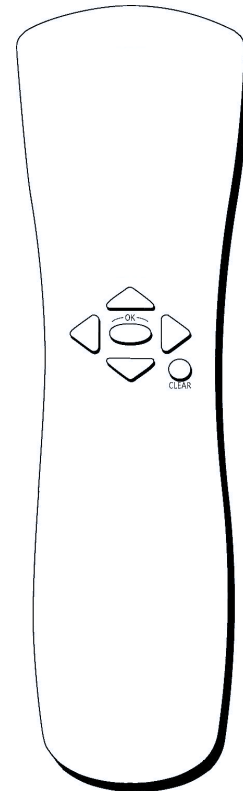

Don't worry about getting stuck inside a menu. Pressing the CLEAR button on the remote takes you out of the menu system and back to the program you were watching.

USING THE REMOTE

PROGRAMMING THE REMOTE CONTROL

The satellite system's remote can be programmed to control most brands of remote controllable TVs. The remote is programmed to control most RCA, GE and ProScan TVs. The remote needs to be programmed to control other manufacturers' brands.

This remote may not operate all models of the brands that are shown. Use the codes shown in this manual, or on the sheet packed with your remote.

TESTING THE REMOTE

To determine whether the universal remote needs to be programmed, turn a device ON, such as a VCR, point the remote at the VCR, and press the VCR button. Then press POWER or CH ^ (channel up) or CH v (channel down) to see if the VCR responds to the remote commands. If not, the remote needs to be programmed.

There are two ways to program the remote: automatic or direct entry.

Using Automatic Code Search

The following instructions can be used to program the remote to control each of the devices connected to your TV. If you want to exit the automatic code search without programming any of your devices, press CLEAR until the LED turns off.

1. Turn on the device you want to control (VCR, SAT, etc.)
2. Press and hold the button you want to program (VCR, AUX, etc.). While holding the device button, press and hold ON•OFF until the red light on the remote turns on, then release both buttons.
3. Press and release PLAY, then wait 5 seconds or until the LED stops flashing.

At this point the remote is searching for the correct code to program. If, after 5 seconds, the device you want to control does not turn off, press PLAY again to tell the remote to search the next set of codes.

Continue pressing PLAY until the device turns off or you have searched through all of the codes. There are 20 total sets of codes. If the device does not turn off after pressing PLAY 20 times, then the remote cannot control that particular device.

If the device you want to control *does* turn off:

1. Press and release REVERSE, then wait 2 seconds. Repeat this step until the device turns back ON.
2. To finish, press and hold STOP until the red light on the remote turns off.

USING THE REMOTE

Using Direct Entry

1. Turn on the component to be programmed.
2. Look up the brand and code number(s) for the component on the code list on the last page of this section, Using the Remote.
3. Press and hold the button on the remote you want to program.
4. Enter the code from the code list.
5. Release button, and then press ON•OFF to see if the component responds to the remote commands. If it doesn't, try pressing the component button and then ON•OFF again.
6. If you get no response, repeat these steps using the next code listed for your brand, until the component responds to the remote commands.

USING THE REMOTE TO CONTROL A DEVICE

Once the remote has been programmed successfully, you are ready to use it to control your devices.

To operate the device:

1. Press the device button (TV, VCR, DVD, or AUX) to set the remote to control the device.
2. Press ON•OFF to turn the device ON or OFF.
3. Use the remote buttons that apply to that device.

MODES OF OPERATION

Because this universal remote can control several different components (DVD player, VCR, Cable Box, etc.) it uses operational modes triggered by the component buttons. For example, if you want the remote to control the TV, you would press the TV button to put the remote into TV mode before you could control the TV.

USING THE REMOTE TO CONTROL A SECOND RECEIVER

The remote can control two receivers. From the Main menu, select *Options*, then *System Options*, then *Remote Setup*. Have the AUX button control the second receiver, while the first receiver is controlled by the SAT button.

USING THE REMOTE

TV Codes

A-Mark	102	Kawasho	002, 011, 027	Sampo	011, 027
Admiral	005, 114	Kenwood	006, 011, 014, 027	Samsung	006, 011, 014, 015, 019, 027, 036, 037, 077, 110
Akai	002, 103	Kloss Novabeam	035, 043	Sanyo	017, 021, 039, 056, 057, 058
Amtron	064	KTV	078	Scott	028, 037, 064
Anam	104, 105	Loewe	013	Sears.....	000, 006, 011, 014, 017, 018, 021, 023, 027, 039, 040, 041, 051, 071, 083, 095
Anam National	038, 106	Luxman	011, 027	Sharp....	011, 020, 025, 027, 037, 052, 053, 059, 060, 108
AOC.....	011, 019, 027, 088, 107	LXI	000, 013, 018, 021, 023, 054	Signature	005, 094, 108
Bell & Howell.....	005, 013	Magnavox....	006, 007, 010, 011, 013, 016, 027, 033, 035, 043, 049, 066, 087, 089	Sony	002
Candle.....	011, 027, 033	Marants	013	Soundesign	011, 027, 033
Citizen.....	011, 027, 033, 064	Marantz	011, 013, 027, 069	Sylvania.....	006, 007, 010, 011, 013, 016, 027, 033, 035, 043, 049, 066, 087, 089
Colortyme	011, 027, 084	Memorex	005	Symphonic	064, 076, 115
Concerto	011, 027	MGA.....	006, 011, 014, 019, 022, 027, 041, 056, 061, 068	Tatung	038
Contec/Cony .	036, 037, 040, 042, 064	Mitsubishi	006, 011, 014, 019, 022, 027, 041, 055, 056, 061, 068, 108, 117	Technics	012
Craig	064	MTC.....	011, 019, 027	Techwood	011, 027
Curtis Mathes	000, 011, 015, 027, 037	Multivision.....	081	Teknika	011, 019, 027, 033, 036, 037, 040, 066
CXC	064	NAD	018, 023	Telecaption	090
Daewoo	011, 019, 027, 112, 116	NEC	011, 014, 019, 027, 038, 084	TMK	011, 027
Daytron.....	011, 027	Panasonic.....	012, 013, 038, 086, 111	Toshiba	018, 021, 023, 040, 071, 077, 085, 090
Dimensia	000	Penney .	000, 008, 011, 019, 027, 040, 068, 077, 086, 088	Universal	008, 009
Electrohome	006, 011, 014, 027, 038, 061, 068	Philco ...	006, 007, 010, 011, 013, 016, 019, 027, 033, 035, 037, 038, 043, 087, 089	Victor	051
Emerson	011, 026, 027, 028, 029, 030, 031, 032, 037, 042, 053, 064, 065, 067, 075, 076, 078, 079, 094, 095, 096	Philips	002, 006, 007, 010, 011, 013, 016, 033, 035, 037, 038, 043, 066, 073	Vidtech	019, 027
Envision	011, 027	Pioneer .	011, 027, 045, 062, 093, 113	Wards.....	000, 005, 006, 007, 008, 009, 010, 011, 013, 019, 025, 027, 028, 035, 043, 059, 066, 076, 082, 089
Fisher	017, 021, 039, 041	Portland	011, 019, 027, 037	Yamaha	006, 014, 019, 027
Funai	064	ProScan	000	Zenith	001, 099, 114
GE.....	000, 008, 009, 011, 012, 027, 038, 068, 086, 089, 091, 116	Proton	011, 027, 037, 072, 118		
Goldstar	003, 004, 006, 011, 019, 027, 037, 050	Quasar	012, 038, 092, 111		
Hallmark	011, 027	Radio Shack	000, 021, 025, 036, 037, 059, 064, 078		
Hitachi	009, 011, 027, 036, 037, 040, 047, 048, 063, 080, 094, 097, 098	RCA	000, 006, 011, 019, 027, 034, 038, 044, 046, 088, 100, 101, 109		
Infinity	013	Realistic.....	021		
JBL.....	013				
Jensen	011, 027				
JVC	012, 024, 036, 037, 040, 048, 051, 074				

Laserdisc/DVD Player Codes

RCA	033, 037
RCA (DVD Player)	078
Pioneer	033, 033
ProScan	033, 037

USING THE REMOTE

VCR Codes

Admiral	006, 079	JVC	002, 014, 016, 030, 046, 074	Samsung	007, 013, 022, 032, 042
Aiwa	015	Kenwood	002, 014, 016,	Sansui	016, 071
Akai	003, 017, 022, 023, 063, 066	030, 044, 046	Sanyo	002, 012
Audio Dynamics	014, 016	KLH	073	Scott	004, 013, 041, 049, 068
Bell & Howell	002	Lloyd	015	Sears	002, 005, 009, 012,
Broksonic	010	Logik	031	018, 019, 035, 043, 048
Candle	007, 009, 013, 044,	Magnavox	008, 029, 053, 056	Sharp	006, 024, 027, 039, 045
.....	045, 046, 052	Marantz	002, 008, 014, 016, 029,	Shintom	017, 026, 031, 055
Canon	008, 053	030, 044, 046, 061	Signature	015
Capehart	001	Marta	009	Sony	017, 026, 038
Citizen	007, 009, 013, 044,	MEI	008	Sylvania	008, 015, 029, 053, 056
.....	045, 046, 052	Memorex	008, 009, 012, 015	Symphonic	015
Colortyme	014	MGA	004, 027	Tandy	002, 015
Craig	007, 012	Midland	032	Tashiko	009
Curtis Mathes	000, 007, 008, 014,	Minolta	005, 035	Tatung	030
.....	015, 044, 046, 053, 064, 067	Mitsubishi	004, 005, 027, 035, 040	Teac	015, 030, 069
Daewoo	013, 045, 052, 076	Montgomery Ward	006	Technics	008
dbx	014, 016	MTC	007, 015	Teknika	008, 009, 015, 021
Dimensia	000	Multitech	007, 015, 031, 032	Toshiba	005, 013, 019, 048, 049
Dynatech	015	NEC	002, 014, 016, 030, 044,	Totevision	007, 009
Electrohome	027	046, 059, 061, 064	TMK	067
Emerson	008, 009, 010, 013, 015,	Panasonic	008, 053, 075, 077	Unitech	007
.....	020, 023, 027, 034, 041, 042, 047,	Pentax	005, 035, 044	Vector Research	014, 016, 044
.....	049, 057, 062, 065, 067, 068, 070	Pentex Research +	046	Victor	016
Fisher	002, 012, 018, 019,	Philco	008, 029, 053, 056	Video Concepts	014, 016, 044
.....	043, 048, 058	Philips	008, 029	Videosonic	007
Funai	015	Pioneer	005, 016, 050	Wards ...	005, 006, 007, 008, 009, 012,
GE	000, 007, 008, 032, 037, 053	Portland	044, 045, 052	013, 015, 025, 027, 031, 035
Goldstar	009, 014, 046, 060	ProScan	000	Yamaha	002, 014, 016, 030, 046
Harman Kardon	014	Quartz	002	Zenith	011, 017, 026, 072, 079
Hitachi	005, 015, 035, 036	Quasar	008, 053		
Instant Replay	008	RCA	000, 005, 007, 008,		
JCL	008	028, 035, 037, 054, 069		
JC Penney	002, 005, 007, 008, 014,	Radio Shack/Realistic ..	002, 006, 008,		
.....	016, 030, 035, 051, 053	009, 012, 015, 019, 027, 043, 053		

USING THE REMOTE

Cable Box Codes

ABC	022, 046, 053, 054	NSC.....	009	Sprucer	027
Anvision	007, 008	Oak	001, 016, 038	Starcom.....	046
Cablestar	007, 008	Oak Sigma	016	Stargate 2000	058
Diamond	056	Panasonic.....	003, 027, 039, 061	Sylvania.....	011, 059
Eagle	007, 008	Philips	007, 008, 019, 021,	Teknika	006
Eastern Int.	002	026, 028, 029, 032, 033, 040, 041	Texscan	010, 011, 059
General Instument	046	Pioneer	018, 020, 044	Tocom	017, 021, 049, 050, 055
GI 400.....	004, 005, 015, 023,	RCA	000, 027	Unika	031, 032, 041
.....	024, 025, 030, 036	RCA (Satellite Reciever)	066	Universal	051, 052, 060
Hamlin	003, 012, 013, 034, 048	Randtek	007, 008	Viewstar	007, 008, 019, 021,
Hitachi	037, 043, 046	Regal.....	003, 012, 013	026, 028, 029, 032, 033, 040, 041
Jerrold... ..	004, 005, 015, 023, 024, 025,	Regency	002, 033	Warner Amex	044
.....	030, 036, 045, 046, 047, 062, 065	Samsung	044	Zenith	014, 042, 057, 061
Macom	037, 043	Sci. Atlanta ...	003, 022, 035, 063, 064		
Magnavox.....	007, 008, 019, 021,	Signature	046		
.....	026, 028, 029, 032, 033, 040, 041	Sony (Satellite Receiver)	095		

USING THE REMOTE

PROGRAM GUIDES

WHAT IS A PROGRAM GUIDE?

A program guide is an on-screen programming schedule. There are several types of guides, each presenting the schedule in a different format.

Using the program guide is easy as long as you remember the Point and Select rule. Point to items on the screen by pressing the arrow keys on the remote or front panel. Then, press OK to tune to that program.

1 SETUP AND CONNECTIONS



2 USING THE REMOTE



3 PROGRAM GUIDES



4 THE MENU SYSTEM



5 TROUBLESHOOTING

PROGRAM GUIDES

ANATOMY OF A PROGRAM GUIDE

The following diagram shows you the kind of information you will see in the program guides.

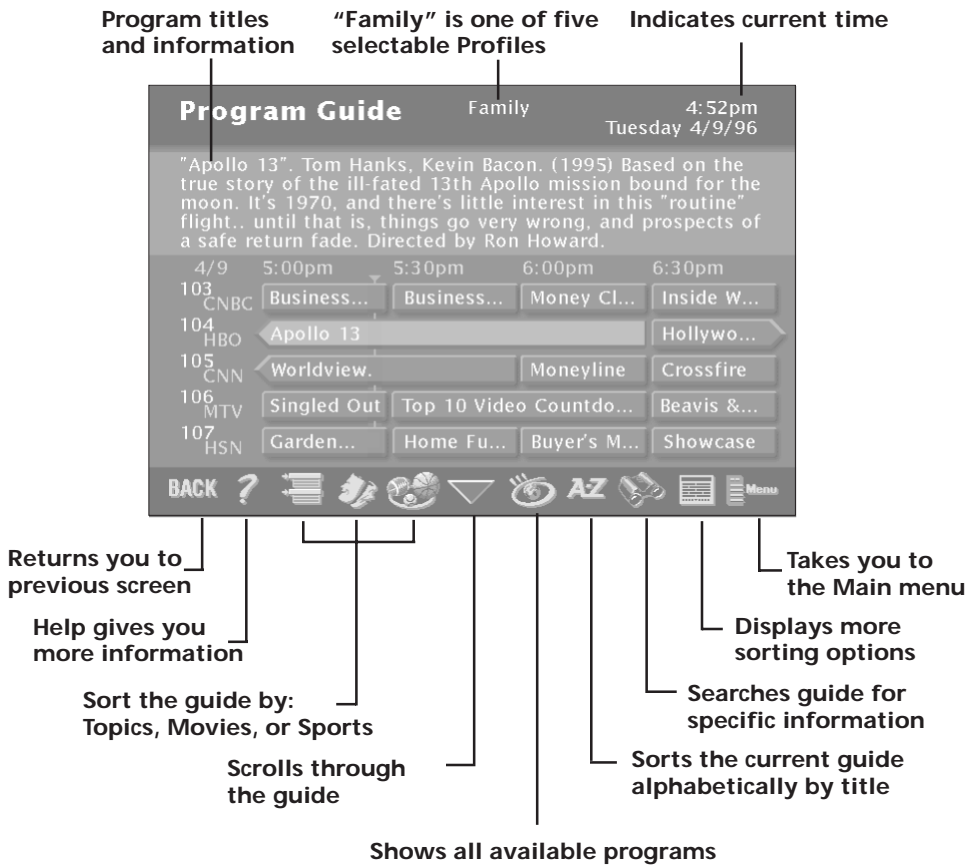

BRINGING UP THE PROGRAM GUIDES

You can access the program guides by pressing MENU on the remote and selecting *Program Guide*, or by using the GUIDE button on the remote.

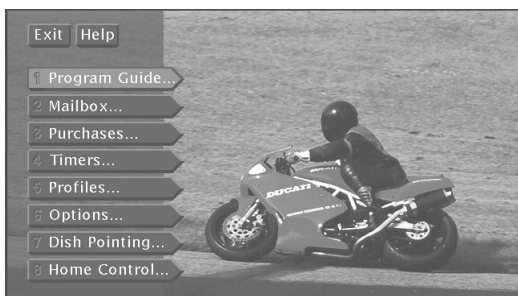

PROGRAM GUIDES

THE CHANNEL BANNER

The channel banner appears whenever you tune to a channel, exit a guide, or press INFO on the remote. Use the arrow buttons and OK to choose an item.

On-screen icons represent frequently-used menu items. Some icons also change appearance to show the item's status. Some of the items you select in the guides can also be selected in the channel banner.

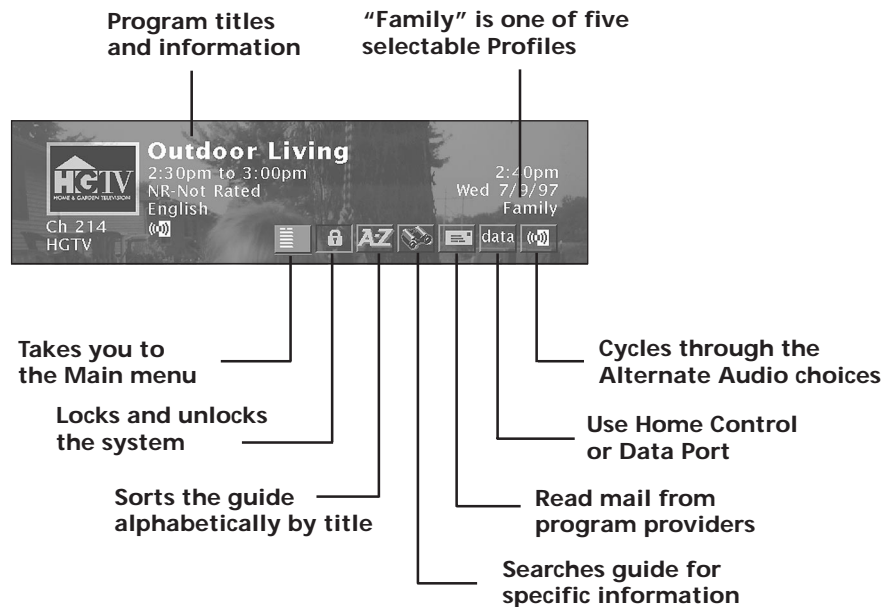

Main Menu icon When selected, will take you to the Main Menu.

Green Unlock icon The system is unlocked. Spending, viewing and other limits can be accessed and changed.

Yellow Unlock icon A password has been entered to override family or profile limits. No limits can be accessed or changed.

Yellow Unlock icon with a P A password has been entered to override limits for the current program. After the program ends, limits are restored.

Red Lock icon No limits can be accessed or changed. A password is required to override limits or access the system.

AlphaSort icon When selected, allows you to sort program titles alphabetically.

Highlighted Scout (binoculars) icon A Scout has found program information.

Highlighted Mail icon Indicates a message in your mailbox.

Home Control or Data Port icons The icon changes appearance depending on how the Home Control jack on the back panel is used.

Alternate Audio icon When selected, cycles through the alternate audio choices.

PROGRAM GUIDES

USING THE GUIDE BUTTON

Each press of the GUIDE button takes you to an alternate type of program guide.

The Detail Guide

The Detail Guide shows five channels in a time-and-channel format, with program information for the highlighted program.

The Grid Guide

The Grid Guide shows seven channels in a time-and-channel format.

The SurfGuide

The SurfGuide displays seven channels in a half-hour time-and-channel format. Press the right arrow button to extend the SurfGuide to show the next two hours.

GETTING AROUND IN THE GUIDES

This section describes how to change channels and move around the program guide.

Point to Channels with the number keys (0-9)

You can point quickly to any channel in the program guide by entering the channel number with the number keys (0-9). For example, to point to channel 228, press the numbers 2-2-8 on the remote. To point to channel 530, press 5-3-0.

Scrolling Channel By Channel

The programs that you see on the TV screen make up one section—or page—of the total program guide. You can scroll to other sections using the arrows: point to other times with the left and right arrows; point to other channels with the up and down arrows.

Scrolling Page By Page

If you want to scroll up or down through the program guide faster, press the Channel Up/Down buttons on the remote control. The highlight scrolls a page at a time.

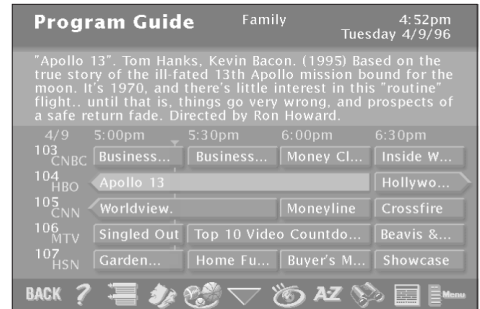

Detail Guide

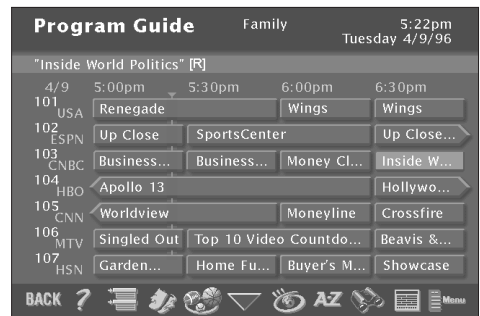

Grid Guide

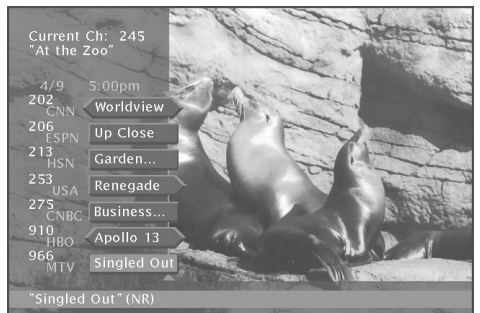

Surf Guide

By default, the Detail Guide appears when you press GUIDE on the remote. You can change the default guide from the Detail Guide to the Grid Guide or SurfGuide.

Select *Options* from the Main menu. Select *Look and Feel*, then set the *Default Guide*.

PROGRAM GUIDES

TUNING TO A PROGRAM

To tune directly to a current program listed in the guide, point to the program and press OK.

To see information about a program in the guide, press INFO.

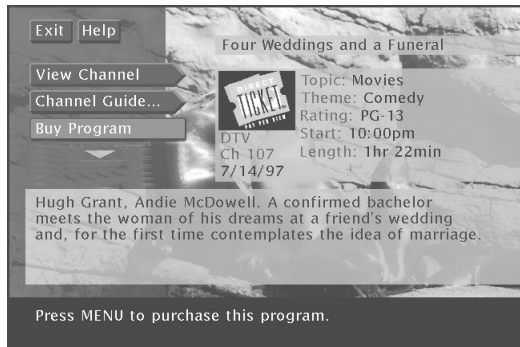

The Program Details screen appears and gives you several options.

Then, you can select:

- *View Channel* to tune to that channel
- *Buy Program* to purchase the program
- *Other Times* to see what other times the program is available. The program title is automatically entered and sorted in the AlphaSort control panel.

The options available to you may vary according to the type of program you select.

PROGRAM GUIDES

ADDITIONAL PROGRAM GUIDES

Besides the Detail Guide, Grid Guide, and SurfGuide, there are a few more guides: the Channel Guide, the Logo Guide and the Attractions Guide.

You can access these guides by selecting the *Other Guides* button at the bottom of the Detail Guide and Grid Guide.



Other Guides button

The Channel Guide

Displays a channel's programming schedule in a channel-by-channel format.

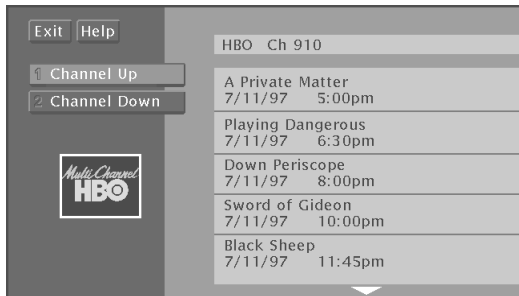

The Logo Guide

Displays channel logos for the current user's profile.



You can point to any program and tune to that channel or get more information. Just press the OK or INFO buttons.

Exiting A Program Guide

There are three ways to exit a guide:

- Point to a channel and press OK.
- Point to *Back* and press OK.
- Press CLEAR or GO BACK on the remote.

PROGRAM GUIDES

The Attractions Guide

Displays a list of channels that show coming attractions and special events information.



The *Other Guides* button also lets you sort the guide by different variables, such as future times, user profile channel lists, and channel groups. You can then choose a guide format to view the program information.

Select the *Other Guides* button. You can select multiple sort parameters. For example, you could sort the guide by pay-per-view movies that are available at a future time.

Select *Guide Data* and use the arrow and OK buttons to choose the *Guide Data* group.



Other Guides button

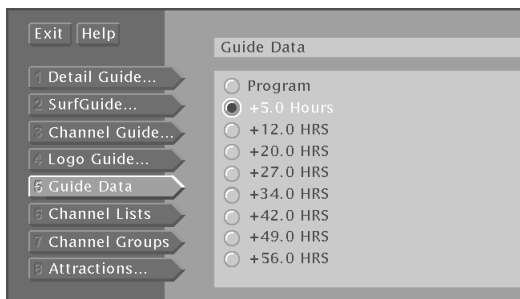

Guide Data lets you see what's on in the future.

PROGRAM GUIDES

Then, select *PPV* in the *Channel Groups* category.



Channel Groups is another way to sort types of programming.

Select *Back*, or press the GO BACK button on the remote to return to the previous guide. You can also choose another guide format from the category list.

SORTING THE GUIDES

Sorting the guide is a way of organizing the guide to show only the types of programs that interest you. There are several on-screen buttons that sort the guide in different ways.

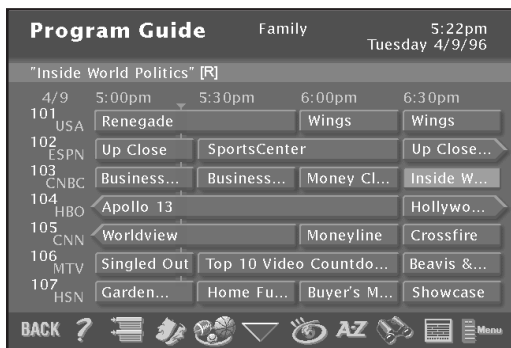

The Sorting buttons appear at the bottom of the Grid Guide and Detail Guide.

PROGRAM GUIDES

Topics

The *Topics* button sorts the guide according to the current user's preferences. Select the *Topics* button to sort the guide.

The *Topics* button changes to the *Topics Themes* button. Press the *Topics Themes* button to edit the current user's themes preferences. These preferences are saved in each user's profile.



Checkmark the themes that interest you.

Select the categories, and checkmark the themes you would like to appear when you select the *Topics* button in the guides. Programming that fits the description of checkmarked themes will appear in the guide when you sort by the *Topics* button.

Movies

Select the *Movies* button to list movies only. After selecting *Movies*, the *Movies* button changes to a *Movies Themes* button.

Select the *Movies Themes* button to sort the guide to list specific types of movies, such as comedies or musicals.

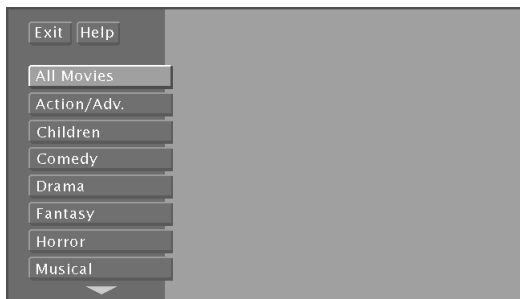

Select a Movies Themes that interests you.



Topics button



Topics Themes button



Movies button



Movies Themes button

PROGRAM GUIDES

Sports

Select the *Sports* button to list sporting events only. After selecting *Sports*, the *Sports* button changes to a *Sports Themes* button.

Select the *Sports Themes* button to sort the guide to list specific types of sports, such as basketball or soccer.



Select a *Sports Theme* that interests you.



Sports button



Sports Themes button

All

The *All* button resets the guide to show all available topics, channels and listings for the current Profile.

AlphaSort

AlphaSort lists in alphabetical order all the program titles in the current guide. Select the *AlphaSort* button to search for specific program titles that are in the current program guide. Use the arrow button to highlight a character, then press OK.

For example, to search for the program, *Auto Racing*, the first letter you should point to and select is "A". (Words like "The", "A" and "An" appear at the end of a title.) All titles that begin with "A" appear in the *AlphaSort* list. Next, enter the letter "U". All titles beginning with "AU" appear in the list.



All button



AlphaSort button

PROGRAM GUIDES



AlphaSort searches for specific titles in the guide.

Continue entering the specific title's letters until it appears in the *AlphaSort* list. If you enter the wrong letter, select either *Backspace* or *Clear All*.

Use the arrow buttons to highlight the title you are looking for. Press the OK button to select it, or the INFO button to see more information. Only titles that are in the current program guide can be found by AlphaSort.

Scout

The *Scout* button lets you assign "Scouts" to search the guide for very specific program information, such as actors' names or program descriptions. Select the *Scout* button from the Program Guide to view the available scouts.

Point to an available *Scout*, and select it. Select the *Enter Text* button to set up the information the *Scout* will look for in the program guide. Use the on-screen keyboard to enter the desired search parameters.

For example, if you are interested in National Basketball Association events, enter a common term you might see in program information, like "NBA".



Scout button

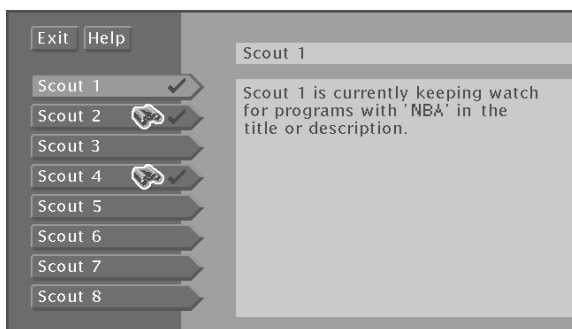

A checkmark next to the Scout means it is in use. A highlighted binocular icon means the Scout has found something.

PROGRAM GUIDES

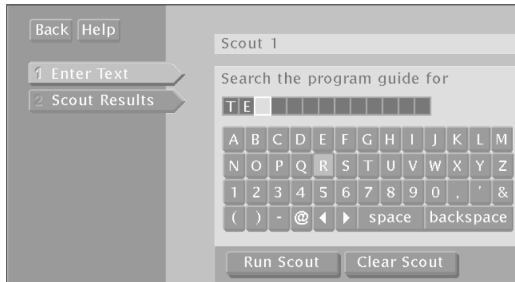

Select Enter Text to set up a Scout.

If "NBA" appears within a program title or program description, the program will be included in the Scout Results program list.

The Scout will search for information when the receiver is off. (This may take up to 30 minutes for a full guide search.) You can check a Scout's results by selecting a Scout.

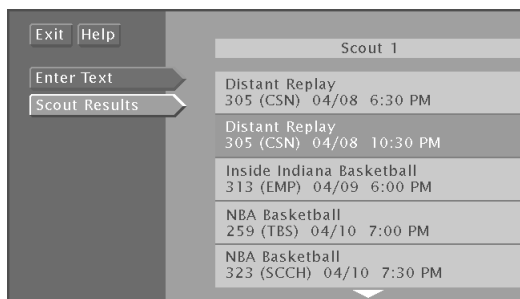

Scouts look for specific program information.

PROGRAM GUIDES

The Other Buttons

Back

Exits the guide and returns you to normal viewing on the current channel. Press OK to continue.

Help

Brings up additional information about the guide. Press OK to continue.

Down Arrow

The arrow button allows you to scroll down through other channels in the guide. Point to the down arrow, and then press OK to scroll down through the program guide.

The Main menu

Brings up the system Main menu. Press OK to continue.



Back button



Help button



Arrow button



Main menu button

PROGRAM GUIDES