

RCA

user
manual

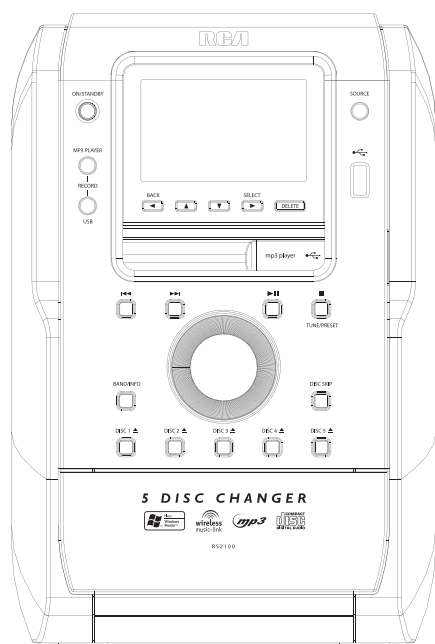

RS2100

It is important to read this instruction book prior to using your new product for the first time.
Es importante leer este manual antes de usar por vez primera su equipo.

FCC Information

FCC Information

This device complies with Part 15 of the FCC Rules. Operation is subject to the following two conditions: (1) This device may not cause harmful interference, and (2) this device must accept any interference received, including interference that may cause undesired operation.

In accordance with FCC requirements, changes or modifications not expressly approved by Thomson Inc. could void the user's authority to operate this product. This device generates and uses radio frequency (RF) energy, and if not installed and used properly, this equipment may cause interference to radio and television reception.

If this equipment does cause interference to radio or television reception (which you can determine by unplugging the unit), try to correct the interference by one or more of the following measures:

- Re-orient the receiving antenna (that is, the antenna for the radio or television that is "receiving" the interference).
- Move the unit away from the equipment that is receiving interference.
- Plug the unit into a different wall outlet so that the unit and the equipment receiving interference are on different branch circuits.

If these measures do not eliminate the interference, please consult your dealer or an experienced radio/television technician for additional suggestions. Also, the Federal Communications Commission has prepared a helpful booklet, "How To Identify and Resolve Radio TV Interference Problems." This booklet is available from the U.S. Government Printing Office, Washington, DC 20402. Please specify stock number 004-000-00345-4 when ordering copies. This product complies with DHHS Rules 21 CFR Subchapter J. Applicable at the date of manufacture.

For Your Safety

The AC power plug is polarized (one blade is wider than the other) and only fits into AC power outlets one way. If the plug won't go into the outlet completely, turn the plug over and try to insert it the other way. If it still won't fit, contact a qualified electrician to change the outlet, or use a different one. Do not attempt to bypass this safety feature.

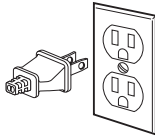

CAUTION: TO PREVENT ELECTRIC SHOCK, MATCH WIDE BLADE OF PLUG TO WIDE SLOT, FULLY INSERT.

Main plug is used as the disconnect device, it shall remain readily operable and should not be obstructed during intended use. To be completely disconnected the apparatus from supply mains, the main plug of the apparatus shall be disconnected from the mains socket outlet completely.

Changes or modifications not expressly approved by the party responsible for compliance could void the user's authority to operate the equipment.

Have a Blast- Just Not in Your Eardrums

Make sure you turn down the volume on the unit before you put on headphones. Increase the volume to the desired level only after headphones are in place.



For mp3 player only

This Class B digital apparatus complies with Canadian ICES-003.

Cet appareil numérique de la class B est conforme à la norme du NMB-003 du Canada



RCA
RD2100

Equipment tested for compliance as a complete unit

FCC Information

Technical specification

Product: 5CD Audio System with mp3 Player
Brand: RCA
Model: RS2100(Audio System)/RD2100(mp3 player)

Electrical Consumption:

Power Supply: 120V~60Hz
Power consumption: 150 Watts

IMPORTER

Comercializadora Thomson de México, S.A. de C.V.
Álvaro Obregón No. 151. Piso 13.
Col. Roma. Delegación Cuauhtémoc
C.P. 06700. México, D.F.
Telefono: 52-55-11-020360
RFC: CTM-980723-K55

For Your Records

In the event that service should be required, you may need both the model number and the serial number. In the space below, record the date and place of purchase, and the serial number:

Model No.
Remote Control No.
Date of Purchase
Place of Purchase
Serial No.

Service Information

This product should be serviced only by those specially trained in appropriate servicing techniques. For instructions on how to obtain service, refer to the warranty included in this Guide.

Main unit FCC ID:G95RS2100



This device complies with part 15 of the FCC rules. Operation is subject to the following two conditions:
(1) This device may not cause harmful interference, and
(2) This device must accept any interference received, including interference that may cause undesired operation.

Remote controller FCC ID:G95RS2100A

This device complies with part 15 of the FCC rules. Operation is subject to the following two conditions:
(1) This device may not cause harmful interference, and
(2) This device must accept any interference received, including interference that may cause undesired operation.

USB dongle FCC ID:G95RS2100B

This device complies with part 15 of the FCC rules. Operation is subject to the following two conditions:
(1) This device may not cause harmful interference, and
(2) This device must accept any interference received, including interference that may cause undesired operation.

	CAUTION RISK OF ELECTRIC SHOCK DO NOT OPEN	
THE LIGHTNING FLASH AND ARROW-HEAD WITHIN THE TRIANGLE IS A WARNING SIGN ALERTING YOU OF "DANGEROUS VOLTAGE" INSIDE THE PRODUCT.	CAUTION: TO REDUCE THE RISK OF ELECTRIC SHOCK, DO NOT REMOVE COVER (OR BACK). NO USER-SERVICEABLE PARTS INSIDE. REFER SERVICING TO QUALIFIED SERVICE PERSONNEL.	THE EXCLAMATION POINT WITHIN THE TRIANGLE IS A WARNING SIGN ALERTING YOU OF IMPORTANT INSTRUCTIONS ACCOMPANYING THE PRODUCT.
SEE MARKING ON BOTTOM / BACK OF PRODUCT		

WARNING: TO PREVENT FIRE OR ELECTRICAL SHOCK HAZARD, DO NOT EXPOSE THIS PRODUCT TO RAIN OR MOISTURE.

Portions based upon Microsoft Windows Media Technologies. Copyright © 1999 Microsoft Corporation. All Rights Reserved. Microsoft, Windows Media, and the Windows Logo are trademarks or registered trademarks of Microsoft Corporation in the United States and/or other countries.

The descriptions and characteristics given in this document are given as a general indication and not as a guarantee. In order to provide the highest quality product possible, we reserve the right to make any improvement or modification without prior notice. The English version serves as the final reference on all products and operational details should any discrepancies arise in other languages.

Important Information

EN

Safety Precautions

- Never open the cabinet under any circumstances. Any repairs or internal adjustments should be made only by a trained technician.
- Never operate this product with the cabinet removed.
- Do not use your System immediately after transporting it from a cold place to a warm place, as condensation may cause the system to malfunction.
- Keep your unit away from humid areas and abnormally hot places.
- Do not touch the player with wet hands. If any liquid enters the player cabinet, take the player to a trained technician for inspection.
- This compact disc player uses a laser to read the music on the disc. The laser mechanism corresponds to the cartridge and stylus of a record player. Although this product incorporates a laser pick-up lens, it is completely safe when operated according to directions.
- Discs rotate at high speed inside the player. Do not use damaged, warped, or cracked discs.
- Do not touch the pick-up lens which is located inside the disc compartment. To keep dust from collecting on the pick-up lens, do not leave the compartment door open for an extended period of time. If the lens becomes dirty, clean it with a soft brush, or use an air blower brush designed for camera lenses.
- The apparatus shall not be exposed to dripping or splashing and that no objects filled with liquids, such as vases, shall be placed on the apparatus.
- Minimum distances around the apparatus for sufficient ventilation .
- The ventilation should not be impeded by covering the ventilation opening with items, such as newspaper, table-cloths, curtains, etc.
- No naked flame sources, such as lighted candles, should be placed on the apparatus.
- Attention should be drawn to the environmental aspects of battery disposal .

Precautions for the mp3 Player

- Do not use the unit immediately after transportation from a cold place to a warm place; condensation problem may result.
- Do not store the unit near fire, places with high temperature or in direct sunlight.
- Do not operate or store unit in places with frequent static electricity or electrical noise (e.g. speaker, TV set).
- Clean the unit with a soft cloth or a damp chamois leather. Never use solvents.
- The unit must only be opened by qualified personnel.



Note:

This unit may temporarily cease to function if subjected to electrostatic disturbance. To resume normal operation, it may be necessary to cycle the power off and back on or to remove and reinstall the batteries.

Important Information

Important Battery Information

- Remove the batteries to avoid leakage if you do not use your remote control for more than one month.
- Discard leaky batteries immediately as leaking batteries may cause skin burns or other personal injuries. Dispose of batteries in the proper manner, according to provincial and local regulations.
- Any battery may leak electrolyte under the following circumstances:
 - if mixed with a different battery type,
 - if inserted incorrectly,
 - if all batteries are not replaced at the same time,
 - if disposed of in fire, or
 - if an attempt is made to charge a battery not intended to be recharged.

Headset Safety

- Do not play your headset at high volume. Hearing experts warn against extended high-volume play.
- If you experience ringing in your ears, reduce volume or discontinue use.
- You should use with extreme caution or temporarily discontinue use in potentially hazardous situations.
Even if your headset is an open-air designed to let you to hear outside sounds, do not turn up the volume so high that you are unable to hear what is around you.

Caution While Driving

Use of headphones while operating an automobile or moving vehicle is not recommended and is unlawful in some states and areas. Be careful and attentive on the road. Stop operation of the unit if you find it disruptive or distracting while driving.

Please Respect the Environment!

Before throwing any batteries away, consult your distributor who may be able to take them back for specific recycling.

Don't Infringe

This product should only be used for the purposes for which it is sold, that is, entertainment, violating no copyright law. Any attempts to use this product for which it is not intended is unlawful and therefore not condoned by Thomson.

Table of Contents

FCC Information

Important Information

Table of Contents1

Getting Started 2

Content of Box2

Connections of Antennas and Speakers 2

General Controls 3

Main Unit3

Navigation Buttons4

Music Navigator Remote5

Navigation Buttons5

Display7

Settings 7

Setting the Clock and Timer7

Sleep Mode 8

Sound Features 8

Volume Control 8

Bass Boost and Equalizer8

Program Recording8

CD and mp3 Disc Playback 9

Loading Discs10

Play/Pause/Stop Discs10

Skipping/Scanning Tracks11

USB and mp3 Playback11

Connecting/Disconnecting USB device

/mp3 player to the Main Unit11

Selecting USB or mp3 player Mode11

USB/mp3 player Playback Features12

Memory Usage12

Radio12

Selecting Tuner Band12

Tuning to a Station12

Using Presets12

Auto Preset Programming12

Manually Setting Presets12

Recording to the mp3 player13

Recording CD to mp3 player13

Recording Tuner/AUX to mp3 player13

Program Recording13

Recording to USB device14

Deleting files from mp3 player/USB device ..14

Wireless Musiclink?? WAITING INFO

Advanced Playback Controls15

Intro/ Repeat/Random15

Setting Up a Program List15

Advanced Navigation Controls ...16

Tips on Playback Sequence of Disc16

mp3 Player17

Turn On/Off the Player17

Playback Controls17

Adjusting the Volume18

Key Lock18

DSP18

Play modes18

Frequently Asked Questions18

Troubleshooting Tips19

Main Unit19

mp3 Player20

Maintenance21

Cleaning21

Handling CDs21

CD Lens Care21

Technical Specification21

Warranty22

Getting Started

Content of Box

- one main unit (with 2 main speakers);
- one remote control;
- one AM loop antennas;
- one mp3 Player;
- one set of earphones;
- one USB cable;
- one Wireless Music-link transceiver;
- one user manual;
- one safety leaflet;
- Owner registration Card.



Warning:

Use of this product is for your personal use only. Unauthorized recording or duplication of copyrighted material may infringe upon the rights of third parties and may be contrary to copyright laws.



Note:

Make sure the tracks are encoded in mp3 or Windows Media formats and supported bitrates. Bitrates supported by the player:
mp3 – 32 to 320kbps
wma – 48 to 160kbps

Using the FM and AM Antennas

Before you use your audio system, you'll want to make sure both the FM and AM antennas are positioned properly. Uncoil the FM antenna at the back of the unit, making sure it is fully extended (you may even want to tape it to the wall behind the unit if possible. The higher the better.) You'll also need to connect the AM antenna loop to the back of the unit if you listen to AM stations. Rotate the AM loop antenna for better reception.

Connecting the Speakers

Each speaker has a black (negative) and a red (positive) jack. When connecting the speakers, match the red wires to the red jacks and the black wires to the black jacks.

Speaker Wire Connection

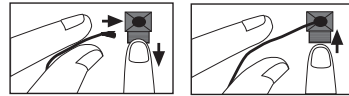

Push Speaker terminal tab down to insert wire.

Release tab to lock wire in the terminal.

NOTE: Make sure the insulation is completely removed from the ends of the speaker wires at all connection points.

Installation

To ensure sufficient ventilation, keep the spacings shown below free from other surfaces:

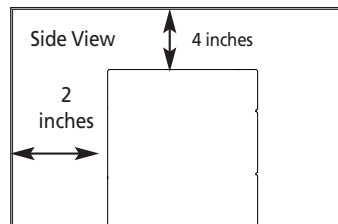
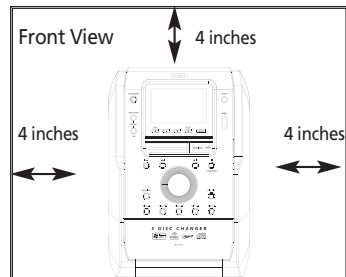

Connections of Antennas and Speakers

1. Wireless Music-link antenna.
2. AM Loop antenna Jacks.
3. FM Pigtail Antenna.
4. AUX IN.
5. Main Speaker Jacks.

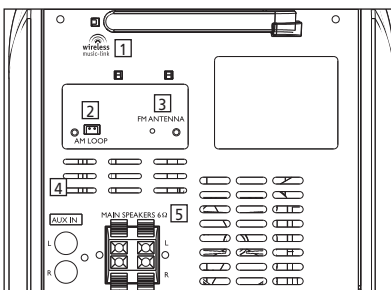

General Controls

Main Unit - Front View

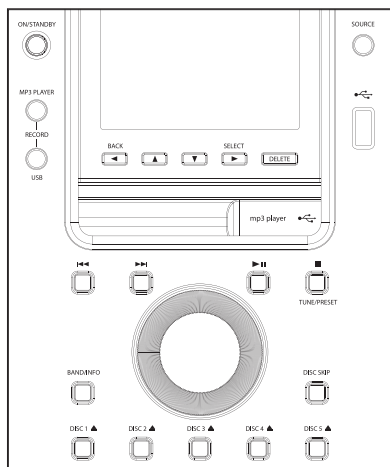

ON/STANDBY - Turns power on or off (STANDBY mode).



Tips:

In STANDBY mode, press

ON/STANDBY to turn the system on in the previously used mode. Press **SOURCE** to select the corresponding mode. Look at the display icons to identify the current mode.

SOURCE - Selects among CD player, TUNER, PC, PORTABLE PLAYER, USB and AUX.

RECORD MP3 PLAYER - Starts and stops recording to mp3 player.

RECORD USB - Starts and stops recording to USB device.

USB socket - Connects USB device.

mp3 player - Connects mp3 player.

SKIP BACKWARD - In CD, Portable Player, USB or MP3/WMA mode - Goes to the previous track; searches backward through track. In Tuner mode - Tunes down radio frequency. In Clock or Timer mode - Decreases hour and minute digit.

SKIP FORWARD - In CD, Portable Player, USB or MP3/WMA mode - Goes to the next track; searches forward through track. In Tuner mode - Tunes up radio frequency. In Clock or Timer mode - Increases hour and minute digit. In Tuner mode - Tunes up radio frequency.

PLAY/PAUSE - In CD, Portable Player, USB or MP3/WMA mode - Starts and pauses playback.

TUNE PRESET - In CD, Portable Player, USB or MP3/WMA mode - Stops playback. In MP3/WMA mode - Returns to the first track of the current disc in stop mode; displays the total number of folders and total number of tracks on the current disc when playback is completely stopped. In Recording mode - Stops record to USB device; In Tuner mode - Selects tune or preset mode.

BAND/INFO - In CD mode - Selects display options to show track elapse time, track remain time or disc remain time. During recording, selects display options to show record time and remaining time.

In Portable Player, USB or MP3/WMA mode - Shows ID3 tag.

In Portable Player or USB mode - Shows memory usage.

In Tuner mode - Selects radio band. Enters auto preset program in FM mode when depressed for 2 seconds.

DISC SKIP - Skips to the next disc in CD mode.

DISC 1 ▲ / DISC 2 ▲ / DISC 3 ▲ / DISC 4 ▲ / DISC 5 ▲ - Opens or closes the corresponding disc tray if no disc is loaded in the corresponding tray.

Enters CD mode and plays the corresponding CD when disc is loaded in the corresponding tray.

General Controls

VOLUME CONTROL - Adjusts volume.

In navigation mode - Rotate clockwise to navigate downwards and rotate counter-clockwise to navigate upwards.

Navigation Buttons

Use the navigation buttons to navigate through menu.

MENU - When reviewing program, removes track from Program List.

In CD, Portable Player, USB or MP3/WMA mode - Removes file from the connected USB device or mp3 player.

▲ **(UP)**- *In Portable Player, USB or MP3/WMA stop mode* - Enters navigation mode.
In navigation mode - Goes to the previous folder in stop mode.

In navigation mode - Navigates upwards; moves up a list; selects the previous file or folder.

In tuner mode - Selects the previous preset station; selects the next preset number.

In rename mode - Selects alphabets.

In navigation mode - Navigates upwards and move up a list.

In tuner mode - selects the next preset number.

In rename mode - selects alphabets

▼ **(DOWN)**- *In navigation mode* - Navigates downwards and move down a list.

In tuner mode - Selects the previous preset number.

In rename mode - selects alphabets

▶ **SELECT (RIGHT)** - *In Portable Player, USB or MP3/WMA stop mode* - Enters navigation mode.

In navigation mode - Moves down one navigation menu level; enters current folder and shows the first file/folder from current folder; begins playback of the selected file in navigation mode.

In tuner mode - Selects the previous preset station; selects the next preset number.

In rename mode - Confirms the current alphabet and move to the next alphabet.

◀ **BACK (LEFT)** - *In navigation mode* - Returns to the previous navigation menu level; returns to stop mode.

In rename mode - Edits the previous alphabet.

Main Unit - Top View

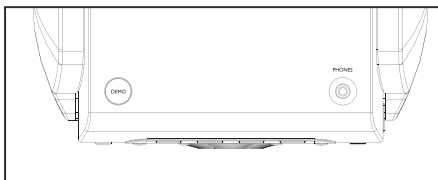

PHONES - Jack for connecting headphones.

DEMO - Activates and deactivates demonstration.



Note:

Refer to "mp3 Player" section on page 17-18 for mp3 player operation details.

General Controls

Music Navigator Remote

Basically, the LCD of the remote shows briefly the screen of the main unit.

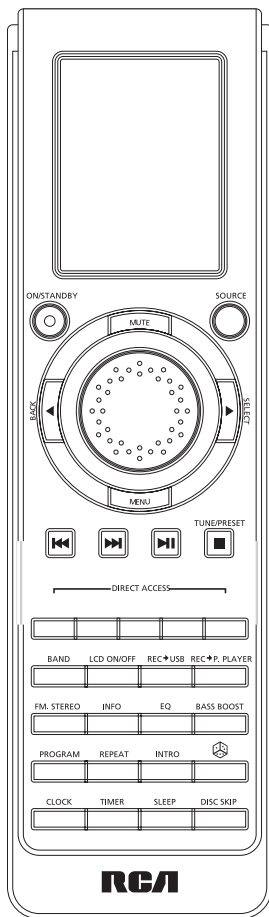

ON/STANDBY - Turns power on or off (STANDBY mode).

SOURCE - Selects among CD player, TUNER, PC, PORTABLE PLAYER, USB and AUX.

MUTE - Mutes audio output.

MENU - When reviewing program, removes track

from Program List.

In CD, Portable Player, USB or MP3/WMA mode - Removes file from the connected USB device or mp3 player.

VOLUME CONTROL - Adjusts volume.
In navigation mode - Rotate clockwise to navigate downwards and rotate counter-clockwise to navigate upwards.

◀◀ (SKIP BACKWARD) - *In CD, Portable Player, USB or MP3/WMA mode* - Goes to the previous track; searches backward through track.
In Tuner mode - Tunes down radio frequency.
In Clock or Timer mode - Decreases hour and minute digit.
In Recording mode - selects ripping speed.

▶▶ (SKIP FORWARD) - *In CD, Portable Player, USB or MP3/WMA mode* - Goes to the next track; searches forward through track.
In Tuner mode - Tunes up radio frequency.
In Clock or Timer mode - Increases hour and minute digit.
In Recording mode - selects ripping speed;
In Tuner mode - Tunes up radio frequency.

▶|| (PLAY/PAUSE) - *In CD, Portable Player, USB or MP3/WMA mode* - Starts and pauses playback.

■ TUNE/PRESET - *In CD, Portable Player, USB or MP3/WMA mode* - Stops playback.
In MP3/WMA mode - Returns to the first track of the current disc in stop mode; displays the total number of folders and total number of tracks on the current disc when playback is completely stopped.
In Recording mode - Stops record to USB device;
In Tuner mode - Selects tune or preset mode.

CD 1/CD 2/CD 3/CD 4/CD 5 - Direct accesses the corresponding disc.

BAND - *In Tuner mode* - Selects radio band. Enters auto preset program in FM mode when depressed for 2 seconds.

LCD ON/OFF - Turns LCD on or off.

REC ▶ USB - Starts recording to USB device.

General Controls

REC ► **P. PLAYER** - Starts recording to mp3 player.

FM STEREO - Selects between stereo and mono sound in FM tuner mode.

INFO - *In CD mode* - Selects display options to show track elapse time, track remain time or disc remain time. During recording, selects display options to show record time and remaining time. *In Portable Player, USB or MP3/WMA mode* - Shows ID3 tag. *In Portable Player or USB mode* - Shows memory usage.

EQ - Selects equalizer presets.

BASS BOOST - Turns on or off Bass Boost.

PROGRAM - *In CD / USB and Tuner mode* - Enters program mode.

REPEAT - *In CD mode* - Repeats a track, CD or all CDs. *In Portable Player, USB or MP3/WMA mode* - Selects repeat one file, repeat all files mode.

INTRO - *In CD, Portable Player, USB or MP3/WMA mode* - Turns intro mode on or off to play the first 10 seconds of each track / file.

 - *In CD, Portable Player, USB or MP3/WMA mode* - Turns on/off random playback.

CLOCK - Displays clock time. Press and hold to enter clock setting mode.

TIMER - Enters timer setting mode. Activates and deactivates timer.

SLEEP - Selects the time interval in minutes before the unit turns off.

DISC SKIP - Skips to the next disc in CD mode.

Navigation Buttons

► **SELECT (RIGHT)** - *In Portable Player, USB or MP3/WMA stop mode* - Enters navigation mode. *In navigation mode* - Moves down one navigation menu level; enters current folder and shows the first file/folder from current folder;

begins playback of the selected file in navigation mode.

In tuner mode - Selects the previous preset station; selects the next preset number.

In rename mode - Confirms the current alphabet and move to the next alphabet.

◀ **BACK (LEFT)** - *In navigation mode* - Returns to the previous navigation menu level; returns to stop mode.

In rename mode - Edits the previous alphabet.

Installing Batteries

The remote control must be inserted with 2 "AAA" or "UM-4" or "R03" batteries prior to use. Follow the steps below to ensure correct installation.

1. Open the battery compartment door by pressing down on the tab and then lifting the door out.
2. Insert "AAA"(UM4) batteries in the compartment.
3. Replace the battery compartment door in place.

Display

EN

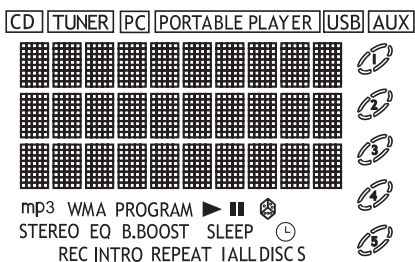

CD/TUNER/PC/PORTABLE PLAYER/USB/AUX - indicates the current mode.



- The corresponding disc icon lights to show which disc compartment is loaded. The current playing disc will flash.

mp3 / WMA - Current CD format.

PROGRAM - In program mode.

▶| - Currently in playback mode.

|| - Currently in pause mode.

⊞ - Random playback is activated in CD mode.

STEREO - In FM tuner mode, indicates stereo sound is selected.

EQ - Current equalizer setting.

B.BOOST - Bass boost is activated.

SLEEP - Sleep is activated.

⌚ - Timer is activated.

REC - Recording is activated.

INTRO - In CD mode, intro is activated so the first 10 seconds of each track will be played.

REPEAT 1/REPEAT 1 DISC/REPEAT ALL

DISCS/ALL DISCS - In CD mode, indicates the repeat option that is activated.

REPEAT 1 - Repeats current track.

REPEAT 1 DISC - Repeats current disc.

REPEAT ALL DISCS - Repeats all discs.

ALL DISCS - Plays all discs once.

Settings

Setting the Clock

1. Press and hold **CLOCK** on the remote control to set the clock.
2. Press ◀◀ or ▶▶ to set the time. Press **CLOCK** again to save settings.



Note:

When system is ON, you can press **CLOCK** to display the current time for about 2 seconds.

Setting the Timer

You can turn on/off the unit or record TUNER at preset times by setting the timer.

1. Press and hold **TIMER** on the remote control until Timer On and the clock hour flashes on the display.
2. Press ◀◀ or ▶▶ to set the time.
3. Press **TIMER**. Repeat step 2 to change to Timer Off setting with clock hour flashing. .
4. Press **TIMER** to select source. Press ◀◀ or ▶▶ to select CD/USB/Tuner/Rec Tuner. If Rec Tuner is selected, press ◀◀ or ▶▶ to select the preset station.
5. Press **TIMER**. Adjust **VOLUME CONTROL** to set volume.
7. Press **TIMER** to save and quit setting. The timer is automatically activated once timer setting is saved.

Settings

Activating the Timer

Press and release **TIMER** to turn on/off the alarm.

 is displayed when timer is activated.



Tips:

"Rec Tuner" setting is for Program Recording. For more information, see paragraph below.

Program Recording

When setting the Timer, select "Rec Tuner" as the source to preset the unit to record radio at the preset time. Make sure the mp3 player is connected and have enough memory space.

Sleep Mode

You can select the time interval before the unit turns off automatically.

Press **SLEEP** to select among OFF, 120, 90, 60, 45, 30, 15 and 5 minutes.

SLEEP is displayed when sleep mode is activated.

Viewing Remaining Sleep Time

When sleep is activated, press **SLEEP** once to view remaining sleep time.

Adjusting Sleep Time

Press **SLEEP** again when the remaining sleep time is displayed to change sleep time.



Note:

Sleep is automatically de-activated when the unit is turned off.

EN

Sound Features

Volume Control

Rotate the volume control on the main unit or press **VOL** ▲ or ▼ on the remote control to adjust volume level.

Bass Boost

Press **BASS BOOST** to turn on/off boosting the bass frequency. **B.BOOST** is displayed when it is activated.

Muting Audio

Press **MUTE** on the remote control to cut the sound. **MUTE** flashes on the display.

Using Preset Equalizer Curves

Press **EQ** to toggle among FLAT, ROCK, POP, JAZZ, CLASSIC and CUSTOM. **EQ** is displayed when EQ is activated.

Creating a Custom Curve

1. Press **EQ** to select CUSTOM mode.
2. While CUSTOM is displayed, press ◀◀ or ▶▶ to cycle among displayed bass and treble range levels.
3. While BAS and TRE is displayed, adjust volume control to set the associated gain between -10 - +10.
4. Press **EQ** to exit.

CD and mp3 Disc Playback

Important CD and mp3/WMA Information



This unit is compatible with CD-RW/ CD-R discs for playback.



Notes on CD-R/RW Disc:

- Do not affix any type of labels to either side (recordable or labeled side) of a CD-R/RW disc as this may result in the unit malfunctioning.
- To avoid damages to the CD-R/RW disc, do not open the disc compartment door while the disc is being read.
- Do not load an unrecorded CD-R/RW disc into the unit. This may take a longer time to read the disc.
- Playback capability for CD-RW discs may vary due to variations in the quality of the CD-RW disc and the recorder used to create the disc.



Notes on mp3/WMA Disc:

- Use .mp3 as the extension when converting audio files into mp3 for saving onto CD-R(W) or CD-ROM, e.g. Abc08.mp3. Do not use any other extension e.g. .doc, .pdf.
- Do not use the .mp3 extension for other text or non-audio data files as this may result in serious malfunction and harmful noise interference.
- For better quality in mp3/WMA disc playback, the CD quality should be recorded 128kbps or above.
- Disc data size > 650MB is not recommended.
- Total files and folders in the disc should not exceed 250, it also depends on the length of the file/folder names.
- For mixed mode discs, only one mode will be selected for playback depending on the recording format.
- To ensure good performance, wait until the disc changer completely reads the disc before proceeding.
- mp3 files in CD ROM EXTRA format disc cannot be recognized.

CD and mp3 Disc Playback

Loading Discs

1. Press **SOURCE** repeatedly to select CD mode.
2. Press **DISC 1 ▲/2 ▲/3 ▲/4 ▲/5 ▲** to open the desired disc tray. (For example, press **DISC 1 ▲** to open disc tray 1)
3. Insert a disc with label face up.
4. Press **DISC 1 ▲/2 ▲/3 ▲/4 ▲/5 ▲** to close the disc tray. (For example, press **DISC 1 ▲** to close disc tray 1)
5. Repeat steps 2-4 to load discs in all the disc trays.

A Solid disc tray icon lights on the display indicating that the corresponding tray is occupied. The current disc tray icon flashes on the display.

If the disc is a mp3 / WMA CD, the respective **mp3** or **WMA** lights on the display.



Note:

Be sure to remove all discs from the disc compartment before moving or transporting the unit.



Tips:

In TUNER, PC, PORTABLE PLAYER, USB or AUX mode, the corresponding disc will start playback when **DISC 1 ▲/2 ▲/3 ▲/4 ▲/5 ▲** is pressed. If there is no disc in the corresponding disc tray, the current disc will be set to the next occupied tray.

Play Discs

- **To play all discs in the disc tray**
Press **▶||** in stop mode to begin playback.
- **To play a specific disc in the disc tray**
Press **CD 12/3/4/5** on the remote to play the corresponding disc.

- **To play a specific track in the disc**

Press **◀◀** or **▶▶** to select the track and press **▶||** to start playback.



Attention:

Do not push to force closing of the tray during CD playback or tray opening.

Pause Discs

Press **▶||** during playback to pause disc. Press again to resume.

Play and load simultaneously:

1. While a CD is playing, press **DISC 1 ▲/2 ▲/3 ▲/4 ▲/5 ▲** (except the current disc) to open the desired disc tray. (For example, a CD is playing in disc tray 1, press **DISC 2 ▲/3 ▲/4 ▲/5 ▲** to open the desired disc tray.)
2. Load or change discs for the trays.
3. Press **DISC 1 ▲/2 ▲/3 ▲/4 ▲/5 ▲** to close the tray.

Stop Playback

During playback, press **■** to stop playback. The unit returns to navigation mode briefly (approx. 10 seconds) before entering stop mode.



Tips:

In CD stop mode, press **▶** to enter navigation mode and show disc menu. In CD navigation mode, press **◀** to return to stop mode.

Selecting a Disc

Press **CD 12/3/4/5** to direct access the corresponding disc or **DISC SKIP** on the remote to skip discs.

CD and mp3 Disc Playback

Skipping Tracks

- Press **⏮** or **⏭** to skip to the previous or next track.

Scanning Tracks

- Press and hold **⏮** or **⏭** to search through a CD while it is playing.

Program Playback

Refer to [page 15](#) for details.

EN

USB and mp3 Player Playback

The playback controls of USB devices and mp3 player are basically the same. Connect the devices first and then you can start playback.

Connecting USB device to the Main Unit

Insert the USB port of the USB device into the USB connector of the main unit. Unplug the device to disconnect.

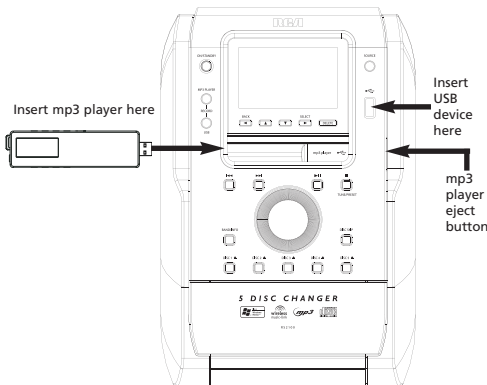

Connecting the mp3 Player to the Main Unit

1. Press and hold the lock button on the back of the player and push the USB connector out from the player.
2. Insert the USB port of the mp3 player into the USB connector for the player of the main unit.

Disconnecting the mp3 player from the Main Unit

Press eject button on the right side of the unit to disconnect the player.

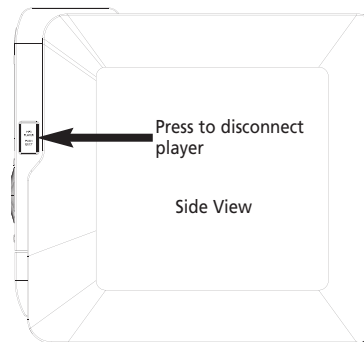

Selecting USB or Portable Player Mode

Press **SOURCE** repeatedly to select USB or PORTABLE PLAYER mode.

USB / mp3 player Playback Features

Start and Pause Playback

Press **▶||** to start and pause playback.

USB and mp3 Player Playback

Stop Playback

Press **■** to stop playback. The unit enters navigation mode for 10 seconds before entering stop mode.

Skipping Files

- Press **⏮** or **⏭** to skip to the previous or next file.
- Press and hold **⏮** or **⏭** to search through a file while it is playing.



Tips:

In CD stop mode, press **▶** to enter navigation mode and show disc menu.
In CD navigation mode, press **◀** to return to stop mode.

EN

Memory Usage

Press **BAND/INFO** on the main unit or **INFO** on the remote control to view memory usage on the USB device or the mp3 player.

Radio

Selecting Tuner Band

1. Press **SOURCE** to enter Tuner mode.
2. Press **BAND** to select between FM or AM Radio band.



Tips:

Your audio system has 32 preset stations.

Auto Preset Programming (FM only)

Press and hold the **BAND** button for 2 seconds to scan stations in FM band. The stations will then be stored as preset channels. A maximum of 32 stations can be stored. Beware of your preset channels being erased accidentally because the scanning and storing process is automatic upon pressing the button. You can stop the automatic scan by pressing any button, but the erased stations cannot be recovered.

Tuning to a Station

Press **⏮** or **⏭** to select frequencies. Press and hold **⏮** or **⏭** to scan frequencies.

Using Presets

The tuner can be in either TUNE or PRESET mode.

- Press **■ TUNE/PRESET** to toggle TUNE and PRESET mode.
- Press **⏮** or **⏭** to access the previous or next preset station.



Tips:

Under PRESET mode, press **⏮** or **⏭** can only access the preset stations. Manually tuning is not accessible in this mode.

Manually Setting Presets

1. Press **■ TUNE/PRESET** to enter TUNE mode.
2. Press **⏮** or **⏭** to access the desired frequency.
3. Press the **PROG** button once and the most recently accessed program location flashes on the display.
4. If a different program location is preferred, press **⏮** or **⏭** to move to the desired preset number (1-32).
5. Press **PROG** to store the selected frequency at that preset.

Suppressing Stereo Signal

Press **FM. STEREO** to toggle between FM mono and stereo mode. **STEREO** is displayed in stereo mode.

Recording to the mp3 Player

Recording to mp3 player or USB device are basically the same. You can record CD, Tuner or AUX files to the mp3 player or USB device.

EN

Recording CD to mp3 Player

1. Connect the mp3 player to the USB port, "USB Connected" will show on the display of the player.
2. In CD stop mode or CD navigation mode, press **RECORD MP3 PLAYER** on the main unit or press **REC ► P. PLAYER** on the remote control. The unit will start playback and recording will begin. **REC** is displayed.
3. Press **■**, press **RECORD MP3 PLAYER** on the main unit or press **REC ► P. PLAYER** on the remote control to stop recording.

Example (Record one CD):

??? Pls advice the control ???

Example (Record all 5 CDs):

In CD stop mode or CD navigation mode, press **RECORD MP3 PLAYER** on the main unit or press **REC ► P. PLAYER** on the remote control. The unit will start playback and recording will begin. **REC** is displayed. (Make sure **ALL DISCS** mode is selected by pressing **REPEAT** repeatedly)

Example (Record only selected tracks from a CD):

1. Create a CD program by following instructions under "Setting Up a CD Program" on page 19.
2. In CD stop mode or CD pause mode, press **PROG** and then **►||** to enter program playback mode. Playback and recording will begin. **PROGRAM** and **REC** is displayed.
3. Press **■**, press **RECORD MP3 PLAYER** on the main unit or press **REC ► P. PLAYER** on the remote control to stop recording.



Tips:

To view remaining time (Rem), press **BAND/INFO** on the main unit or **CD INFO** on the remote in recording mode.



Tips:

If CD playback is already started, recording will begin instantly when **RECORD MP3 PLAYER** on the main

unit or press **REC ► P. PLAYER** on the remote control is pressed. If CD playback is stopped, playback and recording will start instantly when **RECORD MP3 PLAYER** on the main unit or press **REC ► P. PLAYER** on the remote control is pressed.



Tips:

Recording stops automatically when CD stops (For example: end of disc is reached).



Note:

The encoding bitrate for tuner, CD and AUX signal are as below:
CD / Aux : 128 kbps
Tuner : 96 kbps

Recording Tuner/AUX to mp3 Player

1. In Tuner or AUX mode, press **RECORD MP3 PLAYER** on the main unit or press **REC ► P. PLAYER** on the remote control to start recording.

Example:

1. In Tuner mode, select the station to record (refer to page 12 for details).
2. Press **RECORD MP3 PLAYER** on the main unit or press **REC ► P. PLAYER** on the remote control to start recording.
3. Press **■**, press **RECORD MP3 PLAYER** on the main unit or press **REC ► P. PLAYER** on the remote control to stop recording.

Program Recording

Refers to "Setting the Timer" on page 7.

Recording to the mp3 Player

EN

Recording to USB Device

Follow the steps of "Recording CD/Tuner/AUX to mp3 player" in the last section by pressing **RECORD USB** on the main unit or **REC ► USB** on the remote control instead of **RECORD MP3 PLAYER** on the main unit or press **REC ► P. PLAYER** on the remote control.

Deleting Files from mp3 Player/USB device

1. In navigation mode, select the file to delete using the navigation buttons. (Refer to "Navigation Buttons" on page 6 for details.)
2. Press **DEL** on the remote control.
3. Rotate the **Volume Control** on the main unit or press **▲** or **▼** on the remote control to select Yes to delete or No to cancel.
4. Press **►** to confirm selection.

Deleting All Files

In navigation mode and mp3 stop mode, press and hold **DEL** on the remote control to delete all the files on the mp3 player or memory card.

Advanced Playback Controls

EN

In CD , USB and Portable Player mode, advanced playback controls allow you to sample, repeat and random playback files, set up a Program List. In USB mode, allow you to rename tracks.

Sampling Tracks

Press **INTRO** on the remote control to play the first 10 seconds of each track on the current disc, all discs in the tray, or turn intro mode off.



INTRO is displayed when sampling is activated.

Repeat

Press **REPEAT** on the remote control to toggle repeat options:

Repeat the current track (REPEAT 1),
Repeat current disc (REPEAT 1 DISC) ,
Repeat all discs (REPEAT ALL DISC), or
Normal playback (ALL DISCS).

Random Playback

Press  on the remote control to turn on/off random playback.  is displayed when it is activated.

All the tracks on one disc will be shuffled and played once before shuffling and playing tracks from the next disc.



Tips:

Random playback can be activated simultaneously with repeat 1 disc (randomly play tracks from one disc repeatedly) or repeat all discs (randomly play tracks from all discs repeatedly).

Setting Up a Program List

1. In navigation mode, press **CD 1/2/3/4/5** on the remote control or **DISC SKIP** to select disc.
2. Use the navigation buttons to select the track / file to add to Program List.
3. **??Pls advice which button to add files???**



Note:

You can create a program of up to 32 tracks.

Playing a Program List

While in PROGRAM stop mode , press **▶▶** .

If you are not currently in program mode, press **PROG** to enter program mode. Program playback begins automatically. **PROGRAM** is displayed.

Display Program List

1. While CD playback is stopped, press **PROG** to enter PROGRAM mode. Program playback begins automatically after entering program mode.
To display program list, press **■** .
2. Press **▲** or **▼** repeatedly to view each track assignment in the program list.

Deleting from Program List

1. While in PROGRAM mode, press **▲** or **▼** to select the program to delete.
2. Press **MENU** on the main unit.
3. Press **▲** or **▼** to select between No to cancel and Yes to confirm.
4. Press **▶** to confirm selection.

Deleting the Entire Program List

1. While in PROGRAM mode, press **▲** or **▼** to select the program to delete.
2. Press and hold **MENU** on the main unit.
3. Press **▲** or **▼** to select between No to cancel and Yes to confirm.
4. Press **▶** to confirm selection.

**Any rename function??
Pls advice the controls?**

WAITING INFO FOR WIRELESS MUSICLINK

Advanced Navigation Controls



Tips on Playback Sequence of Disc

- Check that the mp3/WMA disc is created with a single folder structure. Refer to the diagram below for playback sequence details on multi-level folder structure.
- For example, folders and songs from level 2 are played before moving on to play folders and songs from level 3.

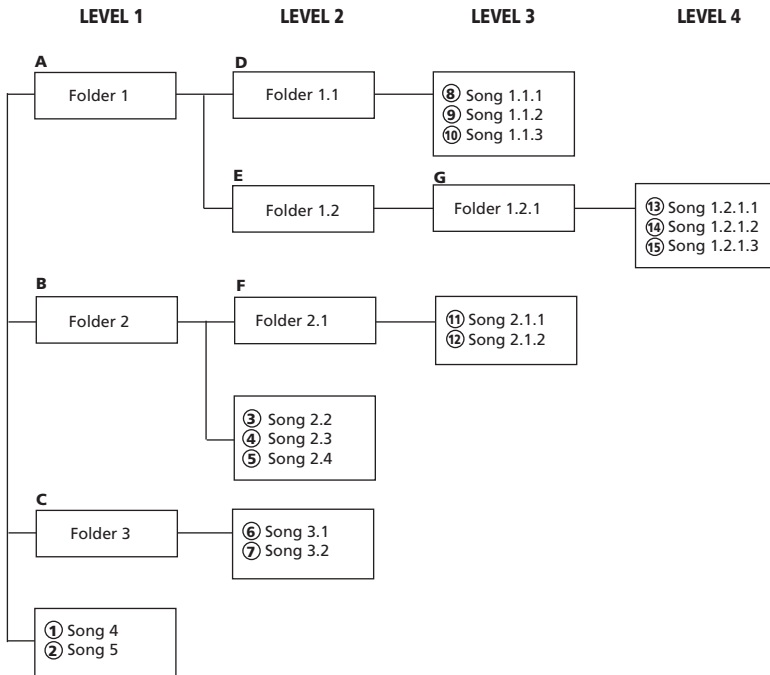

Note:

- Folder playback sequence is indicated by the letters A to G.
- Song playback sequence is indicated by the numbers (1 to 15) in front of the song name.

mp3 Player

EN

Insert battery into the player

1. Slide the battery door by following the direction of arrow.
2. Insert a "AAA"(UM4) battery with polarities corresponding to the indications in the compartment.
3. Replace the door to the battery compartment.



Note:

This unit may temporarily cease to function if subjected to electrostatic disturbance. To resume normal operation, it may be necessary to cycle the power off and back on or to remove and reinstall the batteries.

General Controls

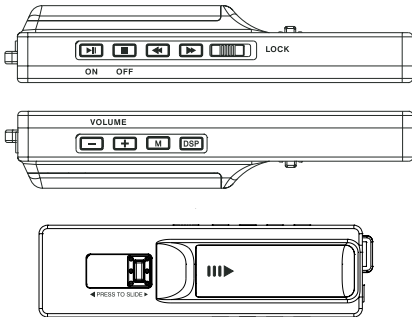

- ▶|| - Press once to turns the unit on. In play mode, press once to starts and pause music playback.
- - In stop mode, press once to turn off the unit. Press once to stop music playback.
- ◀◀ - Skips to the previous song or the beginning of the current song. Press and hold to scan backwards.
- ▶▶ - Skips to the next song. Press and hold to scan forward.
- LOCK** - Slide the switch to lock or unlock the keys of the player
- Headphones Jack** - Insert headphones here.
- 🔌 - Use the USB port to connect to the Audio System.
- USB lock button** - Press and hold and push the USB connector out form the unit.

VOLUME + / - - Increases and decreases the volume level.

M - Selects among playback options. (repeat one, repeat all, random playback, repeat random playback)

DSP - Selects among DSP modes (Flat, Bass, Pop, Rock, Jazz)

Display Overview

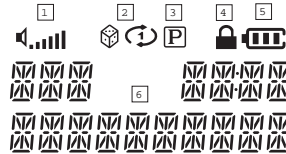

1. Shows current volume level.
2. The relative play mode indicator lights to show current selection.
 - 🔄 - repeat track
 - 🔄 - repeat all
 - 🎲 - random playback
 - 🔄🎲 - repeat random playback
3. 🔒 is displayed when the key lock function is activated.
4. 🔋 shows the battery level.
5. This section shows song information.

The information in this section presumes you've successfully transferred files to the mp3 player, and you're ready to play some music.

Turn On/Off the mp3 player

Press ▶|| to turn the unit on/off. Playback starts automatically from the first track.

Play / Pause

- Press ▶|| to start and pause playback of selected track. Current track number, elapsed playback time and track title show on display.

Stop Playback

- During playback, press ■ to stop playback. The total number of tracks is display.
- Press ■ in stop mode to turn the unit off.

mp3 Player

Skipping Tracks

- Press **⏮** or **⏭** to skip to the previous or the next track.

Scan Tracks

- Press and hold **⏮** or **⏭** to scan backwards and forwards during playback.



Note:

If the elapsed time of the playing track is less than 0:04, pressing **⏮** once will return to previous track.

If the elapsed time of the playing track is more than 0:04, pressing **⏮** once will return to the beginning of the current track.

Adjusting the Volume

Press **VOLUME +/-** to adjust the volume.

Key Lock

- To avoid accidental key activation, slide the key lock switch to the left. **🔒** is displayed.
- Slide to the switch to the right to unlock.



Note:

When the unit is in off mode and the key lock switch is at the LOCK position, pressing the **▶||** key will cause the display to show the key lock icon for three seconds.

DSP

Press **DSP** repeatedly to select among DSP modes: FLAT > BASS > POP > ROCK > JAZZ
The current selection shows briefly on the display.

Play modes

During playback, press **M** repeatedly to select among the following playback modes:

Normal playback

Repeat Track -

Repeat All -

Random Playback -

Repeat Random Playback -

Check for Updates

Visit www.thomson-lyra.com for the latest news and firmware upgrades for our Lyra Digital Audio Player. You must update your system after new downloads have been made in order for the new applications to be executed.

Frequently Asked Questions

You can get FAQ information at www.thomson-lyra.com

Troubleshooting Tips

Main Unit

EN

Problem	Solution	Problem	Solution
<i>System will not turn on</i>	<ul style="list-style-type: none"> • Check power cord for a secure connection. • Unplug the unit for a moment, and then plug into power source again. • Check the outlet by plugging in another device. 	<i>CD sound skips</i>	<ul style="list-style-type: none"> • Clean the disc. • Check disc for warping, scratches, or other damage. • Check if something is causing the system to vibrate. If so, move the system. • Make sure the speakers are at least 3 feet away or on a different surface from the main unit.
<i>No sound</i>	<ul style="list-style-type: none"> • Increase the volume setting. • Check connection to speakers. • Check that you have selected the appropriate function: CD, Tuner. • Make sure mute is off. • Make sure headphones are not plugged in. 	<i>CD button will not respond, or does not change discs when you press DISC SKIP</i>	<ul style="list-style-type: none"> • Switch to another function (Tuner) and then back to CD.
<i>Poor radio reception</i>	<ul style="list-style-type: none"> • Check antenna connection. • Move antenna. • Turn off nearby electrical appliances, such as hair dryer, vacuum cleaner, microwave, fluorescent lights. 	<i>Remote control does not work</i>	<ul style="list-style-type: none"> • Check that the batteries are properly installed. • Replace weak batteries. • Check the system is plugged into power source. • Point the remote directly at the system's front panel. • Move closer to the system. • Remove any obstacles between the remote and the system.
<i>CD does not play</i>	<ul style="list-style-type: none"> • Check that CD is in the tray. • Check that CD label is facing up. • Check that PAUSE mode is not on. • Check that CD function is selected. • Use CD lens cleaner. • Clean the disc. • Try another CD. 		

Troubleshooting Tips

mp3 Player

EN

Problem

Solution

The player does not turn on when PLAY button pressed.

- Battery may be inserted incorrectly.
- Battery may be empty.

Skipping tracks or bad sound quality?

- Repeat or random function may be activated.
- There may be strong magnetic fields (e.g. too close to TV) near the unit.
- Low Battery level. Replace with new one.

Cannot perform playback?

- LOCK function may be activated.
- There may be no mp3 tracks in the card or internal memory.
- Memory Card may be damaged.

Cannot playback tracks on the player.

- Make sure audio tracks are encoded in the mp3 or Windows Media formats at supported bitrates.
Bitrates support by the player:
mp3 – 32 to 320 kbps
wma – 48 to 160 kbps

Check the website and/or application help system of the music download service provider from where the content was purchased from for license acquisition details.
For more information on how license acquisition works, go to www.microsoft.com/windowsmedia/drm.

Problem

Solution

What does the PlaysForSure logo mean?

PlaysForSure is a new logo program from Microsoft®. Consumers can match the PlaysForSure logo on a large selection of devices and online music stores. If you see the logo, you'll know your digital media will play for sure.
For more information on the Microsoft PlaysForSure program, visit www.PlaysForSure.com.
For more information on RCA PlaysForSure devices, visit www.rca.com.

USB display does not appear when connected to computer.

- Check connection between your unit and the computer.

The player does not respond to key operations?

- To reset the unit, turn the player off by removing the battery. Reinsert the battery properly and turn the player on again to resume normal operations.



Note:

This unit may temporarily cease to function if subjected to electrostatic disturbance. To resume normal operation, it may be necessary to cycle the power off and back on or to remove and reinstall the batteries.

Maintenance

Disconnect the audio system from the power source before performing any maintenance.

EN

Cleaning

Clean the exterior of the system using a soft dust cloth.

CD Player

CAUTION! This system operates with a laser. It must be opened by only a qualified technician.

Handling CDs

- Do not touch the signal surfaces. Hold CDs by the edges, or by one edge and the hole.
- Do not affix labels or adhesive tapes to the label surfaces.
- Do not scratch or damage the label. CDs rotate at high speeds inside the player.
- Do not use damaged (cracked or warped) CDs

Cleaning CDs

- Dirty CDs can cause poor sound quality. Always keep CDs clean by wiping them gently with a soft cloth from the inner edge toward the outer perimeter.
- If a CD becomes dirty, wet a soft cloth in water, wring it out well, wipe the dirt away gently, and then remove any water drops with a dry cloth.
- Do not use record cleaning sprays or antistatic agents on CDs. Also, never clean CDs with benzene, thinner, or other volatile solvents which may cause damage to disc surface

CD Lens Care

When your CD lens gets dirty it can also cause the system to output poor sound quality. To clean the lens you will need to purchase a CD lens cleaner can maintain the output sound quality of your system. For instructions on cleaning the CD lens, refer to the ones accompanying the lens cleaner.

Technical Specification

Power supply: 120V~60Hz

Dimensions (H x W x D mm):

Unit size - 280 x 187 x 310

Speaker - 278 x 185 x 229

CD player: Response curve (+/- 2dB): 60Hz to 5kHz

Rating Plate: Look for it at the back of the set.

Maximum size of Mass Storage Class device supported: 20 GB

Limited Warranty (U.S.)

What your warranty covers:

- Defects in materials or workmanship.

For how long after your purchase:

- One year from date of purchase for labor and parts
- Warranty period for rental units begins with the first rental or 45 days from date of shipment to the rental firm, whichever comes first.

What we will do:

- Pay any Authorized RCA Audio Service Center the labor charges to repair your unit.
- Pay any Authorized RCA Audio Service Center for the new or, at our option, refurbished replacement parts required to repair your unit.

How you get service:

- Take your unit to any Authorized RCA Audio Service Center. To identify your nearest Authorized RCA Audio Service Center, ask your dealer, look in the Yellow Pages, or call 1-800-336-1900.
- Show the Authorized Service Center Representative your evidence of purchase date or first rental.
- Pick up your unit when repairs are completed.
- Proof of purchase in the form of a bill of sale or receipted invoice which is evidence that the product is within the warranty period must be presented to obtain warranty service. For rental firms, proof of first rental is also required.

What your warranty does not cover:

- Customer instruction. (Your Owner's Manual describes how to install, adjust, and operate your unit. Any additional information should be obtained from your dealer.)
- Installation and related adjustments.
- Signal reception problems not caused by your unit.
- Damage from misuse or neglect.
- Cleaning of audio heads.
- Batteries.
- A unit that has been modified or incorporated into other products or is used for institutional or other commercial purposes.
- A unit purchased or serviced outside the U.S.A.
- Acts of nature, such as but not limited to lightning damage.

Product Registration:

- Please complete and mail the Product Registration Card packed with your product. It will make it easier to contact you should it ever be necessary. The return of the card is not required for warranty coverage.

Limitation of Warranty:

- **THE WARRANTY STATED ABOVE IS THE ONLY WARRANTY APPLICABLE TO THIS PRODUCT. ALL OTHER WARRANTIES, EXPRESS OR IMPLIED (INCLUDING ALL IMPLIED WARRANTIES OF MERCHANTABILITY OR FITNESS FOR A PARTICULAR PURPOSE) ARE HEREBY DISCLAIMED. NO VERBAL OR WRITTEN INFORMATION GIVEN BY THOMSON INC., ITS AGENTS OR EMPLOYEES SHALL CREATE A WARRANTY OR IN ANY WAY INCREASE THE SCOPE OF THIS WARRANTY.**
- **REPAIR OR REPLACEMENT AS PROVIDED UNDER THIS WARRANTY IS THE EXCLUSIVE REMEDY OF THE CONSUMER. THOMSON INC. SHALL NOT BE LIABLE FOR INCIDENTAL OR CONSEQUENTIAL DAMAGES RESULTING FROM THE USE OF THIS PRODUCT OR ARISING OUT OF ANY BREACH OF ANY EXPRESS OR IMPLIED WARRANTY ON THIS PRODUCT. THIS DISCLAIMER OF WARRANTIES AND LIMITED WARRANTY ARE GOVERNED BY THE LAWS OF THE STATE OF INDIANA. EXCEPT TO THE EXTENT PROHIBITED BY APPLICABLE LAW, ANY IMPLIED WARRANTY OF MERCHANTABILITY OR FITNESS FOR A PARTICULAR PURPOSE ON THIS PRODUCT IS LIMITED TO THE APPLICABLE WARRANTY PERIOD SET FORTH ABOVE.**

How State Law relates to warranty:

- Some states do not allow the exclusion nor limitation of incidental or consequential damages, or limitations on how long an implied warranty lasts, so the above limitations or exclusions may not apply to you.
- This warranty gives you specific legal rights, and you also may have other rights that vary from state to state.

If you purchased your unit outside the United States:

- This warranty does not apply. Contact your dealer for warranty information.

Service calls which do not involve defective materials or workmanship are not covered by this warranty. Costs of such service calls are the sole responsibility of the purchaser.

Limited Warranty (Canada)

What your warranty covers:

- Defects in materials or workmanship.

For how long after your purchase:

- One year from date of purchase for labor and parts
- The warranty period for rental units begins with the first rental or 45 days from date of shipment to the rental firm, whichever comes first.

What we will do:

- Pay any Authorized RCA Audio Service Center the labor charges to repair your unit.
- Pay any Authorized RCA Audio Service Center for the new or, at our option, refurbished replacement parts required to repair your unit.

How you get service:

- Take your unit to any Authorized RCA Audio Service Center. To identify your nearest Authorized RCA Audio Service Center, ask your dealer, look in the Yellow Pages, or call 1-800-336-1900.
- Show the Authorized Service Center Representative your evidence of purchase date or first rental.
- Pick up your unit when repairs are completed.
- Proof of purchase in the form of a bill of sale or receipted invoice which is evidence that the product is within the warranty period must be presented to obtain warranty service. For rental firms, proof of first rental is also required.

What your warranty does not cover:

- Customer instruction. (Your Owner's Manual describes how to install, adjust, and operate your unit. Any additional information should be obtained from your dealer.)
- Installation and related adjustments.
- Signal reception problems not caused by your unit.
- Damage from misuse or neglect.
- Cleaning of audio heads.
- Batteries.
- A unit that has been modified or incorporated into other products or is used for institutional or other commercial purposes.
- A unit purchased or serviced outside Canada.
- Acts of nature, such as but not limited to lightning damage.

Product Registration:

- Please complete and mail the Product Registration Card packed with your product. It will make it easier to contact you should it ever be necessary. The return of the card is not required for warranty coverage.

Limitation of Warranty:

- **THE WARRANTY STATED ABOVE IS THE ONLY WARRANTY APPLICABLE TO THIS PRODUCT. NO VERBAL OR WRITTEN INFORMATION GIVEN BY THOMSON MULTIMEDIA LTD., ITS AGENTS OR EMPLOYEES SHALL CREATE A GUARANTEE OR IN ANY WAY INCREASE THE SCOPE OF THIS WARRANTY.**
- **REPAIR OR REPLACEMENT AS PROVIDED UNDER THIS WARRANTY IS THE EXCLUSIVE REMEDY OF THE CONSUMER. THOMSON MULTIMEDIA LTD. SHALL NOT BE LIABLE FOR INCIDENTAL OR CONSEQUENTIAL DAMAGES RESULTING FROM THE USE OF THIS PRODUCT. EXCEPT TO THE EXTENT PROHIBITED BY APPLICABLE PROVINCIAL LAW, ANY IMPLIED WARRANTY OF MERCHANTABILITY OR FITNESS FOR A PARTICULAR PURPOSE ON THIS PRODUCT IS LIMITED TO THE APPLICABLE WARRANTY PERIOD SET FORTH ABOVE.**

How Provincial Laws relates to warranty:

- This warranty gives you specific legal rights which are in addition to statutory warranties that may vary from Province to Province.

If you purchased your unit outside Canada:

- This warranty does not apply. Contact your dealer for warranty information.

Service calls which do not involve defective materials or workmanship are not covered by this warranty. Costs of such service calls are the sole responsibility of the purchaser.

IMPORTADOR

Comercializadora Thomson de México, S.A. de C.V.

Álvaro Obregón No. 151. Piso 13.

Col. Roma. Delegación Cuauhtémoc

C.P. 06700. México, D.F.

Telefono: 52-55-11-020360

RFC: CTM-980723-KS5

EXPORTER

Thomson Inc.

P.O. Box 1976

Indianapolis, IN 46206-1976

© 2006 Thomson Inc.

Trademark(s) ® Registered

Marca(s) ® Registrada(s)

Marque(s) ® Deposée(s)

www.rca.com

Printed In China / Impreso en China

56280040 (EN/F/E)