

System Component

Operating Instructions

Model No. **SC-EH760**
SC-EH560

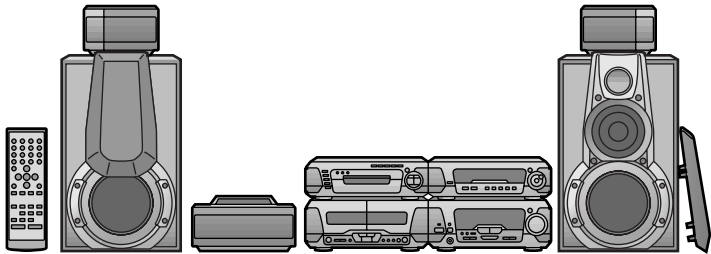

The illustrations show SC-EH760 for areas except Australia and N.Z.

COMPACT
disc
DIGITAL AUDIO

Technics®

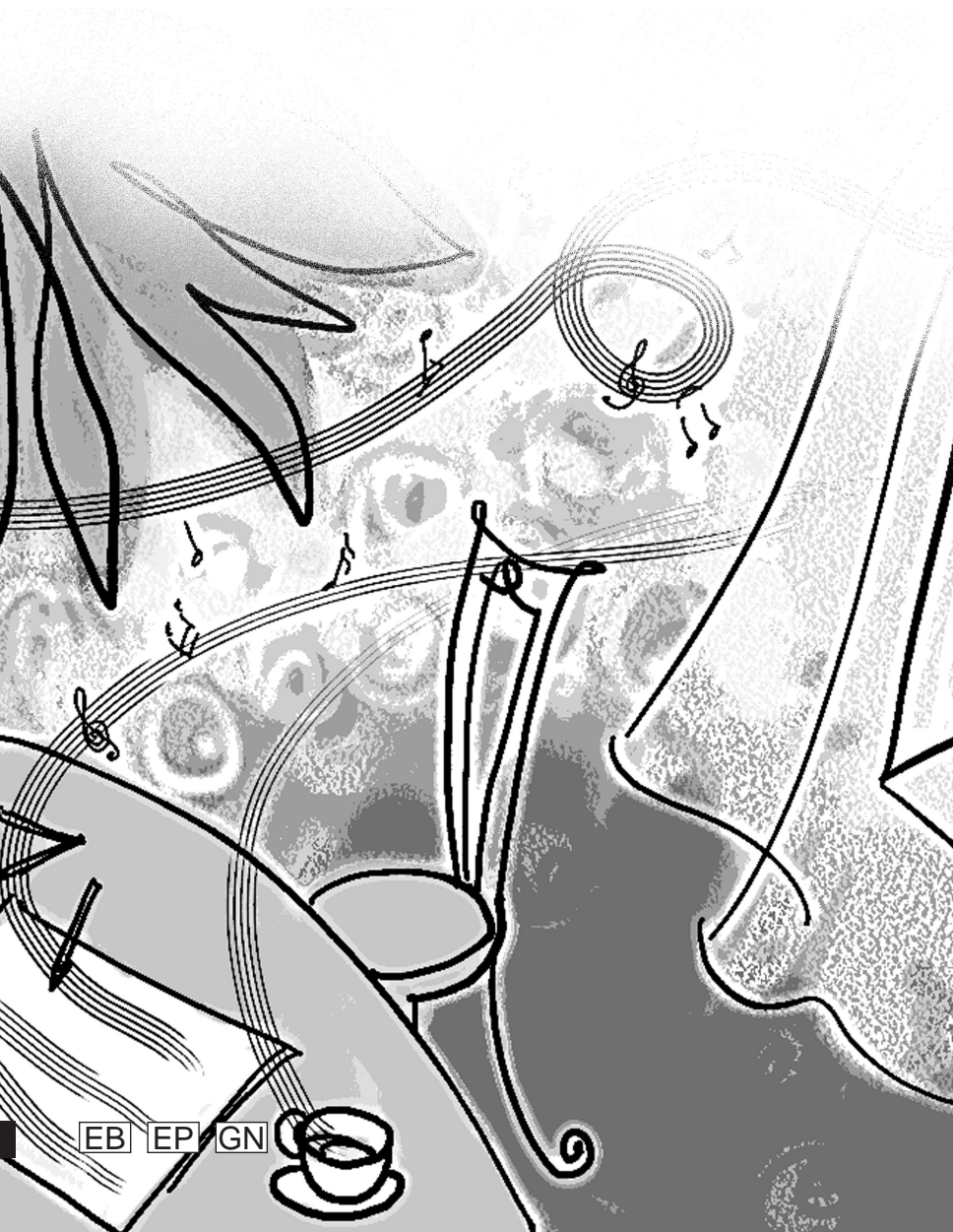

Note

The "EB" indication shown on the outside packing case indicates United Kingdom.

Before connecting, operating or adjusting this product, please read these instructions completely. Please keep this manual for future reference.

RQT5355-B

Dear customer

Thank you for purchasing this product.
For optimum performance and safety, please read these instructions carefully.

These operating instructions are applicable to the following systems. These operating instructions, however, fundamentally explain the operation of system SC-EH760.

SC-EH760: indicates a function which can be enjoyed with SC-EH760 only.

SC-EH560: indicates a function which can be enjoyed with SC-EH560 only.

System		SC-EH760	SC-EH560
Sound processor		SH-EH760	SH-EH560
Tuner amplifier		SA-EH760	SA-EH560
CD changer		SL-EH760	—
CD player		—	SL-EH560
Cassette deck		RS-EH760	RS-EH760
Speaker	Front	SB-EH760	SB-EH560
	Center	SB-PC75	—
	Surround	SB-PS75	—

CAUTION!

THIS PRODUCT UTILIZES A LASER.
USE OF CONTROLS OR ADJUSTMENTS OR PERFORMANCE OF PROCEDURES OTHER THAN THOSE SPECIFIED HEREIN MAY RESULT IN HAZARDOUS RADIATION EXPOSURE.
DO NOT OPEN COVERS AND DO NOT REPAIR YOURSELF. REFER SERVICING TO QUALIFIED PERSONNEL.

CAUTION!

DO NOT INSTALL OR PLACE THIS UNIT IN A BOOKCASE, BUILT IN CABINET OR IN ANOTHER CONFINED SPACE. ENSURE THE UNIT IS WELL VENTILATED. ENSURE THAT CURTAINS AND ANY OTHER MATERIALS DO NOT OBSTRUCT THE VENTILATION TO PREVENT RISK OF ELECTRIC SHOCK OR FIRE HAZARD DUE TO OVERHEATING.

**CLASS 1
LASER PRODUCT**

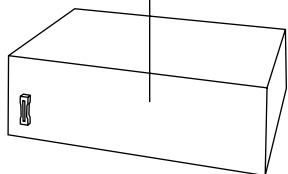

CD changer or CD player
(Back of product)

DANGER	INVISIBLE LASER RADIATION WHEN OPEN. AVOID DIRECT EXPOSURE TO BEAM.	(Inside of product)
ADVARSEL	USYNLIG LASERSTRÅLING VED ÅBNING. NÅR SIKKERHEDSAFBRYDERE ER UDE AF FUNKTION. UNDGÅ UDSÆTTELSE FOR STRÅLING.	(Indersiden af apparatet)
VARO!	AVATTAESSA JA SUOJALUKITUS OHITETTAESSA OLET ALLTIINA NÄKYMÄTÖNTÄ LASERSÄTELYLLÄ. ÄLÄ KATSO SÄTEESEEN.	(Tuotteen sisällä)
VARNING	OSYNLIG LASERSTRÅLNING NÄR DENNA DEL ÄR ÖPPNAD OCH SPÄRREN ÄR URKOPPLAD. BETRÄKTA EJ STRÅLEN.	(Apparatens insida)
ADVARSEL	USYNLIG LASERSTRÅLING NÄR DEKSEL ÅPNES OG SIKKERHEDSLÅS BRYTES. UNNGÅ EKSPONERING FOR STRÅLEN.	(Produktets inside)
VORSICHT	UNSIHTBARE LASERSTRÄHLUNG, WENN ABDECKUNG GEÖFFNET. NICHT DEM STRAHL AUSSETZEN.	(Im Inneren des Gerätes)

Supplied accessories



Please check and identify the supplied accessories.

- AC mains lead** 1 pc.
For United Kingdom (VJA0733) For Australia and N.Z. (RJA0035-X)

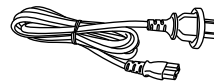
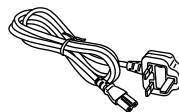

For others (RJA0019-X)

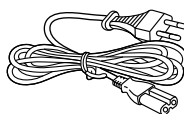

- Remote control transmitter** 1 pc.
SC-EH760 (RAK-EHA28WH) **SC-EH560** (RAK-EHA29WH)

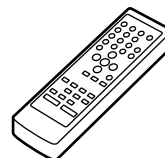
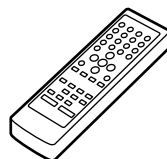

- Remote control batteries** 2 pcs.

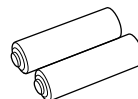

- FM indoor antenna** 1 pc.
For Australia and N.Z. (RSA0006) For others (RSA0007)

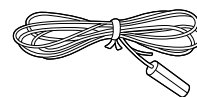
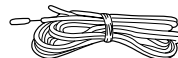

- AM loop antenna set (RSA0022-J)** 1 set

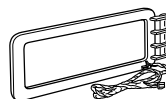

- Speaker cords** 6 pcs.
SC-EH760 (REE0984) (REE0985) **SC-EH560** (REE0393) (REE0499)
(Blue•Black) (Gray•Black) (Red•Black) (Red•Black)



- Antenna plug adaptor (SJP9009)** 1 pc.
(Only for United Kingdom)



Use numbers indicated in parentheses when asking for replacement parts.

Before use

Safety precautions	3
Caution for AC Mains Lead	4
Installation	5
Basic connections	6
Optional antenna connections	7
Front panel controls	8
The remote control	10
Setting the time	11
Turning DEMO off	11
Saving power in the standby mode	11

Basic operations

CDs	12
The radio: manual tuning	16
The radio: preset tuning	17
Cassette tapes	18

Changing sound field and quality

Changing sound field and quality	20
Using the manual equalizer	20
Using the acoustic image equalizer (3D AI EQ)	21
Boosting the super woofer	21
Enjoying surround sound	22
6CH DISCRETE INPUT SC-EH760	24
DOLBY PRO LOGIC SC-EH760	25
VIRTUAL DOLBY SURROUND SC-EH560	26
SUPER SURROUND SC-EH760	26
SIMULATED STEREO	26
Surround effects	27
CENTER FOCUS SC-EH760	27
VIRTUAL REAR SURROUND SC-EH760	27
MULTI REAR SURROUND SC-EH760	27
3D ENHANCED SURROUND SC-EH760	27
CENTER EFFECT SC-EH560	28
SURROUND EFFECT SC-EH560	28
SEAT POSITION	29

Recording operations

Before recording (Deck 2 only)	30
Recording CDs	32
Recording the radio	33
Tape-to-tape recording	33

Timer operations

Using the timers	34
-------------------------------	-----------

Convenient functions

Changing the sound range display	37
Muting the volume	37
Using headphones (not included)	37
External unit connections	38
Using other equipment	39
Enjoy karaoke with CDs and cassettes (for Australia and N.Z. only)	40

Reference

Technical specifications	41
Troubleshooting guide	42
Maintenance	43

Placement

Set the system up on an even surface away from direct sunlight, high temperatures, high humidity, and excessive vibration. These conditions can damage the cabinet and other components, thereby shortening the unit's service life.

Place it at least 15 cm away from wall surfaces to avoid distortion and unwanted acoustical effects.

Do not place heavy items on the unit.

Voltage

Do not use high voltage power sources. This can overload the unit and cause a fire.

Do not use a DC power source. Check the source carefully when setting the unit up on a ship or other place where DC is used.

AC mains lead protection

Ensure the AC mains lead is connected correctly and not damaged. Poor connection and lead damage can cause fire or electric shock. Do not pull, bend, or place heavy items on the lead.

Grasp the plug firmly when unplugging the lead. Pulling the AC mains lead can cause electric shock.

Do not handle the plug with wet hands. This can cause electric shock.

Foreign matter

Do not let metal objects fall inside the unit. This can cause electric shock or malfunction.

Do not let liquids get into the unit. This can cause electric shock or malfunction. If this occurs, immediately disconnect the unit from the power supply and contact your dealer.

Do not spray insecticides onto or into the unit. They contain flammable gases which can ignite if sprayed into the unit.

Service

Do not attempt to repair this unit by yourself. If sound is interrupted, indicators fail to light, smoke appears, or any other problem that is not covered in these instructions occurs, disconnect the AC mains lead and contact your dealer or an authorized service center. Electric shock or damage to the unit can occur if the unit is repaired, disassembled or reconstructed by unqualified persons.

Extend operating life by disconnecting the unit from the power source if it is not to be used for a long time.

(For United Kingdom)

(“EB” area code model only)

For your safety, please read the following text carefully.

This appliance is supplied with a moulded three pin mains plug for your safety and convenience.

A 5-ampere fuse is fitted in this plug.

Should the fuse need to be replaced please ensure that the replacement fuse has a rating of 5-ampere and that it is approved by ASTA or BSI to BS1362.

Check for the ASTA mark  or the BSI mark  on the body of the fuse.

If the plug contains a removable fuse cover you must ensure that it is refitted when the fuse is replaced.

If you lose the fuse cover the plug must not be used until a replacement cover is obtained.

A replacement fuse cover can be purchased from your local dealer.

CAUTION!

IF THE FITTED MOULDED PLUG IS UNSUITABLE FOR THE SOCKET OUTLET IN YOUR HOME THEN THE FUSE SHOULD BE REMOVED AND THE PLUG CUT OFF AND DISPOSED OF SAFELY.

THERE IS A DANGER OF SEVERE ELECTRICAL SHOCK IF THE CUT OFF PLUG IS INSERTED INTO ANY 13-AMPERE SOCKET.

If a new plug is to be fitted please observe the wiring code as stated below.

If in any doubt please consult a qualified electrician.

IMPORTANT

The wires in this mains lead are coloured in accordance with the following code:

Blue: Neutral, Brown: Live.

As these colours may not correspond with the coloured markings identifying the terminals in your plug, proceed as follows:

The wire which is coloured Blue must be connected to the terminal which is marked with the letter N or coloured Black or Blue.

The wire which is coloured Brown must be connected to the terminal which is marked with the letter L or coloured Brown or Red.

WARNING: DO NOT CONNECT EITHER WIRE TO THE EARTH TERMINAL WHICH IS MARKED WITH THE LETTER E, BY THE EARTH SYMBOL  OR COLOURED GREEN OR GREEN/YELLOW.

THIS PLUG IS NOT WATERPROOF—KEEP DRY.

Before use

Remove the connector cover.

How to replace the fuse

The location of the fuse differ according to the type of AC mains plug (figures A and B). Confirm the AC mains plug fitted and follow the instructions below. Illustrations may differ from actual AC mains plug.

1. Open the fuse cover with a screwdriver.

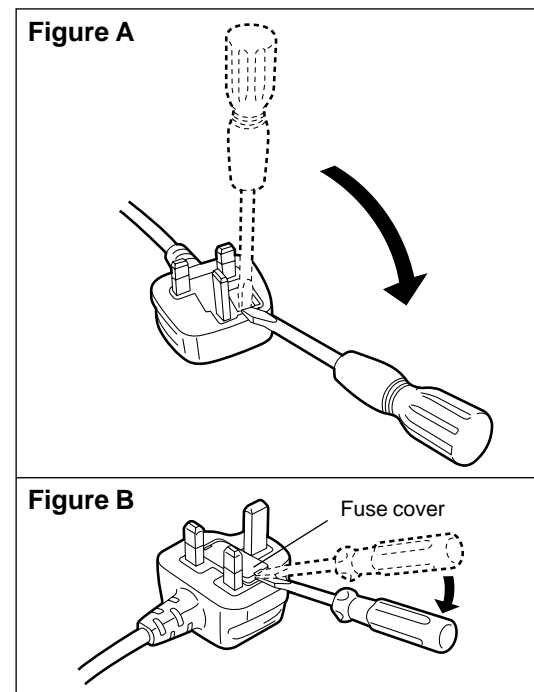

2. Replace the fuse and close or attach the fuse cover.

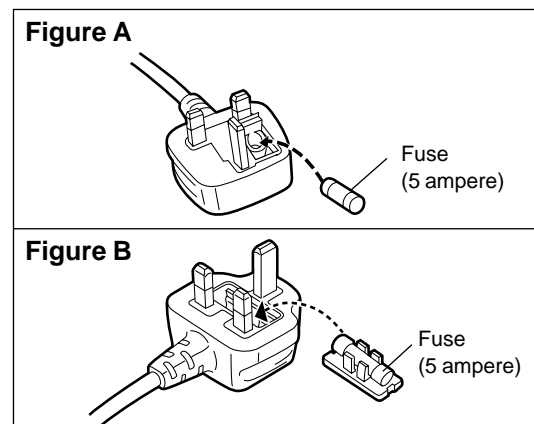

Installation

Locating the components

A Side-by-side set-up

B Stacking

Note

- Do not put the CD changer or CD player on the tuner amplifier. Heat from the tuner amplifier can damage your CDs.
- Left and right front speakers are exactly the same.

Use only the supplied speakers.

The combination of the system and the speakers provides the best sound. Using other speakers can damage the unit and sound quality will be negatively affected.

Caution

- Use the speakers only with the recommended system. Failure to do so may lead to damage to the amplifier and/or the speakers, and may result in the risk of fire. Consult a qualified service person if damage has occurred or if you experience a sudden change in performance.
- Do not attempt to attach these speakers to walls using methods other than those described in this manual.

C Placement of center/surround speakers SC-EH760

Center speaker

Place the center speaker (a) directly above the television.

Surround speakers

Place the surround speakers (b), (c) either side of the listening position, or slightly to the rear, about 1 meter higher than ear level. Place the speakers with the Technics logo facing toward the listening position.

However the position should be adjusted to your personal preference, because the effect varies to some degree depending upon the type of music and the music source.

Note

If you are unable to position the surround speakers as recommended, you can put them near the front speakers and still achieve a surround-like effect (➔ page 27, "VIRTUAL REAR SURROUND").

D Attaching to a wall

Set speaker onto screws and slide through bracket to lock into position.

Note

The wall or pillar on which the speaker systems are to be attached should be capable of supporting 5 kg.

If irregular coloring occurs on your television

Turn the television off for about 30 minutes.

The television's demagnetizing function should correct the problem. If it persists, move the speakers further away from the television.

Before use

A

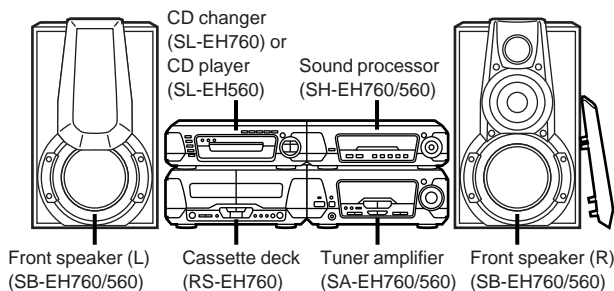

B

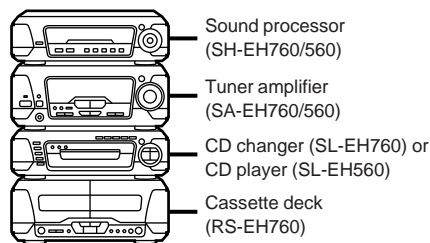

C

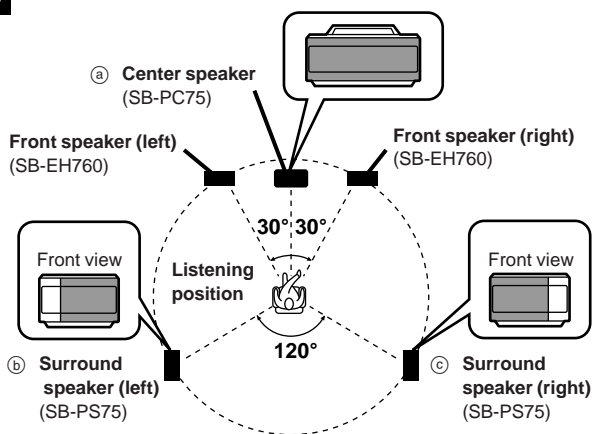

※The front, center, and surround speakers should be placed at approximately the same distance from the listening position. The angles in the diagram are approximate.

D

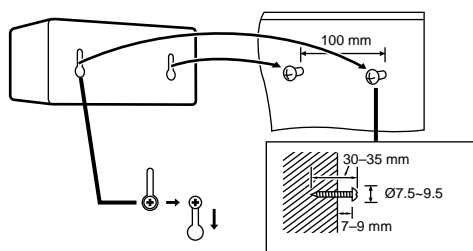

Basic connections

Before use

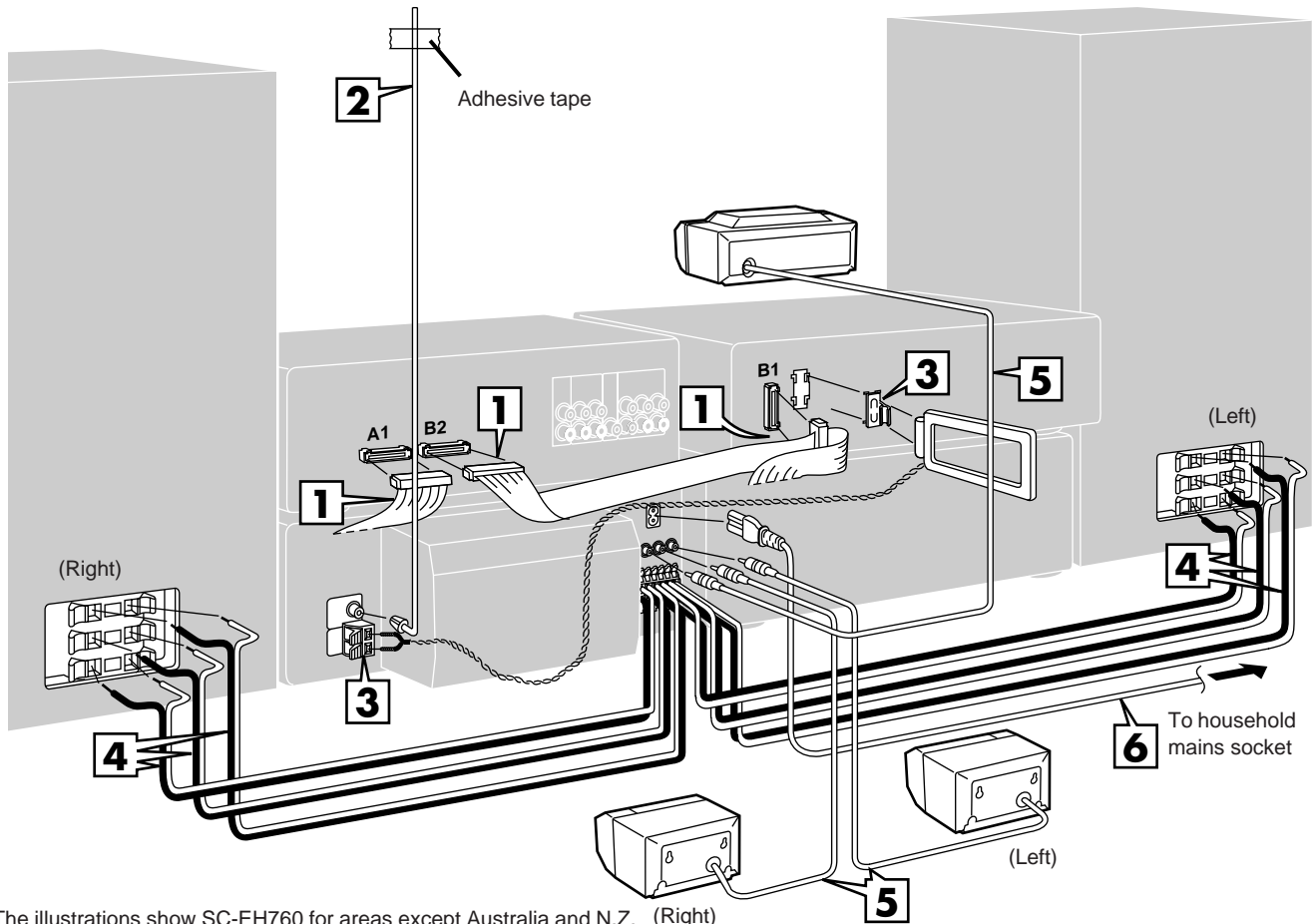

The illustrations show SC-EH760 for areas except Australia and N.Z. (Right)

<p>A</p>	<p>3</p> <p>①</p>	<p>4 Tuner amplifier side</p> <p>Speaker side</p>
<p>1</p> <p>To connect cables To unplug cables</p> <p>Hold the connector from both ends and pull it out.</p>	<p>② (For Australia and N.Z.)</p> <p>(For others)</p>	<p>6</p> <p>Appliance inlet Connector</p> <p>Approx. 6 mm</p>
<p>2 (For Australia and N.Z.)</p> <p>(For others)</p>		

Optional antenna connections

Before connection

- Do not connect the AC mains lead until all other connections are complete.
- To prepare the AM loop antenna and speaker cables (and FM antenna for Australia and N.Z.), twist the vinyl tip and pull off (A).

1 Flat cables.

Keep the cables as flat as possible against the back of the unit.

Note

Connect the black connectors to the black terminals and the blue connector to the blue terminal. Incorrect connection of the flat cables can damage the unit.

2 FM antenna.

Fix the other end of the antenna where reception is best.

3 AM loop antenna.

- ① Attach the antenna holder to the rear panel of the CD changer or CD player. Then clamp the antenna into the antenna holder.
- ② Connect the antenna terminal to the rear panel of the tuner amplifier.

Keep loose antenna cord away from other wires and cords.

4 Front (L/R) speaker cables.

Connect the cables to the terminals of the same color.

Note

- To prevent damage to circuitry, never short-circuit positive (+) and negative (-) speaker wires.
- Be sure to connect only positive (red, blue or gray) wires to positive (+) terminals and negative (black) wires to negative (-) terminals.

5 SC-EH760

Surround and center speaker cables.

(For United Kingdom only)
BE SURE TO READ THE CAUTION FOR THE AC MAINS LEAD ON PAGE 4 BEFORE PROCEEDING TO STEP 6.

6 AC mains lead.

Insertion of connector

Even when the connector is perfectly inserted, depending on the type of inlet used, the front part of the connector may jut out as shown in the drawing.

However there is no problem using the unit.

Note

The included AC mains lead is for use with this unit only. Do not use it with other equipment.

For your reference:

Information you enter into the unit's memory, except for time, remains intact for up to two weeks after the mains lead is disconnected.

Use outdoor antennas if radio reception is poor.

FM outdoor antenna

Note

- Disconnect the FM indoor antenna.
- The antenna should be installed by a competent technician.

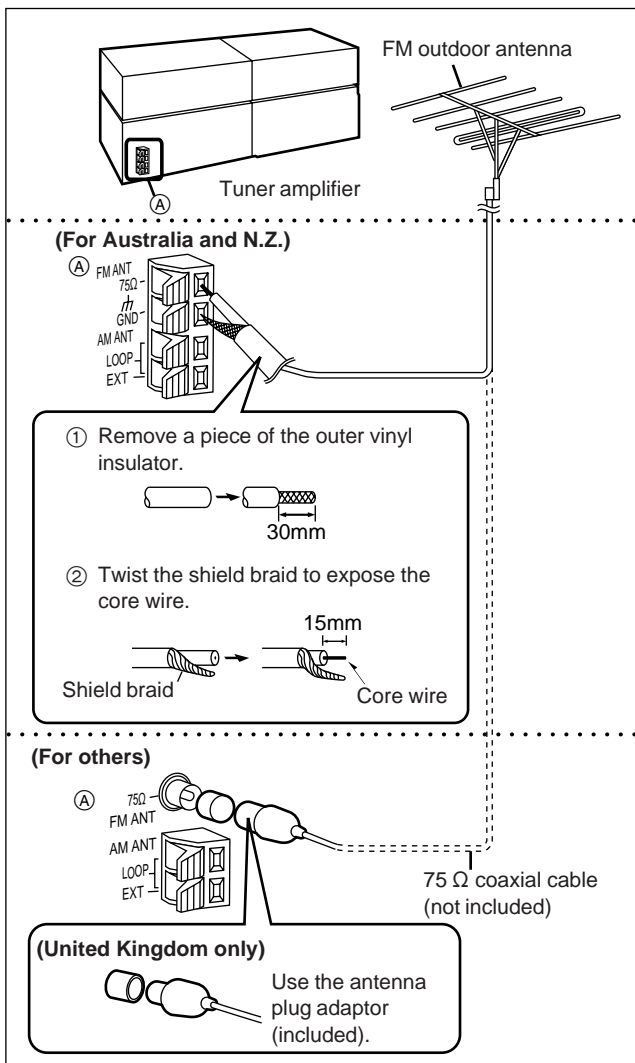

AM outdoor antenna

Run a piece of vinyl wire horizontally across a window or other convenient location.

Note

- Leave the loop antenna connected.
- Disconnect the antenna when the unit is not in use. Do not use the antenna during an electrical storm.

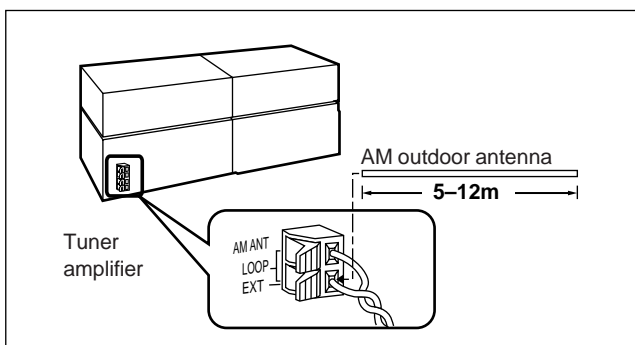

Before use

A SC-EH760

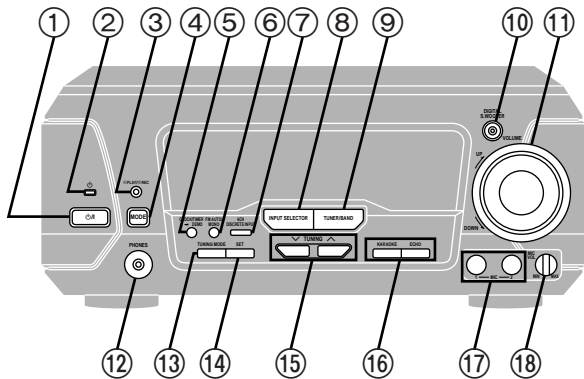

SC-EH560

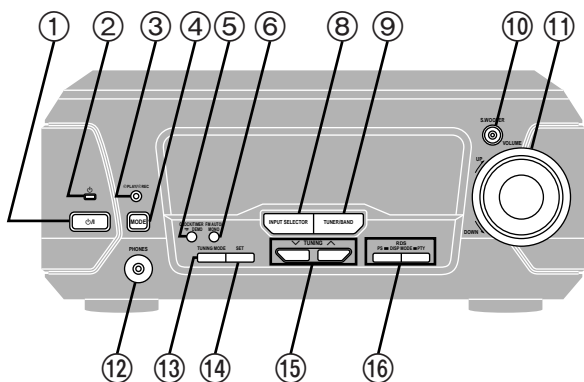

B SC-EH760

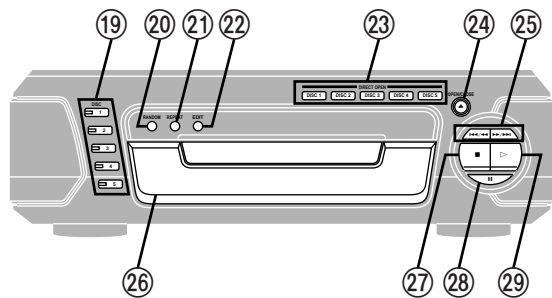

SC-EH560

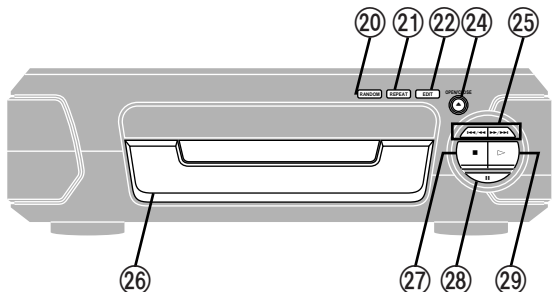

A Tuner amplifier

- ① **Standby/on switch (⏻/⏻)** 11, 34, 35
Press to switch the unit from on to standby mode or vice versa. In standby mode, the unit is still consuming a small amount of power.
- ② **Standby indicator (⏻)**
When the unit is connected to the AC mains supply, this indicator lights up in standby mode and goes out when the unit is turned on.
- ③ **Play timer/record timer button and indicator (⏻/⏻)** 34, 35
- ④ **ECO mode button (MODE)** 11
- ⑤ **Clock/timer, demo button (CLOCK/TIMER, -DEMO)** 11, 34-36
- ⑥ **FM mode button (FM AUTO/MONO)** 16
- ⑦ **SC-EH760**
6ch discrete input button (6CH DISCRETE INPUT) 24
- ⑧ **Source input button (INPUT SELECTOR)** 39
- ⑨ **Tuner/band button (TUNER/BAND)** 16
- ⑩ **SC-EH760**
Digital super woofer button and indicator (DIGITAL S.WOOFER) 21
- SC-EH560**
Super woofer button and indicator (S.WOOFER) 21
- ⑪ **Volume control (VOLUME)** 12, 16, 18
- ⑫ **Headphone jack (PHONES)** 37
- ⑬ **Tuning mode button (TUNING MODE)** 16
- ⑭ **Set button (SET)** 11, 17, 34, 35
- ⑮ **Tuning buttons (∇, ▲ TUNING)** 11, 16, 34, 35
- ⑯ **SC-EH760 for areas except Australia and N.Z.**
SC-EH560 for areas except United Kingdom
RDS display mode buttons (RDS, PS-DISP MODE-PTY) 16
- SC-EH760 for Australia and N.Z.**
KARAOKE and echo buttons (KARAOKE, ECHO) 40
- ⑰ **SC-EH760 for Australia and N.Z.**
Microphone jacks (MIC, 1, 2) 40
- ⑱ **SC-EH760 for Australia and N.Z.**
Microphone volume control (MIC VOL) 40

B CD changer/CD player

- ⑲ **SC-EH760**
Disc select buttons and indicators (DISC, 1-5) 12
Green: Indicates that the tray is ready to play its CD or to be opened.
- ⑳ **Random play button (RANDOM)** 15
- ㉑ **Repeat button (REPEAT)** 15
- ㉒ **CD edit button (EDIT)** 32
- ㉓ **SC-EH760**
Disc direct open buttons (DIRECT OPEN, DISC 1- DISC 5) 12
- ㉔ **Disc tray open/close button (▲ OPEN/CLOSE)** 12
- ㉕ **Skip/search buttons (◀◀/▶▶)** 13
- ㉖ **Disc tray** 12
- ㉗ **Stop button (■)** 13
- ㉘ **Pause button (⏸)** 13
- ㉙ **Play button and indicator (▶)** 12, 32
The color of the indicator depends on the operation taking place.
If stopped: orange
If playing: green
If paused: flashes

A

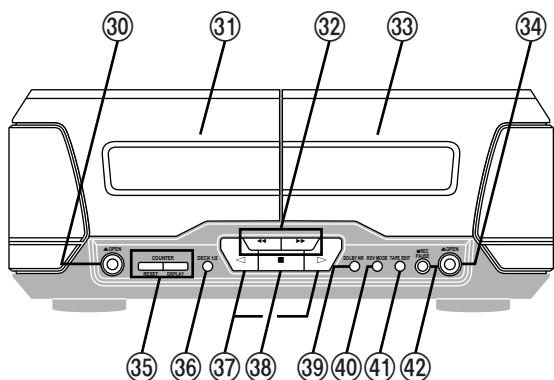

A **Cassette deck**

- 30 Deck 1 cassette holder open button (▲ OPEN) 18
- 31 Deck 1 cassette holder
- 32 Fast forward/rewind buttons (◀◀, ▶▶) 19
- 33 Deck 2 cassette holder
- 34 Deck 2 cassette holder open button (▲ OPEN) 18, 31
- 35 Counter reset, display buttons (COUNTER, RESET, DISPLAY) 30
- 36 Deck 1/deck 2 select button (DECK 1/2) 18, 19
- 37 Playback buttons and indicators (◀, ▶) 18, 32, 33
The color of the indicators depends on the operation taking place.
If stopped, fast forwarding or rewinding: orange
If playing or recording: green
While carrying out TPS or recording is on standby: flashes
- 38 Stop button (■) 18, 32
- 39 Dolby noise reduction button (DOLBY NR) 18, 31
- 40 Reverse mode button (REV MODE) 18, 31
- 41 Tape edit button (TAPE EDIT) 33
- 42 Record pause button (● REC PAUSE) 32, 33

B

SC-EH760

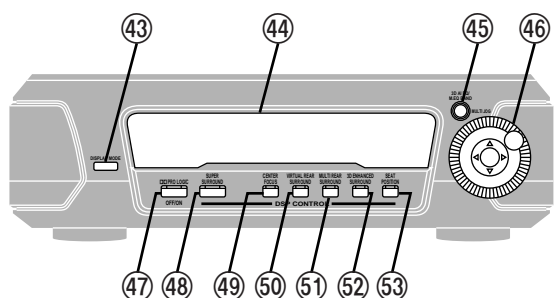

SC-EH560

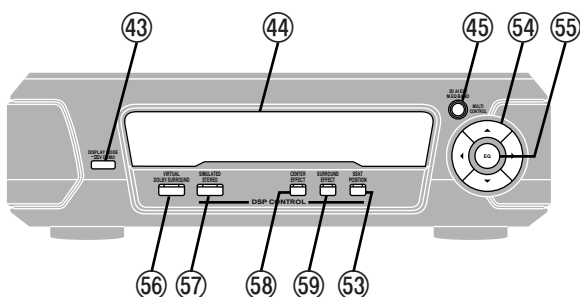

B **Sound processor**

- 43 **SC-EH760**
Display mode button (DISPLAY MODE) 37
- SC-EH560**
Display mode, virtual speaker demo button (DISPLAY MODE, -□□V DEMO) 26, 37
- 44 Display
- 45 3D AI EQ, M.EQ BAND button (3D AI EQ/M.EQ BAND) 20, 21
- 46 **SC-EH760**
Jog control and joystick (MULTI JOG) 20, 21
- 47 **SC-EH760**
DOLBY PRO LOGIC button and indicator (□□ PRO LOGIC, OFF/ON) 25
- 48 **SC-EH760**
Super surround button and indicator (SUPER SURROUND) 26
- 49 **SC-EH760**
Center focus button and indicator (CENTER FOCUS) ... 27
- 50 **SC-EH760**
Virtual rear surround button and indicator (VIRTUAL REAR SURROUND) 27
- 51 **SC-EH760**
Multi rear surround button and indicator (MULTI REAR SURROUND) 27
- 52 **SC-EH760**
3D ENHANCED SURROUND button and indicator (3D ENHANCED SURROUND) 27
- 53 Seat position button and indicator (SEAT POSITION) 29
- 54 **SC-EH560**
Multi control buttons (◀, ▶, ▲, ▼ MULTI CONTROL) 20, 21
- 55 **SC-EH560**
EQ button (EQ) 20, 21
- 56 **SC-EH560**
Virtual Dolby Surround button and indicator (VIRTUAL DOLBY SURROUND) 26
- 57 **SC-EH560**
Simulated stereo button and indicator (SIMULATED STEREO) 26
- 58 **SC-EH560**
Center effect button and indicator (CENTER EFFECT) 28
- 59 **SC-EH560**
Surround effect button and indicator (SURROUND EFFECT) 28

The remote control

Before use

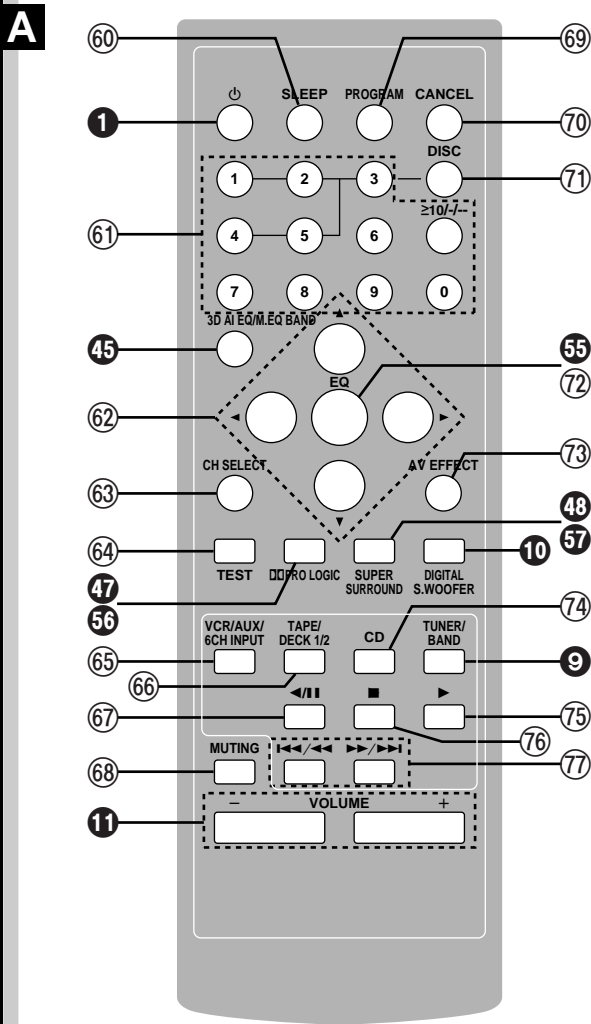

A Controls

Buttons 1, 9-11, 45, 47, 48 and 55-57 function in the same way as the controls on the main unit.

- 60 Sleep timer button (SLEEP) 36
- 61 Numbered buttons (1-9, 0, ≥10/--) 14, 15, 17
- 62 Cursor buttons (◀, ▶, ▲, ▼) 20, 21
- 63 **SC-EH760**
Channel select button (CH SELECT) 24, 26
- 64 **SC-EH760**
Test button (TEST) 25
- 65 **SC-EH760**
Input select button (VCR/AUX/6CH INPUT) 24, 39
- SC-EH560**
VCR button (VCR) 39
- 66 TAPE select, deck 1/deck 2 select button (TAPE/DECK 1/2) 18, 19
- 67 CD pause/Tape reverse playback button (◀||) 13, 18, 32, 33
- 68 Muting button (MUTING) 37
- 69 Program button (PROGRAM) 14
- 70 Cancel button (CANCEL) 14
- 71 **SC-EH760**
Disc button (DISC) 14, 15
- 72 EQ button (EQ) 20, 21
- 73 AV effect button (AV EFFECT) 27-29
- 74 CD button (CD) 14, 15
- 75 CD play/tape forward playback button (▶) 12, 14, 18, 32, 33
- 76 CD/tape stop button (■) 13, 18, 32
- 77 CD skip/search, tape fast forward/rewind buttons (◀◀/▶▶) 13, 19

B Batteries

- Insert so the poles (+ and -) match those in the remote control.
- Do not use rechargeable type batteries.

Do not;

- mix old and new batteries.
 - use different types at the same time.
 - heat or expose to flame.
 - take apart or short circuit.
 - attempt to recharge alkaline or manganese batteries.
 - use batteries if the covering has been peeled off.
- Mishandling of batteries can cause electrolyte leakage which can damage items the fluid contacts and may cause a fire. If electrolyte leaks from the batteries, consult your dealer. Wash thoroughly with water if electrolyte comes in contact with any part of your body.

Remove if the remote control is not going to be used for a long period of time. Store in a cool, dark place. Replace if the unit does not respond to the remote control even when held close to the front panel.

If the battery lid comes loose, slide it back into place horizontally.

C Use

Aim at the sensor, avoiding obstacles, at a maximum range of 7 meters directly in front of the unit.

- Keep the transmission window and the unit's sensor free from dust.
- Operation can be affected by strong light sources, such as direct sunlight, and the glass doors on cabinets.

Do not;

- put heavy objects on the remote control.
- take the remote control apart.
- spill liquids onto the remote control.

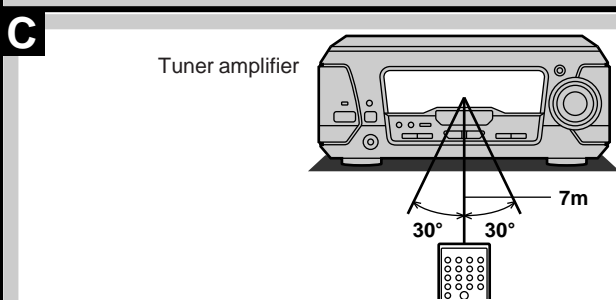
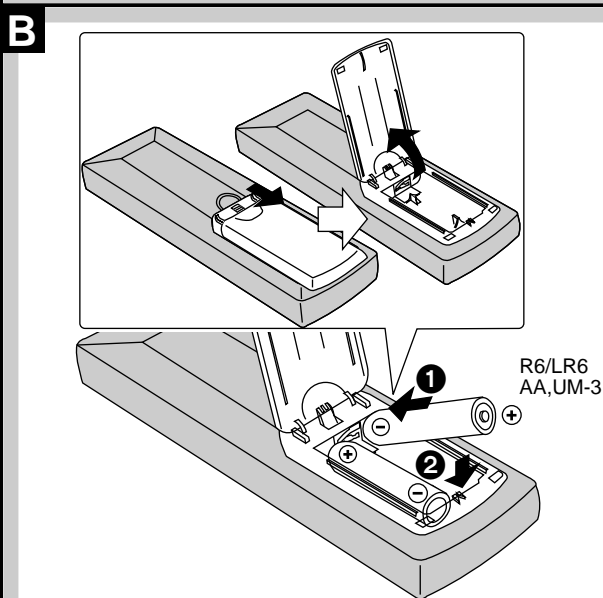

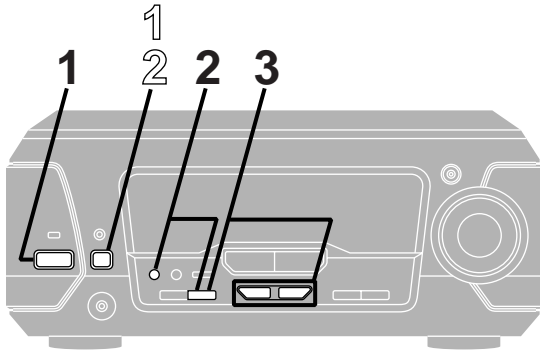
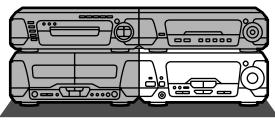

A Setting the time

This is a 24-hour clock.
The example shows how to set the clock for 16:25 (4:25 p.m.).

- 1** Press [⏻/⏻] to turn the unit on.
- 2**
 - ① Press [CLOCK/TIMER, -DEMO] to display “CLOCK”.
Each time you press the button:
CLOCK → ⏻PLAY → ⏻REC → Original display
 - ② Within 7 seconds Press [SET].
- 3**
 - ① Press [TUNING (∨ or ^)] to set the time.
The time display can be changed in one minute units by tapping the buttons, and quickly by holding down the buttons.
 - ② Press [SET].

The time is set and the original display is restored.

Displaying the clock

Press [CLOCK/TIMER, -DEMO].
The clock is shown for about 5 seconds.

B Turning DEMO off

A demonstration of the display is shown if you have not set the clock.
Turn DEMO off to get the most from ECO mode.

While the unit is on:

- 1** Press and hold [CLOCK/TIMER, -DEMO] until “NO DEMO” is displayed.

Each time you press and hold the button:
NO DEMO (off) ↔ DEMO (on)

C Saving power in the standby mode

Set the unit to reduce energy consumption in the standby mode (11 W → 0.5 W).

While the unit is on:

- 1** Press [MODE].
The current mode is displayed.
- 2** Within 5 seconds Press [MODE] to display “ECO”.
Each time you press the button:
NORMAL (off) ↔ ECO (on)

ECO: The clock is not displayed in the standby mode. The “⏻” and “⏻PLAY/⏻REC” indicators still light.

Note

The mode can be switched to ECO when the unit is in standby but it cannot be switched back to NORMAL.

A

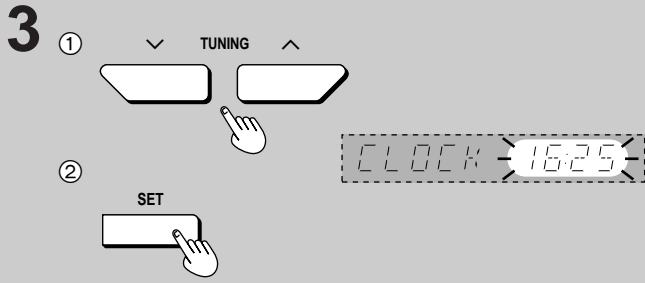
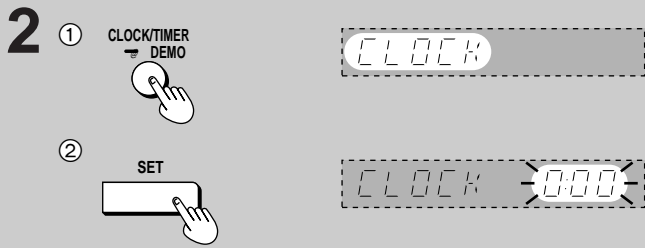

B

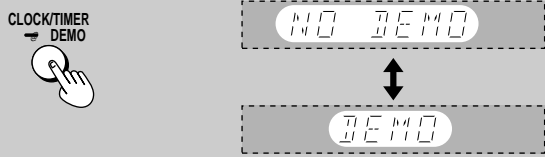

C



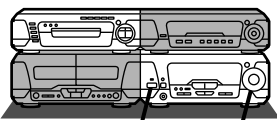

SC-EH760

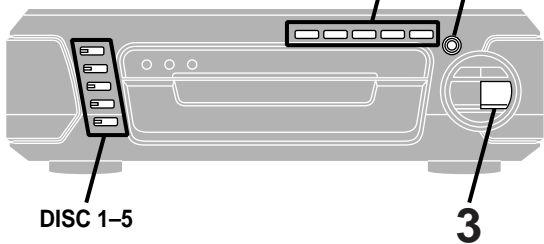

SC-EH560

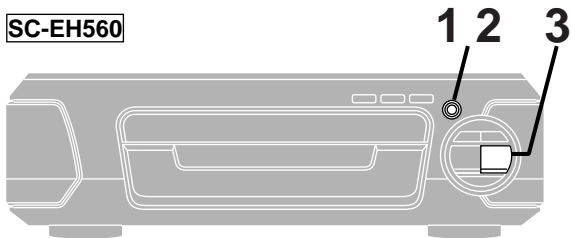

1

SC-EH760

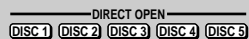

SC-EH560



Label must face upward

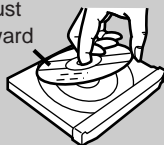

2

SC-EH760

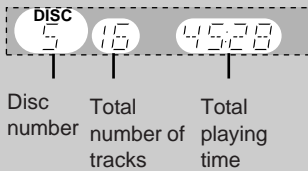

SC-EH560



3

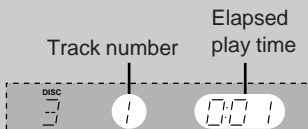
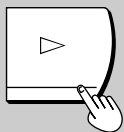

4

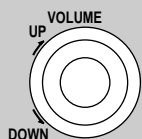

CDs

Normal play

Preparation: Press [⏻/⏮] to turn the unit on.

SC-EH760

- 1** Press [DIRECT OPEN] ([DISC 1]–[DISC 5]) to open a tray and set a CD.
- 2** Press [▲ OPEN/CLOSE] to close the tray.
Repeat steps 1 and 2 to load the other trays.
- 3** Press [▶] to start play.
Play starts from the first track on the disc in the play position and finishes at the end of the last track on the final disc (see below).
You can start play from another disc by pressing [DISC 1–5].
- 4** Adjust the volume.

Note

You can not change CDs while a disc is playing.

What is meant by “final disc”?

For example, if play starts from disc 4, disc 3 will be the “final disc”.

Order of progression:

Disc 4→5→1→2→3

SC-EH560

- 1** Press [▲ OPEN/CLOSE] to open the tray and set a CD.
- 2** Press [▲ OPEN/CLOSE] to close the tray.
- 3** Press [▶] to start play.
- 4** Adjust the volume.

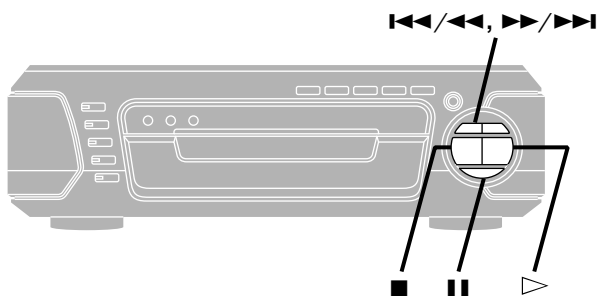
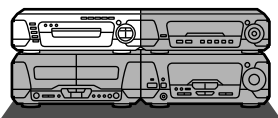

CDs

To stop the disc

Press [■].

To pause play

Press [||] during play. The “▷” indicator flashes.
Press [||] or [▷] to resume play.

Skipping tracks

Press [◀◀/▶▶] (backward), or [▶▶/▶▶] (forward).

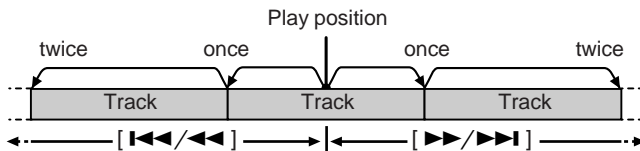

Searching through tracks

During play

Press and hold [◀◀/▶▶] (backward), or [▶▶/▶▶] (forward).

“NO DISC” is displayed

When the unit is in CD mode but a disc isn't in the playing position (SC-EH760) or in the player (SC-EH560).

Note

- Skipping is done in the selected order in program play (➔ page 14).
- You cannot skip to tracks already played in random play (➔ page 15).
- You can search only within tracks in program and random play.

A

(a)



(b)



(c)

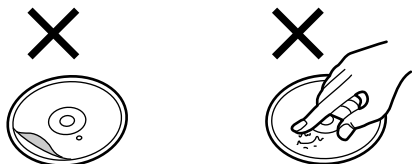

B

(d)

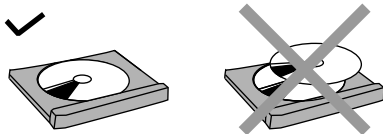

(e)

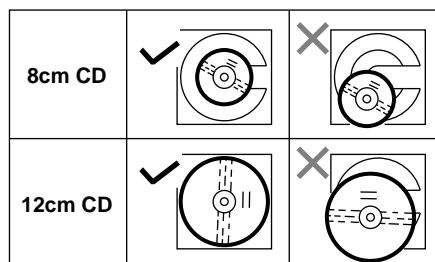

A

CD selection

Choose discs with this mark (a).

Do not;

- use irregularly shaped discs (b).
- attach extra labels and stickers.
- use discs with labels and stickers that are coming off or with adhesive exuding from under labels and stickers (c).
- attach scratch-proof covers or any other kind of accessory.
- write anything on the CD.
- clean CDs with liquids. (Wipe with a soft, dry cloth.)
- use CDs printed with label printers available on the market.

B

To prevent damage

Always observe the following points.

- Load only 1 CD per tray (d).
- Load CDs as shown in figure (e).
- An adaptor is not needed with 8 cm CDs (singles).
- Set the system on a flat, level surface.
- Always unload all CDs before moving the system.

Do not;

- set it on top of magazines, inclined surfaces, etc.
- move the system while tray is opening/closing, or when loaded.
- put anything except CDs in trays.
- use cleaning CDs or CDs which are badly warped or cracked.

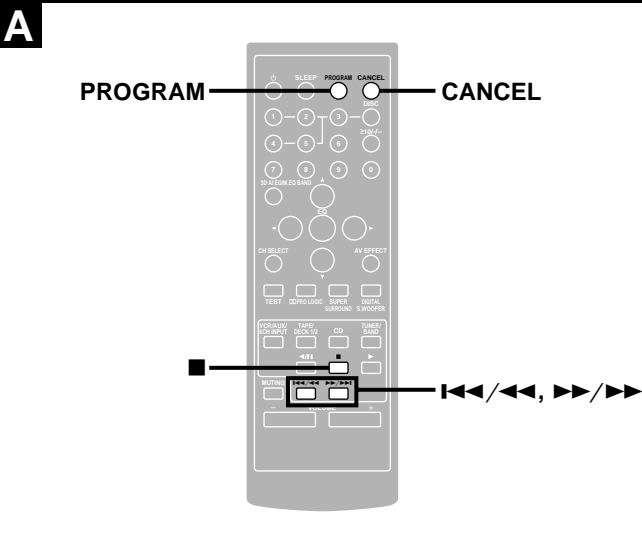
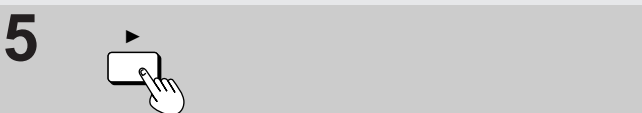
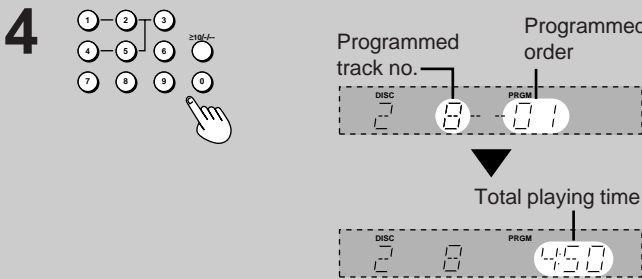
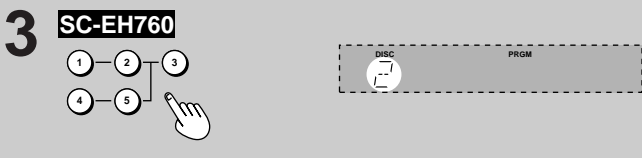
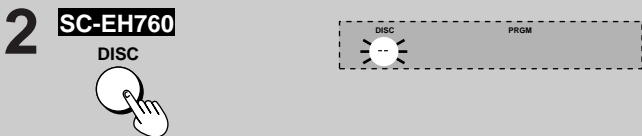
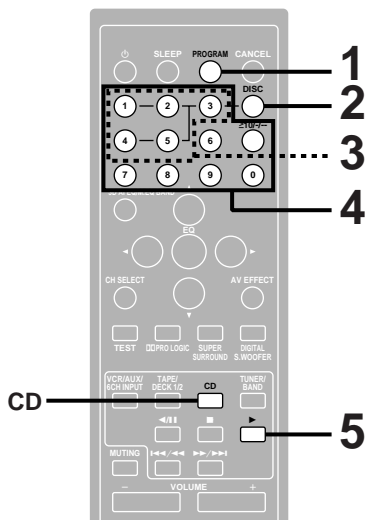

Program play

Select up to 24 tracks to play in the order you choose.

Remote control only

Preparation: Press [CD] to put the unit in CD mode.

1 Press [PROGRAM].

2 SC-EH760
Press [DISC].

3 SC-EH760
Within 10 seconds or so
Press [1]–[5] to select the disc.

4 Select the track with the numbered buttons.

For tracks numbered 10 and over, press [≥10] then the two digits.

Repeat steps 2 through 4 (SC-EH760) or step 4 (SC-EH560) to program the tracks in the required order.

The total playing time of the programmed tracks is displayed.

5 Press [▶].

All the tracks are played in the selected order.

A To cancel

Press [PROGRAM].

“CLEAR” is displayed and all the tracks are canceled. If a track was playing, play continues to the end of the disc.

“FULL” is displayed

If 24 tracks have been programmed.

“--:--” is displayed if;

- total playing time for the tracks is over 99 minutes and 59 seconds.
 - a track numbered 25 or over was programmed.
 - a disc not in playing position was programmed (SC-EH760).
- Tracks can still be programmed and played.

A To check the contents of the program

- ① Press [CANCEL]. “CANCEL” will light.
- ② Press [I◀◀/◀◀] or [▶▶/▶▶]. Each time you press the button, the disc numbers (SC-EH760), track numbers and program positions are displayed.
- ③ After the playing time appears on the display, press [CANCEL]. “CANCEL” goes out.

To add to the end of the program

Repeat steps 2 through 4 (SC-EH760) or step 4 (SC-EH560).

A To cancel tracks

A particular track	1. Press [CANCEL]. 2. Select the track with [I◀◀/◀◀] or [▶▶/▶▶] then press [CANCEL]. 3. Press [CANCEL] again.
All tracks	Press [PROGRAM] or [■] while stopped.

To program the track you are listening to

Press [PROGRAM]. The program mode engages and the current track is automatically recorded as program No. 1.

Other modes of play

Preparation: Press [CD] on the remote control or [INPUT SELECTOR] on the tuner amplifier to select "CD".

A Direct access play

SC-EH760

Starts normal play from a selected track on a selected disc to the last track of the final disc (⇒ page 12).

SC-EH560

Starts normal play from a selected track to the last track.

Remote control only

1 SC-EH760
Press [DISC].

2 SC-EH760
Within 10 seconds or so
Press [1]–[5] to select the disc.

3 Select the track with the numbered buttons.
For tracks numbered 10 and over, press [≥10] then the two digits.

B Random play

SC-EH760

Plays the tracks of all discs once each in random order.

SC-EH560

Plays the tracks once each in random order.

Press [RANDOM].

To cancel
Press [RANDOM].
"RANDOM" goes out.

For your reference:
In the program play mode (⇒ page 14), the programmed tracks are played randomly.

C Repeat play

SC-EH760

Repeats all tracks on all discs or all programmed tracks.

SC-EH560

Repeats all tracks or programmed tracks.

Press [REPEAT] before or during play.

To cancel
Press [REPEAT].
"↺" goes out.

To repeat only your favorite track(s)
① Program the track(s) you want (⇒ page 14).
② Press [REPEAT] and make sure "↺" is displayed.
③ Press [▷]. Play will start.

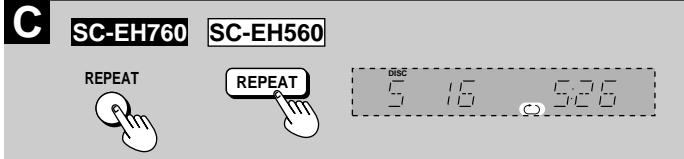
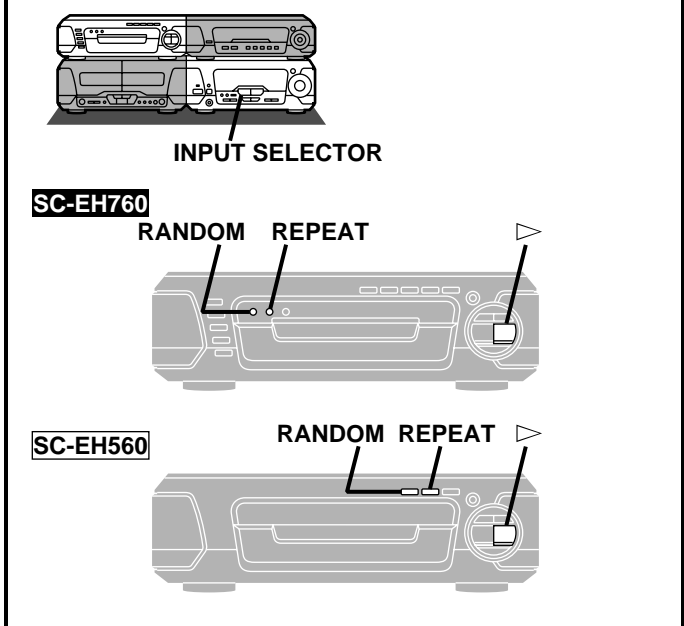
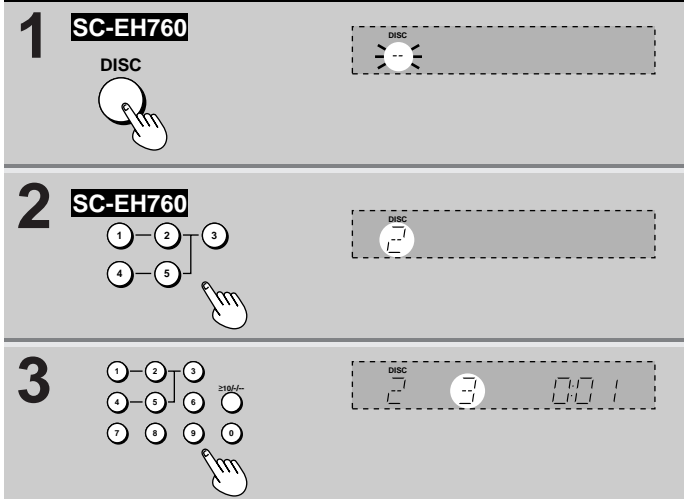
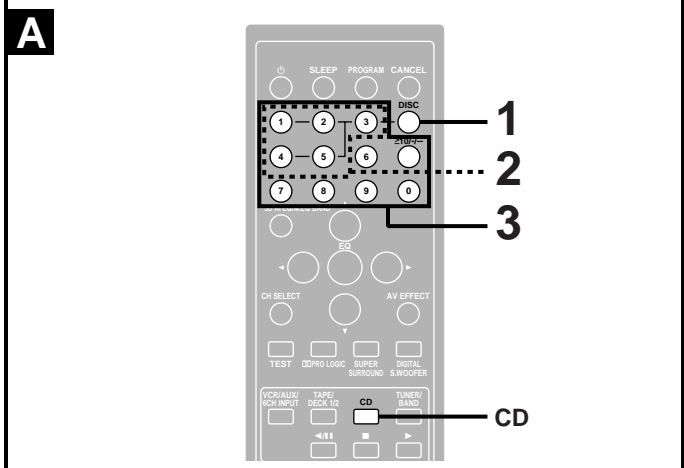

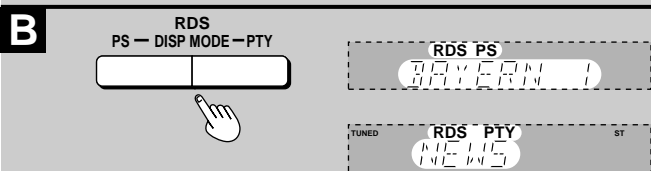
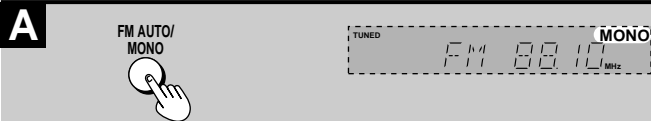
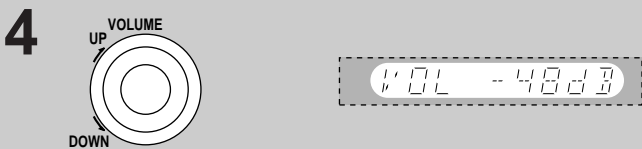
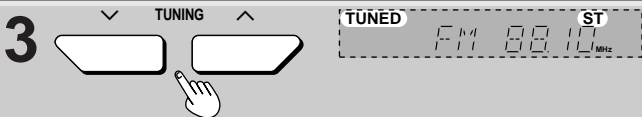
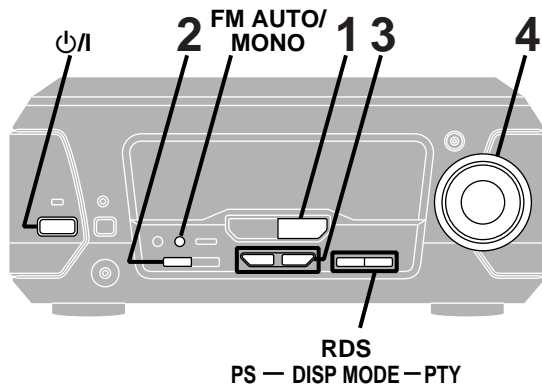
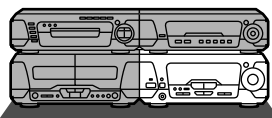

PTY displays			
NEWS	VARIED	FINANCE	COUNTRY
AFFAIRS	POP M	CHILDREN	NATIONAL
INFO	ROCK M	SOCIAL A	OLDIES
SPORT	M.O.R M*	RELIGION	FOLK M
EDUCATE	LIGHT M	PHONE IN	DOCUMENT
DRAMA	CLASSICS	TRAVEL	TEST
CULTURE	OTHER M	LEISURE	ALARM
SCIENCE	WEATHER	JAZZ	

The radio: manual tuning

Radio stations can be tuned manually by selecting the station's frequency or they can be preset into channels to make it easy to tune with the tuner amplifier or the remote control (➔ page 17).

Preparation: Press [P/I] to turn the unit on.

1 Press [TUNER/BAND] to select FM or AM.

Each time you press the button: FM↔AM

2 Press [TUNING MODE] to select "MANUAL".

Each time you press the button: MANUAL↔PRESET

3 Press [TUNING (v or ^)] to tune in the desired broadcast.

"TUNED" is displayed when a radio station is tuned.

"ST" is displayed when a stereo FM broadcast is being received.

4 Adjust the volume.

Auto tuning

Press and hold [TUNING (v or ^)] for a moment until the frequency starts changing rapidly. The unit begins auto tuning, stopping when it finds a station.

- When there is excessive interference, auto tuning may not function.
- To cancel auto tuning, press [TUNING (v or ^)] once again.

A If noise is excessive in FM

Press [FM AUTO/MONO] to display "MONO."

This mode improves sound quality if reception is weak for some reason but broadcasts are heard in monaural.

Press [FM AUTO/MONO] again to cancel the mode. "MONO" goes out.

MONO is also canceled if the frequency is changed.

Turn off "MONO" for normal listening. Stereo and monaural broadcasts are automatically played as they are received.

Stations can be preset in monaural. Carry out presetting manually (➔ page 17).

B RDS broadcasting

- SC-EH760 for areas except Australia and N.Z.**
- SC-EH560 for areas except United Kingdom**

This unit can display the text data transmitted by the radio data system (RDS) available in some areas.

If the station you are listening to is transmitting RDS signals, "RDS" will light up on the display.

Displaying the name of a broadcasting station

Press [PS-DISP MODE] to display a station name.

Press [DISP MODE-PTY] to display a program type.

Each time you press the button:

Frequency display↔PS or PTY display

If the PS display isn't shown

Press and hold [PS-DISP MODE] for about 4 seconds.

The mode switches every time the button is pressed and held:

MODE 1↔MODE 2

Note

RDS displays may not be available if reception is poor.

*"M.O.R M"="Middle of the road music".

The radio: preset tuning

Choose either automatic presetting, which presets all the stations the tuner amplifier can receive, or manual presetting, which allows you to select the stations to preset and the order they are to be preset in. There are 39 channels available for presetting.

A Automatic presetting

Do the following once each for FM and AM.

Preparation: Tune to the frequency presetting is to begin at (→ page 16).

Hold down [SET].

Release the button when "AUTO MEMORY" appears.

The tuner presets all the stations it can receive into the channels in ascending order. FM stations are preset into channels 1 to 39, and AM stations are preset into channels 21 to 39.

"SET OK" is shown when presetting is complete and the last station to be preset is played.

"ERROR" is displayed if the tuner doesn't receive any stations. Do presetting manually if this happens (see below).

Note

AM stations replace any FM channels that were preset in channels 21 to 39.

B Manual presetting

Preset the stations one at a time.

- 1 Tune to the required station.
- 2 Press [SET].
- 3 Press [TUNING (∨ or ^)] to select a channel.
- 4 Press [SET].

The station occupying a channel is erased if another station is preset in that channel.

C Selecting channels

On the remote control

- 1 Press [TUNER/BAND].
- 2 Press the numbered buttons to select the channel.
For channels 1 to 9 press the corresponding number.
For channels 10 or over press [≥10], then the two digits.
e.g. To select channel 21 [≥10]→[2]→[1]
- 3 Adjust the volume.

On the main unit

- ① Select "PRESET" with [TUNING MODE].
- ② Press [TUNING (∨ or ^)] to select the channel.

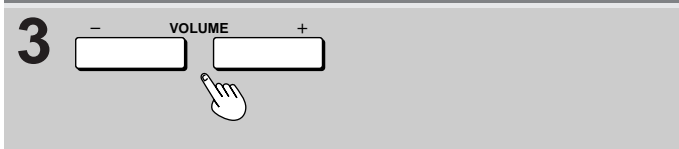
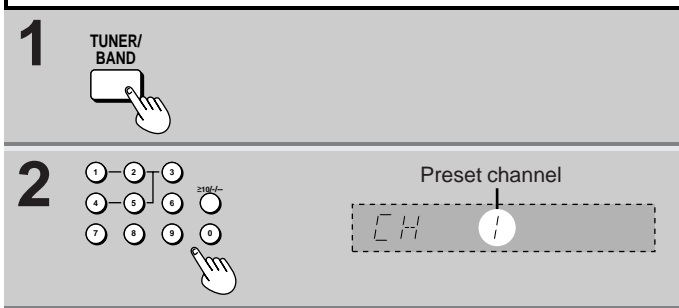
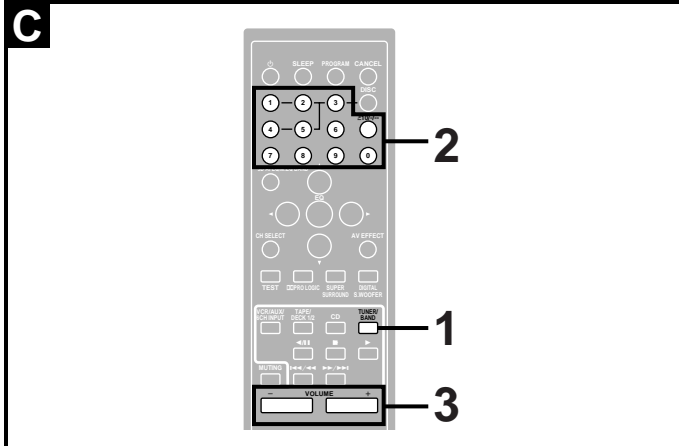
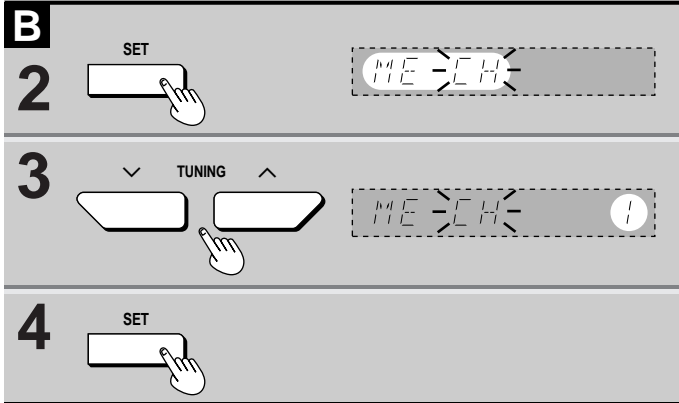
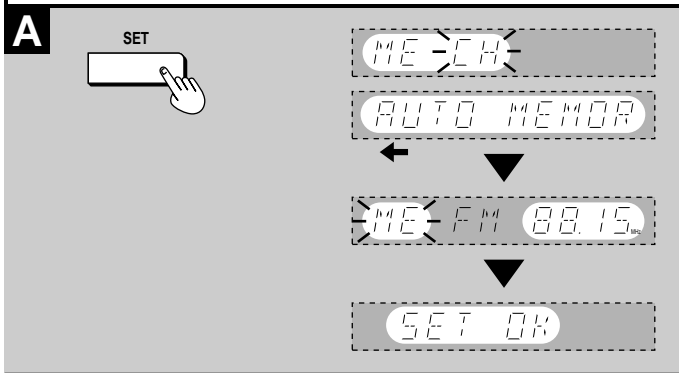
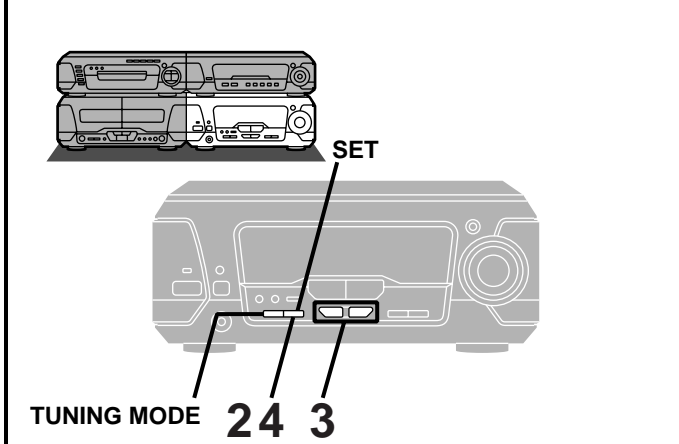

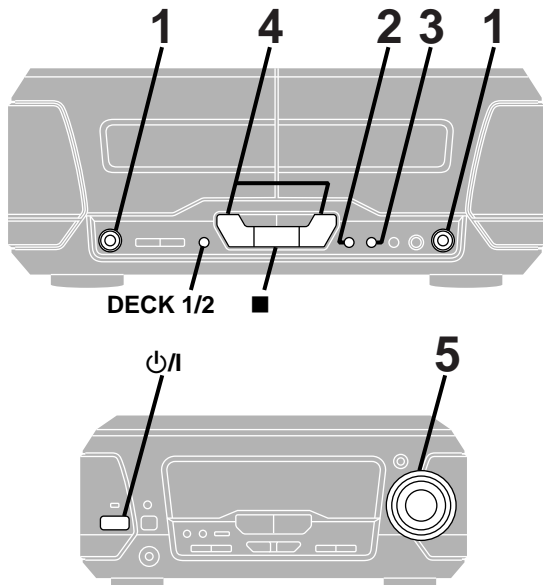
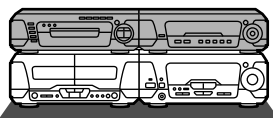

Cassette tapes

Preparation: Press [⏻/⏪] to turn the unit on.

- 1** Press [**▲ OPEN**] on deck 1 or deck 2 and insert the cassette.
- 2** Press [**DOLBY NR**] to select Dolby NR on ("DDNR" appears) or off. (→ "Dolby noise reduction" page 19)
- 3** Press [**REV MODE**] to select the reverse mode.
Each time you press the button:
 - ←: One side is played.
 - ↔: Both sides are played.
 - ↺↻: Both sides are played 8 times each.
- 4** Press [**◀**] (reverse side) or [**▶**] (forward side). Play begins and the indicator changes to green.
- 5** Adjust the volume.

To stop the tape

Press [■].

A To change the deck to be used

Press [DECK 1/2] to select the deck you want to play.

To listen to 2 tapes consecutively

Insert a tape into each deck and select "↺↻". Both tapes will be played 8 times each.

1

▲OPEN



Forward side
Tape facing down

2

DOLBY NR

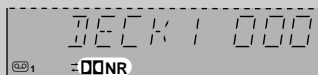

3

REV MODE

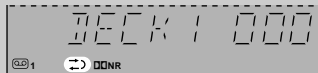

4

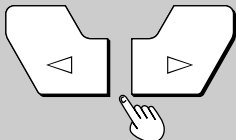

Tape direction



5

VOLUME

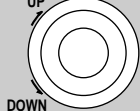

A

DECK 1/2

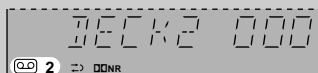

Deck in use

Cassette tape selection and care

The unit can correctly play the following types. It identifies the type automatically.

Normal position/TYPE I	✓
High position/TYPE II	✓
Metal position/TYPE IV	✓

- Tapes exceeding 100 minutes are thin and can break or get caught in the mechanism.
- Tape slack can get caught up in the mechanism and should be taken up before the tape is played.
- Endless tapes can get caught up in the deck's moving parts if used incorrectly. Use tapes appropriate to this unit's auto-reverse mechanism.

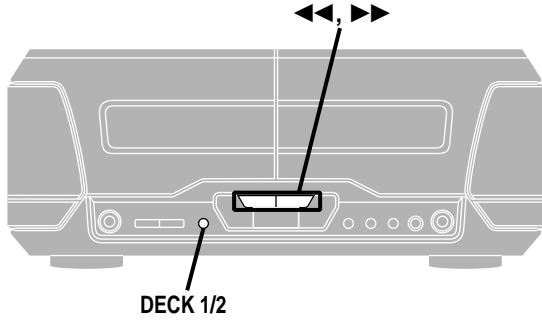
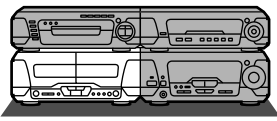

Cassette tapes

A Fast-forwarding and rewinding

Press [◀◀] or [▶▶] while the tape is stopped.

Tape direction	rewind	fast-forward
▷	◀◀	▶▶
◁	▶▶	◀◀

For your reference:

- Each deck's play direction is stored in the system's memory.
- You can fast forward or rewind the tape while you are playing or recording a tape in another deck. Press [DECK 1/2] to switch to the non playing deck, and then press [◀◀] or [▶▶]. After the above operation, be sure to press [DECK 1/2] to reselect the deck in which you are playing a tape.

A



B



B Tape program sensor (TPS)

TPS finds the beginning of a track and resumes play from there.

Press [◀◀] or [▶▶] during play.

Tape direction	backward	forward
▷	◀◀	▶▶
◁	▶▶	◀◀

Note

- TPS may not operate correctly in the following situations:
- If the interval between tracks is less than 4 seconds.
 - If there is noise between tracks.
 - If there are silent parts within tracks.

Dolby noise reduction

Dolby NR reduces "hissing" when playing tapes. It increases the high frequency region when recording and then reduces it in playback. Use the same system during playback and recording. This unit has Dolby B NR which reduces noise to a third. Prerecorded cassettes and equipment marked "DD" use Dolby B NR.

Dolby noise reduction manufactured under license from Dolby Laboratories.
"Dolby" and the double-D symbol are trademarks of Dolby Laboratories.

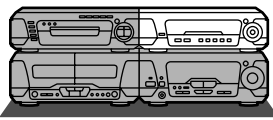

SC-EH760

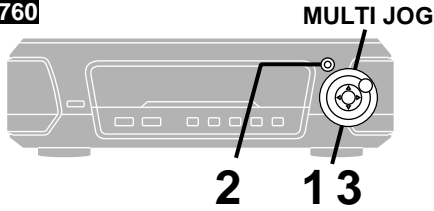

SC-EH560

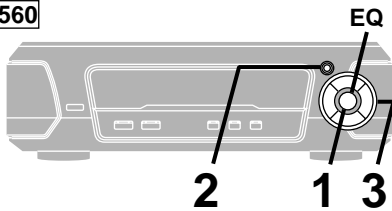

A Changing sound field and quality

Changes to sound field and quality have no effect on recordings.

SC-EH760

Turn **[MULTI JOG]** to select a setting.

SC-EH560

Press **[EQ]** to select a setting.

Each time you turn **[MULTI JOG]** (SC-EH760) or press **[EQ]** (SC-EH560):

HEAVY: Adds punch to rock.

CLEAR: Clarifies higher sounds.

HALL: Expands sound to make you feel like you were in a hall.

AI-EQ: Adjust sound with the acoustic image equalizer (→ page 21).

M.EQ: Create your own effects (→ see below).

FLAT: Canceled (no effect is added).

On the remote control

Press **[EQ]**.

Note

Turn off the effect if sound quality reduces when using **HALL** or **3D AI EQ** with a source.

A **SC-EH760** **SC-EH560** (On the tuner amplifier)

(On the sound processor)

SC-EH760 **SC-EH560**

B Using the manual equalizer

Create your own sound quality effects.

1

SC-EH760

Turn **[MULTI JOG]** to select “**M.EQ**”.

SC-EH560

Press **[EQ]** to select “**M.EQ**”.

2

Press **[3D AI EQ/M.EQ BAND]** to select the band.

Each time you press the button:

LOW → MID → HIGH

3

Use **[◀, ▶, △, ▽]** to make the required curve.

① Select the frequency you want to use as the peak with **[◀, ▶]**.

② Adjust the level of the peak with **[△, ▽]**.

- Adjacent frequencies are adjusted at the same time to maintain a smooth curve.

- When you have adjusted the curve, you can move the peak of the curve by pressing **[◀, ▶]** (a).

Repeat steps 2 and 3 to adjust the three bands.

The original display is restored on the display panel in about 5 seconds.

B

1

(On the sound processor)

2

3D AI EQ/M.EQ BAND

(On the tuner amplifier)

3

(On the sound processor)

1

2

a

To cancel

Turn **[MULTI JOG]** (SC-EH760) or press **[EQ]** (SC-EH560) to select “**FLAT**”.

Note

- The changes you make are stored and automatically recalled the next time you select “**M.EQ**”.

- After making a curve in one band, any adjustments in another band make a curve that is a combination of the two.

C To flatten the curves in all three bands

Set the frequencies **b** in **LOW**, **c** in **MID**, and **d** in **HIGH** to flat.

C

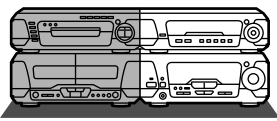

A SC-EH760

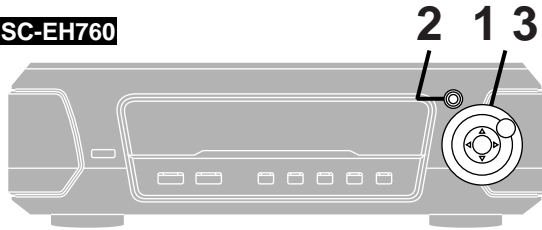

SC-EH560

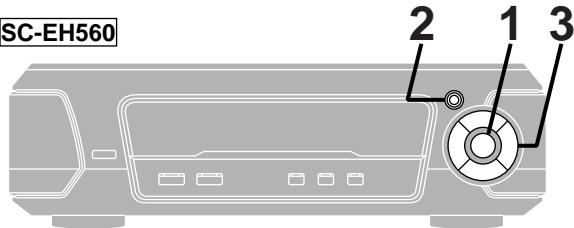

1 SC-EH760 SC-EH560

MULTI JOG

(On the tuner amplifier)

2

3D AI EQ/
M.EQ BAND

(On the sound processor)

3

MULTI JOG

MULTI CONTROL

①

②

B SC-EH760 SC-EH560

DIGITAL S.WOOFER S.WOOFER

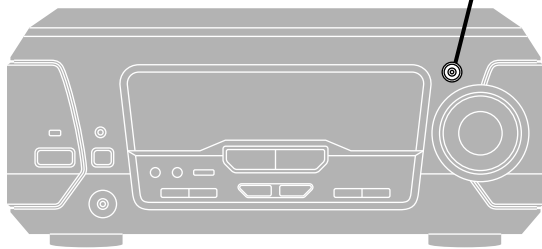

SC-EH760 SC-EH560

DIGITAL S.WOOFER S.WOOFER

(On the tuner amplifier)

A Using the acoustic image equalizer (3D AI EQ)

Achieve subtle sound quality settings with the soft, sharp, heavy, and light coordinates. Select one of the two 3D settings for a surround effect.

- 1 SC-EH760**
Turn [MULTI JOG] to select "AI-EQ".
SC-EH560
Press [EQ] to select "AI-EQ".
- 2** Press [3D AI EQ/M.EQ BAND] to select the surround level.
Each time you press the button:
AI EQ → 3D AI 1 → 3D AI 2
↑
- 3** Change the sound quality with [◀, ▶, △, ▽].
① Adjust softness and sharpness with [◀, ▶].
② Adjust heaviness and lightness with [△, ▽].

The original display is restored on the display panel in about 5 seconds.

To cancel
Turn [MULTI JOG] (SC-EH760) or press [EQ] (SC-EH560) to select "FLAT".

Note

- The changes you make are stored and automatically recalled the next time you select "AI-EQ".
- "3D AI 1" and "3D AI 2" cannot be selected while the surround system or karaoke mode is on (➡ page 22 or 40).

B Boosting the super woofer

SC-EH760
Press [DIGITAL S.WOOFER].
SC-EH560
Press [S.WOOFER].

The indicator lights.
Each time you press the button:
MID (medium) → MAX (high) → cancel
↑

There is only one level when listening through headphones.

To cancel
Press [DIGITAL S.WOOFER] (SC-EH760) or [S.WOOFER] (SC-EH560) to turn the indicator off.





Enjoying surround sound

The following chart gives a summary of this unit's surround features. It also shows additional features that can be used to enhance your enjoyment.

Note

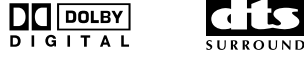
- All the features are only effective if speakers are used. No discernible effect will be heard through headphones.
- You may experience a reduction in sound quality when these surround systems and effects are used with some sources. If this occurs, either turn the surround system or effect off or reduce the level of the effect.

Changing sound field and quality

Surround system	Features	Software
<p>SC-EH760 6CH DISCRETE INPUT (→ page 24)</p>	<ul style="list-style-type: none"> • Use this input selector to enjoy 5.1 channel sources (e.g. Dolby Digital or DTS) played on a DVD player with 5.1 channel output and a built in Dolby Digital/DTS decoder (→ page 38 for connection, page 24 for operation). • Connect a subwoofer (not included) to the SUBWOOFER OUT terminal to enhance the surround effect (→ page 24 for operation). 	<p>DVDs encoded with Dolby Digital or DTS can be identified with these marks.</p>  <p>See the manual for the equipment you have connected for details on the types of software you can use.</p>
<p>SC-EH760 DOLBY PRO LOGIC (→ page 25)</p>	<ul style="list-style-type: none"> • Dolby Pro Logic is a decoding system that was developed to get a better sense of presence from sources encoded with Dolby Surround. The feeling of position has been improved by the addition of a separate center speaker channel. • This unit has built-in Dolby Pro Logic circuitry so you can enjoy Dolby Surround by connecting the speakers. • If your DVD player only has 2-channel output, you can still enjoy surround sound when playing 5.1 channel software by using Dolby Pro Logic. 	<p>Software encoded with Dolby Surround can be identified with this mark.</p>  <ul style="list-style-type: none"> • DVD • Laser Disc • Video tape • CD
<p>SC-EH560 VIRTUAL DOLBY SURROUND (→ page 26)</p> 	<p>This mode enables you to play sources recorded in Dolby Digital or Dolby Pro Logic through the two front speakers, but with a surround-like effect.</p>	<p>Software encoded with Dolby Digital or Dolby Surround can be identified with these marks.</p>  <ul style="list-style-type: none"> • DVD • Laser Disc • Video tape • CD
<p>SC-EH760 SUPER SURROUND (→ page 26)</p> <p>MOVIE</p> <p>MUSIC</p>	<ul style="list-style-type: none"> • This mode adds surround effects to movie software that hasn't been recorded with the above systems. • In MOVIE mode you can adjust the volume of the surround speakers to get the best surround effect. <p>This mode adds surround effects to stereo sources.</p>	<p>Any stereo sound source except for the radio.</p> <ul style="list-style-type: none"> • Video tape • CD • Tape
<p>SIMULATED STEREO (→ page 26)</p>	<p>This mode adds stereo-like effects to monaural sources.</p>	<p>Any monaural sound source except for the radio.</p> <ul style="list-style-type: none"> • Video tape • CD • Tape

Amplifier modes

SC-EH760

When using the above surround systems (except for SIMULATED STEREO), the amplifier is automatically switched to the surround mode.

In all other cases, the TRI-AMP mode (stereo) is engaged. In this mode, three separate amplifiers are used to drive the three sections (LOW, MID, and HIGH) of the two front speakers.

SC-EH560

The TRI-AMP mode is active at all times.

(Tuner amplifier)

Surround mode

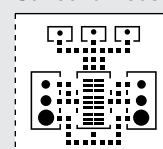

TRI-AMP mode (stereo)

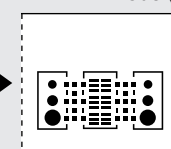

Additional effects

- (A) Center focus
- (B) Virtual rear surround
- (C) Multi rear surround
- (D) 3D enhanced surround
- (G) Seat position

- (A) Center focus
- (B) Virtual rear surround
- (C) Multi rear surround
- (D) 3D enhanced surround
- (G) Seat position

- (E) Center effect
- (F) Surround effect
- (G) Seat position

- (B) Virtual rear surround
- (C) Multi rear surround
- (D) 3D enhanced surround
- (G) Seat position

When you select a surround effect, the indicators corresponding to the effects you can use with that surround effect light orange.

"DTS" and "DTS Digital Surround" are trademarks of Digital Theater Systems, Inc.

Manufactured under license from Dolby Laboratories Licensing Corporation. DOLBY, the double-D symbol  and "PRO LOGIC" are trademarks of Dolby Laboratories Licensing Corporation.

SC-EH760

(A) Center focus (⇒ page 27)

- This mode makes it seem like the sound from the center speaker is coming from within the television.
- You can select one of two levels.
- The center speaker should be placed on top of the television.

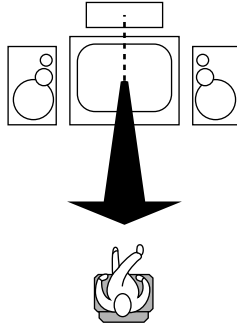

SC-EH760

(B) Virtual rear surround (⇒ page 27)

- This mode is useful if you have to place your surround speakers near the front speakers due to the layout of your room.
- This mode makes it seem like the sound from the surround speakers is coming from behind you.

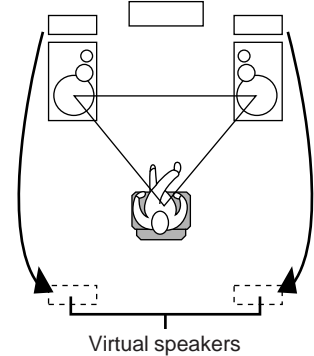

SC-EH760

(C) Multi rear surround (⇒ page 27)

- This mode makes it seem like there are multiple surround speakers in your room, increasing the cinema-like atmosphere.

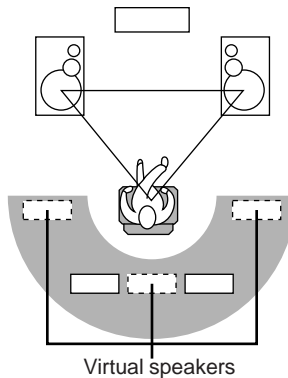

SC-EH760

(D) 3D enhanced surround (⇒ page 27)

- This mode adds width to the sound from the surround and front speakers.

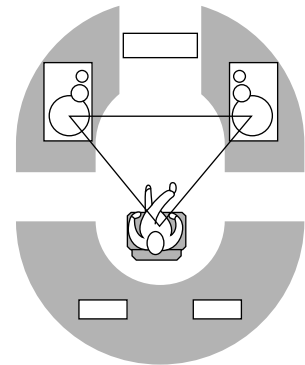

SC-EH560

(E) Center effect (⇒ page 28)

(F) Surround effect (⇒ page 28)

- When you are using Virtual Dolby Surround, you can adjust the sound that is directed to the virtual center and surround speakers in three levels.

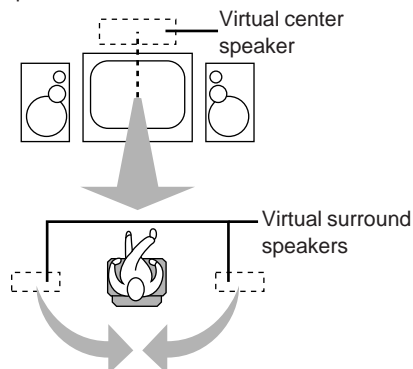

(G) Seat position (⇒ page 29)

- This mode helps maintain the sound position even if the listening position itself is changed.

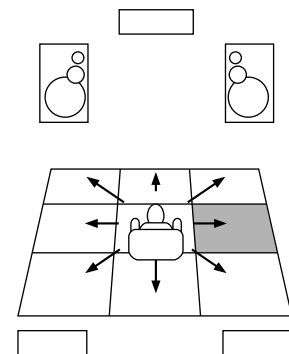

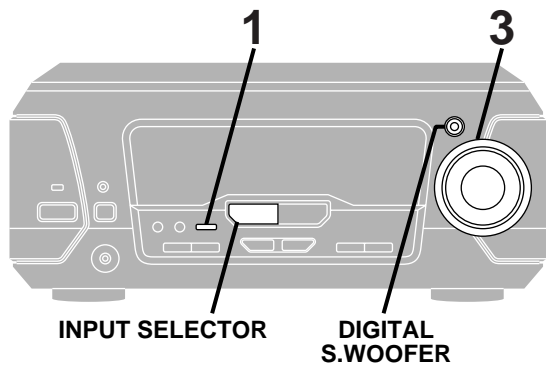
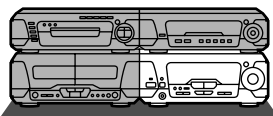

Enjoying surround sound

6CH DISCRETE INPUT SC-EH760

Preparation:

Connect a DVD player with a built in Dolby Digital or DTS decoder (→ page 38).

- 1** Press [6CH DISCRETE INPUT].
- 2** Playback a Dolby Digital or DTS source on the DVD player.
- 3** Adjust the volume.

To cancel

Press [INPUT SELECTOR] to select another source.

If you have connected a subwoofer

Press and hold [DIGITAL S.WOOFER] until "SUB W ON" is displayed.

A Speaker level adjustments

If the level of the speakers appears to be different while listening to a source, adjust the level of the speakers to the same apparent level.

While playing a Dolby Digital or DTS source

- ① Press [CH SELECT] to select the speaker to adjust.

Each time you press the button:

- Lch: Front left speaker
- Cch: Center speaker
- Rch: Front right speaker
- RSch: Right surround speaker
- LSch: Left surround speaker
- SWch: Subwoofer (only when connected)

- ② Press [▲] (to increase level) or [▼] (to decrease level).

Repeat steps ① and ② to adjust the level accordingly.

- If your DVD player is able to output a test signal, you can use it instead of playing a source.

Note

You cannot record or enjoy karaoke (for Australia and N.Z. only) when you are using 6CH DISCRETE INPUT. To record or enjoy karaoke with DVDs, ensure the DVD player is also connected to the AUX (DVD) IN terminals and select "AUX (DVD)" with [INPUT SELECTOR] (→ page 39).

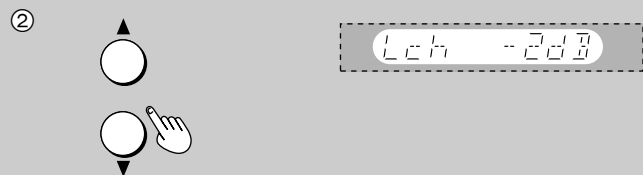
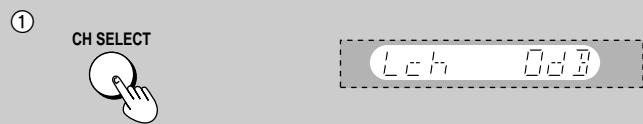
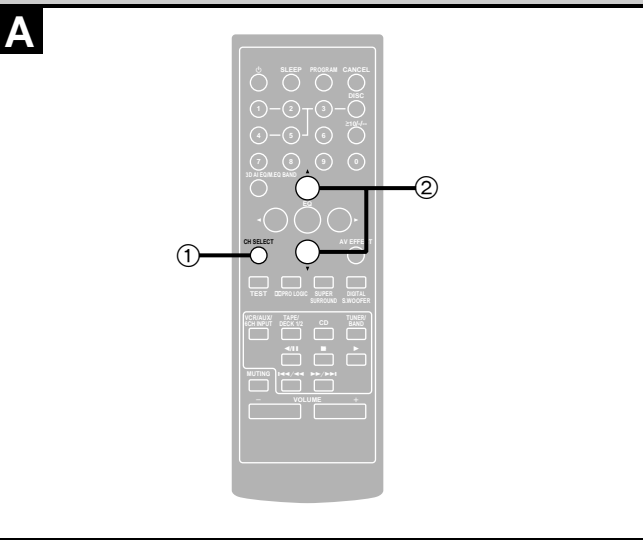
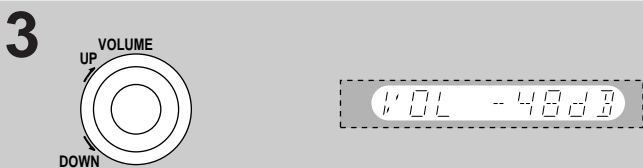

DOLBY PRO LOGIC SC-EH760

1 Press [DOLBY PRO LOGIC, OFF/ON].
The indicator turns green.

2 Playback a Dolby Surround source.

To cancel

Press [DOLBY PRO LOGIC, OFF/ON] so the indicator goes out.

A Speaker level adjustments

If the level of the speakers appears to be different while listening to a source, adjust the level of the speakers to the same apparent level.

① Press [TEST] to output a test signal.

The speaker outputting the test signal is displayed.

Lch: Front left speaker

Cch: Center speaker

Rch: Front right speaker

Sch: Surround speakers

② Press [VOLUME (- or +)] to set the volume level of the front speakers normally used for enjoying the source.

③ Press [▲] (to increase level) or [▼] (to decrease level) for center and surround speakers.

To stop the test signal, press [TEST] again.

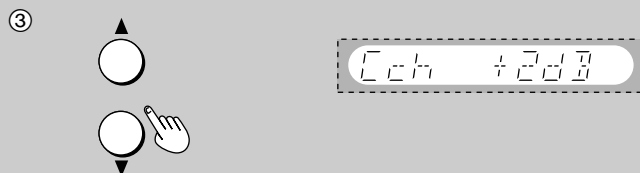
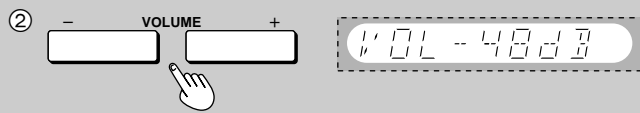
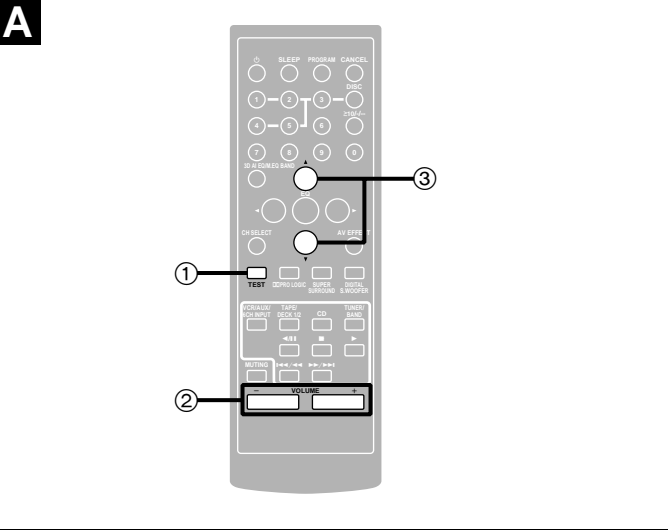
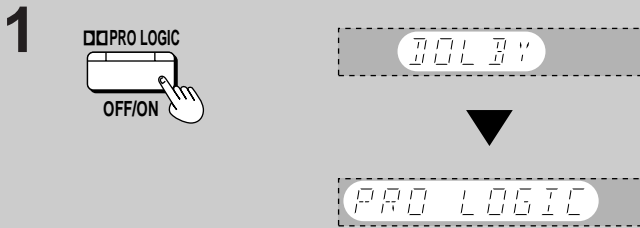
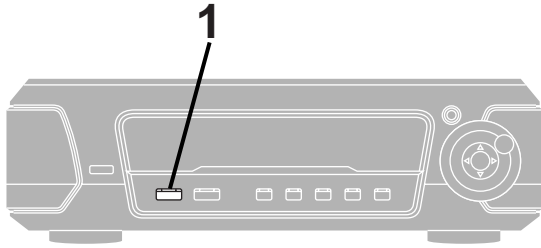
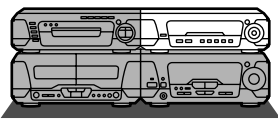

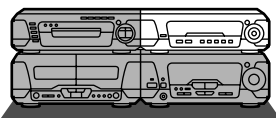

SC-EH760

SUPER SURROUND

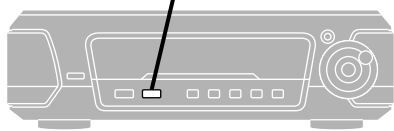

SC-EH560

VIRTUAL DOLBY SURROUND

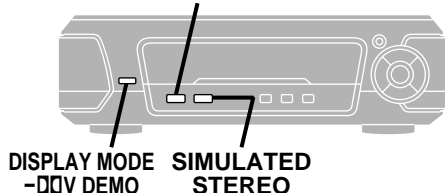

A

VIRTUAL DOLBY SURROUND



(On the tuner amplifier)

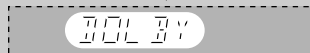

(On the sound processor)

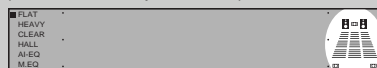

B

SUPER SURROUND

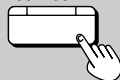

(On the tuner amplifier)

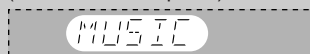

C

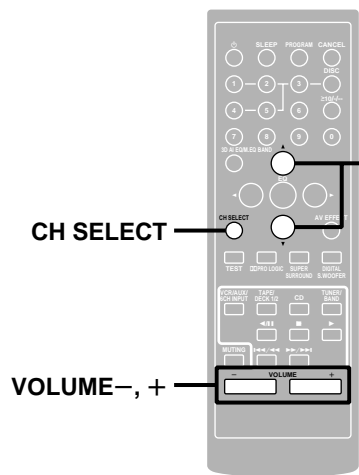

D

SC-EH760

SUPER SURROUND



SC-EH560

SIMULATED STEREO

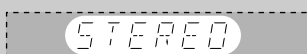

Enjoying surround sound

VIRTUAL DOLBY SURROUND

A

SC-EH560

Press **[VIRTUAL DOLBY SURROUND]**.

The indicator turns green.

To cancel

Press **[VIRTUAL DOLBY SURROUND]** so the indicator goes out.

Virtual speaker level adjustments

You can adjust the level (1, 2 or 3) of the virtual center and surround speakers (only when CENTER EFFECT or SURROUND EFFECT is on) (→ page 28).

① Press and hold **[DISPLAY MODE, -DOLBY DEMO]** to output a demo signal.

The speaker outputting the demo signal is displayed.

Lch: Front left speaker

Cch: Center speaker (virtual)

Rch: Front right speaker

Sch: Surround speakers (virtual)

② Set the volume level of the front speakers normally used for enjoying the source. **[C]**

③ Press **[▲]** (to increase level) or **[▼]** (to decrease level) for center and surround speakers. **[C]**

To stop the demo signal, press and hold **[DISPLAY MODE, -DOLBY DEMO]** again.

B

SUPER SURROUND SC-EH760

Press **[SUPER SURROUND]** and select **“MOVIE”** or **“MUSIC”**.

The indicator turns green.

Each time you press the button:

MUSIC → MOVIE → SIMULATED STEREO

↑ STEREO SOUND (off) ↓

To cancel

Press **[SUPER SURROUND]** to select “STEREO SOUND”. The indicator goes out.

C Surround speaker level adjustments

While playing a source

① Press **[CH SELECT]**.

② Press **[▲]** (to increase level) or **[▼]** (to decrease level).

D

SIMULATED STEREO

SC-EH760

Press **[SUPER SURROUND]** and select **“SIMULATED STEREO”**.

Each time you press the button:

MUSIC → MOVIE → SIMULATED STEREO

↑ STEREO SOUND (off) ↓

SC-EH560

Press **[SIMULATED STEREO]**.

The indicator turns green.

To cancel

SC-EH760

Press **[SUPER SURROUND]** to select “STEREO SOUND”. The indicator goes out.

SC-EH560

Press **[SIMULATED STEREO]** so the indicator goes out.

These effects are available when the corresponding indicators are alight.

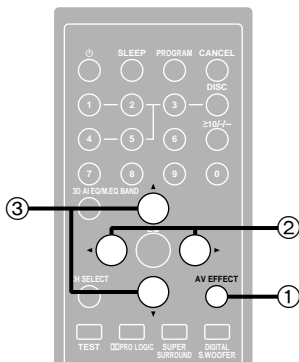
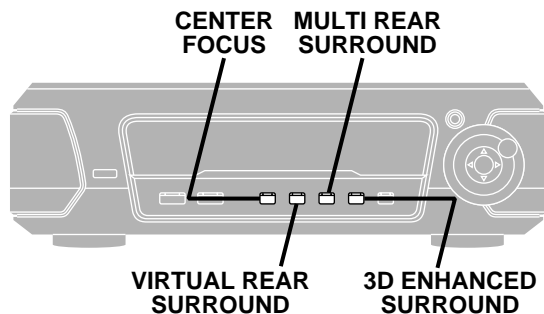
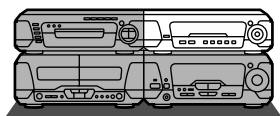

A CENTER FOCUS

Press [CENTER FOCUS].

The indicator turns green.
Each time you press the button:
CENTER FOCUS1 → CENTER FOCUS2 → (off)

To cancel

Press [CENTER FOCUS] so the indicator turns orange.

On the remote control

- 1 Press [AV EFFECT].
- 2 Press [◀] or [▶] so the "CENTER FOCUS" indicator flashes.
- 3 Press [▲] (to turn on or increase level) or [▼] (to decrease level or turn off).
(The indicator turns orange when off.)

B VIRTUAL REAR SURROUND

Press [VIRTUAL REAR SURROUND].

The indicator turns green.

To cancel

Press [VIRTUAL REAR SURROUND] so the indicator turns orange.

On the remote control

- 1 Press [AV EFFECT].
- 2 Press [◀] or [▶] so the "VIRTUAL REAR SURROUND" indicator flashes.
- 3 Press [▲] (ON) or [▼] (OFF).
(The indicator turns orange when off.)

C MULTI REAR SURROUND

Press [MULTI REAR SURROUND].

The indicator turns green.

To cancel

Press [MULTI REAR SURROUND] so the indicator turns orange.

On the remote control

- 1 Press [AV EFFECT].
- 2 Press [◀] or [▶] so the "MULTI REAR SURROUND" indicator flashes.
- 3 Press [▲] (ON) or [▼] (OFF).
(The indicator turns orange when off.)

D 3D ENHANCED SURROUND

Press [3D ENHANCED SURROUND].

The indicator turns green.

To cancel

Press [3D ENHANCED SURROUND] so the indicator turns orange.

On the remote control

- 1 Press [AV EFFECT].
- 2 Press [◀] or [▶] so the "3D ENHANCED SURROUND" indicator flashes.
- 3 Press [▲] (ON) or [▼] (OFF).
(The indicator turns orange when off.)

A (On the tuner amplifier)

(On the sound processor)

B (On the tuner amplifier)

(On the sound processor)

C (On the tuner amplifier)

(On the sound processor)

D (On the tuner amplifier)

(On the sound processor)

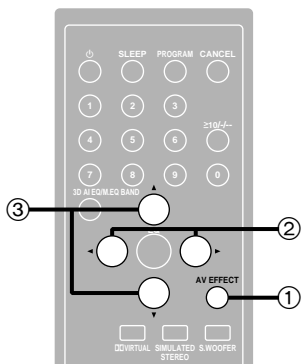
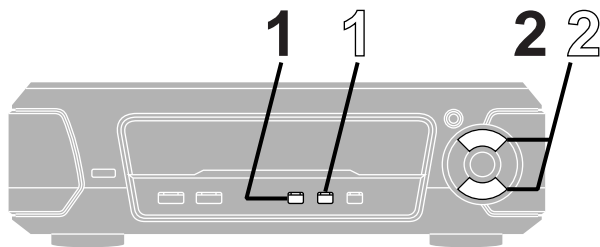
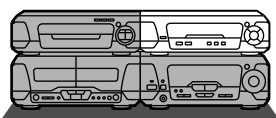

A

1

CENTER EFFECT



2

MULTI CONTROL

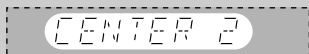
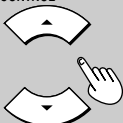

B

1

SURROUND EFFECT



2

MULTI CONTROL

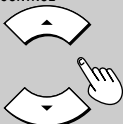

Surround effects SC-EH560

These effects are available when the corresponding indicators are alight.

A CENTER EFFECT

1 Press [CENTER EFFECT].

The indicator flashes green.

2 While the indicator is flashing (within 10 seconds) Press [▲] (to increase level) or [▼] (to decrease level).

There are three levels.

To cancel

- ① Press [CENTER EFFECT] so the indicator flashes green.
- ② Press [CENTER EFFECT] again while the indicator is flashing so it turns orange.

On the remote control

- ① Press [AV EFFECT].
- ② Press [◀] or [▶] so the "CENTER EFFECT" indicator flashes.
- ③ Press [▲] (to turn on or increase level) or [▼] (to decrease level). To turn it off, after steps ① and ② press [▼] so the indicator turns orange.

B SURROUND EFFECT

1 Press [SURROUND EFFECT].

The indicator flashes green.

2 While the indicator is flashing (within 10 seconds) Press [▲] (to increase level) or [▼] (to decrease level).

There are three levels.

To cancel

- ① Press [SURROUND EFFECT] so the indicator flashes green.
- ② Press [SURROUND EFFECT] again while the indicator is flashing so it turns orange.

On the remote control

- ① Press [AV EFFECT].
- ② Press [◀] or [▶] so the "SURROUND EFFECT" indicator flashes.
- ③ Press [▲] (to turn on or increase level) or [▼] (to decrease level). To turn it off, after steps ① and ② press [▼] so the indicator turns orange.

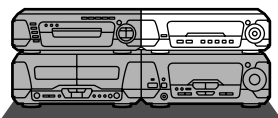

SC-EH760

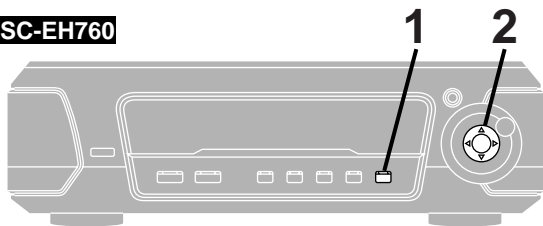

SC-EH560

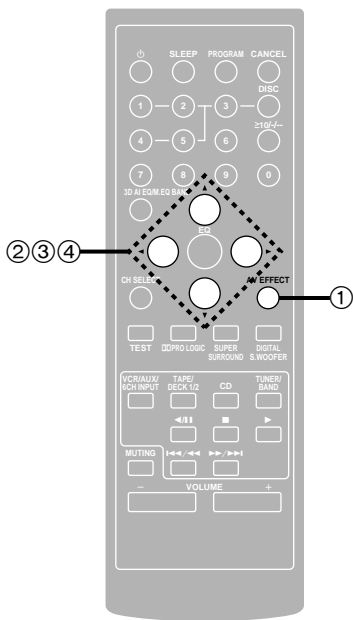
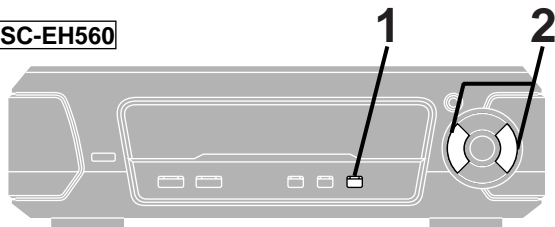

Surround effects

SEAT POSITION

- 1** Press [SEAT POSITION].
The indicator flashes green.
- 2** While the indicator is flashing (within 10 seconds) Adjust the seat position.

To cancel

- ① Press [SEAT POSITION] so the indicator flashes.
- ② Press [SEAT POSITION] again while the indicator is flashing so it turns orange.

On the remote control

- ① Press [AV EFFECT].
- ② Press [◀] or [▶] so the "SEAT POSITION" indicator flashes.
- ③ Press [▲] (ON).
- ④ Adjust the seat position with [◀, ▶, ▲, ▼] (SC-EH760) or [◀, ▶] (SC-EH560).

To turn it off, after steps ① and ② press [▼] so the indicator turns orange.

SC-EH760

With virtual rear surround or 3D enhanced surround
3 horizontal steps

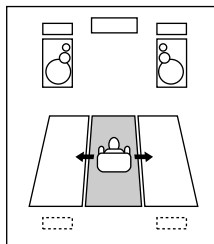

SC-EH560

5 horizontal steps

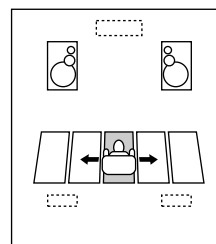

Changing sound field and quality

1



(On the tuner amplifier)

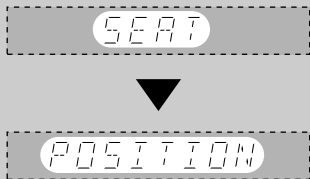

2

SC-EH760

SC-EH560

(On the sound processor)

SC-EH760

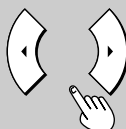
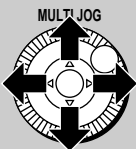

SC-EH560



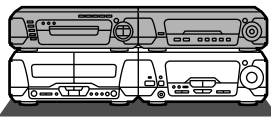

A

**COUNTER
RESET DISPLAY**

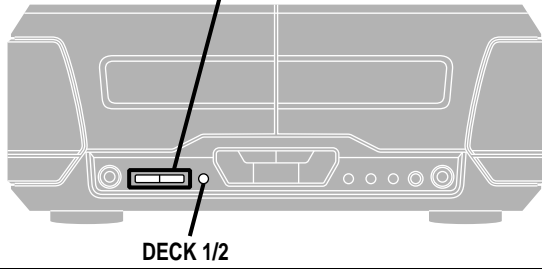

COUNTER



COUNTER



B

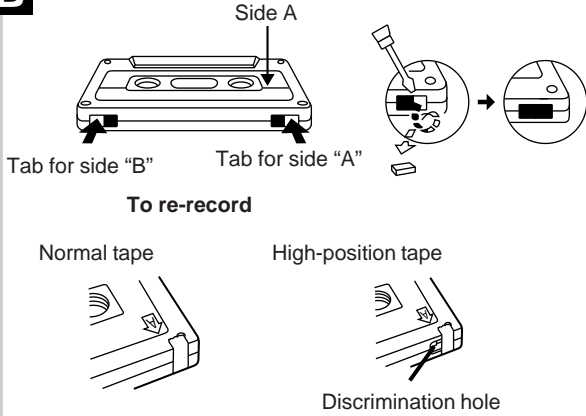

To re-record

Normal tape

High-position tape

Discrimination hole

C

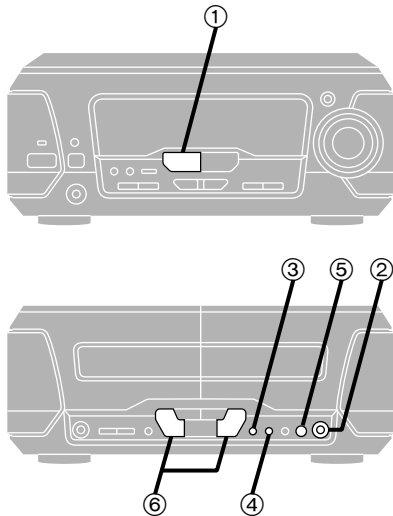

Before recording (Deck 2 only)

Note

SC-EH760

You cannot record when [6CH DISCRETE INPUT] is selected. ("ERROR" appears.)

Selection of tapes for recording

The unit automatically identifies the type of tape.

Normal position/TYPE I	✓
High position/ TYPE II	✓
Metal position/ TYPE IV	✓

A To display the tape counter while recording

Press [COUNTER DISPLAY].

The counter is displayed for about 5 seconds.

To reset the tape counter

Press [COUNTER RESET].

- To display or reset the tape counter for deck 1, first press [DECK 1/2].

B Erasure prevention

The illustration shows how to remove the tabs to prevent recording. To record on the tape again, cover as shown, being careful not to cover the high position discrimination hole.

Volume, sound quality and surround effects

These have no effect on recording. Sound quality and surround effects are automatically set to flat when recording.

C Erasing recordings

- ① Press [INPUT SELECTOR] to select "TAPE".
- ② Insert the recorded tape into deck 2.
- ③ Press [DOLBY NR] so the "DOLBY NR" indicator goes out.
- ④ Select the reverse mode.
- ⑤ Press [● REC PAUSE].
- ⑥ Press [<] or [>].

Your attention is drawn to the fact that recording pre-recorded tapes or discs or other published or broadcast material may infringe copyright laws.

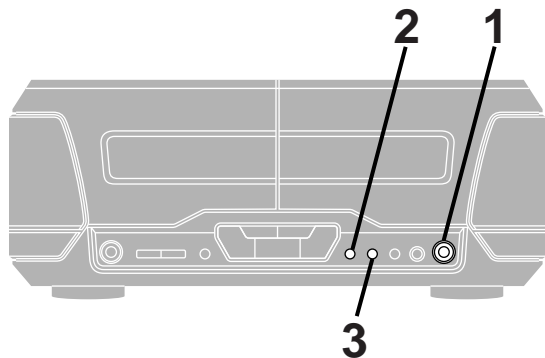
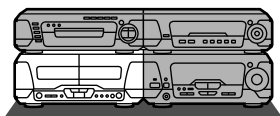

Preparatory steps

Do these steps before each recording.

Wind up the leader tape in deck 2 so recording can begin immediately.

1 Press [**▲ OPEN**] on deck 2 and insert the cassette.

Insert the cassettes on both decks for tape-to-tape recording (→ page 33).

DECK 1: For playback

DECK 2: For recording

2 Press [**DOLBY NR**] to select Dolby NR on (“**DNR**” appears) or off.

(→ “Dolby noise reduction” page 19)

3 Press [**REV MODE**] to select the reverse mode.

Each time you press the button:

←→: One side only records.

↔ and ↔: Both sides record (forward→ reverse).

“↔” automatically changes to “↔” when [● REC PAUSE], [EDIT] or [TAPE EDIT] is pressed.

1



Forward side
Tape facing down

2

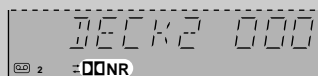

3

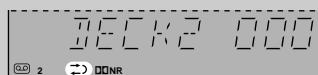

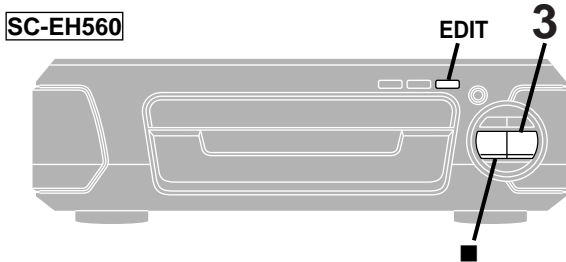
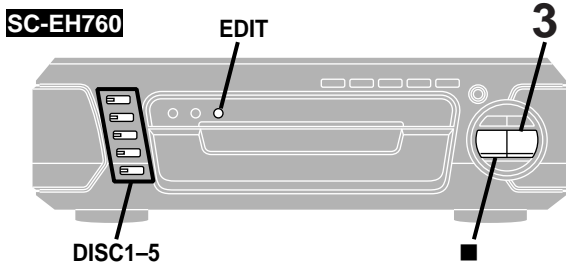
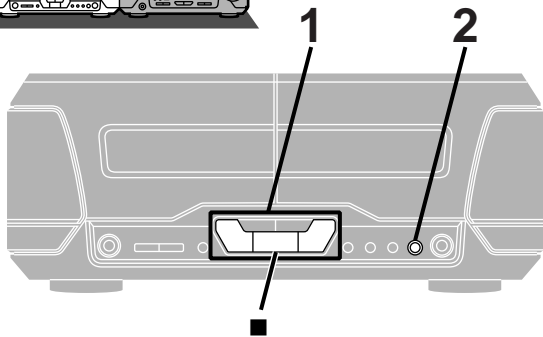
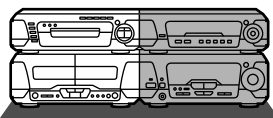
**A**

1

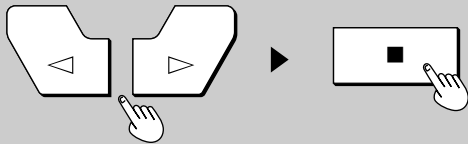

2

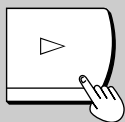

3

**B**

SC-EH760

SC-EH560

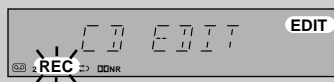
**Recording CDs****Preparation:**

- Do the preparatory steps (⇒ page 31).
- Insert the CD(s) you want to record (⇒ page 12).
- **SC-EH760**
Press [DISC 1]–[DISC 5] on the CD changer to select the disc where you want to start recording, then press [■] to stop the disc.

A Normal recording

- 1 Press [◀] (reverse side) or [▶] (forward side) then [■] to set the tape direction.**
- 2 Press [● REC PAUSE].**
The deck goes into the recording standby mode and the indicator "◀" or "▶" starts flashing.
- 3 Press [▶] on the CD changer or CD player.**
Recording starts automatically.

4 seconds after the CD(s) finishes, the deck goes into the recording standby mode.

To stop recording EITHER

Press [■] on the CD changer or CD player.
The deck goes into the recording standby mode 4 seconds later.

OR

Press [■] on the deck.
Recording stops immediately but the CD continues to play.

To record programmed tracks

Program tracks before step 1 (⇒ page 14).

B One touch CD editing

This function makes it easier for you to record from discs.

- When recording, if a track is cut off in the middle at the end of the front side, it is recorded from the beginning on the reverse side.
- At the end of the reverse side recording stops and the current track will be interrupted.

After pressing [◀] or [▶] then [■] on the cassette deck to set the tape direction,

Press [EDIT].

Recording starts. In the meantime, "CD EDIT" will scroll across the display from right to left.

After edit-recording has finished

The cassette deck automatically stops.

To stop editing

Press [■] on the CD changer or CD player. The cassette deck also stops.

"EDIT OUT" is displayed.

To edit programmed tracks

Program the tracks (⇒ page 14) and press [EDIT].

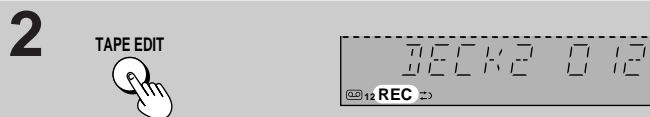
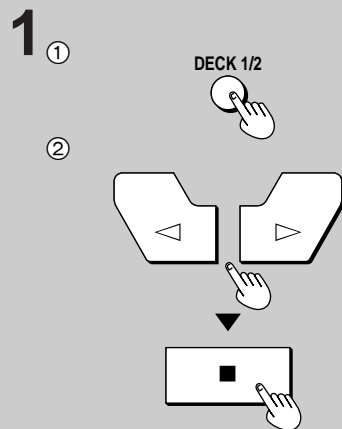
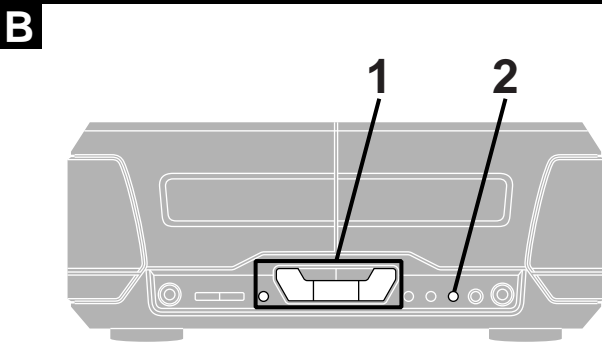
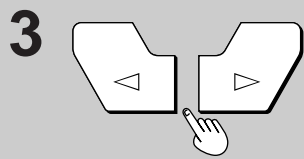
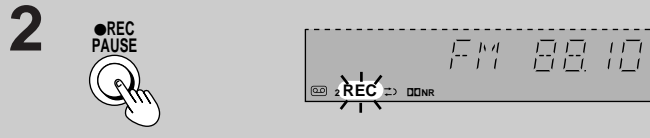
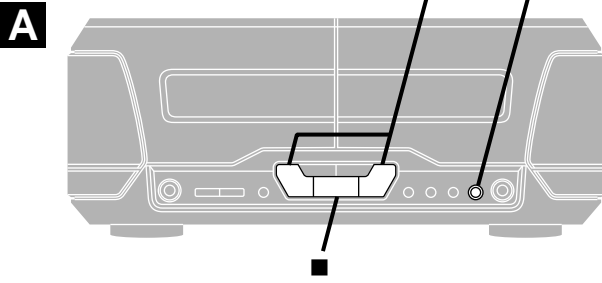
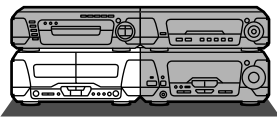

A Recording the radio

Preparation: Do the preparatory steps (⇒ page 31).

- 1 Tune to the required station.**
(⇒ page 16 or 17)
- 2 Press [● REC PAUSE].**
The deck goes into the recording standby mode and the play indicator “<” or “>” starts flashing.
- 3 Press [<] (reverse side) or [>] (forward side) to start recording.**

To stop recording

Press [■].

To temporarily stop recording

Press [● REC PAUSE].

The deck goes into recording standby mode.

To resume recording press [<] or [>] with the flashing indicator.

B Tape-to-tape recording

Preparation: Do the preparatory steps 1 and 3 (⇒ page 31).

- 1 Set the tape direction on both decks.**
 - ① Press [DECK 1/2] to select “DECK 2”.
 - ② First press [<] or [>], and then [■].

Repeat steps ① and ② for deck 1.
- 2 Press [TAPE EDIT] to start recording.**
The indicator “<” or “>” shows deck 2 direction.
If either deck 1 or deck 2 stops, the other deck also stops.

To stop recording

Press [■].

Both decks will stop.

To enjoy another source while recording

Start playing the other sound source.

You can change the volume level and tone quality without affecting the recording.

Note

The recording level and the noise reduction effect of the original (playback) tape will be recorded on the new tape.

Using the timers

The play timer

This timer starts play of the selected source at the selected time. The example shows settings for preset radio channel 8 to play between 6:30 and 7:40 at -40 dB.

Preparation: Turn the unit on, set the time (➔ page 11), preset radio stations if you want the timer to start playing the radio (➔ page 17).

1 ① Press [CLOCK/TIMER, -DEMO] to select "⌚PLAY."

Each time you press the button:
CLOCK→⌚PLAY→⌚REC→Original display

② Press [SET] within 3 seconds.

2-5

① Press [TUNING (∨ or ∧)] to select the condition required and

② press [SET].

2 Select the start time.

3 Select the finish time.

4 Select the source.

TUNER↔CD↔TAPE

Insert a CD or tape if you select these sources.

If you select TUNER

Select a preset channel.

5 Select the volume.

The play timer is now on standby. The display shows each condition again then restores the original display.

6 Press [⏻/⏻] to turn the unit off.

"⌚PLAY/⌚REC" indicator remains illuminated to show the play (or record) timer is on even when ECO mode is selected (➔ page 11).

The timer starts at the set time with the volume increasing gradually to the set level.

To cancel the timer

Press [⌚PLAY/⌚REC] so "⌚PLAY" goes out.

Each time you press the button:

⌚PLAY→⌚REC→⌚PLAY ⌚REC→Light off (OFF)

The play timer function will be canceled, but the settings stay in the memory.

For your reference:

When you insert cassettes in decks 1 and 2, deck 1 has priority.

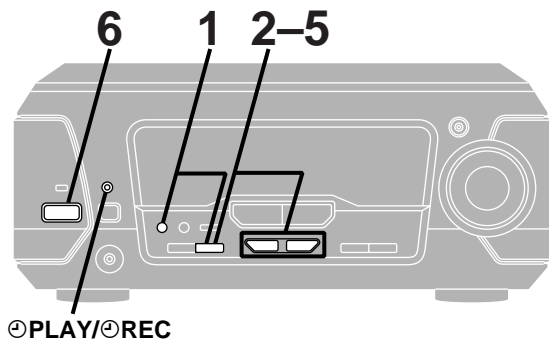
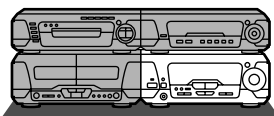

⌚PLAY/⌚REC

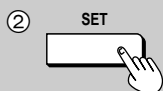

2-5

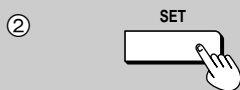
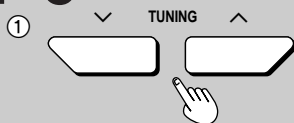

The record timer

This timer records the radio at the set time.

The example shows settings for recording preset channel 8 from 18:30 to 19:30.

Preparation: Turn the unit on, set the time (➔ page 11), preset radio stations (➔ page 17).

1 ① Press [CLOCK/TIMER, -DEMO] to select “ⓈREC”.

Each time you press the button:
CLOCK→ⓈPLAY→ⓈREC→Original display

② Press [SET] within 3 seconds.

2-4

① Press [TUNING (∨ or ∧)] to select the condition required and

② press [SET].

2 Select the start time.

3 Select the finish time.

4 Select the preset channel.

The record timer is now on standby. The display shows each condition again then restores the original display.

5 Prepare for recording.

- ① Insert a tape into deck 2.
- ② Select the Dolby NR mode.
- ③ Select the reverse mode.
- ④ Select the tape direction.

6 Press [Ⓢ/I] to turn the unit off.

“ⓈPLAY/ⓈREC” indicator remains illuminated to show the record (or play) timer is on even when ECO mode is selected (➔ page 11).

Recording starts 30 seconds before the set time with the volume muted during the set time.

To cancel the timer

Press [ⓈPLAY/ⓈREC] so “ⓈREC” goes out.

Each time you press the button:

ⓈPLAY→ⓈREC→ⓈPLAY ⓈREC→Light off (OFF)

The record timer function will be canceled, but the settings stay in the memory.

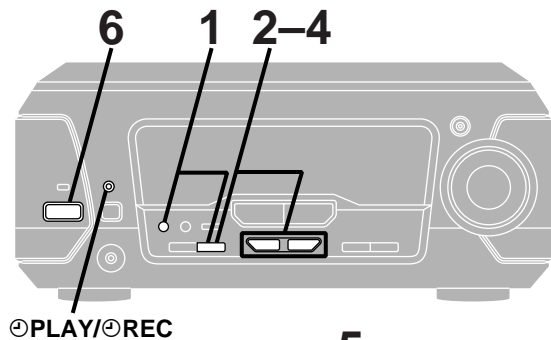
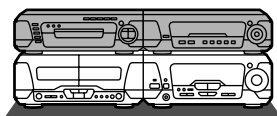

ⓈPLAY/ⓈREC

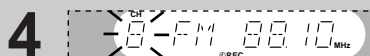
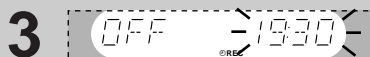
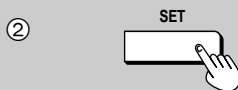
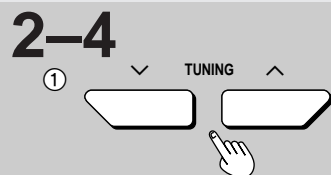
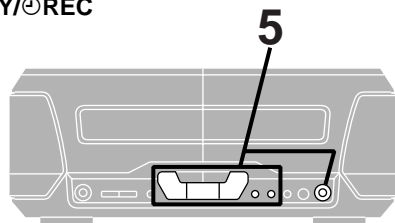

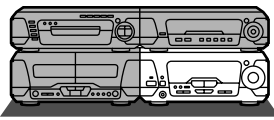

A

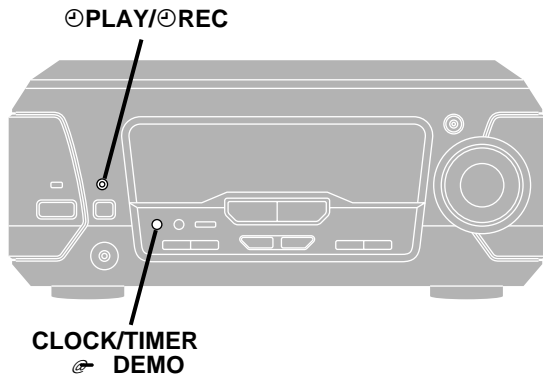

B

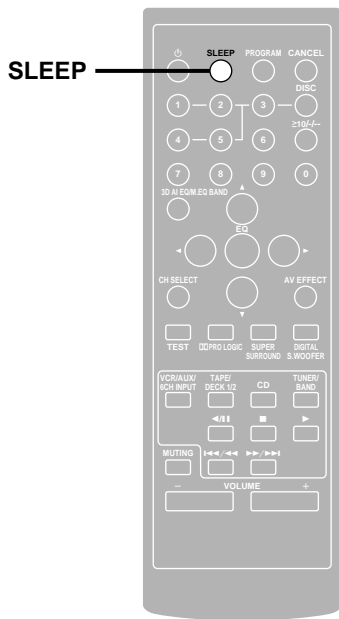

SLEEP



Using the timers

A The play and record timers

Checking the timers

Press [CLOCK/TIMER, -DEMO] to select “⊖PLAY” (or “⊖REC”).

The timer conditions are shown in the following order:

Play timer:

Start time→Finish time→Source→Volume

Record timer:

Start time→Finish time→Broadcast station you select

The timers can be checked even if the unit is off.

Playing the unit after the timers are set

The unit can be used after the timers are set. Make sure the unit is off before the set start time.

Turning the timers on and off

The timers come on at the set times if “⊖PLAY/⊖REC” indicator is illuminated. They can be turned on and off by pressing [⊖PLAY/⊖REC] (➡ pages 34 and 35).

Note

- If you turn the unit off and on again while a timer is functioning, the finish time setting will not be activated.
- If the power is on, the timer will not function. The system must be in the standby mode.
- This system retains the ON/OFF time settings until you make a new setting. If you make a new ON time setting, you must make a new OFF time setting.

B The sleep timer

Remote control only

This timer turns the unit off after a set time.

While playing a source

Press [SLEEP] to select the time (minutes).

Each time you press the button:

SLEEP 30 → SLEEP 60 → SLEEP 90
 ↑ SLEEP OFF ← SLEEP 120 ←

To cancel the sleep timer

Press [SLEEP] to select “SLEEP OFF”.
 “SLEEP” goes out.

To confirm the remaining time

(While the timer is functioning)

Press [SLEEP].

The remaining time is shown for about 5 seconds.

To change the setting

Press [SLEEP] to display the remaining time, then press again to select the required time.

Using the timers together

Any of the timers can be used together, but ensure the unit is off before the start time for the record and play timers.

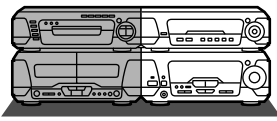

A Changing the sound range display

The sound processor shows the level of each sound range with the three types of display described below.

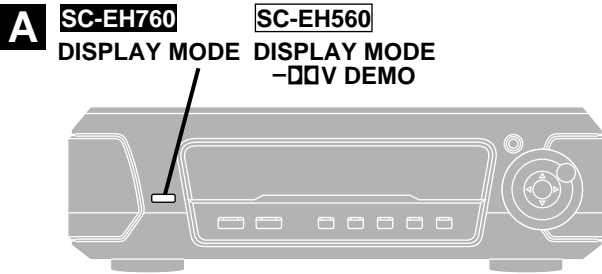

SC-EH760
Press [DISPLAY MODE].

SC-EH560
Press [DISPLAY MODE, -DDV DEMO].

The spectrum display will change as follows.

- a Normal display**
This display indicates the strength of the sound in each tonal range.
- b Peak-hold display**
The peak sound value of each sound range is held on the display for about one second after it occurs.
- c Aurora display**
The peak sound value of each sound range is displayed in inverted form.

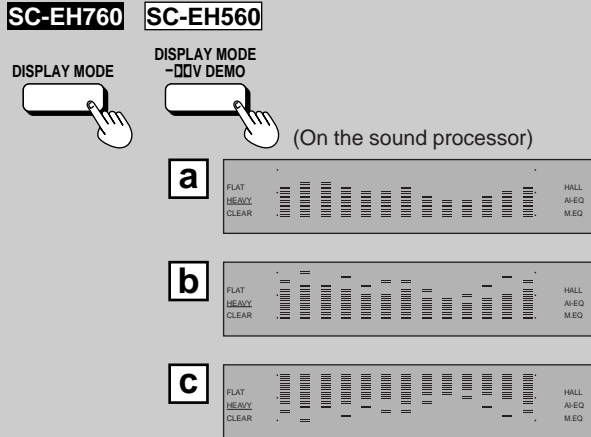

B Muting the volume

Remote control only

Press [MUTING].

Volume is reduced to minimum.

To cancel

Press [MUTING] again.

"MUTING" goes out and the volume is restored.

To cancel from the tuner amplifier, turn [VOLUME] to minimum (— dB), then raise it to the required level.

Muting is also canceled when the unit is turned off.

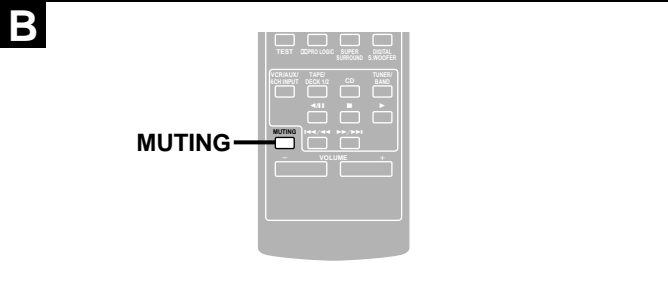

(On the tuner amplifier)

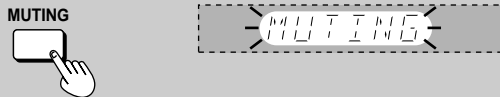

C Using headphones (not included)

Reduce the volume before connection.

Avoid listening for prolonged periods of time to prevent hearing damage.

Plug type: 3.5 mm stereo

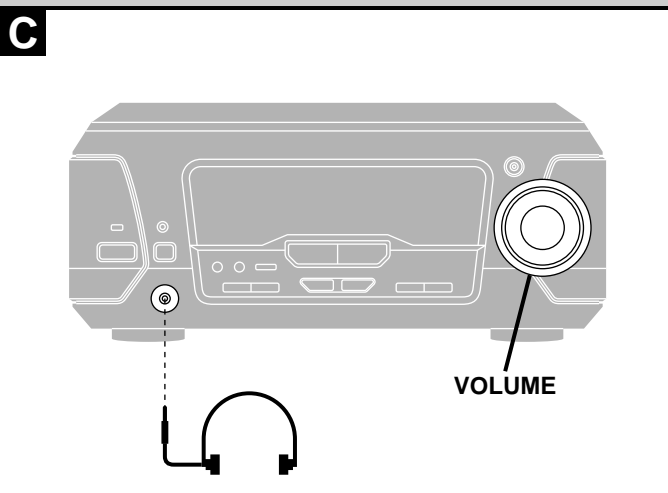

External unit connections

- Turn off all units before making connections.
- Refer to the manual of the other unit for details.
(Cables and equipment not included.)

Stereo phono cable (not included)

White (L) 
Red (R) 

Video connection cable (not included)



Connections to SC-EH760

A DVD player with 5.1ch output

This unit has the input terminals for 5.1ch surround systems but it does not have the decoders necessary to play them back. The DVD player should have these decoders and 5.1ch output.

To record sound from the DVD player

Connect to AUX (DVD).

Subwoofer

The included front speakers have subwoofers, but you can enhance surround sound from a unit connected to DVD 6ch INPUT by connecting another subwoofer to SUBWOOFER OUT (⇒ page 24 for operation).

B DVD player/Laser disc player (without 5.1ch output), etc.

This unit has Dolby Pro Logic circuitry. The sound will be reproduced with the same powerful stereophonic effects found in movie theaters.

C Video cassette recorder

You can enjoy the sound from your video cassette recorder.

D Television set (For Australia and N.Z. only)

By connecting the video connection cable as shown in the illustration, it is possible to switch both audio and video input with [INPUT SELECTOR] of this unit.

Connections to SC-EH560

B DVD player/Laser disc player etc.

You can enjoy the sound from your DVD player/Laser disc player etc.

C Video cassette recorder

You can enjoy the sound from your video cassette recorder.

A DVD player with 5.1ch output

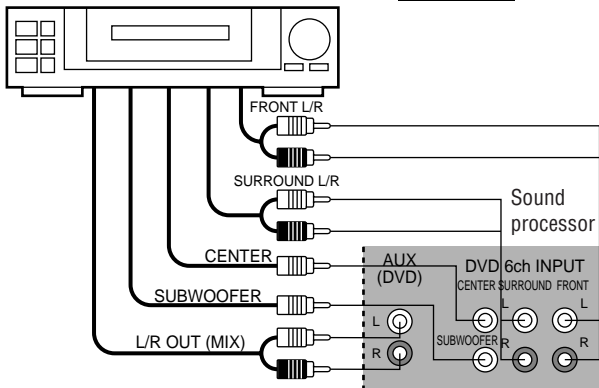

B DVD player/Laser disc player (without 5.1ch output), etc.

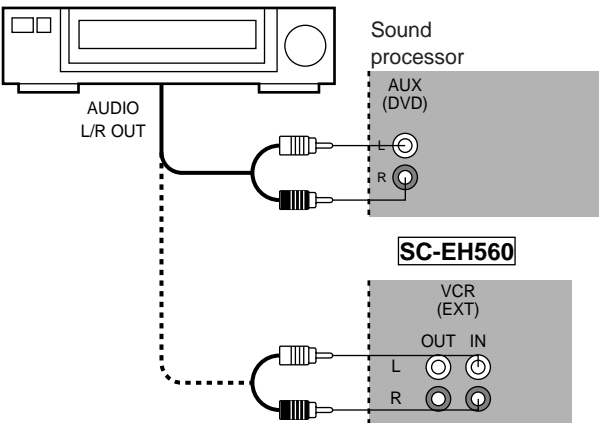

C Video cassette recorder

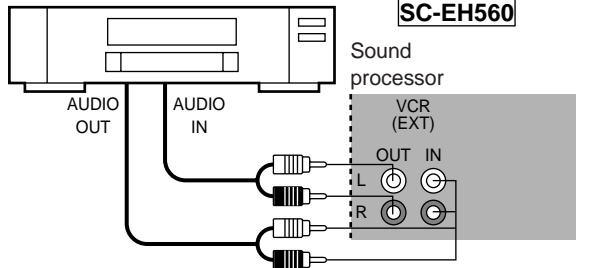

D Television set

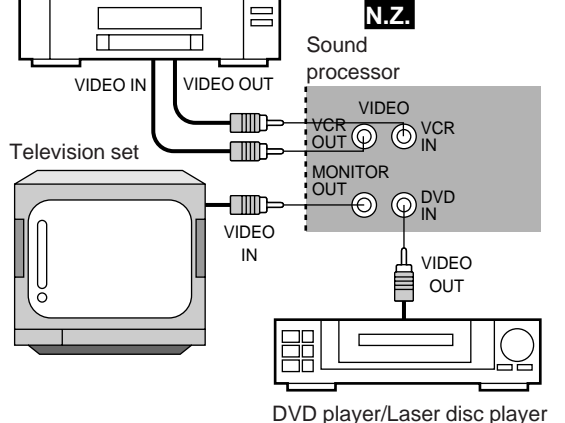

Using other equipment

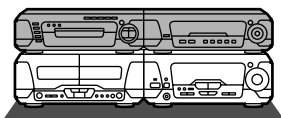

A

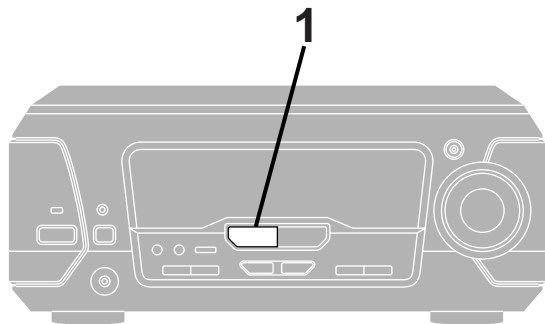

1

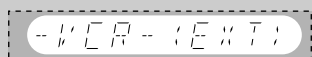
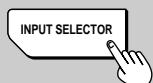

B

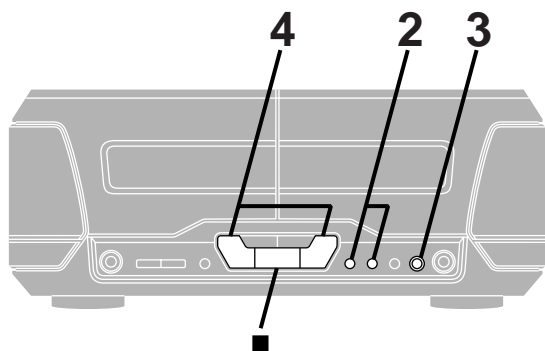
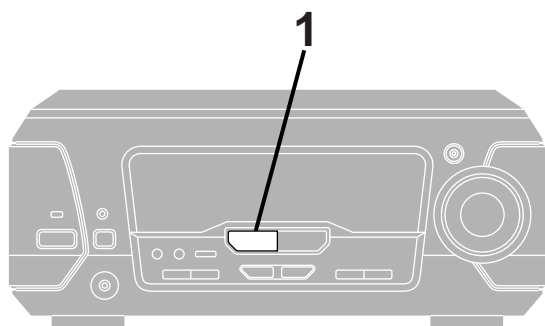

1

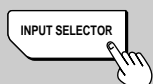

2

DOLBY NR



REV MODE



3

● REC PAUSE



4

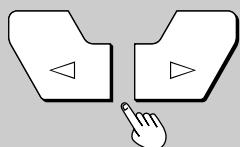

A Listening to an external source

1 Press [INPUT SELECTOR] to select the external source.

Each time you press the button:

SC-EH760

TUNER → CD → TAPE → VCR (EXT) → AUX (DVD)



SC-EH560

TUNER → CD → TAPE → VCR (EXT)



On the remote control

Press [VCR/AUX/6CH INPUT] (SC-EH760) or [VCR] (SC-EH560).

2 Operate the unit.

See the unit's manual for details on operation and connection.

To enjoy Dolby Digital and DTS

→ page 24

B Recording an external source

1 Press [INPUT SELECTOR] to select the external source.

2 Select Dolby NR and reverse mode.

(→ page 31)

3 Press [● REC PAUSE].

4 Press [◀] or [▶] to start recording.

5 Start the source to be recorded.

See the unit's manual for details on operation and connection.

To stop recording

Press [■] on the deck.

To temporarily stop recording

Press [● REC PAUSE].

The deck goes into the recording standby mode.

To resume recording press [◀] or [▶] with the flashing indicator.

Recording onto an external unit

Select the source to be recorded with [INPUT SELECTOR].

Start recording on the external unit and start playing the source to be recorded.

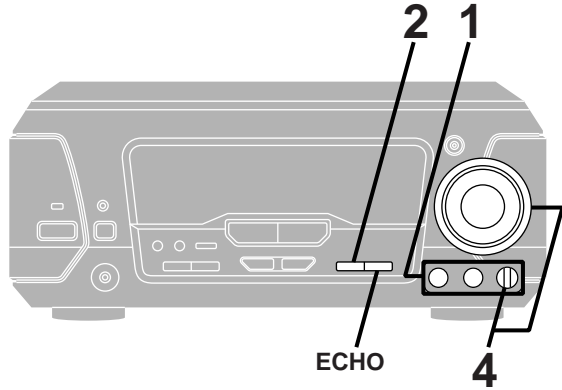
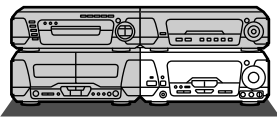

Enjoy karaoke with CDs and cassettes (For Australia and N.Z. only)

1 Lower the volume with [MIC VOL] and connect the microphone.
Plug type: 6.3 mm monaural

2 Press [KARAOKE] to select a voice mode.

Each time you press the button:
MONO L → MONO R → VOICE MUTE → (off)

Use this chart to select the appropriate mode.
○: appropriate ●: for practice —: inappropriate

Software Voice modes	Karaoke		Non-karaoke
	Sound multiplex	Stereo	
MONO L	○ (Background music)	—	—
MONO R	● (Voice)	—	—
VOICE MUTE	—	—	○
(off)	● (Background music+Voice)	○	● (For singing along)

3 Start playing the CD or cassette.

4 Adjust the main volume and microphone volume.

To cancel
Press [KARAOKE] to clear the display.

To record your performance
Start recording in deck 2 and then start singing.
Ensure the voice mode is set to off (at step 2 above) when playing the recording.

Note
The karaoke modes cannot be used with the radio, 3D AI EQ, 6CH DISCRETE INPUT or surround effects.

When using the VOICE MUTE function
Voice mute may not function sufficiently or noise may interfere when using the following software.

- Monaural software
- Software with few musical instruments, including classic music and poetry recitations
- Software with duets or strong choruses

A Using the echo effect

Press [ECHO].
Each time you press the button:
ECHO 1 → ECHO 2 → ECHO 3 → OFF

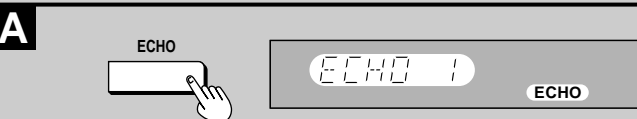
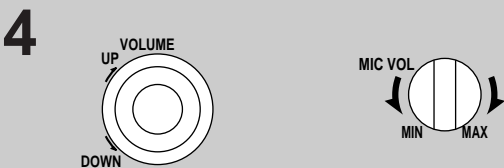
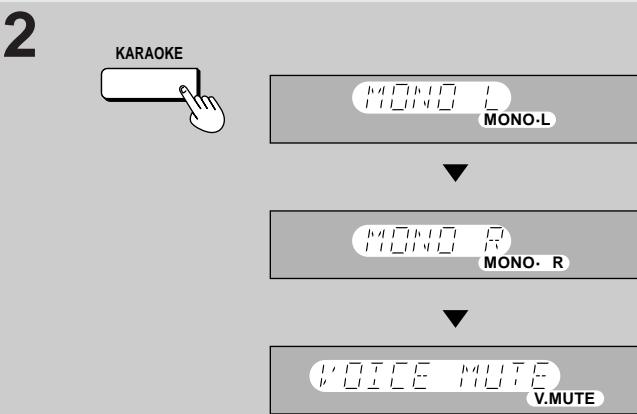
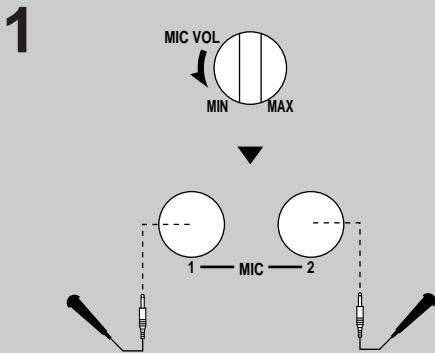

Technical specifications

SOUND PROCESSOR

■ **EQ/SFP section**
MANUAL GEQ
 3-Band parametric EQ
 Center frequency
 High band
 3.5 kHz, 5.3 kHz, 8 kHz, 12.5 kHz
 Mid band 240 Hz, 390 Hz, 630 Hz, 1 kHz,
 1.5 kHz, 2.3 kHz, 3.5 kHz
 Low band 70 Hz, 90 Hz, 143 Hz, 240 Hz
 Level control ±1.2, 2.4, 3.6, 4.8, 6 dB
EQ SPACE mode
 3 modes HEAVY, CLEAR, HALL
3D acoustic image EQ
 3 modes AI EQ, 3D AI 1, 3D AI 2

■ **Pre-amplifier section** **SC-EH760**
 Input sensitivity/impedance
 VCR (EXT) 250 mV/15 kΩ
 AUX (DVD) 250 mV/15 kΩ
 Output level
 VCR REC OUT 150 mV/1.5 kΩ
 (For Australia and N.Z. only)
VIDEO OUTPUT
 MONITOR OUT 1 Vp-p, 75 Ω
 VCR REC OUT 1 Vp-p, 75 Ω

■ **Pre-amplifier section** **SC-EH560**
 Input sensitivity/impedance
 VCR (EXT) 250 mV/15 kΩ
 Output level
 VCR REC OUT 150 mV/1.5 kΩ

■ **DOLBY PRO LOGIC section** **SC-EH760**
PRO LOGIC mode SURROUND
CENTER mode NORMAL
DELAY TIME 20 ms (Fixed)

■ **VIRTUAL DOLBY SURROUND section**
SC-EH560

Mode VIRTUAL DOLBY SURROUND

■ **AV SURROUND section**
AV surround mode SIMULATED STEREO
SC-EH760 SUPER SURROUND
 (MUSIC, MOVIE)

■ **DSP CONTROL section**
DSP control mode SEAT POSITION
SC-EH760 CENTER FOCUS (1, 2),
SC-EH760 VIRTUAL REAR SURROUND,
SC-EH760 MULTI REAR SURROUND,
SC-EH760 3D ENHANCED SURROUND
SC-EH560 CENTER EFFECT (1, 2, 3),
SC-EH560 SURROUND EFFECT (1, 2, 3)

■ **Spectrum analyzer section**
Display mode NORMAL, PEAKHOLD, AURORA

■ **General**
Dimensions (W×H×D)
SC-EH760 293×89×270 mm
SC-EH560 293×89×269 mm
Mass
SC-EH760 1.5 kg
SC-EH560 1.4 kg

TUNER AMPLIFIER

■ **Amplifier section** **SC-EH760**
 Power output (L/R both channel driven)
 Stereo Mode

DIN 10 kHz THD 1 %/6 Ω (High) 2×20 W
 1 kHz THD 1 %/6 Ω (Mid) 2×20 W
 100 Hz THD 1 %/8 Ω (Low) 2×50 W
 RMS 10 kHz THD 10 %/6 Ω (High) 2×30 W
 1 kHz THD 10 %/6 Ω (Mid) 2×30 W
 100 Hz THD 10 %/8 Ω (Low) 2×70 W

PRO LOGIC mode
 DIN FRONT 1 kHz THD 1 %/TTL Imp. 6 Ω
 (High/Mid) 2×20 W
 100 Hz THD 1 %/8 Ω (Low) 2×50 W
 SURROUND 1 kHz THD 1 %/8 Ω 2×20 W
 CENTER 1 kHz THD 1 %/8 Ω 50 W
 RMS FRONT 1 kHz THD 10 %/TTL
 Imp. 6 Ω (High/Mid)

2×30 W
 100 Hz THD 10 %/8 Ω (Low) 2×70 W

SURROUND 1 kHz THD 10 %/8 Ω 2×30 W
CENTER 1 kHz THD 10 %/8 Ω 70 W
PMPO 1 kHz/High or Mid 6 Ω, Low 8 Ω
 CENT. 8 Ω, SURR. 8 Ω 3,000 W

Total harmonic distortion
 Rated power at 1 kHz 1 % (6 Ω)
 Half power at 1 kHz 0.1 % (6 Ω)

Load impedance
FRONT (High/Mid) total impedance 6 Ω
 (Low) 8 Ω
SURROUND 8 Ω
CENTER 8 Ω

S. WOOFER
 Center frequency 70 Hz
LEVEL (VOL -20 dB) MID +8 dB
 MAX +12 dB

■ **Amplifier section** **SC-EH560**
Power output (L/R both channel driven)
 DIN 10 kHz THD 1 %/6 Ω (High) 2×12 W
 1 kHz THD 1 %/6 Ω (Mid) 2×12 W
 100 Hz THD 1 %/6 Ω (Low) 2×36 W
 RMS 10 kHz THD 10 %/6 Ω (High) 2×18 W
 1 kHz THD 10 %/6 Ω (Mid) 2×18 W
 100 Hz THD 10 %/6 Ω (Low) 2×54 W
PMPO 1 kHz/Low 6 Ω, Mid 6 Ω, High 6 Ω 1,400 W

Total harmonic distortion
 Rated power at 1 kHz 1 % (6 Ω)
 Half power at 1 kHz 0.1 % (6 Ω)
Load impedance Main (High) 6 Ω
 (Mid) 6 Ω
 (Low) 6 Ω

S. WOOFER
 Center frequency 70 Hz
LEVEL (VOL -20 dB) MID +8 dB
 MAX +12 dB

■ **FM tuner section**
Frequency range 87.50–108.00 MHz
 (0.05 MHz steps)

Sensitivity 1.8 μV (IHF usable)
S/N 26 dB 1.5 μV

S/N
MONO 70 dB (75 dB, IHF)
Antenna terminal(s) 75 Ω (unbalanced)

■ **AM tuner section**
Frequency range 522–1629 kHz (9 kHz steps)
 520–1630 kHz (10 kHz steps)

Sensitivity (S/N 20 dB) 500 μV/m

■ **Timer section**
Clock Quartz-lock type
Function Play timer (1 time, daily),
 Rec timer (1 time, daily),
 Sleep (120 min, 30 min intervals)

Setting intervals (Play/Rec)
 1 minute–23 hours 59 minutes
 (1 min intervals)

■ **General**
Power supply
 (For United Kingdom, Australia and N.Z.)
 AC 230–240 V 50 Hz

(For others) AC 230 V 50 Hz
Power consumption **SC-EH760** 205 W
SC-EH560 110 W

Standby
 Normal mode 11 W
 ECO mode 0.5 W
Dimensions (W×H×D) 293×118.5×346 mm
Mass **SC-EH760** 5.3 kg
SC-EH560 4.3 kg

CD PLAYER

■ **Audio**
DA converter 1 bit DAC MASH

■ **Pickup**
Wavelength 780 nm

■ **General**
Dimensions (W×H×D)
SC-EH760 293×89×288 mm
SC-EH560 293×89×268 mm

Mass **SC-EH760** 2.2 kg
SC-EH560 1.6 kg

CASSETTE DECK

Deck system Stereo cassette deck
Track system 4 track, 2 channel
Recording system AC bias
Bias frequency 100 kHz
Erasing system AC erase

Heads
Deck 1 (Playback head) Permalloy head
Deck 2 (Recording/Playback head) Permalloy head
(Erasing head) Double gap ferrite head

Motors
Deck 1, 2
Capstan drive DC servo motor

Tape speed 4.8 cm/s
Wow and flutter 0.16 % (WRMS)

Fast forward and rewind times
 Approx. 110 seconds with
 C-60 cassette tape

Frequency response (Dolby NR off)
TYPE I (NORMAL) 20 Hz–16 kHz (DIN)
TYPE II (HIGH) 20 Hz–16 kHz (DIN)
TYPE IV (METAL) 20 Hz–16 kHz (DIN)

S/N (Signal level=max recording level, TYPE II type tape)
NR off 56 dB (A weighted)
Dolby B NR on 66 dB (A weighted)

Input sensitivity and impedance
REC (IN) 150 mV/23 kΩ

Output voltage and impedance
PLAY (OUT) 280 mV/360 Ω

■ **General**
Dimensions (W×H×D) 294×118.5×281 mm
Mass 2.1 kg

FRONT SPEAKER

SC-EH760
Type 3 way, 3 speakers

Speaker(s)
Super woofer 17 cm cone type
Woofer 12 cm cone type
Tweeter 6 cm ring shaped dome type
Impedance High 6 Ω
 Mid 6 Ω
 Low 8 Ω

Input power (Music) High 60 W
 Mid 60 W
 Low 120 W

Output sound pressure level 87 dB/W (1.0 m)
Crossover frequency 120 Hz, 4 kHz
Frequency range 42 Hz–50 kHz (–16 dB)
 46 Hz–36 kHz (–10 dB)

■ **General**
Dimensions (W×H×D) 254×422×260 mm
Mass 6.4 kg

FRONT SPEAKER

SC-EH560
Type 3 way, 3 speakers

Speaker(s)
Super woofer 14 cm cone type
Woofer 12 cm cone type
Tweeter 6 cm cone type
Impedance High 6 Ω
 Mid 6 Ω
 Low 6 Ω

Input power (Music) High 40 W
 Mid 40 W
 Low 70 W

Output sound pressure level 84 dB/W (1.0 m)
Crossover frequency 150 Hz, 4 kHz
Frequency range 46 Hz–22 kHz (–16 dB)
 50 Hz–20 kHz (–10 dB)

■ **General**
Dimensions (W×H×D) 254×422×260 mm
Mass 6.0 kg

CENTER SPEAKER

SC-EH760
Type 2 way, 2 speakers

Speaker
Woofer 10 cm cone type
Tweeter 6 cm cone type
Impedance 8 Ω
Input power (Music) 120 W
Output sound pressure level 85 dB/W (1.0 m)
Crossover frequency 4 kHz
Frequency range 75 Hz–22 kHz (–16 dB)

■ **General**
Dimensions (W×H×D) 250×121×147 mm
Mass 1.6 kg

SURROUND SPEAKER

SC-EH760
Type 1 way, 1 speaker

Speaker
Full range 8 cm cone type
Impedance 8 Ω
Input power (Music) 60 W
Output sound pressure level 84 dB/W (1.0 m)
Frequency range 120 Hz–20 kHz (–16 dB)

■ **General**
Dimensions (W×H×D) 170×106×118 mm
Mass 0.9 kg

Note

- Specifications are subject to change without notice.
 Mass and dimensions are approximate.
- Total harmonic distortion is measured by the digital spectrum analyzer.

Troubleshooting guide

Before requesting service, make the below checks. If you can't fix the system as described below, or if something not listed here occurs, refer to the enclosed directory to locate an Authorized Service Center convenient to you or contact your dealer.

Reference pages are shown as black circled numbers ⑥.

Common Problems

No sound.	Turn the volume up. The speaker cords may be shorted. Turn the unit off, check and correct the connections and turn the unit on. ⑥
Sounds unfixed, reversed or come from one speaker only.	Check the speaker connections. ⑥
Humming heard during play.	An AC mains lead or fluorescent light is near the cables. Keep other appliances and leads away from this unit's cables. If possible in your area, turn the AC mains lead's plug or connector over to reverse the lead's polarity.
"ERROR" is displayed.	Incorrect operation performed. Read the instructions and try again.
"U70" is displayed.	Connect the flat cables firmly. If "U70" remains on the display, contact the dealer.
"F61" is displayed.	There is a problem with the tuner amplifier. Consult your dealer.
ECO mode on but display still lights up in standby mode.	Turn DEMO off. ①
"--:--" appears on the display.	You plugged the AC mains lead in for the first time or there was a power failure recently. Set the time. ①

Listening to the radio

Noise is heard. The stereo indicator flickers or doesn't light. Sound is distorted.	Use an outdoor antenna. ⑦
A beat sound is heard.	Turn the TV off or separate it from the unit.
A low hum is heard during AM broadcasts.	Separate the antenna from other cables and leads.
The correct AM frequency can't be tuned in.	Change the frequency step. Hold [TUNER/BAND] down for 10 seconds to change the step to 9 kHz.

When there is a television set nearby

The picture on the TV disappears or stripes appear on the screen.	The location and orientation of the antenna are incorrect. If you are using an indoor antenna, change to an outdoor antenna. The TV antenna wire is too close to the system. Separate the antenna wire of the TV set from the system.
--	--

The cassette deck

Poor quality sound.	Clean the heads. ④③ Check the Dolby NR setting. ①⑥
Recording is not possible.	If the erasure prevention tabs have been removed, cover the holes with adhesive tape. ③⑩

The CD changer or CD player

<p>The display is wrong or play won't start.</p>	<p>The disc may be upside down. ❶ Wipe the disc. Replace the disc if it is scratched, warped, or nonstandard. Condensation may have formed in the changer or player due to a sudden change in temperature. Wait about an hour for it to clear and try again.</p>
<p>SC-EH760 "TAKE OUT/DISC" appears on the display.</p>	<p>There is a problem with the CD mechanism. (A power failure may have occurred.) The tray will open automatically. Remove the CD from the tray, and after ensuring there is no CD in the tray close it. The unit will make the disc changing noises for a few moments and then it should operate normally.</p>

During "One touch" editing (⇒ page 32)

<p>"DECK NO TAPE" is displayed.</p>	<p>Load a cassette into deck 2. ❸</p>
<p>"DECK CHANGE TAPE" is displayed.</p>	<p>If the erasure prevention tabs have been removed, cover the holes with adhesive tape. ❹</p>

The remote control

<p>The remote control doesn't work.</p>	<p>Check the batteries are inserted correctly. ❶ Replace the batteries if they are worn.</p>
---	--

All components are required to service the system. If service is ever necessary, bring the entire system.

Maintenance

If the surfaces are dirty

To clean this unit, wipe with a soft, dry cloth.

If the surfaces are extremely dirty, use a soft cloth dipped in a soap-and-water solution or a weak detergent solution.

- Never use alcohol, paint thinner or benzine to clean this unit.
- Before using chemically treated cloth, read the instructions that came with the cloth carefully.

For a cleaner crisper sound

Clean the heads regularly to assure good quality playback and recording. Use a cleaning tape (not included).

