

# System Component

## Operating Instructions

Model No. **SC-EH790**  
**SC-EH590**

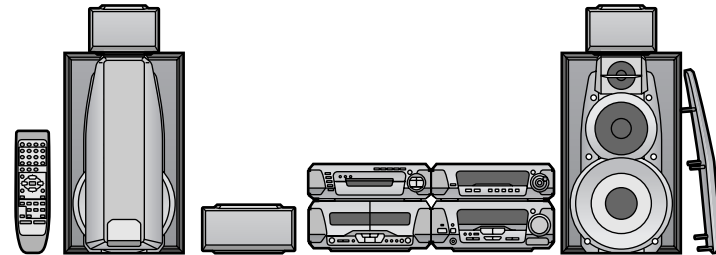

The illustration shows SC-EH790 for the United Kingdom and Eastern Europe.

**COMPACT**  
**disc**  
**DIGITAL AUDIO**

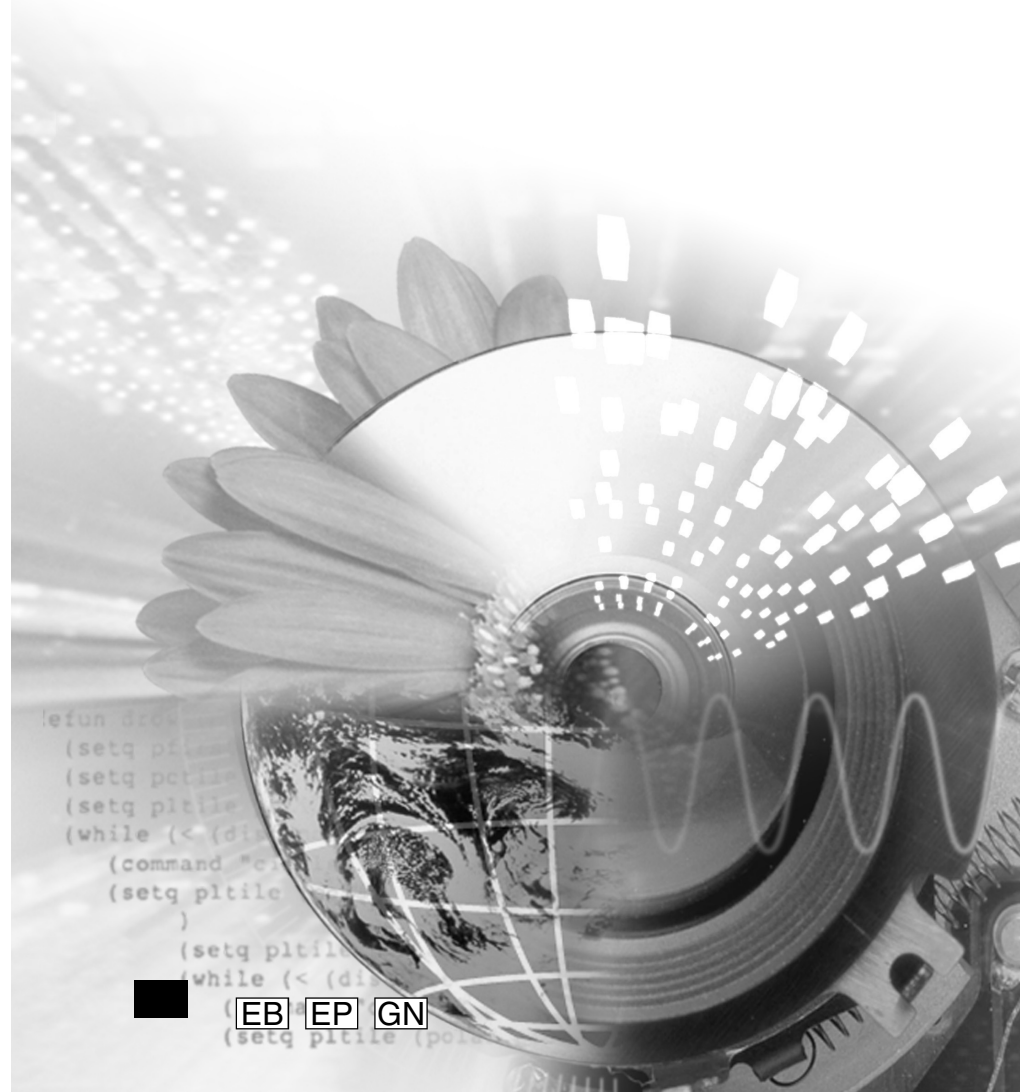

# Technics®

**Note**

“EB” on the outer packaging indicates the United Kingdom.

Before connecting, operating or adjusting this product, please read these instructions completely. Please keep this manual for future reference.

EB EP GN

RQT6866-B

## Dear customer

Thank you for purchasing this product. For optimum performance and safety, please read these instructions carefully.

These operating instructions are applicable to the following systems. These operating instructions, however, fundamentally explain the operation of system SC-EH790.

**EH790**: indicates a function which can be enjoyed with SC-EH790 only.  
**EH590**: indicates a function which can be enjoyed with SC-EH590 only.

System	SC-EH790	SC-EH590	
Sound processor	SH-EH790	SH-EH590	
Tuner / amplifier	SA-EH790	SA-EH590	
CD changer	SL-EH790	—	
CD player	—	SL-EH590	
Cassette deck	RS-DV290	RS-DV290	
Speakers	Front	SB-DV290	SB-EH590
	Center	SB-PC95	—
	Surround	SB-PS95	—

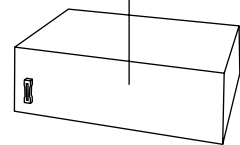

CD changer or CD player  
(Back of product)

DANGER	INVISIBLE LASER RADIATION WHEN OPEN. AVOID DIRECT EXPOSURE TO BEAM.
ADVARSEL	USYNLIG LASERSTRÅLING VED ÅBNING. NÅR SIKKERHEDSAFBRYDRE ER UDE AF FUNKTION. UNDGÅ UDSÆTTELSE FOR STRÅLING.
VARO!	AVATTAESSA JA SUOJALUKITUS OHITETTAESSA OLET ALTTIINA NÄKYMÄTÖNTÄ LASERSÄTEILYLLE. ÄLÄ KATSO SÄTEESEEN.
VARNING	OSYNLIG LASERSTRÅLNING NÄR DENNA DEL ÄR ÖPPNAD OCH SPÄRREN ÄR URKOPPLAD. BETRÄKTA EJ STRÅLEN.
ADVARSEL	USYNLIG LASERSTRÅLING NÅR DEKSEL ÅPNES OG SIKKERHEDSLÅS BRYTES. UNNGÅ EKSPONERING FOR STRÅLEN.
VORSICHT	UNSIHTBARE LASERSTRÄHLUNG, WENN ABDECKUNG GEÖFFNET. NICHT DEM STRAHL AUSSETZEN.

(Inside of product)

### For United Kingdom and Republic of Ireland

**shop@ Panasonic**  
 www.panasonic.co.uk (for UK customers only)

- Order accessory and consumable items for your product with ease and confidence by telephoning our Customer Care Centre Mon-Friday 9:00am-5:30pm. (Excluding public holidays.)
- Or go on line through our Internet Accessory ordering application.
- Most major credit and debit cards accepted.
- All enquiries transactions and distribution facilities are provided directly by Panasonic UK Ltd.
- It couldn't be simpler!

Customer Care Centre  
 For UK customers: 08705 357357  
 For Republic of Ireland customers: 01 289 8333

Technical Support  
 For UK customers: 0870 1 505610

This Technical Support Hot Line number is for Panasonic PC software related products only.

For Republic of Ireland, please use the Customer Care Centre number listed above for all enquiries.

For all other product related enquiries, please use the Customer Care Centre numbers listed above.

## Supplied accessories



Please check and identify the supplied accessories. Use numbers indicated in parentheses when asking for replacement parts.

- AC mains lead** ..... 1  
 For the United Kingdom (RJA0053-3X) For Australia and N.Z. (RJA0035-2X)

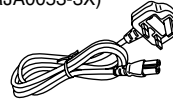

For Eastern Europe (RJA0019-2X)



### Note

The included AC mains lead is for use with this unit only. Do not use it with other equipment.

- Remote control** ..... 1  
**EH790** for the United Kingdom and Eastern Europe (EUR7702270) **EH790** for Australia and N.Z. (EUR7702280)

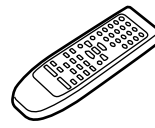
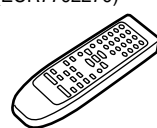

**EH590**  
(EUR7702070)

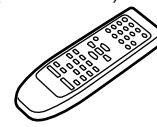

- Remote control batteries** ..... 2

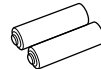

- FM indoor antenna** ..... 1  
 For the United Kingdom and Eastern Europe (RSA0007) For Australia and N.Z. (RSA0006-J)

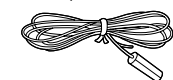

- AM loop antenna set** ..... 1  
(RSA0022-L)

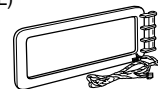

- Speaker leads**  
 (REE1234) ..... 2 (REE1233) ..... 2  
 (Red/Black) (Gray/Blue)



- Antenna plug adaptor** ..... 1  
 Only for the United Kingdom (SJP9009)



## Table of contents

### Before use

- Safety precautions** ..... 3
- Caution for AC Mains Lead** ..... 4

### Simple set-up and play

- Locating** ..... 5
- Speaker leads** ..... 6
- Antennas** ..... 7
- Flat cables and AC mains lead** ..... 7
- Listening to a CD** ..... 8

### Control guide and preparatory steps

- Front panel controls** ..... 9
- The remote control** ..... 11
- Turning DEMO off** ..... 12
- Setting the time** ..... 12

### Basic operations

- CDs** ..... 13
- The radio: manual tuning** ..... 17
- The radio: preset tuning** ..... 18
- Cassette tapes** ..... 19

### Changing sound field and quality

- Boosting the super woofer** ..... 20
- Using the super sound equalizer** ..... 20
- Changing sound field and quality** ..... 20
  - Using the acoustic image equalizer (AI EQ) ..... 21
  - Using the manual equalizer (M.EQ) ..... 22
- Enjoying surround sound** ..... 23
  - 6CH DISCRETE INPUT ..... 24
  - DOLBY PRO LOGIC ..... 24
  - SUPER SURROUND ..... 24
  - Speaker level adjustments ..... 25
- Surround effects** ..... 26

### Recording operations

- Before recording (Deck 2 only)** ..... 28
- Recording CDs** ..... 29
- Recording the radio** ..... 30
- Tape-to-tape recording** ..... 30

### Timer operations and convenient functions

- Using the timers** ..... 31
- Changing the sound range display** ..... 34
- Muting the volume** ..... 34
- Using headphones** ..... 34
- Enjoying karaoke (For Australia and N.Z.)** ..... 35
- External unit connections** ..... 36
- Optional antenna connections** ..... 37
- Using other equipment** ..... 37

### References

- Troubleshooting guide** ..... 38
- Maintenance** ..... 39
- Cassette tape selection and care** ..... 39
- Technical specifications** ..... Back cover

## Safety precautions

### Placement

Set the unit up on an even surface away from direct sunlight, high temperatures, high humidity, and excessive vibration. These conditions can damage the cabinet and other components, thereby shortening the unit's service life.

Place it at least 15 cm away from wall surfaces to avoid distortion and unwanted acoustical effects.

Do not place heavy items on the unit.

### Voltage

Do not use high voltage power sources. This can overload the unit and cause a fire.

Do not use a DC power source. Check the source carefully when setting the unit up on a ship or other place where DC is used.

### AC mains lead protection

Ensure the AC mains lead is connected correctly and not damaged. Poor connection and lead damage can cause fire or electric shock. Do not pull, bend, or place heavy items on the lead.

Grasp the plug firmly when unplugging the lead. Pulling the AC mains lead can cause electric shock.

Do not handle the plug with wet hands. This can cause electric shock.

### Foreign matter

Do not let metal objects fall inside the unit. This can cause electric shock or malfunction.

Do not let liquids get into the unit. This can cause electric shock or malfunction. If this occurs, immediately disconnect the unit from the power supply and contact your dealer.

Do not spray insecticides onto or into the unit. They contain flammable gases which can ignite if sprayed into the unit.

### Service

Do not attempt to repair this unit by yourself. If sound is interrupted, indicators fail to light, smoke appears, or any other problem that is not covered in these instructions occurs, disconnect the AC mains lead and contact your dealer or an authorized service center. Electric shock or damage to the unit can occur if the unit is repaired, disassembled or reconstructed by unqualified persons.

Extend operating life by disconnecting the unit from the power source if it is not to be used for a long time.

### CAUTION!

THIS PRODUCT UTILIZES A LASER. USE OF CONTROLS OR ADJUSTMENTS OR PERFORMANCE OF PROCEDURES OTHER THAN THOSE SPECIFIED HEREIN MAY RESULT IN HAZARDOUS RADIATION EXPOSURE. DO NOT OPEN COVERS AND DO NOT REPAIR YOURSELF. REFER SERVING TO QUALIFIED PERSONNEL.

### WARNING:

TO REDUCE THE RISK OF FIRE, ELECTRIC SHOCK OR PRODUCT DAMAGE, DO NOT EXPOSE THIS APPARATUS TO RAIN, MOISTURE, DRIPPING OR SPLASHING AND THAT NO OBJECTS FILLED WITH LIQUIDS, SUCH AS VASES, SHALL BE PLACED ON THE APPARATUS.

### CAUTION!

DO NOT INSTALL OR PLACE THIS UNIT IN A BOOKCASE, BUILT-IN CABINET OR IN ANOTHER CONFINED SPACE. ENSURE THE UNIT IS WELL VENTILATED. TO PREVENT RISK OF ELECTRIC SHOCK OR FIRE HAZARD DUE TO OVERHEATING, ENSURE THAT CURTAINS AND ANY OTHER MATERIALS DO NOT OBSTRUCT THE VENTILATION VENTS. DO NOT OBSTRUCT THE UNIT'S VENTILATION OPENINGS WITH NEWSPAPERS, TABLECLOTHS, CURTAINS, AND SIMILAR ITEMS. DO NOT PLACE SOURCES OF NAKED FLAMES, SUCH AS LIGHTED CANDLES, ON THE UNIT. DISPOSE OF BATTERIES IN AN ENVIRONMENTALLY FRIENDLY MANNER.

This product may receive radio interference caused by mobile telephones during use. If such interference is apparent, please increase separation between the product and the mobile telephone.

THIS UNIT IS INTENDED FOR USE IN MODERATE CLIMATES.

# (For United Kingdom)

("EB" area code model only)

For your safety, please read the following text carefully.

This appliance is supplied with a moulded three pin mains plug for your safety and convenience. A 5-ampere fuse is fitted in this plug.

Should the fuse need to be replaced please ensure that the replacement fuse has a rating of 5-ampere and that it is approved by ASTA or BSI to BS1362.

Check for the ASTA mark or the BSI mark on the body of the fuse.

If the plug contains a removable fuse cover you must ensure that it is refitted when the fuse is replaced.

If you lose the fuse cover the plug must not be used until a replacement cover is obtained.

A replacement fuse cover can be purchased from your local dealer.

### CAUTION!

IF THE FITTED MOULDED PLUG IS UNSUITABLE FOR THE SOCKET OUTLET IN YOUR HOME THEN THE FUSE SHOULD BE REMOVED AND THE PLUG CUT OFF AND DISPOSED OF SAFELY.

THERE IS A DANGER OF SEVERE ELECTRICAL SHOCK IF THE CUT OFF PLUG IS INSERTED INTO ANY 13-AMPERE SOCKET.

If a new plug is to be fitted please observe the wiring code as stated below.

If in any doubt please consult a qualified electrician.

### IMPORTANT

The wires in this mains lead are coloured in accordance with the following code:

Blue: Neutral, Brown: Live.

As these colours may not correspond with the coloured markings identifying the terminals in your plug, proceed as follows:

The wire which is coloured Blue must be connected to the terminal which is marked with the letter N or coloured Black or Blue.

The wire which is coloured Brown must be connected to the terminal which is marked with the letter L or coloured Brown or Red.

**WARNING: DO NOT CONNECT EITHER WIRE TO THE EARTH TERMINAL WHICH IS MARKED WITH THE LETTER E, BY THE EARTH SYMBOL  $\perp$  OR COLOURED GREEN OR GREEN/YELLOW.**

**THIS PLUG IS NOT WATERPROOF—KEEP DRY.**

### Before use

Remove the connector cover.

### How to replace the fuse

The location of the fuse differ according to the type of AC mains plug (figures A and B). Confirm the AC mains plug fitted and follow the instructions below. Illustrations may differ from actual AC mains plug.

1. Open the fuse cover with a screwdriver.

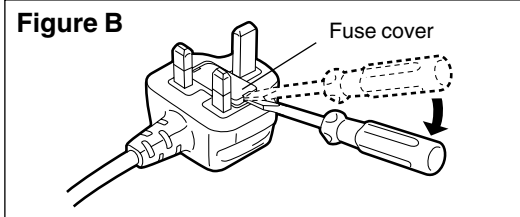
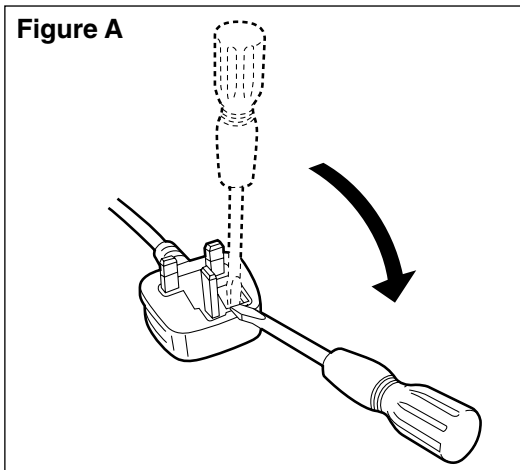

2. Replace the fuse and close or attach the fuse cover.

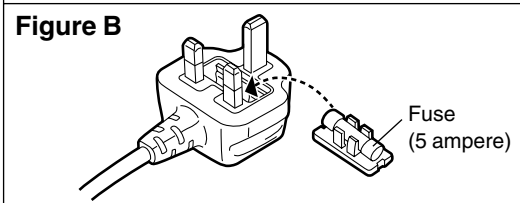
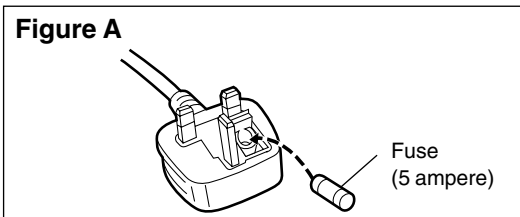

# Simple set-up and play

## STEP 1 Locating

The illustrations show SC-EH790 for the United Kingdom and Eastern Europe.

### Components

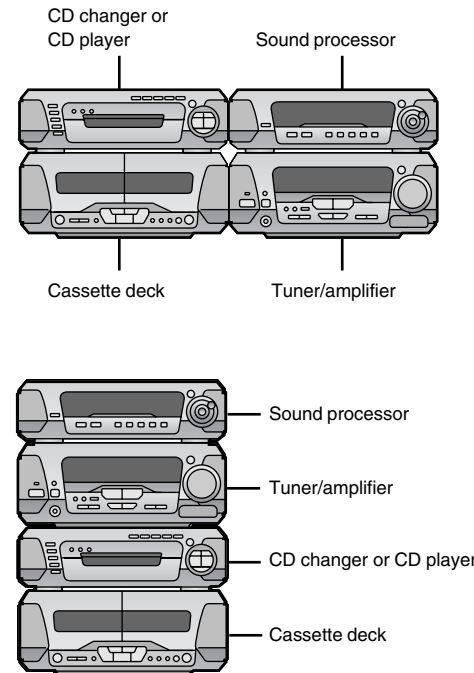

### Speakers

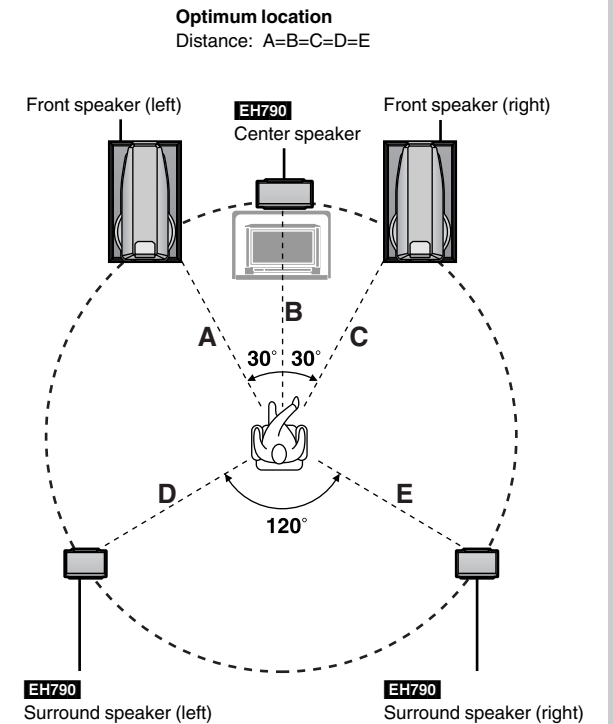

### Note

Do not put the CD changer or CD player on the top of the tuner/amplifier. Heat can damage your CDs.

### Use only the supplied speakers.

Using other speakers can damage the unit and sound quality will be negatively affected.

### Caution

- Use the speakers only with the recommended system. Failure to do so may lead to damage to the amplifier and/or the speakers, and may result in the risk of fire. Consult a qualified service person if damage has occurred or if you experience a sudden change in performance.
- Do not attempt to attach these speakers to walls using methods other than those described in this manual.

### Notes on speaker use

- You can damage your speakers and shorten their useful life if you play sound at high levels over extended periods.
- Reduce the volume in the following cases to avoid damage.
  - When playing distorted sound.
  - When the speakers are receiving howling from a microphone (for Australia and N.Z.) or record player, noise from FM broadcasts, or continuous signals from an oscillator, test disc, or electronic instrument.
  - When adjusting the sound quality.
  - When turning the unit on or off.

### If irregular colouring occurs on your television

These speakers are designed to be used close to a television, but the picture may be affected with some televisions and set-up combinations. If this occurs, turn the television off for about 30 minutes. The television's demagnetizing function should correct the problem. If it persists, move the speakers further away from the television.

### Front speakers

Left and right front speakers are exactly same.

### Surround speakers

Place either side of the listening position, or slightly to the rear, about 1 meter higher than ear level with the Technics logo facing toward the listening position.

The effect varies with the type of music and the music source.

If you are unable to position the surround speakers as recommended You can put them near the front speakers and still achieve a surround-like effect (→ page 26, VIRTUAL REAR SURROUND).

### Attaching to a wall

Set the speaker onto screws and slide through bracket to lock into position.

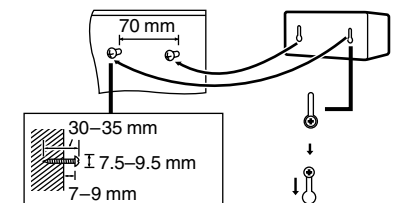

### Note

The wall or pillar on which the speakers are to be attached should be capable of supporting 5 kg per screw.



# Simple set-up and play

## STEP 2 Speaker leads

The illustrations show SC-EH790 for the United Kingdom and Eastern Europe. Do not connect the AC mains lead until all other connections are complete.

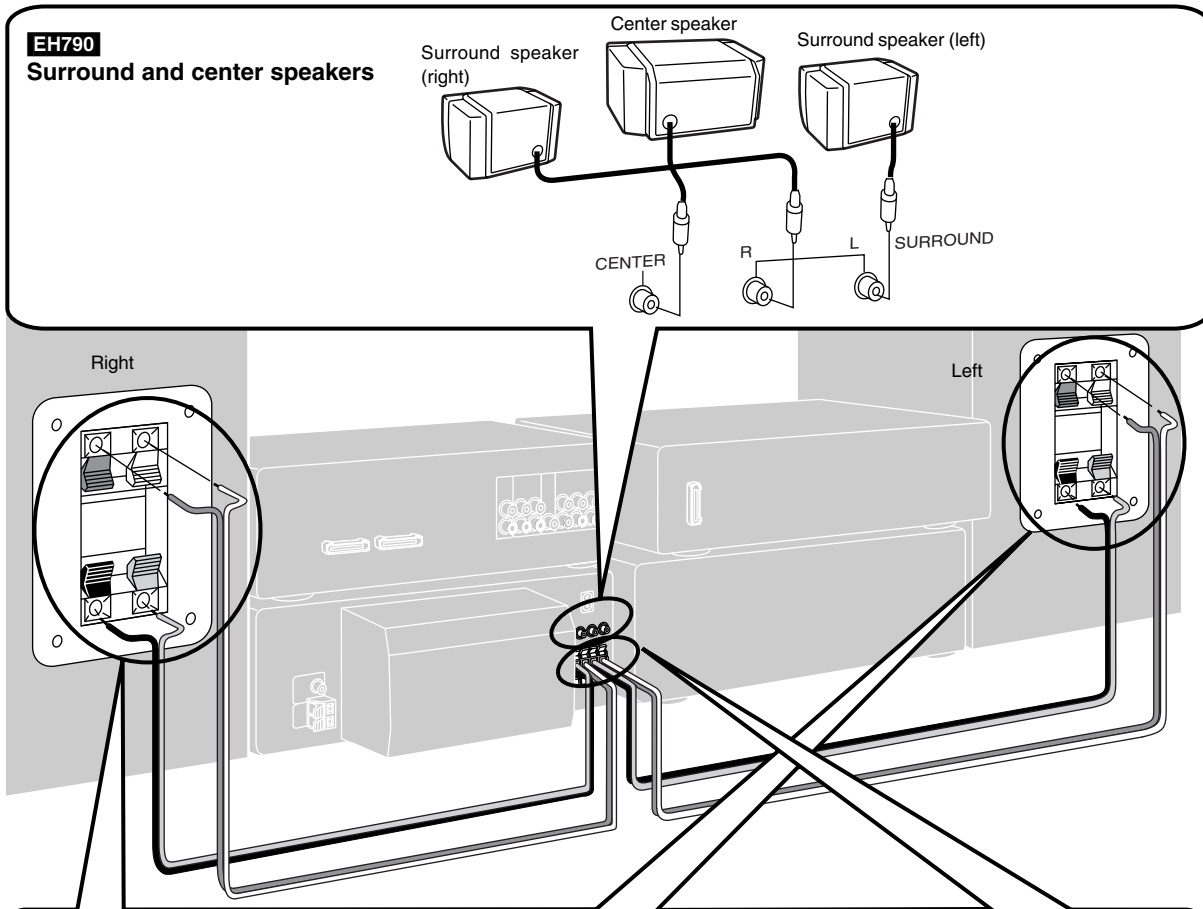

### Front speaker

Connect the leads to the terminals of the same colour.  
LF and HF stand for low frequency and high frequency.

**Connect the left (L) side in the same way.**

**Note**

- Never short-circuit positive (+) and negative (-) speaker wires.
- Be sure to connect only positive (red or grey) wires to positive (+) terminals and negative (black or blue) wires to negative (-) terminals.

Incorrect connection can damage the speakers.

Twist the vinyl tip and pull off.

### Speaker side

### Tuner/amplifier side

## STEP 3 Antennas

### FM indoor antenna

Fix the other end of the antenna where reception is best.

### For Australia and N.Z.

Twist the vinyl tip and pull off.

### AM indoor antenna

Twist the vinyl tip and pull off.

## STEP 4 Flat cables and AC mains lead

### Flat cables

Keep the cables as flat as possible against the back of the unit. Connect the connectors to the terminals of the same colour. Incorrect connection can damage the unit.

### Connecting

### Disconnecting

### AC mains lead

**(For the United Kingdom only)**  
**BE SURE TO READ THE CAUTION FOR THE AC MAINS LEAD ON PAGE 4 BEFORE CONNECTION.**

### Insertion of connector

Even when the connector is perfectly inserted, depending on the type of inlet used, the front part of the connector may jut out as shown in the drawing. However there is no problem using the unit.

Appliance inlet  
Connector  
Approx. 6 mm

### For your reference:

Information you enter into the unit's memory, except for time, remains intact for up to two weeks after the mains lead is disconnected.

# Simple set-up and play — Listening to a CD —

The illustrations show SC-EH790 for the United Kingdom and Eastern Europe.

**2** **EH790**  
Press **DIRECT OPEN [DISC1]–[DISC5]** and insert a CD.

**1** Press **[⏻/⏷]** to turn the unit on.

**EH590**  
Press **[▲, OPEN/CLOSE]** and insert a CD.

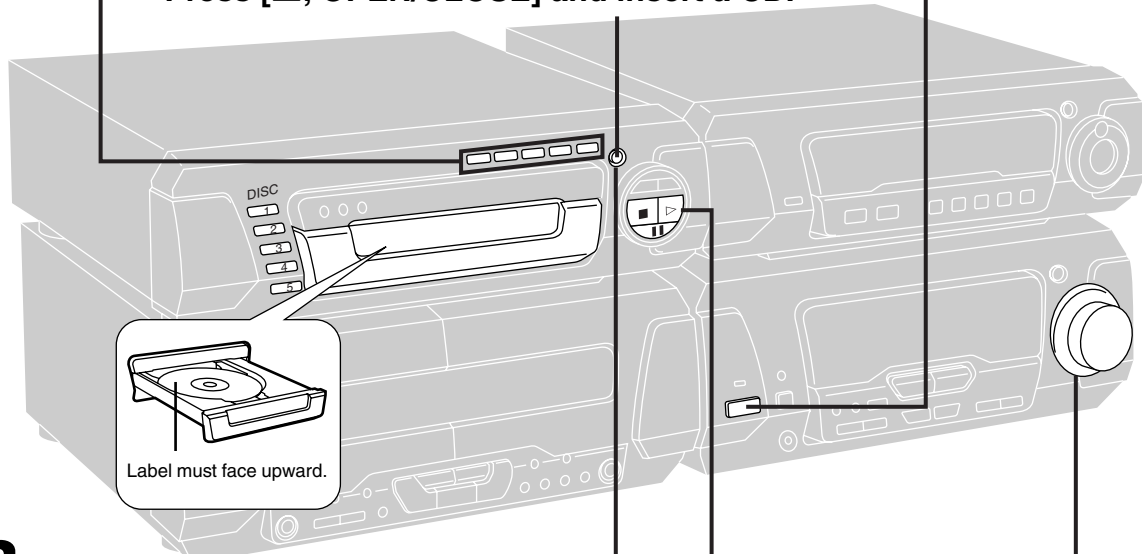

**3** Press **[▲, OPEN/CLOSE]** to close the tray.

**EH790** Repeat steps 2 and 3 to load the other trays.  
Displayed when the unit is in CD mode.  
e.g. CD (CD-DA)

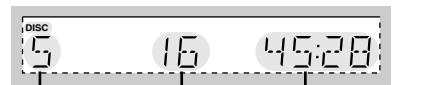

**EH790** Total number of tracks      Total playing time  
Disc number

**4** Press **[▶]** to start play.

**EH790**  
Play starts from the first track on the disc in the play position and finishes at the end of the last track on the final disc (see below).  
You can start play from another disc by pressing [DISC, 1–5].

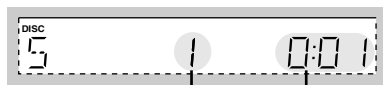

Track number      Elapsed play time

**5** Adjust the volume.



**To stop the disc**  
Press **[■]**.

**To pause play**  
Press **[⏸]** during play. The “▷” indicator flashes.  
Press **[⏸]** or **[▶]** to resume play.

**Note**  
**EH790**  
You can not change CDs in other trays while a disc is playing.

**Final disc** **EH790**  
For example, if play starts from disc 4, disc 3 will be the final disc.  
Order of progression: Disc 4→5→1→2→3

**“NO DISC” is displayed**  
When the unit is in CD mode but a disc isn't in the play position\* (SC-EH790) or in the player (SC-EH590).  
\*The disc in the play position is ready to play immediately when you press [▶].

## A

**EH790**

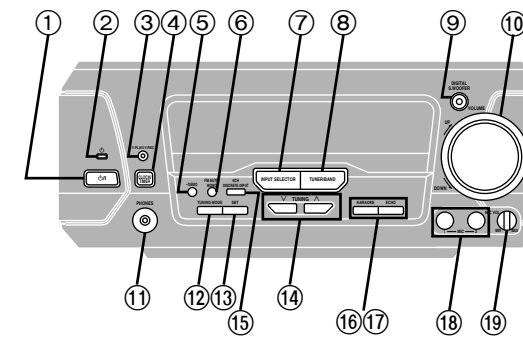

**EH590**

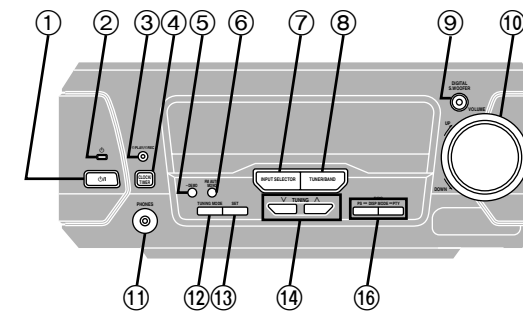

## B

**EH790**

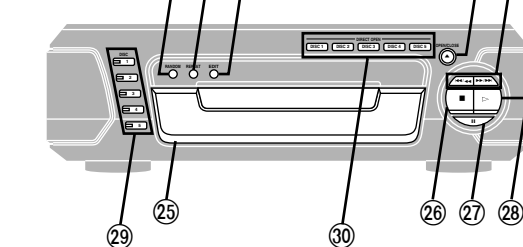

**EH590**

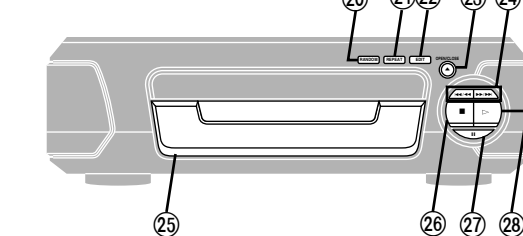

## Front panel controls

### A Tuner/amplifier

- ① **Standby/on switch (⏻/⏷)** ..... 8  
Press to switch the unit from on to standby mode or vice versa. In standby mode, the unit is still consuming a small amount of power.
- ② **Standby indicator (⏻)**  
When the unit is connected to the AC mains supply, this indicator lights up in standby mode and goes out when the unit is turned on.
- ③ **Play timer/record timer button and indicator (⏻/⏻)** ..... 31, 32
- ④ **Clock/timer button (CLOCK/TIMER)** ..... 12, 31, 32
- ⑤ **Demo button (–DEMO)** ..... 12
- ⑥ **FM mode button (FM AUTO/MONO)** ..... 17
- ⑦ **Source input button (INPUT SELECTOR)** ..... 37
- ⑧ **Tuner/band button (TUNER/BAND)** ..... 17
- ⑨ **Digital super woofer button and indicator (DIGITAL S.WOOFER)** ..... 20
- ⑩ **Volume control (VOLUME)** ..... 8
- ⑪ **Headphone jack (PHONES)** ..... 34
- ⑫ **Tuning mode button (TUNING MODE)** ..... 17
- ⑬ **Set button (SET)** ..... 12, 18
- ⑭ **Tuning buttons (v, ^ TUNING)** ..... 12, 17
- ⑮ **EH790**  
**6ch discrete input button (6CH DISCRETE INPUT)** ..... 24
- ⑯ **EH790 for the United Kingdom and Eastern Europe**  
**EH590**  
**RDS display mode button (RDS, PS–DISP MODE–PTY)** ..... 17
- EH790 for Australia and N.Z.**
- ⑰ **Karaoke and echo buttons (KARAOKE, ECHO)** ..... 35
- ⑱ **Microphone jacks (1–MIC–2)** ..... 35
- ⑲ **Microphone volume control (MIC VOL)** ..... 35

### B CD changer/CD player

- ⑳ **Random play button (RANDOM)** ..... 16
- ㉑ **Repeat play button (REPEAT)** ..... 16
- ㉒ **CD edit button (EDIT)** ..... 29
- ㉓ **Disc tray open/close button (▲, OPEN/CLOSE)** ..... 8
- ㉔ **Skip/search buttons (◀◀/▶▶, ▶▶/▶▶)** ..... 13
- ㉕ **Disc tray**
- ㉖ **Stop button (■)** ..... 8
- ㉗ **Pause button (⏸)** ..... 8
- ㉘ **Play button and indicator (▶)** ..... 8  
The colour of the indicator depends on the operation taking place.  
If stopped: orange  
If playing: green  
If paused: flashes
- EH790**
- ㉙ **Disc select buttons and indicators (DISC, 1–5)** ..... 8  
Green: Indicates that the tray is ready to play its CD or to be opened.
- ㉚ **Disc direct open buttons (DIRECT OPEN, DISC 1–DISC 5)**

Control guide and preparatory steps

Simple set-up and play

**A**

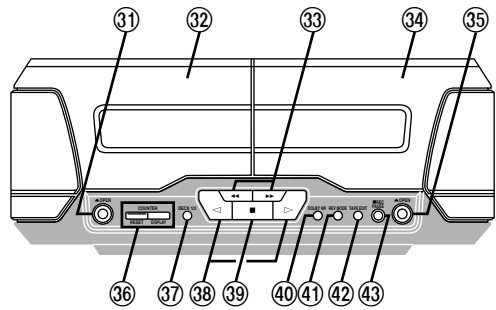

**Front panel controls**

**A Cassette deck**

- 31 Deck 1 cassette holder open button (▲ OPEN) ..... 19
  - 32 Deck 1
  - 33 Fast forward/rewind, TPS buttons (◀◀, ▶▶) ..... 19
  - 34 Deck 2
  - 35 Deck 2 cassette holder open button (▲ OPEN) ..... 19
  - 36 Counter reset, display buttons (COUNTER, RESET, DISPLAY) ..... 28
  - 37 Deck 1/deck 2 select button (DECK 1/2) ..... 19
  - 38 Playback buttons and indicators (◀, ▶) ..... 19
- The colour of the indicators depends on the operation taking place.  
 If stopped, fast forwarding or rewinding: orange  
 If playing or recording: green  
 While carrying out TPS or recording is on standby: flashes
- 39 Stop button (■) ..... 19
  - 40 Dolby noise reduction button (DOLBY NR) ..... 19
  - 41 Reverse mode button (REV MODE) ..... 19
  - 42 Tape edit button (TAPE EDIT) ..... 30
  - 43 Record pause button (● REC PAUSE) ..... 29

**B**

**EH790**

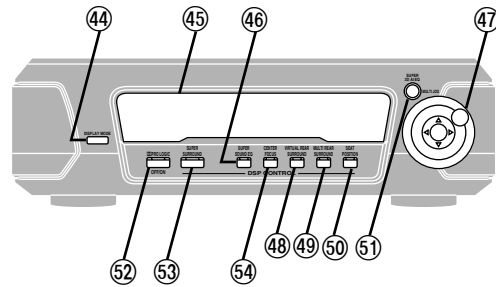

**EH590**

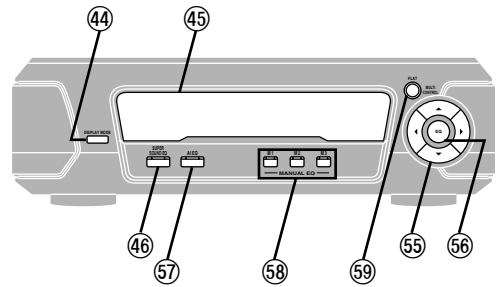

**B Sound processor**

- 44 Display mode button (DISPLAY MODE) ..... 34
  - 45 Display
  - 46 Super sound EQ button (SUPER SOUND EQ) ..... 20
- EH790**
- 47 Jog control and joystick (◀, ▶, ▲, ▼, MULTI JOG) ..... 20
  - 48 Virtual rear surround button and indicator (VIRTUAL REAR SURROUND) ..... 26
  - 49 Multi rear surround button and indicator (MULTI REAR SURROUND) ..... 26
  - 50 Seat position button and indicator (SEAT POSITION) ..... 27
  - 51 Super 3D AI EQ button (SUPER 3D AI EQ) ..... 21
  - 52 DOLBY PRO LOGIC button and indicator (DOLBY PRO LOGIC, OFF/ON) ..... 24
  - 53 Super surround button and indicator (SUPER SURROUND) ..... 24
  - 54 Center focus button and indicator (CENTER FOCUS) ..... 26
- EH590**
- 55 Multi control buttons (◀, ▶, ▲, ▼, MULTI CONTROL) ..... 21
  - 56 EQ button (EQ) ..... 20
  - 57 AI EQ button (AI EQ) ..... 21
  - 58 Manual EQ buttons (M1, M2, M3) ..... 22
  - 59 Flat button (FLAT) ..... 20

**A**

The illustration shows the remote control for SC-EH790 for Australia and N.Z.

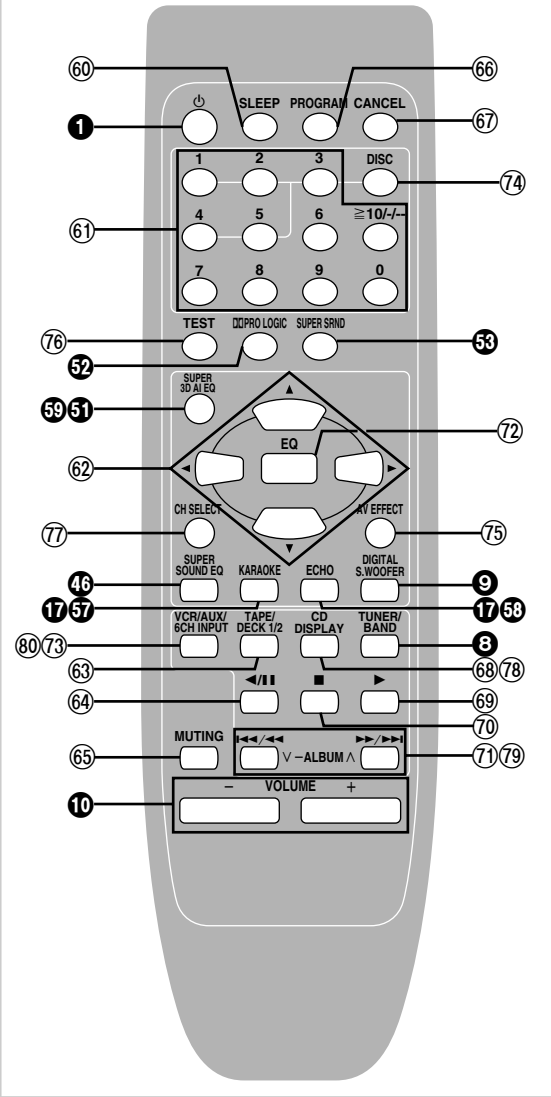

**Front panel controls**

**A Remote control**

Buttons such as 1 function in the same way as the controls on the main unit.

- 60 Sleep timer button (SLEEP) ..... 33
  - 61 Numbered buttons (1-9, 0, ≥10/-/-) ..... 15
  - 62 Cursor buttons (◀, ▶, ▲, ▼) ..... 25, 26
  - 63 Tape select, deck 1/deck 2 select button (TAPE/DECK 1/2) ..... 19
  - 64 CD pause/tape reverse playback button (◀/II) ..... 8, 19
  - 65 Muting button (MUTING) ..... 34
  - 66 Program button (PROGRAM) ..... 15
  - 67 Cancel button (CANCEL) ..... 15
  - 68 CD button (CD) ..... 15, 16
  - 69 CD/tape forward playback button (▶) ..... 15, 19
  - 70 CD/tape stop button (■) ..... 15, 19
  - 71 CD skip/search, tape fast forward/rewind buttons (I◀◀, ▶▶I) ..... 13, 19
  - 72 EQ button (EQ) ..... 20
- EH790**
- 73 Input select button (VCR/AUX/6CH INPUT) ..... 24, 37
  - 74 Disc button (DISC) ..... 15
  - 75 AV effect button (AV EFFECT) ..... 26
  - 76 Test button (TEST) ..... 25
  - 77 Channel select button (CH SELECT) ..... 25
  - 78 Display button (DISPLAY) ..... 14
  - 79 Album skip buttons (v, ^, -ALBUM) ..... 13
- EH590**
- 80 AUX button (AUX) ..... 37

**The remote control**

**B Batteries**

- Insert so the poles (+ and -) match those in the remote control.
- Do not use rechargeable type batteries.

**Do not;**

- mix old and new batteries.
  - use different types at the same time.
  - heat or expose to flame.
  - take apart or short circuit.
  - attempt to recharge alkaline or manganese batteries.
  - use batteries if the covering has been peeled off.
  - keep together with metallic objects such as necklaces.
- Mishandling of batteries can cause electrolyte leakage which can damage items the fluid contacts and may cause a fire.  
 If electrolyte leaks from the batteries, consult your dealer.  
 Wash thoroughly with water if electrolyte comes in contact with any part of your body.

Remove if the remote control is not going to be used for a long period of time. Store in a cool, dark place.  
 Replace if the unit does not respond to the remote control even when held close to the front panel.

**C Use**

Aim at the sensor, avoiding obstacles, at a maximum range of 7 meters directly in front of the unit.

- Keep the transmission window and the unit's sensor free from dust.
- Operation can be affected by strong light sources, such as direct sunlight, and the glass doors on cabinets.

**Do not;**

- put heavy objects on the remote control.
- take the remote control apart.
- spill liquids onto the remote control.

**B**

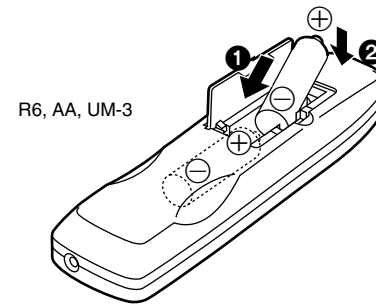

**C**

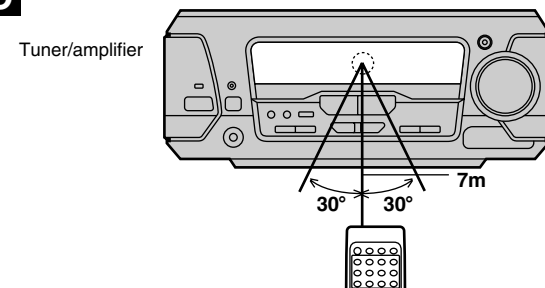

**A**

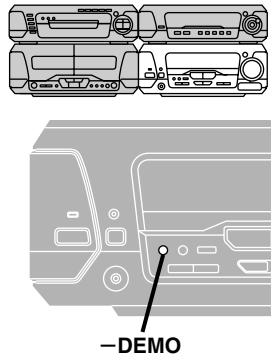

**B**

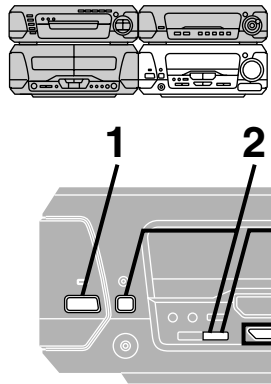

**1**



**2**



**3**

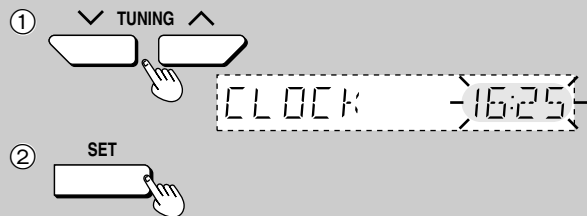

**A Turning DEMO off**

A demonstration of the display is shown if you have not set the clock.  
You can reduce the power consumed in standby mode by turning the demonstration off.

While the unit is on:  
**Press and hold [-DEMO] until "NO DEMO" is displayed.**  
Each time you press and hold the button:  
NO DEMO (off) ↔ DEMO (on)

**B Setting the time**

This is a 24-hour clock.  
The example shows how to set the clock for 16:25 (4:25 p.m.).

- 1 Press [POWER] to turn the unit on.**
- 2**
  - ① Press [CLOCK/TIMER] to display "CLOCK".**  
Each time you press the button:  
CLOCK → [PLAY] → [REC] → Original display
  - ② Within 5 seconds Press [SET].**
- 3**
  - ① Press [TUNING (∨ or ∧)] to set the time.**  
The time display can be changed in one minute units by tapping the buttons, and quickly by holding down the buttons.
  - ② Press [SET].**

The time is set and the original display is restored.

**Displaying the clock**

Press [CLOCK/TIMER].  
The clock is shown for about 5 seconds.

Reset the clock regularly to maintain accuracy.

**A**

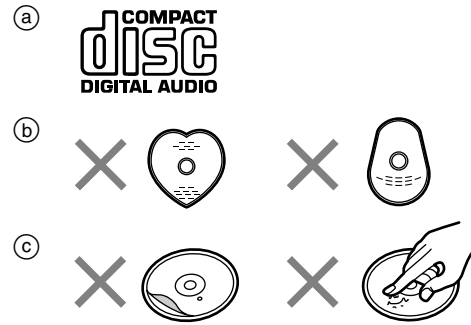

**B**

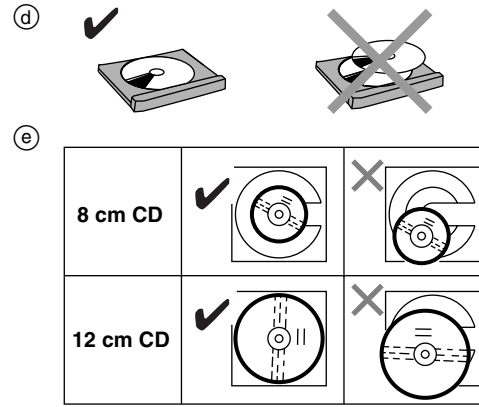

**C**

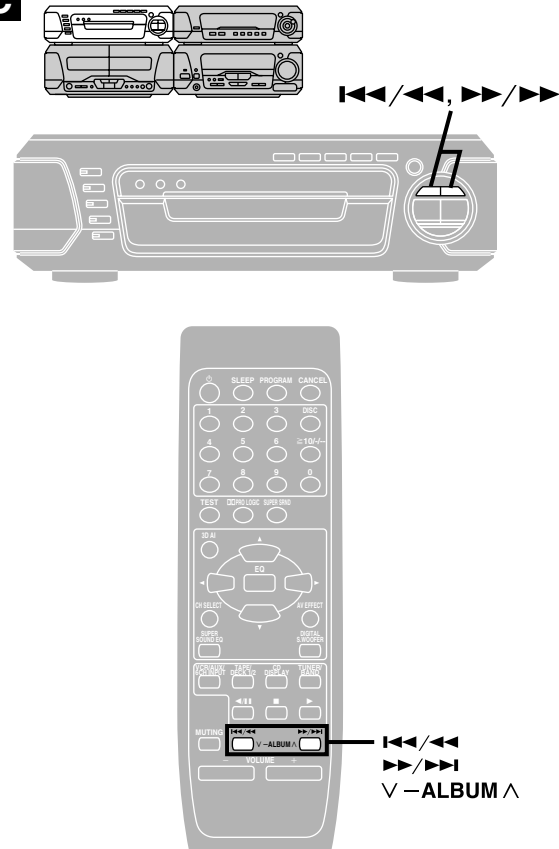

**CDs**

See page 8 for basic CD play.

**A CD selection**

Choose discs with this mark (a).

**Note on CD-R and CD-RW**

This unit can play CD-R/RW (audio recording disc) recorded with CD-DA, WMA (SC-EH790) or MP3 (SC-EH790). Finalize\* the disc after recording.  
\*A process that allows play on compatible equipment.

**EH790**

See page 14 for details about WMA and MP3.

**Do not;**

- use irregularly shaped discs (b).
- attach extra labels and stickers.
- use discs with labels and stickers that are coming off or with adhesive exuding from under labels and stickers (c).
- attach scratch-proof covers or any other kind of accessory.
- write anything on the CD.
- clean CDs with liquids. (Wipe with a soft, dry cloth.)
- use CDs printed with label printers available on the market.

**B To prevent damage**

Always observe the following points.

- Load only 1 CD per tray (a).
- Load CDs as shown in figure (e).
- An adaptor is not needed with 8 cm CDs (singles).
- Set the system on a flat, level surface.
- Always unload all CDs before moving the system.

**Do not;**

- set it on top of magazines, inclined surfaces, etc.
- move the system while tray is opening/closing, or when loaded.
- put anything except CDs in trays.
- use cleaning CDs or CDs which are badly warped or cracked.

**C Skipping and searching through tracks**

**Skipping tracks**

Press [REVERSE] (backward), or [SKIP] (forward).

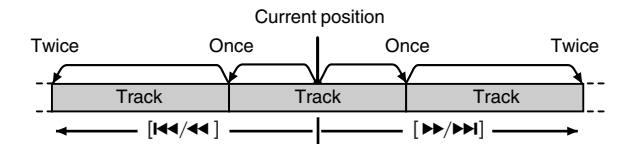

**Skipping albums EH790 (WMA/MP3 only)**

Press and hold [REVERSE] (backward), or [SKIP] (forward) on the main unit.

Press and hold [-ALBUM (∨ or ∧)] on the remote control.

**Searching through tracks**

**During play**

Press and hold [REVERSE] (backward), or [SKIP] (forward).

**Note**

- Skipping is done in the selected order in program play (→ page 15).
  - You cannot skip to tracks already played in random play (→ page 16).
  - You can search only within tracks in program and random play.
- EH790 (WMA/MP3 only)**
- You cannot search through tracks.



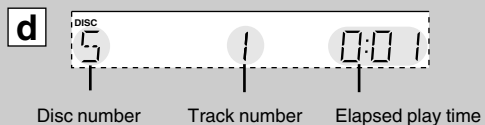
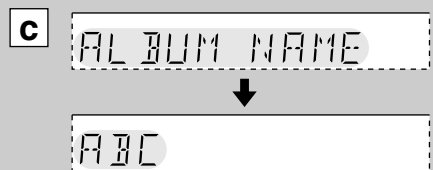
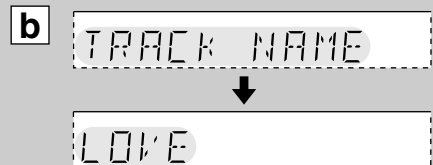
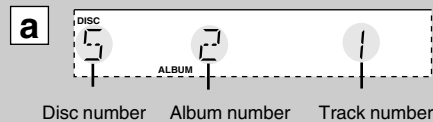
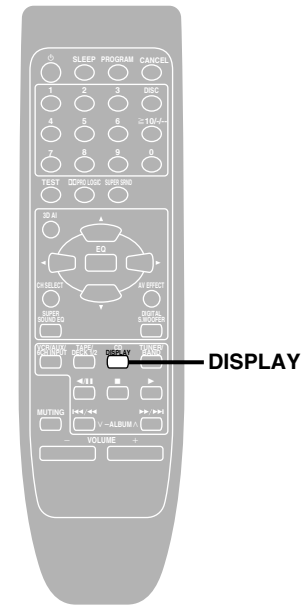

CDs

**EH790** (WMA/MP3 only)

**Changing the display**

**Remote control only**

**During play**  
Press **[DISPLAY]**.

The display will change as follows.

- a** Disc number, album number and track number
- b** Track name (Example: Track name is "LOVE".)
- c** Album name (Example: Album name is "ABC".)
- d** Disc number, track number and elapsed play time (Normal display)

**To display the root (names of albums above the current one)**

Press and hold **[DISPLAY]** during play. "ROOT", name(s) of album(s) above the current one, current album name and track name scroll across the display. Root also appears when you move to another track (only when the display mode **b** or **c** above is selected).

**Note**

The unit displays up to 12 characters each for album/track name.

**WMA and MP3 information**

- Discs must conform to ISO9660 level 1 or 2 (except for extended formats).
- This unit is compatible with multi-session but if there are a lot of sessions it takes more time for play to start. Keep the number of sessions to a minimum to avoid this.

**Notes on WMA only**

- Noise may occur when playing WMA files.
- When creating a WMA disc, ensure the copyright feature is off.

**Notes on MP3 only**

- This unit is not compatible with ID3 tags.
- This unit is not compatible with files with a sampling rate of 32 kHz.
- If you play an MP3 track that includes still picture data, it will take some time before the music itself starts playing and the elapsed time will not be displayed during this time. Even after the track starts, the correct play time will not be displayed.

**Order of play**

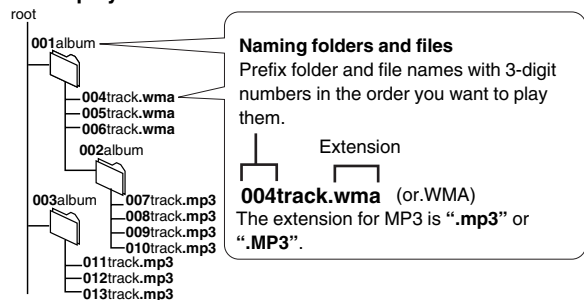

MPEG Layer-3 audio decoding technology licensed from Fraunhofer IIS and Thomson multimedia.

Windows Media, and the Windows logo are trademarks, or registered trademarks of Microsoft Corporation in the United States and/or other countries.

WMA is a compression format developed by Microsoft Corporation. It achieves the same sound quality as MP3 with a file size that is smaller than that of MP3.



CDs

**Program play**

Select up to 24 tracks to play in the order you choose.

**Remote control only**

**Preparation:** Press **[CD]** to put the unit in CD mode.

**EH790** (WMA/MP3 only)

You can use program play only within a disc in the play position tray. Ensure a WMA/MP3 disc is in the play position tray.

- 1** Press **[PROGRAM]**.
- 2** **EH790**  
**A** For CD (CD-DA)  
① Press **[DISC]**.  
② Within 10 seconds or so Press **[1]-[5]** to select the disc.  
**B** For WMA/MP3  
Press and hold **[-ALBUM (∨ or ^)]** to select the album.
- 3** Select the track with the numbered buttons.  
To select a 2-digit number  
e.g. To select track 21, press  $[≧10/-/-] → [2] → [1]$   
To select a 3-digit number **EH790**  
e.g. To select track 123, press  $[≧10/-/-] → [≧10/-/-] → [1] → [2] → [3]$   
**EH790**  
Alternatively, press **[1<<</>>>]** or **[>>>/<<<]** then press **[PROGRAM]**.

Repeat steps 2 through 3 (SC-EH790) or step 3 (SC-EH590) to program additional tracks in the required order.

**4** Press **[▶]**.

**To cancel**

Press **[■]** while stopped.  
**EH590** Alternatively, press **[PROGRAM]**.  
All the tracks are canceled.

**"FULL" is displayed**

If 24 tracks have been programmed.

**"--:--" is displayed if;**

- total playing time for the tracks is over 99 minutes and 59 seconds.
- a track numbered 25 or over was programmed.
- a disc not in playing position was programmed (SC-EH790).
- a WMA/MP3 disc was programmed (SC-EH790).  
Tracks can still be programmed and played.

**To check the contents of the program**

- ① Press **[DISPLAY]** (SC-EH790) or **[CANCEL]** (SC-EH590).
- ② Press **[1<<</>>>]** or **[>>>/<<<]**. Each time you press the button, the contents of the program are displayed.
- ③ **EH590** After the playing time appears on the display, press **[CANCEL]**.

**To add to the end of the program**

Repeat steps 2 and 3 (SC-EH790) or step 3 (SC-EH590).

**To cancel tracks**

The last track (SC-EH790)	Press <b>[CANCEL]</b> .
A particular track	1. Press <b>[DISPLAY]</b> (SC-EH790) or <b>[CANCEL]</b> (SC-EH590). 2. Select the track with <b>[1&lt;&lt;&lt;/&gt;&gt;&gt;]</b> or <b>[&gt;&gt;&gt;/&lt;&lt;&lt;]</b> then press <b>[CANCEL]</b> . 3. <b>EH590</b> Press <b>[CANCEL]</b> again.
All tracks	Cancel program play (see above).

**To program the track you are listening to [CD (CD-DA) only]**

Press **[PROGRAM]**. The program mode engages and the current track is automatically recorded as program No. 1.

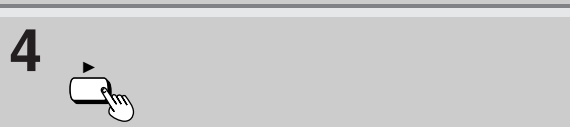
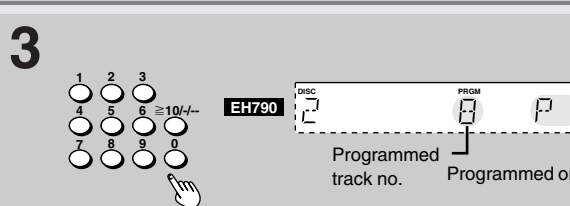
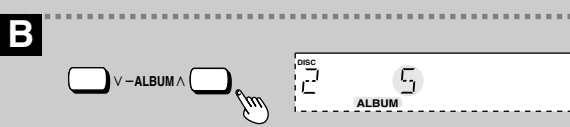
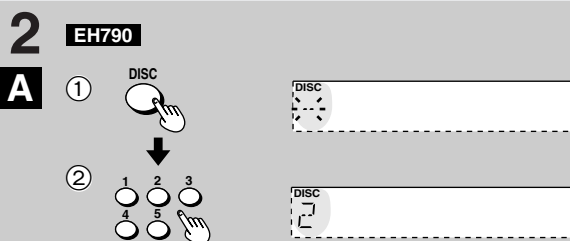
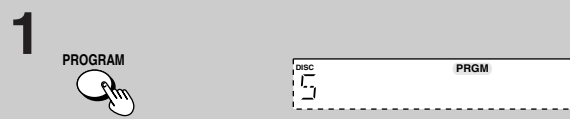
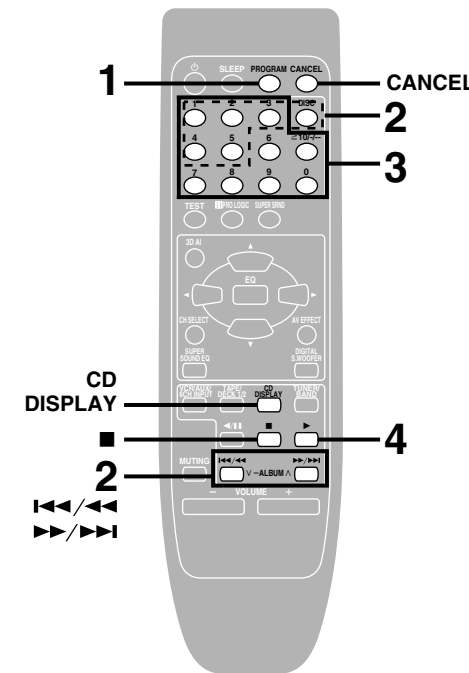



**A**

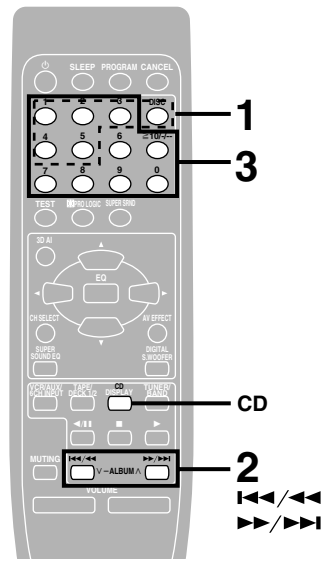

**1** **EH790**  
 ① Press [DISC].  
 ② Press [1]-[5] to select the disc.

**2** **EH790**  
 Press [V-ALBUM ^] to select the album.

**3**  
 Select the track with the numbered buttons.

**EH790** **RANDOM REPEAT**

**EH590** **RANDOM REPEAT**

**INPUT SELECTOR**

**B** **EH790** **EH590**  
 Press [RANDOM].

**C** **EH790** **EH590**  
 Press [REPEAT].

**CDs**

**Preparation:** Press [CD] on the remote control or [INPUT SELECTOR] on the tuner/amplifier to select "CD".

**A Direct access play**

**EH790**  
Starts normal play from a selected track on a selected disc to the last track of the final disc (→ page 8).

**EH590**  
Starts normal play from a selected track to the last track.

**Remote control only**

- EH790**  
 ① Press [DISC].  
 ② Within 10 seconds or so Press [1]-[5] to select the disc.
- EH790** (WMA/MP3 only)  
 Press and hold [-ALBUM (v or ^)] to select the album.
- Select the track with the numbered buttons.  
 To select a 2-digit number  
 e.g. To select track 21, press [≥10/-/-]→[2]→[1]  
 To select a 3-digit number **EH790**  
 e.g. To select track 123, press [≥10/-/-]→[≥10/-/-]→[1]→[2]→[3]  
**EH790**  
 Alternatively, press [I<<</<<] or [▶▶/▶▶].

**B Random play**

**EH790**  
Plays the tracks on all discs once each in random order. (For WMA/MP3, you cannot use random play.)

**EH590**  
Plays the tracks once each in random order.

**Press [RANDOM].**

**To cancel**  
Press [RANDOM]. "RANDOM" goes out.

**For your reference:**  
In the program play mode (→ page 15), the programmed tracks are played randomly.

**C Repeat play**

**EH790**  
Repeats all tracks on all discs or all programmed tracks.

**EH590**  
Repeats all tracks or programmed tracks.

**Press [REPEAT] before or during play.**

**To cancel**  
Press [REPEAT]. "↻" goes out.

- To repeat only your favourite track(s)**
- Program the track(s) you want (→ page 15).
  - Press [REPEAT] and make sure "↻" is displayed.
  - Press [>]. Play will start.

**The radio: manual tuning**

Radio stations can be tuned manually by selecting the station's frequency or they can be preset into channels to make it easy to tune (→ page 18).

**Preparation:** Press [⏻/⏹] to turn the unit on.

- Press [TUNER/BAND] to select FM or AM.  
Each time you press the button: FM↔AM
- Press [TUNING MODE] to select "MANUAL".  
Each time you press the button: MANUAL↔PRESET
- Press [TUNING (v or ^)] to tune in the desired broadcast.

If you press and hold [TUNING (v or ^)] for a moment, the frequency starts changing automatically. It stops when a station is found. It may also stop if there is outside interference. Press and hold [TUNING (v or ^)] again to restart. You can also stop the frequency changing by pressing [TUNING (v or ^)].

"TUNED" is displayed when a radio station is tuned. "ST" is displayed when a stereo FM broadcast is being received.

- Adjust the volume.

**A If noise is excessive in FM**

Press [FM AUTO/MONO] to display "MONO". This mode improves sound quality if reception is weak for some reason but broadcasts are heard in monaural. Press [FM AUTO/MONO] again to cancel the mode. "MONO" goes out. MONO is also canceled if the frequency is changed.

Turn off "MONO" for normal listening. Stereo and monaural broadcasts are automatically played as they are received.

Stations can be preset in monaural. Carry out presetting manually (→ page 18).

**B RDS broadcasting**

**EH790 for the United Kingdom and Eastern Europe**  
**EH590**

This unit can display the text data transmitted by the radio data system (RDS) available in some areas. If the station you are listening to is transmitting RDS signals, "RDS" will light up on the display.

**Displaying the text data**  
Press [PS-DISP MODE] to display a station name. Press [DISP MODE-PTY] to display a program type. Each time you press the button: Frequency display↔PS or PTY display

**Note**  
RDS displays may not be available if reception is poor.  
\* "M.O.R M" = "Middle of the road music"

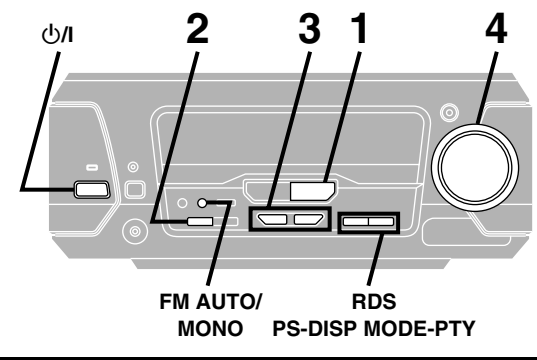
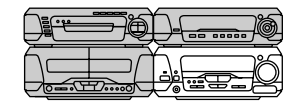

**1** TUNER/BAND  
 FM 87.50 MHz

**2** TUNING MODE  
 MANUAL

**3** TUNING (v or ^)  
 FM 88.10 MHz  
 TUNED  
 ST

**4** VOLUME  
 UP DOWN  
 VOLUME -48 dB  
 MIN MAX

**A** FM AUTO/MONO  
 FM 88.10 MHz  
 MONO

**B** RDS PS  
 PS - DISP MODE - PTY  
 RDS PS  
 BAYERN 1  
 RDS PTY  
 NEWS

**PTY displays**

NEWS	VARIED	FINANCE	COUNTRY
AFFAIRS	POP M	CHILDREN	NATIONAL
INFO	ROCK M	SOCIAL A	OLDIES
SPORT	M.O.R M*	RELIGION	FOLK M
EDUCATE	LIGHT M	PHONE IN	DOCUMENT
DRAMA	CLASSICS	TRAVEL	TEST
CULTURE	OTHER M	LEISURE	ALARM
SCIENCE	WEATHER	JAZZ	

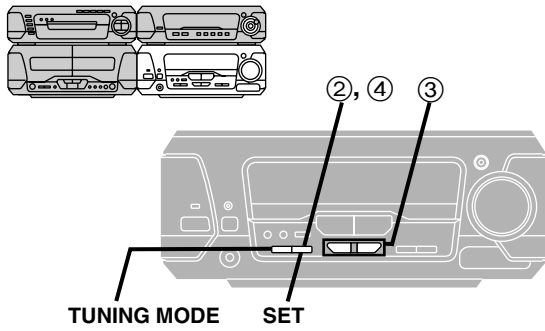

### The radio: preset tuning

There are two methods of presetting stations.  
**Automatic presetting:** The stations the tuner can receive are preset.  
**Manual presetting:** You can select the stations to preset and the order they are preset in.  
There are 39 channels available for presetting.

#### A Automatic presetting

Do the following once each for FM and AM.  
**Preparation:** Tune to the frequency presetting is to begin at (→ page 17).  
**Hold down [SET].**

Release the button when "AUTO MEMORY" appears.  
The tuner presets all the stations it can receive into the channels in ascending order. FM stations are preset into channels 1 to 39, and AM stations are preset into channels 21 to 39.  
"SET OK" is shown when presetting is complete and the last station to be preset is played.  
"ERROR" is displayed if the tuner doesn't receive any stations. Do presetting manually if this happens (see below).

**Note**  
AM stations replace any FM channels that were preset in channels 21 to 39.

#### B Manual presetting

Preset the stations one at a time.

- ① Tune to the required station.
- ② Press [SET].
- ③ Press [TUNING (∨ or ∧)] to select a channel.
- ④ Press [SET].

The station occupying a channel is erased if another station is preset in that channel.

#### C Selecting channels

**Preparation:** Press [⏻] to turn the unit on.

**On the remote control**

- 1 Press [TUNER/BAND].
- 2 Press the numbered buttons to select the channel.  
For channels 1 to 9 press the corresponding number.  
For channels 10 or over press [≥10/---], then the two digits.  
e.g. To select channel 21: [≥10/---]→[2]→[1]
- 3 Adjust the volume.

**On the main unit**

- ① Select "PRESET" with [TUNING MODE].
- ② Press [TUNING (∨ or ∧)] to select the channel.

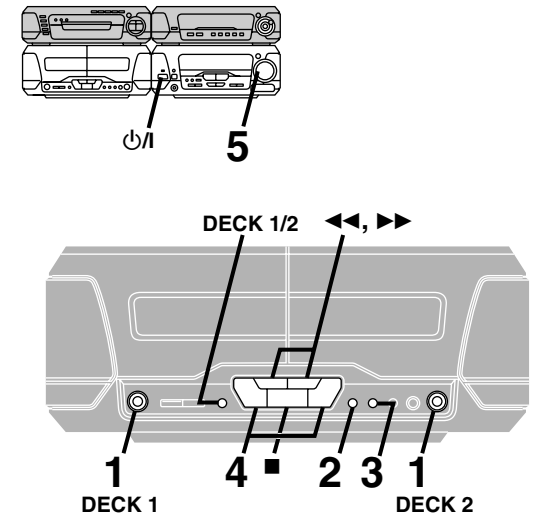
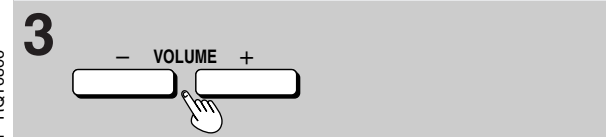
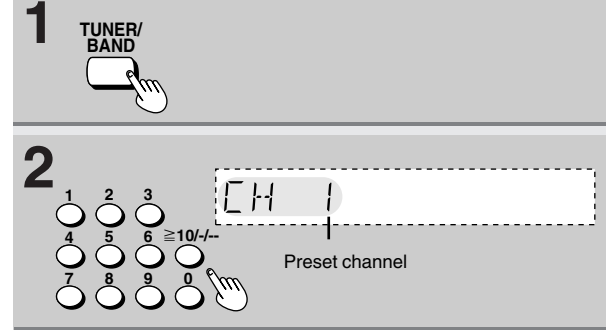
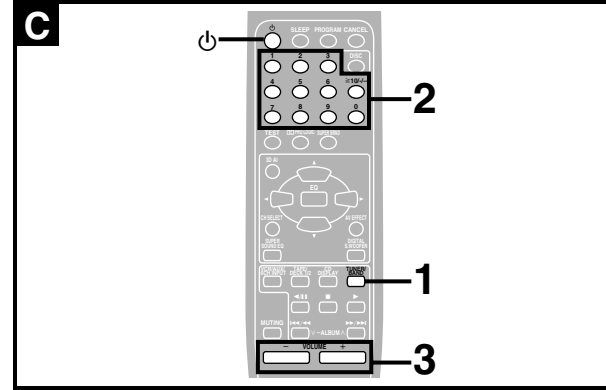
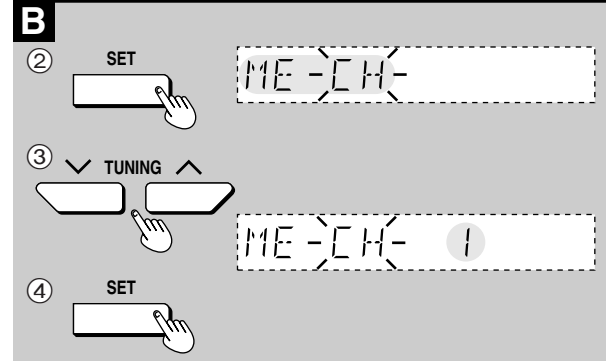
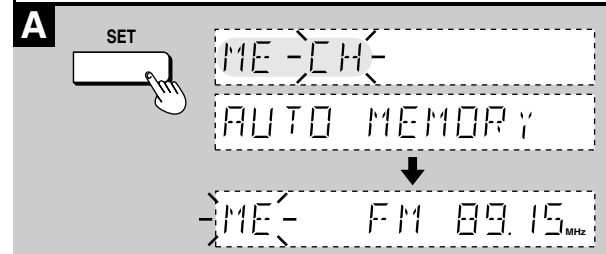

### Cassette tapes

See page 39 for tape selection.

**Preparation:** Press [⏻/⏹] to turn the unit on.

- 1 Press [▲ OPEN] on deck 1 or deck 2 and insert the cassette.  
Close the holder by hand.
- 2 Press [DOLBY NR] to select Dolby NR on ("DOLNR" appears) or off.
- 3 Press [REV MODE] to select the reverse mode.  
Each time you press the button:  
→ One side is played.  
↔ Both sides are played.  
↻ Both sides are played 8 times each.
- 4 Press [◀] (reverse side) or [▶] (forward side).  
Play begins and the indicator changes to green.
- 5 Adjust the volume.

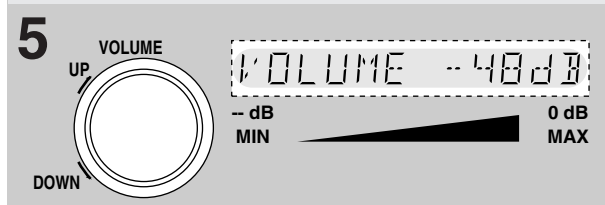
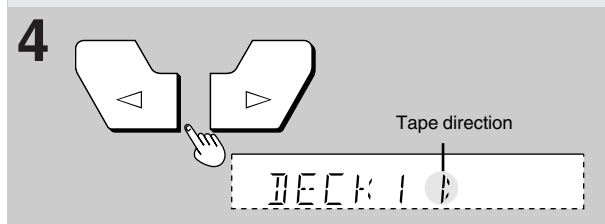
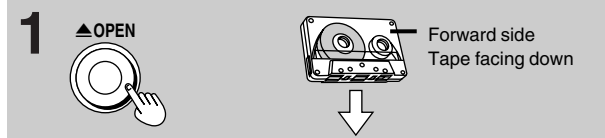

#### To stop the tape

Press [■].

#### A To change the deck to be used

Press [DECK 1/2] to select the deck you want to play.

#### To listen to 2 tapes consecutively

Insert a tape into each deck and select "↻". Both tapes will be played 8 times each.

#### B Finding a place on a tape

**To fast-forward and rewind**  
Press [◀◀] or [▶▶] while the tape is stopped.

**To find the beginning of a track (TPS: Tape program sensor)**  
Press [◀◀] or [▶▶] during play.  
Play resumes from the beginning.

Tape direction	rewind	fast-forward
▶	◀◀	▶▶
◀	▶▶	◀◀

- Each deck's play direction is stored in the system's memory.
- You can fast-forward or rewind the tape while you are playing or recording a tape in another deck.  
Press [DECK 1/2] to switch to the deck not playing, and then press [◀◀] or [▶▶]. After the above operation, be sure to press [DECK 1/2] to reselect the deck playing.

#### Note

TPS may not operate correctly in the following situations:  
If the interval between tracks is less than 4 seconds.  
If there is noise between tracks.  
If there are silent parts within tracks.

#### Dolby noise reduction

Dolby NR reduces "hissing" when playing tapes. It increases the high frequency region when recording and then reduces it in playback. Use the same system during playback and recording. This unit has Dolby B NR which reduces noise to a third.  
Prerecorded cassettes and equipment marked "DOLNR" use Dolby B NR.

Manufactured under license from Dolby Laboratories.  
"Dolby" and the double-D symbol are trademarks of Dolby Laboratories.

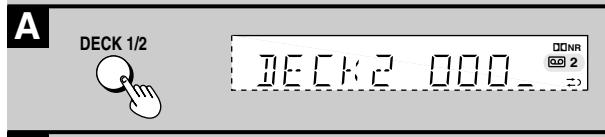

Using the acoustic image equalizer (AI EQ)

Achieve subtle sound quality settings with the soft, sharp, heavy, and light coordinates.

**1** **EH790** Turn [MULTI JOG] to select "AI EQ".

**EH590** Press [AI EQ] to select "AI EQ".  
The indicator turns green.

**2** **EH790** Press [SUPER 3D AI EQ] to select the surround level.

Each time you press the button:  
AI EQ → SUPER 3D AI 1 → SUPER 3D AI 2

SUPER 3D AI 1: Adds a surround effect to the AI EQ.  
SUPER 3D AI 2: Adds a stronger surround effect to the AI EQ.

**3** Change the sound quality with [◀, ▶, ▲, ▼].  
Adjust softness and sharpness with [◀, ▶].  
Adjust heaviness and lightness with [▲, ▼].  
The original display is restored on the display panel in about 5 seconds.

To cancel

**EH790** Turn [MULTI JOG] to select "FLAT".  
**EH590** Press [FLAT]. The indicator turns off.

The changes you make are stored and automatically recalled the next time you select AI EQ.

Note

- EH790** Turn off the effect if sound quality reduces when using SUPER 3D AI EQ with a source.
- You cannot select "SUPER 3D AI 1" or "SUPER 3D AI 2" while:
  - Using a surround system (⇒ page 23)
  - Karaoke mode is on (SC-EH790 for Australia and N.Z. only ⇒ page 35)
  - Listening to the radio
  - Using headphones

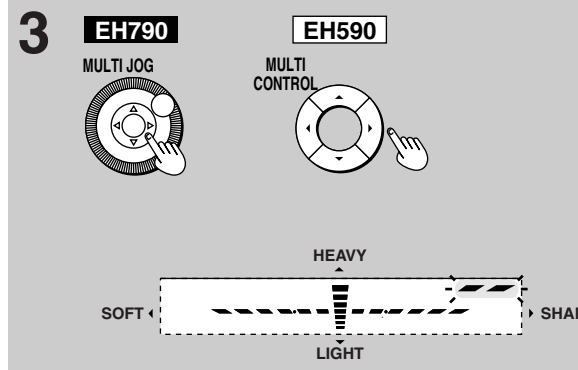
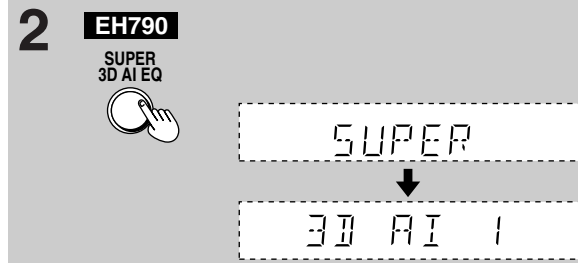
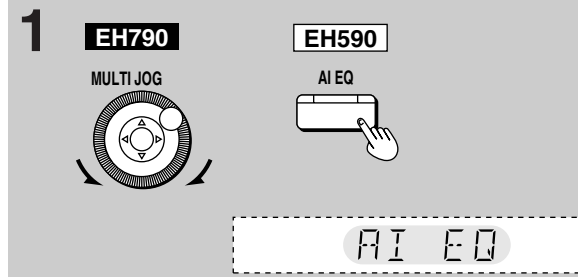
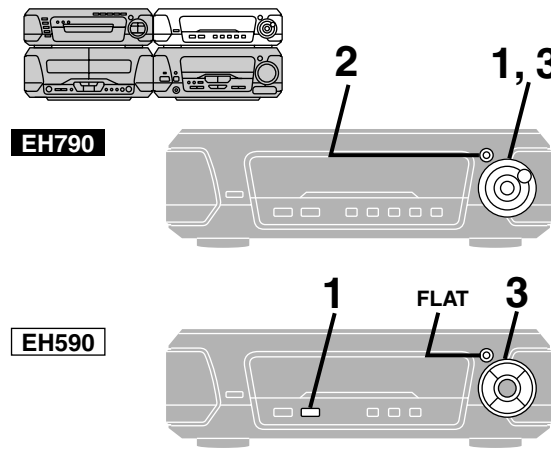

**A** Boosting the super woofer

Boosting the super woofer adds power to the bass.

Press [DIGITAL S.WOOFER].

The indicator turns green.  
Each time you press the button:  
MID (medium) → MAX (high) → cancel (off)

There is only one level when listening through headphones.

To cancel

Press [DIGITAL S.WOOFER] to turn the indicator off.

**B** Using the super sound equalizer

Turning on the super sound equalizer gives you a more powerful sound.

Press [SUPER SOUND EQ].

The indicator turns green.

To cancel

Press [SUPER SOUND EQ] so the indicator turns orange (SC-EH790) or turns off (SC-EH590).

**C** Changing sound field and quality

**EH790**

Turn [MULTI JOG] to select a setting.

- Each time you turn:
- HEAVY: Adds punch to rock.
  - CLEAR: Clarifies higher sounds.
  - SOFT: For background music
  - HALL: Expands sound to make you feel like you were in a hall.
  - AI-EQ: Adjust sound with the acoustic image equalizer (⇒ page 21).
  - M.EQ: Create your own effects (⇒ page 22).
  - FLAT: Canceled (no effect is added).

**EH590**

Press [EQ] to select a setting.

- Each time you press the button:
- HEAVY: Adds punch to rock.
  - CLEAR: Clarifies higher sounds.
  - SOFT: For background music

On the remote control

Press [EQ].

To cancel

**EH790** Turn [MULTI JOG] to select "FLAT".  
**EH590** Press [FLAT].

Note

**EH790** Turn off the effect if sound quality reduces when using HALL with a source.

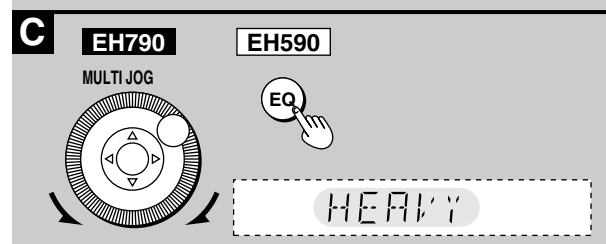
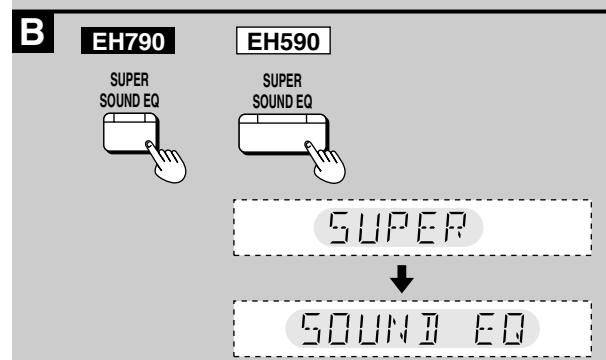
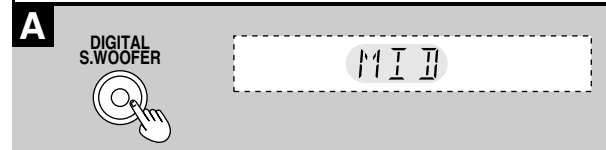
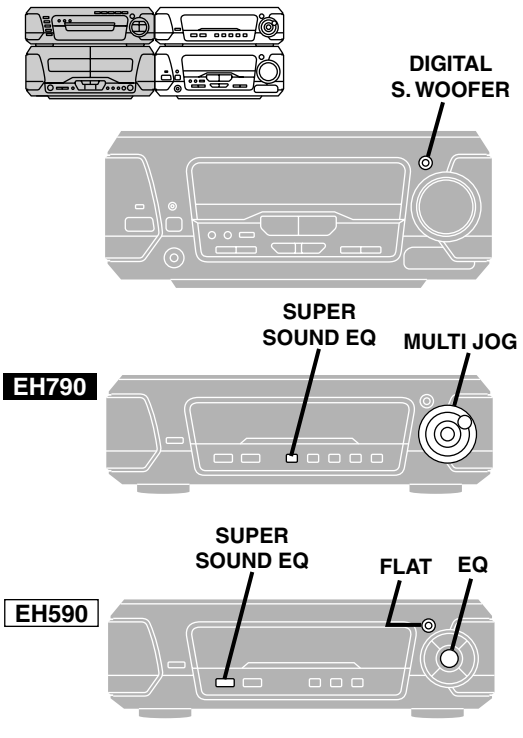

Using the manual equalizer (M.EQ)

Create your own sound quality effects. SC-EH590 has three manual equalizers.

**1** **EH790** Turn [MULTI JOG] to select "MANUAL".

**EH590** Press [M1], [M2], or [M3] to select the equalizer you want to set. The indicator turns green.

**2** Change the sound quality with [◀], [▶], [▲], [▼].

- ① Select the sound range to be adjusted with [◀] or [▶].
- ② Adjust the level with [▲] or [▼].

Repeat step 2 to set the desired sound quality. The original display is restored on the display panel in about 5 seconds.

To cancel

**EH790** Turn [MULTI JOG] to select "FLAT".

**EH590** Press [FLAT]. The indicator turns off.

Note

The changes you make are stored and automatically recalled the next time you select the manual equalizer.

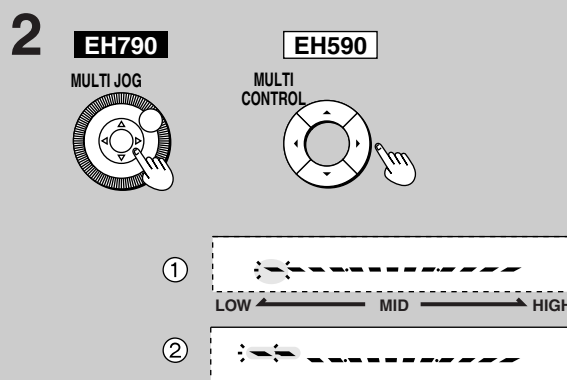
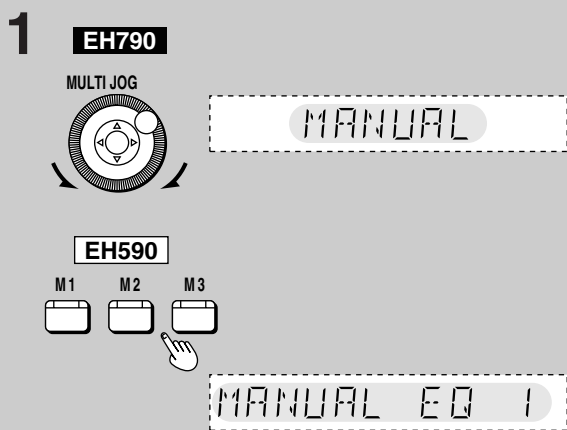
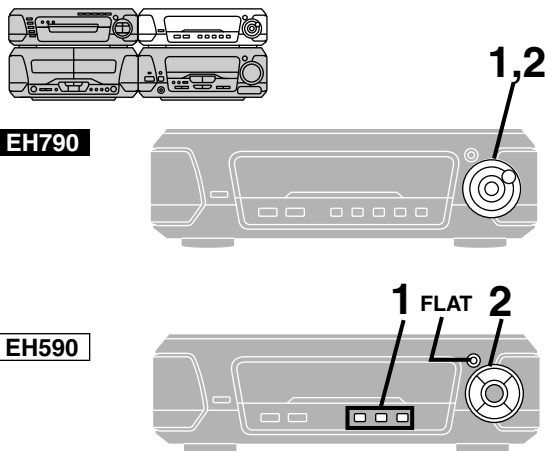

EH790

The following chart gives a summary of this unit's surround features. It also shows additional effects that can be used to enhance your enjoyment.

Note

- All the features are only effective if speakers are used. No discernible effect will be heard through headphones.
- You may experience a reduction in sound quality when these surround systems and effects are used with some sources. If this occurs, turn the surround system or effect off.

When you turn on one of the surround systems, the indicator for the additional effects you can use also light.

"DTS", "DTS Digital Surround" and "DTS Digital Out" are registered trademarks of Digital Theater Systems, Inc.

Manufactured under license from Dolby Laboratories. "Dolby", "Pro Logic" and the double-D symbol are trademarks of Dolby Laboratories.

Surround system	Features	Software	Additional effects See below for details.				
<b>6CH DISCRETE INPUT</b> (⇒ page 24)	<ul style="list-style-type: none"> <li>•Use this input selector to enjoy 5.1 channel sources (e.g. Dolby Digital or DTS) played on a DVD player with 5.1 channel output and a built in Dolby Digital/DTS decoder (⇒ page 36 for connection, page 24 for operation).</li> <li>•Connect a subwoofer (not included) to the SUBWOOFER terminal to enhance the surround effect (⇒ page 36).</li> </ul>	DVDs encoded with Dolby Digital or DTS can be identified with these marks.  See the manual for the equipment you have connected for details on the types of software you can use.	(A) Center focus (B) Virtual rear surround (C) Multi rear surround (D) Seat position				
<b>DOLBY PRO LOGIC</b> (⇒ page 24)	<ul style="list-style-type: none"> <li>•This unit has built-in Dolby Pro Logic circuitry so you can enjoy Dolby Surround.</li> <li>•Dolby Pro Logic is a decoding system that was developed to get a better sense of presence from sources encoded with Dolby Surround. The feeling of position has been improved by the addition of a separate center speaker channel.</li> <li>•If your DVD player only has 2-channel output, you can still enjoy surround sound when playing 5.1 channel software by using Dolby Pro Logic.</li> </ul>	Software encoded with Dolby Surround can be identified with this mark.  <ul style="list-style-type: none"> <li>•DVD</li> <li>•Laser Disc</li> <li>•Video tape</li> <li>•CD</li> </ul>	(A) Center focus (B) Virtual rear surround (C) Multi rear surround (D) Seat position				
<b>SUPER SURROUND</b> (⇒ page 24)	<table border="0"> <tr> <td><b>MOVIE</b></td> <td> <ul style="list-style-type: none"> <li>•This mode adds surround effects to movie software that hasn't been recorded with the above systems.</li> <li>•In MOVIE mode you can adjust the volume of the surround speakers to get the best surround effect.</li> </ul> </td> </tr> <tr> <td><b>MUSIC</b></td> <td>This mode adds surround effects to stereo sources.</td> </tr> </table>	<b>MOVIE</b>	<ul style="list-style-type: none"> <li>•This mode adds surround effects to movie software that hasn't been recorded with the above systems.</li> <li>•In MOVIE mode you can adjust the volume of the surround speakers to get the best surround effect.</li> </ul>	<b>MUSIC</b>	This mode adds surround effects to stereo sources.	Any stereo sound source except for the radio. <ul style="list-style-type: none"> <li>•Video tape</li> <li>•CD</li> <li>•Tape</li> </ul>	(B) Virtual rear surround (C) Multi rear surround (D) Seat position
<b>MOVIE</b>	<ul style="list-style-type: none"> <li>•This mode adds surround effects to movie software that hasn't been recorded with the above systems.</li> <li>•In MOVIE mode you can adjust the volume of the surround speakers to get the best surround effect.</li> </ul>						
<b>MUSIC</b>	This mode adds surround effects to stereo sources.						

Additional effects

**(A) Center focus** (⇒ page 26)

- This mode makes it seem like the sound from the center speaker is coming from within the television.
- The center speaker should be placed above the television.

**(C) Multi rear surround** (⇒ page 26)

This mode makes it seem like there are multiple surround speakers in your room, increasing the cinema-like atmosphere.

Virtual speakers

**(B) Virtual rear surround** (⇒ page 26)

- This mode is useful if you have to place your surround speakers near the front speakers due to the layout of your room.
- This mode makes it seem like the sound from the surround speakers is coming from behind you.

Virtual speakers

**(D) Seat position** (⇒ page 27)

This mode helps maintain the sound position even if the listening position itself is changed.



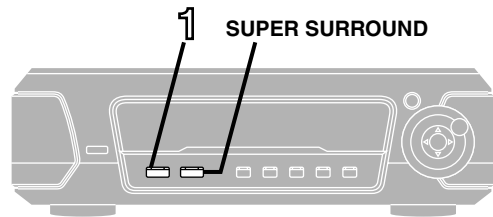
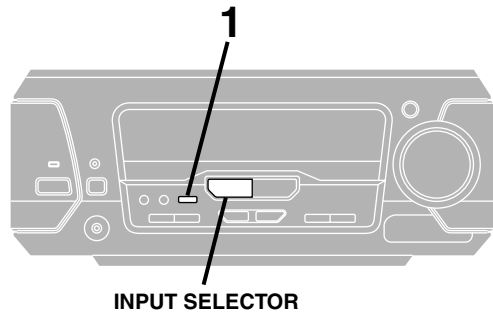
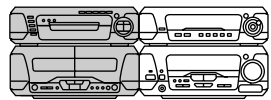

### A

1



### B

1

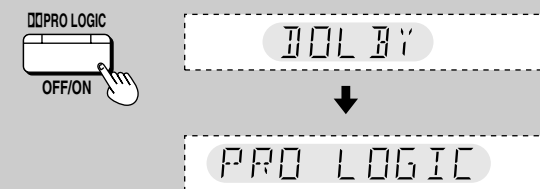

### C

1



## Enjoying surround sound

EH790

See page 25 for speaker level adjustments.

### A 6CH DISCRETE INPUT

**Preparation:** Connect a DVD player with a built in Dolby Digital or DTS decoder (→ page 36).

- 1 Press [6CH DISCRETE INPUT].
- 2 Playback a Dolby Digital or DTS source.

#### On the remote control

Press [VCR/AUX/6CH INPUT] to select "6CH INPUT".

#### To cancel

Press [INPUT SELECTOR] to select another source.

#### Note

You cannot record or enjoy karaoke (For Australia and N.Z.) when you are using 6CH DISCRETE INPUT. To record or enjoy karaoke with DVDs, ensure the DVD player is also connected to the AUX (DVD) terminals and select "AUX (DVD)" with [INPUT SELECTOR] (→ page 37).

### B DOLBY PRO LOGIC

- 1 Press [DOLBY PRO LOGIC, OFF/ON].  
The indicator turns green.
- 2 Playback a Dolby Surround source.

#### To cancel

Press [DOLBY PRO LOGIC, OFF/ON] so the indicator turns off.

### C SUPER SURROUND

Press [SUPER SURROUND] and select "MOVIE" or "MUSIC".

The indicator turns green.

Each time you press the button:

MUSIC → MOVIE → STEREO SOUND (off)

#### To cancel

Press [SUPER SURROUND] to select "STEREO SOUND".

The indicator turns off.

## Enjoying surround sound

EH790

### Speaker level adjustments

#### 6CH DISCRETE INPUT, DOLBY PRO LOGIC

If the level of the speakers appears to be different while listening to a source, adjust the level of the speakers to the same apparent level.

**6CH DISCRETE INPUT:** Adjust while listening to a surround source. If your DVD player is able to output a test signal, you can use it instead of playing a source.

**DOLBY PRO LOGIC:** Adjust while listening to a test signal.

**Preparation:** Set the volume level of the front speakers normally used for enjoying the source.

#### Remote control only

##### ① 6CH DISCRETE INPUT

Press [CH SELECT] to select the speaker.

The speaker channel changes each time you press the button.

##### DOLBY PRO LOGIC

Press [TEST].

A test signal is output from each speaker in order.

To stop the test signal, press [TEST] again.

Lch: Front left

Cch: Center

Rch: Front right

RSch: Right surround

LSch: Left surround

SWch: Subwoofer (6CH DISCRETE INPUT; only when connected)

•The surround channel for Dolby Pro Logic is monaural so the indicator appears as "Sch" instead.

② Press [▲] (to increase level) or [▼] (to decrease level).

##### SUPER SURROUND

While playing a source

1. Press [CH SELECT].

2. Press [▲] (to increase level) or [▼] (to decrease level).

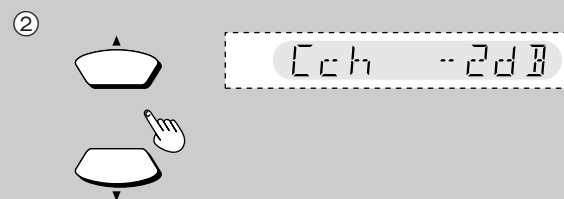
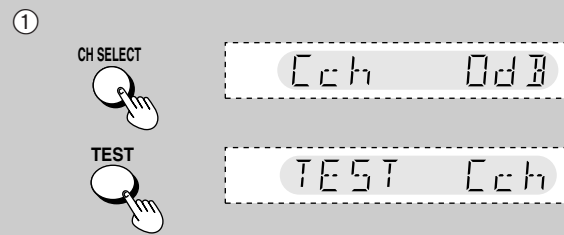
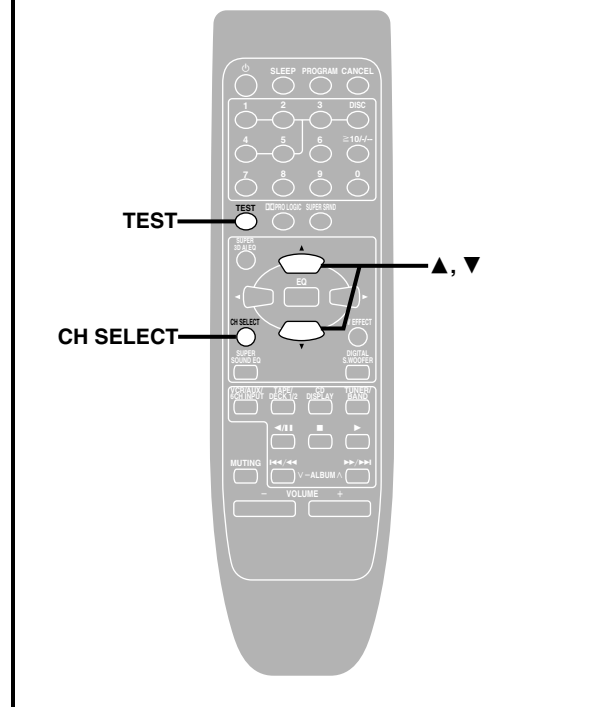

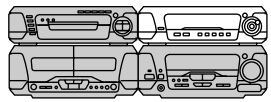

VIRTUAL REAR SURROUND

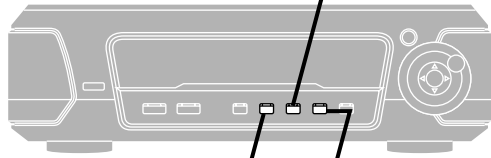

CENTER FOCUS

MULTI REAR SURROUND

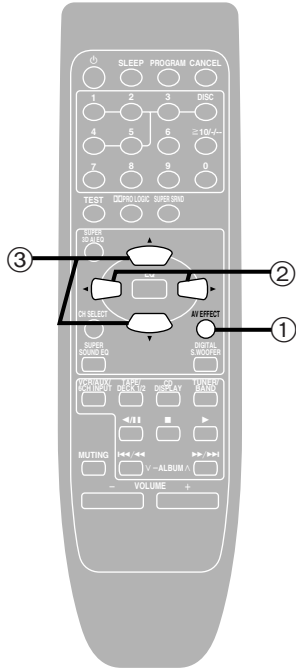

**A**



CENTER FOCUS

**B**



VIRTUAL REAR SURROUND

**C**



MULTI REAR SURROUND

**Surround effects**

**EH790**

These effects can be used with the surround systems described on page 24. Refer to the chart on page 23 for details on which effects can be used. These effects are available when the corresponding indicators are alight.

**A CENTER FOCUS**

Press [CENTER FOCUS].

The indicator turns green.

**To cancel**

Press [CENTER FOCUS] so the indicator turns orange.

**On the remote control**

- ① Press [AV EFFECT].
- ② Press [◀] or [▶] so the CENTER FOCUS indicator flashes.
- ③ Press [▲] (ON) or [▼] (OFF).

**B VIRTUAL REAR SURROUND**

Press [VIRTUAL REAR SURROUND].

The indicator turns green.

**To cancel**

Press [VIRTUAL REAR SURROUND] so the indicator turns orange.

**On the remote control**

- ① Press [AV EFFECT].
- ② Press [◀] or [▶] so the VIRTUAL REAR SURROUND indicator flashes.
- ③ Press [▲] (ON) or [▼] (OFF).

**C MULTI REAR SURROUND**

Press [MULTI REAR SURROUND].

The indicator turns green.

**To cancel**

Press [MULTI REAR SURROUND] so the indicator turns orange.

**On the remote control**

- ① Press [AV EFFECT].
- ② Press [◀] or [▶] so the MULTI REAR SURROUND indicator flashes.
- ③ Press [▲] (ON) or [▼] (OFF).

**Surround effects**

**EH790**

**SEAT POSITION**

**1 Press [SEAT POSITION].**

The indicator flashes green.

**2 While the indicator is flashing (within 10 seconds) Adjust the seat position with [◀, ▶, ▲, ▼].**

The indicator flashes for 10 seconds then lights green.

**To cancel**

1. Press [SEAT POSITION] so the indicator flashes.

2. Press [SEAT POSITION] again while the indicator is flashing so it turns orange.

**On the remote control**

- ① Press [AV EFFECT].
- ② Press [◀] or [▶] so the SEAT POSITION indicator flashes.
- ③ Press [▲] (ON).
- ④ Adjust the seat position with [◀, ▶, ▲, ▼].

To turn it off, after steps ① and ② press [▼] so the indicator turns orange.

**Note**

•The seat position is remembered by the unit and is reactivated when you turn seat position on again.

•When used with virtual rear surround, seat position is changed in 3 horizontal steps.

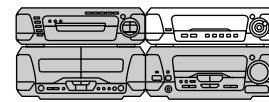
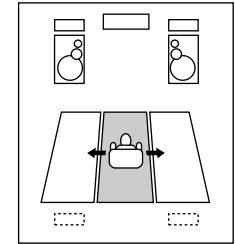

1 2

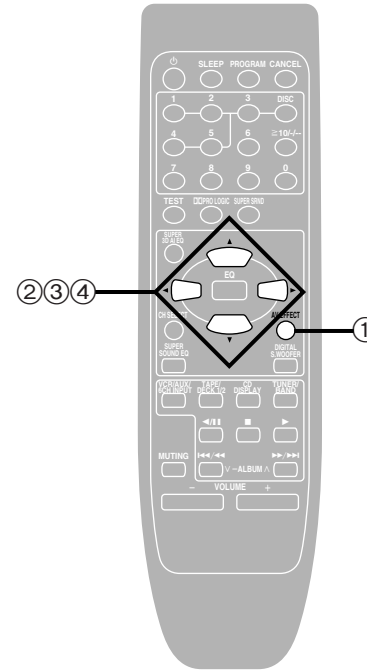
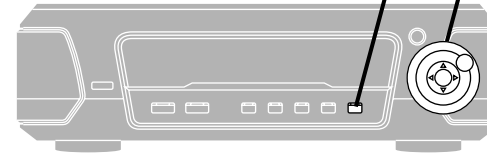

**1**

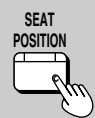

(On the sound processor)



SEAT → POSITION

**2**

MULTI JOG

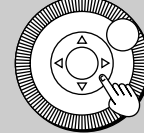

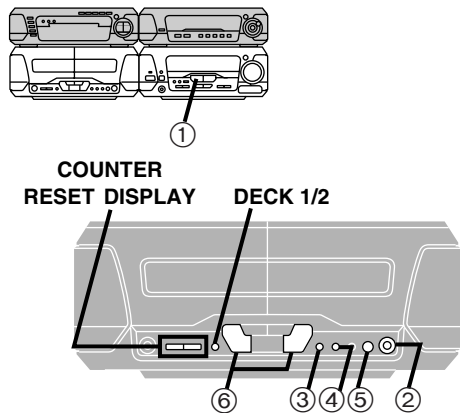
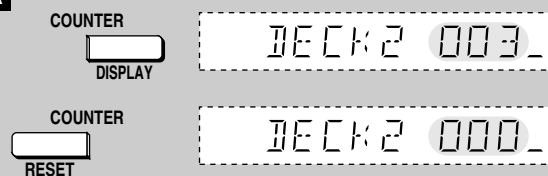
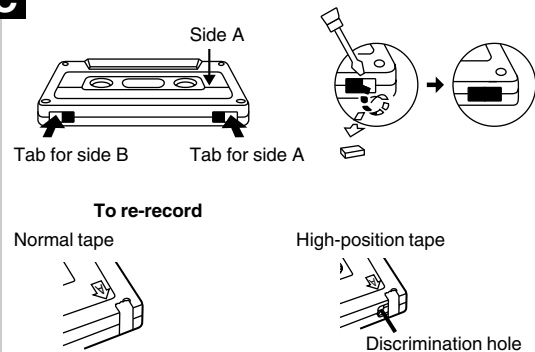
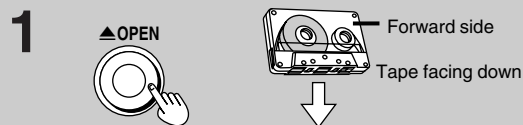
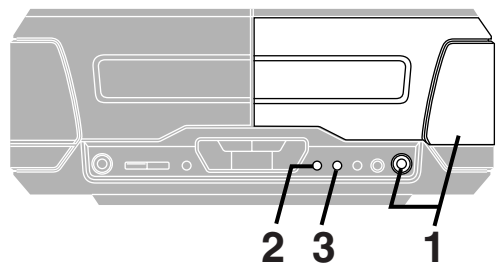
**A B****A****C****D****Before recording (Deck 2 only)**

See page 39 for tape selection.

**Note**  
**EH790**

You cannot record when [6CH DISCRETE INPUT] is selected.

Volume, sound quality and surround effects have no effect on recording. Sound quality and surround effects are automatically set to flat when recording.

**A To display the tape counter while recording**

Press [COUNTER DISPLAY].

The counter is displayed for about 5 seconds.

- Press [COUNTER RESET] to reset the counter.
- To display or reset the tape counter for deck 1, first press [DECK 1/2].

**B Erasing recordings**

- 1 Press [INPUT SELECTOR] to select "TAPE".
- 2 Insert the recorded tape into deck 2.
- 3 Press [DOLBY NR] so the "DOLBY NR" indicator goes out.
- 4 Select the reverse mode.
- 5 Press [● REC PAUSE].
- 6 Press [◀] or [▶].

**C Erasure prevention**

The illustration shows how to remove the tabs to prevent recording. To record on the tape again, cover as shown, being careful not to cover the high position discrimination hole.

Your attention is drawn to the fact that recording pre-recorded tapes or discs or other published or broadcast material may infringe copyright laws.

**D Preparatory steps**

Do these steps before each recording.

Wind up the leader tape so recording can begin immediately.

- 1 Press [▲ OPEN] on deck 2 and insert the cassette.  
Close the holder by hand.
- 2 Press [DOLBY NR] to select Dolby NR on ("DOLBY NR" appears) or off.  
(→ "Dolby noise reduction", page 19)
- 3 Press [REV MODE] to select the reverse mode.  
Each time you press the button:  
 - [↔]: One side only records.  
 - [↔] and [↔]: Both sides record (forward → reverse).  
 - [↔] automatically changes to [↔] when [● REC PAUSE], [EDIT] or [TAPE EDIT] is pressed.

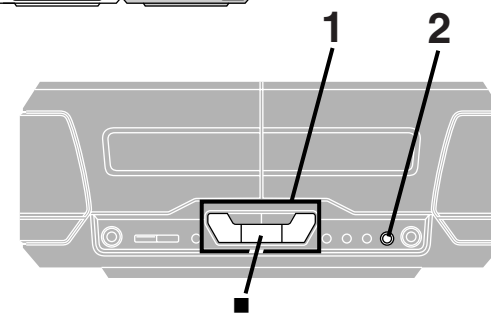
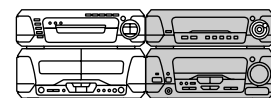
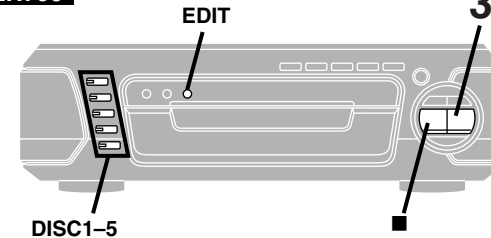
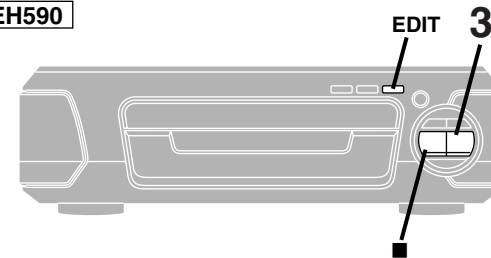
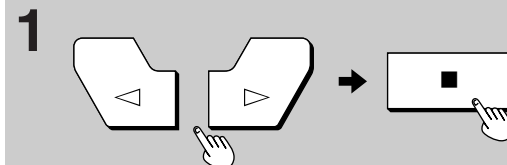
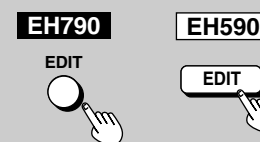
**EH790****EH590****A****B****Recording CDs**

Preparation:

- Do the preparatory steps (→ page 28).
- Insert the CD(s) you want to record (→ page 8).
- **EH790**  
Press [DISC, 1-5] on the CD changer to select the disc where you want to start recording, then press [■] to stop the disc.

**A Normal recording**

- 1 Press [◀] (reverse side) or [▶] (forward side) then [■] to set the tape direction.
- 2 Press [● REC PAUSE].  
The deck goes into the recording standby mode and the indicator "◀" or "▶" starts flashing.
- 3 Press [▶] on the CD changer or CD player.  
Recording starts automatically.

4 seconds after the CD(s) finishes, the deck goes into the recording standby mode.

**To stop recording**

EITHER

Press [■] on the CD changer or CD player.

The deck goes into the recording standby mode 4 seconds later.

OR

Press [■] on the deck.

Recording stops immediately but the CD continues to play.

**To record programmed tracks**

Program tracks before step 1 (→ page 15).

**B One touch CD editing**

This function makes it easier for you to record from discs.

- When recording, if a track is cut off in the middle at the end of the front side, it is recorded from the beginning on the reverse side. (Ensure the reverse mode "↔" is selected.)

- At the end of the reverse side recording stops and the current track will be interrupted.

After pressing [◀] or [▶] then [■] on the cassette deck to set the tape direction,

Press [EDIT].

Recording starts. In the meantime, "CD EDIT" will scroll across the display.

After edit-recording has finished, the cassette deck automatically stops.

**To stop editing**

Press [■] on the CD changer or CD player.

The cassette deck also stops. "EDIT OUT" scrolls across the display.

**To edit programmed tracks**

Program the tracks (→ page 15) and press [EDIT].

**A**

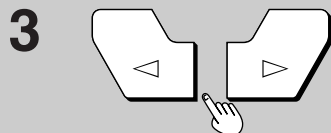
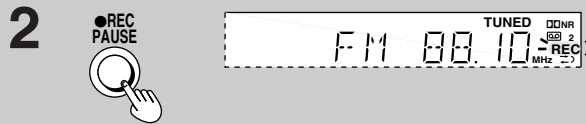
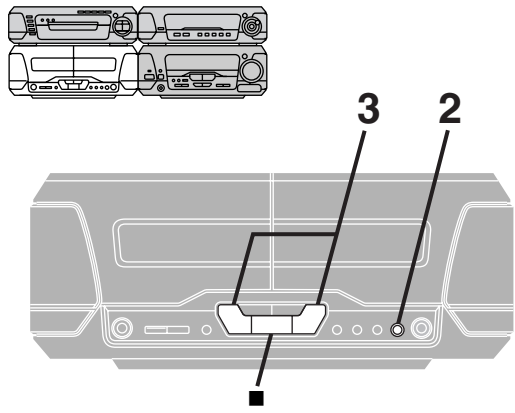

**B**

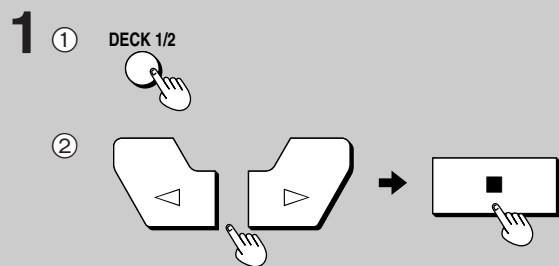
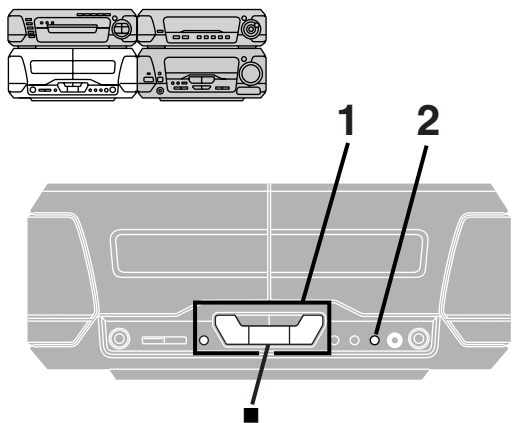

**A Recording the radio**

Preparation: Do the preparatory steps (⇒ page 28).

- 1 Tune to the required station.**  
(⇒ page 17 or 18)
- 2 Press [● REC PAUSE].**  
The deck goes into the recording standby mode and the play indicator “◀” or “▶” starts flashing.
- 3 Press [◀] (reverse side) or [▶] (forward side) to start recording.**

**To stop recording**

Press [■].

**To temporarily stop recording**

Press [● REC PAUSE].

The deck goes into recording standby mode.

To resume recording press [◀] or [▶] with the flashing indicator.

**B Tape-to-tape recording**

Preparation:

- Do the preparatory steps 1 and 3 (⇒ page 28).
- Insert the tape to be recorded in deck 1.

- 1 Set the tape direction on both decks.**
  - ① Press [DECK 1/2] to select “DECK 2”.
  - ② First press [◀] or [▶], and then [■].

Repeat steps ① and ② for deck 1.
- 2 Press [TAPE EDIT] to start recording.**  
The indicator “◀” or “▶” shows deck 2 direction.  
If either deck 1 or deck 2 stops, the other deck also stops.

**To stop recording**

Press [■].

Both decks will stop.

**To enjoy another source while recording**

Start playing the other sound source.

You can change the volume level and tone quality without affecting the recording.

**Note**

The recording level and the noise reduction effect of the original (playback) tape will be recorded on the new tape.

**Using the timers**

**The play timer**

This timer starts play of the selected source at the selected time. The example shows settings for preset radio channel 1 to play between 6:30 and 7:40 at -48 dB.

Preparation: Turn the unit on, set the time (⇒ page 12), preset radio stations if you want the timer to start playing the radio (⇒ page 18).

- 1** ① Press [CLOCK/TIMER] to select “ⓄPLAY”.

Each time you press the button:  
CLOCK→ⓄPLAY→ⓄREC→Original display

- ② Press [SET] within 3 seconds.

- 2 Follow these steps to set items ① to ④.**

- ① Press [TUNING (∨ or ∧)] to select the condition required and

- ② Press [SET].

- ① Start time
- ② Finish time
- ③ Source  
TUNER ↔ CD ↔ TAPE

Insert a CD or tape if you select these sources.

- If you select TUNER
- Select a preset channel.
- ④ Volume

The play timer is now on standby. The display shows each condition again then restores the original display.

- 3 Press [Ⓞ/Ⓞ] to turn the unit off.**

ⓄPLAY/ⓄREC indicator remains illuminated to show the play (or record) timer is on.

The timer starts at the set time with the volume increasing gradually to the set level.

**To cancel the timer**

Press [ⓄPLAY/ⓄREC] so “ⓄPLAY” goes out.

Each time you press the button:

ⓄPLAY→ⓄREC→ⓄPLAY ⓄREC→Light off (OFF)

The play timer will be canceled, but the settings stay in the memory.

**For your reference:**

When you insert cassettes in decks 1 and 2, deck 1 has priority.

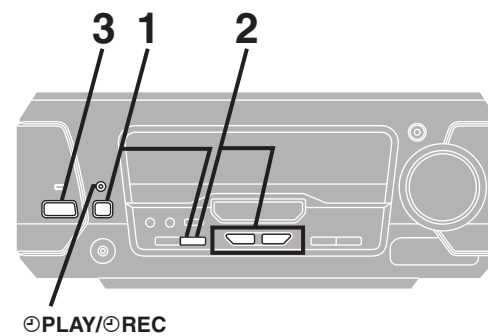
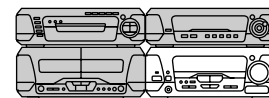

**1**



**2**

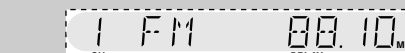
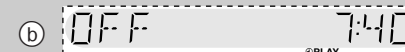
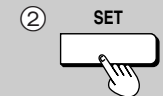
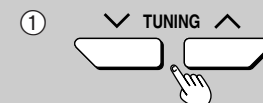

**3**

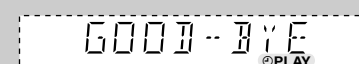



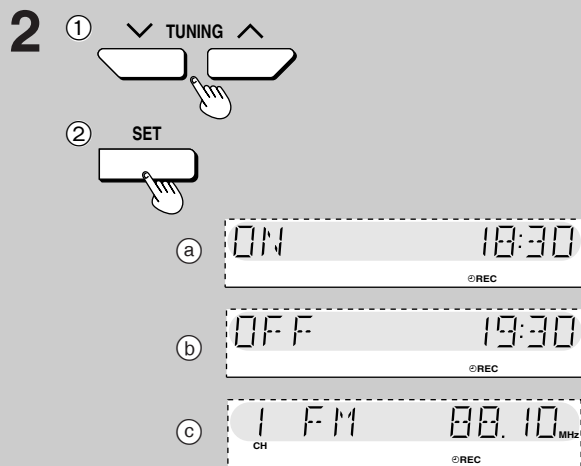
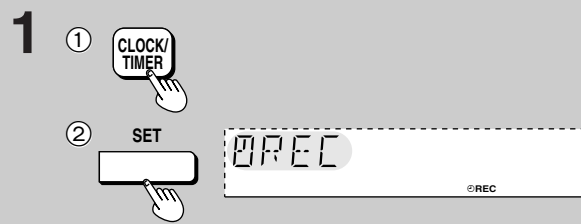
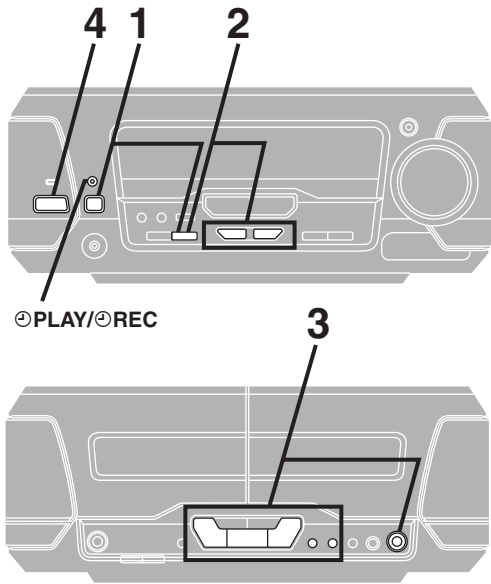
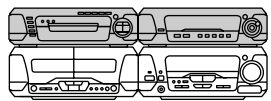

## Using the timers

### The record timer

This timer records the radio at the set time.  
The example shows settings for recording preset channel 1 from 18:30 to 19:30.

**Preparation:** Turn the unit on, set the time (→ page 12), preset radio stations (→ page 18).

- 1** **① Press [CLOCK/TIMER] to select “ⓄREC”.**  
Each time you press the button:  
CLOCK→ⓄPLAY→ⓄREC→Original display
- ② Press [SET] within 3 seconds.**
- 2 Follow these steps to set items (a), (b) and (c).**
  - ① Press [TUNING (∨ or ∧)] to select the condition required and**
  - ② Press [SET].**
    - a Start time**
    - b Finish time**
    - c Preset channel**

The record timer is now on standby. The display shows each condition again then restores the original display.

- 3 Prepare for recording.**
  - ① Insert a tape into deck 2.
  - ② Select the Dolby NR mode.
  - ③ Select the reverse mode.
  - ④ Select the tape direction.

- 4 Press [Ⓞ/I] to turn the unit off.**  
ⓄPLAY/ⓄREC indicator remains illuminated to show the record (or play) timer is on.

Recording starts 30 seconds before the set time with the volume muted during the set time.

#### To cancel the timer

Press [ⓄPLAY/ⓄREC] so “ⓄREC” goes out.  
Each time you press the button:  
ⓄPLAY→ⓄREC→ⓄPLAY ⓄREC→Light off (OFF)

The record timer will be canceled, but the settings stay in the memory.

## A

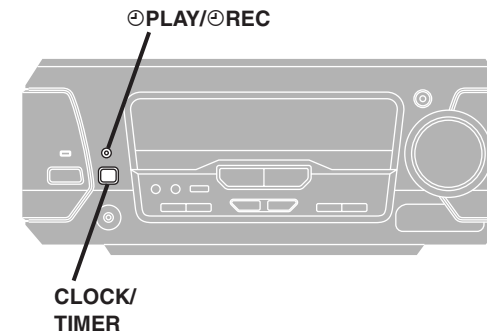
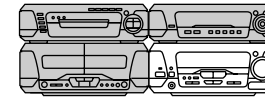

## B

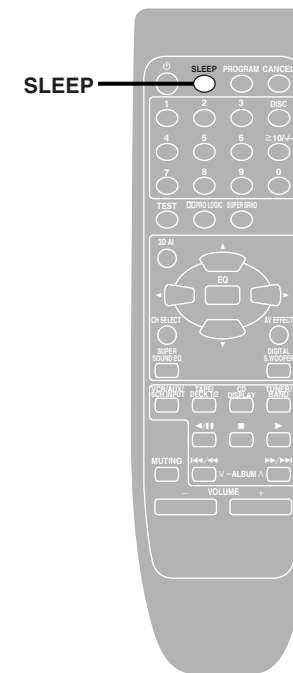

## Using the timers

### A The play and record timers

#### Turning the timers on and off

The timers come on at the set times if the ⓄPLAY/ⓄREC indicator is on. They can be turned on and off by pressing [ⓄPLAY/ⓄREC].

#### Checking the timers

Press [CLOCK/TIMER] to select “ⓄPLAY” (or “ⓄREC”).  
The timer conditions are shown in the following order:

#### Play timer:

Start time→Finish time→Source→Volume

#### Record timer:

Start time→Finish time→Selected radio station

The timers can be checked even if the unit is off.

#### Playing the unit after the timers are set

The unit can be used after the timers are set. Make sure the unit is off before the set start time.

#### Note

- If you turn the unit off and on again while a timer is functioning, the finish time setting will not be activated.
- If the unit is on, the timer will not function. The system must be in the standby mode.
- This system retains the ON/OFF time settings until you make a new setting. If you make a new ON time setting, you must make a new OFF time setting.
- Do not turn DEMO on after setting a timer. The timers will not work while DEMO is on.

### B The sleep timer

#### Remote control only

This timer turns the unit off after a set time.

#### While playing a source

Press [SLEEP] to select the time (minutes).

Each time you press the button:

SLEEP 30 → SLEEP 60 → SLEEP 90  
← SLEEP OFF ← SLEEP 120 ←

#### To cancel the sleep timer

Press [SLEEP] to select “SLEEP OFF”.  
“SLEEP” goes out.

#### To confirm the remaining time

(While the timer is functioning)

Press [SLEEP].

The remaining time is shown for about 5 seconds.

#### To change the setting

Press [SLEEP] to display the remaining time, then press again to select the required time.

### Using the timers together

Any of the timers can be used together, but ensure the unit is off before the start time for the record and play timers.

You can do karaoke with CDs and tapes.

**Preparation:**

Lower the volume with [MIC VOL] and connect the microphone. Use a dynamic microphone. Plug type: 6.3 mm monaural

**1 Press [KARAOKE] to select a voice mode.**

Each time you press the button:  
MONO L → MONO R → VOICE MUTE → off (Normal)

- Karaoke CDs and tapes
  - MONO L: Only left channel sound (No vocal)
  - MONO R: Only right channel sound (Vocal)
  - Select no vocal for karaoke. Vocal and no vocal may be reversed.
- Normal music CDs and tapes
  - VOICE MUTE: Voice mute (Lowers vocal volume)

**2 Start playing the CD or tape.**

**3 Adjust the main volume and microphone volume.**

**To cancel**

Press [KARAOKE] to clear the display.

**To record your performance**

Start recording in deck 2 and then start singing. Ensure the voice mode is set to off (at step 2 above) when playing the recording.

**Note**

The karaoke modes cannot be used with the radio, SUPER 3D AI EQ, 6CH DISCRETE INPUT or surround effects.

**When using the VOICE MUTE function**

- Voice mute may not function sufficiently or noise may interfere when using the following software.
  - Monaural software
  - Software with few musical instruments, including classic music and poetry recitations
  - Software with duets or strong choruses
- VOICE MUTE reduces the level of the vocals but does not cancel them out completely.

**A Using the echo effect**

**Press [ECHO].**

Each time you press the button:  
ECHO 1 → ECHO 2 → ECHO 3 → OFF

**A Changing the sound range display**

The sound processor shows the level of each sound range with the three types of display described below.

**Press [DISPLAY MODE].**

The spectrum display will change as follows.

- a Normal display**  
This display indicates the strength of the sound in each tonal range.
- b Peak-hold display**  
The peak sound value of each sound range is held on the display for about one second after it occurs.
- c Aurora display**  
The peak sound value of each sound range is displayed in inverted form.

**B Muting the volume**

**Remote control only**

**Press [MUTING].**

Volume is reduced to minimum.

**To cancel**

Press [MUTING] again. "MUTING" goes out and the volume is restored. To cancel from the tuner/amplifier, turn [VOLUME] to minimum (--- dB), then raise it to the required level. Muting is also canceled when the unit is turned off.

**C Using headphones (not included)**

**Reduce the volume before connection.**

Avoid listening for prolonged periods of time to prevent hearing damage. Plug type: 3.5 mm stereo

**A**

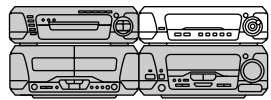

DISPLAY MODE

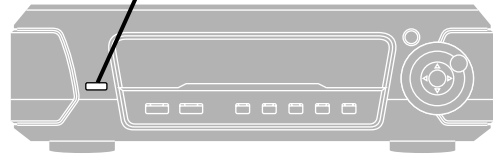

(On the sound processor)

DISPLAY MODE

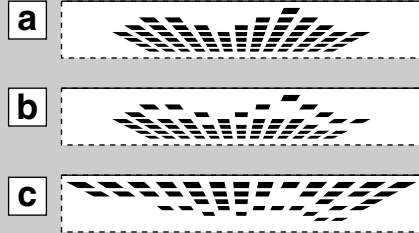

**B**

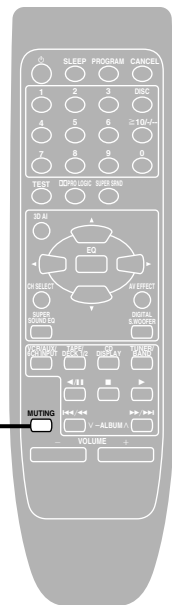

MUTING

MUTING



**C**

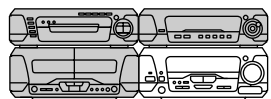

PHONES



VOLUME

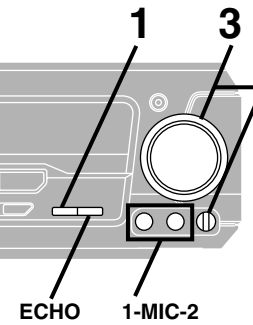
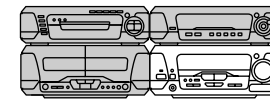

ECHO

1-MIC-2

**1**

KARAOKE



MONO L



MONO R

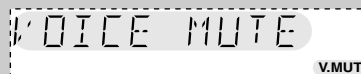

V.MUTE



Original display

**3**

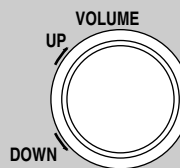

DOWN

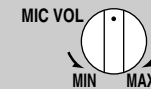

MIN

MAX

**A**

ECHO



ECHO

**A**

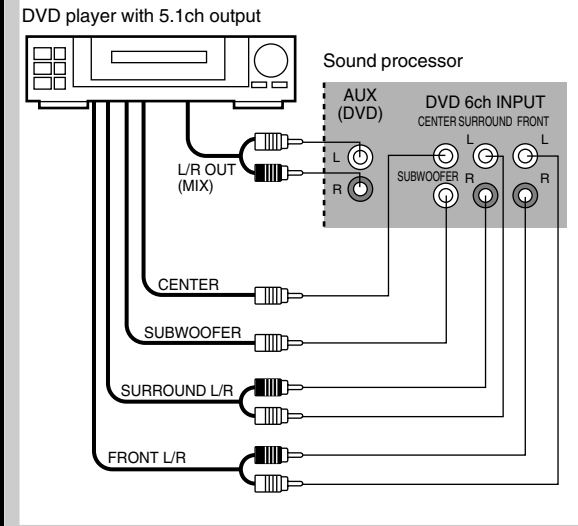

**B**

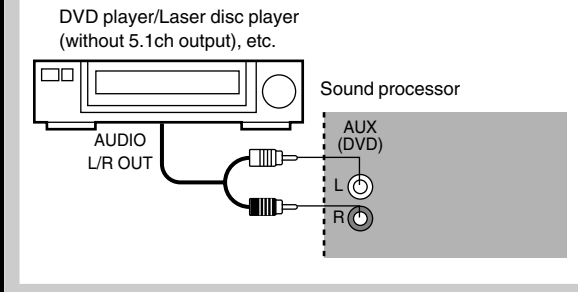

**C**

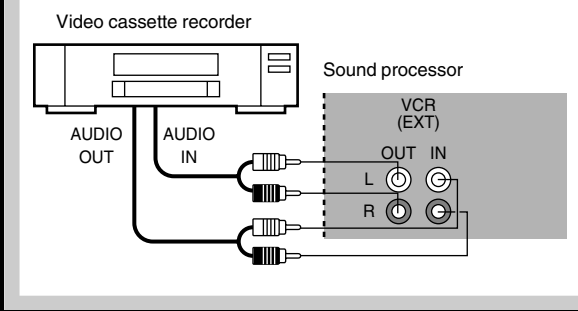

**D**

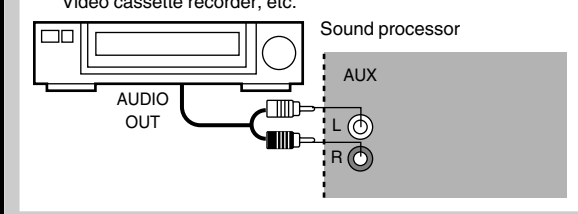

**External unit connections**

- Turn off all units before making connections.
- Refer to the manual of the other unit for details. (Cables and equipment not included.)

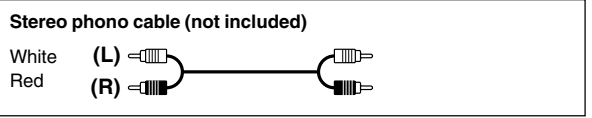

**Connections to SC-EH790**

**A DVD player with 5.1ch output**  
This unit has the input terminals for 5.1ch surround systems but it does not have the decoders necessary to play them back. The DVD player should have these decoders and 5.1ch output.

**To record sound from the DVD player**  
Connect to AUX (DVD).

**Subwoofer**  
The included front speakers have superwoofers, but you can enhance surround sound from a unit connected to DVD 6ch INPUT by connecting another subwoofer to SUBWOOFER terminal.

**B DVD player/Laser disc player (without 5.1ch output), etc.**  
This unit has Dolby Pro Logic circuitry. The sound will be reproduced with the same powerful stereophonic effects found in movie theaters.

**C Video cassette recorder**  
You can enjoy the sound from your video cassette recorder.

**Connections to SC-EH590**

**D DVD player/Laser disc player/Video cassette recorder, etc.**  
You can enjoy the sound from your DVD player/Laser disc player/Video cassette recorder, etc.

**Optional antenna connections**

Use outdoor antennas if radio reception is poor.

**A FM outdoor antenna**

- Disconnect the FM indoor antenna.
- The antenna should be installed by a competent technician.

**B AM outdoor antenna**

Run a piece of vinyl wire horizontally across a window or other convenient location. Leave the loop antenna connected.

**Note**  
Disconnect the antenna when the unit is not in use. Do not use the antenna during an electrical storm.

**C Using other equipment**

**Listening to an external source**

**1 Press [INPUT SELECTOR] to select the external source.**  
Each time you press the button:

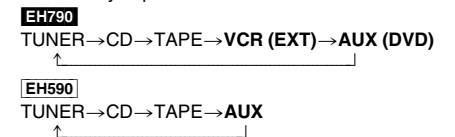

**On the remote control**  
Press [VCR/AUX/6CH INPUT] (SC-EH790) or [AUX] (SC-EH590).

**2 Operate the unit.**  
See the unit's manual for details on operation and connection.

**EH790**  
**To enjoy Dolby Digital and DTS**  
→ page 24

**Recording an external source**

- 1 Press [INPUT SELECTOR] to select the external source.**
- 2 Select Dolby NR and reverse mode.** (→ page 28)
- 3 Press [● REC PAUSE].**
- 4 Press [<] or [>] to start recording.**
- 5 Start the source to be recorded.**  
See the unit's manual for details on operation and connection.

**To stop recording**  
Press [■] on the deck.

**To temporarily stop recording**  
Press [● REC PAUSE].  
The deck goes into the recording standby mode.  
To resume recording press [<] or [>] with the flashing indicator.

**Recording onto an external unit**

**EH790**  
Connect the external unit to VCR (EXT) OUT. Select the source to be recorded with [INPUT SELECTOR]. Start recording on the external unit and start playing the source to be recorded.

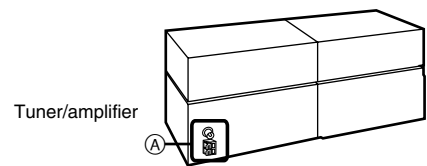

**A For the United Kingdom and Eastern Europe**

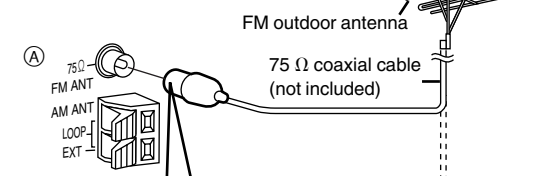

**For the United Kingdom only**  
Use the antenna plug adaptor included.

**For Australia and N.Z.**

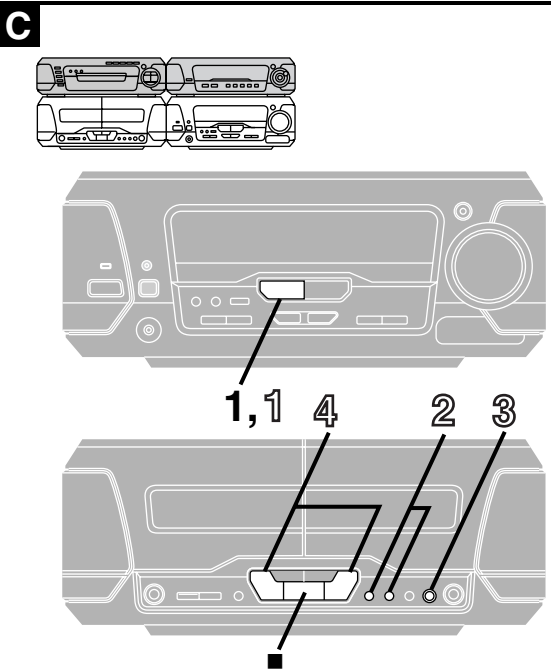
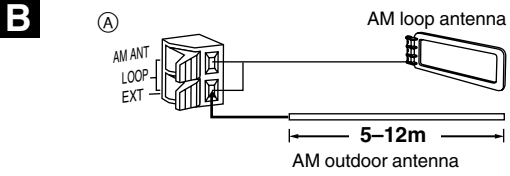
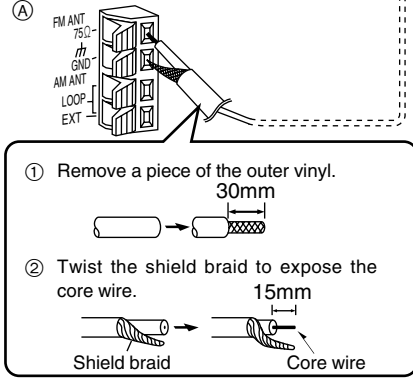

Before requesting service, make the below checks. If you are in doubt about some of the check points, or if the remedies indicated in the chart do not solve the problem, consult your dealer for instructions.

Reference pages are shown as black circled numbers ❸.

## Common Problems

<b>No sound.</b>	Turn the volume up. Switch off the unit, determine and correct the cause, then switch the unit on. Causes include shorting of the positive and negative speaker wires, straining of the speakers through excessive volume or power, and using the unit in a hot environment.
<b>Sounds unfixed, reversed or come from one speaker only.</b>	Check the speaker connections. ❸
<b>Humming heard during play.</b>	An AC mains lead or fluorescent light is near the cables. Keep other appliances and leads away from this unit's cables. If possible in your area, turn the AC mains lead's plug or connector over to reverse the lead's polarity.
<b>"ERROR" is displayed.</b>	Incorrect operation performed. Read the instructions and try again.
<b>"U70" is displayed.</b>	Connect the flat cables firmly. If "U70" remains on the display, contact the dealer.
<b>"F60" is displayed.</b>	There is a problem with the amplifier. Consult your dealer.
<b>"---:---" appears on the display.</b>	You plugged the AC mains lead in for the first time or there was a power failure recently. Set the time. ❷
<b>The display starts up even after the unit is turned off.</b>	The demonstration feature (-DEMO) is on. Turn it off if it is not required. ❷

## The CD changer or CD player

<b>The display is wrong or play won't start.</b>	The disc may be upside down. ❸ Wipe the disc. Replace the disc if it is scratched, warped, or nonstandard. Condensation may have formed in the changer or player due to a sudden change in temperature. Wait about an hour for it to clear and try again.
<b>EH790 "TAKE OUT/DISC" appears on the display.</b>	There is a problem with the CD mechanism. (A power failure may have occurred.) The tray will open automatically. Remove the CD from the tray, and after ensuring there is no CD in the tray, close it. The unit will make the disc changing noises for a few moments and then it should operate normally.

## Listening to the radio

<b>Noise is heard. The stereo indicator flickers or doesn't light. Sound is distorted.</b>	Use an outdoor antenna. ❷
<b>A beat sound is heard.</b>	Turn the TV off or separate it from the unit.
<b>A low hum is heard during AM broadcasts.</b>	Separate the antenna from other cables and leads.
<b>The correct AM frequency can't be tuned in.</b>	Change the frequency step. Hold [TUNER/BAND] down for 10 seconds to change the step to 9 kHz.

## The cassette deck

<b>Poor quality sound.</b>	Clean the heads. ❸ Check the Dolby NR setting. ❸
<b>Recording is not possible.</b>	If the erasure prevention tabs have been removed, cover the holes with adhesive tape. ❸
<b>"DECK NO TAPE" is displayed during "One touch editing".</b>	Load a cassette into deck 2. ❸
<b>"DECK CHANGE TAPE" is displayed during "One touch editing".</b>	If the erasure prevention tabs have been removed, cover the holes with adhesive tape. ❸

## When there is a television set nearby

<b>The picture on the TV disappears or stripes appear on the screen.</b>	The location and orientation of the antenna are incorrect. If you are using an indoor antenna, change to an outdoor antenna. The TV antenna wire is too close to the unit. Separate the antenna wire of the TV set from the system.
--------------------------------------------------------------------------	----------------------------------------------------------------------------------------------------------------------------------------------------------------------------------------------------------------------------------------

## The remote control

<b>The remote control doesn't work.</b>	Check the batteries are inserted correctly. ❶ Replace the batteries if they are worn.
-----------------------------------------	------------------------------------------------------------------------------------------

All components are required to service the system. If service is ever necessary, bring the entire system.

## Maintenance

### If the surfaces are dirty

To clean this unit, wipe with a soft, dry cloth.

- Never use alcohol, paint thinner or benzine to clean this unit.
- Before using chemically treated cloth, read the instructions that came with the cloth carefully.

### For a cleaner crisper sound

Clean the heads regularly to assure good quality playback and recording.  
Use a cleaning tape (not included).

## Cassette tape selection and care

The unit can correctly play or record on the following types. It identifies the type automatically.

Normal position/TYPE I	✓
High position/TYPE II	✓
Metal position/TYPE IV	✓

- Tapes exceeding 100 minutes are thin and can break or get caught in the mechanism.
- Tape slack can get caught up in the mechanism and should be taken up before the tape is played.
- Endless tapes can get caught up in the deck's moving parts if used incorrectly. Use tapes appropriate to this unit's auto-reverse mechanism.



# Technical specifications

## SOUND PROCESSOR

■ **EQ/SFP section**  
**MANUAL GEQ**  
 5-Band EQ  
 Center frequency 70/300/1 k/3.15 k/10 k Hz  
 Level control ±2.0, 4.0, 6.0 dB

EQ/Space mode **EH790**  
 4 modes HEAVY, CLEAR, SOFT, HALL  
 EQ mode **EH590**  
 3 modes HEAVY, CLEAR, SOFT  
 SUPER 3D AI EQ **EH790**  
 3 modes AI EQ, SUPER 3D AI 1, SUPER 3D AI 2

■ **Pre-amplifier section**  
 Input sensitivity/impedance  
 VCR (EXT) **EH790** 250 mV/15 kΩ  
 AUX(DVD) **EH790** 250 mV/15 kΩ  
 AUX **EH590** 250 mV/15 kΩ

Output level **EH790**  
 VCR REC OUT 150 mV/1.5 kΩ  
 ■ **DOLBY PRO LOGIC section** **EH790**  
 PRO LOGIC mode SURROUND  
 CENTER mode NORMAL  
 DELAY TIME 20 ms (Fixed)

■ **AV SURROUND section** **EH790**  
 AV surround mode SUPER SURROUND (MUSIC, MOVIE)  
 ■ **DSP CONTROL section**  
 DSP control mode SUPER SOUND EQ  
**EH790** CENTER FOCUS  
**EH790** VIRTUAL REAR SURROUND  
**EH790** MULTI REAR SURROUND  
**EH790** SEAT POSITION

■ **Spectrum analyzer section**  
 Display mode NORMAL, PEAKHOLD, AURORA

■ **General**  
 Dimensions (W×H×D) **EH790** 293×89×270 mm  
**EH590** 293×89×269 mm  
 Mass **EH790** 1.5 kg  
**EH590** 1.4 kg

## TUNER AMPLIFIER

■ **Amplifier section** **EH790**  
 Power output (L/R both channel driven)  
 Stereo Mode  
 DIN 1 kHz THD 1 %/6 Ω (High) 2×25 W  
 100 Hz THD 1 %/8 Ω (Low) 2×45 W  
 RMS 1 kHz THD 10 %/6 Ω (High) 2×35 W  
 100 Hz THD 10 %/8 Ω (Low) 2×65 W

PRO LOGIC mode  
 DIN  
 FRONT 1 kHz THD 1 %/6 Ω (High) 2×25 W  
 100 Hz THD 1 %/8 Ω (Low) 2×45 W  
 SURROUND 1 kHz THD 1 %/8 Ω 2×30 W  
 CENTER 1 kHz THD 1 %/8 Ω 60 W  
 RMS  
 FRONT 1 kHz THD 10 %/6 Ω (High) 2×35 W  
 100 Hz THD 10 %/8 Ω (Low) 2×65 W  
 SURROUND 1 kHz THD 10 %/8 Ω 2×40 W  
 CENTER 1 kHz THD 10 %/8 Ω 80 W  
 PMPO 1 kHz/High 6 Ω, Low 8 Ω, CENT. 8 Ω, SURR. 8 Ω 3000 W

Total harmonic distortion  
 Rated power at 1 kHz 1 % (6 Ω)  
 Half power at 1 kHz 0.1 % (6 Ω)  
 Load impedance  
 FRONT (High) 6 Ω  
 FRONT (Low) 8 Ω  
 SURROUND 8 Ω  
 CENTER 8 Ω

DIGITAL S. WOOFER  
 Center frequency 60 Hz  
 LEVEL (VOL -20 dB) MID +3 dB/MAX +6 dB

■ **Amplifier section** **EH590**  
 Power output (L/R both channel driven)  
 DIN 1 kHz THD 1 %/6 Ω (High) 2×25 W  
 100 Hz THD 1 %/8 Ω (Low) 2×65 W  
 RMS 1 kHz THD 10 %/6 Ω (High) 2×35 W  
 100 Hz THD 10 %/8 Ω (Low) 2×85 W

Total harmonic distortion  
 Rated power at 1 kHz 1 % (6 Ω)  
 Half power at 1 kHz 0.1 % (6 Ω)  
 Load impedance Main (High) 6 Ω  
 Main (Low) 8 Ω

DIGITAL S. WOOFER  
 Center frequency 60 Hz  
 LEVEL (VOL -20 dB) MID+3 dB/MAX+6 dB

■ **FM tuner section**  
 Frequency range 87.50–108.00 MHz  
 (0.05 MHz steps)  
 Sensitivity 1.8 μV (IHF usable)  
 S/N 26 dB 1.5 μV  
 S/N MONO 70 dB (75 dB, IHF)  
 Antenna terminal(s) 75 Ω (unbalanced)

■ **AM tuner section**  
 Frequency range 522–1629 kHz (9 kHz steps)  
 520–1630 kHz (10 kHz steps)  
 Sensitivity (S/N 20 dB) 500 μV/m

■ **Timer section**  
 Clock Quartz-lock type  
 Function Play timer (1 time, daily),  
 Rec timer (1 time, daily),  
 Sleep (120 min, 30 min intervals)

Setting intervals (Play/Rec)  
 1 minute–23 hours 59 minutes (1 min intervals)

■ **General**  
 Power supply (For the United Kingdom, Australia and N.Z.) AC 230–240 V 50 Hz  
 (For Eastern Europe) AC 230 V 50 Hz  
 Power consumption **EH790** 190 W  
**EH590** 160 W  
 Standby 0.5 W  
 Dimensions (W×H×D) 293×118.5×345 mm  
 Mass **EH790** 5.2 kg  
**EH590** 5.0 kg

## CD PLAYER

■ **Discs played (8 cm or 12 cm)**  
**EH790** CD-R/RW (CD-DA, WMA, MP3 formatted discs)  
**EH590** CD-R/RW (CD-DA formatted discs)

■ **Pickup**  
 Wavelength 780 nm  
 ■ **General**  
 Dimensions (W×H×D) **EH790** 293×89×288 mm  
**EH590** 293×89×268 mm  
 Mass **EH790** 2.2 kg  
**EH590** 1.6 kg

## CASSETTE DECK

Deck system Stereo cassette deck  
 Track system 4 track, 2 channel  
 Recording system AC bias  
 Bias frequency 100 kHz  
 Erasing system AC erase  
 Heads  
 Deck 1 Permalloy head  
 Deck 2 (Playback head)  
 Deck 1 (Recording/Playback head) Permalloy head  
 Deck 2 (Erasing head) Double gap ferrite head  
 Motors  
 Deck 1, 2 Capstan drive DC servo motor  
 Tape speed 4.8 cm/s  
 Wow and flutter 0.16 % (WRMS)  
 Fast forward and rewind times  
 Approx. 110 seconds with C-60 cassette tape

Frequency response (Dolby NR off)  
 TYPE I (NORMAL) 20 Hz–16 kHz (DIN)  
 TYPE II (HIGH) 20 Hz–16 kHz (DIN)  
 TYPE IV (METAL) 20 Hz–16 kHz (DIN)  
 S/N (Signal level=max recording level, TYPE II type tape)  
 NR off 56 dB (A weighted)  
 Dolby B NR on 66 dB (A weighted)

Input sensitivity and impedance  
 REC (IN) 150 mV/23 kΩ  
 Output voltage and impedance  
 PLAY (OUT) 280 mV/360 Ω

■ **General**  
 Dimensions (W×H×D) 294×118.5×281 mm  
 Mass 2.1 kg

## FRONT SPEAKER

Type 3 way, 3 speakers, Bassreflex  
 Speaker(s)  
 Super woofer 17 cm cone type  
 Woofer 12 cm cone type  
 Tweeter **EH790** 6 cm ring shaped dome type  
**EH590** 6 cm cone type

Impedance High 6 Ω, Low 8 Ω  
 Input power (Music) High 60 W, Low 120 W  
 Output sound pressure level **EH790** 87 dB/W (1.0 m)  
**EH590** 84 dB/W (1.0 m)

Crossover frequency **EH790** 120 Hz, 4 kHz  
**EH590** 150 Hz, 4 kHz

Frequency range **EH790** 42 Hz–50 kHz (–16 dB)  
 46 Hz–36 kHz (–10 dB)  
**EH590** 42 Hz–22 kHz (–16 dB)  
 46 Hz–20 kHz (–10 dB)

■ **General**  
 Dimensions (W×H×D) 240×412×259 mm  
 Mass 5.8 kg

## CENTER SPEAKER **EH790**

Type 2 way, 3 speakers, Bassreflex  
 Speaker  
 Woofer(×2) 8 cm cone type  
 Tweeter 6 cm cone type  
 Impedance 8 Ω  
 Input power (Music) 160 W  
 Output sound pressure level 86 dB/W (1.0 m)  
 Crossover frequency 4 kHz  
 Frequency range 100 Hz–22 kHz (–16 dB)  
 115 Hz–20 kHz (–10 dB)

■ **General**  
 Dimensions (W×H×D) 190×99×166 mm  
 Mass 1.8 kg

## SURROUND SPEAKER **EH790**

Type 1 way, 1 speaker, Closed  
 Speaker  
 Full range 8 cm cone type  
 Impedance 8 Ω  
 Input power (Music) 70 W  
 Output sound pressure level 84 dB/W (1.0 m)  
 Frequency range 130 Hz–20 kHz (–16 dB)  
 150 Hz–18 kHz (–10 dB)

■ **General**  
 Dimensions (W×H×D) 140×99×118 mm  
 Mass 0.9 kg

## Note

- Specifications are subject to change without notice.  
 Mass and dimensions are approximate.
- Total harmonic distortion is measured by the digital spectrum analyzer.
- “Low” and “High” stand for low frequency and high frequency.