

MULTIBAND P25 AIRBORNE TRANSCEIVER MODEL TDFM-600/6000

Installation and Operating Instructions

Til Document No.
01RE293
Rev. C
Issue 6

May 2004

Technisonic Industries Limited

240 Traders Blvd, Mississauga, Ontario L4Z 1W7
Tel:(905)890-2113 Fax:(905)890-5338
www.til.ca

CAUTION

This unit contains static sensitive devices. Wear a grounded wrist strap and/or conductive gloves when handling printed circuit boards.



WARNING: This device complies with Part 15 of the FCC Rules. Operation is subject to the following two conditions: (1) this device may not cause harmful interference and (2) this device must accept any interference received, including interference that may cause undesired operation.



WARNING For compliance with FCC RF Exposure Requirements, the mobile transmitter antenna installation shall comply with the following two conditions:

1. The transmitter antenna gain shall not exceed 3 dBi
2. The transmitter antenna is required to be located outside of a vehicle and kept at a separation distance of 70 cm or more between the transmitter antenna of this device and persons during operation.

NOTE: *This equipment has been tested and found to comply with the limits for a Class A digital device, pursuant to Part 15 of the FCC Rules. These limits are designed to provide reasonable protection against harmful interference when the equipment is operated in a commercial environment. This equipment generates, uses, and can radiate radio frequency energy and, if not installed and used in accordance with the instruction manual, may cause harmful interference to radio communications. Operation of this equipment in a residential area is likely to cause harmful interference in which case the user will be required to correct the interference at his own expense.*

Warning:

Changes or modifications not expressly approved by Technisonic Industries could void the users authority to operate the equipment.

WARRANTY INFORMATION

The Model TDFM-600/6000 Transceiver is under warranty for one year from date of purchase. Failed units caused by defective parts, or workmanship should be returned to:

Technisonic Industries Limited
240 Traders Boulevard
Mississauga,
Ontario L4Z 1W7

Technisonic Industries Limited
3840 E. Robinson Road, Suite 214
Amherst,
New York 14228

Tel: (905) 890-2113 Fax: (905) 890-5338

Tel: (716) 691-0669

Summary of DO-160C Environmental Testing for Technisonic Model TDFM-600 and 6000 Transceiver.

Conditions	Section	Description of Conducted Tests
Temperature and Altitude	4.0	Equipment tested to categories C4 and D1.
Vibration	8.0	Equipment is tested without shock mounts to categories B, M and N.
Magnetic Effect	15.0	Equipment is class Z.
Power Input	16.0	Equipment tested to category B.
Voltage Spike	17.0	Equipment tested to category B.
RF Emission	21.0	Equipment tested to category Z.

Installation Approval Note

Presently no TSO standard exists for airborne FM transceivers. To make it easier for installation agencies to provide their customers with an approved installation supported by an effective Airworthiness Approval, Technisonic has secured Supplemental Type Certificate (STC) Approvals (both US and Canadian) on its Airborne FM products for many helicopters currently being delivered in the US and Canada as well as a number of single engine fixed wing aircraft. The above referenced DO-160C test data is also on file and available from Technisonic to support approval requirements in airframes for which Technisonic does not possess an STC.

Approved aircraft types are listed in the attachments to the formal STC documents. These STC's are the exclusive property of Technisonic and require the written authority of Technisonic for their use. To assist Factory Authorized Technisonic Dealers in the certification process, we have placed copies of our Canadian and US STC's on our web site along with a letter of authorization for their use. These documents may be downloaded and used as support for the technical submission to FAA or Transport Canada. Only factory authorized dealers/installers are permitted to download and make use of these documents on behalf of their customers (end users) in support of regulatory agency approval. Please refer to the Technisonic web site www.til.ca for the latest issue of available STC's and letter of authorization for use.

TABLE OF CONTENTS

Paragraph	Title	Page
SECTION 1 GENERAL DESCRIPTION		
1.1	Introduction.....	1-1
1.2	Description.....	1-1
1.3	Model Variation.....	1-1
1.4	Technical Summary	1-3
SECTION 2 OPERATING INSTRUCTIONS		
2.1	General.....	2-1
2.2	Front Panel.....	2-1
2.3	Power Switch.....	2-2
2.4	Knob	2-2
2.5	Soft Keys and HOME.....	2-3
2.6	Function Keys.....	2-3
2.7	MUP and MDN Keys.....	2-5
2.8	Up and Down Arrow Keys.....	2-5
2.9	Left and Right Arrow Keys.....	2-5
2.10	ESW Key.....	2-5
2.11	TSW Key	2-5
2.12	Display	2-6
2.13	General Operation	2-6
2.14	Customer Programming Software (CPS)	2-6
2.15	Configuration Menu.....	2-8
2.16	Flash Upgrade Mode.....	2-8
2.17	Front Panel Programming (FPP) Mode.....	2-8
SECTION 3 INSTALLATION INSTRUCTIONS		
3.1	General.....	3-1
3.2	Equipment Packing Log.....	3-1
3.3	Transceiver Installation	3-1
3.4	Installation Kit - Contents.....	3-1
3.5	Pin Locations and Connections.....	3-2
3.6	Wiring Instructions	3-3
3.18	Post Installation Tests.....	3-7

LIST OF TABLES

Table No.	Title	Page
3-1	25-pin D Connections	3-2

LIST OF ILLUSTRATIONS

Figure No.	Title	Page
2-1	Operator's Controls – TDFM-600/6000	2-1
2-2	Operator's Controls – TDFM-636	2-2
3-1	Outline Drawing	3-1
3-2	Wiring Connections and notes.....	3-5

SECTION 1

GENERAL DESCRIPTION

1.1 INTRODUCTION

This publication provides operating and installation information on the TDFM-600/6000 series airborne transceiver. The exact model number depends on which and how many RF modules are installed.

1.2 DESCRIPTION

The TDFM-600/6000 series of transceivers are airborne multi-band radios capable of operation in conventional analog and P25 digital FM systems, SmartNet/SMART ZONE trunking systems and P25 9600 trunking systems. Type I RF modules are available in VHF, UHFLO, UHFHI and 800 MHz bands. Type II RF modules support additional optional features not available in type I modules and are currently available in VHF, UHFLO and 700/800 MHz.

These optional additional features include P25 9600 trunking that may be combined with AES and/or DES-OFB encryption with OTAR in any of the available modules. The factory will only produce radios with all modules of the type I or type II configuration since different Motorola CPS programming software is required for each type of module.

It may be possible to retrofit existing type I transceivers with one or more type II modules to support optional features not available on type I modules. Contact Technisonic for details.

Irrespective of module type the bands are numbered 1, 4, 5 and 8 respectively. The front panel LED display indicates whether type I or II modules are present upon radio start-up. The transceiver's part number will also indicate which type of modules it contains. Please see section 1.3 on Model Variation below for details.

The following are typical model examples:

TDFM-655	-	Two UHF high band modules
TDFM-688	-	Two 800 MHz modules
TDFM-6148	-	One VHF, UHF low and 800 MHz module
TDFM-6158	-	One VHF, UHF high and 800 MHz module

Module numbers are always specified in ascending numerical order. ie/ TDFM-6814 is not available.

The one exception to this numbering scheme is the model TDFM-636 which is a VHF transceiver with two type II VHF modules and a 10 watt RF amplifier for each module.

1.3 MODEL VARIATION

There are several variations of the Model TDFM-600/6000 Transceiver. Each variation offers different features and performance based on the type of RF modules and options installed.

TDFM-600 Model Variations with type I Modules

TDFM-6XX, P/N 011210-1-6XX/PYYY/28	GREEN display and 28 Volt back lighting.
TDFM-6XX, P/N 011210-1-6XX/PYYY/5	GREEN display and 5 Volt back lighting.
TDFM-6XX, P/N 011210-2-6XX/PYYY/28	RED display and 28 Volt back lighting.
TDFM-6XX, P/N 011210-2-6XX/PYYY/5	RED display and 5 Volt back lighting.
TDFM-6XXNV, P/N 011210-1-6XXNV/PYYY/28	GREEN NV display and 28 Volt back lighting
TDFM-6XXNV, P/N 011210-1-6XXNV/PYYY/5	GREEN NV display and 5 Volt back lighting.

TDFM-6000 Model Variations with type I Modules

TDFM-6XXX, P/N 011210-1-6XXX/PYYY/28
TDFM-6XXX, P/N 011210-1-6XXX/PYYY/5
TDFM-6XXX, P/N 011210-2-6XXX/PYYY/28
TDFM-6XXX, P/N 011210-2-6XXX/PYYY/5
TDFM-6XXXNV, P/N 011210-1-6XXXNV/PYYY/28
TDFM-6XXXNV, P/N 011210-1-6XXXNV/PYYY/5

X is represented by:

1 for VHF (138-174MHz) module
4 for UHF Lo (403-470MHz) module
5 for UHF Hi (450-512MHz) module
8 for 800 MHz (806-870)

Module numbers must always be specified in ascending order.

TDFM-6000 Model Variations with type II Modules

TDFM-6XX, P/N 011210-3-6XX/PYYY/28
TDFM-6XX, P/N 011210-3-6XX/PYYY/5
TDFM-6XX, P/N 011210-4-6XX/PYYY/28
TDFM-6XX, P/N 011210-4-6XX/PYYY/5
TDFM-6XXNV, P/N 011210-3-6XXNV/PYYY/28
TDFM-6XXNV, P/N 011210-3-6XXNV/PYYY/5

TDFM-6000 Model Variations with type II Modules

TDFM-6XXX, P/N 011210-3-6XXX/PYYY/28
TDFM-6XXX, P/N 011210-3-6XXX/PYYY/5
TDFM-6XXX, P/N 011210-4-6XXX/PYYY/28
TDFM-6XXX, P/N 011210-4-6XXX/PYYY/5
TDFM-6XXXNV, P/N 011210-3-6XXXNV/PYYY/28
TDFM-6XXXNV, P/N 011210-3-6XXXNV/PYYY/5

X is represented by:

1 for VHF (138-174MHz) module
4 for UHF Lo (380-470MHz) module
8 for 700/800 MHz (764-870)

Module numbers must always be specified in ascending order.

TDFM-636 Model Variations with type II VHF Modules

TDFM-636, P/N 011210-5-636/PYYY/28
TDFM-636, P/N 011210-5-636/PYYY/5
TDFM-636, P/N 011210-6-636/PYYY/28
TDFM-636, P/N 011210-6-636/PYYY/5
TDFM-636NV, P/N 011210-5-636NV/PYYY/28
TDFM-636NV, P/N 011210-5-636NV/PYYY/5

PYY represents a 3-digit project number that identifies specific options that are contained in the module. All TDFM-636 transceivers are shipped as P600 units unless a custom project number is requested. P600 defines specific options in each VHF module. VHF Module 1 supports P25 Trunking, Smart Zone and SMART NET trunking protocols. VHF Module 2 supports conventional (non-trunked) operation with FPP (front panel programming) capability. Both modules support secure communications using AES/DES-OFB/DES/DES-XL encryption formats and P25 OTAR. Custom project numbers can be assigned by the Technisonic sales department to meet non-standard requirements.

GREEN display and 28 Volt back lighting.
GREEN display and 5 Volt back lighting.
RED display and 28 Volt back lighting.
RED display and 5 Volt back lighting.
GREEN NV display and 28 Volt back lighting
GREEN NV display and 5 Volt back lighting.

PYYY represents a 3-digit project number that identifies specific options that are contained in the module. The Technisonic sales department assigns project numbers based on customer requirements. P100 and P200 series project numbers are used in transceivers with type I modules.

GREEN display and 28 Volt back lighting.
GREEN display and 5 Volt back lighting.
RED display and 28 Volt back lighting.
RED display and 5 Volt back lighting.
GREEN NV display and 28 Volt back lighting
GREEN NV display and 5 Volt back lighting.

GREEN display and 28 Volt back lighting.
GREEN display and 5 Volt back lighting.
RED display and 28 Volt back lighting.
RED display and 5 Volt back lighting.
GREEN NV display and 28 Volt back lighting
GREEN NV display and 5 Volt back lighting.

PYYY represents a 3-digit project number that identifies specific options that are contained in the module. P300, P400 and P500 project numbers are used in transceivers with type II modules.

GREEN display and 28 Volt back lighting.
GREEN display and 5 Volt back lighting.
RED display and 28 Volt back lighting.
RED display and 5 Volt back lighting.
GREEN NV display and 28 Volt back lighting
GREEN NV display and 5 Volt back lighting.

All model variations are provided with 28 Volt back lighting unless a specific request is made for 5 Volt AC operation. NV (Night Vision) compatible option is only available with green display.

1.4 TECHNICAL CHARACTERISTICS

<u>Specification</u>	<u>Characteristic</u>
Model Designation:	TDFM-600/6000
Physical Dimensions:	Approx. 8" X 3" X 5.75"
Weight:	4.2 lbs. (1.9 kg)
Operating Temperature Range:	-30°C to +60°C
Power Requirement:	
Voltage:	28.0 Vdc, ± 15%
Current:	350mA minimum / 5A maximum
Audio Output Power (including sidetone):	500 mW into 600 ohms
Microphone Inputs:	Carbon or Equivalent
Panel Back Lighting:	
Voltage:	28 VDC or 5VAC (specified when ordered)
Current:	100mA max. @28VDC 400mA max. @5VAC

Type I Modules

RF Output Power:	1 or 5 Watts (VHF) 1 or 4 Watts (UHF) 1 or 3 Watts (800)
Frequency Range -	VHF Module: 136 to 178 MHz UHF LO Module: 403 to 470 MHz UHF HI Module: 450 to 512 MHz 800 Module: 806 to 870 MHz
No. of channels per band:	255 pre-programmable channels
Transmitter section	VHF UHF 800
FM Hum and noise in dB (wideband):	-48 -45 -45
Frequency Stability in ppm:	± 2.0 ± 2.0 ± 1.5
Audio Distortion (at 1000Hz):	< 2% < 2% < 2%
Modulation Limiting:	Wide band ± 5kHz Narrow band ± 2.5kHz

1.3 TECHNICAL CHARACTERISTICS (continued)

Receiver section	VHF	UHF	800
<i>Sensitivity</i> in μV :			
*Digital 1% BER (12.5kHz)	0.35	0.35	0.45
*Digital 5% BER (12.5kHz)	0.25	0.25	0.25
**Analog with 12dB SINAD	0.25	0.25	0.25
 <i>Selectivity</i> in dB:			
25 kHz Channel	-78	-78	-75
12.5 kHz Channel	-67	-68	-63
Intermodulation (dB) * * *	-78	-77	-74

Type II Modules

RF Output Power:		1 or 7 Watts (VHF)		
		1 or 5 Watts (UHF)		
		1 or 3 Watts (800)		
		1 or 10 Watts (TDFM-636)		
Frequency Range -	VHF Module:	136 to 178 MHz		
	UHF LO Module:	380 to 470 MHz		
	700/800 Module:	764 to 870 MHz		
No. of channels per band:		512 pre-programmable channels		
		240 channels (15 zones of 16 channels)		
		in modules with Front Panel Programming.		

Transmitter section	VHF	UHF	800
FM Hum and noise in dB (wideband):	-48	-45	-45
Audio Distortion:	1%	1.5%	1.5%
Frequency Stability (ppm):	± 2.0	± 2.0	± 1.5
Modulation Limiting:	Wide band		$\pm 5\text{kHz}$
	Narrow band		$\pm 2.5\text{kHz}$

Receiver section	VHF	UHF	800
<i>Sensitivity</i> in μV :			
*Digital 1% BER (12.5kHz)	0.25	0.25	0.40
*Digital 5% BER (12.5kHz)	0.25	0.25	0.25
**Analog with 12dB SINAD	0.25	0.25	0.25
 <i>Selectivity</i> in dB:			
25 kHz Channel	-80	-78	-72
12.5 kHz Channel	-63	-63	-63
Intermodulation * * *	-78	-77	-75

* Measured in digital mode per TIA/EIA IS 102.CAAA under nominal conditions.

** Measured in analog mode per TIA/EIA 603 under nominal conditions.

SECTION 2 OPERATING INSTRUCTIONS

2.1 GENERAL

A 2 line display and a keypad and 2 or 3 rotary knobs provide the operator control of the 2 or 3 RF modules installed in the unit. The display is showing the activity of one RF module at a time, selected by pressing the desired knob. The knobs have multiple functions including volume, channel, display dimmer. The microphone, key line and headphone audio are separate for each of the two or three bands therefore switching from band to band is performed at an audio panel such as the Technisonic A710 series. This allows for separate and simultaneous operation on each of the bands just like having 2 or 3 separate radios. If combined operation is desired, a Technisonic AMS-6000 audio mode selector may be used ahead of the audio controller.

2.2 FRONT PANEL

Refer to the diagrams below:

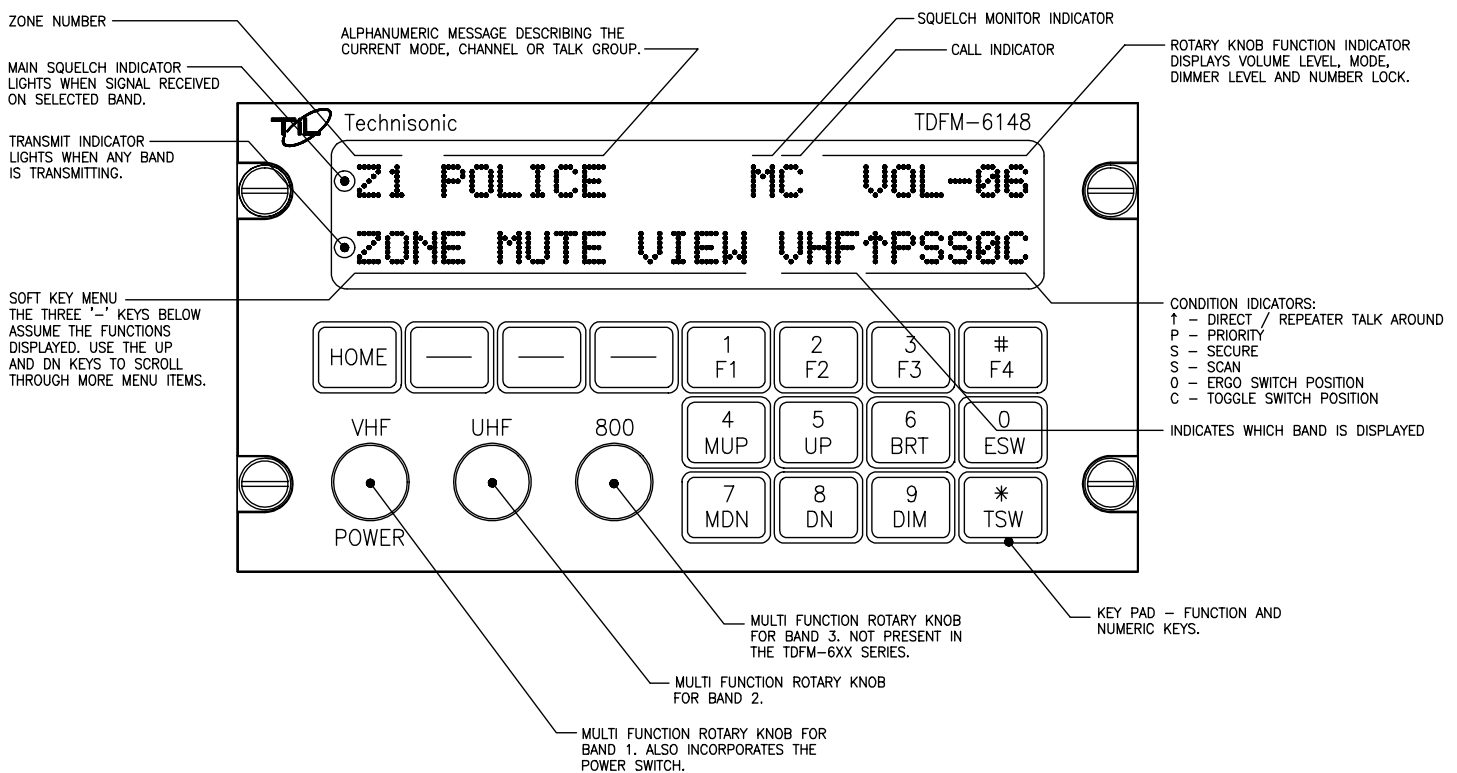

Figure 2-1 Front panel Controls – TDFM-600/6000 Series Transceivers (not including TDFM-636)

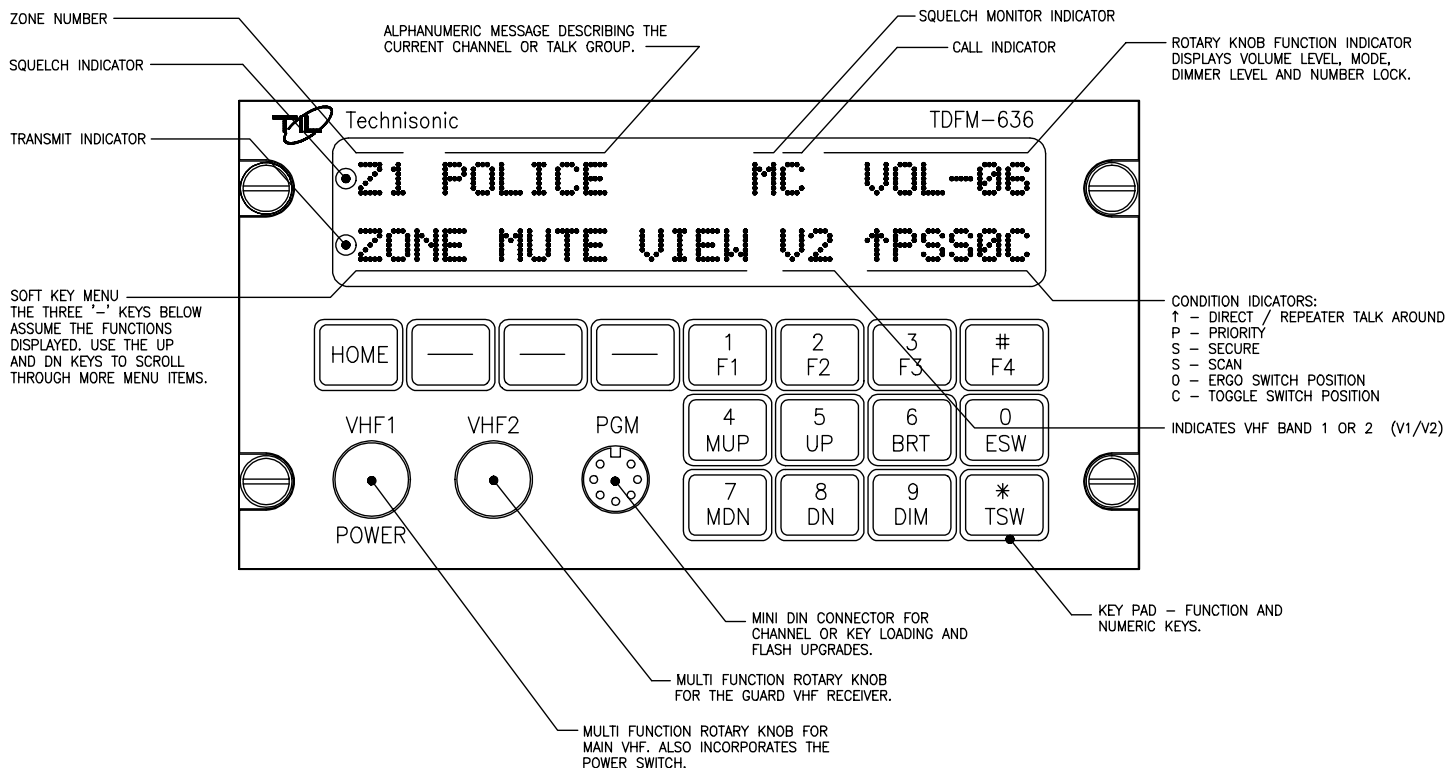

Figure 2-2 Front panel Controls – TDFM-636 Transceiver Only

2.3 POWER SWITCH

To switch the transceiver on, press and hold the left most knob until the radio powers up. The display will show *TECHNISONIC* and the software version installed followed by the model number as determined by which RF modules are installed. The display will then show the normal display for band 1. To switch off the transceiver at any time, press and hold the left most knob for 2 seconds until the display shows *OFF* then release. If it is desired that the radio comes on with the radio master in the aircraft, a power jumper may be installed (see installation instructions) such that the radio is always on.

2.4 KNOBS

The transceiver will have two or three knobs depending on how many RF modules are installed. The knobs are rotary encoders which turn endlessly which means their actual position is not important. Each knob also has a push button incorporated in it so you can press the knob as well as turn it. Pressing a different knob will cause the display and keyboard to switch to the band associated with that knob. The knob will start out as a volume control. Pressing the same knob again will change its function to act as the channel/talkgroup selector depending on how that band is programmed. Pressing the same knob again changes the function of the knob to a display dimmer control. Pressing the knob again causes the key pad function to change from function keys to number keys. The knob in this mode acts as a volume control. Another knob press will bring you the recall mode (if this feature is enabled in the configuration menu). Typing in the channel number will bring you quickly to that channel without scrolling through channels in between. Pressing the knob again brings it back to the first mode of volume control. The current function of the knob is shown at the top right of the display.

The function of the knobs for the unselected bands is always the volume control mode. The starting mode (when the band is selected) of the knob can be programmed in the configuration menu to be VOLUME or CHAN.

2.5 SOFT KEYS AND HOME

The transceiver has three *soft* keys which assume the function shown above them on the display. The functions displayed depend on how the module was programmed with the radio service software (CPS)[™]. Functions can be different on a channel by channel basis as well. These may include:

ZONE - Pressing this function will prompt you for a new zone number which can be entered directly or scrolled using the UP and DN keys.

MUTE - Selecting this function will prompt you for an on or off entry using the soft keys to mute the tones. Tones refer to the beeps heard when pressing buttons.

VIEW - The view function is used to view lists. Lists can include phone numbers, call lists and or page.

PWR - Selecting PWR will allow the power output of the radio to be set to high or low.

PROG - Selecting PROG allows brings you to user programmable features of the radio such as telephone numbers. The ability for the user to program phone numbers, etc can be enabled or disabled by the CPS[™].

FPP – Front Panel Programming mode. Allows you to program channels at the front panel without the customer programming software. This option usually on VHF band 2 (V2) in the TDFM-636 only.

At any time while in one of these functions, you can escape back to the normal mode by pressing the HOME key. When programming the modules with the CPS[™], it is suggested not to double up functions. For example, programming a soft key to CHAN would be redundant since there is already a channel function using the knobs. Using the CHAN soft key would also not update the channel number on the display, causing some confusion.

2.6 FUNCTION KEYS

Four function keys at the top of the keypad provide the same actions as the three side buttons and the top button found on the XTS-3000 or XTS-5000 portable. They are as follows:

F1 - Top side button (purple button) on the portable.

F2 - Center side button (with one dot) on the portable.

F3 - Bottom side button (with two dots) on the portable.

F4 - Top button (orange button) on the portable.

TDFM-600/6000 Transceiver Recommended Keypad Menu Defaults:

TDFM-600/6000 Series Transceiver ITEM	Portable ITEM	Conventional Operation	SmartNet Operation	SMARTZONE Operation
F1 Key	Top Side Button 1	Monitor	Phone	Phone
F2 Key	Center Side Button 2	Scan	Scan	Scan
F3 Key	Bottom Side Button 3	Talkaround/ Direct	Private Call	Site Display/Search
F4 Key	Orange (Top) Button	Emergency	Emergency	Emergency
MUP and MDN keys	16-Position Rotary Knob	Channel Select	Channel Select	Channel Select
ESW Key	Two-Position Concentric or Ergo Switch	Blank (O) Low Power (Ø)	Blank (O) Low Power (Ø)	Blank (O) Low Power (Ø)
TSW Key	Three-Position Toggle Switch	Blank (A) Scan (B) Blank (C)	Blank (A) Scan (B) Blank (C)	Blank (A) Scan (B) Blank (C)

Note: It is possible to use Motorola's Customer Programming Software (CPS™) to alter the default keypad settings of the TDFM-600/6000 series radios. However if custom key settings are chosen it will not be possible for Technisonic to help the Pilot or other Radio User through operational difficulties. These questions will have to be referred to the Radio System Administrator responsible for customising the settings. Technisonic recommends that the default key settings stay in place until all airframe installation and operational issues have been overcome.

The TDFM-600/6000 series Transceivers are programmable by Motorola CPS™. The following settings may be programmed for each Channel in a Conventional Radio:

Tx Frequency	Zone
Tx PL/DPL Code	Channel
Rx Frequency	Name
Rx PL/DPL Code	RX Signal Voice Type
Time-Out Timer	TX Signal Voice Type
Scan List	Network Access Code
Phone	Tx Power
Smart PTT	

The following settings must be programmed for each mode in a Trunked (P25 9600, SmartNet or SMARTZONE) Radio:

System Type	TG Strapping
System ID	Zone
Individual ID	Scan List
Coverage Type	Scan Type
Affiliation Type	Interconnect
Control Channel 1	Phone Display Format
Control Channel 2	Private Call
Talkgroup 1	Private Call Type
Talkgroup 2	Private Call Operation

The function keys along with the rest of the key pad, revert to normal number keys during transmit and when NUM LOCK is selected by pressing the rotary knob.

2.7 MUP AND MDN KEYS

These keys provide the same function as the rotary knob does when it is set to CHAN. This equates to the 16 position rotary knob on the portable. When one of these keys is pressed, the function of the rotary knob is automatically set to CHAN.

2.8 UP AND DN KEYS

The keys provide the same function as the left and right arrow keys on the portable. The UP key equates to the right arrow key. These keys are used for a variety of functions but in the normal mode they are used to scroll through the soft key menus.

2.9 BRT AND DIM KEYS

Use these keys to dim or brighten the display. The radio powers up at full brightness for normal use but can be dimmed for night operations.

2.10 ESW KEY

The ESW key provides the function of the concentric or 'ergo' switch on the portable. The switch has two conditions which are represented by 'O' and 'Ø'. Pressing the ESW key toggles the condition back and forth. The condition is displayed at the bottom of the display, second character from the right. The ergo switch condition is saved when the unit is turned off. There are separate conditions for each band installed. The ESW key can be programmed with the CPS™ to a variety of functions such as low power, scan, channel, and secure mode.

2.11 TSW KEY

The TSW key provides the function of the toggle switch on the portable. The switch has three conditions which are represented by 'A', 'B' and 'C'. Pressing the TSW key toggles the condition A,B,C,A,B, etc. The condition is displayed at the bottom of the display, last character on the right. The toggle switch condition is saved when the unit is turned off. There are separate conditions for each band installed. The TSW key can be programmed with the CPS™ to a variety of functions such as low power, scan, channel, and secure mode.

2.12 DISPLAY

The transceiver has a two line, 48 character LED display which gives information about the selected band. On the top line is shown the zone number, channel name and rotary knob function. The bottom line displays the soft key menu, the band selected, and the ESW/TSW condition. Also displayed are letters and symbols indicating scan, direct/repeater talk around, monitor, secure, priority and call. In addition to the character display, there are two LED indicators on the left. The top LED indicates a signal is being received on the selected band while the bottom LED indicates that any one or more of the installed bands are transmitting.

2.13 GENERAL OPERATION

Switch on the transceiver as described in 2.3. Select the desired band by pressing the appropriate knob. Select the same band on the audio panel. Press the knob again so that CHAN shows up on the top right of the display. Rotate the knob until the desired channel or talk group is selected. Press the knob until VOL is again shown on the display. You can adjust the volume by waiting until a signal is received or by pressing F1 (factory programmed for monitor function) and adjusting the rotary knob. The radio is ready to use. Remember that the band selected by pressing the rotary knobs is what is displayed on the screen but the band selected by the audio panel is band that you are actually transmitting and receiving on. If another band is displayed, the rotary knob for the band you are using is still operating the volume level. To use the DTMF key pad while transmitting, the band you are using must be displayed on the screen.

2.14 CUSTOMER PROGRAMMING SOFTWARE (CPS™)

To make any changes to the programming in the radio, CPS™ software must be used. There is no provision in the radio to allow the user to change frequencies, zones, talk groups, etc. CPS™ software can be purchased from Motorola Customer Service (see following page). A Motorola Radio Interface Box (RIB) is required to connect the computer to the TDFM-600/6000. Each band in the TDFM-600/6000 is considered a type I (XTS-3000) or a type II (XTS-5000) portable by the CPS™ software. To program a band in the transceiver, it must be selected by pressing the appropriate knob before running the CPS™. Follow the instructions supplied with the

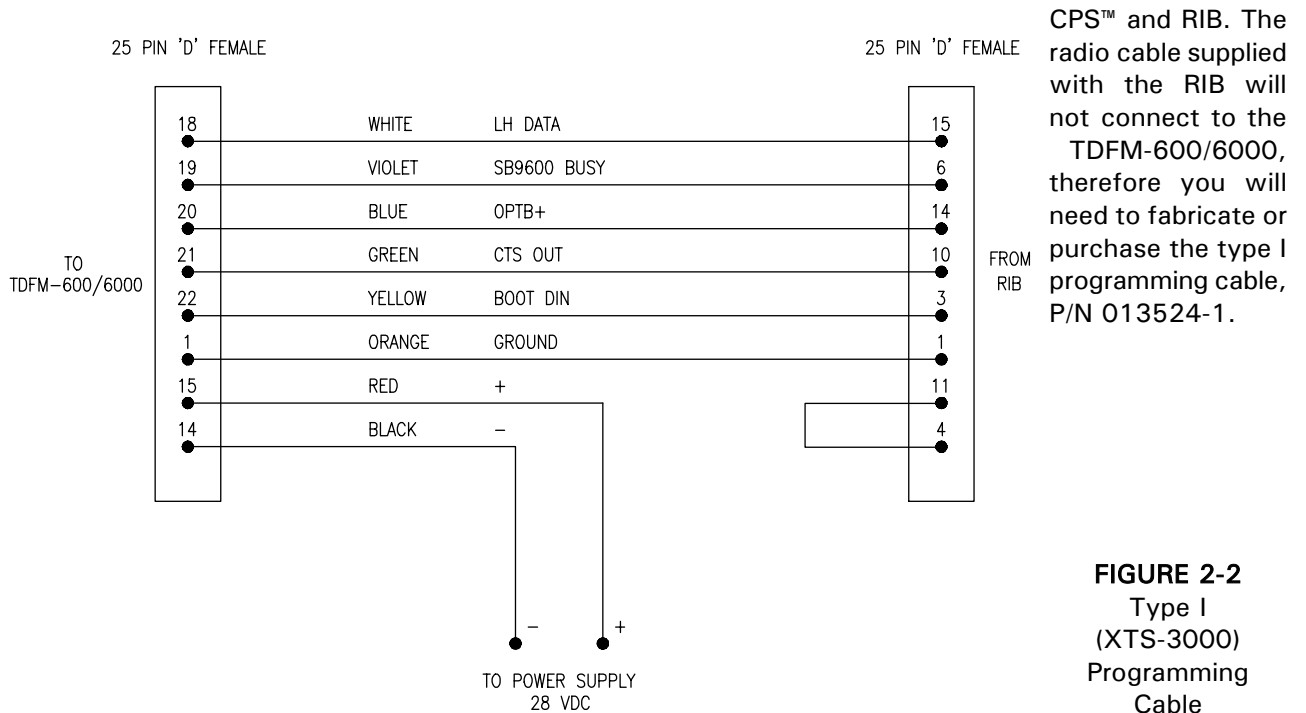

CPS™ and RIB. The radio cable supplied with the RIB will not connect to the TDFM-600/6000, therefore you will need to fabricate or purchase the type I programming cable, P/N 013524-1.

FIGURE 2-2
Type I
(XTS-3000)
Programming
Cable
(Requires RIB)

2.14 CUSTOMER PROGRAMMING SOFTWARE (CPS™) - continued

Programming Cables for units with Type I modules

The following items are Motorola part numbers and are required to program the TDFM-600/6000 with type I modules. They must be purchased from Motorola Customer service (1-888-567-7347).

P/N RVN4182	CPS Programming Software, Note: Latest revision will be provided.
P/N RLN10150	Smart RIB Interface Box
P/N 0180202E27	Smart RIB AC PWR PAC 110V
P/N 3080390B48	Computer RIB Cable

A Technisonic type I programming cable P/N 013524-1 is also required and available from Technisonic. If encryption keys need to be loaded via a KVL-3000, key loader cable P/N 047381-1 may be also be obtained from Technisonic. This keyloader cable will plug into the rear connector of the TDFM-600/6000 transceiver and work with type I or type II modules.

If the AMS-6000 is used with a TDFM-600/6000 transceiver with type I modules the following programming cables plug directly into the AMS-6000 front panel connector. They are available from Technisonic.

P/N 037347-1	AMS-6000 Download/Programming Cable that mates with RIB interface Box to program TDFM-600/6000 units employing type I modules.
P/N 037352-1	AMS-6000 Encryption Keyload Cable that mates with Motorola KVL-3000 Keyloader. Same P/N for type I or type II modules.

Programming cables for units with Type II modules

The TDFM-600/6000 series transceivers that employ type II modules do not require a Smart RIB box, AC power pack or computer RIB cable. A Technisonic PC-6000 II programming cable, P/N 047366-1 and Motorola CPS Programming software, P/N RVN4186 (Latest revision) is all that is required to program transceivers with type II modules. Programming cable P/N 047366-1 must be ordered from Technisonic and cannot be field fabricated. The CPS Programming software P/N RVN4186 must be ordered from Motorola Customer service (1-888-567-7347).

If encryption keys need to be loaded via a KVL-3000, key loader cable P/N 047381-1 may be also be obtained from Technisonic. This keyloader cable will plug into the rear connector of the TDFM-600/6000 transceiver and work with type I or type II modules.

If the AMS-6000 is used with a TDFM-600/6000 transceiver with type II modules the following programming cables plug directly into the AMS-6000 front panel connector. They are available from Technisonic.

P/N 047365-1	AMS-6000/TDFM-636 Download/Programming Cable that mates with PC computer to program TDFM-600/6000 units employing type II modules.
P/N 037352-1	AMS-6000/TDFM-636 Encryption Keyload Cable that mates with Motorola KVL-3000 Keyloader. Same P/N for type I or type II modules.

The TDFM-636 transceiver employs a front panel programming connector identical to the AMS-6000. The above cables can plug directly into the TDFM-636 front panel.

2.15 CONFIGURATION MENU

Some features of the TDFM-600/6000 transceiver can be configured to the user's preference. To enter the configuration menu, turn the unit on while simultaneously pressing the F4, ESW and TSW keys. Hold the keys until the display reads 'Configuration Menu'. The first menu item to show will be **'Knob Default'**. Rotating the left knob will toggle back and forth between 'volume' and 'channel'. This will select which mode the knobs will be in when you select a band or when the radio is first turned on. Press the left knob to accept the desired setting. The next menu item is **'Recall Mode'**. Rotating the left knob will enable and disable this feature. When enabled, a recall mode is added to the available knob functions. Press the left knob to accept the desired setting. The last menu item is the **'Auto reset'** function. Rotating the left knob will toggle the function 'enabled' or 'disabled'. This function should be left enabled. However, if a module has failed or has been removed from the radio, this feature should be disabled to prevent the radio from continuously trying to establish communication with the missing or failed module. Press the left knob to accept the setting. The radio will then power up normally. The radio will keep these settings until they are changed again by the configuration menu.

2.16 FLASH UPGRADE MODE

On occasion it may be required to flash upgrade one or more of the modules in the radio to change or add new features. This can be done using the Motorola RIB box and software supplied in a Motorola flash upgrade kit. The transceiver must be put into flash upgrade mode by turning on the radio while holding the HOME key. Select the band to be upgraded by pressing the desired band knob. Follow the software instructions. During the flash procedure, the software will ask you to turn off and on the radio, use the RESET soft key, do not turn off the transceiver.

2.17 FRONT PANEL PROGRAMMING (FPP) MODE

One of the bands may have the capability to program channel information such as frequencies, PL tones, modulation types, etc from the front panel. 'FPP' will show up as one of the soft menu items at the bottom of the screen. When the FPP soft key is pressed, you will be prompt for channel information. Wait until the cursor is flashing then press 'OK' for the next input or press 'QUIT' to finish and get out of the programming mode. All changes up to that point will be saved. The prompts are as follows:

- TX Frequency – Enter the desired transmit frequency using the numeric key pad. If the frequency entered is not within band limits or not on proper channel spacing, the frequency will automatically be changed to the closest valid channel.
- RX Frequency – Enter the desired receive frequency.
- TX PL – Enter the desired transmit PL tone frequency. After the last digit is pressed the radio will verify that it is a valid frequency and flash the first cursor again. Press 'OK' at this time. The transceiver supports all standard PL tones. (Also known as CTCSS tones) TXPL tones are generally used to open repeaters or in talk groups where the receivers are squelch protected by PL tones. Enter '000.0' for no tone. PL tones are used by analog mode only.
- RX PL – Enter the desired receive PL tone frequency. Enter '000.0' no tone – carrier squelch operation.
- TX DPL – Enter the desired DPL code. You can not have both a PL and a DPL at the same time. The one that is entered last will turn the other off. A DPL of 000 means off. DPL codes are also known as DCS codes.
- RX DPL – Enter the receive DPL code as above.
- TX NAC – Enter the desired transmit P25 NAC code if using digital, otherwise just press 'OK'. The code is hexadecimal therefore the letters A to F could also be used. Press the 'A-F' soft key to use buttons 1-6 as A-F. A NAC or Network Access Code is used like PL tones but are only used by P25 (digital) mode. A value of 293 is considered to be the standard code for open channel.

2.17 FRONT PANEL PROGRAMMING (FPP) MODE - continued

RX NAC – Enter the desired receive P25 NAC code as above.

RX TYPE – Select the receive mode using the UP and DN keys – Analog, digital or mixed.

Mixed mode will allow the receiver to decode analog and P25 digital signals as needed.

TX TYPE – This prompt will only come up if you selected mixed for RX. Select analog or digital.

BANDWIDTH – Select 12.5, 20.0 or 25.0 kHz using the UP and DN keys. Bandwidth may also be called ‘Channel Spacing’.

CHANNEL NAME – Use the UP and DN keys to scroll to the desired letter and press the NXT soft key to get to the next character. Press ‘OK’ when done. There will be a delay while the channel is saved, then the display will return to normal.

The following is a list of the standard PL tones:

<u>Number</u>	<u>Tone</u>	<u>Number</u>	<u>Tone</u>	<u>Number</u>	<u>Tone</u>
01	67.0	13	103.5	25	156.7
02	71.9	14	107.2	26	162.2
03	74.4	15	110.9	27	167.9
04	77.0	16	114.8	28	173.8
05	79.7	17	118.8	29	179.9
06	82.5	18	123.0	30	186.2
07	85.4	19	127.3	31	192.8
08	88.5	20	131.8	32	203.5
09	91.5	21	136.5		
10	94.8	22	141.3		
11	97.4	23	146.2		
12	100.0	24	151.4		

Standard DPL Codes:

017	051	116	156	243	266	346	431	466	612	721
023	053	122	162	244	271	351	432	503	624	731
025	054	125	165	245	274	356	445	506	627	732
026	065	131	172	246	306	364	446	516	631	734
031	071	132	174	251	311	365	452	523	632	743
032	072	134	205	252	315	371	454	526	654	754
036	073	143	212	255	325	411	455	532	662	
043	074	145	223	261	331	412	462	546	664	
047	114	152	225	263	332	413	464	565	703	
050	115	155	226	265	343	423	465	606	712	

SECTION 3

INSTALLATION INSTRUCTIONS

3.1 GENERAL

This section contains information and instructions for the correct installation of the TDFM-600/6000 Transceiver.

3.2 EQUIPMENT PACKING LOG

Unpack the equipment and check for any damage that may have occurred during transit. Save the original shipping container for returns due to damage or warranty claims. Check that each item on the packing slip has been shipped in the container.

3.3 INSTALLATION

The TDFM-600/6000 Transceiver is designed to be dzus mounted and should be installed in conjunction with an IN-600 installation kit. See figure 3-1 for an outline drawing of the unit with dimensions to facilitate the installation.

3.4 INSTALLATION KIT - CONTENTS

The IN-600 installation kit (P/N 019301-1) consists of:

1. One 25 pin Cannon D mating connector (female) complete with crimp pins and hood.
2. 3 BNC connectors.

3.5 ANTENNA INSTALLATION

The type and number of antennas depends on the model of transceiver being installed. The following is a list of recommended antennas for the various RF modules:

VHF	136 to 176 MHz	Comant part # CI-292
UHFLO	403 to 470 MHz	Comant part # CI-275
UHFHI	450 to 512 MHz	Comant part # CI-275
800	806 to 870 MHz	Comant part # CI-306

The antenna should be mounted on the bottom of the aircraft whenever possible. Consult with instructions provided with the antenna. Connect the RF cables to the back of the transceiver using the BNC connectors provided in the installation kit.

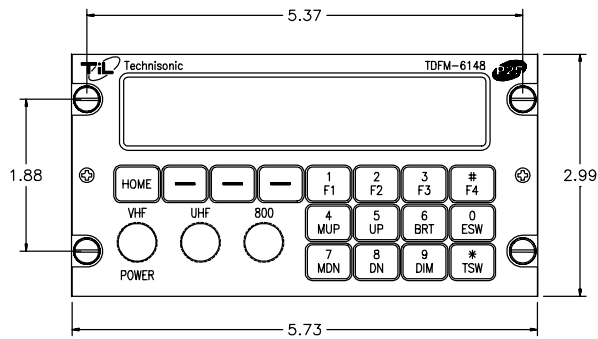
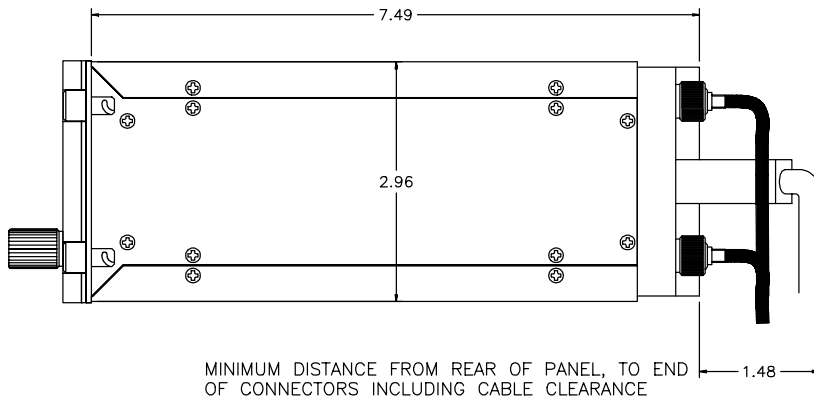
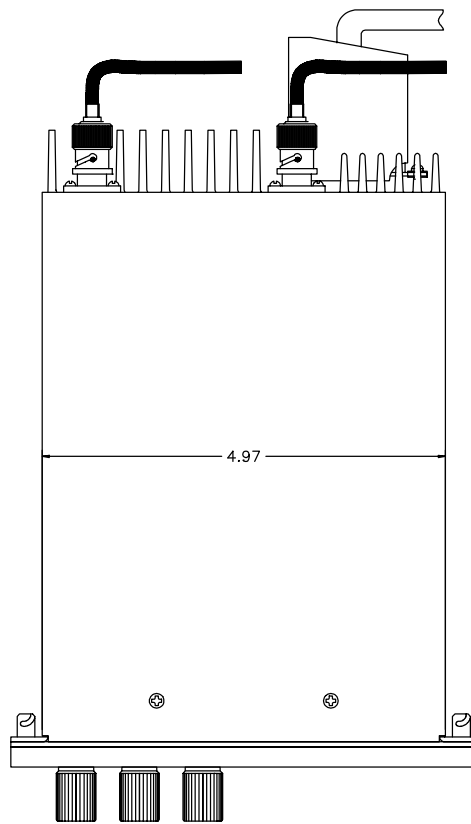

FIGURE 3-1 OutlineDrawing for Model TDFM-600/6000

3.6 INSTALLATION - PIN LOCATIONS AND CONNECTIONS

J1 - 25 Pin D Connections - Use FEMALE Connector	
Pin #	Description
1	Ground
2	Main Power +28 VDC
3	Mic 1
4	Audio 1
5	PTT 1
6	Mic 2
7	Audio 2
8	PTT 2
9	Mic 3 (TDFM-6000 only)
10	Audio 3 (TDFM-6000 only)
11	PTT 3 (TDFM-6000 only)
12	TX Data
13	RX Data
14	Ground
15	Main Power +28 VDC
16	Channel Up
17	Channel Down
18	LH Data
19	SB9600 Busy
20	OPTB +
21	CTS Out
22	Boot DIN
23	RTSBIN
24	RS232DIN
25	Panel Backlighting

TABLE 3-1

3.7 INSTALLATION - WIRING INSTRUCTIONS

Figure 3-2 shows all required connections and recommended wire sizes for the TDFM-600/6000 transceiver.

3.8 MAIN GROUND - PINS 1 AND 14

Both pins should be connected to ground. The main ground is internally connected to the chassis.

3.9 MAIN POWER +28 VDC - PINS 2 AND 15

Both pins should be connected to +28 volts DC +/- 15%.

3.10 MIC 1, 2 AND 3 - PINS 3, 6 AND 9

The microphone input signals shall be connected using shielded wire with the shield connected to ground (pin 1 or 14). It is recommended for best results to leave the other end of the shield floating to prevent ground currents unless you are connecting to an audio panel with floating hi and lo inputs (like the Technisonic A710 or A711 series) in which case the shield must be connected to the lo input.

3.11 AUDIO 1, 2 AND 3 - PINS 4, 7 AND 10

Audio outputs 1, 2 and 3 are 600 ohms impedance against ground. The output power is 500 mW maximum.

3.12 PTT 1, 2 AND 3 - PINS 5, 8 AND 11

The PTT lines should be floating when in receive and grounded for transmit. The input has a pull up resistor to 5 volts. Connecting an audio panel which wishes to see more, may result in no receive audio. Connect a 1N4006 diode in series with the cathode towards the audio panel in this case.

3.13 TX DATA AND RX DATA - PINS 12 AND 13

These are an RS-232 serial port for the RC-6000 remote control head if installed. Consult the RC-6000 installation manual for details.

3.14 CHANNEL UP AND CHANNEL DOWN - PINS 16 AND 17

These pins can be used to scroll up and down through the zone/channel/mode/talk group selections for the band currently displayed on the screen. The inputs normally floating are grounded to activate. Two push buttons or a center off, SPDT, spring loaded toggle switch are typically used on these inputs.

3.15 LH DATA, SB9600 BUSY, OPTB+, CTS OUT, BOOT DIN, RTSBIN AND RS232DIN - PINS 18 THROUGH 24

These pins are used for programming or updating the transceiver using Motorola Radio Service Software (RSS™) or encryption key loading and are generally left unconnected. However, if it is desirable to update the radio without removing it from the aircraft, these lines can be run to a 25 pin D male connector located on the panel where a laptop computer can plug in. Use the same pin numbers so the programming cable described in section 2 can be used (minus the power pins).

3.16 PANEL BACKLIGHTING - PINS 25

Connect to aircraft panel dimming bus. The transceiver comes with either 28 VDC or 5 VAC backlighting circuits. Check the label on the side of the transceiver before applying power.

3.17 POWER JUMPER

The radio must be turned on manually each time the avionics bus is switched on. If it is desired that the radio comes on with the radio master in the aircraft, remove the right side panel from the radio and install a 0.1" jumper across JP1 (two pins) near the rear of the radio on the right side of the MCU board. If you attempt to turn off the radio with the jumper installed, it will just come back on again in 5 seconds.

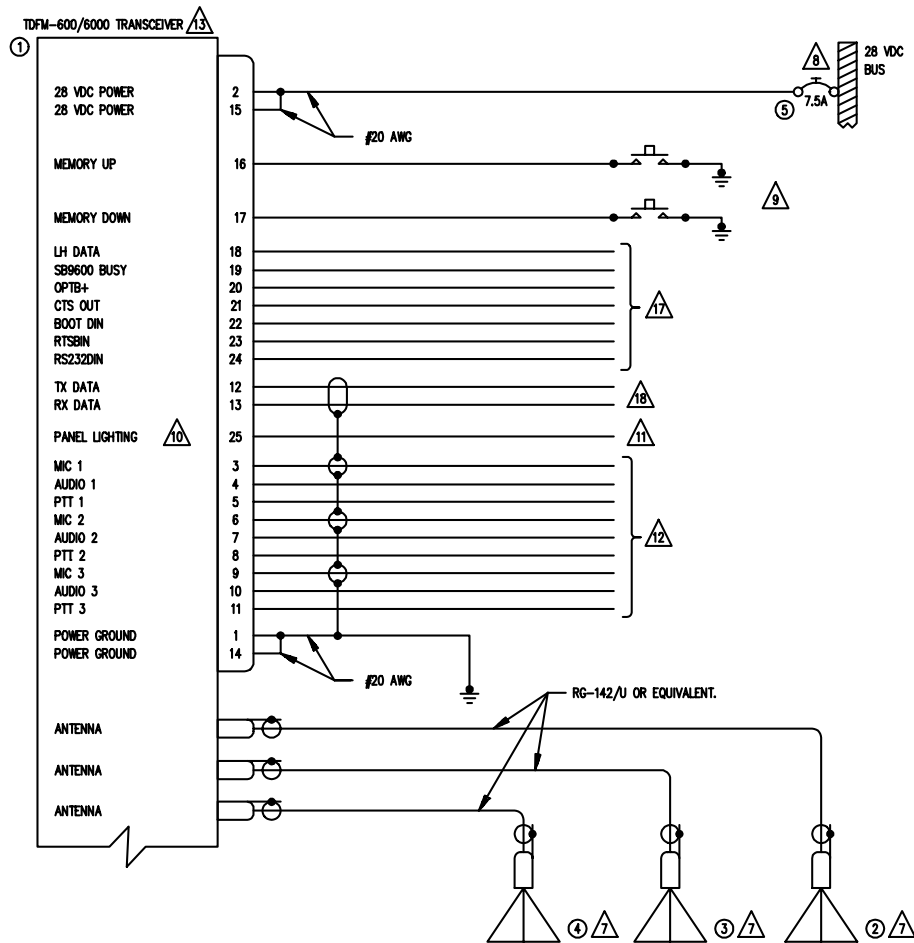

QTY	ITEM	PART NUMBER	DESCRIPTION	SPEC	MATERIAL
1	1	TDFM-600/6000	VHF/FM COMMUNICATIONS TRANSCEIVER.	TECHNISONIC INDUSTRIES LIMITED	
1	2	CI-292	VHF ANTENNA	COMANT INDUSTRIES	
1	3	CI-275	UHF ANTENNA	COMANT INDUSTRIES	
1	4	CI-306	800 ANTENNA	COMANT INDUSTRIES	
1	5	7274-11-7.5	CIRCUIT BREAKER, 7.5 AMPS	KLIXON	

NOTES:

- 1) ALL WIRE IAW MIL-W-22759 UNLESS OTHERWISE SPECIFIED.
 - 2) ALL CABLE IAW MIL-C-27500 UNLESS OTHERWISE SPECIFIED.
 - 3) COAXIAL CABLE IAW MIL-C-17 UNLESS OTHERWISE SPECIFIED. DO NOT USE COAX WITH PVC INSULATION.
 - 4) FABRICATION & INSTALLATION OF WIRING HARNESS IAW AC 43.13-1B CHAPTER 11.
 - 5) GROUNDING AND BONDING IAW AC 43.13-1B CHAPTER 11, SECTION 15.
 - 6) ALL SINGLE WIRE TO BE #22 AWG MINIMUM AND ALL SHIELDED WIRE TO BE #24 AWG MINIMUM, UNLESS OTHERWISE SPECIFIED.
- 7) INSTALLATION OF ANTENNA IAW AC 43.13-1B CHAPTER 4, SECTION 4, CHAPTERS 6 & 7, AND AC 43.13-2A CHAPTER 3. IF POSSIBLE, THE ANTENNA SHOULD BE LOCATED A MINIMUM OF 12 FT FROM AIRCRAFT NAVIGATION RECEIVER ANTENNAS AND A MINIMUM OF 4 FEET FROM AIRCRAFT COMMUNICATIONS AND ELT ANTENNAS. BE CAREFUL NOT TO CHOSE SEPARATIONS THAT CLOSELY APPROXIMATE 1/4 OR 1/2 OR WHOLE NUMBER MULTIPLES OF THE NAVIGATION OR COMMUNICATIONS WAVELENGTH.
- 8) AN EQUIVALENT CIRCUIT BREAKER OR FUSE MAY BE USED.
- 9) THE MEMORY UP/DOWN PUSH BUTTONS ARE OPTIONAL.
- 10) THE TDFM-600/6000 IS AVAILABLE WITH 28V OR 5V PANEL LIGHTING. CHECK THE CONFIGURATION CONTROL LABEL FOR THE CORRECT VOLTAGE.
- 11) CONNECT TO THE APPROPRIATE AIRCRAFT DIMMING BUSS.
- 12) CONNECT TO THE AIRCRAFT AUDIO SYSTEM OR STAND-ALONE HEADSET JACKS.
- 13) INSTALLATION OF TRANSCEIVER IAW AC 43.13-1B CHAPTER 4, SECTION 4 AND AC 43.13-2A, CHAPTER 2. PR3 1/2 DZUS RAIL OR EQUIVALENT MAY BE USED.
- 14) TEST THE SYSTEM IN ACCORDANCE WITH THE POST-INSTALLATION TEST PROCEDURE IN THE INSTALLATION AND OPERATING INSTRUCTIONS MANUAL.
- 15) REFER TO THE AIRCRAFT STRUCTURAL REPAIR MANUAL AND THE MAINTENANCE MANUAL FOR INSTRUCTIONS AND INFORMATION PERTINENT TO THIS INSTALLATION.
- 16) THE USE OF RED DISPLAYS SHOULD BE MINIMIZED OR AVOIDED SO AS NOT TO DETRACT FROM THE ATTENTION GETTING CHARACTERISTICS NEEDED IN WARNING AND CAUTION ANNUNCIATORS. RED SHOULD BE USED TO ANNUNCIATE EMERGENCY CONDITIONS REQUIRING IMMEDIATE RESPONSE BY THE FLIGHT CREW. UNITS WITH RED DISPLAYS SHOULD NOT BE LOCATED IN CLOSE PROXIMITY TO WARNING AND CAUTION ANNUNCIATORS. THE INSTALLATION OF UNITS WITH RED DISPLAYS MUST BE EVALUATED ON A CASE BY CASE BASIS TO ENSURE THAT THE EFFECTIVENESS OF THE WARNING AND CAUTION ANNUNCIATORS IS NOT ADVERSELY AFFECTED.
- 17) OPTIONAL CONNECTION TO A DOWNLOAD PLUG ON THE PANEL.
- 18) CONNECTION TO AN OPTIONAL RC-6000 SLAVE CONTROL HEAD.

FIGURE 3-2 Wiring connections and notes for the TDFM-600/6000 Transceiver

3.18 POST INSTALLATION EMI TEST

PURPOSE

The purpose of this test is to identify any interference that the TDFM-600/6000 transceiver may cause with existing aircraft systems.

TEST CONDITIONS

The TDFM-600/6000 transceiver should be installed and function tested. The antenna VSWR should be checked. A forward/reverse power check with a in-line wattmeter should show no more than 10% reflected power. For the following tests, insure that the output power is set to high.

METHODOLOGY

Most of the EMI tests can be accomplished on the ground. In some cases flight testing is required or is easier. If the aircraft is approved for IFR operations, then it is mandatory that interference between the TDFM-600/6000 transceiver and the approach aids be checked in flight.

The GPS should be operational and navigating with at least the minimum compliment of satellites. The VHF comm should be set to the frequencies indicated with the squelch open. VOR/DME receivers should be set to the frequencies indicated and selected for display. If possible, set up a DME ramp test set on the frequencies indicated and adjust the output until the flags are out of view. The transponder and encoder should be monitored with ramp test equipment. Set the output of the transponder test set to 3db above the output necessary to achieve 90% reply. If possible set the ADF to a nearby navigation station.

Modulate the TDFM-600/6000 transmitter on the indicated frequencies for at least 20 seconds.

Observe the GPS for any degradation in satellite status or availability or flags. Listen for any noise or detected audio signals on the VHF comm(s). Listen for any noise or detected audio signals on the VOR/LOC receiver audio; look for any moment of flags or needles on the VOR/LOC/GS navigation display(s). Observe the transponder for any loss of reply or spurious reply.

List the power plant, fuel and other electric instruments in the chart provided and note any anomalies that occur while transmitting. Assess the results.

If the aircraft is equipped with an autopilot or a stability augmentation system, then test fly the aircraft and verify that operation of the TDFM-600/6000 transceiver does not have adverse effects on these systems. After checking for gross effects at a safe altitude, fly an approach with each of the different navigation systems coupled to the autopilot (ILS, GPS ETC.) and look for any anomalies.

RESULTS

If the installed system passes all of the applicable EMI tests, then no further action is required. If interference is observed then the interference must be assessed against the appropriate standards of airworthiness for the system in question. For example it is permissible for a VFR certified GPS to lose navigation capability while the TDFM-600/6000 unit is transmitting, providing that it recovers properly and promptly, but it is not permissible for an IFR Approach certified GPS to be affected in the same way. A complete discussion of all the standards of airworthiness to be applied in assessing EMI effects is beyond the scope of this document.

PROCEDURE

- A. Operate the TDFM-600/6000 transmitter on the following frequency for at least 20 seconds. Observe the GPS for any degradation in satellite status or availability or flags.

FREQUENCIES	GPS #1		GPS #2	
	PASS	FAIL	PASS	FAIL
TDFM-600/6000				
143.2125 MHz				
143.2250 MHz				
157.5375 MHz				
157.5500 MHz				
512 MHz				

NOTES:

- B. Determine if the image frequency for the VHF Comm falls within the range of the TDFM-600/6000. If so, select a set of frequencies that will cause the TDFM-600/6000 to be set as close as possible to the image frequency. Any one of the many possible sets will suffice. Record those values in the spaces provided in the following chart. Modulate the TDFM-600/6000 transmitter on the following frequencies for at least 20 seconds. Listen for any noise or detected audio signals on the VHF comm.

Example - Bendix/King KY 196A:

The first IF frequency is 11.4 MHz. The L.O. is above the received frequency (high side injection), therefore the image frequency is 22.8 MHz above the selected frequency. Set the KY 196A to 120.000 MHz and the TDFM-600/6000 to 142.8000 MHz.

FREQUENCIES		RESULTS	
VHF #1	TDFM-600/6000	PASS	FAIL
135.975	136.0000		
121.150	157.5000		
131.250	157.5000		
Image:			

FREQUENCIES		RESULTS	
VHF #2	TDFM-600/6000	PASS	FAIL
135.975	136.0000		
121.150	157.5000		
131.250	157.5000		
Image:			

NOTES:

- C. Determine if the image frequency for the VOR/ILS Nav falls within the range of the TDFM-600/6000. If so, select two sets of frequencies that will cause the TDFM-600/6000 to be set as close as possible to the image frequency. Choose one set in the localizer frequency range and one in the VOR frequency range. Record those values in the spaces provided in the following chart. Modulate the TDFM-600/6000 transmitter on the following frequencies for at least 20 seconds. Listen for any noise or detected audio signals on the receiver audio; look for any moment of flags or needles on the navigation display.

FREQUENCIES		RESULTS	
VOR/ILS #1	TDFM-600/6000	PASS	FAIL
108.000	162.0000		
108.100	162.1500		
Image:			

FREQUENCIES		RESULTS	
VOR/ILS #2	TDFM-600/6000	PASS	FAIL
108.000	162.0000		
108.100	162.1500		
Image:			

NOTES:

- D. Modulate the TDFM-600/6000 transmitter on the following frequencies for at least 20 seconds. Observe the Glideslope displays. Look for any movement of flags or needles on the navigation display.

FREQUENCIES		RESULTS	
G/S #1	TDFM-600/6000	PASS	FAIL
334.7 (108.1)	167.35		

FREQUENCIES		RESULTS	
G/S #2	TDFM-600/6000	PASS	FAIL
334.7 (108.1)	167.35		

NOTES:

- E. Operate the TDFM-600/6000 transmitter on the following frequency for at least 20 seconds. Observe the Transponder for any spurious replies or loss of reply to test set.

FREQUENCIES	TRANSPONDER #1		TRANSPONDER #2	
	PASS	FAIL	PASS	FAIL
512 MHz				

NOTES:

- F. Modulate the TDFM-600/6000 transmitter on the following frequencies for at least 20 seconds. Observe the DME displays. Look for loss of distance information on the display.

FREQUENCIES		RESULTS	
DME 1	TDFM-600/6000	PASS	FAIL
978 (108.0)	489		
1020 (112.1)	510		

FREQUENCIES		RESULTS	
DME 2	TDFM-600/6000	PASS	FAIL
978 (108.0)	489		
1020 (112.1)	510		

NOTES:

NOTE:

For the following tests, select a frequency at the top, middle and bottom of each band of the TDFM-600/6000 transceiver.

	136 to 178 MHz Band	403 to 470 MHz Band	450 to 512 MHz Band	806 to 870 MHz Band
Frequency #1				
Frequency #2				
Frequency #3				

- H. At a safe altitude engage the autopilot or stability augmentation system. Modulate the TDFM-600/6000 transmitter on the above frequencies for at least 20 seconds. Observe any effect on the autopilot or stability augmentation system.

Observations:

- I. Perform a coupled ILS approach to the aircraft's certified limits. Modulate the TDFM-600/6000 transmitter on the above frequencies for at least 20 seconds. Observe any effect on the autopilot. Repeat for second flight director/autopilot if equipped.

Observations:

J. List the power plant, fuel and other electric instruments in the chart provided and note any anomalies that occur while transmitting. Assess the results.

STEP	SYSTEM	PASS	FAIL	NOTES
1	Com 1&2 (UHF Lo, UHF Hi, and 800 MHz)			
2	Transponder & Encoder (VHF, UHF Lo, and 800 MHz)			
3	ADF 1 & 2			
4	VG			
5	Glideslope 1&2 (UHF Lo, UHF Hi, and 800 MHz)			
6	VOR/LOC 1&2 (UHF Lo, UHF Hi, and 800 MHz)			
7	Compass			
8	Directional Gyro			
9	Fuel Pressure			
10	Oil Temp			
11	Amps			

STEP	SYSTEM	PASS	FAIL	NOTES
12	Bus Voltage			
13	Fuel %			
14	Ng			
15	TOT			
16	Torque %			
17	Annunciators			
18	Digital Clock			
19	Oil Pressure			
20	DME 1&2 (VHF, UHF Lo, and 800 MHz)			
21	GPS 1&2 (UHF Lo and 800 MHz)			

STEP	SYSTEM	PASS	FAIL	NOTES

NOTES: