

# VHF/AM SINGLE CHANNEL 50 WATT TRANSCEIVER MODEL TSC-4400

P/N 011211-1

## Installation and Operating Instructions

TiL Document No.  
04RE331  
Rev. n/c

November 2004

**Technisonic Industries Limited**

240 Traders Blvd., Mississauga, Ontario L4Z 1W7 Tel:(905)890-2113 Fax:(905)890-5338  
web site: [www.til.ca](http://www.til.ca)

**WARNING**

Do not make physical contact with antenna when transmitter is on. This unit can produce over 50 watts of power when transmitting.

**CAUTION**

This unit contains static sensitive devices. Wear a grounded wrist strap and/or conductive gloves when handling printed circuit boards.

# **! CAUTION !**

## **ANTENNA *MUST* BE CONNECTED TO THE TRANSCEIVER BEFORE TURNING POWER ON**

**WARRANTY INFORMATION**

The rack mounted Single Channel Transceiver, Model TSC-4400 is under warranty for one year from date of purchase. Failed units caused by defective parts, or workmanship should be returned to:

**Technisonic Industries Limited**

240 Traders Blvd  
Mississauga, Ontario  
L4Z 1W7 CANADA

Tel: (905) 890-2113  
Fax: (905) 890-5338

REVISIONS				
REV	PAGE	DESCRIPTION	DATE	APPROVED
N/C		Original Issue	11/04	RR HD

## TABLE OF CONTENTS

Paragraph	Title	Page
<b>SECTION 1 GENERAL DESCRIPTION</b>		
1.1	Introduction . . . . .	1-1
1.2	Description . . . . .	1-1
1.2.1	Transceiver Module . . . . .	1-2
1.2.2	Power Supply Module - P/N 043603-1 . . . . .	1-2
1.2.3	RF Amplifier Modules - P/N 043604-1 (Model PA-50) . . . . .	1-2
1.2.4	Mother Board - P/N 033588-1 . . . . .	1-2
1.2.5	Remote Control Boards . . . . .	1-2
1.2.6	Crystal Filter (Option 1) . . . . .	1-3
1.3	Modes of Operation . . . . .	1-3
1.3.1	Local/Remote Operation . . . . .	1-3
1.3.1.1	Conference Audio . . . . .	1-4
1.3.2	AC and DC Operation . . . . .	1-4
1.4	Technical Summary . . . . .	1-4
<b>SECTION 2 PREPARATION FOR USE AND STORAGE</b>		
2.1	Introduction . . . . .	2-1
2.2	Disassembly/Assembly . . . . .	2-1
2.2.1	Remove/Replace Cover Assembly . . . . .	2-1
2.2.2	Remove/Replace Transceiver Module . . . . .	2-1
2.2.3	Remove/Replace Memory Set Board Module A5A1 . . . . .	2-3
2.2.4	Remove/Replace Control Board . . . . .	2-3
2.2.5	Remove/Replace Crystal Filter Board, P/N 923069 . . . . .	2-5
2.3	Channel Frequency Programming . . . . .	2-5
2.3.1	Introduction . . . . .	2-5
2.3.2	Frequency Range . . . . .	2-5
2.3.3	Frequency Programming Requirements . . . . .	2-5
2.3.4	Programming a Frequency . . . . .	2-7
2.4	Remote Operation Set Up . . . . .	2-8
2.4.1	Remote Control Board P/N 923051-1 . . . . .	2-9
2.4.2	Remote Control Board P/N 943180-1 . . . . .	2-10
2.5	Optional Loudspeaker, Headphone Installation . . . . .	2-13
2.5.1	External Loudspeaker . . . . .	2-13
2.5.2	Headset . . . . .	2-13
2.6	Transceiver Adjustments and Settings . . . . .	2-13
2.7	Operational Check . . . . .	2-13
2.8	Storage . . . . .	2-13

## TABLE OF CONTENTS (Continued)

Paragraph	Title	Page
<b>SECTION 3 OPERATING INSTRUCTIONS</b>		
3.1	Introduction . . . . .	3-1
3.2	Installation . . . . .	3-1
3.3	Operator's Switches, Controls and Indicators . . . . .	3-1
3.4	Operating Instructions . . . . .	3-5
3.4.1	Transmitter Operation (Local Mode) . . . . .	3-5
3.4.2	Receiver Operation (Local Mode) . . . . .	3-6
3.4.3	Switching OFF . . . . .	3-6
3.4.4	External DC Operation . . . . .	3-7

## LIST OF TABLES

Table No.	Title	Page
1-1	TSC-4400 Configurations . . . . .	1-1
1-2	TSC-4400 Leading Particulars . . . . .	1-5
2-1	ICAO Frequency Pairing Plan . . . . .	2-6
2-2	Remote Control Connector Functions . . . . .	2-8
2-3	Remote Control Board P/N 923051-1 Settings . . . . .	2-9
2-4	Remote Control Board P/N 943180-1 Settings . . . . .	2-10
3-1	Operator's Switches, Controls and Indicators . . . . .	3-3

## LIST OF ILLUSTRATIONS

Figure No.	Title	Page
2-1	Single Channel Transceiver - Internal View . . . . .	2-2
2-2	Programming Adapter / Crystal Filter Board . . . . .	2-4
2-3	Remote Control Board P/N 923051-1 . . . . .	2-11
2-4	Remote Control Board P/N 943180-1 . . . . .	2-12
2-5	Transceiver Adjustments and Settings . . . . .	2-14
3-1	Single Channel Transceiver Controls and Indicators . . . . .	3-2

## SECTION 1

# GENERAL DESCRIPTION

### 1.1 INTRODUCTION

This publication provides general information on the VHF/AM Single Channel Transceivers, Model TSC-4400, Part No. 011211-1, manufactured by Technisonic Industries Limited. This document covers the configuration of this equipment that utilizes either of the following remote control cards; p/n's 923051-1 (standard) or 943180-1 (supplied upon request). These cards allow the transceiver to be remotely controlled over 600 ohm dedicated lines using a variety of keying methods.

The Model TSC-4400 Transceiver is a simplex, single channel, fixed frequency transceiver operating over the frequency range of 118.000 MHz to 138.000 MHz. These units are intended for base station operation in an air traffic environment. These systems can operate from AC power or external DC power in local and remote operating modes.

### 1.2 DESCRIPTION

The TSC-4400 is a fully pre-programmable 50 Watt transceiver. It can be configured for 2 Wire and 4 Wire remote operation with a variety of remote keying methods (with 923051-1 standard card). The transceiver consists of a Power Supply Module, Mother Board, a Remote Control Board and a 50 Watt RF Amplifier Module.

To improve the rejection of interfering signals, dual conversion receiver technology has been incorporated on the Transmitter/Receiver (Module A1) board used in the TSC-4400. The second IF is 455kHz using a ceramic filter, which is immune to high energy ringing. The dual conversion module also has a second local oscillator, second mixer and ceramic filter. The first local oscillator is the original VCO.

TABLE 1-1 TSC-4400 CONFIGURATION				
System	Motherboard w/ 25 pin connector	AC Power supply module	RF Amplifier	Remote Control Cards
TSC-4400	033588-1	043603-1	Model PA-50 043604-1	P/N 923051-1 or P/N 943180-1 (upon request)

### **1.2.1 Transceiver Module**

The Single Channel Transceiver is based on Transceiver Model 90-6R/8.33. The transceiver module is a low power VHF/AM transceiver which can transmit or receive on independent, pre-programmable synthesized frequencies, with 25kHz or 8.33kHz channel spacing in the frequency range 118.000 MHz to 138.000 MHz. The operating frequency can be easily programmed using a PC via the front panel mounted serial DB-9 connector.

### **1.2.2 Power Supply Module - P/N 043603-1**

The Power Supply Modules provide the DC supply voltage to the transceiver and linear amplifier, and houses a battery charger which can provide charging and trickle charging to external rechargeable batteries. The external DC supply must consist of both 48Vdc and 12Vdc external batteries. The power supply will accept an input supply voltage between 110-240VAC and will autorange.

### **1.2.3 RF Amplifier Modules - P/N 043604-1**

The RF Amplifier (Model PA-50) modules provide 50 Watts of power output. The RF Amplifier is fed by the 7 Watt RF output from the transceiver module. An internally mounted RF Relay bypasses the RF Amplifier when in receive mode. The output of the amplifier can vary from 25-50 watts by adjusting the transceiver module RF output between 2-7 watts.

### **1.2.4 Mother Board, P/N 033588-1**

Mother Board, p/n 033588-1 is supplied with the two available remote control cards and supports both a 25 pin "D" and 9 pin Positronics remote connectors on the back of the transceiver chassis. A RJ11 style connector is also provided which supports only 2-wire audio signals. The Mother Board provides all interconnection between the three external remote control connectors, RF Amplifier Module, Power Supply, Remote Control Board, and Transceiver. The Remote Control Boards, RF Isolator and all internal fuses are mounted on the Mother Board.

### **1.2.5 Remote Control Boards**

#### **1. Line Interface Board P/N 923051-1**

Provides remote control transceiver operation on 2 wire or 4 wire 600 ohm lines. This board can be configured to key the transmitter using a 2175 Hz\* continuous tone (see below), plus/minus DC Voltages, ground keying and internal or external DC (15 mA) current loop keying. Transmit and Receive audio is user selectable for two wires or four wires. \*Crystals for tone frequencies other than 2175 Hz may be obtained by special order (ie/2380 Hz).

## 2. Line Interface Board P/N 943180-1

Provides remote control transceiver operation on 2 wire dedicated 600 ohm lines utilizing the EIA multi-tone keying format found in the Land Mobile Industry. A high level 2175 tone followed by a 1950 Hz guard tone and then a low level 2175 Hz continuous tone is utilized to key the transceiver. The 943180-1 board can also be jumper strapped for standard aeronautical 2175 Hz continuous tone operation. DC (15mA) current loop and ground keying is also supported. However this board does not support 4wire operation.

**NOTE** P/N 923051-1 is the default board supplied in all units. The EIA multi-tone board P/N 943180-1 must be special ordered. To determine which remote card your 92-SC has installed the Configuration label on the side of the rack mount chassis should be consulted.

### 1.2.6 Crystal Filter Board Assembly P/N 923069-1

Additional selectivity during receive operation may be obtained using an optional 25 kHz crystal bandpass filter. An 8.33 kHz bandpass filter is not available. Crystal filters are cut to the required operating frequency and require 6-8 weeks lead time. This item is interchangeable in the field. Refer to Paragraph 2.2.5 for replacement instructions. If no crystal filter option is ordered, jumper board assembly P/N 923074-1 is installed.

## 1.3 MODES OF OPERATION

### 1.3.1 Local/Remote Operation

#### **NOTE**

**Local operation is not disabled when operating in Remote mode and Remote operation is not disabled when operating in Local mode. The two operating modes operate in parallel.**

1. LOCAL OPERATION - In local operation, voice audio, and keying (PTT) functions are routed from the microphone (not supplied) to the transceiver. Receive audio is routed to the internal loudspeaker and phone jack located on the front panel.
2. REMOTE OPERATION - In Remote operation, transmit audio, keying (PTT), and receive audio functions are routed over land lines to the 600 ohm remote inputs. Internal jumpers can be set for  $\pm$  DC, ground, or tone transmitter keying, and to provide a DC squelch signal and RF Output Power signal depending on the remote control board installed. Receive audio is routed to the internal loudspeaker and is adjustable by the volume control. Transmit audio is also routed to the internal loudspeaker at an internally adjustable preset level (see conference audio).



### 1.3.1.1 Conference Audio (Optional)

NOTE: This feature is only provided upon special order. The component (R7) discussed below is left unpopulated on standard configuration radios.

Conference Audio provides the operator with Tx voice on the transceiver speaker when the transmitter is remotely keyed from another location. The audio level of the transmit audio is internally adjustable from 0.0W to 0.5W of audio output. The adjustment is performed via rotation of the potentiometer R7 (see Figure 2-5 for location), which is accessible from the top of the transceiver after removing the top dust cover of the unit.

NOTE: The transmit audio level can be increased by rotating potentiometer R7 clockwise and decreased by counterclockwise rotation. If further adjustment of conference audio is required, the top cover of the transceiver module must be removed to gain access to potentiometer R63, located on the Audio Interface Module, A3 (see Figure 2-5 for location).

### 1.3.2 AC and DC Operation

The unit can be operated by external 120/240 VAC or external 48 VDC & 12 VDC. The AC power supply will automatically set for operation on 120 VAC or 240 VAC as required.

1. AC OPERATION - During AC operation, the unit can charge and trickle charge external batteries via the external connectors mounted on the rear panel of the unit. Refer to section 3 for remote connector pin details regarding DC operation.
2. DC OPERATION - The unit can be operated from an external DC supply which provides 48VDC(nominal) and 12VDC(nominal).

### 1.4 TECHNICAL SUMMARY

A summary of electrical, operational, mechanical and physical characteristics of the Single Channel Transceiver are provided in Table 1-2.

**TABLE 1-2 TSC-4400 LEADING PARTICULARS**

**POWER REQUIREMENTS:**

AC Input Voltage/Current . . . . .	100 to 260 VAC @ 3.5 Amp
DC Input Voltage/Current . . . . .	48 VDC Nominal @ 5.0 Amp
. . . . .	12 VDC Nominal @ 5.0 Amp

**POWER OUTPUT:**

Adjustable . . . . .	25-50 Watts
Output Impedance . . . . .	50 Ohms
Microphone Compression Range . . . . .	35 dB
Battery Charger Current (48V and 12V, Each) . . . . .	2.0 Amps MAX

**REMOTE CONTROL BOARD, P/N 923051-1 specifications:**

Remote Audio Input . . . . .	2 or 4 wire (selectable), balanced 600 S lines
Remote Tx Timeout . . . . .	30 to 300 seconds

**Tone Keying:**

Impedance . . . . .	600 S floating with respect to ground
Tx Control Tone . . . . .	2175 Hz, standard
Tx Tone Input Level . . . . .	0 to -40 dBm
Tx Tone Control Response Time . . . . .	< 12 milliseconds
DC Keying . . . . .	± 48 Vdc
Loop Resistance . . . . .	10 KS MAX
Ground Keying . . . . .	Closure to Ground
Loop Resistance . . . . .	4 KS MAX

**Remote RX:**

Range . . . . .	+ 10 dBm to -15 dBm (Factory set to -10dBm)
Impedance . . . . .	600 S floating with respect to ground

**RX/TX Interface Signals:**

Squelch Signal . . . . .	Ground, Open circuit for Mute
TX RF Output Signal . . . . .	RF ON= Ground, RF OFF= Open Circuit
AGC Signal Output . . . . .	Linear 0 to + 6 Vdc

**Temperature & Humidity:**

Operating Temperature Range . . . . .	-25EC(-13EF) to + 55EC(+ 131EF)
Storage Temperature Range . . . . .	-55EC(-67EF) to + 65EC(+ 149EF)
Relative Humidity (Non-Condensing) . . . . .	95%

**Dimensions & Weight:**

Width . . . . .	483 mm (19.0 in) MAX
Height . . . . .	89 mm (3.5 in) MAX
Depth . . . . .	432 mm (17.0 in) MAX
Weight . . . . .	11 Kg (20 lbs) MAX

**TABLE 1-2 TSC-4400 LEADING PARTICULARS (Continued)**

**TRANSCEIVER MODULE:**

**Dimensions & Weight:**

Width . . . . .	216 mm (8.5 in) MAX
Height . . . . .	70 mm (2.75 in) MAX
Depth . . . . .	260 mm (10.25 in) MAX
Weight . . . . .	1.8 Kg (3 lb 15 oz) MAX

**TRANSMITTER:**

Power Output . . . . .	Adjustable 2-7 Watts
Audio Input . . . . .	0.05 Vrms to 2.0 Vrms
Speech Processor Dynamic Range . . . . .	35 dB
Modulation . . . . .	95% MAX
Audio Distortion @ 90% mod (Low Power) . . . . .	7% MAX
Audio Distortion @ 90% mod (with Linear Amplifier at High Power) . . . . .	10% MAX
Audio Frequency Response . . . . .	300 Hz to 2,500 Hz, + 1, -3 dB
Spurious Emissions . . . . .	60 dB below carrier
Hum and Noise . . . . .	45 dB below modulated carrier

**RECEIVER:**

RF Input Impedance . . . . .	50S, VSWR 2:1 MAX
Sensitivity (12 dB SINAD) @ 1 kHz 30% Mod . . . . .	1.5 µvolts
Selectivity, 25 kHz Channel Spacing:	
Bandwidth at 6 dB Points . . . . .	Greater Than 15 kHz
Bandwidth at 60 dB Points . . . . .	Less Than 22 kHz
Selectivity, 8.33 kHz Channel Spacing:	
Bandwidth at 6 dB Points . . . . .	Greater Than 10 kHz
Bandwidth at 60 dB Points . . . . .	Less Than 15 kHz

Adjacent Channel Selectivity (25kHz and 8.33kHz) . . . . .	Greater Than 80 dB
Spurious Response Attenuation . . . . .	Greater than 90 dB
Frequency Stability (-40EC to + 55EC) . . . . .	± 1,000 Hz MAX
RF AGC (5 µvolts to 1 volt) . . . . .	Audio Level change of less than 3 dB
Intermodulation:	
Ultimate Sensitivity . . . . .	70 dB
30 µvolts . . . . .	45 dB
300 µvolts . . . . .	30 dB
Unwanted Radiation . . . . .	Less than 80 µvolts into 50 S
Hum & Noise @ 1mV RF 30% MOD . . . . .	40 dB

Loudspeaker Output . . . . .	3 W MAX
Phone Output . . . . .	100 mW into 600 S
Audio Distortion 1mV RF Input, 30% MOD . . . . .	3% MAX
Audio Distortion 1mV RF Input, 90% MOD . . . . .	5% MAX
Audio Output Limiting . . . . .	Less than 1 dB @30 to 100% MOD
Audio Frequency Response 300 Hz-2500 Hz . . . . .	+ 1 -3 dB
Audio Acquisition Time . . . . .	Less than 50 msecs
Audio Squelch Characteristics:	
Squelch Type . . . . .	Noise and Carrier Operated
Carrier Operated Squelch . . . . .	Adjustable 1 to 10 µvolts

## SECTION 2

# PREPARATION FOR USE AND STORAGE

## 2.1 INTRODUCTION

This section provides the information required for custom configuration and storage of the Single Channel Transceiver. Custom system configuration includes customizing remote control board functions, and Transmit/Receive frequency selection.

**CAUTION:** Antenna must be connected to transceiver before transmitting or permanent damage to the output stage may occur.

## 2.2 DISASSEMBLY/ASSEMBLY (Refer to Figure 2-1)

### 2.2.1 Remove/Replace Top Dust Cover Assembly

#### REMOVAL

- (1) Remove and retain twelve screws securing top dust cover to the 19" rack chassis.
- (2) Please note the location of the three longer screws which travel through the heatsink shims rivetted to the inside of the top cover.
- (3) Lift cover clear of chassis to expose internal view of transceiver as shown in Figure 2-1.

#### REPLACEMENT

- (1) Position top cover on chassis.
- (2) Position one screw in each corner of the top cover mounting holes. Place the three longer screws into their correct holes located over the internal transceiver module.
- (3) Secure cover to chassis with remaining screws.

### 2.2.2 Remove/Replace Transceiver Module

#### REMOVAL

- (1) Remove dust cover as described in paragraph 2.2.1.
- (2) Disconnect RF and DC connectors from rear of transceiver module.
- (3) Remove and retain the screws securing the top cover of the internal transceiver module.
- (4) Remove and retain two screws and two washers securing flat cable to the side of the transceiver module and disconnect the flat cable. Disconnect the flat cable running out of the transceiver module at the connector on the external memory set board.
- (5) Remove and Retain four countersunk screws securing transceiver module to front panel.

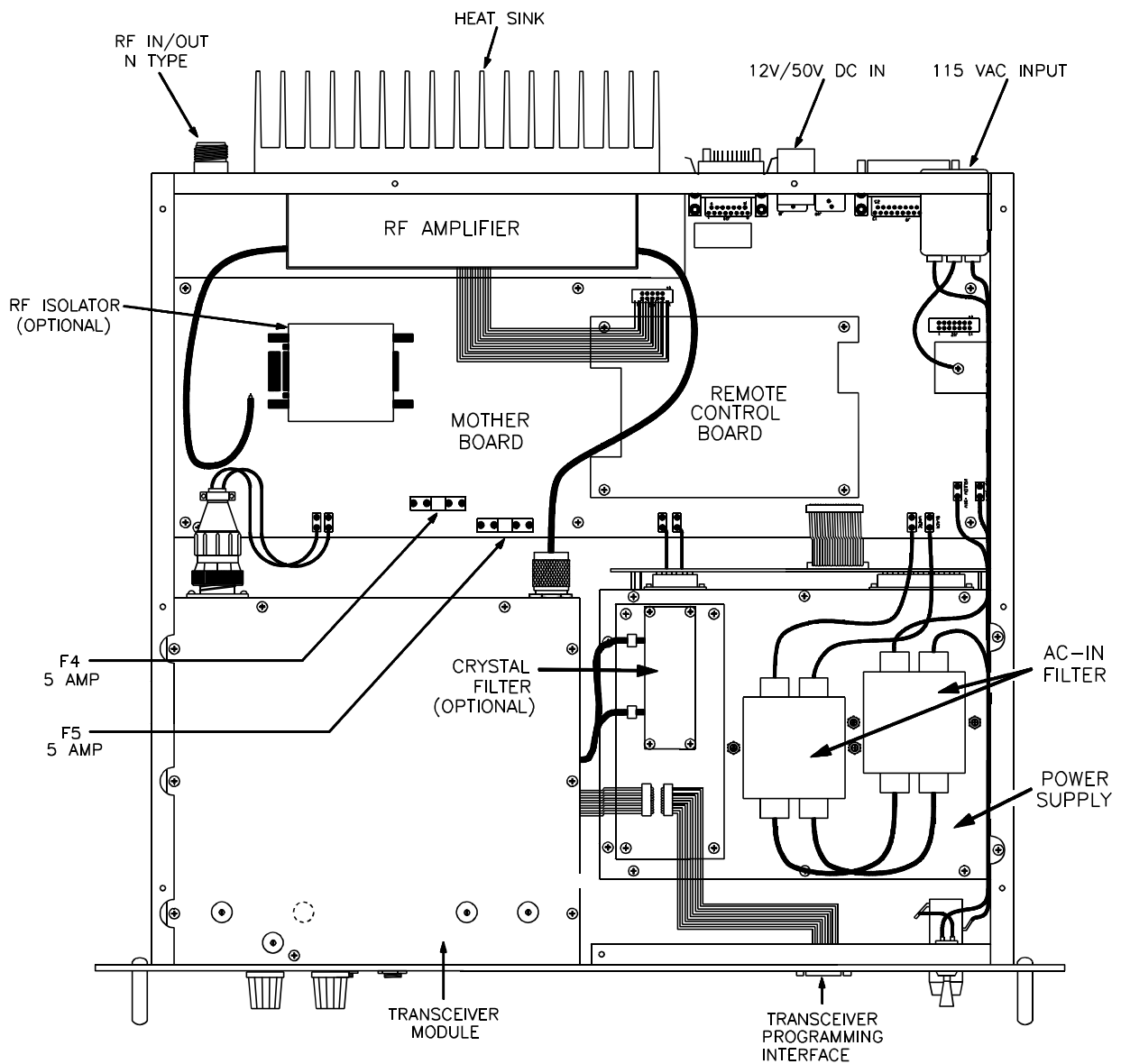

Figure 2-1 Single Channel Transceiver - Internal View

- (6) Move the transceiver module slightly back from the front panel and disconnect the flat cable connecting the front panel assembly to the transceiver module, audio interface board A3. The connector is located on the A3 board.
- (7) Lift transceiver module clear of chassis.

#### REPLACEMENT

- (1) Position the transceiver module into the chassis. While holding the transceiver module slightly back from the front panel, re-connect the flat cable from the front panel to the A3 board in the transceiver module.
- (2) Position and secure transceiver module to front panel with four countersunk screws.
- (3) Re-connect flat cable to transceiver module. Secure flat cable to the side of transceiver module with two screws and two washers. Connect flat cable running out of the transceiver module to the external memory set board. Connect DC and RF connectors to rear of transceiver module.
- (4) Replace and secure the top cover of the transceiver module with the screws removed in step (3) of the REMOVAL instructions. Replace top dust cover as described in paragraph 2.2.1.

### 2.2.3 Remove Replace External Single Channel Memory Set Module A5A1

#### REMOVAL

- (1) Remove dust cover as described in paragraph 2.2.1, remove top cover of transceiver module.
- (2) Disconnect the two crystal filter co-axial cable leads for jumper J2/P3 on the Rx/Tx module A1, located in the transceiver module.
- (3) Remove and retain four screws securing Memory Set Board, Module A5A1 "piggy back" to the standoffs on the power supply cover. (See Figure 2-1 for location).

#### REPLACEMENT

- (1) Secure the Memory Set Module to the stand-offs located on the power supply cover by the four screws. Re-connect coaxial leads for RF crystal filter.

### 2.2.4 Remove/Replace Control Board

#### REMOVAL

- (1) Remove dust cover as described in paragraph 2.2.1.

**CAUTION** Care must be taken when removing or replacing Control Board to avoid damage to Motherboard Connector Pins.

- (2) Remove and retain four screws securing Control Board "piggy back" to the Mother Board standoffs. Remove Control Board from Mother Board.

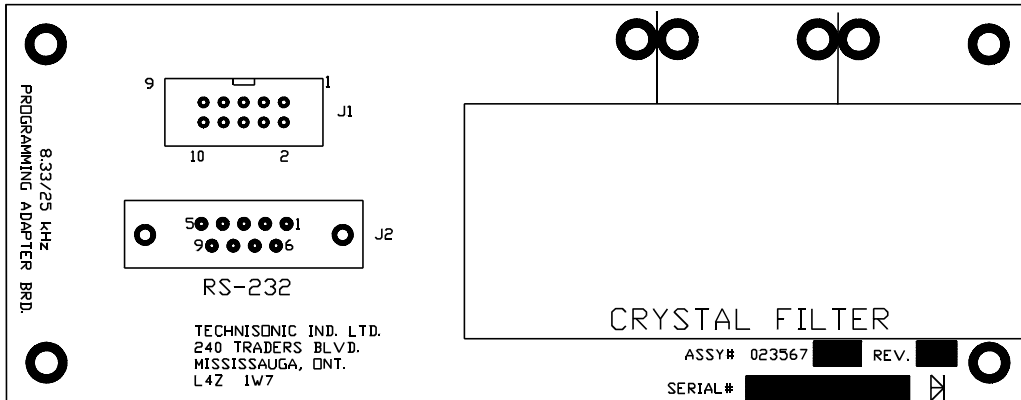

Figure 2-2 Programming Interface Board with Crystal Filter Option

## REPLACEMENT

- (1) Align the two female connectors on the control board with the male connectors on the Mother Board using the four mounting holes and standoffs as a guide. Secure control board to the Mother Board standoffs with four screws and washers.
- (2) Replace dust cover as described in paragraph 2.2.1.

### 2.2.5 Remove/Replace Crystal Filter Board, p/n 923069 or Jumper Board, p/n 923074

#### REMOVAL

- (1) Remove dust cover of unit as described in Paragraph 2.2.1.
- (3) Remove and retain the four screws securing the crystal filter board, p/n 923069-1 (or jumper Board, p/n 923074) to the standoffs on the external frequency set module A5A1. Pull the crystal filter board assembly straight up to avoid damaging the connector pins.

#### REPLACEMENT

- (1) Align the pins on the bottom of the crystal filter board with their sockets on the memory set board. Push the crystal filter board straight down until it rests on the memory set board standoffs and secure with the four mounting screws.
- (2) Connect Module A5A1 co-axial jumper leads to jumper J2/P3 on Rx/Tx Module A1, if not already connected. Either a crystal filter board, p/n 923074 or a jumper board, p/n 923074 must be installed and the A5A1 co-axial jumper leads connected to J2/P3 on the Rx/Tx Module A1, for the receiver to work.

**NOTE:** Make certain that the memory set board, module A5A1 is programmed to the same operating frequency as the crystal filter board assembly. If no crystal filter board assembly (option) is installed, jumper board assembly P/N 923074-1 must be installed.

## 2.3 CHANNEL FREQUENCY PROGRAMMING

### 2.3.1 Introduction

Transceiver Model TSC-4400, as shipped from the factory, is preprogrammed with a test frequency. Before programming a new frequency, perform an operational check. If there is any deficiency or equipment malfunction, the transceiver is to be returned to the manufacturer, Technisonic Industries Limited, under warranty.

### 2.3.2 Frequency Range

The operating frequency may be programmed over the frequency range 118.000 MHz to 138.000 MHz with 8.33kHz or 25kHz channel spacing.

### 2.3.3 Frequency Programming Requirements

A personal computer is required to reprogram a new frequency into the transceiver channel memory. Refer to document 04RE332 (Section 3, Addendum A) for detailed instructions on TDP-90 software installation and operation.



A standard 9 pin serial cable must be temporarily connected between the front panel DB-9 connector on the transceiver and the computer serial port.

The transceiver is capable of 25 kHz spacing (wide band) and 8.33 kHz spacing (narrow band) channels. The frequency entered will determine whether the channel will be wide or narrow mode, based on the Combined 8.33 kHz/25 kHz ICAO Frequency-Channel Pairing Plan. For example if you program 118.000 into a memory, the transceiver will operate on 118.000 MHz in wide band mode. If you program 118.005 into a memory, the transceiver will operate on 118.000 MHz in narrow band mode. For the most part, this will be transparent to the user since a frequency will be issued in the ICAO format and the radio will select wide or narrow mode. Refer to the chart below.

**TABLE 2-1 COMBINED 8.33/25 kHz ICAO FREQUENCY CHANNEL PAIRING PLAN**

Frequency Entered (MHz)	Actual Operating Frequency	Channel Spacing (kHz)
<i>118.000</i>	<i>118.0000</i>	<i>25</i>
118.005	118.0000	8.33
118.010	118.0083	8.33
118.015	118.0166	8.33
<i>118.025</i>	<i>118.0250</i>	<i>25</i>
118.030	118.0250	8.33
118.035	118.0333	8.33
118.040	118.0416	8.33
<i>118.050</i>	<i>118.0500</i>	<i>25</i>
118.055	118.0500	8.33
118.060	118.0583	8.33
118.065	118.0666	8.33
<i>118.075</i>	<i>118.0750</i>	<i>25</i>
118.080	118.0750	8.33
118.085	118.0833	8.33
118.090	118.0916	8.33
<i>118.100</i>	<i>118.1000</i>	<i>25</i>
118.105	118.1000	8.33
etc	etc	etc

### 2.3.4 Programming a Frequency

Having ascertained the desired operating frequency, continue as follows:

- (1) Run the TDP-90 program on the computer.
- (2) Click on the **Data** pull-down list and select the serial port to which the transceiver is connected.
- (3) Set the program for 1 channel.
- (4) Turn on power to the transceiver.
- (5) Click on the **Up** icon to retrieve the frequencies from the radio. You will see activity in the Terminal window as data is being transferred.
- (6) Edit the frequencies as desired.
- (7) Click on the **Dn** icon to copy the frequency to the transceiver. You will see activity in the Terminal window as data is being transferred.
- (8) Click on the **diskette** icon to save the file.
- (9) Click on the **printer** icon to print a hard-copy of the frequency.
- (10) Turn off power to the transceiver.

## 2.4 REMOTE OPERATION SETUP

The Procedures listed below enable the user to custom configure the unit for external remote control hardware. Refer to Table 2-3 for connector pin details on Remote Control D Connector located at rear of Single Channel Transceiver. Position Jumpers on Control board as indicated in Table 2-4 or Table 2-5 as required. Refer to Figure 2-3 and Figure 2-4 for board locations. Verify Remote Control operation in accordance with manufacturers instructions.

**TWO WIRE SETUP** - In two wire operation, a single balanced 600 ohm pair is provided for transmit and receive audio. The transmitter can be keyed on the same pair or externally.

**FOUR WIRE SETUP** - In four wire operation, separate balanced 600 ohm pairs are provided for transmit and receive audio. The transmitter can be keyed on the Tx audio pair or externally.

**DC KEYING** - In  $\pm$  DC keying, a positive voltage between + 10 Vdc and + 48 Vdc or negative voltage between -10 Vdc and -48 Vdc will key the transmitter. A DC voltage between -5 Vdc and + 5 Vdc will not key the transmitter.

**TONE KEYING** - In Tone keying a tone of 2175 Hz or 2380 Hz (Optional) can be used to key the transmitter. Tone sensitivity is adjustable from -40 dBm to 0 dBm.

**GROUND KEYING** - In Ground Keying the transmitter is keyed by shorting the control point (landline or External Keying) to chassis ground

**CURRENT LOOP KEYING** - In Current Loop keying, an internal or external current source (15 mA) is used to key the transmitter

**EIA TONE KEYING** - The EIA multi-tone keying format is found in the Land Mobile Industry. A high level 2175 Hz tone followed by a 1950 Hz guard tone then a low level 2175 Hz continuous tone is utilized to key the transceiver.

TABLE 2-2 REMOTE CONTROL CONNECTOR FUNCTIONS		
9 PIN NO	25 PIN NO	Connector Pin Functions
A,B	9,21	4 Wire Tx Audio Line or 2 Wire Rx/Tx Audio Line (600 S)
C,D	10,22	4 Wire Rx Audio Line (600 S)
N/A	8	AGC
K	13	Single Line Keying (PTT)
J	1,2,14,15	Ground
N/A	25	Squelch
E(-),F(+)	23(-),11(+)	Carrier Control
N/A	20	RF Indicator
N/A	3,4,5,6,7,16,17,18, 19	Not Connected, allocated for future functions

**NOTE:** A modular RJ-11 Jack is also provided on the rear of the 19" rack chassis for quick connection to the 2 wire, Tx/Rx Audio. The red and green wire connections (centre pins) on the RJ-11 are connected parallel to pins 9 and 21 on the 25 pin connector. This RJ-11 jack CANNOT be used if the remote control card is set to 4-wire operation as it does not have the necessary connections.

### 2.4.1 Two/Four Wire Remote Control Board P/N 923051-1

Provides remote control base station operation on 2 wire or 4 wire, 600 ohm lines. This board can be configured to key the transmitter using a 2175 Hz tone (2380 Hz upon request), plus/minus DC Voltages, ground keying and internal or external current loop keying. Transmit and Receive audio is user selectable for two wires or four wires. Crystals for tone frequencies other than 2175 Hz or 2380 Hz may be obtained by special order.

See Figure 2-3 for location of jumpers referred to in the following table. Pins are numbers increase as you go from top to bottom or left to right on the connector.

TABLE 2-3 REMOTE CONTROL BOARD P/N 923051-1 SETTINGS	
CONTROL	FUNCTION
J1	Jumper Pin 1 and Pin 2 for DC Current Loop Keying Jumper Pin 2 and Pin 3 for $\pm$ DC Keying or Ground Keying. <b>Note: SW2 must be in position 2 if Pin 2 and Pin 3 are jumpered.</b>
J2	Jumper Pin 1 and Pin 2 for Ground Keying (Land Line). Jumper Pin 1 and Pin 4 for $\pm$ DC Keying (Land Line). Jumper Pin 2 and Pin 3 for Ground Keying (Single Key Line). Jumper Pin 3 and Pin 6 for $\pm$ DC Keying (Single Key Line). Jumper Pin 2 and Pin 5 for No Function.
J3	Jumper Pin 1 and Pin 2 for $\pm$ DC or Ground Keying. Jumper Pin 4 and Pin 5 for Tone Keying. <b>Note: Both Options may be selected.</b> Jumper Pin 2 and Pin 3 for No Function. Jumper Pin 5 and Pin 6 for No Function.
J7	Jumper Pin 1 and Pin 2 to enable Timeout Timer. Jumper Pin 2 and Pin 3 to disable Timeout Timer.
J6	Jumper Pin 1 and Pin 2 to for Internal Current Loop Keying. Jumper Pin 2 and Pin 3 to for External Current Loop Keying.
SW1	Position 1 Selects 2 Wire Operation. Position 2 Selects 4 Wire Operation.
SW2	Position 1 Selects Normal (Land Line Keying). Position 2 Selects Local (Single Line Keying).
Y1,Y2	Determines Keying Tone Frequency.
R7	Sets Tx Audio IN Level (Range -18 dBm to + 10 dBm).
R22	Sets Key Tone Level (Range -40 dBm to 0 dBm).
R25	Sets Rx Audio OUT Level (Range -15 dBm to + 10 dBm).
R44	Sets Timeout Timer (Range 30 to 300 Seconds).
R10	Sets Receive Audio Output Balance.

## 2.4.2 Two Wire Line Interface Board P/N 943180-1

Provides remote control Base Station operation on 2 wire 600 ohm lines. Two wire Line Interface board with EIA multi-tone, standard 2175Hz continuous tone, DC keying of ground keying over audio lines. The multi-tone keying format consists of a high level 2175 tone followed by a 1950 Hz guard tone and then a low level 2175 Hz continuous tone is utilized to key the transceiver. This board will also support 15mA current loop or ground keying. Refer to Figure 2-4 for jumper locations to set functions and line level adjustments for this board. Summary of jumper settings follow. Pins are numbers increase as you go from top to bottom or left to right on the connector.

Set **J1** for **ST** (standard 2175Hz continuous) Tone keying or for **EIA** (multi-tone keying format).

Set **J2** for Tone keying function **ON** (left jumper position) or **OFF** (right jumper position).

Set **J3** for Time out timer **OFF** (left jumper position) or **ON** (right jumper position).

See Figure 2-4 for location of jumpers and left/right orientation.

TABLE 2-4 REMOTE CONTROL BOARD P/N 943180-1 SETTINGS	
CONTROL	FUNCTION
J1	Jumper Pin 1 and Pin 2 for ST (standard 2175 Hz continuous) tone Keying Jumper Pin 2 and Pin 3 for EIA multi-tone Keying.
J2	Jumper Pin 1 and Pin 2 for Tone Keying. Jumper Pin 4 and Pin 5 for Current Loop (15mA DC) or Ground Keying. <b>NOTE: Both options may be selected</b> Jumper Pin 2 and Pin 3 to disable Tone Keying. Jumper Pin 5 and Pin 6 to disable Current Loop and Ground Keying.
J3	Jumper Pin 1 and Pin 2 to enable Timeout Timer. Jumper Pin 2 and Pin 3 to disable Timeout Timer.
R6	Tx audio level Adjustment
R24	Keying Tone Attenuator
R26	1950 Tone level Adjustment
R41	2175 Tone Level Adjustment
R59	Sets Rx Audio Level Adjustment (Range -15 dBm to + 10 dBm).
R64	Sets Timeout Timer (Range 30 to 300 Seconds)

## Control Configuration for 2/4 Wire (+/-)DC/Ground/Tone/ (Current Loop) Keying Control Board.

Assembly #: 923051

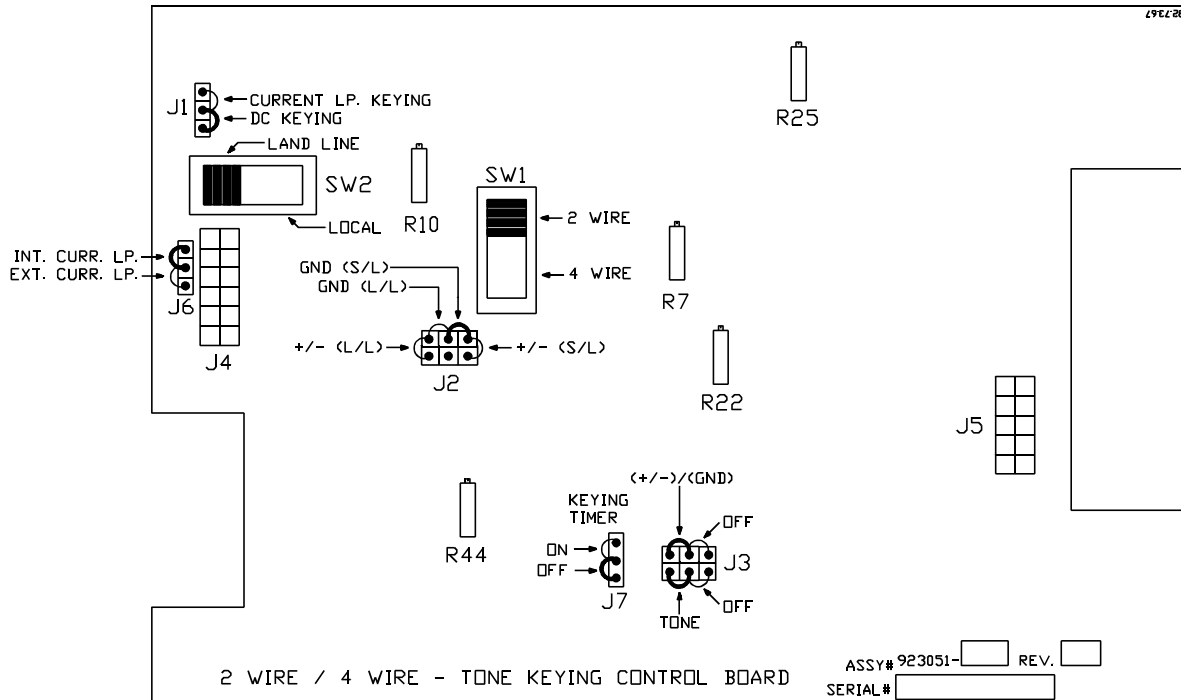

- |  |   |
|--|---|
| <p><b>R7:</b> Tx Audio<br/>(-25 <i>dBm</i> sensitivity;<br/>increases clockwise).</p> <p><b>R10:</b> 2 Wire Rx Balance @ 6000<br/>(1mV RF @ 1KHz, 30% Mod.)<br/>R10 adjusted for <b>minimum<br/>amplitude</b> at C6/R4 junction.</p> <p><b>R22:</b> Keying Tone<br/>(-30 <i>dBm</i> sensitivity;<br/>decreases clockwise).</p> <p><b>R25:</b> Rx Audio<br/>(-10 <i>dBm</i> output level;<br/>increases clockwise).</p> <p><b>R44:</b> Time Out Timer<br/>(15 to 300 sec.;<br/><b>90 sec.</b> Nominal;<br/>increases clockwise).</p> <p><b>SW1:</b> Selects either <b>2 Wire</b><br/>or 4 Wire operation.</p> | <p><b>SW2:</b> Selects either <b>Local</b><br/>or Land Line Current<br/>Loop Keying.</p> <p><b>J1:</b> Selects <b>DC</b> or Current<br/>Loop Keying operation.</p> <p><b>J2:</b> Selects either <b>Land Line<br/>(L/L)</b> or Single Line (S/L)<br/>and +/- DC or Ground<br/>keying operation.</p> <p><b>J3:</b> Selects <b>Tone</b> and/or +/- DC<br/>Keying enable or disable.</p> <p><b>J6:</b> Selects between <b>Internal</b><br/>or External Current loop<br/>keying (<b>ICL/ECL</b>).</p> <p><b>J7:</b> Keying timer<br/>Enable/<b>Disable</b>.</p> <p><b>J4:</b> Input Connector.</p> <p><b>J5:</b> Output Connector.</p> |
|--|---|

**NOTE: Bold Italics indicate Factory default configurations.**

Figure 2-3 Line Interface/Remote Control Board P/N 923051-1

**Control Configuration for Multi-Tone  
Control Board.  
Assembly #: 943180**

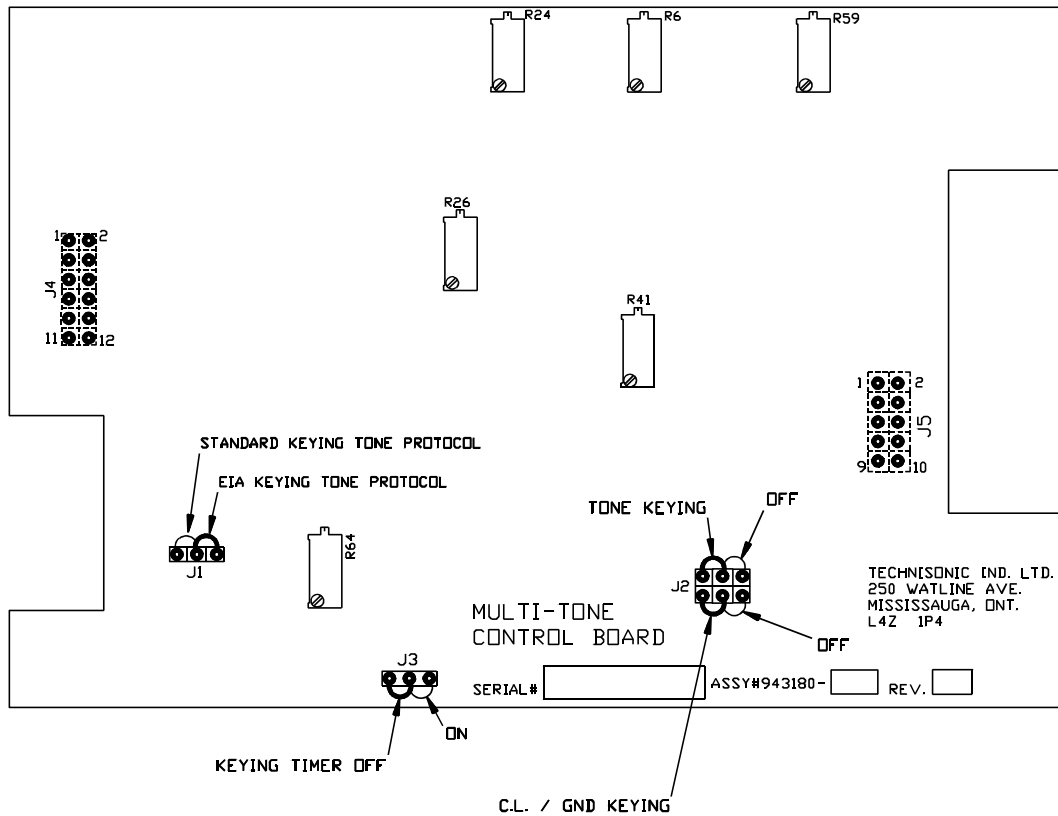

○ DENOTES FACTORY DEFAULT CONFIGURATION

- |  |  |
|--|--|
| <b>R6:</b> Tx audio level adjustment (-25 dBm).  | <b>J1:</b> Standard or <i>EIA</i> Keying tone protocol.  |
| <b>R24:</b> Keying Tone Attenuator.              | <b>J2:</b> Selects <b><i>Tone and/or Current Loop/</i></b> <b><i>Ground</i></b> Keying enable or disable |
| <b>R26:</b> 1950 Hz tone level adjustment        | <b>J3:</b> Selects Keying timer Enable/ <b><i>Disable</i></b>  |
| <b>R41:</b> 2175 Hz tone level adjustment        | <b>J4:</b> Input Connector   |
| <b>R59:</b> Rx Audio level adjustment. (-10 dBm) | <b>J5:</b> Output Connector  |
| <b>R64:</b> Time out timer (90 sec. default)     |  |

**NOTE: *Bold Italics* indicate Factory default configurations.**

**Figure 2-4 Line Interface/Remote Control Board P/N 943180-1**

## **2.5 OPTIONAL LOUDSPEAKER, HEADPHONE INSTALLATION**

Provision is made for connection of an external loudspeaker or headphone to the SPEAKER/PHONE jack of the transceiver, as shown in Figure 3-1.

### **2.5.1 External Loudspeaker**

When an external loudspeaker is to be installed, an 8-ohm nominal impedance loudspeaker should be used. The loudspeaker cable should be terminated by a 1/4 in., 3-pole telephone plug (male), with the loudspeaker connected between tip and sleeve (ground). Insert the external loudspeaker connector into the SPEAKER/PHONE jack located on the front panel of the transceiver. When the external loudspeaker is connected to the transceiver SPEAKER/PHONE jack, the internal loudspeaker is automatically disconnected.

### **2.5.2 Headset**

Headset impedance should be 150 to 600 ohms. The headset cable must terminate in a 1/4 in. 3-pole telephone plug (male), to mate with the SPEAKER/PHONE jack located on the front panel of the transceiver. The internal loudspeaker is automatically disconnected. Connect the headset as indicated below for receiver audio with or without transmit audio.

- (1) HEADSET WITHOUT TRANSMIT AUDIO - When receiver audio only without transmit audio is required, the headset should be connected between the tip and sleeve (ground) of the telephone plug.
- (2) HEADSET WITH TRANSMIT AUDIO - When receiver audio with transmit audio is required, the headset should be connected between the ring and sleeve (ground).

## **2.6 TRANSCEIVER ADJUSTMENTS AND SETTINGS**

The locations at which certain transceiver settings and adjustments can be performed are shown in Figure 2-5. The top dust cover of the transceiver must be removed as described in paragraph 2.2.1 to access the AGC, Squelch and Modulation settings. The plastic plugs must be removed prior to adjustment of the remaining settings which are accessed from the bottom of the transceiver chassis. If alignment procedures for these settings are required please consult the manufacturer or the appropriate service manual.

## **2.7 OPERATIONAL CHECK**

Perform an operational check of the transceiver after all adjustments. Ensure that the transceiver operates in both the transmit and receive modes of operation, using the Operating Instructions given in Section 3 of this document and the appropriate specified operating procedures for use with the Remote Control Unit.

## **2.8 STORAGE**

To store for an extended period, store unit in a dry place, in the original shipping container.



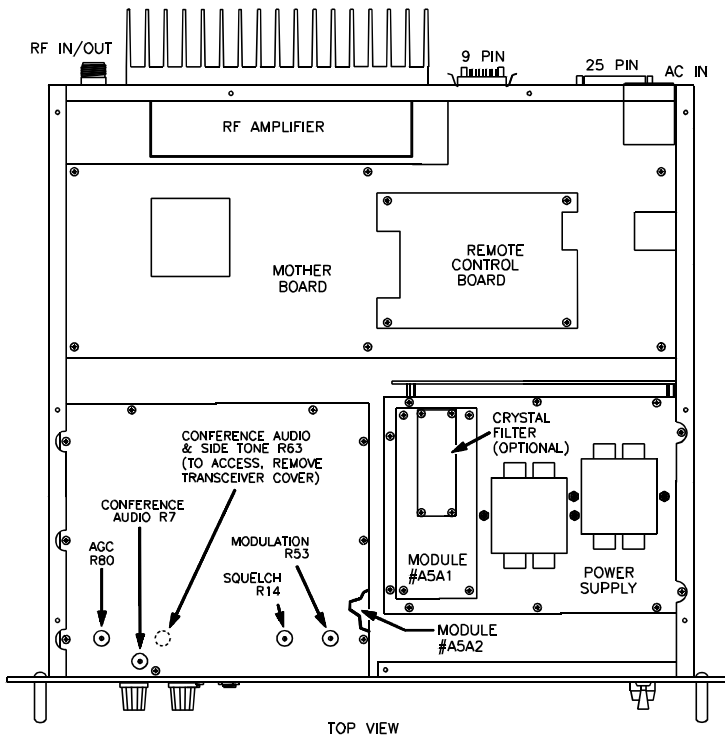
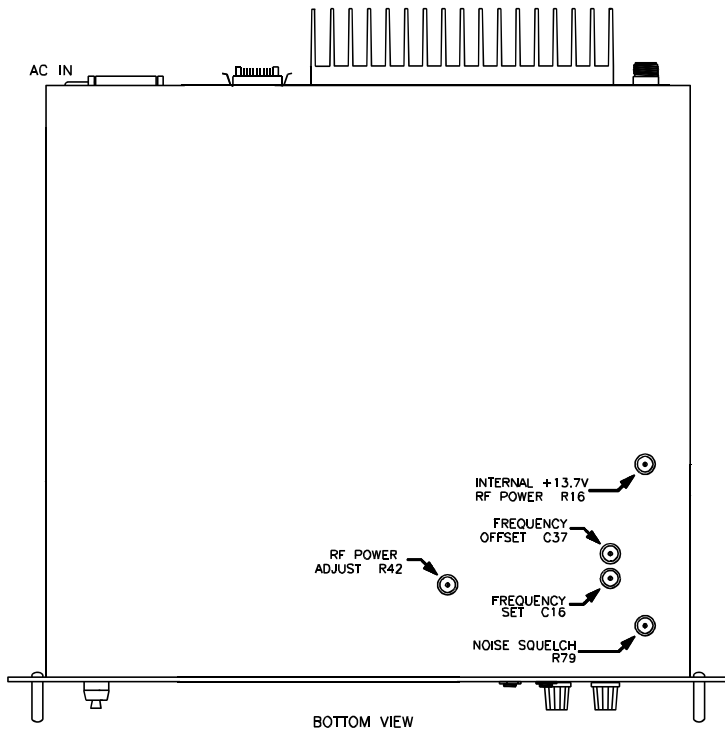

Figure 2-5 Transceiver Adjustments and Settings

## SECTION 3

# OPERATING INSTRUCTIONS

### 3.1 INTRODUCTION

This section includes a functional description of each switch, control, indicator and connector located on the front and rear panels of the portable transceiver, including the PRESS-TO-TALK switch located on the microphone. Operating instructions for transmit/receive and the special functions are also included.

### 3.2 INSTALLATION

The TSC-4400 Transceiver is designed to be mounted in a 19 inch rack. An AC Line cord P/N 927002-1 is supplied for connection to AC Power. A 9 Pin connector (mates with Positronic GM9MSCG000VL or equivalent) and a 25 Pin Connector (mates with Amphenol 17D-B-25S or equivalent) are provided for connection with external DC and 2 Wire or 4 Wire 600 ohm dedicated lines. A 50 ohm "N" Type connector is provided for connection to an external antenna. Refer to Section 2 for frequency selection and remote control setup details.

- (1) Mount Transceiver in 19 inch rack with 4 screws.
- (2) Install Microphone in Microphone (PTT) connector if required.
- (3) Ensure that Transceiver POWER ON/OFF switch is set to OFF.
- (4) Install AC line cord in AC chassis connector on rear panel.
- (5) Install Remote Control connector to 9 Pin or 25 Pin connector as required. (Refer to Figure 3-1 for connector pin outs.)
- (6) Connect antenna connector to rear panel chassis N Type connector.

### 3.3 OPERATOR'S SWITCHES, CONTROLS AND INDICATORS

A view of the front and rear panel is given in Figure 3-1. A functional description of each of the operator's switches, controls and indicators, and the microphone PRESS-TO-TALK switch, is given in Table 3-1, Operator's Switches, Controls and Indicators.

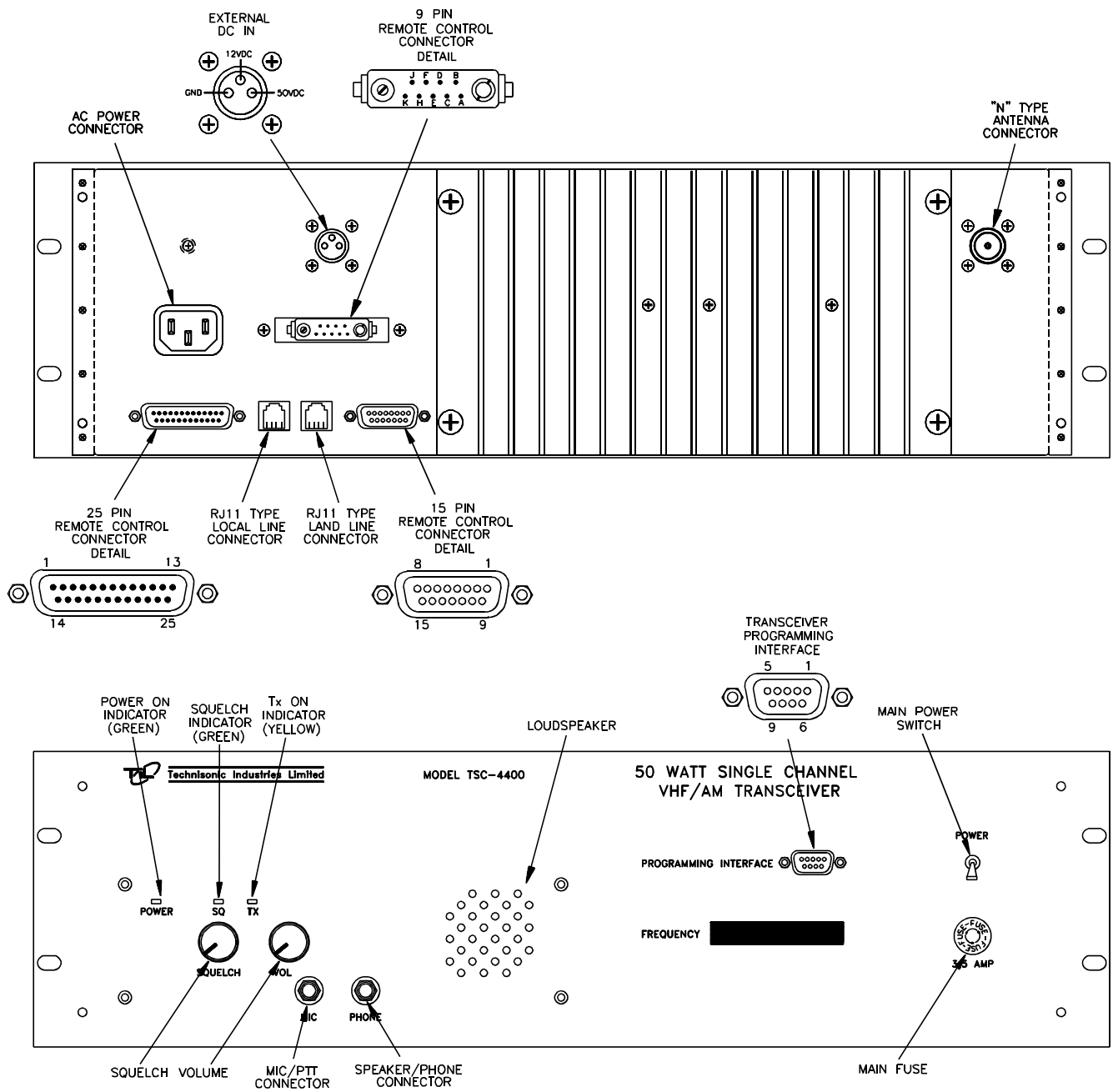

Figure 3-1 Single Channel Transceiver Controls and Indicators

<b>TABLE 3-1 OPERATOR'S SWITCHES, CONTROLS AND INDICATORS</b>		
<b>Item No.</b>	<b>SWITCHES CONTROLS &amp; INDICATORS</b>	<b>FUNCTIONAL DESCRIPTION</b>
1	POWER ON/OFF SWITCH	A toggle switch applies the AC power to the power supply and the DC voltage to the transceiver. The transceiver is switched to ON in the toggle UP position the transceiver is switched OFF in the toggle DOWN position.
2	POWER ON LED INDICATOR	A GREEN LED Indicates when the POWER ON/OFF switch is set to ON and voltage is applied to the transceiver.
3	SQUELCH CONTROL	A linear potentiometer determines the squelch threshold level. When the SQUELCH CONTROL is rotated in the counter-clockwise direction, the SQUELCH GREEN LED indicates that the squelch is connecting demodulated audio to the VOLUME control.
4	SQUELCH INDICATOR	A GREEN LED indicates the squelch circuit is connecting demodulated audio signal to the VOLUME control.
5	Tx ON AMBER LED INDICATOR	An AMBER LED indicates when the transceiver is keyed by the microphone PRESS-TO-TALK (PTT) switch or remote land line, and the transceiver is operated in the Tx mode. The Tx ON AMBER LED switches OFF, when the transceiver is operated in the receive mode.
6	VOLUME CONTROL	A logarithmic potentiometer determines the audio level applied to the internal speaker when the transceiver is operated in the receive mode. When the SPEAKER/PHONE connector is in use the internal loudspeaker is disconnected and the VOLUME CONTROL sets the audio level applied to the external speaker or headphone.
7	MIC/PTT CONNECTOR	A standard 0.2 inch 3-pole jack is provided to connect a microphone with PTT to the transceiver front panel.
8	TX LABEL	Indicates the frequency programmed for transmit.

<b>TABLE 3-1 OPERATOR'S SWITCHES, CONTROLS AND INDICATORS (Continued)</b>		
<b>Item No.</b>	<b>SWITCHES CONTROLS &amp; INDICATORS</b>	<b>FUNCTIONAL DESCRIPTION</b>
9	RX LABEL	Indicates the frequency programmed for receive.
10	LOUDSPEAKER	An 8-ohm internal speaker reproduces the receiver audio output. The audio line is disconnected from the internal loudspeaker when the transceiver is operated in Tx mode or when the SPEAKER/PHONE connector is in use.
11	SPEAKER/ PHONE CONNECTOR	A 3-pole connector provides interconnection to either an external loudspeaker or headphone. When in use, the internal speaker is disconnected and the VOLUME control sets the audio level applied to the external speaker or headphone.
12	DC POWER CONNECTOR	A 3 Pin connector for use with DC Power Supply (12VDC and 50VDC nominal)
13	AC FUSE	A 5.0 Amp Slo-Blo fuse protects the Base Station power supply from power supply internal short circuit or transceiver short circuit.
14	* "N" TYPE RF CONNECTOR	A 50 ohm coaxial connector provides connection to external antenna.
15	*AC POWER CONNECTOR	3 Prong AC Connector for use with AC Power Cord P/N 927002-1.
16	*9 PIN REMOTE CONTROL CONNECTOR	9 Pin "D" type connector provides connections required for remote operation. Refer to Table 2-3 for connector details.
17	*25 PIN REMOTE CONTROL CONNECTOR	25 Pin "D" type connector provides connections required for remote operation. Refer to Table 2-3 for connector details.
18	*RJ-11 REMOTE CONNECTOR	RJ-11 type connector provides parallel connection to the 2-Wire Tx/Rx audio from remote/line interface board. This connector supports 2 wire operation only.
* Denotes items located on rear panel.		

### 3.4 OPERATING INSTRUCTIONS

#### NOTE

**Refer to appropriate Operating Instructions for use with Remote Control Unit.**

#### NOTE

**The following operating procedures are intended specifically for Local Operation.**

- (1) Ensure that the microphone connector is connected to the MIC/PTT connector of the transceiver.
- (2) Set the SQUELCH control in the fully counter-clockwise (CCW) position.
- (3) Set the VOLUME control in the 12 o'clock centre position.
- (4) Set the POWER ON/OFF switch to "ON".
- (5) Verify that the POWER ON green LED is ON.
- (6) Proceed to operate in the transmit mode, paragraph 3.4.1 or operate in the receive mode, paragraph 3.4.2 as required.

#### 3.4.1 Transmitter Operation (Local Mode)

To operate the transceiver in the transmit mode, proceed as follows:

- (1) Set RF POWER switch (if applicable) to desired operating level.
- (2) Hold the microphone in one hand, with the upper edge of the microphone as close as possible to the upper lip.

#### NOTE

**This technique activates the noise cancelling feature of the microphone. The microphone is most effective when sound is ½ inch (12.7 mm) or more away from the microphone.**

- (3) Press and hold the PRESS-TO-TALK switch of the microphone during transmission.
- (4) Ensure that the Tx ON amber LED is ON.
- (5) Speak slowly and distinctly into the microphone using specified operating procedures during transmission.
- (6) When message is ended, release the PRESS-TO-TALK switch of the microphone.
- (7) The transceiver is now operating in the receive mode.
- (8) Verify that the Tx ON amber LED is OFF.

### 3.4.2 Receiver Operation (Local Mode)

To operate the transceiver in the receive mode, proceed as follows:

- (1) Ensure that the PRESS-TO-TALK switch on the microphone is NOT depressed, and verify that the Tx ON amber LED is OFF.
- (2) Verify that the correct operating frequency is indicated on the front panel.
- (3) Adjust the SQUELCH control to suit local reception conditions. When the SQUELCH control is rotated in the counter-clockwise direction, the SQUELCH indicator green LED will switch to ON, indicating that the squelch circuit is connecting the demodulated audio output to the VOLUME control.

Further adjustment of the SQUELCH control determines the squelch setting.

#### IMPORTANT NOTE

The dual conversion receiver's squelch knob must be rotated significantly more clockwise (4 o'clock position) to obtain the same squelch setting (3uV) as a single conversion receiver's squelch knob set to the 12 o'clock (straight up) position.

If the receiver's squelch knob is set to the 12 o'clock position, signals with a level greater than 0.5uV will open the squelch. At most airports this will not be an adequate level of squelch.

#### Recommended procedure:

The squelch taper on a dual conversion receiver looks as follows:

<b>Squelch knob position</b>	<b>Squelch setting</b>
12 o'clock	0.5uV
3 o'clock	1.2uV
3:30 position	2.5uV
4 o'clock	3uV
Fully clockwise	9uV

It is recommended that the squelch be set to at least 2.5uV (3:30 knob position) at busy airport locations. If ACARS signals are present on adjacent or nearby channels the squelch level should be at least 3uV (4 o'clock) to prevent ACARS bleed through.

- (4) The VOLUME control can then be adjusted in a clockwise direction to increase the audio level, or in a counter-clockwise direction to decrease the audio level which can be heard on the internal loudspeaker.

#### NOTE

**When an external loudspeaker or headset is connected to the SPEAKER/PHONE jack of the transceiver, the internal loudspeaker is automatically disconnected. The VOLUME control will now control the audio level applied to the external loudspeaker or headset, as applicable.**

### 3.4.3 Switching OFF

To switch off the transceiver:

- (1) Set the POWER ON/OFF on transceiver to switch to OFF.
- (2) Verify that all indicator LED's on the front panel are OFF.

#### **NOTE**

**When the transceiver is switched OFF there is no current drain from external DC.**

### 3.4.4 EXTERNAL DC OPERATION

- (1) Set AC ON/OFF switch to OFF.
- (2) Refer to Figure 3-1 for pin locations to hook up external DC Power.



# Section 3 Addendum A

Til Document No.  
04RE332

*This document contains designs and other information which are the property of Technisonic Industries Ltd. Except for rights expressly granted by contract to the Canadian Government, or to the United States Government, this document may not in whole or in part, be duplicated or disclosed or used for manufacture of the part disclosed herein, without the prior permission of Technisonic Industries Ltd.*

# **TiL TDP-90 Data Programming Software for the TSC-4400 Transceiver**

## **Installation and Operating Instructions**

**TiL Document No.  
04RE332  
Rev. n/c**

**March 2004**



**Technisonic Industries Limited**

240 Traders Blvd. E., Mississauga, Ontario L4Z 1W7 Tel:(905)890-2113 Fax:(905)890-5338  
www.til.ca

## TABLE OF CONTENTS

Paragraph	Title	Page
<b>SECTION 1 GENERAL DESCRIPTION</b>		
1.1	Introduction . . . . .	1-1
1.2	Description . . . . .	1-1
1.3	Minimum System Requirements . . . . .	1-1
<b>SECTION 2 INSTALLATION INSTRUCTIONS</b>		
2.1	Software Installation . . . . .	2-1
	2.1.1 - Windows 95 . . . . .	2-3
	2.1.2 - Windows 98 / Windows 2000 . . . . .	2-4
	2.1.3 - Windows NT 4.0 . . . . .	2-4
2.2	Hardware Installation . . . . .	2-5
<b>SECTION 3 OPERATING INSTRUCTIONS</b>		
3.1	General . . . . .	3-1
3.2	Getting Started . . . . .	3-1
3.3	Pull Down Menus . . . . .	3-2
	3.3.1 - File Menu . . . . .	3-2
	3.3.2 - Data Transfer Menu . . . . .	3-3
	3.3.3 - Help Menu . . . . .	3-4
	3.3.4 - Channel Selection . . . . .	3-5
3.4	Sample Upload and Download . . . . .	3-6
3.5	RS-232 Serial Technical Data . . . . .	3-7

## LIST OF ILLUSTRATIONS

Figure No.	Title	Page
2.1.1	Setup Extraction Dialog . . . . .	2-1
2.1.2	Welcome Dialog . . . . .	2-1
2.1.3	License Agreement . . . . .	2-2
2.1.4	Program Installation Dialog . . . . .	2-2
2.2.1	Programming Connections for Mobile transceivers . . . . .	2-6
2.2.2	Programming Connections for Base Station transceivers . . . . .	2-7
2.2.3	Programming Connections for Rack Mount transceivers . . . . .	2-7
3.3.1	File Menu Pulldown . . . . .	3-2
3.3.2	Data Menu Pulldown . . . . .	3-3
3.3.3	Help Menu Pulldown . . . . .	3-4
3.3.4.1	Single Channel Selection . . . . .	3-4
3.3.4.2	Six Channel Selection . . . . .	3-5

## Copyright and Trademark acknowledgement

- Microsoft, Windows 95, Windows 98, Windows NT, Windows 2000, DCOM, and Internet Explorer are registered trademarks of Microsoft Corporation.
- DPL is a registered trademark of Motorola Inc.
- S Adobe, Adobe Acrobat, and Adobe Acrobat Reader are registered trademark of Adobe Systems Inc.

## SECTION 1

### GENERAL DESCRIPTION

#### 1.1 INTRODUCTION

This publication provides operating and installation information on the TiL TDP-90 Programming Software for 8.33 kHz AM series transceivers. The TDP software allows a standard PC to retrieve data from a connected 8.33kHz AM series transceiver, for editing, storing, and sharing with other 8.33 kHz AM series transceivers. With the TDP software, you can create, save and print archives of your 8.33 kHz AM series transceiver channel settings.

#### 1.2 DESCRIPTION

The TiL TDP-90 software is a 32 bit Windows application that will work under Windows 95, Windows 98 and Windows NT 4.0. There are no known issues preventing the TDP-90 from working under Windows 2000. Please see section 2 for details on your particular installation.

#### 1.3 MINIMUM SYSTEM REQUIREMENTS

##### Windows 95

- Intel 486 or compatible based PC
- Windows 95 with the latest Service Releases/Packs installed (Installation of Microsoft Internet Explorer 5.0 or any Microsoft application more recent than mid 1998, will have automatically updated the required system files.)
- Mouse
- 5 MB free Hard-Disk space
- One available properly configured RS-232 serial (COM) port

or Windows 98 / Windows 2000

- Intel or compatible Pentium class PC
- Windows 98 or Windows 2000 with the latest Service Releases/Packs installed
- Mouse
- 5 MB free Hard-Disk space
- One available properly configured RS-232 serial (COM) port

or Windows NT 4.0

- Intel or compatible Pentium class PC
- Windows NT 4.0 with at least Service Pack 4 installed (Installation of Microsoft Internet Explorer 5.0 or any Microsoft application more recent than mid 1998, will have automatically updated the required system files.)
- Mouse
- 5 MB free Hard-Disk space
- One available properly configured RS-232 serial (COM) port

## SECTION 2

### INSTALLATION INSTRUCTIONS

#### 2.1 SOFTWARE INSTALLATION

Before the TDP software can be installed, all of the minimum computer system requirements outlined in the previous section must be met, otherwise difficulty may be encountered during installation or operation the software.

The installation procedures outlined in this document assume some basic working knowledge of at least one of Microsoft's Windows 95/98/NT/2000 operating systems.

**NOTE: At any point during installation, if any Dialog Boxes pop up exclaiming that newer system files are about to be overwritten by older files, click on NO to skip overwriting newer files.**

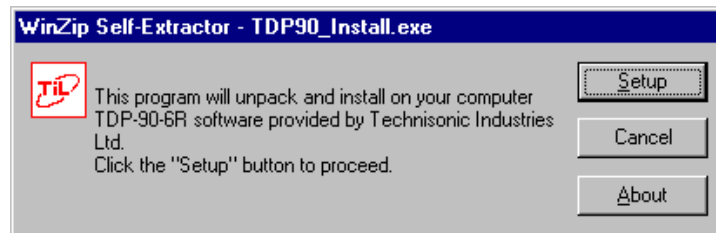

Figure 2.1.1 - Setup Extraction Dialog



Figure 2.1.2 - Welcome Dialog

This is a standard Welcome dialog box. To continue installation click on **Next>**. In any one of the dialog boxes, program installation can be stopped at any time by clicking the **Cancel** button.

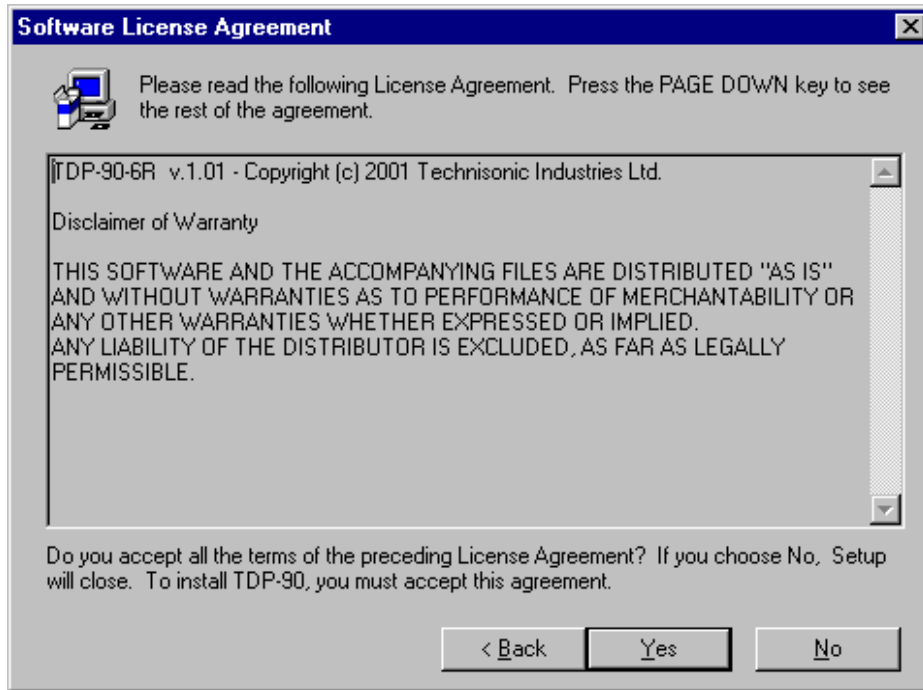

Figure 2.1.3 - License Agreement

In order to Install the TDP-90 Software onto your computer, you must agree to the terms of the license agreement, and confirm so by clicking on OK in the License dialog box.

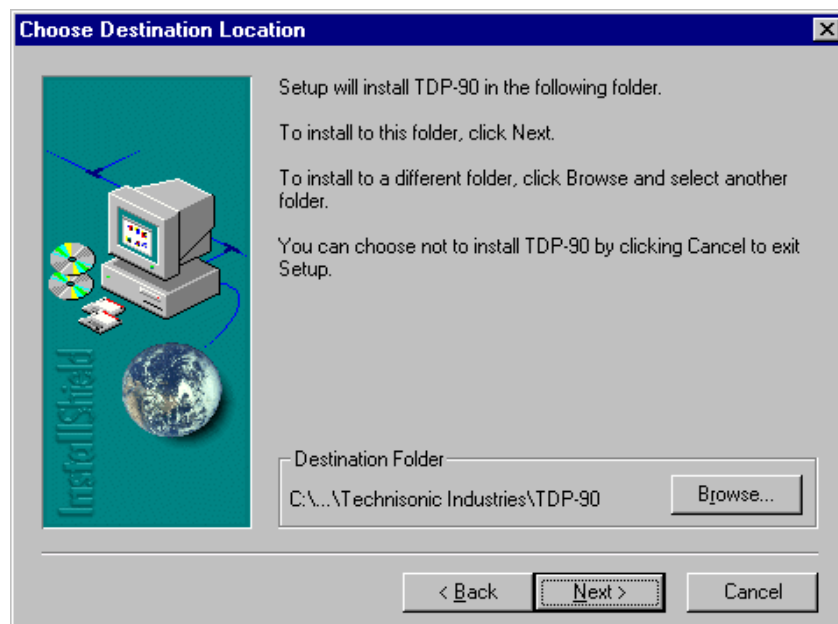

Figure 2.1.4 - Program Installation Dialog



### 2.1.1 Windows 95

If your computer does not have Microsoft Internet Explorer 5.0 or any other Microsoft application, no later than mid 1998 installed, then it is possible that certain essential system files are outdated. If these system files are outdated your system will not meet the minimum requirements for installing and operating a large variety of new software including the TDP software.

If your computer DOES meet the minimum requirements, you may proceed to step 3.

1. To update Windows 95, you will need to install an update available on Microsoft's website, called DCOM95 (dcom95.exe). To download DCOM95, just enter this current (as of the release date of this manual) Internet URL for the file in your 'location bar' in your Internet Browser.

**<http://download.microsoft.com/msdownload/dcom/95/x86/en/dcom95.exe>**

Your Browser will invoke a SAVE AS dialog box for you to save the file. Keep track of where you place it, as you will be required to locate it and RUN it. Conveniently, the file will fit on a regular IBM Formatted 3½" 1.44MB floppy disk, for easy transport and distribution.

If you have the DCOM95.EXE update file on a floppy disk, copy/place it in a temporary location on your Hard-disk.

2. RUN DCOM95 by locating and double-clicking on it in Windows Explorer. Any System files on your computer that are OLDER than the ones contained in the DCOM95 update, will be replaced. You will be asked to restart your computer. Do so, and when the computer has finished booting, you will have an updated Operating System that will meet the requirements of the TDP software.
3. To install the TDP software, locate the TDP90\_Install.exe file on the CD-ROM using Windows Explorer. When you have located it, double-click it to start the setup process.

You will see the first Setup dialog (Figure 2.1.1). Click on the Setup button to continue installation. The Setup will unpack the necessary components. After it completes, you will see a Welcome dialog box. Click **Next>** to continue. Before you can continue, you will have to agree to the terms of the License Agreement by clicking **OK** (Figure 2.1.3).

The setup wizard may or may not ask to reboot the computer, depending on which components your system required from the installation package. If so, let the computer restart and run setup again to complete the installation process. No further reboots will be required.

4. After setup finishes unpacking the software, a dialog box will pop up with the option to continue (by clicking on the **Next>** button see Figure 2.1.4), exit the setup, or at this time you may choose an alternate location for the installation. If you have no objections to the default location just click on the **Next>** button to continue the installation.
5. The TDP installation will ask what START menu Program Group you want the TDP software shortcut installed. Click **FINISH** if the default Program Group name is adequate.  
The Data Programming Software is now installed and ready to use with an 8.33 kHz AM series Transceiver.

### 2.1.2 Windows 98 / Windows 2000

Windows 98 comes pre installed with Internet Explorer 5.0 embedded into the operating system. As a result, the operating system as a whole meets the requirements for the installation and operation of the TDP software.

1. To install the TDP software, locate the TDP90\_Install.exe file on the CD-ROM using Windows Explorer. When you have located it, double-click it to start the setup process.

You will see the first Setup dialog (Figure 2.1.1). Click on the Setup button to continue installation. The Setup will unpack the necessary components. After it completes, you will see a Welcome dialog box. Click **Next >** to continue. Before you can continue, you will have to agree to the terms of the License Agreement by clicking **OK** (Figure 2.1.3).

The setup wizard may or may not ask to reboot the computer, depending on which components your system required from the installation package. If so, let the computer restart and run setup again to complete the installation process. No further reboots will be required.

2. After setup finishes unpacking the software, a dialog box will pop up with the option to continue (by clicking on the **Next >** button see Figure 2.1.4), exit the setup, or at this time you may choose an alternate location for the installation. If you have no objections to the default location just click on the **Next >** button to continue the installation.
3. The TDP installation will ask what START menu Program Group you want the TDP software shortcut installed. Click **FINISH** if the default Program Group name is adequate.

The Data Programming Software is now installed and ready to use with an 8.33 kHz AM series Transceiver.

### 2.1.3 Windows NT 4.0

For a Windows NT 4.0 installation, a minimum of Service Pack 4 must be installed. If you do not have at least Service Pack 4, contact Microsoft for the most current Service Pack.

1. To install the TDP software, locate the TDP90\_Install.exe file on the CD-ROM using Windows Explorer. When you have located it, double-click it to start the setup process.

You will see the first Setup dialog (Figure 2.1.1). Click on the Setup button to continue installation. The Setup will unpack the necessary components. After it completes, you will see a Welcome dialog box. Click **Next >** to continue. Before you can continue, you will have to agree to the terms of the License Agreement by clicking **OK** (Figure 2.1.3).

The setup wizard may or may not ask to reboot the computer, depending on which components your system required from the installation package. If so, let the computer restart and run setup again to complete the installation process. No further reboots will be required.

2. After setup finishes unpacking the software, a dialog box will pop up with the option to continue (by clicking on the **Next>** button see Figure 2.1.4), exit the setup, or at this time you may choose an alternate location for the installation. If you have no objections to the default location just click on the **Next>** button to continue the installation.
3. The TDP installation will ask what START menu Program Group you want the TDP software shortcut installed. Click **FINISH** if the default Program Group name is adequate.

The Data Programming Software is now installed and ready to use with an 8.33 kHz AM series Transceiver.

## 2.2 HARDWARE INSTALLATION

### Rack Mount Transceiver:

Plug the female end of a 9 pin serial cable into the 9 pin D connector on the front panel of the unit. Connect the other end of the serial cable to an available Serial (COM) Port on your PC. Plug the transceiver into 120VAC and turn the unit on.

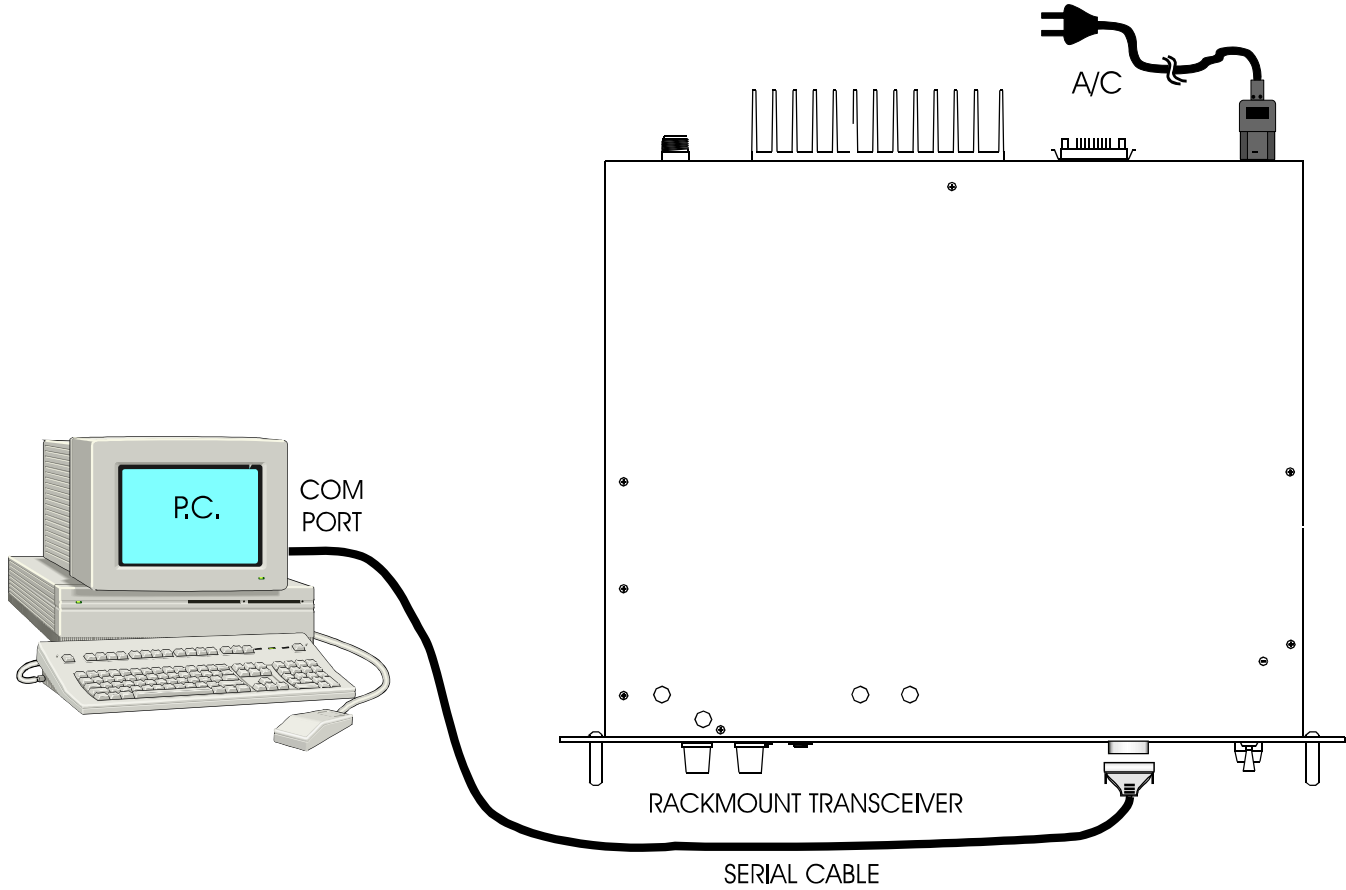

FIGURE 2.2.2

## SECTION 3

### OPERATING INSTRUCTIONS

#### 3.1 GENERAL

This section contains instructions for proper operation of the TDP-90 software and explains the various elements of the Graphical User Interface (GUI).

**NOTE:** The following images are examples only, and may not reflect your particular data settings, or current TDP software version.

#### 3.2 GETTING STARTED

To start the TDP-90 in Windows, simply click the Start menu > Programs > TiL Transceiver Data Programmer > TDP-90. The program will start, and the following Graphical User Interface (GUI) will appear. The current *version number* is shown in square brackets on the title bar. The *pull-down menus* and *icons* provide the set-up and operating functions. The *Terminal window* displays communication activity as it occurs. The *Channels* pull-down tab provides selection for single or six channel transceivers. The number of channels in the *Frequency editing window* changes accordingly. Select "1 Channel TxRx" for the TSC-4400. The frequency, as displayed in the *Frequency editing window*, can be changed by clicking on the channel window and entering the frequency.

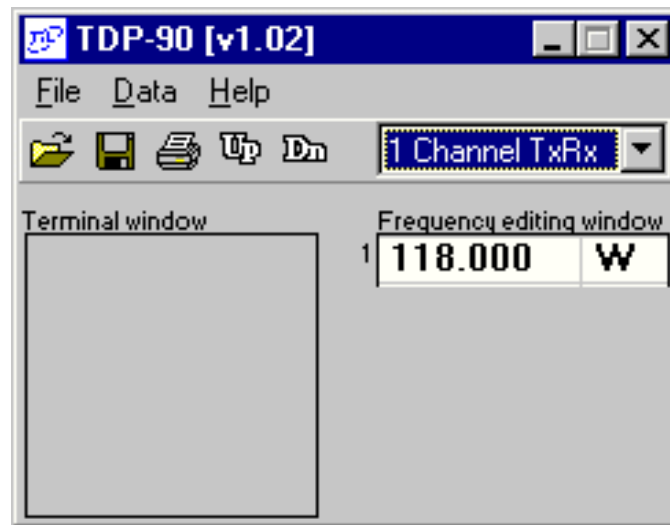

Figure 3.3.1 - Main Graphical User Interface

**Note:** \*\* Use of a mouse is highly recommended! \*\* It is possible however, to use the TDP software without a mouse by using the [Tab], [Shift]+[Tab] and 'cursor' keys to navigate through the program interface. You will note that all menu items and buttons have an underlined letter. By pressing the [Alt] key and the underlined letter in the menu bar or button, you can pull down that menu item. eg: [Alt]+F, would pull down the file menu. You could then cursor down to the desired function, or press the underlined letter for the corresponding function.

### 3.3 PULL DOWN MENUS

The TDP-90 program has several functions available through the use of pull-down menus. Through these menus, you can invoke file functions, print the channel list, initiate communications with a connected TFM-90 and quit the TDP software.

#### 3.3.1 File Menu

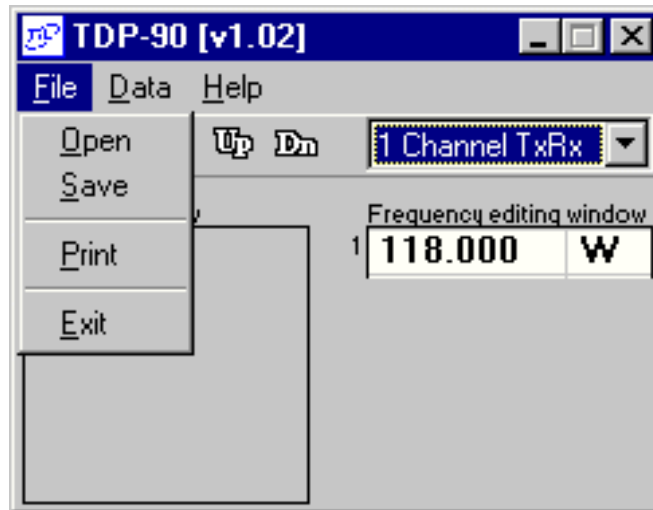

Figure 3.3.1 - File Menu

**O**pen will allow you to select and load an existing file that was previously saved on disk. The yellow folder icon provides the same function in a single mouse click.

**S**ave will allow you to save the current data into a file with a name of your choice. The filename may be any length up to 64 characters. The diskette icon provides the same function in a single mouse click.

**P**rint will create a text file of the channel list, as presented in the Frequency List window. Once the **P**rint function is invoked, you will be prompted to enter the serial number of the currently connected transceiver. The printout will append a header to the top of the page that includes the serial number of the transceiver as well as the time and date. The printout can be filed as a record of the frequencies that are programmed into that particular transceiver. The printer icon provides the same function in a single mouse click.

**E**xit will quit the TDP-90 program. If you have not saved your data, or if any changes were made to your data set since your last save, the TDP will warn you of this, and allow you to do so before quitting.

### 3.3.2 Data Transfer Menu

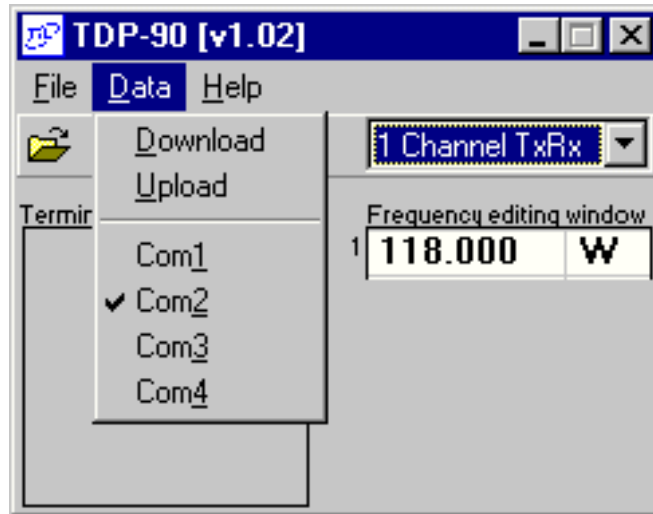

Figure 3.3.2 - Data Menu

**Download (to Radio)** instructs the TDP-90 software to transfer the frequency data in the list to the memory channels in the connected 8.33 kHz AM transceiver. The Dn icon provides the same function in a single mouse click.

**Upload (from Radio)** instructs the TDP-90 program to wait for and read the channel data from the memory channels in the connected 8.33 kHz AM transceiver. The Up icon provides the same function in a single mouse click.

**Com1 (2,3,4)** selects the COM (RS-232 Serial COMmunications) port on your computer, to which the transceiver is connected. On computers manufactured after 1990, COM 1 is typically a 9 pin male "D" connector. COM 2 may be either a 9 pin male or 25 pin male "D" connector. COM 3 and COM 4 are available in the TDP-90 software as a valid option, although they typically exist only in a computer with a third party serial communications card installed.

The COM port setting is automatically saved. The next time the TDP-90 software is executed, the previously selected COM port will be used.

**NOTE: \*\* The TDP-90 software assumes you have an available and properly configured COM port, and assumes that a TSC-4400 transceiver is connected. \*\***

### 3.3.3 Help Menu

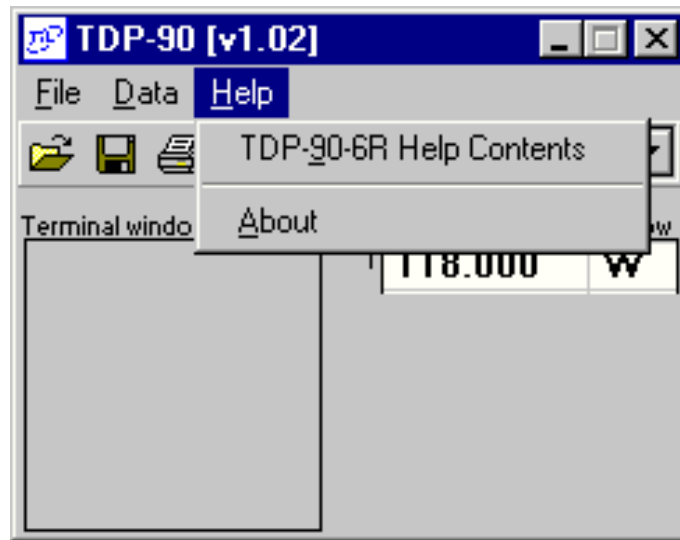

Figure 3.3.3 - Help Menu

**TDP-90-6R Help Contents** will start the Windows Help dialog for the TDP-90 software. Here, you will find hardware connection and operating information as well as troubleshooting tips and answers to some Frequently Asksed Questions.

**About** displays Technisonic company and contact information as well as the revision number of the TDP software in the "Terminal window" screen.



### 3.3.4 Channel Selection

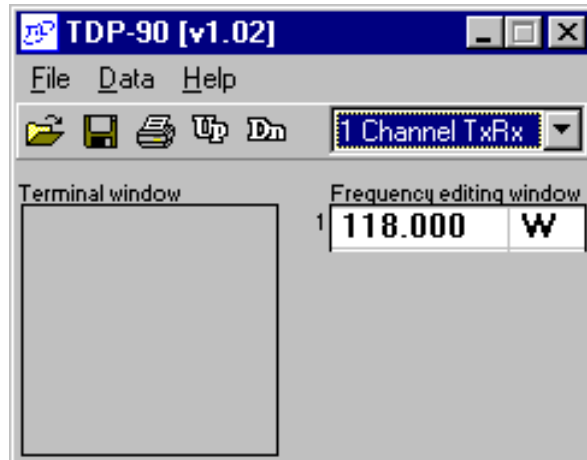

Figure 3.3.4.1 - Single channel

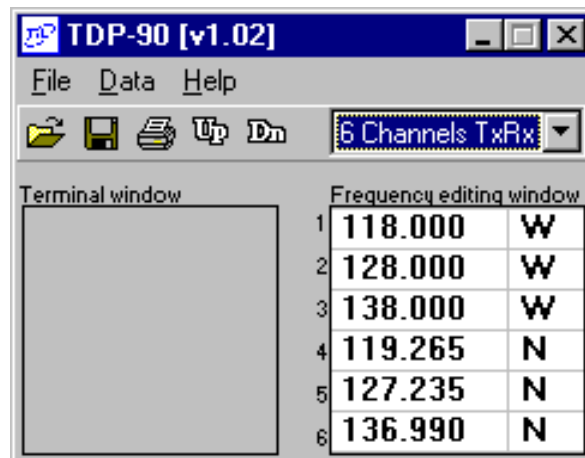

Figure 3.3.4.2 - Six channels

The **x Channel(s)** pull-down tab allows you to select for single or six channel 8.33 kHz AM transceiver use. The frequency editing window changes accordingly. Select "1 Channel TX/RX" for the TSC-4400.

### 3.4 SAMPLE UPLOAD AND DOWNLOAD

1. Connect the computer to the transceiver and apply power as described in section 2.2.
2. Run the TDP-90 program on the computer.
3. Click on the **Data** pull-down list and select the serial port to which the transceiver is connected.
4. Set the program for "1 channel TX/RX".
5. Turn on power to the transceiver.
6. Click on the **Up** icon to retrieve the currently loaded frequency from the radio. You will see activity in the Terminal window as data is being transferred.
7. Edit the frequency as desired.
8. Click on the **Dn** icon to copy the frequency to the transceiver. You will see activity in the Terminal window as data is being transferred.
9. Click on the **diskette** icon to save the file.
10. Click on the **printer** icon to print a hard-copy of the frequencies.

### 3.5 RS-232 SERIAL TECHNICAL DATA

The TDP-90 communicates with a connected transceiver at 9600 Baud, 8 Data bits, no Parity and 1 Stop bit. The TDP software sets these communications parameters upon startup, independent of the Windows default settings for the COM port you are using. These communications parameters are not user configurable.