

XV-100 / XU-100 Portable Radio

Service Manual

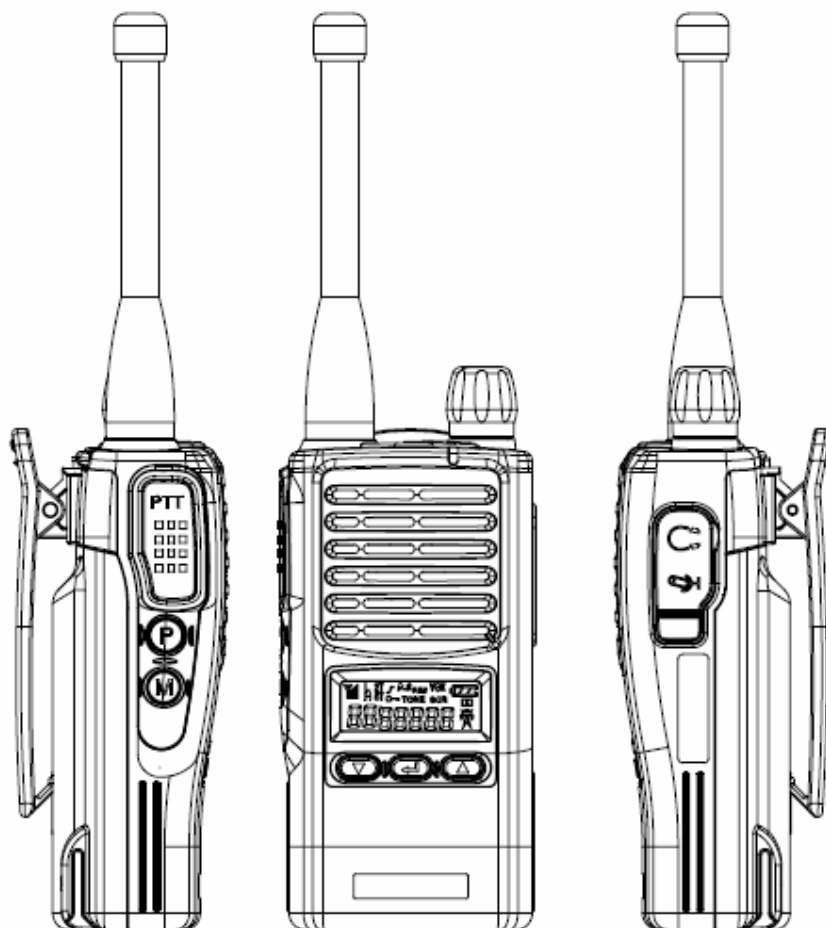

* This Service manual is subject to change according to improvement of XV-100 / XU-100 Portable Radio without notice.

* Version #1 (2008-03-10)

----- **Table of Contents** -----

1. XV/XU-100 Features	----- 3
2. Components of XV/XU-Series Radio	----- 6
3. Appearance of XV/XU-Series Radio	----- 7
4. Basic Operation of XV/XU Series Radio	----- 8
5. Operating XU/XV-100 RADIO	----- 11
6. Operating Instructions of XV/XU Series Radio	----- 14
7. Precautions	----- 27
8. Safety Notes	----- 28
9. Specification	----- 29
9.1 XU-100	----- 29
9.2 XU-100	----- 30

1. XV/XU-100 Features

The features of XV/XU-100 are various as below. XV/XU-100 can be used under tough industrial environments as well as public places. XV/XU-100 series have the following functions:

- 128 channels and 16 groups are selectable
- Call guard squelch of standardized CTCSS / DCS
- Built-in Scrambler
- Built-in Compressor
- Dual Tone Modulation Frequency (DTMF)
- Normal scanning / Priority scanning
- VOX(Voice Operated Transmit)
- Identification origination(2 Tone and 5 Tone)
- BCL(Busy Channel Lock)/BCLO(Busy Channel Lock Out)
- Time-Out Timer (TOT)
- Channel Spacing Only 12.5KHz
- High/Low Power Switching
- Selectable Squelch Level(0-4)
- Monitor
- Lone Worker
- High-Quality Audio Output
- PLL synthesizer method
- DC+3.7V 1,800mAh rechargeable Li-ion employment quantity battery use
- Advanced Speaker Protection technology
- Remote Radio Stun / Kill / Revive (Use 5 tone)
- Various Parameters and PC downloading methods
- PC Tuning

1) Numeric LCD Windows

Numeric LCD Windows enable to represent any kind of expression on LCD Display.

2) Built-in Scrambler

Maintaining private and secure communications is increasingly important, with potentially sensitive information flowing back and forth. The XV/XU-100 Scrambler feature provides enhanced security for your important public safety and private security communications.

3) Lone Worker

The feature provides added security and safety for individuals who work remotely from their team. Should a user not respond to a regular warning tone then a defined emergency procedure is activated.

4) Powerful Audio Output

XV/XU-1000 Voice compander audio enhancement and powerful 1W Speaker ensure superb clear, crisp sound, even in noisy environments.

5) Caller ID (Paging Feature)

XV/XU-1000 have a Caller ID Function that is usually used in the TRS Radio to maximize communication efficiency and convenience. The caller's ID is displayed on the right bottom on screen.

6) Power Output Setting

Output levels are factory set to provide 2 Watts.

7) Selectable Squelch Level (0~4)

Helps minimize interference from undesired signals and helps weak signals be heard.

8) 512 Channels and 16 Groups Selectable

Users can use various tones with 53 CTCSS and 104 DCS 512 channels can be divided into 16 groups so that users can make group for other users and page each group.

9) Multi-functional Ear/MIC Jack

With multi-functional Ear/MIC Jack, it is possible to be used together with various accessories.

10) Cloning

For compatibility with current models of TEKK, the data of those models (such as channels, tones, 5-tone ID, etc.) are cloned to another radio with Cloning cable. .

11) Voice Operated Transmit(VOX)

Enjoy the convenience of hands-free operation when used with optional accessories.

12) PC Programming and Tuning

Radio parameter programming and tuning can be accomplished via the accessory connector from a PC-compatible computer without ever having to open the radio to save both time and expense (requires optional programming JIG and software)

13) Flash Memory Advantage

Flash memory permits updates, advanced feature sets and system architectural changes to be made electronically without ever opening the unit. This means fast changes for the system operator and less down time for users.

1.1 Part Number Breakdown

The following is a breakdown of the part number used to identify this transceiver

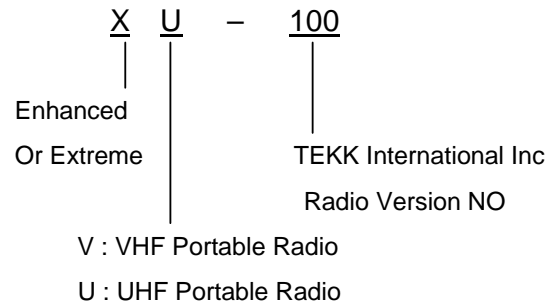

Model History Table

Model Name	Frequency Range	RF Power	Channel Spacing	Remark
XV-100	146~174MHz	2Watt	12.5 KHz	
XU-100	440~470MHz	2Watt	12.5 KHz	

2. Components of XV/XU-Series Radio

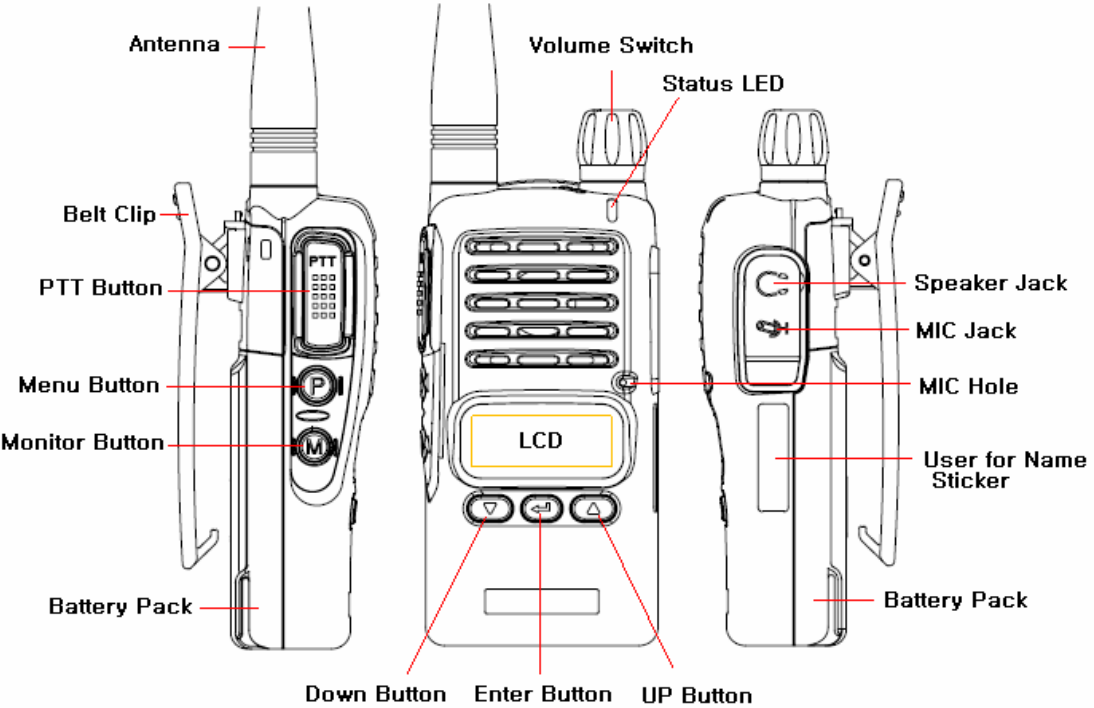

3. Appearance of XV/XU-Series Radio

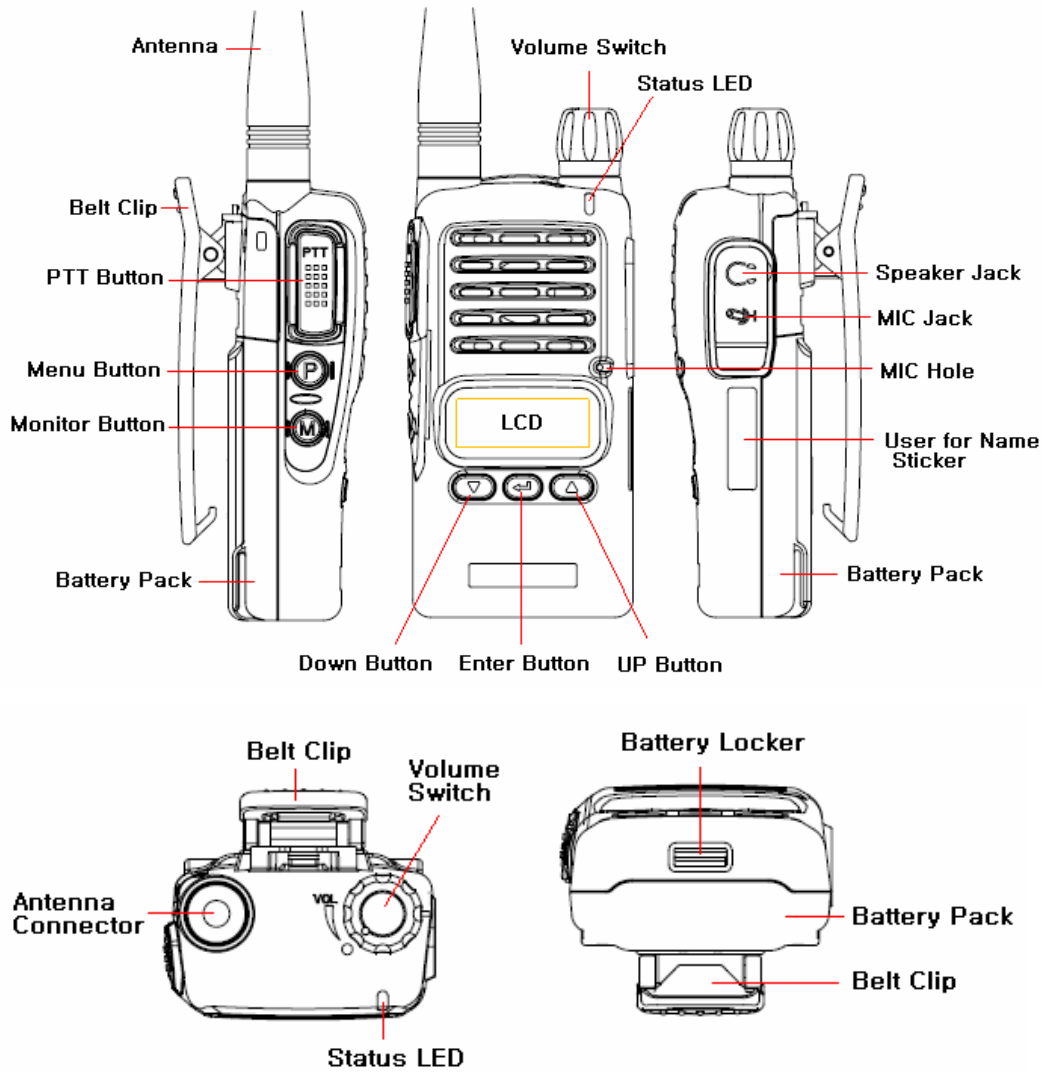

Figure 3-1) Appearance of XV/XU-100 Series Radio

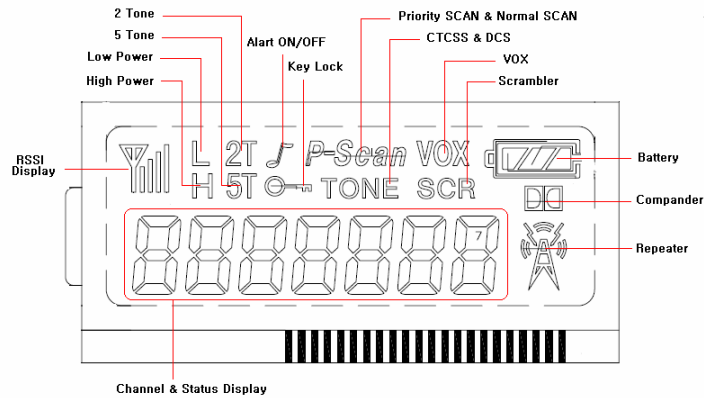

Figure 3-2) XV/XU-100 Series LCD Indication

4. Basic Operation of XV/XU Series Radio

Please read this manual carefully before using XV/XU series Radio.

This manual contains important information about using Radio.

4.1 Installation and Removing the Antenna

To install the antenna, insert the antenna into antenna connector and screw the antenna clockwise. To remove the antenna, screw the antenna counter clockwise.

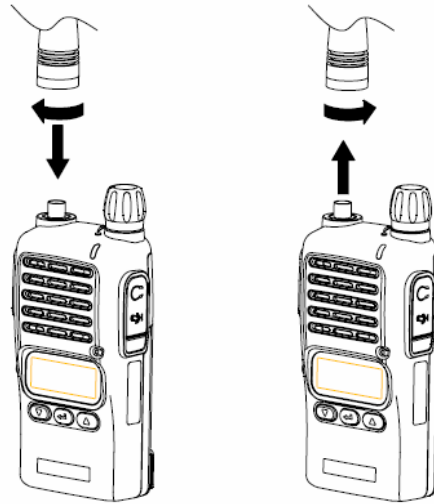



Figure 4-1) Installation and Removing the Antenna

 <p>주의</p>	<p>When installation of the antenna, giving a strong pressure to the Radio or pulling the antenna with a strong power from the Radio can make a damage on the antenna connector, which may cause the Radio to have a critical problem.</p>
---	--

4.2 Installation and Removing the Battery

4.2.1 Installation of the battery

To install battery, slide up the battery towards the top of the radio until battery latch is locked.

4.2.2 Removing the Battery

- Slide the battery latch located on the bottom of radio to the open position as shown in Figure 4-2.
- The battery is removed by pressing it against and sliding it towards the bottom of the radio

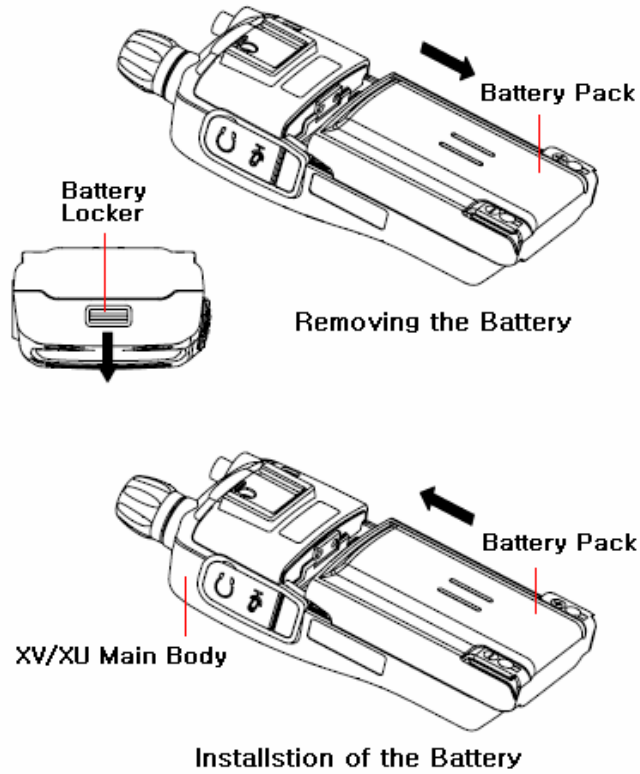

Figure 4-2) Installation and Removing the Battery

4.3 Installation and Removing the Belt Clip

- To attach belt clip to radio, align belt clip rails with the grooves in radio and slide the belt clip onto the mounting rails until it latches into place.
- To remove belt clip from radio, push up on tab of belt clip with flat bladed screwdriver and at the same time, slide the belt clip towards the top of Radio (Figure4-3).

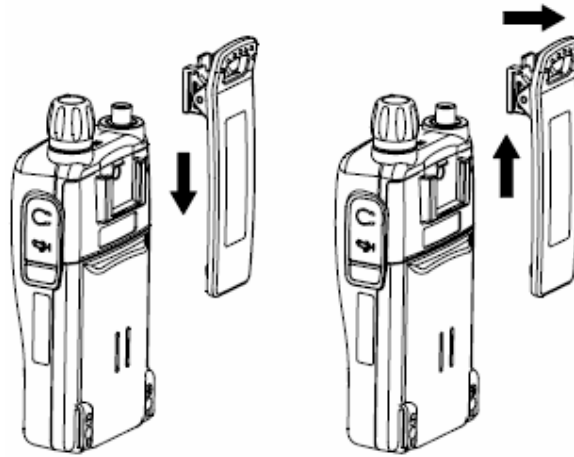

Figure 4-3) Installation and Removing the Belt Clip

4.4 Accessory connector

Accessory connector is used to connect external speaker/Mic, and headset, etc.
Please close the cover when nothing is connected.



Figure 4-4) Accessory connector

5. Operating XU/XV-100 RADIO

5.1 On/Off/Volume Control

Turns the radio on and off and adjusts audio volume level.

5.2 PTT Button(Push-To-Talk Button)

Radio transmission button.

5.3 Menu Button(P, Program Menu Button)

Enter into Menu mode by pressing the Menu button (P) for 2 seconds.

The sequence of menu mode is as follows.

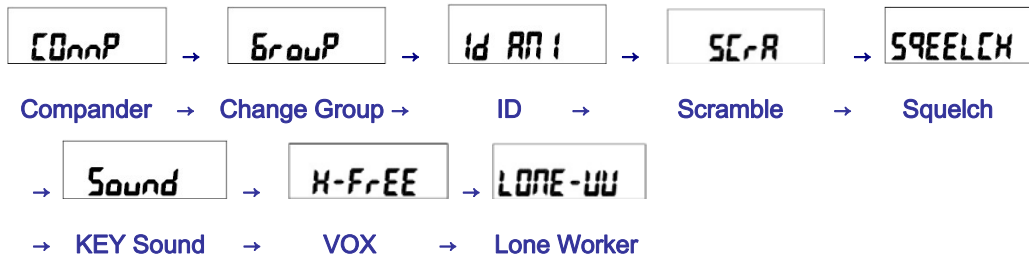

5.4 Monitor Button(M)

The monitor mode is enabled and disabled by pressing the Monitor button (M) on the side.

Normal Mode : During pressing the (M) button for about 2 seconds, it is possible to check the receiving status.

Continuous Mode : During pressing the (M) button for more than 2 seconds, the Radio will make a “Beep” tone, which means the monitor function is maintained and if you press the (M) button again, the monitor function will be released.

5.5 Emergency Button

In case of emergency situation, if you press the Emergency button, a siren sound will be heard through the speaker in the Radio and the Radio will transmit the emergency signal to the party through the emergency channel.

5.6 Channel Buttons(▼,▲)

Channel Buttons(▼,▲) have 3 functions as shown in following.

- 1 Channel buttons(▼,▲) are to change channels.
- 2 Channel buttons(▼,▲) are to select menu at menu mode.
- 3 Channel buttons(▼,▲) are to change transmission power. By pressing Up button(▲) while PTT button is being pressed, the user can select "H"(High Power), or by pressing Down button(▼), the user can select "L"(Low Power).

5.7 Accessory Connector

The Accessory Connector is used when using an external speaker microphone or doing PC programming or making the Cloning or using as a Repeater.

5.8 RX /TX Led

This LED is a lamp indicating the current status of the Radio and please refer to the below contents.

- 1 RX : Red Lamp
- 2 TX : Green Lamp
- 3 CTCSS, DCS Error : Green Blinks.
- 4 Low Battery: Red Blinks With “beep” sound.

5. Charging the Battery

5.1 Safety Notes

- 1) The radio of XV/XU series receives power from high-performance Li-ion battery (XSB-1800). XSB-2400 Battery is safe of high performance and highly reliable, and could be charged very fast. XSB-2400 Battery has been designed suitably only for the charger of Tekk (WLB-100).

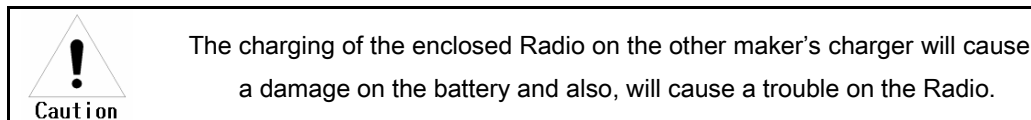

- 2) Please charge the battery before using the radio for best performance and safety.
- 3) When you charge the battery that is installed in the Radio, please turn off the radio first to charge the battery.

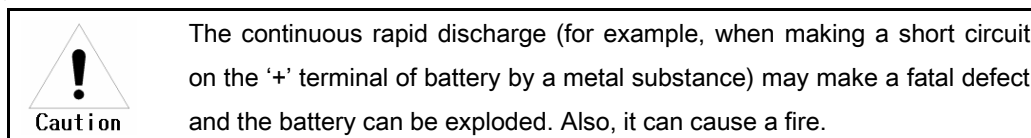

- 4) Using the correct battery will improve the efficiency and safety.

5.2 The Time of Charging

Low battery voltage will make the radio less coverage and also make the performance worse. Please charge the battery in case of following:

- 1 When you think performance of the radio becomes lower
- 2 When the red lamp on RX/TX Led blinks (every 0.5 second) during transmission or reception
- 3 When the battery icon blinks
- 4) When “beep” sound is generated while the radio is in use.



Figure 5-1) XV/XU-100 Charging the Battery

5.3 How to Charge

- 1) Plug the DC-100 charger into the electricity power outlet.
- 2) When charging the Radio with the battery installed, please turn off the power of the Radio and place the Radio on the charger (The charger has a slide slot.).
- 3) After completion of the charging, the green LED on the charger will light. However, please continue the charging for 30 more minutes for the complete full charge.

status	LED indication	status	LED indication
During charging	Red LED lights.	Detecting error	Red LED is off.
After charging	Green LED lights.	When charging	Green LED lights

5.4 Charger (XDC-100)

The DC-1000 charger is designed to charge only the Li-ion battery enclosed in this Radio.



Figure 5-2) XDC-100 Charger

Specifications of XDC-100 Charger :

- Input Voltage : DC85 ~ 250V
- Battery : XSB-1800
- Quick Changing Time : In 4Hours and half
- Operation Temperature : 0°C~+50°C
- Size : 75(W)x84.5(D)x36(H)m/m
- Charging Current : 750mA(Fast charging)

6. Operating Instructions of XV/XU Series Radio

6.1 Power On/Off

Turn Power switch clockwise. As soon as power is supplied, the backlight will be turned on.

If the user had set up the user ID, it will be displayed on the LCD and radio will enter into the latest state as a signal sound is generated.

- ☞ Caution) When turning (power) on the radio by pressing a button on it, the radio may enter into a special modes in which transmission and reception is impossible. Please don't turn on the radio by above way.

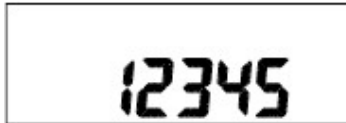

Figure 6-1) User ID

6.2 Transmission Method

For transmission, press PTT button on the left side of the radio. As soon as the user presses keys according to the setting, DTMF or 5-tone ID will be transmitted, and during this time, voice communication will be interrupted for several seconds. Then, red LEDs for transmission and reception will be turned on. It is recommended to talk 5 ~ 10cm away from the microphone for the best voice communication.

☞ Note: If the user makes transmission for more than a certain time while BCLO or TOT feature is on, transmission will be forcefully disconnected for other users.

☞ Caution) If present channel is TX Inhibited by pc program, TX will not be worked.

(By PC Program, it could be set)



figure 6-2) When receiving



figure 6-3) When transmitting

6.3 Reception Method

The user should not press PTT button during the reception. The user can adjust the volume by Volume switch, and during reception, the green LED will be turned on. Depending on conditions of the transmitting radio,

6.4 Changing Channels

Channel buttons (▼,▲) are to change channels. Press Up button (▲). Then, “beep” sound will be generated and the channel number will be increased. Or press Down button (▼) to decrease the channel. If the user presses Up or Down button while only one channel is set, the channel will not be changed and a different sound from “beep” will be generated. For fast increase or decrease channel numbers, press Channel buttons (▼,▲) for a while. In this case, however, “beep” sound will not be generated.

6.5 Adjusting the Transmission Power

The user can change the transmission power – High Power or Low Power. By pressing Up button (▲) while PTT button is being pressed, the user can select “H” (High Power), or by pressing Down button (▼), the user can select “L” (Low Power). By selecting Low power under good communication conditions, the user can extend the battery use time.

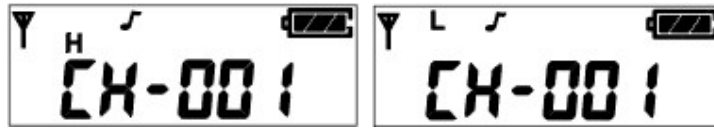

Figure 6-4) High Power

Figure 6-5) Low Power

6.6 Operation of Scan function

By pressing **Menu Button (P)** and **Enter Button ()** in order within 0.5 second in Standby mode, the user can activate Scan function. After Scan function is activated, the radio will automatically search channels and detect a channel corresponding to the frequency. To deactivate Scan function, press **Menu Button (P)** once.

6.6.1 Normal Scan

At the Scan mode, the LCD displays 'SCAN' icon. When the scan list is S1, S2, S3, the Radio proceeds the channel scan in the sequence of S1, S2, S3, S1, S2, During receiving a signal, if you press the UP(▲) or DOWN (▼) button, you can delete the receiving channel temporarily from the scan list and at that time, you can move to the next channel.



6.6.2 Priority Scan

At the Priority Scan mode, the LCD displays 'SCAN' and 'P-' icons. The Radio scans the channel in the sequence of P, S1, P, S2, P, S3, ... at the priority scan mode. During receiving signal through the common channel, the Radio scans the priority channel periodically and if the Radio detects the Priority channel, it starts receiving the channel. During receiving the signal, you can move to the following scan channel by pressing the UP or DOWN button. If you press the **Enter** button, you can erase the current receiving channel temporarily from the scan list and at that time, you can move to the next channel.

But in the course of receiving the Priority channel signal, you can not change or erase the channel by the UP/DOWN buttons(▲,▼).

6.7 Key Lock function

During pressing the "Enter" button at the receiving standby mode, press the "▲" button within 0.5second and then, the Key Lock function will be executed and the key icon of LCD will appear. At this situation, the other key except for the PTT and the Monitor key will not be operated. In order to release the Lock function, press the "Enter" button and during pressing the button, press the "▼" button within 0.5second.

6.8 2TONE / 5TONE function

6.8.1 2TONE

You can use the private and group tone functions by the central control system which is using the 2TONE SIGNALLING. If the Radio receives the tone signal, the Radio will make a Beep sound which is advising the tone signal status and which means the Radio is ready to talk.

6.8.2 5TONE

At the tone mode, you can make the private & group calls by the 5TONE and each call memory has the call IDs up to 30 numbers. The set-up of call memory and 5-TONE is made by PC programming. If pressing the "Enter" button for 2seconds at the general mode, the Radio is converted to the call mode and if pressing the "P(Program-MENU)" button for 2seconds at the call mode, the Radio is converted to the general mode. By using the channel buttons (▲, ▼) at the call mode, the call number of a channel which is available for the call is displayed.



Figure 6-6) General Mode



Figure 6-7) Call Mode

1) 1:1 Call at call mode

Press the "Enter" button for a long period (about 2seconds) at the general mode in order to enter into the call mode.

- 1 Select your party to call by using the channel button (▲, ▼). If you (ID : 12345) want to call your party (ID : 54321), select him (ID : 54321) by using the channel button (▲, ▼) at the call mode.

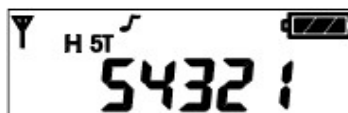

Figure 6-8) ID Selection

- 2 You can call the party (ID : 54321) by pressing the "Enter" button and then, the Radio of your party (ID:54321) displays the ID number "12345". Even though your party's Radio is in general mode, the Radio will be converted to the call mode automatically.



Figure 6-9) ID Transmission

3 After the call is completed, the Transmission and the Reception have no restriction, which means that the TX/RX will be free.

2) 2) Group(1:N) Call at call mode

- 1 In order to make the Group call at the call mode, the following should be set up at the PC programming.
- 2 If the 1st party (ID:53579) and the 2nd party(ID:52468) are in one group, the "5AAAA"which is a call number / call name(example : baseball player) should be designated. ("A" means that all the numbers are applied.)

3) If the caller makes a call to the group of baseball players, the caller's Radio should press the "Menu" and "▲" buttons at the same time after selecting the party with ID "1AAAA". In this case, the Radios of the party1 and the party2 display the ID "1AAAA". In case of the group call, the party's Radio displays the group ID number.

After the call is completed, the Transmission and the Reception have no restriction, which means that the TX/RX will be free.



Figure 6-10) Group Call

3) RESET

This Reset function converts the TX/RX with no restriction to the previous Close mode. Press the Monitor button (M) at the call mode.

- 1 The call signal will be transmitted to the party's Radio with the ID number + "C" tone.
- 2 If the party's Radio is in the Close channel and after receiving the call with the "C" tone, the call is converted to the "TX/RX with no restriction" mode.

6.9 Emergency Call function

1) This Emergency call is used for calling the party in emergency and if pressing for about 2 seconds the button in Red color on the top side of Radio, the Emergency Call is transmitted.

In case of setting to the emergency call channel (available by PC programming) with your ID at the general mode or if the Radio is in the call mode, you can make an Emergency Call by pressing the button in Red color for about 2 seconds.

The transmission is sent with the "C" tone after your ID number.

1 The party's Radio receives the "C" tone along with your ID number. The Radio recognizes it as an emergency call and displays your ID number with the consecutive alarm sound.

2) Without transmitting the emergency call to the party, the Radio itself makes the emergency call sound continuously.

6.10 STUN function

The Radio is lost or in case you don't want someone to use your Radio, the reception of STUN ID saved in the Radio protects the Radio from the use by someone.

(The Stun ID can be set up by PC Program.) If the STUN ID is saved in the Radio, the Radio can't be used even after the power off & on of Radio. After receiving the UNSTUN ID, you can use the Radio.



Figure 6-11) STUN Screen

6.11 Programming function

The Programming is the function for input of the data such as Frequency/Tone/Scan into the Radio.

* Programming Method

First, please prepare the Program cable for XP-Series Radio.

- 1 Press the "P" button of the Radio to turn on. Then, the **-Prog-** message is displayed.
- 2 Connect the Programming cable to the Ear/Microphone Jack of Radio.
- 3 By using the PC Program, store the data and after disconnecting the cable, turn off the power and turn on the power again.



Figure 6-12) Program Screen

6.12 Cloning function

The CLONING is to copy the data such as Frequency/Tone/Scan into the other Radio.

* Cloning Method

- ① First, please prepare the Clone cable for XP-Series Radio.
- 2 The original Radio should be turned on with pressing the **PTT button** and the Radio to be copied should be turned on with pressing the "**P**" **button** .
- 3 The original Radio displays **-CLON-** message, and the Radio to be copied displays **-Prog-** message.
- ④ Connect the Clon cable to the Ear/Mic Jack of 2 Radios.
- ⑤ If pressing the "**Enter**" **button** of the original Radio, the copy is made and after completing, please disconnect the cable and turn off & on the power of the 2 Radios. Finally please use the Radio after checking if the copy is made without problem.

☞ Caution) If the Cloning is made into the other brand's Radio, a malfunction can happen.



Figure 6-13) CLON Screen

6.13 Menu description

If pressing the "**P**" button on the side for 2 seconds, the Radio will be in Menu mode. The Menu mode consists of 9 Menus and you can use your desired Menu after selection.

☞ Caution) After entering into the Menu, if you don't operate the Menu for more than 8 seconds, the Menu mode will be terminated automatically and it is converted to the Receiving mode.

6.13.1 Compaender selection

This Compaender selection is for On/Off of the Compaender.

The selection can be made by the PC program and at the Menu.

- 1 Enter into the Menu mode.
- 2 By using the channel button(▲, ▼), choose the "Comp" and press the "Enter" button.



- 3 By using the channel button(▲,▼), choose the ON("y") or the OFF("n") and press the "Enter" button to store.
- 4 In order to come out of the Menu mode, press the "P" button and by selecting the On/Off, the Compander ICON on LCD disappears/appears.

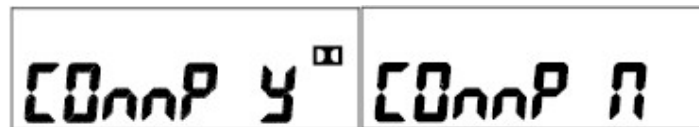

6.13.2 Group change

The Radio is designed to have total 512 channels and 16 Groups and the selection of each Group & Channel can be available by PC program and Menu.

- 1 Enter into the Menu mode.
- 2 By using the channel button(▲, ▼), choose the "Group" and press the "Enter" button.



- 3 Using the channel button(▲,▼), choose the Group and press the "Enter" button to store.
- ④ In order to come out of the Menu mode, press the "P" button.

6.13.3 ID output

This is for transmission of your ID and reception of your party's ID. ID is divided by DTMF and Call ID. Especially the Call ID transmits your ID to the party and also, the party's ID is displayed on your Radio to use your Radio in convenience and efficiently.

- 1 Choose the "Id ANI" by the channel button and press the "Enter" button.



- 2 After the "d-TON" message comes out, choose the ON("y")/OFF("n") by the channel button and press the "Enter" button.



- 3 After the "C-TON" message comes out, choose the ON("y")/OFF("n") by the channel button and press the "Enter" button.



- 4 Comes out of the Menu mode by pressing the "P" button.

6.13.4 Scramble selection

The Scramble is for protection from overhearing and the scramble reverses the voice signal from microphone to a specific frequency and a mixed voice in order for the other person not to hear your voice.

The selection can be available by PC program and Menu.

- 1 Enter into Menu mode.
- 2 Select "SCrA" by pressing Channel buttons (▼,▲), and press **Enter** button().



- 3 Select On(y) or Off (n) by pressing Channel buttons (▼,▲), and save the selected status by pressing **Enter** button().



- ④ Exit Menu mode by pressing Menu Button(P) button. Select “Off”. Then, the “ SCR “ symbol will disappear on the LCD

6.13.5 Set Squelch

Squelch sensitivity level is selectable by 5step.

By PC Program and menu, it could be set.

1. Enter into Menu mode.
2. Select “SQUELCH” by pressing Channel buttons (▼,▲), and press **Enter** button(). Then, the message of the squelch sensitivity will be displayed.



3. Select squelch sensitivity -0~5- by pressing Channel buttons (▼,▲), and press **Enter** button() to save the level



4. Exit Menu mode by pressing Menu Button(P).

6.13.6 Set KEY Sound

Set Key Sound menu is to decide whether to generate sound or not when the user presses four buttons .

By PC Program and menu, it could be set.

1. Enter into Menu mode.
2. Select “Sound” by pressing Channel buttons (▼,▲), and press **Enter** button().



3. Select On(y) or Off (n) by pressing Channel buttons (▼,▲), and save the selected status by pressing **Enter** button().



4. Exit Menu mode by pressing Menu Button(P) button. Select “Off”. Then, the “ ” symbol will disappear on the LCD.

6.13.7 Set VOX

Set VOX is to enable users to make transmission for VOX without pressing PTT button. (This function could be available with Ear Mic [External VOX]).

By PC Program and menu, it could be set.

1. Enter into Menu mode.
2. Select “H-FrEE” by pressing Channel buttons (▼,▲), and press **Enter** button().

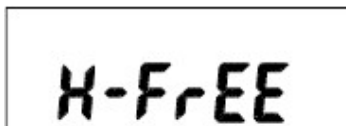

3. Select On(y) or Off (n) by pressing Channel buttons (▼,▲), and press **Enter** button()..

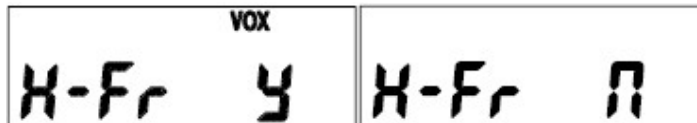

4. Select on(y). Then, the “vox , H-Fr 05” symbol s will appear on the LCD.

Set sensitivity by pressing Channel buttons (▼,▲), and press **Enter** button().



5. Select "Off". Then, the " vox " symbol will disappear on the LCD.
6. Exit Menu mode by pressing Menu Button(P) button.

6.13.8 Set Lone Worker

The Set Lone Worker is for transmission of emergency alarm sound without pressing the designated button within a period of time when night patrol or guarding and the Lone Worker can be set to be ON/OFF.

The selection can be available by PC program and Menu.

1. Enter into Menu mode.
2. Select "LONE W" by pressing Channel buttons (▼,▲), and press **Enter** button().



3. Select On(y) or Off (n) by pressing Channel buttons (▼,▲), and save the selected status by pressing **Enter** button()..



4. Exit Menu mode by pressing Menu Button(P) button.

6.14 Sub-Tone Table

1) TCSS Frequency Table

No.	Frequency	No.	Frequency	No.	Frequency	No.	Frequency
1	67.0	14	107.2	27	167.9	40	159.8
2	71.9	15	110.9	28	173.8	41	183.5
3	74.4	16	114.8	29	179.9	42	189.9
4	77.0	17	118.8	30	186.2	43	196.6
5	79.7	18	123.0	31	192.8	44	199.5
6	82.5	19	127.3	32	203.5	45	206.5
7	85.4	20	131.8	33	210.7	46	229.1
8	88.5	21	136.5	34	218.1	47	254.1
9	91.5	22	141.3	35	225.7	48	165.5
10	94.8	23	146.2	36	233.6	49	171.3
11	97.4	24	151.4	37	241.8	50	177.3
12	100.0	25	156.7	38	250.3	51	60.7
13	103.5	26	162.2	39	69.3	52	62.5

2) DCS Tone Table

No.	DCS Code	No.	DCS Code	No.	DCS Code	No.	DCS Code
1	023	28	172	55	431	82	743
2	025	29	174	56	432	83	754
3	026	30	205	57	445	84	053
4	031	31	223	58	464	85	122
5	032	32	226	59	465	86	036
6	043	33	243	60	466	87	14
7	047	34	244	61	503	88	212
8	051	35	245	62	506	89	225
9	054	36	251	63	516	90	246
10	065	37	261	64	532	91	252
11	071	38	263	65	546	92	255
12	072	39	265	66	565	93	266
13	073	40	271	67	606	94	274
14	074	41	306	68	612	95	325
15	114	42	311	69	624	96	332
16	115	43	315	70	627	97	356
17	116	44	331	71	631	98	446
18	125	45	343	72	632	99	452
19	131	46	346	73	654	100	454
20	132	47	351	74	662	101	455
21	134	48	364	75	664	102	462
22	143	49	365	76	703	103	523
23	152	50	371	77	712	104	526
24	155	51	411	78	723		
25	156	52	412	79	731		
26	162	53	413	80	732		
27	165	54	423	81	734		

7. Precautions

7.1 When using the XP Series Radios

 WARNING	Don't remove the antenna from the Radio or don't transform the antenna or don't make any change on the antenna. The strong electronic wave to be emitted from the Radio can have an effect on the performance of the Radio and can cause the Radio to have a defect.
--	--

 Caution	Don't use the accessories (such as rechargeable battery, adaptor, external speaker microphone and earphone, etc.) from the other makers, which can cause to make a defect on battery and a malfunction or a defect on the Radio.
--	--

 WARNING	Don't disassemble or reorganize the Radio. The disassembly or reorganization will be causes of defect or malfunction and it will be impossible to make repair afterward. Also, a punishment can be made by law.
--	---

 WARNING	Don't use the other frequency except for the permitted frequency in order not to be punished by law.
---	--

 Caution	<ul style="list-style-type: none">• Don't give an excessive shock to the Radio.• Don't place the Radio where the direct sunlight and/or the high temperature occurs.• If the Radio is placed for a long time in car in summer, the hot temperature in the car may cause an explosion of battery.• Don't make a damage to the battery by a sharp substance and/or an excessive shock.
--	---

7.2 Influences to the operations of Radio or other Equipments

The Radio emits a strong electronic wave, which may have an effect on the operation of other equipments and also, can be influenced by the other devices.

 WARNING	Please turn off the Radio before boarding on airplane. When you want to use the Radio in the airplane, please follow the rules in the airplane or the instructions by crew.
--	--

	<p>In case of the area that medical equipments are being used, please use the Radio after discussion with the equipment maker or the related doctor.</p>
---	--

	<p>Please don't use the Radio at the place where computer or the other electric/electronic devices are being used, because the strong electronic wave from the Radio can have an effect on the equipments.</p>
---	--

8. Safety Notes

Please make sure to read the followings for safe and effective use of the Radio.

	<ul style="list-style-type: none"> • Please keep the Radio away at least 1inch from the body. • If the outside surface of antenna gets stripped out, it can make a burn on the skin. • If you contact a conductive metal to battery terminal, a heat can be made and it may cause fire, explosion and burn. Especially, please be careful when putting the battery in a pocket or a bag. • When using an earphone, please don't listen to the sound at a high level. The high sound may have a bad effect on your ear. • After setting the volume of the Radio at a low level, please adjust the volume step by step to the level you want. A sudden high sound may give a bad damage to the ear or the heart. • Please don't remove or replace or charge or discharge the battery at a dangerous area, since it may cause an explosion or a fire by an electrical spark. • At the area where an electromagnetic force can be made, please make sure to turn off the power of the Radio.
---	---

FCC Information

THIS DEVICE COMPLIES WITH PART 15 OF THE FCC RULES. OPERATION IS SUBJECT TO THE CONDITION THAT THIS DEVICE DOES NOT CAUSE HARMFUL INTERFERENCE.

MODIFICATIONS OR CHANGES NOT EXPRESSLY APPROVED BY THE MANUFACTURER COULD VOID THE USER'S AUTHORITY TO OPERATE THE EQUIPMENT.

IMPORTANT NOTE: To maintain compliance with Radio Frequency exposure guidelines, hold the transmitter and antenna at least 1 inch (2.5 centimeters) from your face. If you wear the handset on your body while using the approved accessories, use only the manufacturer's supplied belt clip for this product and ensure that the antenna is at least 1.5 centimeters from your body when transmitting.

Your radio generates radio frequency electromagnetic energy during transmission mode. The radio is designed for and classified as "Occupational Use Only" and must be used by individuals who are properly trained and aware of these hazards and the means in which to minimize such hazards. This radio is NOT intended for use by the "General Population" or in uncontrolled environments.

To ensure that your exposure to radio frequency electromagnetic energy is within the FCC allowable limits for occupational use, always follow these guidelines:

DO NOT transmit for more than 50% of the total radio use time (this is a maximum 50% duty cycle radio). Transmitting more than 50% can cause FCC RF exposure compliance requirements to be exceeded. Pressing the PTT switch enables the radio to transmit. Use ONLY authorized accessories with this equipment. Use of unauthorized accessories can cause the Radio Frequency Exposure compliance requirements to be exceeded.

9. Specification

9.1 XV-100 Specification

General

Frequency Range	VHF: 146 ~ 174 MHz
Frequency Stability	±2.5PPM (-30 to +60 °C)
Programmable Channels	128 Channels/16 Group
Channel Spacing	Dual Channel Spacing 12.5 KHz
Dimensions	97.5mm (H)×49.5mm (W)×25.5mm (D)
Weight	150g (with Battery pack & Antenna)
Power Source	DC +3.7V rechargeable Li-ion 1800 mAh battery pack
Current Drain (maximum)	Receive mode, rated audio out - 280 mA (Audio Max) Transmit mode – 1,500mA Standby mode – 50mA
Duty Cycle(5/5/90)	15.5 Hours(High) / 21 Hours(Low)

Receiver

Sensitivity	.282uV 12 dB SINAD
Squelch Sensitivity	.25uV 10dB SINAD
Selectivity	60dB
Spurious and Harmonic Rejection	70dB
Inter-modulation	60dB
FM Hum and Noise	40dB
Audio Output Power	1 Watt across an 8-ohm load
Audio Distortion	Less than 5% at rated output
Audio Response	+1, -3 dB from 6dB per octave de-emphasis Characteristic from 300 ~ 3000Hz
Speaker Impedance	8 ohms
IF Frequencies	21.4MHz and 455KHz
Input Impedance	50 ohms

Transmitter

RF Power Output	2Watt
Spurious and Harmonic	60dB
FM Hum and Noise	40dB
Audio Distortion	5% maximum with 1KHz modulation
Audio Frequency Response	+1, -3dB from 6dB per octave pre-emphasis Characteristic from 300 ~ 3000Hz
Output Impedance	50 ohms

9.2 XU-100 Specification

General

Frequency Range	UHF: 440 ~ 470 MHz
Frequency Stability	±2.5PPM (-30 to +60 °C)
Programmable Channels	128 Channels/16 Group
Channel Spacing	Dual Channel Spacing 12.5 KHz
Dimensions	97.5mm (H)×49.5mm (W)×25.5mm (D)
Weight	150g (with Battery pack & Antenna)
Power Source	DC +3.7V rechargeable Li-ion 1800 mAh battery pack
Current Drain (maximum)	Receive mode, rated audio out - 2800 mA (Audio Max) Transmit mode – 1500mA Standby mode - 50mA
Duty Cycle(5/5/90)	15 Hours(High) / 20 Hours(Low)

Receiver

Sensitivity	.282uV 12 dB SINAD
Squelch Sensitivity	.25uV 10dB SINAD
Selectivity	60dB
Spurious and Harmonic Rejection	70dB
Inter-modulation	60dB
FM Hum and Noise	40Db
Audio Output Power	Watt across an 8-ohm load
Audio Distortion	Less than 5% at rated output
Audio Response	+1, -3 dB from 6dB per octave de-emphasis Characteristic from 300 ~ 3000Hz
Speaker Impedance	8 ohms
IF Frequencies	45.3MHz and 455KHz
Input Impedance	50 ohms

Transmitter

RF Power Output	2Watt
Spurious and Harmonic	60dB
FM Hum and Noise	40dB
Audio Distortion	5% maximum with 1KHz modulation
Audio Frequency Response	+1, -3dB from 6dB per octave pre-emphasis Characteristic from 300 ~ 3000Hz
Output Impedance	50 ohms