

# Tele Radio 860

## Manual



## CONTENTS

---

3-4	.....	860TX/860RX
5-32	.....	Dansk
33-60	.....	Norsk
61-88	.....	Svensk
89-116	.....	Nederlands
117-144	.....	Español
145-173	.....	Français
174-202	.....	Deutsch
203-232	.....	English

.

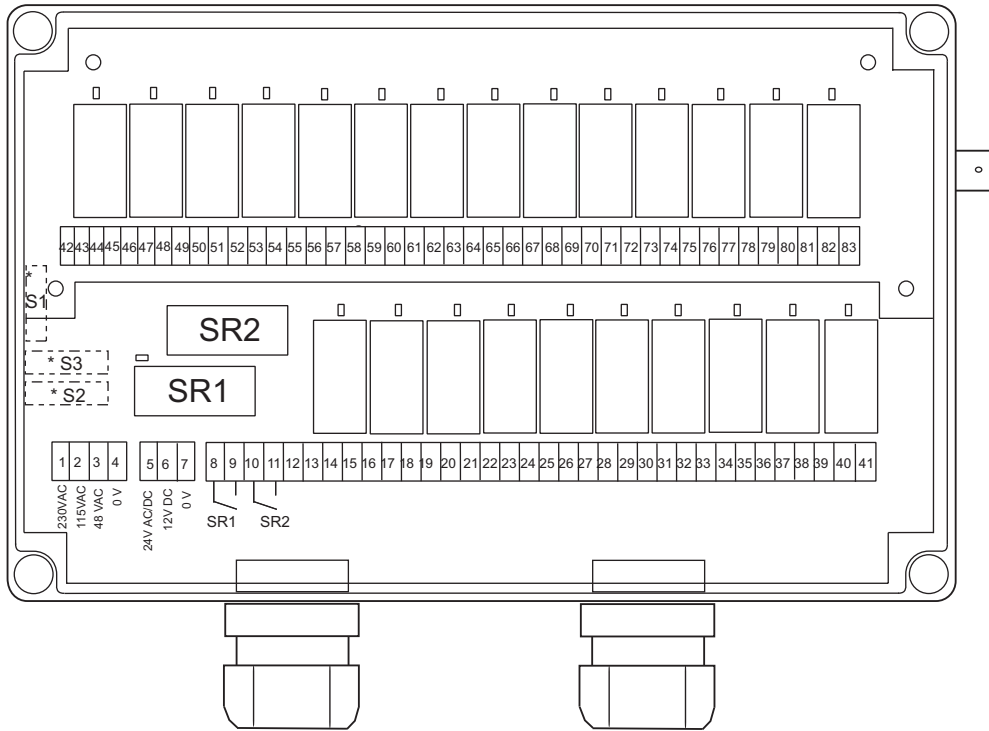

\* Fuse S1, S2 and S3 ceramic slow.

S1	200 mA
S2	300-315 mA
S3	500 mA

860RX

- 1= Red LED 1
- 2= Yellow LED 2
- 3= Reset button
- 4= Green LED 4
- 5= Red LED 5
- 6= Yellow LED 6
- 7= Function selector switch
- 8= Green LED 8
- 9= Red LED 9
- 10= Yellow LED 10
- 11= Radio module
- 12= Green LED 12

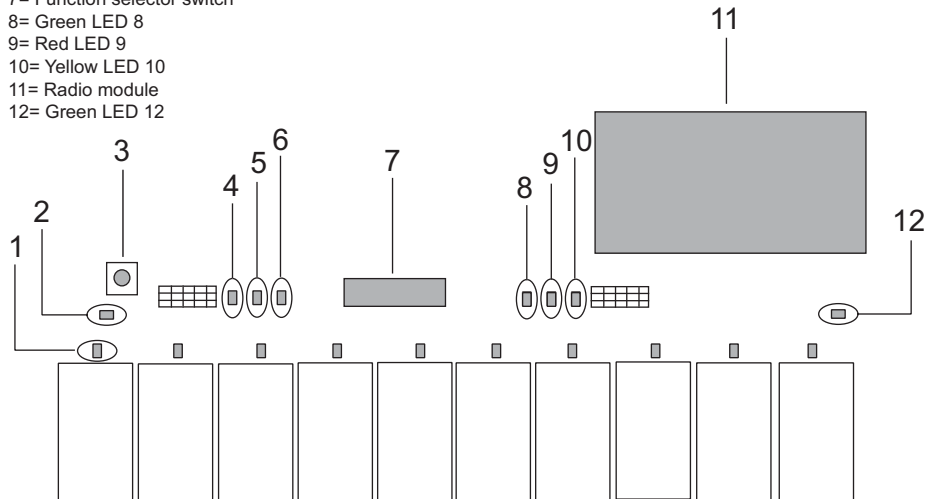

Charging the 860TX-10

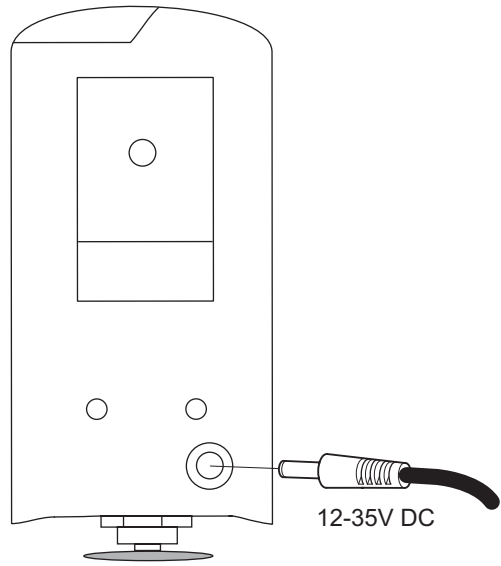

- 1 = Yellow LED 1
- 2 = Yellow LED 2
- 3 = Red/ Green LED 3
- 4 = Charge connector

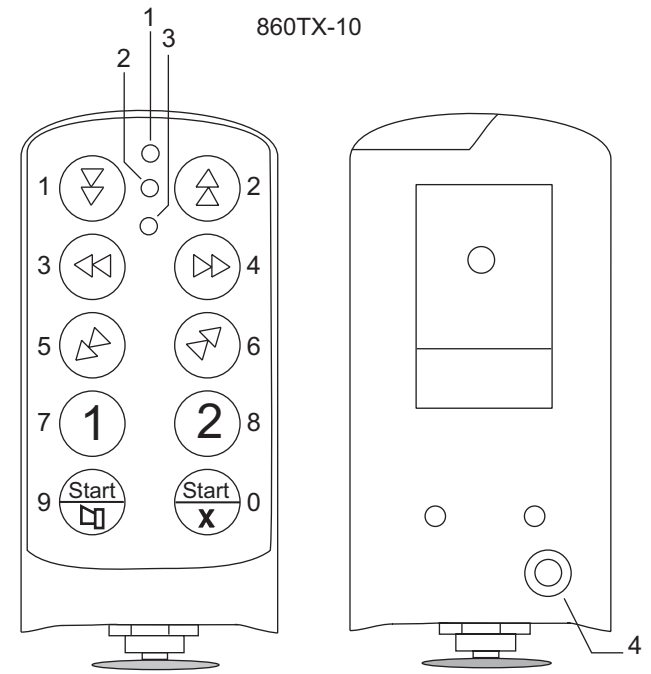

Charging the 860TX-12

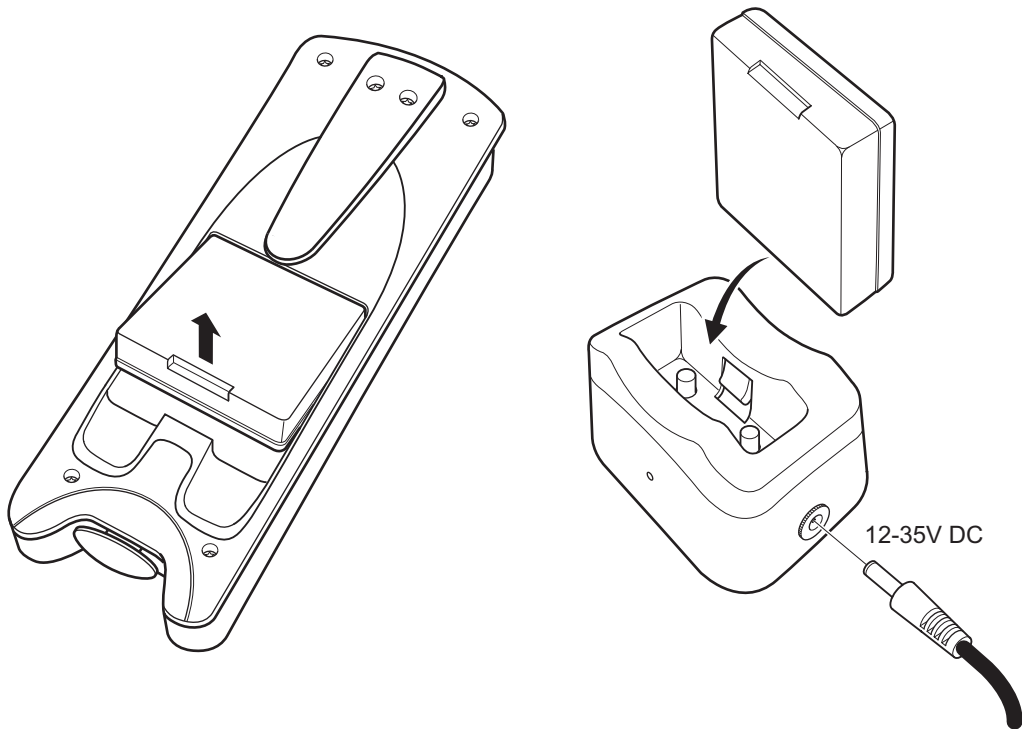

- 1 = Yellow LED 1
- 2 = Yellow LED 2
- 3 = Red/ Green LED 3

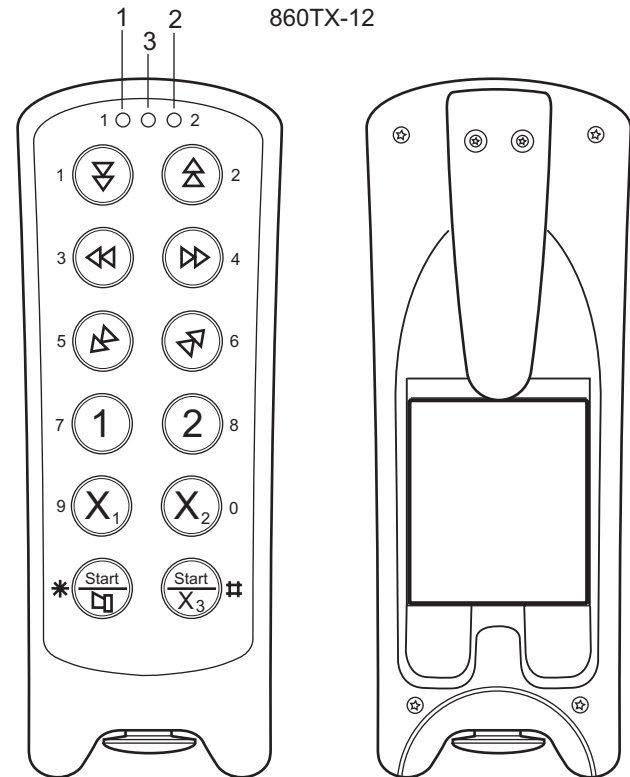

Important!.....	203
System Functions.....	204
Transmitter.....	205
Receiver 860RX.....	206
Installing the receiver and the receiver antenna.....	207
Co-programming the transmitter and receiver.....	208
Erasing all the transmitters in the receiver.....	208
Replace a transmitter in the receiver.....	208
Lock/unlock a receiver.....	209
Radio module mode.....	210
Changing the frequency.....	211
Automatic Shut-off.....	213
Pin code function.....	214
Erasing all pin-codes.....	215
Time delay between pushbuttons.....	215
Function selector.....	216
The transmitter's function selections and led indications.....	218
Yellow LED/start-up.....	219
The receiver's function selection/relay functions.....	220
Momentary or latched relay functions.....	226
Interlocks.....	226
Stop function selector.....	228
Trouble shooting.....	229
Disposal.....	229
Settings form: receiver and transmitter.....	230

**IMPORTANT!**

**!** In order to get the best out of your system it is important you take the time to read through the manual before you start to install/program your equipment.

**ENSURE THAT:**

- Qualified personnel receive a review of the system's functions before it is used.
- Only qualified personnel have access to the transmitter.
- The transmitter is not left unsupervised.
- The transmitter is switched off when not in use.
- The operator always has a complete view of the equipment when radio controlled.

**TO GET STARTED:**

- Start by entering the system's serial number on the Settings form for the receiver and transmitter settings. Enter the other data on the form as you program the system.
- It is an advantage to program as many of the required functions as possible before the receiver is installed, if the receiver is to be placed high up or in any other inaccessible position.
- Check that the supply voltage to the receiver is correct.

## SYSTEM FUNCTIONS

### Frequency

System 860 uses 69 different frequencies, which makes it possible to use several transmitters and receivers within the same coverage area.

### Battery status

The transmitter has an integrated battery indicator which shows when only approx. 10% of the battery capacity remains.

### Automatic shut-off

The transmitter has an automatic shut-off function built-in to conserve battery power. The available selections for automatic shut-off are: after 2, 6 or 12 minutes, or no automatic shut-off.

### Pin code

Up to 10 individual/personal PIN codes can be programmed on each transmitter.

### Time delay between pushbuttons

Time delays can be programmed between pushbuttons and between first and second step in the pushbutton.

### Logging off/on

The receiver can be programmed to accept up to three different transmitters, where each transmitter has its own unique code. For reasons of safety only one transmitter at a time can be logged on. The current transmitter must first be logged off before another transmitter can be logged on.

### Function selection

The system offers the possibility of programming different combinations of relay functions.

### Momentary or latched relay functions

Each function relay can be programmed for momentary or latched relay operations.

### Interlocking

Using this function it is possible to interlock/prioritise a relay function/button before another. If interlocking has been programmed and two buttons on the transmitter are pressed simultaneously, one of the buttons is given priority/interlocked over the other, which means, for example, up and down movements can not be operated at the same time.

### Safety relay

The receiver is supplied with two safety relays, which are continuously monitored.

### Integrated safety function when the transmitter starts: 0-position monitoring

If any button is inadvertently pressed when the transmitter is starting, the transmitter will not start. This is indicated by a red LED. So-called 0-position monitoring.

DK

NO

SE

NL

ES

FR

DE

EN

## TRANSMITTER

*Pictures of the transmitter can be found on the fold-out page.*

### Technical Specifications

#### **860TX-10**

Stop button  
10 two way push buttons  
Internal rechargeable battery  
Radio: PLL Synthesizer  
69 different frequencies, 433.075 - 434.775 MHz  
Enclosure size: 160x70x35 mm  
Weight: approx. 270 g  
Enclosure class: IP 54

#### **860TX-12**

Stop button  
12 two way push buttons  
External rechargeable battery  
Radio: PLL Synthesizer  
69 different frequencies, 433.075 - 434.775 MHz  
Enclosure size: 210x80x40 mm  
Weight: approx. 400 g  
Enclosure class: IP 65

### HOW TO START THE TRANSMITTER

1. The stop button must be pulled out.
2. Press the start buttons simultaneously for at least 1 second.
3. Release the start buttons.
4. LED 3 is lit green to indicate the transmitter is running.

### HOW TO START A TRANSMITTER WITH A PIN CODE

1. The stop button must be pulled out.
  2. Press the start buttons simultaneously for at least 1 second.
  3. Release the buttons.
    - The yellow (2) and green (3) LEDs flash.
  4. Enter the PIN code (4 numbers).
    - The green LED (3) lights continuously.
- If the wrong PIN code is entered the transmitter will switch itself off.

### HOW TO TURN OFF THE TRANSMITTER

To turn off the transmitter press the stop button. All relays in the receiver are disconnected when the stop button is pressed on the transmitter.

### HOW TO CHARGE THE TRANSMITTER:

*Pictures of charging the transmitter can be found on the fold-out page.*

- The 860TX-10 transmitter is supplied with an internal rechargeable battery and an integrated charger.
- The 860TX-12 transmitter is supplied with an external rechargeable battery and a charger unit.

The LED in the transmitter indicates red or green depending on the status of the battery. The operating time for the transmitter is approx. 30 hours for the 860TX-10 and 20 hours for the 860TX-12 with continuous usage. The LED (3) changes colour to red when it is time to charge the battery and approximately 10 % of the battery capacity remains.

The LED in the 860TX-10 transmitter and in the 860TX-12 charger unit, will remain red during charging (full charge time: approx. 4 hours) until fully charged when it changes colour to green. The battery can not be overcharged.

*NOTE! The life span of the battery increases if you wait until the LED changes to red before recharging. However, it should be charged at least once every second month.*

- Charging: 12V-35V DC (500 mA) or 230V AC via an adaptor.

DK  
NO  
SE  
NL  
ES  
FR  
DE  
EN

## RECEIVER 860RX

*Pictures of the receiver can be found on the fold-out page.*

### Technical Specifications

Relay outputs: Midi: 10+2 for stop function, Maxi: 24+2 for stop function

Stop relay: potential free, makes 8A AC I

Function relay: potential free, breaks/makes 16A AC I

Radio: PLL synthesizer

69 different frequencies, 433.075 - 434.775 MHz

Size: 250x175x75 mm

Enclosure class: IP 65

Antenna connector: BNC

SUPPLY VOLTAGE	POWER CONSUMPTION: MIN.	POWER CONSUMPTION: MAX.
12V DC	150 mA	1 A
24V DC	60 mA	600 mA
24V AC	80 mA	800 mA
48V AC	100 mA	400 mA
115V AC	70 mA	200 mA
230V AC	25 mA	100 mA

The different status LEDs on the receiver

Yellow LED 2 lights when the receiver has the correct supply voltage.

Yellow LEDs 6 and 10 flash 1, 2 or 3 times, depending on how many transmitters are programmed on the receiver.

Green LED 12 lights when the receiver receives radio signals (433.075 – 434.775 MHz).

Green LEDs 4 and 8 lights when the receiver has locked on a transmitter.

Red LEDs 5 and 9 indicate that there is a fault on the receiver.

Each relay is fitted with a red LED that lights when the relay is active.

DK

NO

SE

NL

ES

FR

DE

EN



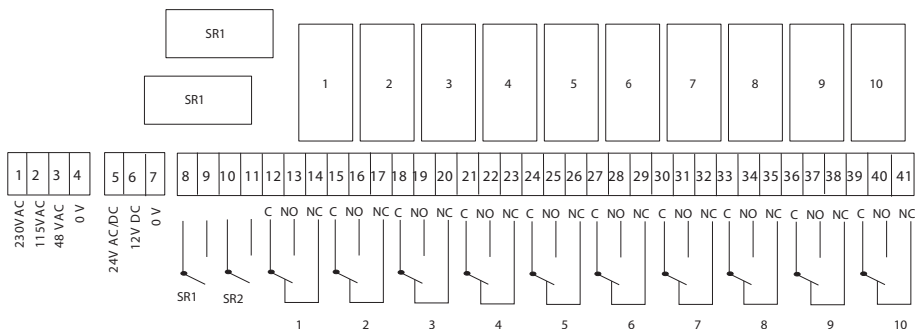

To utilize the safety of the system, be sure to use relays SR1, SR2 as stop relays in the safety circuitry of the object to be controlled.

### INSTALLING THE RECEIVER AND THE RECEIVER ANTENNA

The receiver should be installed:

- As far as possible, protected from the wind and weather. Do not install the receiver in such a way that it can be exposed to exceptional moist conditions such as high-pressure washing
- With the cable glands downward.

Placement of the receiver antenna:

- Place the antenna high above the ground.
- The antenna should not be in the vicinity of metal objects such as girders, electrical cables and other antennas.

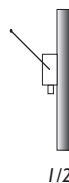

1/2

The 1/2-wave antenna is ground plane independent, which is beneficial and a great advantage when there is not a “natural” ground plane such as a metal plate or vehicle roof. It is important that the antenna is angled out from the wall if the receiver is installed on a wall.

The 1/4-433K antenna with three metre coaxial cable makes it possible to place the antenna high and unobstructed. To get the best possible range with the 1/4-433K antenna it should be installed on a flat roof, free from other metal objects and antennae. When installing the antenna on a vehicle it is suitable to use a vehicle bracket (F1).



1/4-433K

The 5/8-wave antenna with three metre coaxial cable makes it possible to place the antenna high and unobstructed. To get the best possible range with the 5/8-wave antenna it should be installed on a flat roof, free from other metal objects and antennae. When installing the antenna on a wall it is suitable to use a wall bracket (VM1).



5/8

## CO-PROGRAMMING THE TRANSMITTER AND RECEIVER

The receiver can be programmed to accept up to three different transmitters, where each transmitter has its own unique code. The LEDs 6 and 10 on the receiver indicate how many transmitters have been programmed in the receiver.

Not flashing	= No transmitter has been programmed
1 flash	= 1 transmitter has been programmed
2 flashes	= 2 transmitters have been programmed
3 flashes	= 3 transmitters have been programmed

1. On the receiver: turn the function selector switch 2 to the ON position.
2. Press the reset button on the receiver.
  - The green, red and yellow LEDs 4-6 and 8-10 lights.
3. Release the reset button.
  - The green (4 and 8) and red (5 and 9) LEDs go out. The yellow LEDs 6 and 10 light continuously. (If the yellow and red LEDs flash alternately then three transmitters have already been programmed on the receiver, so all the transmitters must be erased and reprogrammed.)
4. Start the transmitter by pressing the start buttons simultaneously for at least 1 second.
  - Release the buttons.
5. Press the start buttons simultaneously again until the yellow LEDs 6 and 10 on the receiver start to flash. The receiver has found the transmitter.
6. On the receiver: turn the function selector switch 2 to the OFF position.
7. The transmitter has been programmed.

*NOTE! Do not forget to complete the Settings form after programming!*

## ERASING ALL THE TRANSMITTERS IN THE RECEIVER

### ON THE RECEIVER

1. Turn the function selector switch 2 to the ON position.
2. Press the reset button.
  - The green (4 and 8), red (5 and 9) and yellow (6 and 10) LEDs light continuously.
3. Release the reset button.
  - The green (4 and 8) and red (5 and 9) LEDs go out. The yellow (6 and 10) LEDs light continuously. (If the yellow and red LEDs flash alternately this means 3 transmitters have been programmed in the receiver.)
4. Turn switch 2 to the OFF position.
5. Turn switch 2 to the ON position within 2 seconds.
  - The yellow (6 and 10) LEDs flash and the receiver has been erased.
6. Turn switch 2 to the OFF position.

## REPLACE A TRANSMITTER IN THE RECEIVER

It is possible to erase a programmed transmitter and program a new transmitter into the receiver without putting the receiver's DIP-switch in program mode. It is very helpful if you would like to replace a transmitter without going up to a high mounted receiver on a crane. This operation will be done from the transmitter that should be programmed into the receiver.

## DO THE FOLLOWING TO REPLACE A TRANSMITTER:

1. Check the ID-code on the transmitter that should be erased from the receiver.
2. Start-up the transmitter that should be programmed into the receiver. You must be in the working range of the receiver that should be erased and programmed.
3. Press the stop button on the transmitter.
  - The red LED 3 lights continuously for 1 second, then (on the transmitter) the yellow LED 2 lights continuously and the red LED 3 starts to flash.
4. Enter the PIN-code. You have 2 seconds per button. If the time elapses, the transmitter will switch off.
  - If no PIN-code has been programmed you should enter 4 zeros (0000).
5. If the PIN-code is ok, the transmitters yellow LED 2 goes out.  
If the wrong PIN-code is entered the transmitter will switch off.
6. Enter the ID-code for the transmitter that should be erased (max 5 numbers). You have 2 seconds per button.  
*Please note that no zeros should be entered if the ID-code is less than 5 numbers. For example: ID-code 678 should be 6, 7, 8 and not 0, 0, 6, 7, 8.*
7. When the ID-code is entered the transmitters red LED 3 lights continuously and the yellow LED 2 will flash. The transmitter will now send a command (10s) to the receiver to erase the selected ID-code and program the ID-code for the operating transmitter.
8. When the transmitter has switched off it can be started-up and used with the selected receiver.  
*Please note that the erased transmitter can no longer be used together with the receiver.*

## LOCK/UNLOCK A RECEIVER

When a transmitter that is programmed to a receiver starts, the receiver “locks” on to the transmitter's ID code. In this position the receiver will only accept this transmitter (even if more transmitters have been programmed on the receiver). The green LEDs 4 and 8 lights on the receiver to confirm that only the selected transmitter can be used.

When another transmitter is to be used the receiver must first be unlocked. Another programmed transmitter can then be locked on to the receiver.

## UNLOCKING THE RECEIVER

The transmitter to be logged must be started/logged on.

On the logged on transmitter (Alternative 1):

1. Press the stop button on the transmitter.
    - The red LED 3 lights continuously for 1 second, then (on the transmitter) the yellow LED 2 lights continuously and the red LED 3 starts to flash.
  2. Enter the PIN code. You have 2 seconds per button.
    - If no PIN code has been programmed you should enter 4 zeros (0000) to unlock the receiver.
  3. If the PIN code is approved, the transmitter sends a signal to unlock the receiver. The transmitter switches itself off and is now logged out.
    - The green LEDs 4 and 8 on the receiver go out and it is now possible for another programmed transmitter to be logged on.
- If the wrong PIN code is entered the transmitter will switch itself off without unlocking the receiver.

On the logged on transmitter (Alternative 2):

1. Press push button 9 (left start button) on the transmitter and then press stop button.
  - The red LED 3 lights continuously for 1 second, then (on the transmitter) the yellow LED 1 flashes. The transmitter then automatically sends a signal to unlock the receiver. The transmitter switches itself off when this operation is done and the transmitter is logged out. The green LEDs 4 and 8 on the receiver go out and it is now possible for another programmed transmitter to be logged on. **NOTE! this way of unlocking the receiver requires that no dangerous function is placed on button 9 (left start button)**

## UNLOCKING THE RECEIVER WITHOUT A TRANSMITTER

---

1. Turn switch 2 to the ON position.
2. Press down the reset button.
  - Green (4 and 8), red (5 and 9) and yellow (6 and 10) LEDs light continuously.
3. Release the reset button.
  - The green (4 and 8) and red (5 and 9) LEDs go out. Yellow LED (6 and 10) lights continuously.
4. Turn switch 2 to the OFF position.
5. Yellow (6 and 10) LEDs go out.

The receiver can now be logged on to another transmitter.

## RADIO MODULE MODE

If the 69 channel radio module is mounted in the transmitter it is possible to program the module to operate in 3 modes. This is very useful when the 69 channel transmitter is used with a receiver with the 16+16 radio modul (old 860 version). If the 16+16 channel radio module is mounted in the transmitter it is not possible to select these modes.

Mode	Channels
0	1-69
1	1-16
2	17-32

## PROGRAMMING RADIO MODULE MODE

---

1. Start the transmitter by pressing the start buttons for at least 1 second.
  - The red LED 3 lights continuously.
2. Release left start button, but hold right start button.

*NOTE! You have 0.3 seconds to perform the action in step 3.*
3. Release right start button and then select button 2 for programming radio module mode. (If you do not press any of the function buttons the transmitter starts.)
  - The yellow LED 2 lights continuously and the green LED 3 starts to flash.
4. Enter the safety code **5, 3, 4, 6**. You have 5 seconds per button, if the time elapses the transmitter switches off.
  - The green LED 3 flashes and the yellow LED 2 goes out if the safety code is correct.
5. Enter a **0** for mode 0 (1-69), a **1** for mode 1 (1-16) or a **2** for mode 2 (17-32).
  - When you have entered the transmitting mode the yellow LED 1 flashes 3 times and the transmitting mode is programmed. The transmitter switches itself off.
6. Restart the transmitter.

## CHANGING THE FREQUENCY

Programming/changing the frequency can only be carried out with the help of the transmitter.

Decide which channel/frequency you wish to transmit on by using the table below before you start programming. The receiver automatically detects and changes to the new frequency.

FREQUENCY TABLE (69 CHANNELS)

CHANNEL	FREQUENCY	CHANNEL	FREQUENCY
01	433,075 MHz	36	433,950 MHz
02	433,100 MHz	37	433,975 MHz
03	433,125 MHz	38	434,000 MHz
04	433,150 MHz	39	434,025 MHz
05	433,175 MHz	40	434,050 MHz
06	433,200 MHz	41	434,075 MHz
07	433,225 MHz	42	434,100 MHz
08	433,250 MHz	43	434,125 MHz
09	433,275 MHz	44	434,150 MHz
10	433,300 MHz	45	434,175 MHz
11	433,325 MHz	46	434,200 MHz
12	433,350 MHz	47	434,225 MHz
13	433,375 MHz	48	434,250 MHz
14	433,400 MHz	49	434,275 MHz
15	433,425 MHz	50	434,300 MHz
16	433,450 MHz	51	434,325 MHz
17	433,475 MHz	52	434,350 MHz
18	433,500 MHz	53	434,375 MHz
19	433,525 MHz	54	434,400 MHz
20	433,550 MHz	55	434,425 MHz
21	433,575 MHz	56	434,450 MHz
22	433,600 MHz	57	434,475 MHz
23	433,625 MHz	58	434,500 MHz
24	433,650 MHz	59	434,525 MHz
25	433,675 MHz	60	434,550 MHz
26	433,700 MHz	61	434,575 MHz
27	433,725 MHz	62	434,600 MHz
28	433,750 MHz	63	434,625 MHz
29	433,775 MHz	64	434,650 MHz
30	433,800 MHz	65	434,675 MHz
31	433,825 MHz	66	434,700 MHz
32	433,850 MHz	67	434,725 MHz
33	433,875 MHz	68	434,750 MHz
34	433,900 MHz	69	434,775 MHz
35	433,925 MHz		

DK

NO

SE

NL

ES

FR

DE

EN

## FREQUENCY TABLE (16+16 CHANNELS)

CHANNEL	FREQUENCY	STRAP	CHANNEL	FREQUENCY	STRAP
01	434.650 MHz	Open	17	434.625 MHz	Closed
02	434.600 MHz	Open	18	434.575 MHz	Closed
03	434.550 MHz	Open	19	434.525 MHz	Closed
04	434.500 MHz	Open	20	434.475 MHz	Closed
05	434.450 MHz	Open	21	434.425 MHz	Closed
06	434.400 MHz	Open	22	434.375 MHz	Closed
07	434.350 MHz	Open	23	434.325 MHz	Closed
08	434.300 MHz	Open	24	434.275 MHz	Closed
09	434.250 MHz	Open	25	434.225 MHz	Closed
10	434.200 MHz	Open	26	434.175 MHz	Closed
11	434.150 MHz	Open	27	434.125 MHz	Closed
12	434.100 MHz	Open	28	434.075 MHz	Closed
13	434.050 MHz	Open	29	434.025 MHz	Closed
14	434.000 MHz	Open	30	434.975 MHz	Closed
15	433.950 MHz	Open	31	433.925 MHz	Closed
16	433.900 MHz	Open	32	433.875 MHz	Closed

## CHANGING THE FREQUENCY

1. Start the transmitter by pressing the start buttons for at least 1 second.
  - The red LED 3 lights continuously.
2. Release left start button, but hold right start button.
 

*NOTE! You have 0.3 seconds to perform the action in step 3.*
3. Release right start button and then select button 2 for the frequency. (If you do not press any of the function buttons the transmitter starts.)
  - The yellow LED 2 lights continuously and the green LED 3 starts to flash.
4. Enter the safety code **1, 2, 3, 4**. You have 5 seconds per button, if the time elapses the transmitter switches off.
  - The green LED 3 flashes and the yellow LED 2 goes out if the safety code is correct.
5. Select the channel/frequency. For example, channel 02: first press the 0 button and then the 2 button.
  - The yellow LED 1 lights each time an accepted button is pressed. Once you have selected the frequency the yellow LED (1) flashes 3 times and programming and the change of frequency are then complete.
6. Restart the transmitter.

*Do not forget to write down the changes on the Settings form after programming!*

## STEP UP/DOWN IN FREQUENCY

---

It is possible to move up or down in frequency before the transmitter is started-up.

1. Start the transmitter by pressing the start buttons for at least 1 second.
2. Release left start button, but hold right start button.
3. Press button 1 (yellow LED 1 indicates) to move up one step in frequency.  
Press button 2 (yellow LED 2 indicates) to move down one step.
  - Example: If you like to move up 5 frequency steps, you need to press button 1 five times.
4. Release all buttons and the transmitter starts on the new frequency.

## AUTOMATIC SHUT-OFF

The transmitter can be programmed with an automatic shut-off function once the last command has been given to conserve battery capacity. See the time options below.

### Time option

- |          |  |
|----------|--|
| Button 0 | = No automatic shut-off.               |
| Button 1 | = Automatic shut-off after 2 minutes.  |
| Button 2 | = Automatic shut-off after 6 minutes.  |
| Button 3 | = Automatic shut-off after 12 minutes. |

## PROGRAMMING AUTOMATIC SHUT-OFF:

---

1. Start the transmitter by pressing the start buttons for at least 1 second.
  - The red LED 3 lights continuously.
2. Release left start button, but hold right start button.  
*NOTE! You have 0.3 seconds to perform the action in step 3.*
3. Release right start button and then select button 3 for automatic shut-off. (If you do not press any of the function buttons the transmitter starts.)
  - The yellow LED 2 lights continuously and the green LED 3 starts to flash.
4. Enter the safety code **1, 2, 3, 4**. You have 5 seconds per button; if the time elapses the transmitter switches off.
  - The green LED 3 flashes and the yellow LED 2 goes out if the safety code is correct.
5. Select the required time option (see the options above).
  - The yellow LED 1 lights each time an accepted button is pressed. Once you have selected an option the yellow LED (1) flashes 3 times and programming is complete.
6. Restart the transmitter.

*Do not forget to write down the changes on the Settings form after programming!*

DK

NO

SE

NL

ES

FR

DE

EN

## PIN CODE FUNCTION

It is possible to program 10 PIN codes on each transmitter.

### PROGRAMMING A PIN CODE:

---

1. Start the transmitter by pressing the start buttons for at least 1 second.
  - The red LED 3 lights continuously.
2. Release left start button, but hold right start button.  
*NOTE! You have 0.3 seconds to perform the action in step 3.*
3. Release right start button and select button 4 for the PIN code. (If you do not press any of the function buttons the transmitter starts.)
  - The yellow LED 2 lights continuously and the green LED 3 starts to flash.
4. Enter the safety code **1, 2, 3, 4**. You have 5 seconds per button, if the time elapses the transmitter switches off.
  - The yellow LED 1 lights each time an accepted button is pressed.
  - The green LED 3 flashes and the yellow LED 2 goes out if the safety code is correct.
5. Select the number (button) the PIN code should be programmed to (0-9).
  - The green LED 3 flashes.
  - The yellow LED 2 will light if the number is used by a PIN code.
6. Select en PIN code by entering a combination of 4 numbers. Confirm the code by repeating it.
  - Once you have selected a PIN code the yellow LED (1) flashes 3 times and programming is complete. The transmitter switches itself off.
7. Restart the transmitter.

*NOTE! The PIN code combination 0000 cannot be used.*

*Do not forget to write down the changes on the Settings form after programming!*

### CHANGING/ERASING THE PIN CODE:

---

1. Start the transmitter by pressing the start buttons for at least 1 second.
  - The red LED 3 lights continuously.
2. Release left start button, but hold right start button.  
*NOTE! You have 0.3 seconds to perform the action in step 3.*
3. Release right start button and select button 4 for the PIN code. (If you do not press any of the function buttons the transmitter starts.)
  - The yellow LED 2 lights continuously and the green LED 3 starts to flash.
4. Enter the safety code **1, 2, 3, 4**. You have 5 seconds per button, if the time elapses the transmitter switches off.
  - The yellow LED 1 lights each time an accepted button is pressed.
  - The green LED 3 flashes and the yellow LED 2 goes out if the safety code is correct.
5. Press the number (0-9) which the PIN code is programmed under.
  - The yellow LED 2 lights continuously.
6. Enter the existing four digit PIN code.
  - The yellow LED 2 goes out if the PIN code is correct.
7. Changing the PIN code: Select a PIN code by entering a combination of 4 numbers. Confirm the code by repeating it.
  - Once you have selected a PIN code the yellow LED (1) flashes 3 times and programming is complete.
8. Erasing the PIN code: Enter four zeros (0000) and confirm by entering the four zeros (0000) again.
  - The yellow LED (1) flashes 3 times and the erasing procedure is complete. The transmitter switches off.
9. Restart the transmitter.



## ERASING ALL PIN-CODES

You can, if necessary, erase all the PIN codes on the transmitter.

### ERASE ALL THE PIN CODES ON THE TRANSMITTER:

1. Start the transmitter by pressing the start buttons for at least 1 second.
  - The red LED 3 lights continuously.
2. Release left start button, but hold right start button.  
*NOTE! You have 0.3 seconds to perform the action in step 3.*
3. Release right start button and then select button 8 to erase the PIN codes.
  - The yellow LED 2 lights continuously and the green LED 3 flashes.
4. Enter the code **7, 1, 0, 4, 2, 1**.
  - Once you have entered the code the yellow LED (1) flashes 3 times and the erasing procedure is complete. The transmitter switches itself off.
5. Restart the transmitter.

## TIME DELAY BETWEEN PUSHBUTTONS

It is possible to program time delays between pushbuttons and between first and second step in the pushbutton. The following options are possible to program:

CODE	PUSHBUTTON DELAY	COMMENTS
0 1	Pushbutton 1 (also used as button 11)	Time delay function between the first and second step for the same pushbutton
0 2	Pushbutton 2 (also used as button 12)	
0 3	Pushbutton 3 (also used as button 13)	
0 4	Pushbutton 4 (also used as button 14)	
0 5	Pushbutton 5 (also used as button 15)	
0 6	Pushbutton 6 (also used as button 16)	
0 7	Pushbutton 7 (also used as button 17)	
0 8	Pushbutton 8 (also used as button 18)	
0 9	Pushbutton 9 (also used as button 19)	
1 0	Pushbutton 10 (also used as button 20)	
2 2 *	Pushbutton 21 (also used as button 23)	Time delay function between two different pushbuttons
2 3 *	Pushbutton 22 (also used as button 24)	
1 1	Pushbutton 1 and 2	
1 2	Pushbutton 3 and 4	
1 3	Pushbutton 5 and 6	
1 4	Pushbutton 7 and 8	
1 5	Pushbutton 9 and 10	
2 4 *	Pushbutton 21 and 22	
1 6	Time delay options, code 01 to 15 (+ 22 to 24 *)	Pre-set programming for all pushbuttons in the specified code range
1 7	Time delay options, code 01 to 10 (+ 22 to 23 *)	
1 8	Time delay options, code 11 to 15 (+ 24 *)	
1 9	Time delay options, code 01 to 06	
2 0	Time delay options, code 11 to 13	
2 1	Time delay options, code 01 to 06 + 11 to 13	

\* Only on 860TX-12

CODE	TIME DELAY	COMMENTS
0	No time delay	Sets the time delay in seconds
1	0,3s	
2	0,5s	
3	1s	
4	1,5s	
5	3s	

## PROGRAMMING TIME DELAY BETWEEN PUSHBUTTONS

- Start the transmitter by pressing the start buttons for at least 1 second.
  - The red LED 3 lights continuously.
- Release left start button, but hold right start button.
 

*NOTE! You have 0.3 seconds to perform the action in step 3.*
- Release right start button and then select button 6 for programming time delay between pushbuttons. (If you do not press any of the function buttons the transmitter starts.)
  - The yellow LED 2 lights continuously and the green LED 3 starts to flash.
- Enter the safety code: **8, 5, 3, 2, 4, 6**. You have 5 seconds per button, if the time elapses the transmitter switches off.
  - The green LED 3 flashes and the yellow LED 2 goes out if the safety code is correct.
- Enter the pushbutton delay code (two digits) and time code (one digit). The yellow LED 1 lights each time an accepted button is pressed.
  - Once you have selected option and time the yellow LED (1) flashes 3 times and programming is complete.
- Restart the transmitter.

## FUNCTION SELECTOR

The functions in the table can be programmed by using the buttons on the transmitter and by setting the function selector switches. Note that the table is only an outline and all function options are described in detail in the chapters that follow the table.

No. of functions	Function selection TX (transmitter)	LED TX (transmitter)	Function selection RX (receiver)	Receiver model (Maxi or Midi)	Function selector switch (receiver) 4, 6, 7, 8.	Comments
10x1	0	-	A	MIDI	OFF.OFF.OFF.OFF	Only 1 receiver
4x2+2x1	0	-	B	MIDI	OFF.OFF.OFF.ON	Only 1 receiver
6x2+1x1	0	-	C	MIDI	OFF.OFF.ON.OFF	Only 1 receiver
10x1	1	1	D	MIDI	OFF.OFF.OFF.OFF	Receiver 1 (8x1)
10x1	1	2	D	MIDI	ON.OFF.OFF.OFF	Receiver 2 (8x1)
10x1	1	1+2	D	MIDI	*.OFF.OFF.OFF	Receiver 1+2 (8x1)
10x1	2	1	E	MIDI	OFF.OFF.OFF.OFF	Receiver 1 (8x1)
10x1	2	2	E	MIDI	ON.OFF.OFF.OFF	Receiver 2 (8x1)
10x1	3	1	F	MIDI	OFF.OFF.OFF.OFF	Receiver 1 (9x1)
10x1	3	2	F	MIDI	ON. OFF.OFF.OFF	Receiver 2 (9x1)
4x2+2x1	1	1	G	MIDI	OFF.OFF.OFF.ON	Receiver 1 (4x2+2x1)
4x2+2x1	1	2	G	MIDI	ON.OFF.OFF.ON	Receiver 2 (4x2+2x1)
4x2+2x1	1	1+2	G	MIDI	*.OFF.OFF.ON	Receiver 1+2 (4x2+2x1)
4x2+2x1	2	1	H	MIDI	OFF.OFF.OFF.ON	Receiver 1 (4x2+2x1)
4x2+2x1	2	2	H	MIDI	ON.OFF.OFF.ON	Receiver 2 (4x2+2x1)

No. of functions	Function selection TX (transmitter)	LED TX (transmitter)	Function selection RX (receiver)	Receiver model (Maxi or Midi)	Function selector switch (receiver) 4, 6, 7, 8.	Comments
6x2+1x1	1	1	I	MIDI	OFF.OFF.ON.OFF	Receiver 1 (6x2+1x1)
6x2+1x1	1	2	I	MIDI	ON.OFF.ON.OFF	Receiver 2 (6x2+1x1)
6x2+1x1	1	1+2	I	MIDI	*.OFF.ON.OFF	Receiver 1+2 (6x2+1x1)
6x2+1x1	2	1	J	MIDI	OFF.OFF.ON.OFF	Receiver 1 (6x2+1x1)
6x2+1x1	2	2	J	MIDI	ON.OFF.ON.OFF	Receiver 2 (6x2+1x1)
10x2/12x2	0	-	K	MAXI	OFF.OFF.OFF.OFF	Only 1 receiver
10x2/12x2	1	1	L	MAXI	OFF.OFF.OFF.OFF	Receiver 1 (8x2)
10x2/12x2	1	2	L	MAXI	ON.OFF.OFF.OFF	Receiver 2 (8x2)
10x2/12x2	1	1+2	L	MAXI	*.OFF.OFF.OFF	Receiver 1+2 (8x2)
10x2/12x2	2	1	M	MAXI	OFF.OFF.OFF.OFF	Receiver 1 (8x2)
10x2/12x2	2	2	M	MAXI	ON.OFF.OFF.OFF	Receiver 2 (8x2)
10x2/12x2	1	1	N	MAXI	OFF.OFF.ON.ON	Lift 1
10x2/12x2	1	2	N	MAXI	OFF.OFF.ON.ON	Lift 2
10x2/12x2	1	1+2	N	MAXI	OFF.OFF.ON.ON	Lift 1+2
10x2/12x2	2	1	O	MAXI	OFF.OFF.ON.ON	Lift 1
10x2/12x2	2	2	O	MAXI	OFF.OFF.ON.ON	Lift 2
10x2/12x2	3	1	P	MAXI	OFF.ON.OFF.OFF	9+9 (Button 1-9->Relay 1-9)
10x2/12x2	3	2	P	MAXI	OFF.ON.OFF.OFF	9+9 (Button 1-9->Relay 11-19)
10x2/12x2	0	-	Q	MAXI	OFF.OFF.ON.OFF	"6x2+1x1" with MAXI relay board
10x2/12x2	0	-	R	MAXI	OFF.ON.ON.OFF	"6x2+6x1" with MAXI relay board

\* = The function selector switch no 4 can be set to ON or OFF.

## THE TRANSMITTER'S FUNCTION SELECTIONS AND LED INDICATIONS

It is possible to program the function selection on the transmitter. The two yellow LEDs on the transmitter indicate which receiver/receivers, relay group/groups or the lift on an overhead crane are to be controlled. By setting the receiver's function selector switch at the same time a number of different types of relay functions can be selected (see chapter "The receiver's function selection/relay functions").

Once you have programmed the function selections 1-3 the transmitter's LED 1 will always light when the transmitter starts.

*NOTE! As standard the transmitter is supplied with function selection 0.*

### FUNCTION SELECTION 0:

---

With function selection 0 it is only possible to control one receiver. The two yellow LEDs are not used.

The transmitter's function selection 0 matches with receiver's function selection; A, B, C, K, Q, R

### FUNCTION SELECTION 1:

---

Using function selection 1 you can control two receivers (receiver 1, receiver 2 or both simultaneously), alternatively you can control two lifts on an overhead crane (lift 1, lift 2 or both lifts simultaneously).

By pressing button 7 the yellow LED 1 lights, press button 8 and the yellow LED 2 lights. Press buttons 7 and 8 simultaneously and the LEDs 1 and 2 light.

The transmitter's function selection 1 matches with receiver's function selection; D, G, I, L, N

### FUNCTION SELECTION 2:

---

Using function selection 2 you can control two receivers (receiver 1 or receiver 2, but never simultaneously), alternatively you can control two lifts on an overhead crane (lift 1 or lift 2 but never simultaneously).

By pressing button 7 the yellow LED 1 lights, press button 8 and the yellow LED 2 lights. The yellow LEDs 1 and 2 can never be lit simultaneously.

The transmitter's function selection 2 matches the receiver's function selection; E, H, J, M, O

### FUNCTION SELECTION 3:

---

With function selection 3 you can control two receivers (9 single functions on each receiver) or one receiver (9+9 single functions).

By pressing button 10 (right start button) you switch between lighting the yellow LED 1 or LED 2. The yellow LEDs 1 and 2 can never be lit simultaneously.

The transmitter function selection 3 matches the receiver's function selection: F, P

DK

NO

SE

NL

ES

FR

DE

EN

## PROGRAMMING THE FUNCTION SELECTION ON THE TRANSMITTER:

---

1. Start the transmitter by pressing the start buttons for at least 1 second.
  - The red LED 3 lights continuously.
2. Release left start button, but hold right start button.

*NOTE! You have 0.3 seconds to perform the action in step 3.*
3. Release right start button and then select button 1 for function selection. (If you do not press any of the function buttons the transmitter starts.)
  - The yellow LED 2 lights continuously and the green LED 3 starts to flash.
4. Enter the safety code: **1, 2, 3, 4**. You have 5 seconds per button, if the time elapses the transmitter switches off.
  - The green LED 3 flashes and the yellow LED 2 goes out if the safety code is correct.
5. Choose the respective function options (button 0, 1, 2 or 3). The yellow LED 1 lights each time an accepted button is pressed.
  - Once you have selected a function option the yellow LED (1) flashes 3 times and programming is complete.

*NOTE! The function is deprogrammed using the 0 button.*
6. Restart the transmitter by pressing the start buttons.

### YELLOW LED/START-UP

If function selection 1 or 2 is programmed in 860 mode it is possible to choose which yellow LED/LED's that should be on when starting the transmitter.

Yellow LED start-up options, function selection 1:

- Option 0: No yellow LED's.
- Option 1: Yellow LED 1 is on.
- Option 2: Yellow LED 2 is on.
- Option 3: Yellow LED 1+2 is on.

Yellow LED start-up options, function selection 2:

- Option 0: No yellow LED's.
- Option 1: Yellow LED 1 is on.
- Option 2: Yellow LED 2 is on.

### PROGRAMMING YELLOW LED/START-UP

---

1. Start the transmitter by pressing the start buttons for at least 1 second.
  - The red LED 3 lights continuously.
2. Release left start button, but hold right start button.

*NOTE! You have 0.3 seconds to perform the action in step 3.*
3. Release right start button and then select button 1 for function selection. (If you do not press any of the function buttons the transmitter starts.)
  - The yellow LED 2 lights continuously and the green LED 3 starts to flash.
4. Enter the safety code: **7, 4, 8, 3**. You have 5 seconds per button, if the time elapses the transmitter switches off.
  - The green LED 3 flashes and the yellow LED 2 goes out if the safety code is correct.
5. Choose the respective yellow LED start-up option (button 0-3).
  - The yellow LED 1 lights each time an accepted button is pressed. Once you have selected a function option the yellow LED (1) flashes 3 times and programming is complete.
6. Restart the transmitter.

## THE RECEIVER'S FUNCTION SELECTION/RELAY FUNCTIONS

Program the function selection on the receiver:

The function selection on the receiver is programmed by setting the function selector switches in either the ON or OFF positions. To see how the switches should be set refer to respective function selections or the function selection table. (For the transmitter's matching function selections, see chapter "The transmitter's function selections and led indications".)

Pictures of the receiver can be found on the fold-out page.

### RECEIVER 860RX-MIDI

Function selection A:

Relay function: 10 single functions (10x1).

See figure A for which buttons control respective relays.

The function selector switch: 4=OFF, 6=OFF, 7=OFF, 8=OFF

The receiver's function selection A matches the transmitter's function selection 0.

Function selection B:

Relay function: 4 double + 2 single functions (4x2+2x1).

See figure B for which buttons control respective relays.

The function selector switch: 4=OFF, 6=OFF, 7=OFF, 8=ON

The receiver's function selection B matches the transmitter's function selection 0.

Function selection C:

Relay function: 6 double + 1 single functions (6 x 2 + 1 x 1).

See figure C for which buttons control respective relays.

The function selector switch: 4=OFF, 6=OFF, 7=ON, 8=OFF

The receiver's function selection C matches the transmitter's function selection 0.

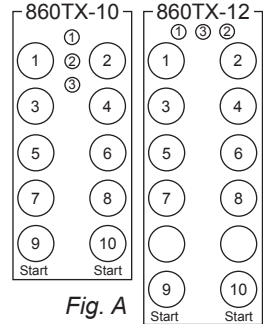

Fig. A

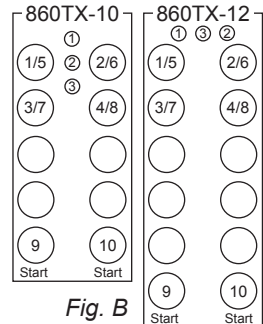

Fig. B

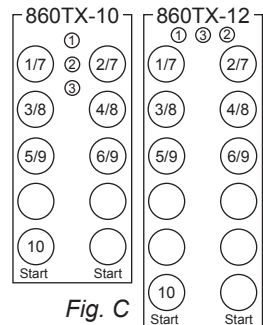

Fig. C

### Function selection D:

Relay function: 8 single functions + 2 relays to indicate that the receiver is selected.

Using the transmitter's buttons 7 and 8 either receiver 1, 2 or both can be controlled. See figure D for which buttons control respective relays.

Receiver 1:

The function selector switch: 4=OFF, 6=OFF, 7=OFF, 8=OFF

Relay 7 is activated when the yellow LED 1 is lit on the transmitter.

Receiver 2:

The function selector switch: 4=ON, 6=OFF, 7=OFF, 8=OFF

Relay 8 is activated when the yellow LED 2 is lit on the transmitter.

The receiver's function selection D matches the transmitter's function selection I.

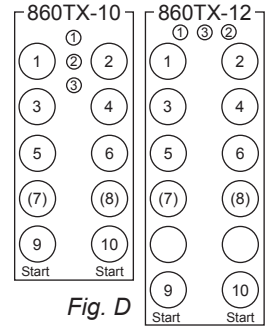

Fig. D

### Function selection E:

Relay function: 8 single functions + 2 relays to indicate that the receiver is selected.

Using the transmitter's buttons 7 and 8 receivers 1 or 2 can be controlled, but never both receivers simultaneously. See figure E for which buttons control respective relays.

Receiver 1:

The function selector switch: 4=OFF, 6=OFF, 7=OFF, 8=OFF

Relay 7 is activated when the yellow LED 1 is lit on the transmitter.

Receiver 2:

The function selector switch: 4=ON, 6=OFF, 7=OFF, 8=OFF

Relay 8 is activated when the yellow LED 2 is lit on the transmitter.

The receiver's function selection E matches the transmitter's function selection 2.

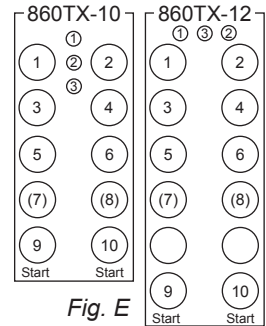

Fig. E

### Function selection F:

Relay function: 9 single functions + 1 relay for indication that the receiver is selected.

Using the transmitter's button 10 receivers 1 or 2 can be controlled, but never both receivers simultaneously. See figure F for which buttons control respective relays.

Receiver 1:

The function selector switch: 4=OFF, 6=OFF, 7=OFF, 8=OFF

Relay 10 is activated when the yellow LED 1 is lit on the transmitter.

Receiver 2:

The function selector switch: 4=ON, 6=OFF, 7=OFF, 8=OFF

Relay 10 is activated when the yellow LED 2 is lit on the transmitter.

The receiver's function selection F matches the transmitter's function selection 3.

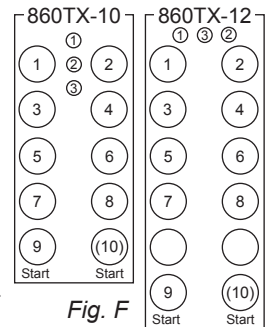

Fig. F

Function selection G:

Relay function: 4 double + 2 single functions (4x2+2x1).

Using the transmitter's buttons 7 and 8 either receiver 1, 2 or both can be controlled. See figure G for which buttons control respective relays.

Receiver 1:

The function selector switch: 4=OFF, 6=OFF, 7=OFF, 8=ON

Receiver 2:

The function selector switch: 4=ON, 6=OFF, 7=OFF, 8=ON

The receiver's function selection G matches the transmitter's function selection 1.

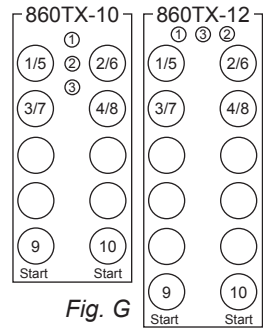

Fig. G

Function selection H:

Relay function: 4 double + 2 single functions (4x2+2x1)

Using the transmitter's buttons 7 and 8 receivers 1 or 2 can be controlled, but never both receivers simultaneously. See figure H for which buttons control respective relays.

Receiver 1:

The function selector switch: 4=OFF, 6=OFF, 7=OFF, 8=ON

Receiver 2:

The function selector switch: 4=ON, 6=OFF, 7=OFF, 8=ON

The receiver's function selection H matches the transmitter's function selection 2.

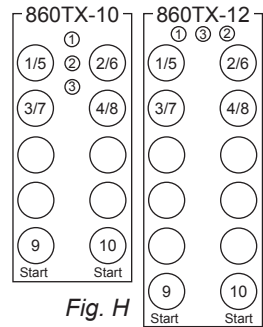

Fig. H

Function selection I:

Relay function: 6 double + 1 single function (6x2+1x1)

Using the transmitter's buttons 7 and 8 either receiver 1, 2 or both can be controlled. See figure I for which buttons control respective relays.

Receiver 1:

The function selector switch: 4=OFF, 6=OFF, 7=ON, 8=OFF

Receiver 2:

The function selector switch: 4=ON, 6=OFF, 7=ON, 8=OFF

The receiver's function selection I matches the transmitter's function selection 1.

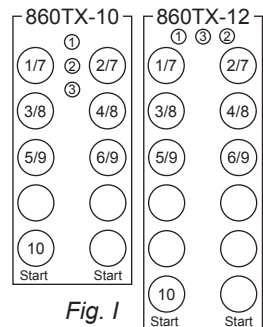

Fig. I



Function selection J:

Relay function: 6 double + 1 single function (6x2+1x1)

Using the transmitter's buttons 7 and 8 receivers 1 or 2 can be controlled, but never both receivers simultaneously. See figure J for which buttons control respective relays.

Receiver 1:

The function selector switch: 4=OFF, 6=OFF, 7=**ON**, 8=OFF

Receiver 2:

The function selector switch: 4=**ON**, 6=OFF, 7=**ON**, 8=OFF

The receiver's function selection J matches the transmitter's function selection 2.

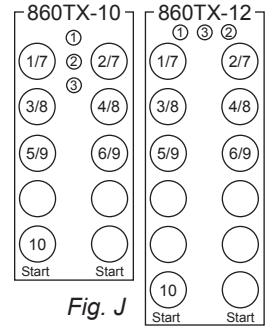

## RECEIVER 860RX-MAXI

The relay functions are depending on the receiver.

Function selection K:

Relay function: 20/24 double functions (10x2/12x2).

See figure K for which buttons control respective relays.

The function selector switch: 4=OFF, 6=OFF, 7=OFF, 8=OFF

The receiver's function selection K matches the transmitter's function selection 0.

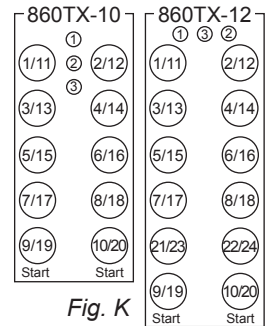

Function selection L:

Relay function: 8/10 double functions + 2 relays to indicate that the receiver is selected.

Using the transmitter's buttons 7 and 8 either receiver 1, 2 or both can be controlled. See figure L for which buttons control respective relays.

Receiver 1:

The function selector switch: 4=OFF, 6=OFF, 7=OFF, 8=OFF

Relay 7 is activated when the yellow LED 1 is lit on the transmitter.

Receiver 2:

The function selector switch: 4=**ON**, 6=OFF, 7=OFF, 8=OFF

Relay 8 is activated when the yellow LED 2 is lit on the transmitter.

The receiver's function selection L matches the transmitter's function selection 1.

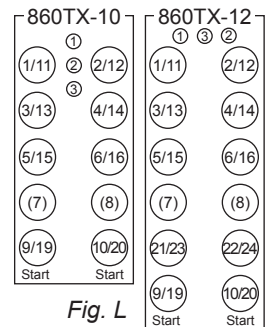

DK  
NO  
SE  
NL  
ES  
FR  
DE  
EN

### Function selection M:

Relay function: 8/10 double functions + 2 relays to indicate that the receiver is selected.

Using the transmitter's buttons 7 and 8 receivers 1 or 2 can be controlled, but both receivers simultaneously. See figure M for which buttons control respective relays.

#### Receiver 1:

The function selector switch: 4=OFF, 6=OFF, 7=OFF, 8=OFF

Relay 7 is activated when the yellow LED 1 is lit on the transmitter.

#### Receiver 2:

The function selector switch: 4=ON, 6=OFF, 7=OFF, 8=OFF

Relay 8 is activated when the yellow LED 2 is lit on the transmitter.

The receiver's function selection M matches the transmitter's function selection 2.

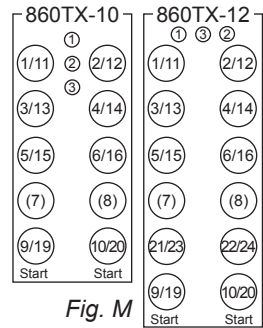

Fig. M

### Function selection N:

Relay function: 8/10 double functions + 2 relays to indicate which lift is selected.

Using the transmitter's buttons 7 and 8 you can control lift 1, 2 or both simultaneously on an overhead crane. See figure N for which buttons control respective relays.

The function selector switch: 4=OFF, 6=OFF, 7=ON, 8=ON

Relay 7 is activated when the yellow LED 1 is lit on the transmitter.

Relay 8 is activated when the yellow LED 2 is lit on the transmitter.

The receiver's function selection N matches the transmitter's function selection 1.

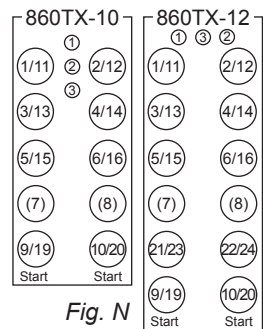

Fig. N

### Function selection O:

Relay function: 8/10 double functions + 2 relays to indicate which lift is selected.

Using the transmitter's buttons 7 and 8 you can control lift 1 or 2 on an overhead crane, but never simultaneously. See figure O for which buttons control respective relays.

The function selector switch: 4=OFF, 6=OFF, 7=ON, 8=ON

Relay 7 is activated when the yellow LED 1 is lit on the transmitter.

Relay 8 is activated when the yellow LED 2 is lit on the transmitter.

The receiver's function selection O matches the transmitter's function selection 2.

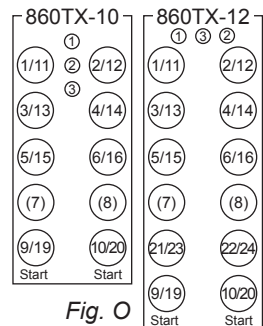

Fig. O

Function selection P:

Relay function: 9+9/11+11 single functions + 2 relays to indicate the selected relay group.

Using the transmitter's button 10 you can select which relay group you want to control (1-9 or 11-19). See figure P for which buttons control respective relays.

The function selector switch: 4=OFF, 6=**ON**, 7=OFF, 8=OFF

Relay 10 is activated when the yellow LED 1 is lit on the transmitter.  
Button 1-9 controls relay 1-9 / Button 21-22 controls relay 21-22.

Relay 20 is activated when the yellow LED 2 is lit on the transmitter.  
Button 1-9 controls relay 11-19 / Button 21-22 controls relay 23-24.

The receiver's function selection P matches the transmitter's function selection 3.

Function selection Q:

This relay mode can be used with 5, 10 or 14 relay MAXI board. Relay 15+17 will be activated if one or more of the pushbuttons are pressed on the transmitter.

The receiver's function selection Q matches the transmitter's function selection 0.

The function selector switch: 4=OFF, 6=OFF, 7=**ON**, 8=OFF

Function selection R:

This relay mode can be used with 5, 10 or 14 relay MAXI board. Relay 23+24 will be activated if one or more of the pushbuttons are pressed on the transmitter.

The receiver's function selection R matches the transmitter's function selection 0.

The function selector switch: 4=OFF, 6=**ON**, 7=**ON**, 8=OFF

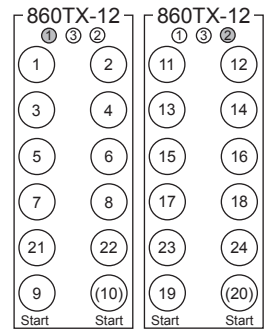
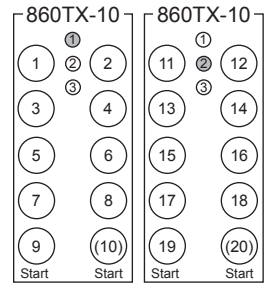

Fig. P

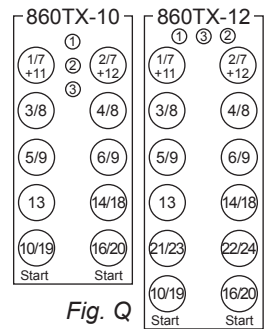

Fig. Q

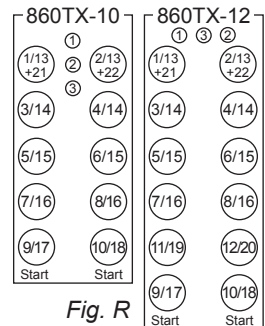

Fig. R

## MOMENTARY OR LATCHED RELAY FUNCTIONS

The system is supplied with an momentary function as the default setting. Program as set out below if you want a latched function.

Momentary function:

The relay only switches/activates during the period the button on the transmitter is pressed down.

Latched/Toggling function:

The position of the relay changes each time the button on the transmitter is pressed, but maintains its new position once the button has been released.

### PROGRAMMING THE LATCHED RELAY FUNCTION:

1. Start the system.
2. Turn the receiver's function selector switch I to the ON position.
  - All the relays in the receiver are disconnected and the red LEDs for respective relays go out.
3. Press the buttons on the transmitter that you wish to assign a latched/toggling function.
  - The red LED will light continuously above respective relays that you have chosen to assign latched/toggling functions.
4. Turn the receiver's function selector switch I to the OFF position.
  - Latched relay functions are programmed and can now be used.

### RETURN TO THE DEFAULT SETTING (MOMENTARY):

1. Start the system.
2. Turn the receiver's function selector switch I to the ON position.
  - All the relays in the receiver are disconnected and the red LEDs for respective relays go out.
3. Turn the receiver's function selector switch I to the OFF position.
  - All relays have an momentary function.

## INTERLOCKS

Interlocking means it is possible to interlock/prioritise a relay function/button before another.

If interlocking has been programmed and two buttons on the transmitter are pressed simultaneously, one the buttons is given priority/interlocked over the other, which means, for example, up and down movements cannot be operated at the same time.

Look through and decide what options you want to program, by using the table below, before you start programming.

*Note that the option OFF OFF = no interlocking. (Example LED 1 = OFF and LED 2 = OFF.)*

Interlocks 10x1	Red LEDs for resp. relays	
Functions 1-2 are blocked when pressed simultaneously.	LED 1 = ON	LED 2 = ON
Functions 3-4 are blocked when pressed simultaneously.	LED 3 = ON	LED 4 = ON
Functions 5-6 are blocked when pressed simultaneously.	LED 5 = ON	LED 6 = ON
Functions 7-8 are blocked when pressed simultaneously.	LED 7 = ON	LED 8 = ON
Functions 9-10 are blocked when pressed simultaneously.	LED 9 = ON	LED 10 = ON
Interlocks 10x2/12x2	Red LEDs for resp relays	
Function 11 has priority over 1, function 12 over 2.	LED 1 = ON	LED 2 = OFF
Function 11 has priority over 1, function 12 over 2. Function 1-2, 11-12 are blocked when pressed simultaneously.	LED 1 = OFF	LED 2 = ON
Function 1-2, 11-12 are blocked when pressed simultaneously.	LED 1 = ON	LED 2 = ON
Function 13 has priority over 3, function 14 over 4.	LED 3 = ON	LED 4 = OFF
Function 13 has priority over 3, function 14 over 4. Functions 3-4, 13-14 are blocked when pressed simultaneously.	LED 3 = OFF	LED 4 = ON

Functions 3-4, 13-14 are blocked when pressed simultaneously.	LED 3 = ON	LED 4 = ON
Function 15 has priority over 5, function 16 over 6.	LED 5 = ON	LED 6 = OFF
Function 15 has priority over 5, function 16 over 6. Functions 5-6, 15-16 are blocked when pressed simultaneously.	LED 5 = OFF	LED 6 = ON
Functions 5-6, 15-16 are blocked when pressed simultaneously.	LED 5 = ON	LED 6 = ON
Function 17 has priority over 7, function 18 over 8.	LED 7 = ON	LED 8 = OFF
Function 17 has priority over 7, function 18 over 8. Functions 7-8, 17-18 are blocked when pressed simultaneously.	LED 7 = OFF	LED 8 = ON
Functions 7-8, 17-18 are blocked when pressed simultaneously.	LED 7 = ON	LED 8 = ON
Function 19 has priority over 9, function 20 over 10.	LED 9 = ON	LED 10 = OFF
Function 19 has priority over 9, function 20 over 10. Functions 9-10, 19-20 are blocked when pressed simultaneously.	LED 9 = OFF	LED 10 = ON
Functions 9-10, 19-20 are blocked when pressed simultaneously.	LED 9 = ON	LED 10 = ON
Function 23 has priority over 21, function 24 over 22.	LED 21 = ON	LED 22 = OFF
Function 23 has priority over 21, function 24 over 22. Functions 21-23, 22-24 are blocked when pressed simultaneously.	LED 21 = ON	LED 22 = ON
Functions 21-23, 22-24 are blocked when pressed simultaneously.	LED 21 = ON	LED 22 = ON
<b>Interlocks 4x2+2</b>		
Red LEDs for resp. relays		
Function 5 has priority over 1, function 6 over 2.	LED 1 = ON	LED 2 = OFF
Function 5 has priority over 1, function 6 over 2. Functions 1-2, 5-6 are blocked when pressed simultaneously.	LED 1 = OFF	LED 2 = ON
Functions 1-2, 5-6 are blocked when pressed simultaneously.	LED 1 = ON	LED 2 = ON
Function 7 has priority over 3, function 8 over 4.	LED 3 = ON	LED 4 = OFF
Function 7 has priority over 3, function 8 over 4. Functions 3-4, 7-8 are blocked when pressed simultaneously.	LED 3 = OFF	LED 4 = ON
Functions 3-4, 7-8 are blocked when pressed simultaneously	LED 3 = ON	LED 4 = ON
Functions 9-10 are blocked when pressed simultaneously.	LED 9 = ON	LED 10 = ON
<b>Interlocks 6x2+1</b>		
Red LEDs for resp relays		
Function 7 has priority over 1, function 7 over 2.	LED 1 = ON	LED 2 = OFF
Function 7 has priority over 1, function 7 over 2. Functions 1-2 and 7 are blocked when pressed simultaneously.	LED 1 = OFF	LED 2 = ON
Functions 1-2 and 7 are blocked when pressed simultaneously.	LED 1 = ON	LED 2 = ON
Function 8 has priority over 3, function 8 over 4.	LED 3 = ON	LED 4 = OFF
Function 8 has priority over 3, function 8 over 4. Functions 3-4 and 8 are blocked when pressed simultaneously.	LED 3 = OFF	LED 4 = ON
Functions 3-4 and 8 are blocked when pressed simultaneously.	LED 3 = ON	LED 4 = ON
Function 9 has priority over 5, function 9 over 6.	LED 5 = ON	LED 6 = OFF
Function 9 has priority over 5, function 9 over 6. Functions 5-6 and 9 are blocked when pressed simultaneously.	LED 5 = OFF	LED 6 = ON
Functions 5-6 and 9 are blocked when pressed simultaneously.	LED 5 = ON	LED 6 = ON

## PROGRAMMING THE INTERLOCK:

---

1. Start the system.
2. On the receiver: Turn the function selector switch 3 to the ON position.
  - All the relays in the receiver are disconnected and the red LEDs for respective relays go out.
3. On the transmitter: program by pressing the buttons (LED) defined as ON in the table "Interlock".  
Example: LED 5 = OFF and LED 6 = ON, is programmed by pressing button 6 on the transmitter, the LEDs will then light according to the required interlock option. The red LEDs will light continuously above the relays you have chosen.
4. On the receiver: Turn the switch 3 to the OFF position.
  - The interlock is programmed and can now be used.

## ERASE THE INTERLOCK:

---

1. Start the system.
2. On the receiver: Turn the function selector switch 3 to the ON position.
  - All the relays in the receiver are disconnected and the red LEDs for respective relays go out.
3. On the receiver: Turn the function selector switch 3 to the OFF position.
  - The interlock is now erased (no relays are interlocked).

## STOP FUNCTION SELECTOR

It is possible to select two different stop function modes with the receiver function selector switch number 5.

If the transmitter is started-up and have contact with the receiver the difference in the modes are the following:

Receiver function selector switch number 5 in **OFF** position:

The stop relay in the receiver will be activated after the receiver had a power failure if the transmitters push-buttons are not activated (zero position check).

Receiver function selector switch number 5 in **ON** position:

If a power failure occurs to the receiver all relays will switch off. When the power comes back the receiver will not start-up the stop relays again. The operator need to press the start buttons at the same time and after that release them to start-up the receiver. If the transmitter is switched off during the power failure and started again after the power is back, it is not necessary to press the start buttons to start-up the receiver.

DK

NO

SE

NL

ES

FR

DE

EN

## TROUBLE SHOOTING

If the equipment does not work as it should, please check the points set out below.

Incorrect function	Possible cause	Action
The receiver's yellow LED for a correct supply voltage is not lit.	Incorrect operating voltage to the receiver.	Check the operating voltage.
	The fuse in the receiver is not intact.	Replace the fuse.
The receiver's yellow LEDs for the number of programmed transmitters do not flash.	A transmitter has not been programmed on the receiver.	Program the required transmitter.
The transmitter does not work when the start buttons are pressed simultaneously (at least 1 second) and then released. The LED on the transmitter produces a red light.	The battery is discharged.	Charge the transmitter.
	A button on the transmitter is broken.	Contact your dealer.
When the transmitter is started the red LED 3 flashes when you press the start buttons simultaneously.	The stop button is pressed in.	Pull out the stop button.
When the transmitter is started the red LED and the yellow LED 1 flash when you press the start buttons simultaneously.	The processor indicates that it has found a fault with the stop button.	Push in the stop button without releasing the start buttons. If the stop button is intact LED 2 should start to flash. Pull out the stop button and release the start buttons. If the transmitter does not start after this instruction the stop button needs to be replaced. Contact your dealer.
The range is too short.	The antenna, antenna cables are damaged or installed incorrectly.	Change the position of the antenna. Change the antenna cable.
Red LED (5 or 9) in the receiver flashes (560ms on/560ms off).	Microcontroller EEPROM memory error.	Contact your dealer.
Red LED (5 or 9) in the receiver flashes (150ms on/150ms off).	Safety relays SR1 or SR2 contact error.	Contact your dealer.
Red LED (5 or 9) in the receiver lights constantly.	Microcontroller RAM/ROM memory error.	Contact your dealer.

Please contact your dealer if you have followed these instructions and despite this have not managed to get the radio system to work.

## DISPOSAL

The 860, any accessories and all replaced parts must be disposed of and recycled in accordance with the local environmental regulations regarding the disposal of used equipment and waste.

DK

NO

SE

NL

ES

FR

DE

EN

## SETTINGS FORM: RECEIVER AND TRANSMITTER

The following data should be documented. Copy the form and enclose it when a service is required.

**Receiver series no:** \_\_\_\_\_

Toggleing relay: \_\_\_\_\_

Interlocks: \_\_\_\_\_

Programmed transmitters:

ID1: \_\_\_\_\_ ID2: \_\_\_\_\_ ID3: \_\_\_\_\_

**Transmitter series no:** \_\_\_\_\_

Function selection: \_\_\_\_\_

Automatic shut-off: \_\_\_\_\_

Frequency: \_\_\_\_\_

PIN-position PIN-code/Name

1 \_\_\_\_\_

2 \_\_\_\_\_

3 \_\_\_\_\_

4 \_\_\_\_\_

5 \_\_\_\_\_

6 \_\_\_\_\_

7 \_\_\_\_\_

8 \_\_\_\_\_

9 \_\_\_\_\_

0 \_\_\_\_\_

**Transmitter series no:** \_\_\_\_\_

Function selection: \_\_\_\_\_

Automatic shut-off: \_\_\_\_\_

Frequency: \_\_\_\_\_

PIN-position PIN-code/Name

1 \_\_\_\_\_

2 \_\_\_\_\_

3 \_\_\_\_\_

4 \_\_\_\_\_

5 \_\_\_\_\_

6 \_\_\_\_\_

7 \_\_\_\_\_

8 \_\_\_\_\_

9 \_\_\_\_\_

0 \_\_\_\_\_

**Transmitter series no:** \_\_\_\_\_

Function selection: \_\_\_\_\_

Automatic shut-off: \_\_\_\_\_

Frequency: \_\_\_\_\_

PIN-position PIN-code/Name

1 \_\_\_\_\_

2 \_\_\_\_\_

3 \_\_\_\_\_

4 \_\_\_\_\_

5 \_\_\_\_\_

6 \_\_\_\_\_

7 \_\_\_\_\_

8 \_\_\_\_\_

9 \_\_\_\_\_

0 \_\_\_\_\_

CE0682 Ⓢ

“ EC Declaration of Conformity for Tele Radio radio remote control systems can be found at <http://www.tele-radio.com>”



# APPENDIX

## 15.19 - TWO PART WARNING STATEMENT

---

THIS DEVICE COMPLIES WITH PART 15 OF THE FCC RULES. OPERATION IS SUBJECT TO THE FOLLOWING TWO CONDITIONS: (1) THIS DEVICE MAY NOT CAUSE HARMFUL INTERFERENCE, AND (2) THIS DEVICE MUST ACCEPT ANY INTERFERENCE RECEIVED, INCLUDING INTERFERENCE THAT MAY CAUSE UNDESIRE OPERATION.

## 15.21 - MODIFICATION STATEMENT

---

NOTE: THE MANUFACTURER IS NOT RESPONSIBLE FOR ANY RADIO OR TV INTERFERENCE CAUSED BY UNAUTHORIZED MODIFICATIONS TO THIS EQUIPMENT. SUCH MODIFICATIONS COULD VOID THE USER'S AUTHORITY TO OPERATE THE EQUIPMENT.

DK

NO

SE

NL

ES

FR

DE

EN



[www.tele-radio.com](http://www.tele-radio.com)

**Tele Radio AS**

Norway

Tel +47-6933 4900

e-mail [m.sundt@tele-radio.com](mailto:m.sundt@tele-radio.com)

**Tele Radio OÜ**

Estonia

Tel. +372 44 511 44

e-mail [m.jurissoo@tele-radio.com](mailto:m.jurissoo@tele-radio.com)

**Tele Radio AB**

Sweden, Main Office

Tel. +46 (0)31 748 54 60

e-mail [info@tele-radio.com](mailto:info@tele-radio.com)

**Tele Radio GmbH**

Deutschland

Tel +49 (0)94 51-94 91 11

e-mail [kontakt@tele-radio.com](mailto:kontakt@tele-radio.com)

**Tele Radio BV**

Netherlands

Tel +31-(0)70-419 41 20

e-mail [info@teleradio.nl](mailto:info@teleradio.nl)

**Tele Radio LTD**

England

Tel. +44 (0)1663 732200

e-mail: [sales@teleradiouk.com](mailto:sales@teleradiouk.com)

**Tele Man LLC**

USA

Tel +1 (305) 459-0763

e-mail [m.tellez@tele-radio.com](mailto:m.tellez@tele-radio.com)

**Tele Radio LLC**

c/o Cervis Incorp., USA

Tel +1 724 452-3775

e-mail [sales@cervis.net](mailto:sales@cervis.net)

**Tele Radio ASIA**

China

Tel. +86 -(0)592-8910122

e-mail [b.sun@tele-radio.com](mailto:b.sun@tele-radio.com)