

REV.	Δ	DESCRIPTION	E.C.N.	DATE	DRAWN	CHECKED
A						



**PROPRIETARY INFORMATION**

ALL RIGHTS RESERVED. NO PARTS OF THIS DOCUMENT MAY BE REPRODUCED, STORED IN RETRIEVAL SYSTEM, OR TRANSMITTED IN ANY FORM OR BY ANY MEANS, ELECTRONIC, MECHANICAL, PHOTOCOPYING, RECORDING OR OTHERWISE WITHOUT THE PRIOR WRITTEN PERMISSION OF TELEMATICS WIRELESS LTD. NOR USED IN WHOLE OR IN PART FOR ANY PURPOSE OR FOR ANY CUSTOMER EXCEPT TELEMATICS WIRELESS.

NAME:  <b>ASTM READER –FP-300RA</b> <b>User Manual</b>	DESIGNED	G.F.K.	11-Aug-2005	SHEET/OF 1 / 38										
	CHECKED	M.N.	11-Aug-2005											
	APPROVED	A.S.	11-Aug-2005											
	Q.A.	A.S.	11-Aug-2005											
PROD/PROJ: ASTM Reader	2	1	4	0	7	2	0	1	8	0	0	0	0	SIZE <b>A</b>

**Note:**

This device complies with Part 15 of the FCC Rules.

Operation is subject to the following two conditions:

- 1) This device may not cause harmful interference, and
- 2) This device must accept any interference received, including interference that may cause undesired operation.

**WARNING!** Changes or modifications to this unit not expressly approved by Telematics Wireless Ltd. could void the user's authority to operate the equipment.

The digital portion of the transceiver has been tested and found to comply with the limits for a Class B digital device, pursuant to part 15 of the FCC Rules. These limits are designed to provide reasonable protection against harmful interference in a residential installation. This equipment generates, uses and can radiate radio frequency energy and, if not installed and used in accordance with the instructions, may cause harmful interference to radio communications. However, there is no guarantee that interference will not occur in a particular installation. If this equipment does cause harmful interference to radio or television reception, which can be determined by turning the equipment off and on, the user is encouraged to try to correct the interference by the following measure:

-Increase the separation between the equipment and receiver.

The antenna and therefore the unit, used for this transmitter must be installed to normally provide minimum separation distance of at least 2 meters from all persons and must not be co-located or operating in conjunction with any other antenna or transmitter.

The Reader is sold with power cable with molded ferrite that provide common-mode filtering. Recommended ferrite manufacturer: Fair-Rite, part number: 0444164281.

The communication cables shall be installed by professional installer, placing ferrites on the cables that are supplied with unit.

Recommended ferrite manufacturer: Fair-Rite, part number: 0444164281.

## Table Of Contents

<b>CHAPTER 1: INTRODUCTION .....</b>	<b>5</b>
1.1 SCOPE.....	5
1.2 GENERAL DESCRIPTION .....	6
1.2.1 Purpose and Use.....	6
1.2.2 Main Technical Characteristics.....	7
1.2.3 Maintenance Utility .....	7
1.2.4 Additional Equipment Needed.....	7
1.3 PHYSICAL DESCRIPTION .....	8
1.4 FUNCTIONAL DESCRIPTION.....	9
1.4.1 Normal Mode.....	9
1.4.1.1 Normal Mode Functions .....	9
1.4.1.2 Transponder Access Capabilities.....	9
1.4.1.3 Air Interface .....	9
1.4.1.4 Multilane Support .....	10
1.4.1.5 Lane Discrimination Support.....	11
1.4.1.6 Support for Reader Synchronization.....	11
1.4.1.7 Active List.....	11
1.4.1.8 Hot Lists.....	12
1.4.2 Maintenance Mode .....	12
1.4.2.1 Configuration .....	12
1.4.2.2 Communication Zone Calibration.....	12
1.4.2.3 Self-Test.....	12
1.4.3 Host Communication .....	13
1.4.4 Real-Time Clock.....	13
<b>CHAPTER 2: INSTALLATION.....</b>	<b>14</b>
2.1 GENERAL.....	14
2.2 INSTALLATION REQUIREMENTS.....	14
2.2.1 Integration in Systems.....	14
2.2.2 Safety Considerations .....	15
2.2.3 Mechanical Data .....	15
2.3 INSTALLATION GUIDELINES.....	16
2.3.1 Power Requirements .....	16
2.3.2 Antennas .....	16
2.3.2.1 Antenna Mounting Position Requirements .....	17
2.3.2.2 FP-300RA-to-Antenna Cabling .....	17
2.3.3 Communication Cables.....	17
2.3.4 Grounding and Lightning Protection Requirements .....	18
2.4 INSTALLATION PROCEDURE.....	18
2.4.1 Tools and Materials.....	18
2.4.2 Preparation for Installation .....	18
2.4.3 FP-300RA Installation Procedure.....	18
2.4.3.1 Physical Installation.....	18
2.4.3.2 Cable Connections .....	19
2.4.3.3 Final Inspection.....	19
<b>CHAPTER 3: OPERATION .....</b>	<b>20</b>
3.1 SCOPE.....	20
3.2 POWER-UP.....	20
3.3 FP-300RA CONFIGURATION .....	21
3.3.1 Setting Host Interface Parameters.....	21
3.3.2 Setting Initial Tx Mode.....	21
3.3.3 Setting TDMA Mode.....	22

3.3.4	Setting Transponder Access Parameters .....	22
3.3.5	Setting Burst Mode .....	22
3.3.6	Setting SYNC Mode .....	22
3.3.7	Setting Multilane Mode .....	23
3.3.8	Setting Lane Discrimination .....	23
3.3.9	Setting Digital I/O .....	24
3.3.10	Save Current Settings.....	24
3.4	HOT LIST CONFIGURATION .....	24
3.4.1	Get Hot List Status.....	24
3.4.2	Remove Hot List.....	24
3.4.3	Add New Hot List.....	24
3.4.4	Set Hot List Auto Function .....	25
3.4.5	Add Transponder to Hot List.....	25
3.4.6	Remove Transponder from Hot List.....	25
3.4.7	Saving the Hot List .....	25
<b>APPENDIX A: CONNECTION DATA .....</b>		<b>26</b>
A-1	ANTENNA CONNECTORS .....	26
A-2	POWER INPUT CONNECTOR.....	26
A-3	DIGITAL INTERFACE CONNECTOR .....	26
A-4	HOST INTERFACE CONNECTOR .....	27
A-5	MAINTENANCE INTERFACE CONNECTOR.....	28
A-6	AUXILIARY INTERFACE CONNECTOR .....	28
<b>APPENDIX B: MAINTENANCE UTILITY.....</b>		<b>30</b>
B-1.	SCOPE.....	30
B-2.	INSTALLATION .....	30
B-2.1	Hardware and Software Requirements .....	30
B-2.2	Installation Procedure .....	30
B-2.3	Preliminary Configuration .....	30
B-3.	MAIN WINDOW .....	31
B-3.1	Monitor Area.....	31
B-3.2	Active List Area.....	31
B-3.3	Log File.....	32
B-3.4	Sending Periodic Status Request .....	32
B-3.5	Setting the Communication Mode .....	32
B-3.6	Setting/Resetting the Digital Output Port .....	32
B-3.7	Information Fields.....	32
B-3.8	Requests Area .....	33
B-3.9	Setting Area .....	33
B-4.	FILE MENU .....	34
B-5.	FP-300RA CONFIGURATION WINDOW .....	35
B-6.	HOT LIST .....	36
B-6.1	Auto-Function .....	36
B-7.	RF SETTING WINDOW .....	37
B-7.1	Get Button.....	37
B-7.2	Set Default Button .....	37
B-7.3	Tx Mode.....	37
B-7.4	Transmitter.....	38
B-7.5	Receiver .....	38
B-7.6	Vector Modulator.....	38
B-7.7	Calibration Process .....	38

# Chapter 1: Introduction

## 1.1 Scope

This manual covers the characteristics, applications, installation, configuration and maintenance of the FP-300RA reader, an advanced and flexible roadside component offered by Telematics Wireless for use in electronic Automatic Vehicle Identification (AVI) systems.

The information included in this manual is organized as follows:

<b>Chapter 1 – Introduction</b>	Presents the manual scope and organization, and describes the FP-300RA reader functions and capabilities.
<b>Chapter 2 – Installation</b>	Provides the information needed to plan the FP-300RA installation, and detailed installation instructions.
<b>Chapter 3 – Operation</b>	Provides information on the FP-300RA operating modes.
<b>Appendix A – Connection Data</b>	Presents the information needed to connect to the FP-300RA.
<b>Appendix B – Maintenance Utility</b>	Presents the functions of the FP-300RA maintenance utility, instructions for its installation on a PC, and covers its utilization for configuration and calibration of FP-300RA units.

For additional information on the FP-300RA technical specifications, its systems integration, help in interfacing to the FP-300RA, and other issues regarding utilization of FP-300RA advanced characteristics, contact Telematics Wireless.

## 1.2 General Description

### 1.2.1 Purpose and Use

The FP-300RA reader offered by Telematics Wireless is a versatile, compact and reliable unit that serves as the roadside component of a vehicle identification system. Figure 1-1 shows a general view of the FP-300RA.

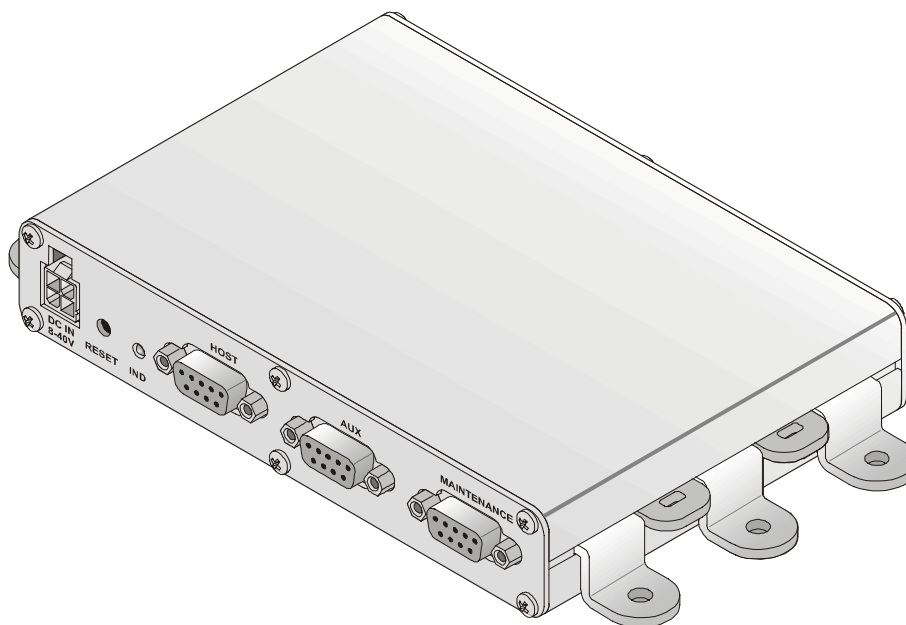

Figure 1-1: FP-300RA, General View

The FP-300RA can automatically identify passing transponders; depending on the system operator's requirements and the specific activities configured by the operator, the FP-300RA can also retrieve information from the transponder, write information to the transponder and instruct it to alert the driver by audio or visual means (beeps, red/yellow/green indicators, etc.). Multiple digital inputs and outputs can be used to read the status of external sensors, and activate various devices. An auxiliary interface can be used as an additional serial communication port to further extend system capabilities and versatility; this port can also be used for synchronizing multiple FP-300RA.

The FP-300RA activities are transmitted on-line to host computers. The FP-300RA communicates with the host computer via a programmable serial interface that provides full control over the FP-300RA operation, and enables collecting extensive vehicle-related data. A local maintenance port can be used to configure and maintain the FP-300RA, independently of the communication with the host computer. These ports also provide control over the digital I/O and auxiliary port.

The FP-300RA can be used in a wide range of applications, for example, electronic toll collection systems, border crossing, access control, Weigh In Motion (WIM) stations, electronic seal systems, vehicle-related services such as parking and gas station payment, and many other applications.

The FP-300RA may be operated from DC sources in the range of 8 to 30 VDC, including batteries. It has low power drain (less than 5 W) and very compact size.

### **1.2.2 Main Technical Characteristics**

The FP-300RA is a complete user-configurable RF and data processing unit that supports two-way communications with in-vehicle transponders (“tags”) using the ASTM V6 Slotted-Aloha Time Division Multiple Access (TDMA) protocol. The physical layer is compatible with ASTM PS111-98.

The FP-300RA communicates with transponders that enter its communication zone at speeds of up to 125 mph (200 kph). The communication uses the 902 to 928 MHz ISM band, with software-configurable synthesized transmit frequency; the data rate is 500 kbps, with ASK modulation. A fixed receiver frequency within the ISM band is used (915 MHz default).

The FP-300RA can use many types of antennas, to match the spatial resolution needed in the desired operation mode (single lane or multilane). It has an integrated antenna-switching unit for multilane sites, supporting up to 4 lanes. The FP-300RA antenna switching rate is configurable; when switching to a lane, the FP-300RA also automatically switches to the RF parameters selected for that lane during the site calibration process.

The high transmit power (software-controllable up to 31.2 dBm) and the high selectivity, high-sensitivity receiver with software-controllable squelch level ensure reliable communication and high performance with minimal external support.

### **1.2.3 Maintenance Utility**

Telematics Wireless offers a dedicated reader maintenance utility for the FP-300RA, that can be installed on any PC running Microsoft® Corp. Windows 2000, Xp. The FP-300RA connects to one of the free serial communication ports of the PC using a null modem cable.

The maintenance utility provides full control over FP-300RA RF and data processing parameters, enables monitoring its operation and updating the FP-300RA software.

### **1.2.4 Additional Equipment Needed**

The only additional accessories that have to be provided are:

Antennas for the specific installation requirements, with the required coaxial cables for connection to the reader.

The number of antennas required and their radiation pattern depend on the application mode:

- Single-lane mode: single transmit/receive antenna.
- Multilane mode: one antenna per active lane, with the option to add one separate transmit antenna.

DC source capable of providing the required supply voltage (8 to 30 VDC) at maximum 5 W.

Means for communicating with the host (serial asynchronous communication link).

### 1.3 Physical Description

Figure 1-2 and Figure 1-3 show the components located on the FP-300RA (see Figure 1 for orientation). The functions of the various components are described in Table 1-1.

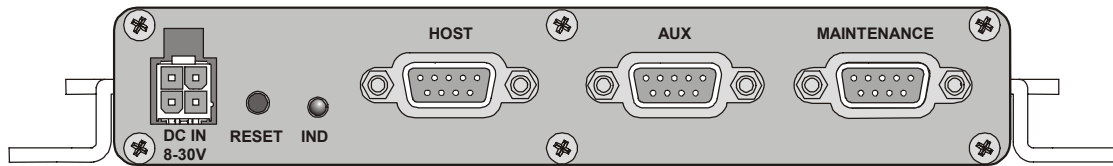

Figure 1-2: FP-300RA, Host Side Panel

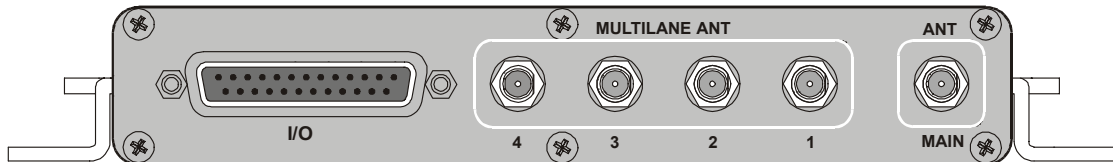

Figure 1-3: FP-300RA, Antenna Side Panel

**Table 1-1: Controls**

Side	Item	Function
<b>Host</b>	DC IN Connector	4-pin connector used to connect the DC input voltage, and enable external resetting by dry-contact closure to ground.
	RESET Push-button	Internal push-button used to initiate cold restart of the FP-300RA.
	IND Indicator	Status indicator, provides the following indications: 1. Flashing in green: normal operation, no tags detected Flashing in orange: normal operation, tags detected Fast flashing in red: mute mode (transmission disabled) Steady red: FP-300RA malfunction detected Alternating off-orange-green sequence: software downloading in progress
	HOST Connector	9-pin D-type female connector includes a serial asynchronous RS-232 DTE interface used for connection to the host computer.
	AUX Connector	9-pin D-type female connector, includes a serial asynchronous RS-232 DTE interface used for connection to auxiliary devices, or as synchronization pulse input or output.
	MAINTENANCE Connector	9-pin D-type female connector, includes a serial asynchronous RS-232 DTE interface used for maintenance.
<b>Antenna</b>	I/O Connector	25-pin D-type female connector, used to connect to the digital I/O interface.
	MULTILANE ANT 1, 2, 3, 4 Connectors	SMA connectors for connection to the secondary antennas.
	MAIN ANT Connector	SMA connector for connection to the main antenna.



## **1.4 Functional Description**

The FP-300RA has two operating modes:

Normal mode

Maintenance mode.

### **1.4.1 Normal Mode**

#### ***1.4.1.1 Normal Mode Functions***

The functions performed by the FP-300RA during operation in the normal mode are as follows:

- Provide communication with transponders passing through its communication zone, using the configured mode (either single lane or multilane)
- Support lane discrimination functionality.
- Maintain a list of the transponders that are currently detected within the FP-300RA communication zone (*active list*)
- Perform preassigned functions (called *auto-functions*) on transponders detected to enter the communication zone (*hot list*)
- Perform various functions on transponders in response to host requests
- Send event and status reports to the host.

#### ***1.4.1.2 Transponder Access Capabilities***

The FP-300RA can access transponders with the following commands:

- Read/write transponder internal or external memory
- Operate transponder driver interface
- Send transponder to sleep mode, with or without driver alert
- Write time stamp into the transponder memory.

#### ***1.4.1.3 Air Interface***

The air interface is based on ASTM V6 protocol. The FP-300RA performs the following tasks:

- Send frame control messages according to the selected mode (open-road or lane-based timing).
- Receive activation messages from transponders.
- Detect and report new transponders that entered the communication zone.
- Send and receive data to/from transponders and report the results to the requesting entity.

**1.4.1.4 Multilane Support**

The FP-300RA has five antenna connectors: one serves for connection to the main antenna, and four additional connectors serve for connection to secondary antennas.

The FP-300RA can transmit and receive using any one of the antenna connectors; the selection of transmit and receive antennas is made every TDMA frame.

Table 1-2 lists the antenna configurations used for single lane and multilane operation.

**Table 1-2: Antenna Configurations**

Operation Mode	Tx Antenna	Rx Antenna
Single lane mode	Main antenna	Main antenna
Multilane mode with one Tx communication zone	Main antenna	Secondary antenna according to multilane setup
Multilane mode with separate lane Tx and Rx communication zones	Secondary antenna according to the multilane setup	Secondary antenna according to the multilane setup

Figure 1-4 shows typical multilane site communication zones.

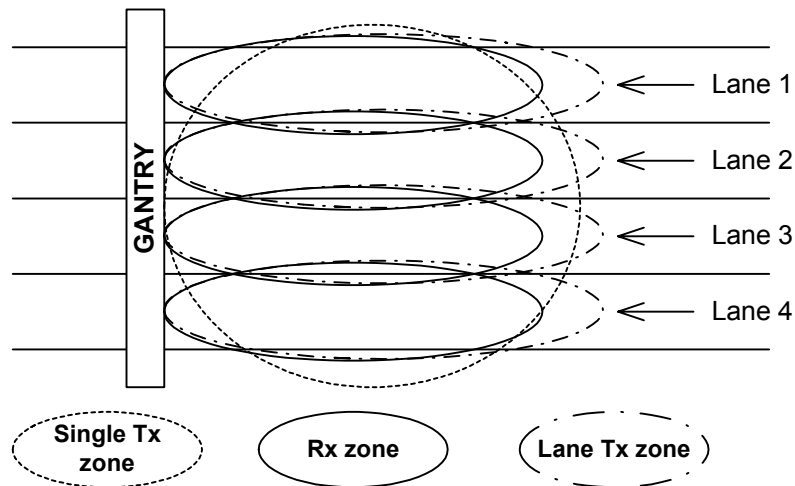

Figure 1-4: Identification of Antenna Used in the Various Operation Modes

The multilane parameters that can be configured include:

- Number of active lanes
- Switching time, i.e., number of frames per lane.

The FP-300RA enables calibrating the communication zone of every lane independently.

#### **1.4.1.5 Lane Discrimination Support**

The FP-300RA lane discrimination function enables detecting on which lane the transponder entered the communication zone.

The lane discrimination parameters that can be configured include:

- Detection of lane in which a transponder enters or leaves the communication zone
- Search window size
- Minimum number of activation messages that must be received
- Minimum delta (difference between the numbers of activation messages received in each lane) needed to identify the lane.

#### **1.4.1.6 Support for Reader Synchronization**

The FP-300RA supports the master-slave synchronization mode:

- When configured as synchronization master, the FP-300RA outputs synchronization pulses via its AUX port, at RS-232/422 levels.
- When configured as slave, the FP-300RA synchronizes its air interface to the synchronization pulses received via its AUX port, at RS-232/422 levels.

While operating in the slave mode, the FP-300RA sends messages reporting loss and regaining of synchronization through the host and maintenance interfaces.

#### **1.4.1.7 Active List**

The FP-300RA maintains a list of transponders that are currently in the FP-300RA communication zone: this list is the active list, and can include up to 100 transponders. The FP-300RA will send the active list to the host upon host's request.

The criteria for adding transponders to the active list are:

- New activation message has been received
- A successful data access is performed with a transponder that is not in the list.

The FP-300RA can check if any transponder is still within its communication zone by self-initiated data access (**ping**). **Ping** reads the transponder internal memory contents. The time between consecutive **pings** can be set by commands, or pinging can be disabled altogether.

The criteria for removing a transponder from the active list are:

The transponder failed to respond to an FP-300RA command (auto-function, **ping** or host request)

If the **ping** function is disabled, then:

- If the transponder has not been accessed, i.e., it is in the out-of-link state, it will be removed after a configurable number of frames from the last received activation message
- If the transponder has been accessed, i.e., it is in the link-granted state, it will be removed 10 seconds after the last access.

#### **1.4.1.8 Hot Lists**

The FP-300RA supports up to 20 hot lists with a total of 1024 transponders:

2. A hot list consists of an automatically-performed function (**auto-function**), a digital output command and a list of transponders.
3. A transponder can be included in only one hot list.
4. Hot list 0 is the default hot list and contains no transponders.

When a transponder enters the communication zone, the FP-300RA checks whether it is a member of a predefined hot list: if positive, the corresponding hot list auto-function and digital output command are performed.

### **1.4.2 Maintenance Mode**

The tasks performed in the maintenance mode are as follows:

- Configuration
- Communication zone calibration
- Self-test.

#### **1.4.2.1 Configuration**

The FP-300RA configurable parameters are divided into two groups:

- Parameters that can be changed only via the maintenance interface
- Parameters that can be changed via either the host or the maintenance interface.

The current configuration is stored in non-volatile memory. When the FP-300RA is restarted, it looks for the last saved configuration and uses it.

If no valid configuration is found, the FP-300RA sets the configuration parameters to their default values. The configurable parameters are explained in Appendix C.

#### **1.4.2.2 Communication Zone Calibration**

The FP-300RA has built-in transmit power and digital squelch control. The FP-300RA stores the transmit power and digital squelch settings for every active lane and use it when switching between lanes. The calibration procedure (explained in Appendix E), enables setting every lane's communication zone.

#### **1.4.2.3 Self-Test**

The FP-300RA supports two types of tests, destructive and non-destructive. Non-destructive test enables the FP-300RA to continue operating in normal mode, whereas the destructive test terminates the normal mode.

### **1.4.3 Host Communication**

The FP-300RA supports communication with a host. Two types of messages are used:

- FP-300RA-initiated message used to report events, e.g., a new transponder
- Messages sent in response to host requests.

The message set is presented in Appendix D.

### **1.4.4 Real-Time Clock**

The FP-300RA has an internal real time clock (RTC) with a resolution of 10 millisecond. Whenever the FP-300RA is restarted, the RTC starts running from an initial value of 00:00 January 1, 2000. Therefore, the host must make the translation to “normal” time.

The FP-300RA RTC can be set via the host and/or maintenance interface.

# Chapter 2: Installation

## 2.1 General

This Chapter provides the information needed to install FP-300RA readers.

The information presented in this Chapter is organized as follows:

- Installation requirements – Section 2.2.
- Installation guidelines – Section 2.3.
- Installation procedures – Section 2.4.

Before starting the installation procedures, make sure to review the **Safety Information** section at the beginning of this manual.

## 2.2 Installation Requirements

### 2.2.1 Integration in Systems

Figure 2-1 shows the connections needed to integrate an FP-300RA unit in a typical electronic vehicle identification system. Use the information appearing in Chapter 1 and Appendix A, that covers the FP-300RA interface characteristics and connection data, to prepare cables in accordance with the specific requirements of each location.

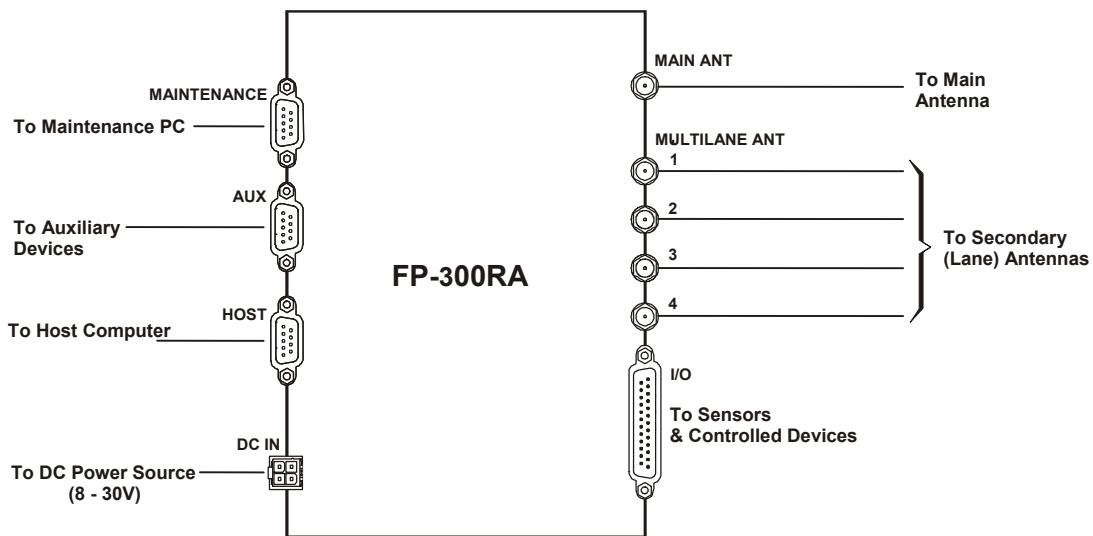

Figure 2-1: FP-300RA Connections

### 2.2.2 Safety Considerations

In addition to the electrical connections shown in Figura 2-1, the FP-300RA case must be connected to protective grounding.

Protective devices, complying with the applicable international standards and the national and local regulations, must be used on all the lines connected to the FP-300RA, to protect against lightning discharges and accidental contact with high-voltage lines.



**Warning**

**The FP-300RA must be properly grounded whenever cables are connected to its connectors. To ground the FP-300RA, attach its case to a high-quality, low resistance protective grounding system, in a way that ensures good electrical contact.**

### 2.2.3 Mechanical Data

Figure 2-2 provides mechanical data for planning the installation of an FP-300RA unit.

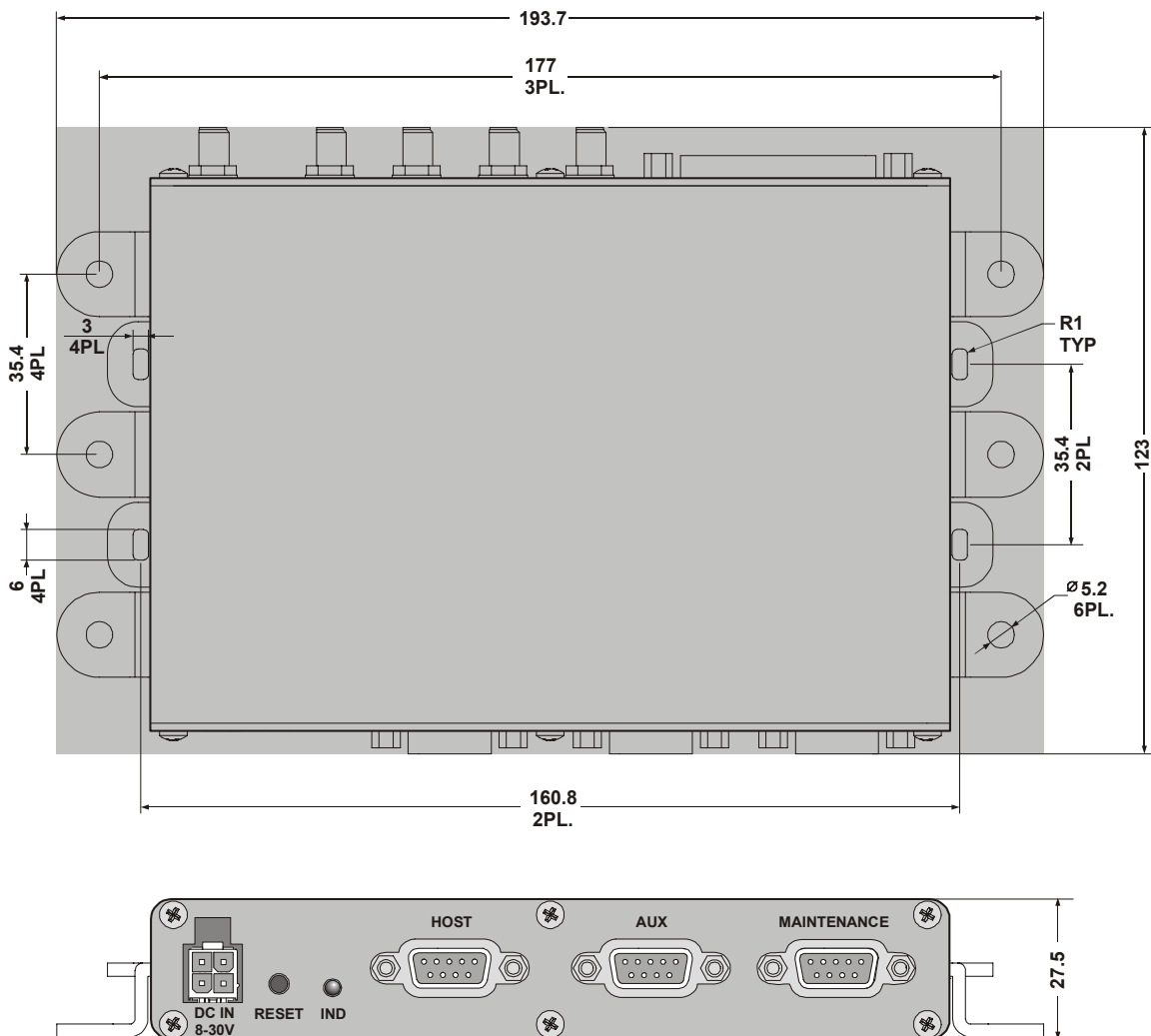

Figure 2-2: FP-300RA Mechanical Data

## 2.3 Installation Guidelines

The FP-300RA is intended for installation in protected cabinets that prevent direct exposure to sun radiation, rain, dust and dirt. It does not require forced air cooling.

The following sections provide additional information needed for successful utilization of the FP-300RA.

### 2.3.1 Power Requirements

The FP-300RA operates on 8 to 30 VDC, and its maximum power drain is 5W. A suitable power source must be provided as part of the installation.

Separate power supply lines should be routed to each FP-300RA unit.

The FP-300RA does not have an ON/OFF power switch, and will start operating as soon as power is connected. Therefore, it is recommended to install a circuit breaker, which will also serve as an ON/OFF switch, to protect the supply line of each FP-300RA.

### 2.3.2 Antennas

The type of antenna to be used with the FP-300RA is generally determined by the FP-300RA application and communication zone requirements.

In most installations, two types of antenna are used:

- For wide communication zone applications, a wide beam antenna is recommended. The antenna can be mounted above the lane or beside the road.
- For narrow communication zones, where lane-to-lane and/or cross-lane discrimination is required, a narrow beam antenna can be used. This antenna must be mounted over the center of the lane.

For either type of antenna, the positioning of the antenna must be carefully set to achieve the required communication zone pattern. For installations subject to external interference, lower gain antennas can be used.

Contact Telematics Wireless if you need help in selecting suitable antennas.

---

**Note:** *The antenna (ANT) connectors of the FP-300RA must always be terminated in matched (50Ω) loads. Connect 50Ω loads with minimal rating of 1W to any FP-300RA ANT connector not connected to an antenna.*

*When the installation procedures call for connecting RF cables to the FP-300RA antenna connectors before the corresponding antennas are installed, connect the loads at the antenna ends of the cables.*

---



### **2.3.2.1 Antenna Mounting Position Requirements**

FP-300RA antennas are mounted in accordance with the application requirements and antenna manufacturer's instructions. Consider the following position requirements:

- **Height:** for above-the-lane installation, the antennas can be mounted on a gantry, overpass, or other above-the-lane facility. Each antenna must be mounted at a sufficient height to meet local vertical clearance requirements.

Any antenna can be damaged and/or misaligned if struck. If snow buildup on vehicles is possible, mounting height must include clearance for snow buildup for the highest anticipated vehicle using the lane(s).

- **Multilane applications:** each antenna should be mounted over the center of its lane. For lane discrimination, antennas should be mounted over the center of the highway or group of lanes to be included in the FP-300RA communication zone.
- **Beside-the-road installation:** the antenna(s) can be pole mounted.

Antennas must be mechanically positioned to provide the appropriate beam orientation for the communication zone wanted. Suitable arrangements must be provided to permit mechanical adjustment of antenna direction, to achieve the beam pattern and communication zone wanted.

### **2.3.2.2 FP-300RA-to-Antenna Cabling**

The maximum distance between the FP-300RA and its antenna is limited by cable signal loss. Generally, the total signal loss between the antenna and the FP-300RA must be less than 3 dB. Any losses on antenna patch panels or switching matrices must also be taken into consideration.

For installations where the FP-300RA-to-antenna cable length is less than 125 feet (38 meters), you may use Times LMR 600/400, Andrew type LD F4-50A 1/2-inch Heliax, or other cables with similar or better characteristics.

Cable routes should be carefully planned, to ensure they follow the shortest path yet are far from sources of strong electrical interference such as electrical motors, air conditioning equipment, two-way radios, etc. Make sure that cables are physically protected, for example, by routing them within cable ducts: sharp bends, distortion of the cable outer shield, etc., may increase the attenuation by an unpredictable amount.

### **2.3.3 Communication Cables**

The cables connecting the FP-300RA communication ports (auxiliary, maintenance and in particular the connection to the host computer) must be shielded. Communication-grade cables consisting of twisted pairs with external shield should be used, and the shield must be grounded at one end.

Cables should be run through grounded conduits, to minimize external interference.

### **2.3.4 Grounding and Lightning Protection Requirements**

All the FP-300RAs, antennas, mounting poles, cabinets, cable conduits and cables must be properly grounded in accordance with the applicable regulations, to prevent injury to personnel or damage to equipment from lightning or other high voltage sources.

Ground bonding points must be free of paint and corrosion. Star washers should be placed on screws to ensure good electrical contact.

For installations where a complete bonded ground connection is not possible for the entire antenna-to-FP-300RA cabling, a separate lightning arrester must be installed for each antenna cable at a point near the RF connection to the FP-300RA cabinet.

## **2.4 Installation Procedure**

### **2.4.1 Tools and Materials**

No special tools and materials are required for FP-300RA installation.

### **2.4.2 Preparation for Installation**

Refer to the site installation plan, and make sure all the required components, cables, and accessories are available.

Identify the prescribed physical location of each system component, and find the grounding points.

Before installing any item (FP-300RA, cabinet, mounting accessory, antenna, cable conduit, etc.), thoroughly clean the surface on which it will be mounted.

### **2.4.3 FP-300RA Installation Procedure**

#### **2.4.3.1 *Physical Installation***

Use the following general procedure to install the FP-300RA in the prescribed location:

1. Identify the exact location and position of the FP-300RA.
2. Mark the 6 holes to be drilled in accordance with the information appearing in Figure 2-2, and then drill using an appropriate drill tip.
3. Thoroughly clean the surface on which the FP-300RA will be mounted. Make sure to remove any burrs.
4. Insert a flat washer and a star washer on each of the 6 fastening screws. Prepare additional flat washers and star washers for insertion under the nuts.
5. Place the FP-300RA on the mounting position, and fasten it with the 6 screws and nuts.

### 2.4.3.2 Cable Connections

**Caution**

---

The FP-300RA does not have an ON/OFF power switch, and will start operating as soon as power is connected. Make sure that no power is supplied until authorization to start operations is received.

---

1. Identify the cables to be connected to the FP-300RA in accordance with the site installation plan.
2. Visually inspect the connectors for any signs of damage: do not attempt to connect if shell or pins are bent. Thoroughly clean using a soft, clean brush to remove dirt and foreign matter.
3. Route each cable to the prescribed connector and mate the connectors. For each D-type connector, secure the connection by tightening the two screws; use a wrench to tighten RF connectors. Do not exert excessive force.
4. Four cable tying points are provided around the FP-300RA: use cable ties to secure the cables. To prevent stress caused by bending, make sure to leave enough slack.

### 2.4.3.3 Final Inspection

1. Visually inspect the installation for proper execution, good workmanship and compliance with the applicable practices and regulations.
2. Check cable connections, and check their routes. Make sure that cables are securely routed and fastened.
3. Inspect the installation of the other system components in accordance with the applicable instructions.
4. Correct any problems detected during the inspection.
5. After the inspection is successfully completed, refer to Chapter 3 to continue with the preliminary configuration.



**Warning**

---

**Do not apply power to the FP-300RA before explicit authorization is received from the person in charge. The FP-300RA may start transmitting as soon as power is applied, resulting in possible exposure of personnel working near the antennas to microwave radiation.**

**The FP-300RA must not be allowed to transmit without being connected to an antenna, or to other matched (50Ω) load.**

---

# Chapter 3: Operation

## 3.1 Scope

This Chapter provides the information needed to prepare a new FP-300RA for operation in your system, using the FP-300RA maintenance utility provided by Telematics Wireless. The information appearing in this Chapter is organized as follows (this is also the recommended order of execution):

- Power-up instructions – see Section 3.2.
- FP-300RA configuration – see Section 3.3.
- Preparing hot lists – see Section 3.4.
- Calibration of communication zone – see Section 3.5.
- Software and firmware downloading – see Section 3.6.

The information appearing in this Chapter assumes that you are familiar with the FP-300RA maintenance utility. If necessary, refer to Appendix B for information on this utility.

## 3.2 Power-Up

Before performing the other activities described in this Chapter, power up the FP-300RA and connect it to the PC running the maintenance utility.



### **Warning**

---

**Do not apply power to the FP-300RA before explicit authorization is received from the person in charge. The FP-300RA may start transmitting as soon as power is applied, resulting in possible exposure of personnel working near the antennas to microwave radiation.**

**The FP-300RA must not be allowed to transmit without being connected to antenna, or to a suitable (50Ω) load.**

**To avoid transmitting when personnel works near the antennas and/or when no antennas are connected, for example, during preparations for first time-operation and during maintenance, connect 50Ω, 1W loads to the FP-300RA antenna connectors. Do not disconnect the loads as long as the FP-300RA is powered.**

---

### □ **To apply power to the FP-300RA:**

1. Check that power may be applied to the FP-300RA.
2. Apply power and monitor the FP-300RA IND indicator: it should start flashing in green.

- 
- Notes:**
- Orange flashing indicates that transponders have been detected within the communication zone of the FP-300RA. This is possible only when the FP-300RA is connected to antennas.
  - Fast red flashing indicates that transmission has been disabled (muted). This is a normal indication. However, steady red means that a malfunction has been detected: press the RESET push-button of the FP-300RA and check that the problem disappears after the FP-300RA restarts. If the indicator lights steadily in red, service is required.
- 

□ **To connect the FP-300RA to the maintenance PC:**

1. Identify the serial COM port of the PC that is configured for communication with the FP-300RA (if necessary, see details in Appendix B).
2. Connect a 9-pin/9-pin null modem cable between the COM port of the PC and the MAINTENANCE connector of the FP-300RA.
3. Start the maintenance utility.
4. After the PC establishes communication with the FP-300RA, the monitoring window of the maintenance utility should show the information retrieved from the FP-300RA.

*At this stage, you may continue to the other preparation and configuration activities.*

### 3.3 FP-300RA Configuration

Before starting, obtain the list of prescribed parameters for the FP-300RA being installed from the person in charge.

Start the configuration procedure by clicking the **Setting – Config** button of the main window of the maintenance utility to display the RVCC Configuration window.

Make sure that the FP-300RA configuration is set to the default parameters. You can click the **Return to Factory Default** button (the FP-300RA will restore the default values and reboot itself).

#### 3.3.1 Setting Host Interface Parameters

Set the host interface baud rate and word format, and then click **Set**.

#### 3.3.2 Setting Initial Tx Mode

Setting the initial Tx mode to **Mute** enables a slow host to boot before receiving messages from the FP-300RA.

When using the **Mute** initial Tx mode, the host must change the FP-300RA mode to **Normal**.

### 3.3.3 Setting TDMA Mode

The TDMA mode enables:

- Set TDMA frame type to either *Open Road* (default) or *Lane Based*.
- *Internal Act, External Act*: Enable/disable internal/external activation messages from transponders.
- *“F” EH*: Set the extended header type: “1111...” or “10101...” (default).
- *Sleep Time*: Set the sleep interval used when commanding a transponder to “sleep”.

### 3.3.4 Setting Transponder Access Parameters

The transponder access parameters are as follows:

- *Net Re-entry Delay*: Set the time transponder activation messages are ignored after transponder sleep command.
- *Max Access Retries*: Set the number of times the FP-300RA tries to access a transponder before it is declared lost.
- *Ping Function, Ping rate*: Enable/disable the ping function and set the ping rate.
- *Tag Lost Timeout*: Set the number of frames in which transponder activation messages have not been detected before a transponder declared lost. If the transponder was previously accessed (either by ping, auto-function or a host request), then the tag will be declared lost 10 seconds after the last access.

### 3.3.5 Setting Burst Mode

The primary use of the burst mode is during communication zone calibration. When the burst mode is enabled, the FP-300RA will be in the normal Tx mode for the number of frames selected by *Frames ON* and will then enter the mute Tx mode for the number of frames selected by *Frames OFF*. To make sure that all the transponders will lose synchronization to the FP-300RA, set *Frames OFF* to more than 15.

### 3.3.6 Setting SYNC Mode

The PF300RA SYNC mode can be set to *None, Master* or *Slave*, by click the corresponding radio button. The default SYNC pulse timing values are set according to field tests.

If required, the SYNC pulse timing can be adjusted as explained below.

- *SYNC Slave Mode*: in this mode, you can adjust the delay between the falling edge of the SYNC pulse and the start of a new frame, designated *SYNC to FCM*, can be adjusted in the range of  $800 \pm 15 \mu\text{sec}$ .

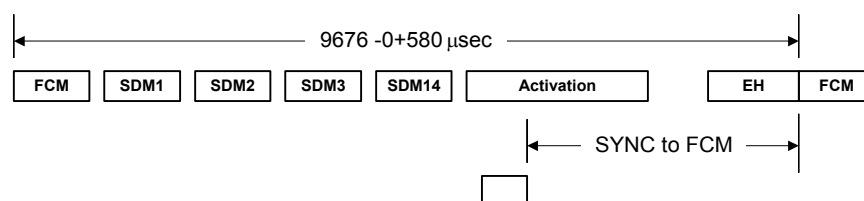

- **SYNC Master Mode:** in this mode, the SYNC pulse duration and timing can be adjusted.

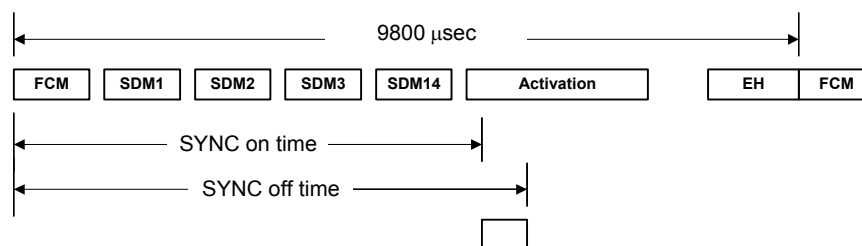

If the Master reader is in burst mode then it will send the SYNC pulse while it in OFF state and block the SYNC pulse while in ON state.

### 3.3.7 Setting Multilane Mode

The FP-300RA can support up to 4 lanes. The default setting is single lane using the MAIN antenna connector for Tx and Rx. The multilane setting enables:

- Set multilane mode using the MAIN antenna for Tx and MULTILANE antennas for Rx
- Set multilane mode using MULTILANE antennas for Tx and Rx.

The multilane parameters are:

- **Lane:** Number of active lanes (1 to 4).
- **Lane Switch:** Number of frames the FP-300RA will use an antenna before switching to the next antenna.

### 3.3.8 Setting Lane Discrimination

The lane discrimination function enables to determine the lane in which the transponder has been detected. The lane discrimination can be made in two ways:

- Try to determine the lane when the transponder enters the communication zone
- Try to determine the lane when the transponder leaves the communication zone.
- Try to determine the lane as soon as possible or when the transponder leaves the communication zone.

The lane discrimination parameters are:

- **Window:** the number of frames, counted from the first detection of a transponder, in which the FP-300RA tries to determine the lane. This parameter is ignored if lane discrimination is made when the transponder leaves the communication zone.
- **Min. Act. Msg:** minimum number of activation message, required for reliable lane determination.
- **Min. Delta:** minimum difference in the number of activation messages received from each lane that is required for reliable lane determination.

### 3.3.9 Setting Digital I/O

The digital I/O setting enables:

- Set the digital output setting when the FP-300RA is powered up
- Set the input sense function by:
  - Selecting the required input, *Sense mask*.
  - Set the polarity for each selected input, *Sense polarity*.

### 3.3.10 Save Current Settings

After completing the FP-300RA configuration, click the *Save current setting* button. The FP-300RA will save the settings and reboot.

## 3.4 Hot List Configuration

The hot list function enables the FP-300RA to activate a predefined transponder access function when a transponder enters the FP-300RA communication zone. To configure the hot list, click the *Setting – Hot Lists* button of the main window of the maintenance utility to display the **Hot List Control** window.

### 3.4.1 Get Hot List Status

- Click the *Get Hot Lists* to get the list of currently-defined hot lists
- Select the desired hot list in the *HL ID – AF ID* window to view the hot list members and the predefined auto-function.

### 3.4.2 Remove Hot List

- Select the desired hot list in the *HL ID – AF ID* window, or type the hot list ID in the *Selected HL* field.
- Click the *Clear hot list(s)* button. If the selected hot list is 255, default hot list, then all the hot lists will be removed, and the auto-function of the hot list 255 (default hot list), will be set to *No Auto Function*.

### 3.4.3 Add New Hot List

A new hot list is added by setting its auto function, or by adding a transponder.



#### 3.4.4 Set Hot List Auto Function

- Select the desired hot list in the **HL ID – AF ID** window, or type the hot list ID in the **Selected HL** field.
- Select the auto-function type and its parameters in the **Auto Function** area.
- Select the digital output setting in the **Auto Function** area.
- Click the **Set Auto Function** button.
  - If the hot list is already defined, then its auto-function is replaced.
  - If not, then a new hot list is defined.

#### 3.4.5 Add Transponder to Hot List

- Select the desired hot list in the **HL ID – AF ID** window, or type the hot list ID in the **Selected HL** field.
- Enter the transponder ID in the **Selected Tag ID**.
- Click **Add TAG** button:
  - If the transponder is already a member of the specified hot list, the FP-300RA will reject the command (reject code 07)
  - If the transponder is already a member of the another hot list, the FP-300RA will change the transponder hot list
  - If the hot list is not defined, then a new hot list is defined.

#### 3.4.6 Remove Transponder from Hot List

- Select the transponder in the **Members** window or enter the transponder ID in the **Selected Tag ID**.
- Click the **Rem TAG** button. If the transponder is not in the specified hot list, the FP-300RA will reject the command (reject code 0A).

#### 3.4.7 Saving the Hot List

Click the **Set Hot list** button to make the current hot lists setting the FP-300RA default hot list.

# Appendix A: Connection Data

## A-1 Antenna Connectors

The FP-300RA has five SMA female antenna connectors, one designated MAIN and four additional connectors designated MULTILANE 1, 2, 3 and 4.

The antenna functions depend on the selected operation mode (single lane, multiple lanes with single transmit zone or multiple lanes with separate lane zones).

## A-2 Power Input Connector

The FP-300RA has one 4-pin connector, designated DC IN, used to connect the DC input voltage, and to enable external resetting by dry-contact closure to ground. Table A-1 lists the pin functions.

*Table A-1: DC IN Connector, Pin Functions*

Pin	Function
1	Input voltage
2	Ground
3	External reset (active low, with internal pull-up)
4	Ground

## A-3 Digital Interface Connector

The digital interface connector is a 25-pin D-type female connector, designated I/O. The connector is used to connect to the FP-300RA digital interface, which includes 8 inputs and 7 outputs, all referenced to ground. Table A-2 lists the connector pin functions.

*Table A-2: I/O Connector, Pin Functions*

Pin	Designation	Pin	Designation	Pin	Designation
1	IN1	15	IN4	21	OUT4
2	IN3	16	IN6	22	OUT5
3	IN5	17	IN8	23	OUT6
4	IN7	18	OUT1	24	OUT7
5 to 13	GND	19	OUT2	25	GND
14	IN2	20	OUT3		

## A-4 Host Interface Connector

The host interface connector is 9-pin D-type female connector designated HOST. Its communication parameters are configured by means of the MAINTENANCE interface.

The connector includes a serial asynchronous DTE interface used for connection to the host computer. Two interfaces can be selected:

- RS-232 interface: Table A-3 lists the connector pin functions for this mode.
- RS-422 interface: Table A-4 lists the connector pin functions for this mode.

**Table A-3: HOST Connector, Pin Functions for RS-232 Interface**

Pin	Designation	Function
1	N.C.	Not connected
2	TxD	Transmit data output
3	RxD	Receive data input
4	N.C.	Not connected
5	GND	Signal ground
6	N.C.	Not connected
7	CTS	Clear to send input
8	RTS	Request to send output
9	N.C.	Not connected

**Table A-4: HOST Connector, Pin Functions for RS-422 Interface**

Pin	Designation	Function
1	RxD-	Receive data input (-)
2	TxD+	Transmit data output (+)
3	RxD+	Receive data input (+)
4	TxD-	Transmit data output (-)
5	GND	Signal ground
6	RTS-	Request to send output (-)
7	CTS+	Clear to send input (+)
8	RTS+	Request to send output (+)
9	CTS-	Clear to send input (-)

## A-5 Maintenance Interface Connector

The maintenance interface connector is 9-pin D-type female connector designated MAINTENANCE. The connector includes the serial asynchronous RS-232 DTE interface used for connection to a PC running the maintenance utility. Its communication parameters are 9600 bps, 1 start bit, 8 data bits, no parity, one stop bit. Table A-5 lists the connector pin functions.

**Table A-5: MAINTENANCE Connector, Pin Functions**

Pin	Designation	Function
1	N.C.	Not connected
2	TxD	Transmit data output
3	RxD	Receive data input
4	N.C.	Not connected
5	GND	Signal ground
6	N.C.	Not connected
7	RTS	Request to send output
8	CTS	Clear to send input
9	N.C.	Not connected

## A-6 Auxiliary Interface Connector

The auxiliary interface connector is 9-pin D-type female connector designated AUX. The connector includes a serial asynchronous RS-232 DTE interface used for connection to auxiliary devices, or for synchronization pulses. Its communication parameters are configured by means of the MAINTENANCE interface.

- RS-232 interface: A-6 lists the connector pin functions for this mode.
- RS-422 interface: A-4 lists the connector pin functions for this mode.

**Table A-6: AUX Connector, Pin Functions for RS-232 Interface**

Pin	Designation	Function
1	N.C.	Not connected
2	TxD	Transmit data output or SYNC pulse output
3	RxD	Receive data input or SYNC pulse input
4	N.C.	Not connected
5	GND	Signal ground
6	N.C.	Not connected
7	CTS	Request to send output
8	RTS	Clear to send input
9	N.C.	Not connected

**Table A-7: AUX Connector, Pin Functions for RS-422 Interface**

<b>Pin</b>	<b>Designation</b>	<b>Function</b>
1	RxD-	Receive data input (-)
2	TxD+	Transmit data output (+)
3	RxD+	Receive data input (+)
4	TxD-	Transmit data output (-)
5	GND	Signal ground
6	RTS-	Request to send output (-)
7	CTS+	Clear to send input (+)
8	RTS+	Request to send output (+)
9	CTS-	Clear to send input (-)

# Appendix B: Maintenance Utility

## B-1. Scope

This Appendix provides installation and general operating instructions for the FP-300RA maintenance utility, version 1.0.

The FP-300RA maintenance utility runs under Microsoft Windows™ 2000, and uses the standard Windows user interface. The utility is provided on a standard CD.

The information presented in this Appendix assumes that the user is familiar with the use of Windows applications. If additional information is necessary, refer to the Windows™ 2000 User's Reference Manual, available from Microsoft Corp.

## B-2. Installation

### B-2.1 Hardware and Software Requirements

The PC used to run the maintenance utility must have Windows 2000 already installed and running before starting the installation of the utility.

Make sure the PC has a free serial communication (COM) port for communication with the FP-300RA.

### B-2.2 Installation Procedure

- Copy the files provided on the CD to the desired folder.
- Prepare a shortcut to the utility .EXE file on the desktop.

### B-2.3 Preliminary Configuration

- Start the utility, e.g., by clicking the desktop shortcut.
- You will see a dialog box that prompts you to select the serial communication (COM) port that will be used for communication with the FP-300RA.
- Select the desired port, e.g., COM1, on the **Com** option menu, and then click the **OK** button to confirm and close the dialog box.

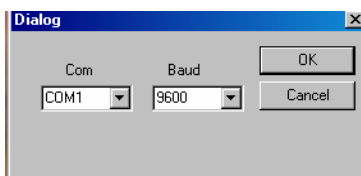

Figure B-1. COM Port Selection Box

You will see the main window.

### B-3. Main Window

Figure B-2 shows a typical main window, as seen after the PC is connected to an operational FP-300RA. The window has a menu bar with two items: **File** and **Help**. The following sections explain the various areas of the window.

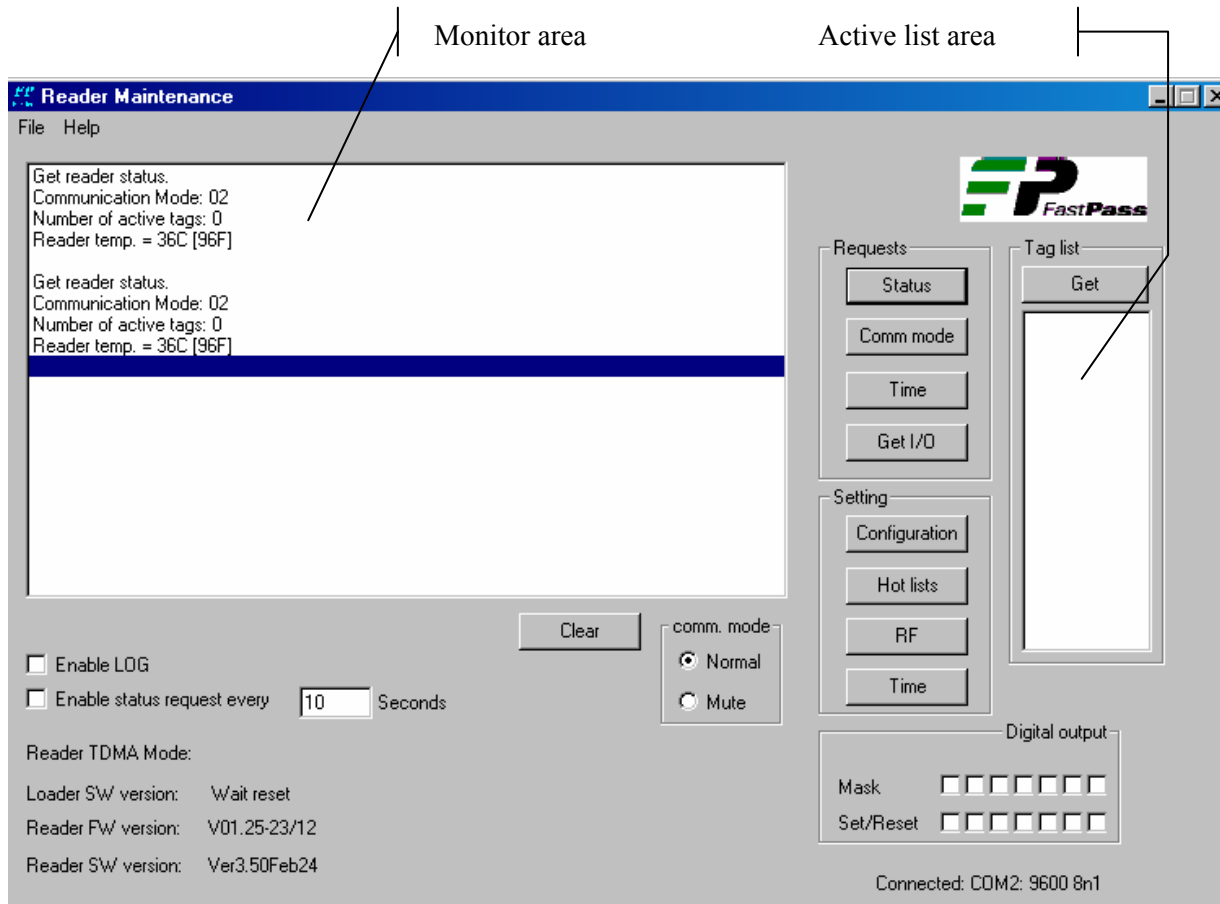

Figure B-2 Typical Main Window

#### B-3.1 Monitor Area

The monitor area displays the request/command messages sent to the FP-300RA and its response.

#### B-3.2 Active List Area

The active list area displays the transponders that are currently in the FP-300RA communication zone. The active list is stored in the FP-300RA and can be read by clicking the **Get** button in the **Tag List** area.

### **B-3.3 Log File**

The information displayed in the monitor area can be recorded in a log file by checking the **Enable Log** box.

The log file is saved in the current directory. The file name is FP-300RA, followed by file opening date and time. The current log file will be closed and a new one will be opened according to the parameters defined by means of the **Log Control** window.

### **B-3.4 Sending Periodic Status Request**

The maintenance utility can be configured to automatically send status requests by checking the **Enable Status Request Every** box, and then entering the desired interval, in seconds, in the adjacent field.

### **B-3.5 Setting the Communication Mode**

The radio buttons in the **Comm Mode** are used to select the FP-300RA communication mode:

- **Normal** – normal operation.
- **Mute** – transmission disabled. For your safety, before replacing an antenna, the FP-300RA must be turned off or set to **Mute**.

### **B-3.6 Setting/Resetting the Digital Output Port**

The maintenance utility can set or reset any one of the seven FP-300RA digital outputs by setting the required bit mask in the **Digital Output** are:

- To set a bit (“1”), check the bit box.
- To reset a bit (“0”), uncheck the bit box.

### **B-3.7 Information Fields**

The main window contains the following information fields:

- **Connected**: displays the configured COM port, its data rate and the word format (data bits – parity – stop bits).
- **Reader TDMA mode**
- **FP-300RA loader software version** (updated after cold reset)
- **FP-300RA firmware version** (updated by self-test result)
- **FP-300RA application software version** (updated by self-test result).



### **B-3.8 Requests Area**

The user can click buttons in the **Requests** area to cause the maintenance utility to send the following request for information to the FP-300RA:

- Status
- Current FP-300RA communication mode
- FP-300RA current time
- Digital I/O settings.

The FP-300RA response is displayed in the monitor window and, if applicable, updates the main window information field.

### **B-3.9 Setting Area**

The buttons in the **Setting** area are used to configure the following FP-300RA parameters:

- Configuration (system parameters)
- Hot list parameters
- RF parameters
- Set FP-300RA time.

Each button, except **Time**, opens a control window. The **Time** setting uses the PC time.

## B-4. File Menu

Figure B-3 shows the **File** menu of the maintenance utility.



Figure B-3: File Menu Structure

The functions of the items included on the **File** menu are as follows:

<b>Config COM</b>	Configure the PC COM port to be connected to the FP-300RA.
<b>Reset Reader</b>	Send a reset command to the FP-300RA.
<b>Self Test</b>	Send a self-test command to the FP-300RA.
<b>Upgrade</b>	Start FP-300RA software/firmware upgrade process.
<b>Msg monitor</b>	Display the command/response messages details.
<b>Log control</b>	Enable selecting the maximum number of lines in the log file, or the maximum time the log file remains open, even when the specified number of lines has not yet been reached. In either case, the current log file is closed and anew one is opened.
<b>Exit</b>	End the FP-300RA maintenance utility.

### B-5. FP-300RA Configuration Window

The **FP-300RA Configuration** window, shown in Figure B-4, is used to select the system configuration parameters. In most cases, the configuration change is made when the focus is moved from the changed parameter's field.

For a description of the system parameters and their range of values, refer to the *FP-300RA Configuration Table* section in Appendix C.

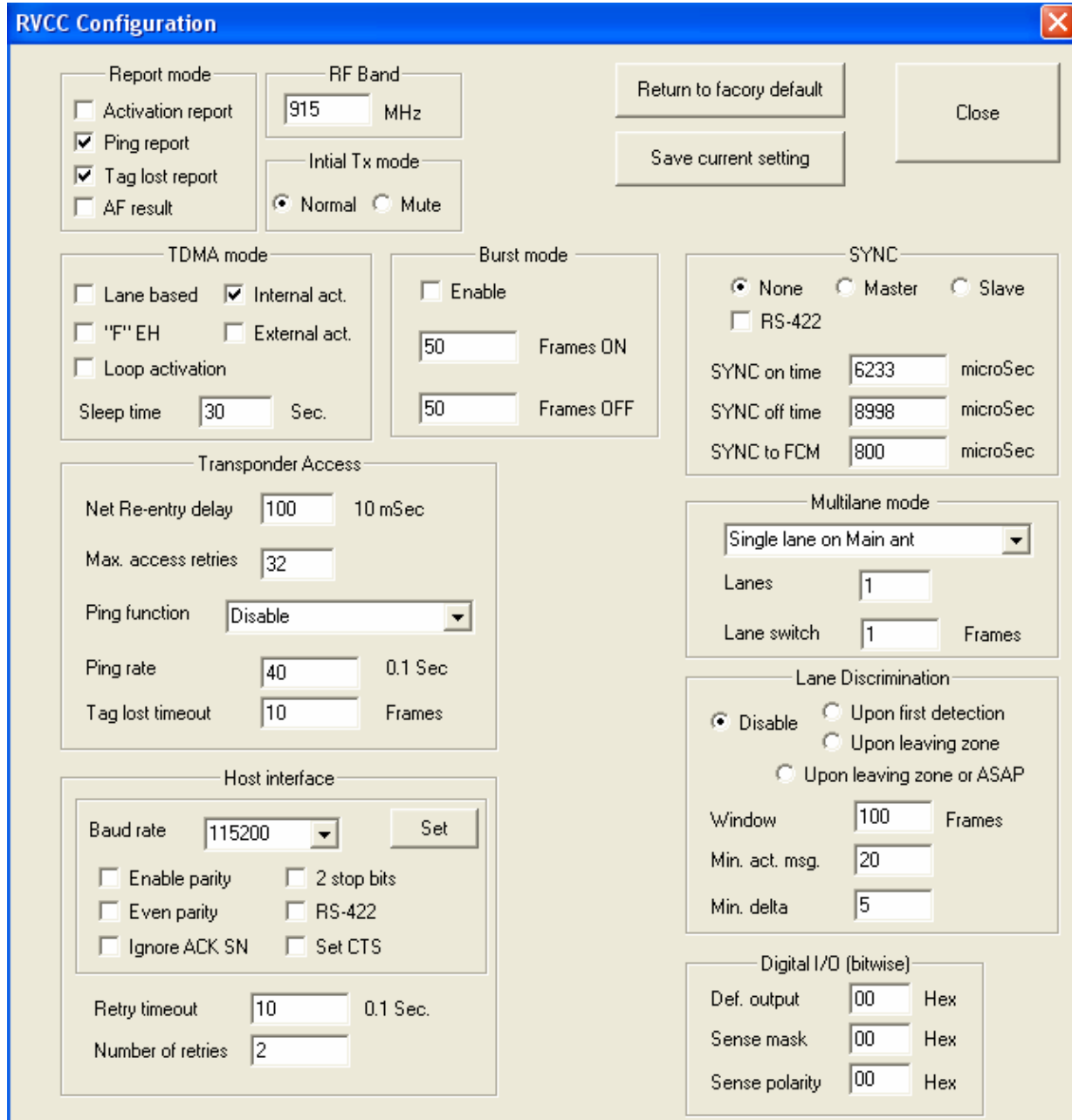

Figure B-4: Typical FP-300RA Configuration Window

## B-6. Hot List

The hot list functionality is described in Chapter 3. A typical **Hot List Control** window is shown in Figure B-5

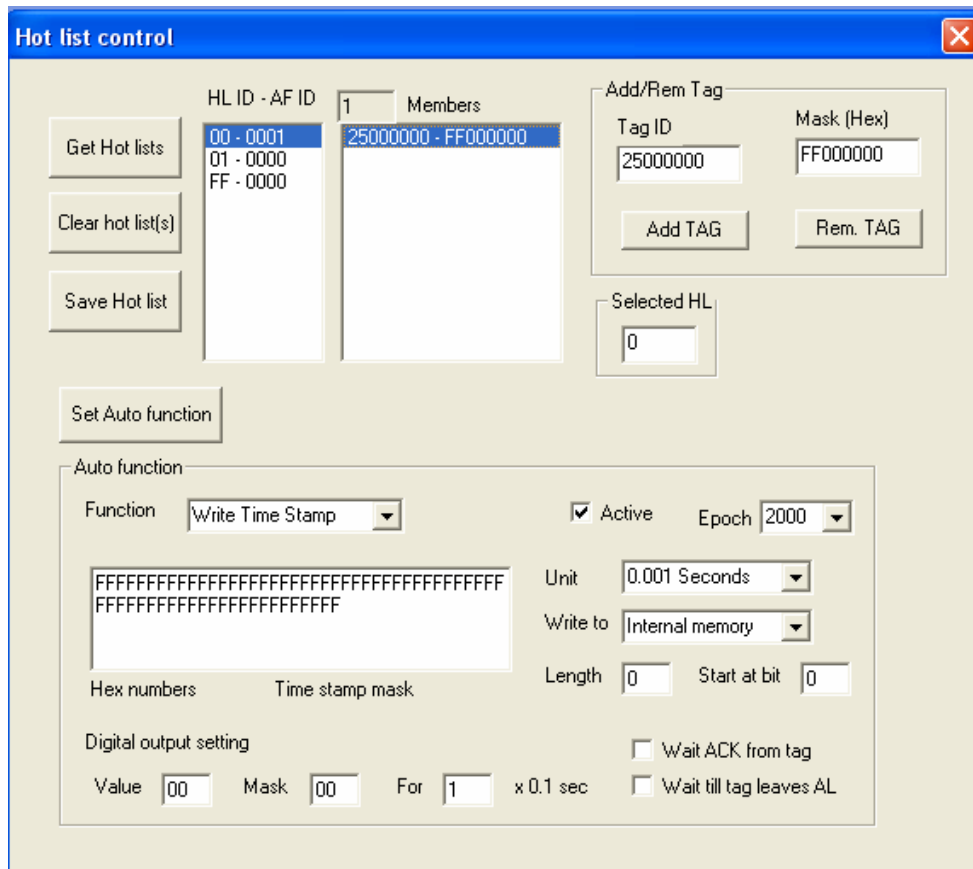

Figure B-5: Typical Hot List Control Window

The window includes the following buttons:

- Get Hot Lists**      Get currently set hot lists.
- Clear hot list(s)**      Clear the selected hot list. Select 0 to clear all the hot lists.
- Save HL**      Save the current hot list setting as default setting.
- Load HL from file**      Load the hot list settings from a script file.
- Add TAG**      Add a selected transponder with Mask to a selected hot list.
- Rem. TAG**      Remove a transponder with Mask from a hot list.
- Set Auto function**      Set the auto-function for the selected hot list.

### B-6.1 Auto-Function

The auto-function is selected from the **Function** list. When a function is selected, the relevant data field will be opened.

The **Digital output setting** is not applicable and the mask field should be 0.

## B-7. RF Setting Window

Figure B-6 shows a typical **RF Setting** window.

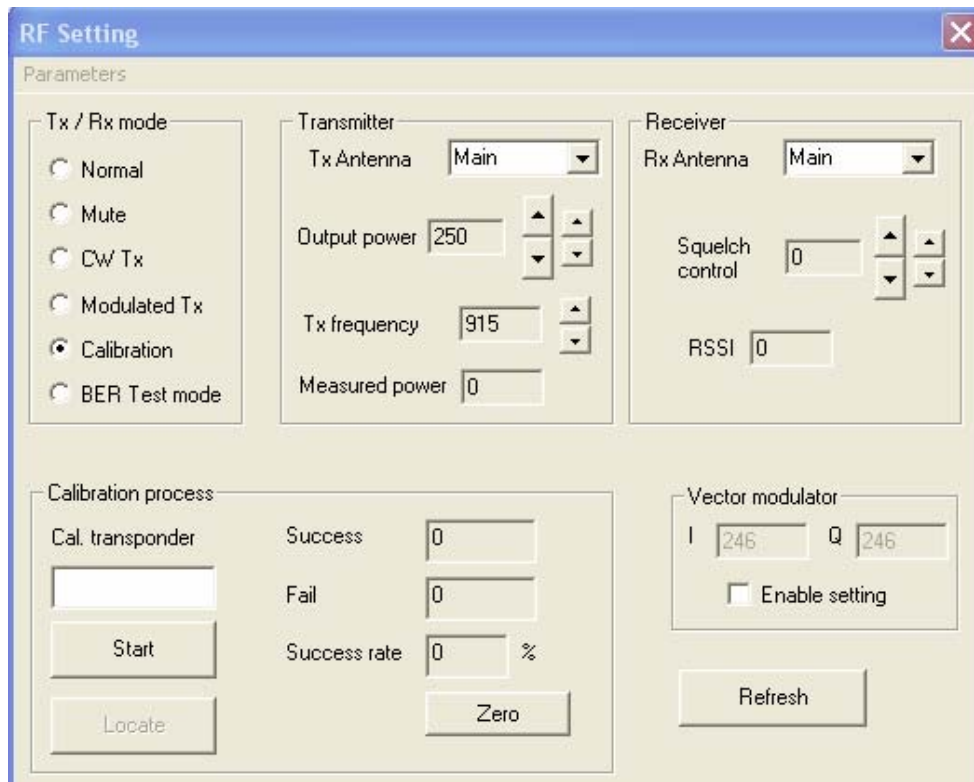

Figure B-6: Typical RF Setting Window

### B-7.1 Get Button

Its function is to get the current RF parameters. When using the CW or modulated mode, the actual transmit output power is measured and reported.

### B-7.2 Set Default Button

Its function is to set the current RF parameters as the FP-300RA default RF parameters.

### B-7.3 Tx Mode

Selects the transmitter operating mode:

<b>Normal</b>	The TDMA air interface is active according to the current configuration.
<b>Mute</b>	The TDMA air interface is inactive (no transmission, no reception).
<b>CW</b>	The FP-300RA continuously transmits a CW signal.
<b>Modulated Tx</b>	The FP-300RA continuously transmits a modulated signal.
<b>Calibration</b>	The TDMA air interface is active; the transmission is made via the antenna selected with <i>Tx Antenna</i> and the reception is made via the antenna selected with <i>Rx Antenna</i> .
<b>BER Test mode</b>	Used for FP-300RA receiver testing

#### **B-7.4 Transmitter**

Enables selecting the Tx antenna and the transmitter output power:

- In the normal mode, the selected setting will take effect when the FP-300RA will switch to this antenna.
- In the calibration mode, the FP-300RA will switch to the selected antenna and the selected output power will be adjusted to the new value on next frame.

#### **B-7.5 Receiver**

Enables selecting the Rx antenna and the receiver digital squelch:

- In the normal mode, the selected setting will take effect when the FP-300RA will switch to this antenna.
- In the calibration mode, the FP-300RA will switch to the selected antenna and the selected digital squelch will be adjusted to the new value on next frame.

#### **B-7.6 Vector Modulator**

The vector modulator is configured by the manufacturer and must not be changed unless explicitly instructed to do so by an authorized Telematics Wireless representative.

#### **B-7.7 Calibration Process**

The calibration process section of the RF setting window is open when calibration Tx mode is selected. The calibration procedure is explained in Appendix E