

TPS360

User Manual

Table of Contents

Getting started.....	1
Device layout.....	1
Buttons	1
Technical Specification	2
Package contents	3
Power on your device	3
Power off your device	3
Installing the SIM card, PSAM and TF card	4
Installing the battery	5
Charging the battery	6
Card Reading	7
Basics.....	8
Home Screen Overview	8
Status & notifications	9
Quick settings.....	10
Profiles	10
Add & switch users	10
Change or delete users	10
Connect & transfer	11
Wi-Fi networks	11
Turn Wi-Fi power on/off.....	11
Connect to networks	11
USB cables	11
Bluetooth	12
Turn Bluetooth power on/off.....	12
Connect devices.....	12
Manage devices	12
Let devices find your device	12
Data use	13
Near Field Communication (NFC) Technology	13
Memory card	14
Mount or unmount memory card	14
Erase memory card content.....	14
Cellular networks	14
Airplane mode	14
Settings	15
Wi-Fi Settings.....	15
Bluetooth Settings.....	15
Data Usage Settings	15
More Settings	16
Cellular Networks Settings.....	16

NFC Settings.....	16
Storage Settings.....	16
Application Manager	17
Location Settings	17
Backup & reset.....	17
Backup and Restore	17
Factory Data Reset	18
Date & Time Settings	18
About Phone	18
Copyright Information.....	19

Read me first

This device provides mobile communication and media services using **Telpo**'s latest standards and technological expertise. This user manual and the information available contain details about the device's functions and features.

- Please read this manual before using the device to ensure safe and proper use.
- Descriptions are based on the device's default settings.
- Some content may differ from your device depending on the region, service provider, or device's software.
- **Telpo** is not liable for performance issues caused by apps supplied by providers other than **Telpo**.
- **Telpo** is not liable for performance issues or incompatibilities caused by edited registry settings or modified operating system software. Attempting to customise the operating system may cause the device or apps to work improperly.
- Software, sound sources, wallpapers, images, and other media provided with this device are licensed for limited use. Extracting and using these materials for commercial or other purposes is an infringement of copyright laws. Users are entirely responsible for illegal use of media.
- You may incur additional charges for data services, such as messaging, uploading and downloading, auto-syncing, or using location services. To avoid additional charges, select an appropriate data tariff plan. For details, contact your service provider.
- Modifying the device's operating system or installing software from unofficial sources may result in device malfunctions and data corruption or loss. These actions are violations of your **Telpo** licence agreement and will void your warranty.
- Is in compliance with the essential requirements and other relevant provisions of Directive 2014/53/EU.
- For safe operating, the antenna of the product shall be least 0.22m away from the body of the user. The maximum allowed antenna gain is 1.0 dBi.
- The Handheld POS Terminal supplied by Li Polymer battery, and charged from approved Travel Charger with USB cable connection.
- Caution:
 - For Adapter: Shall be installed near the equipment and shall be easily accessible.
 - For Battery: Risk of explosion battery is replaced by an incorrect type, dispose of used batteries according to the instructions.
- Only can use the adapter as below:
 - Manufacturer: SAMSON POWER TECHNOLOGY CO.,LTD
 - Model Name: SC/10WA050200US
 - Rated Input & Output: Input: 100-240V~, 50/60Hz, 0.5A; Output: 5V/2A
 - The plug considered as disconnect device of adapter.

Getting started

Device layout

The following illustration outlines your device's primary external features.



Buttons

Button	Function
Power	<ul style="list-style-type: none">Press and hold to turn the device on or off.Press to lock or unlock the device. The device goes into lock mode when the touch screen turns off.
Volume	<ul style="list-style-type: none">Press to adjust the device volume.
Overview	<ul style="list-style-type: none">Tap Overview to see your recent apps, and tap an app to reopen it.To remove an app from the list, swipe it left, right.To scroll the list, swipe up or down.
Home	<ul style="list-style-type: none">Tap to return to the Home screen.
Back	<ul style="list-style-type: none">Tap to return to the previous screen.

Technical Specification

Processor	Quad-Core 1.1GHz or above
OS	Android 7.0 or above
Memory	8GB FLASH, 1GB RAM Optional 16GB FLASH, 2GB RAM
Ext. Memory	TF Card, up to 32GB
Display	5" LCD, 1280*720
Smart Card Reader(Optional)	ISO7816
Contactless Card Reader (Optional)	ISO14443 Type A/B, Mifare®, ISO18092 compliant
Fingerprint	Built-in
Front Camera (Optional)	2MP
Rear Camera	5MP or 8MP, auto focus
GPS	Built-in
SIM	1 SIM or 2 SIMs
PSAM(Optional)	1 PSAM
Communications	TDD-LTE/FDD-LTE/WCDMA/GPRS/Wi-Fi/Bluetooth
Peripheral Ports	1 Micro USB, 1 DC Input
Power Supply	Input: 100-240V AC, 50Hz/60Hz Output: 5V DC, 2A
Battery	Li-Polymer battery, 3.8V/3000mAh,

Package contents

Check the product box for the following items:

- Main Device
- Power Adapter
- Battery
- User guide
- Rubber Case



- The items supplied with the device and any available accessories may vary depending on the region or service provider.
- The supplied items are designed only for this device and may not be compatible with other devices.
- Appearances and specifications are subject to change without prior notice.
- You can purchase additional accessories from your local retailer. Make sure they are compatible with the device before purchase.
- Availability of all accessories is subject to change depending entirely on manufacturing companies. For more information about available accessories, please contact us.

Power on your device

- To turn your device on, hold down the **Power** key until the device powers on. It will take a few seconds before the screen lights up.
- Unlock your device with a swipe, PIN, password or pattern before the Home screen can display if you've set a screen lock in Settings.



- If you do not know your PIN code or if you have forgotten it, contact your network carrier.
- Do not leave your PIN code with your device.
- Store this information in a safe place when not in use.

Power off your device

- To turn your device off, hold down the **Power** key until the Device options appear, then select **Power off**.

Installing the SIM card, PSAM and TF card

- Take out the back cover and battery, the card sockets will be shown.

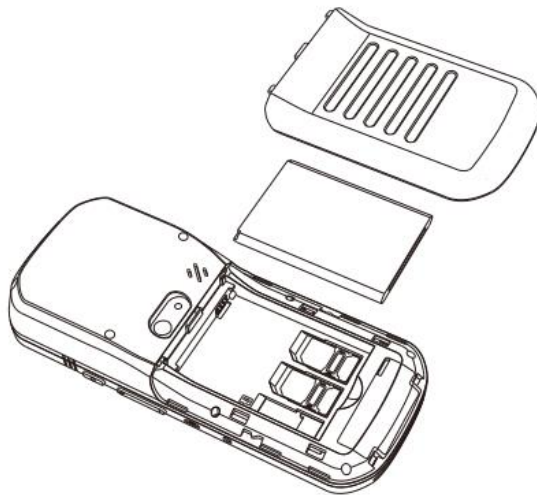

- Be careful not to damage your fingernails when you remove the back cover.
- Do not bend or twist the back cover excessively. Doing so may damage the cover.

- Push the SIM card into the socket correctly. Be sure the SIM card is in right position.

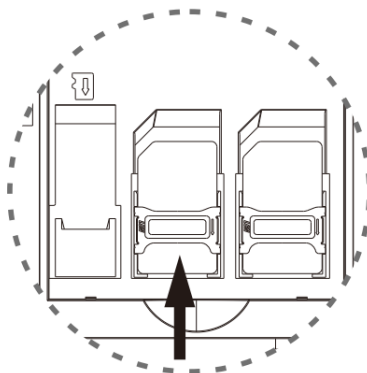

- Do not insert a memory card into the SIM card slot. If a memory card happens to be lodged in the SIM card slot, take the device to a **Telpo** Service Centre to remove the memory card.
- Use caution not to lose or let others use the SIM card. **Telpo** is not responsible for any damages or inconveniences caused by lost or stolen cards.

Installing the battery

- Open the back cover and put the battery into the holder. Install the battery in right direction as the label instructed.

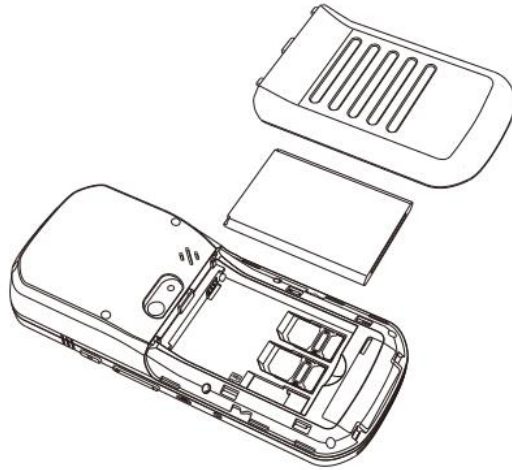

- Put the cover back to the terminal.

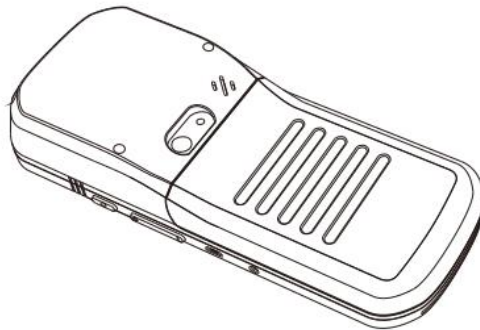

- Any attempt of alteration with wrong battery type has risk of explosion.
- Don't throw battery casually.

Charging the battery

Use the charger to charge the battery before using it for the first time. A computer can be also used to charge the device by connecting them via the USB cable.

- Connect the USB cable to the USB power adaptor.
- Plug one end of the USB cable into the device's Charger Port and the other end into an electrical outlet. The charge time varies depending upon the battery level.

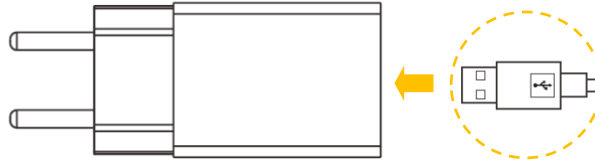

- Use only **Telipo**-approved chargers, batteries, and cables. Unapproved chargers or cables can cause the battery to explode or damage the device.
- Do not remove the battery before removing the charger. This may damage the device.



- When the battery power is low, the battery icon appears empty.
- If the battery is completely discharged, the device cannot be turned on immediately when the charger is connected. Allow a depleted battery to charge for a few minutes before turning on the device.
- If you use multiple apps at once, network apps, or apps that need a connection to another device, the battery will drain quickly. To avoid disconnecting from the network or losing power during a data transfer, always use these apps after fully charging the battery.
- To save energy, unplug the charger when not in use. The charger does not have a power switch, so you must unplug the charger from the electric socket when not in use to avoid wasting power. The charger should remain close to the electric socket and easily accessible while charging.

Card Reading

- NFC tag, put the NFC tag under the head of the device.

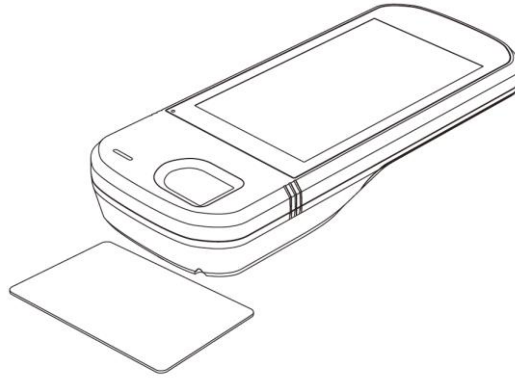

- Smart card, insert the smart card to the slot, chip should be upside.

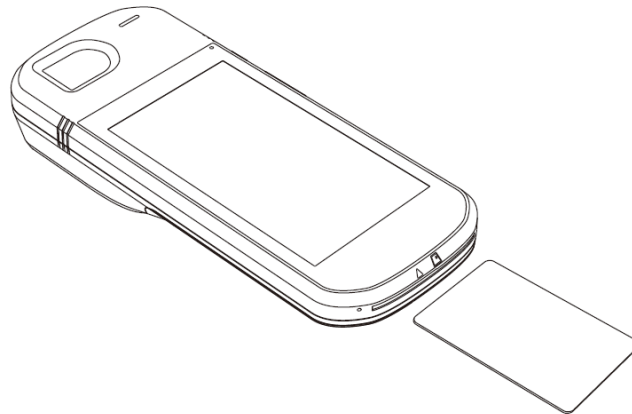

Basics

Home Screen Overview

The home screen is what you see when you first turn on your device. From here, you can explore apps and more.

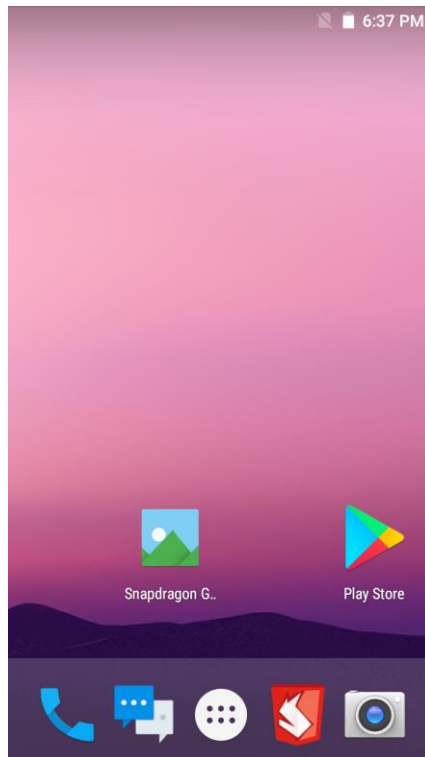

- **Widgets:** To put widgets like a clock, interactive calendar, and more on your home screen, touch and hold an empty spot on the home screen, then tap **WIDGETS**.
- **Settings:** To quickly open settings, swipe the status bar down with two fingers, to open more settings, tap .
- **Apps:** To remove an app from a home screen page, touch and hold the app, then drag it to **Remove**. The app isn't removed from your device, just the home screen. To uninstall apps from your home screen, touch and hold an app, then drag it to **Uninstall**.

Status & notifications

At the top of the screen, icons on the left notify you about new messages or events. If you don't know what an icon means, swipe the status bar down for details.

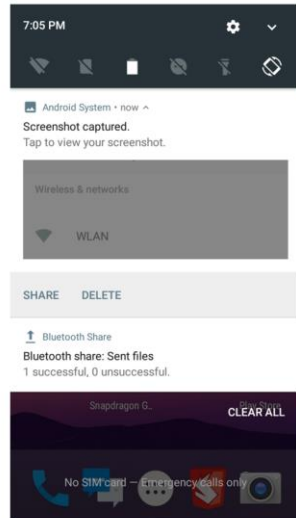









Tips: To clear just one, flick it to the left or right.

Clear Notifications

The icons displayed on the status bar provide information about the status of the device. The icons listed in the table below are most common.

Note: The status bar may not appear at the top of the screen in some apps. To display the status bar, drag down from the top of the screen.

Icon	Meaning
	Bluetooth feature activated
	GPS activated
	Wi-Fi connected
	Signal strength
	Flight mode activated
	Mute mode activated
	Vibration mode activated
	Error occurred or caution required

Quick settings

For quick access to **Wi-Fi**, **Bluetooth**, **Brightness**, **Airplane mode**, and other settings, swipe down the status bar or the lock screen with two fingers. For even more settings, tap .

Note: Your quick settings may look a little different.

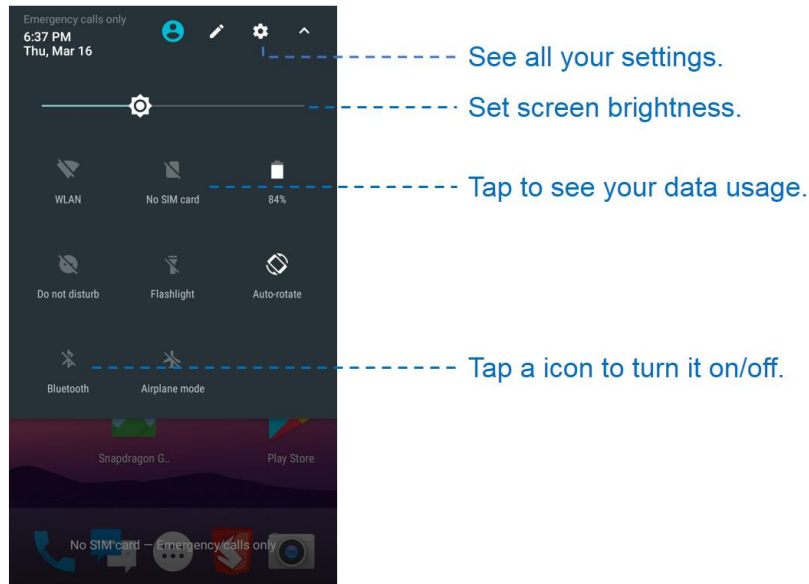

Profiles

You can share your device with others by adding a user. Users will have their own spaces on the device for custom home screens, accounts, apps, personalized settings, and more.

Add & switch users



Note: Only the device's owner can add a user.

Swipe down the status bar with two fingers and tap Profile . Follow the prompts to add a new user.

To switch users, swipe down the status bar with two fingers and tap Profile . Tap a user name.

Note: For a temporary user, use the Guest profile, which has limited access to your device's features and apps. Guests won't have access to your personal information.

Change or delete users

Tap Settings  > Users, then tap  next to a user's name.



Connect & transfer

Wi-Fi networks

Wi-Fi provides wireless Internet access over distances of up to 300 feet. To use your device's Wi-Fi, you need access to a wireless access point or "hotspot."

The availability and range of the Wi-Fi signal depends on a number of factors, including infrastructure and other objects through which the signal passes.

Turn Wi-Fi power on/off

Find it: Settings  > **WLAN**, then touch the Wi-Fi switch to turn it .

Note: To extend battery life, turn the Wi-Fi switch  when you're not using it.

Connect to networks

To find networks in your range:

1. Settings  > **WLAN**.

Note: To show your device's MAC address and Wi-Fi settings, tap Menu  > **Advanced**.

2. Make sure the switch at the top is , then touch Menu  > **Refresh**.

3. Tap a found network to connect it (if necessary, enter **Network SSID**, **Security**, and **Wireless password**, and tap **Connect**).



When your device connects, the Wi-Fi status indicator  appears in the status bar.

Note: The next time your device connects to a previously accessed secured wireless network, you will not be prompted to enter the password again, unless you reset your device to its factory default settings or you instruct the device to forget the network.

Wi-Fi networks are self-discoverable, which means no additional steps are required for your device to connect to a Wi-Fi network. It may be necessary to provide a user name and password for certain closed wireless networks.



USB cables

To load music, pictures, videos, documents, or other files from your computer, connect your device to your computer with a USB cable. To change the type of USB connection (if necessary), tap Settings

 > Storage > Menu  > USB computer connection.

Bluetooth

Turn Bluetooth power on/off



Find it: **Settings**  > **Bluetooth**, then touch the switch to turn it .

Note: Swipe down the status bar with two fingers to quickly turn Bluetooth on or off.

To extend battery life or stop connections, turn Bluetooth switch  when you're not using it.

Connect devices



The first time you connect a **Bluetooth device**, **follow these** steps:

1. Make sure the device you are pairing with is in discoverable mode.
2. Touch **Settings**  > **Bluetooth**.
3. Make sure the switch at the top is .
4. Tap a found device to connect it (if necessary, tap Pair or enter a passkey like 0000).

Note: Tap  to rename a device. When the device connects, the Bluetooth status indicator shows at the top of the screen.

To automatically disconnect or reconnect a device anytime, just turn it off or on.

Manage devices

- To manually reconnect your device with a paired device, tap the device name in the list.
- To manually disconnect your device from a paired device, tap the device name in the devices list, then touch OK.
- To remove a paired device, touch  next to the device name, then touch **Unpair**.
- To change the name your device shows to other devices, touch **Settings**  > **Bluetooth**, turn Bluetooth power on, then tap Menu  > **Rename this device**. Enter a name and touch **Rename**.

Let devices find your device

To let a Bluetooth device discover your device:

- Touch **Settings**  > **Bluetooth**.
- Touch your phone's name at the top to switch between Not visible to other Bluetooth devices and Visible to all nearby Bluetooth devices (for two minutes).

Data use

You can track the amount of data your device uploads and downloads.

Find it: Settings  > **Data usage**

Your device shows a data usage graph. Below the graph, apps appear from highest to least data usage. Apps that use a lot of data might also use a lot of battery power.

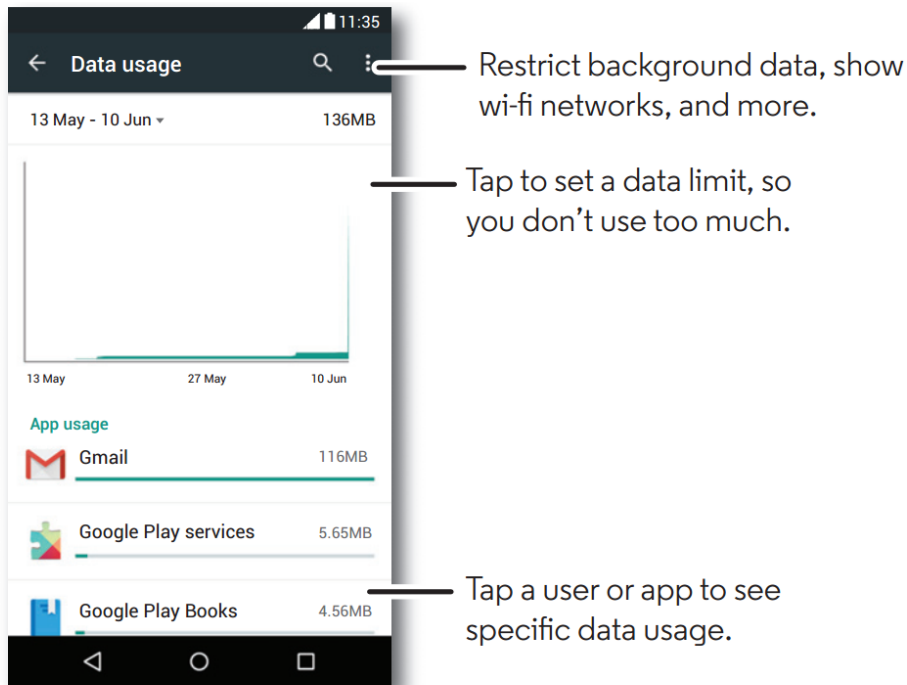

Note: Usage information is provided to help you manage your device. This may not match the amounts charged by your service provider, as they're not measured in the same way.

Near Field Communication (NFC) Technology

NFC (Near Field Communication) technology is a short-range, wireless technology that lets you quickly and wirelessly exchange information between your device and other NFC-enabled devices, smart accessories, and NFC-enabled access points. You can also use NFC technology to save, view, create, or change smart tags.

To use NFC technology on your device, your device must be within approximately 0.78 in. (2 cm) of the NFC-enabled device, smart accessory, NFC-enabled access point, or smart tag that you want to exchange information with. When information is transferred over an NFC connection, your device vibrates.

Turn NFC On and Off

When NFC is turned on, data can be exchanged when your device touches another device.

1. Touch **Settings**  > **More...**
2. Touch the check box next to **NFC** to turn the feature On or Off.

Memory card

Your photos, videos, and other files are automatically stored in your device's internal memory. You can set certain apps, like the camera, to store files on a microSD card.

Note: Your device supports memory cards up to 32GB.

Find it: **Settings**  > **Storage & USB** > **SD CARD**

Mount or unmount memory card

To mount a memory card, simply put it into your device.

To unmount your memory card (so you can take it out of your device), tap **Settings**  > **Storage & USB** > **Unmount SD card**.

Note: Do not remove a memory card while your device is using it or writing files to it.

Erase memory card content

To delete all the information (music, photos, and files) from your memory card, tap **Settings**  > **Storage & USB** > **Erase SD card**.

Cellular networks

You should not need to change any network settings. Contact your service provider for help.

To see network settings options, tap **Settings**  > **More** > **Cellular networks**.

Airplane mode

Use airplane mode to turn off all your wireless connections—useful when flying. Swipe down the status bar with two fingers, then tap **Airplane mode**.

Or tap **Settings**  > **More** > **Airplane mode**.

Note: When you select airplane mode, all wireless services are disabled. You can then turn Wi-Fi and/or Bluetooth Power back on, if permitted by your airline. Other wireless voice and data services (such as calls and text messages) remain off in airplane mode. Emergency calls to your region's emergency number can still be made.

Settings

Wi-Fi Settings



The Wi-Fi settings menu lets you turn Wi-Fi on or off, set up and connect to available Wi-Fi networks, and configure advanced Wi-Fi options.

Access the Wi-Fi Settings Menu

- Touch **Settings**  > **WLAN**.

Advanced Wi-Fi Settings

The advanced Wi-Fi settings menu lets you set up and manage wireless access points.

1. Touch **Settings**  > **WLAN**.
2. Touch **Menu**  > **Advanced**.
3. Configure your Wi-Fi settings, which may include:
 - **Network notification**
 - **Keep Wi-Fi on during sleep**
 - **Scanning always available**
 - **WLAN frequency band**
 - **Install certificates**
 - **WLAN Direct**
 - **WPS Push Button**
 - **WPS Pin Entry**

Bluetooth Settings

Your device's Bluetooth capabilities let you use wireless headsets, send and receive pictures and files, and more.

Access the Bluetooth Settings Menu

- Touch **Settings**  > **Bluetooth**.

Data Usage Settings

The Data usage menu lets you view your device's mobile and Wi-Fi data usage, set data limits, restrict hotspot usage, and more.

- Touch **Settings**  > **Data usage**.

More Settings

The More settings menu provides access to additional wireless and network options, such as **cellular networks, VPN, Mobile plan, Emergency broadcasts**, and more.

Cellular Networks Settings

The Mobile networks options let you enable your device's mobile data access, set your preferred network mode, configure Connections Optimizer, and select network operators for international use.

1. Touch **Settings**  > **More...** > **Cellular networks**.
2. Options include:
 - Data roaming
 - Preferred network type
 - System select
 - Access Point Names
 - Network operators

NFC Settings

NFC (Near Field Communication) is a wireless technology that enables data transmission between two objects when they are brought within a few inches of each other. When you enable NFC on your device, it can exchange data with other NFC-enabled devices or read information from smart tags embedded in posters, stickers, and other products. From the NFC settings menu, you can manage direct sharing and pairing Bluetooth via NFC.

1. Touch **Settings**  > **More...**
2. Touch the check box next to **NFC** to turn the feature On or Off.

Storage Settings

The Storage settings menu lets you manage internal storage on your device. You can view your device's internal storage capability and available space.

- Touch **Settings**  > **Storage & USB**.
 - View your device's memory storage total space and space used by specific features.
 - Touch an itemized category for additional details.

Application Manager

You can download and install applications from the Google Play Store or create applications using the Android SDK and install them on your device. Use Application manager to manage applications on your device.

1. Touch **Settings**  > **Apps**.
2. Touch **Downloaded**, **Phone storage**, **Running** or **All** to view the status of apps and services. Tap an app or service for more information, and for app options, such as stopping and uninstalling.

Location Settings

Your Location menu lets you select how your device determines its location (using the wireless network, GPS satellites, both, or neither).

1. Touch **Settings**  > **Location**.
2. Touch the **ON/OFF** switch next to **Location** to turn the option On or Off.

Backup & reset

Your device's **Back up and reset** menu lets you back up your device's data and settings to Google servers before resetting your device to the original factory settings. The Factory data reset erases all data from the device's application storage, including:

- Your Google Account
- All other email and social networking accounts
- System and application data and settings
- Downloaded applications

Backup and Restore

To set your backup and restore options:

1. Touch **Settings**  > **Back up and reset**.
2. Select your backup and restore options.
 - **Back up my data:** This option lets you back up your app data, Wi-Fi passwords, and other settings to Google servers.
 - **Backup account:** Select a Google Account for your device backup.
 - **Automatic restore:** This option lets you restore backed up settings and data when reinstalling an application after a factory data reset.

Factory Data Reset

1. Touch **Settings**  > **Back up and reset**.
2. Touch **Factory data reset**.
3. Read the factory data reset information page and touch **Reset device**.
4. Touch **Delete all**. Your device will power down and reset itself, which may take up to 10 minutes.

Once the device has reset, it will run through the Hands Free Activation and update processes again. When finished, you will see the Welcome screen and Setup application.

Date & Time Settings

Use the Date & Time settings menu either to automatically use the network-provided date and time or manually set these values, as well as select time and date format options.

1. Touch **Settings**  > **Date and time**.
2. Touch **Automatic date & time** to disable the feature.
 - If enabled, you cannot alter the date, time zone or time values.
3. Touch **Set date**. Adjust the date, month, and year. Touch **Done** when finished.
4. Touch **Set time**. Adjust the hour and minute. Touch **Done** when finished.
5. Touch **Automatic time zone** to disable the feature.
 - If enabled, you cannot alter the time zone values.
6. Touch **Select time zone**, and then select a time zone from the onscreen list. Scroll down the list to view additional time zones.
7. Touch **Use 24-hour format** to toggle between using a 12-hour or a 24-hour format.

About Phone

Find it: **Settings**  > **About Phone**

This contains information about things ranging from Status, Legal information, Model number, Android version, Android security patch level, Baseband version, Kernel version, Build number to those listed below:

- **Status:** This contains the status of the Battery status, Battery level, My device number, Network, Signal strength, etc.
- **Legal information:** Touch to view legal information.
- **Model number:** View your device's model number.
- **Android version:** View the firmware version of your device.
- **Baseband version:** View the baseband version of your device.
- **Kernel version:** View the kernel version of your device.
- **Build number:** View the build number of your device.

Copyright Information

Copyright © 2017 **Telepower Communication Co.,Ltd.**

This manual is protected under international copyright laws.

No part of this guide may be reproduced, distributed, translated, or transmitted in any form or by any means, electronic or mechanical, including photocopying, recording, or storing in any information storage and retrieval system, without the prior written permission of **Telepower Communication Co.,Ltd.**

FCC RF EXPOSURE INFORMATION:

WARNING!! Read this information before using your phone

In August 1986 the Federal Communications Commission (FCC) of the United States with its action in Report and Order FCC 96-326 adopted an updated safety standard for human exposure to radio frequency (RF) electromagnetic energy emitted by FCC regulated transmitters. Those guidelines are consistent with the safety standard previously set by both U.S. and international standards bodies. The design of this phone complies with the FCC guidelines and these international standards. Use only the supplied or an approved antenna. Unauthorized antennas modifications, or attachments could impair call quality, damage the phone, or result in violation of FCC regulations. Do not use the phone with a damaged antenna. If a damaged antenna comes into contact with the skin, a minor burn may result. Please contact your local dealer for replacement antenna.

BODY-WORN OPERATION:

This device was tested for typical body-worn operations with the back/front of the phone kept 5mm from the body. To comply with FCC RF exposure requirements, a minimum separation distance of 5mm must be maintained between the user's body and the back/front of the phone, including the antenna. Third-party belt-clips, holsters and similar accessories containing metallic components shall not be used. Body-worn accessories that cannot maintain 5mm separation distance between the user's body and the back/front of the phone, and have not been tested for typical body-worn operations may not comply with FCC RF exposure limits and should be avoided.

For more information about RF exposure, please visit the FCC website at www.fcc.gov

Your wireless handheld portable telephone is a low power radio transmitter and receiver. When it is ON, it receives and also sends out radio frequency (RF) signals. In August, 1996, the Federal Communications Commission (FCC) adopted RF exposure guidelines with safety levels for handheld wireless phones. Those guidelines are consistent with the safety standards previously set by both U.S. and international standards bodies:

<ANSI C95.1> (1992) / <NCRP Report 86> (1986) / <ICNIRP> (1999)

Those standards were based on comprehensive and periodic evaluations of the relevant scientific literature. For example, over 120 scientists, engineers, and physicians from universities, government health agencies, and industry reviewed the available body of research to develop the ANSI Standard (C95.1). Nevertheless, we recommend that you use a hands-free kit with your phone (such as an earpiece or headset) to avoid potential exposure to RF energy. The design of your phone complies with the FCC guidelines (and those standards).

Use only the supplied or an approved replacement antenna. Unauthorized antennas, modifications, or attachments could damage the phone and may violate FCC regulations.

NORMAL POSITION:

Hold the phone as you would any other telephone with the antenna pointed up and over your shoulder.

RF Exposure Information:

This product is compliance to FCC RF Exposure requirements and refers to FCC website <https://apps.fcc.gov/oetcf/eas/reports/GenericSearch.cfm> search for FCC ID: 2AJ2B-TPS360

This device complies with part 15 of the FCC rules. Operation is subject to the following two conditions:

- (1) this device may not cause harmful interference, and
- (2) this device must accept any interference received, including interference that may cause undesired operation.

NOTE: The manufacturer is not responsible for any radio or TV interference caused by unauthorized modifications to this equipment. Such modifications could void the user's authority to operate the equipment.

NOTE: This equipment has been tested and found to comply with the limits for a Class B digital device, pursuant to part 15 of the FCC Rules. These limits are designed to provide reasonable protection against harmful interference in a residential installation. This equipment generates uses and can radiate radio frequency energy and, if not installed and used in accordance with the instructions, may cause harmful interference to radio communications. However, there is no guarantee that interference will not occur in a particular installation. If this equipment does cause harmful interference to radio or television reception, which can be determined by turning the equipment off and on, the user is encouraged to try to correct the interference by one or more of the following measures:

- Reorient or relocate the receiving antenna.
- Increase the separation between the equipment and receiver.
- Connect the equipment into an outlet on a circuit different from that to which the receiver is connected.
- Consult the dealer or an experienced radio/TV technician for help

Do not use the device with the environment which below minimum -10°C or over maximum 50°C , the device may not work.

Changes or modifications to this unit not expressly approved by the party responsible for compliance could void the user's authority to operate the equipment.

Ad Hoc function is supported but not able to operate on non-US frequencies.