

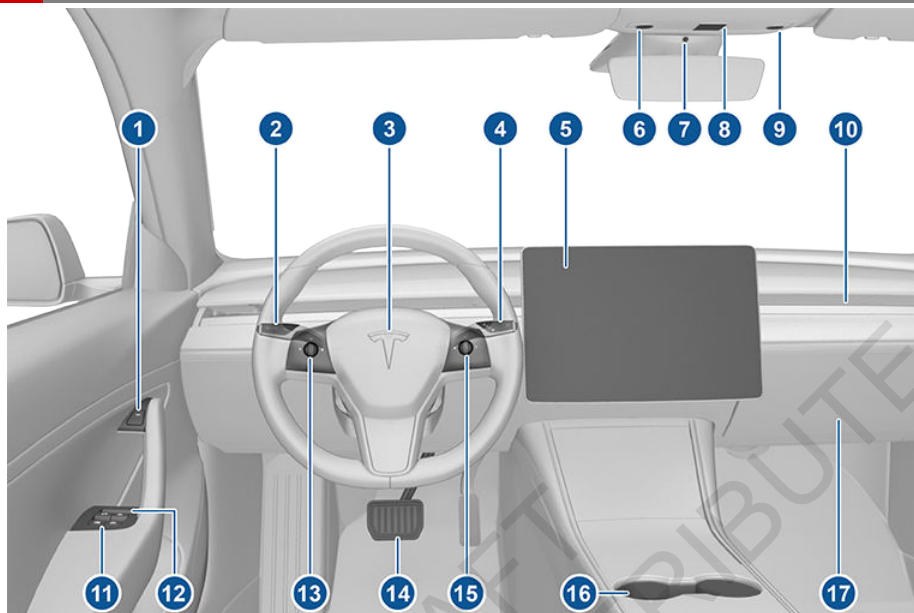

Overview.....	2	Maintenance.....	112
Interior Overview.....	2	Maintenance Schedule.....	112
Exterior Overview.....	3	Tire Care and Maintenance.....	113
Touchscreen Overview.....	4	Cleaning.....	119
Opening and Closing.....	6	Wiper Blades and Washer Jets.....	122
Keys.....	6	Fluid Reservoirs.....	124
Doors.....	9	Jacking and Lifting.....	126
Windows.....	11	Parts and Accessories.....	127
Rear Trunk.....	12	Specifications.....	130
Front Trunk.....	14	Identification Labels.....	130
Interior Storage and Electronics.....	16	Vehicle Loading.....	131
Seating and Safety Restraints.....	17	Dimensions and Weights.....	134
Front and Rear Seats.....	17	Subsystems.....	136
Seat Belts.....	20	Wheels and Tires.....	138
Child Safety Seats.....	23	Roadside Assistance.....	145
Airbags.....	29	Contacting Roadside Assistance.....	145
Driving.....	33	Instructions for Transporters.....	146
Driver Profiles.....	33	Consumer Information.....	150
Steering Wheel.....	35	Easter Eggs.....	150
Mirrors.....	36	About this Owner Information.....	151
Starting and Powering Off.....	37	Disclaimers.....	152
Gears.....	38	Reporting Safety Defects.....	154
Car Status.....	39	Declarations of Conformity.....	155
Lights.....	42		
Wipers and Washers.....	45		
Brakes.....	46		
Traction Control.....	48		
Park Assist.....	49		
Vehicle Hold.....	51		
Getting Maximum Range.....	52		
Rear View Camera.....	53		
Cabin Camera.....	54		
Autopilot.....	55		
About Autopilot.....	55		
Traffic-Aware Cruise Control.....	58		
Autosteer.....	64		
Auto Lane Change.....	67		
Autopark.....	69		
Lane Assist.....	74		
Collision Avoidance Assist.....	76		
Speed Assist.....	79		
Using the Touchscreen.....	81		
Controls and Settings.....	81		
Climate Controls.....	86		
Media and Audio.....	90		
Phone.....	93		
Maps and Navigation.....	95		
Using Voice Commands.....	99		
Security Settings.....	100		
HomeLink [®] Universal Transceiver.....	101		
Connecting to Wi-Fi.....	103		
Software Updates.....	104		
Charging.....	105		
Electric Vehicle Components.....	105		
Battery Information.....	107		
Charging Instructions.....	108		

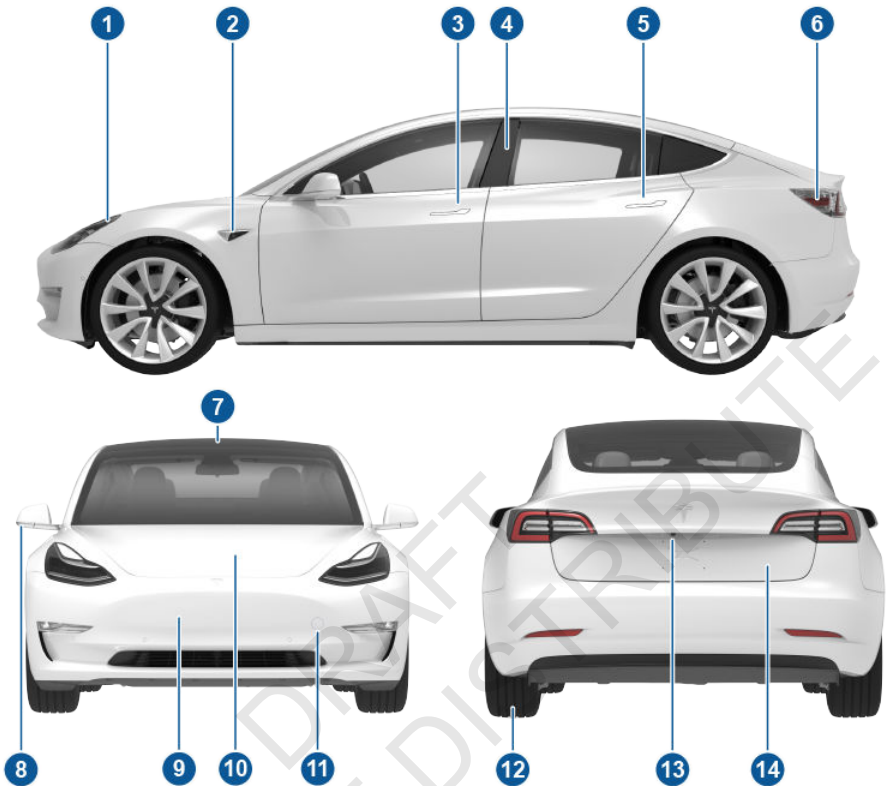

1. Door open button ([Opening Doors from the Interior](#) on page 9)
2. High beams ([High Beam Headlights](#) on page 42), turn signals ([Turn Signals](#) on page 43), and wipers and washers ([Wipers and Washers](#) on page 45)
3. Horn ([Horn](#) on page 35)
4. Gear selector ([Shifting Gears](#) on page 38), Traffic-Aware Cruise Control ([Traffic-Aware Cruise Control](#) on page 58), and Autosteer ([Autosteer](#) on page 64)
5. Touchscreen ([Touchscreen Overview](#) on page 4)
6. Driver dome light ([Lights](#) on page 42)
7. Cabin camera ([Cabin Camera](#) on page 54)
8. Hazard warning flashers ([Hazard Warning Flashers](#) on page 44)
9. Passenger dome light ([Lights](#) on page 42)
10. Climate control vent (see [Climate Controls](#) on page 86)
11. Power window switches ([Windows](#) on page 11)
12. Manual door release ([Opening Doors from the Interior](#) on page 9)
13. Left scroll button ([Scroll Buttons](#) on page 35)
14. Brake pedal ([Brakes](#) on page 46)
15. Right scroll button ([Scroll Buttons](#) on page 35)
16. Center console ([Interior Storage and Electronics](#) on page 16)
17. Glovebox ([Glovebox](#) on page 16)



1. Exterior lights ([Lights](#) on page 42)
2. Autopilot camera ([About Autopilot](#) on page 55)
3. Front door handle ([Using Exterior Door Handles](#) on page 9)
4. Key card sensor ([Keys](#) on page 6), Autopilot camera ([About Autopilot](#) on page 55)
5. Rear door handle ([Using Exterior Door Handles](#) on page 9)
6. Charge port ([Charging Instructions](#) on page 108)
7. Autopilot cameras ([About Autopilot](#) on page 55)
8. Exterior mirrors ([Mirrors](#) on page 36)
9. Radar sensor (hidden from view) ([About Autopilot](#) on page 55)
10. Hood/front trunk ([Front Trunk](#) on page 14)
11. Tow eye cover ([Instructions for Transporters](#) on page 146)
12. Wheels and tires ([Wheels and Tires](#) on page 138)
13. Rear view camera ([Rear View Camera](#) on page 53)
14. Rear trunk ([Rear Trunk](#) on page 12)



Touchscreen Overview

The features and information you need to drive Model 3 are displayed on the touchscreen. When driving, the touchscreen displays driving-related information such as driving speed, vehicle range, warnings, etc. The touchscreen is used to control many features that, in traditional cars, are controlled using physical buttons (for example, adjusting mirrors). You can also use the touchscreen to customize Model 3 to suit your preferences.

Warning: Always pay attention to road and traffic conditions when driving. To minimize driver distraction and ensure the safety of vehicle occupants as well as other road users, avoid using the touchscreen to adjust settings while the vehicle is in motion.

The main areas of the touchscreen are summarized here:

Note: The image below is provided for demonstration purposes only. Depending on vehicle options, software version and market region, your touchscreen may appear slightly different.

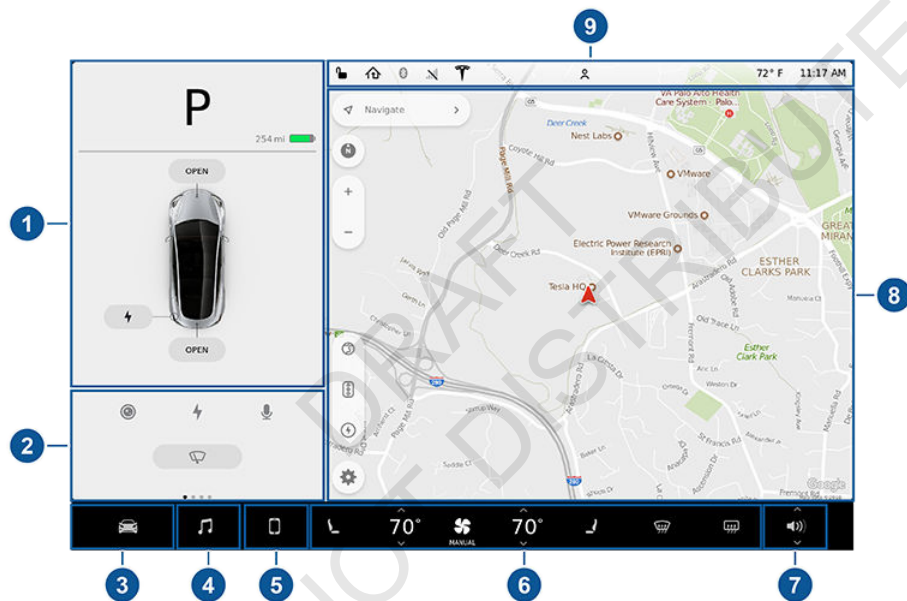

1. **Car Status.** This area dynamically displays the current status of Model 3 as you drive, park, open doors, turn lights on, etc. Monitor this area when driving as it displays important information such as driving speed and warning messages (see [Car Status](#) on page 39). When the car is in Park, you can open the trunks or charge port door.
2. **Cards.** This area automatically updates to display certain information such as incoming calls, seatbelt reminders, current state of the wipers, etc. Additionally, you can swipe to the right or left to scroll through cards that you can use to quickly access:
 - Rear view camera (see [Rear View Camera](#) on page 53), charging status (see [Charging Instructions](#) on page 108), and voice commands (see [Using Voice Commands](#) on page 99).
 - Wipers (see [Wipers](#) on page 45).
 - Trips. You can display distance driven, energy usage and energy efficiency starting at any time, or since Model 3 was last charged. You can also display this information for up to two trips. Touch ... in the top right corner of a trip to rename or reset a trip.
 - Tire Pressures. Display tire pressures or view cautions or warnings related to pressures that are not within acceptable limits (see [Tire Care and Maintenance](#) on page 113).
3. **Controls.** Touch to control features and customize Model 3 to suit your preferences (see [Controls and Settings](#) on page 81).



4. Media Player (see [Media and Audio](#) on page 90).
5. Phone (see [Phone](#) on page 93).
6. Climate Controls (see [Climate Controls](#) on page 86).
7. Volume Control (see [Volume Control](#) on page 90).
8. Navigation (see [Maps and Navigation](#) on page 95).

Note: When you touch **Controls**, the controls and settings window displays on top of this navigation window (see [Controls and Settings](#) on page 81). To close the window and see the map, touch **Controls** again.

9. This area on the top of the touchscreen displays the time, outdoor temperature, vehicle information (the Tesla "T"), network strength, Bluetooth[®] status, and passenger airbag status. It also provides shortcuts to lock/unlock the vehicle and to access settings for features such as HomeLink[®], Driver Profiles, software updates, and Wi-Fi. If you see an exclamation mark, touch it to see warning messages that are in effect.

Note: The airbag status symbol displays in the top right corner of the touchscreen only when Model 3 is powered on, ready to drive, and the airbag is turned off (see [Airbags](#) on page 29).

The Tesla "T"

Touch the Tesla "T" at the top center of the touchscreen to display:

- Vehicle name (see [Naming Your Vehicle](#) on page 85).
- Battery size.
- Odometer.
- Vehicle Identification Number (VIN).
- Version of software currently installed on your Model 3.
- Release notes associated with the currently-installed software version.
- This owner's manual.
- One-touch access to call Tesla Customer Support and Roadside Assistance.
- One-touch access to all discovered Easter Eggs (see [Easter Eggs](#) on page 150).



Two Types of Keys

Instead of a key fob, Model 3 supports two types of keys:

- **Authenticated phone** - communicates with Model 3 using Bluetooth. Supports automatic locking and unlocking as well as several other functions using the Tesla mobile app. An authenticated phone is the preferred key because you never need to remove it from your pocket or purse.
- **Key card** - communicates with Model 3 short range radio-frequency identification (RFID) signals. The key card is used to "authenticate" your phone to work with Model 3. In situations where your authenticated phone has a dead battery, or is lost or stolen, use your key card to unlock, drive, and lock Model 3.

Phone

Using your phone is the most convenient way to access your Model 3. As you approach, your phone's Bluetooth signal is detected and doors unlock when you press a door handle. Likewise, when you exit and walk away with the phone, doors automatically lock (provided the **Walk Away Lock** feature is turned on, as described in [Walk Away Lock](#) on page 10).

Before you can use a phone to access Model 3, follow these steps to authenticate it:

1. Download the Tesla mobile app to your phone.
2. Log into the Tesla mobile app using your Tesla Account user name and password.
Note: You must remain logged in to your Tesla Account to use your phone to access Model 3.
3. Ensure that your phone's Bluetooth setting is turned on.
Note: Model 3 communicates with your phone using Bluetooth. To authenticate your phone or use it as a key, the phone must be powered on and Bluetooth must be enabled. Keep in mind that your phone must have enough battery power to run Bluetooth and that many phones disable Bluetooth when the battery is low.
4. Ensure that Allow Mobile Access (**Controls > Safety & Security > Settings > Allow Mobile Access**) is enabled.

5. In the Tesla mobile app, touch **PHONE KEY** then touch **START** to search for your Model 3.

When your Model 3 is detected, the mobile app asks you to tap your key card.

6. Tap the key card against the Model 3 card reader on the door pillar or center console (see [Key Card](#) on page 7).

When Model 3 detects your key card, the mobile app confirms that your phone has been successfully authenticated. Touch **DONE**.

If the key card is not successfully scanned within approximately 30 seconds, the mobile app displays an error message. Touch **PHONE KEY** on the app again to retry.

Model 3 can store up to 19 keys (authenticated phones or key cards) simultaneously. To view a list of keys that can currently access Model 3, or to remove a phone, touch **Controls > Locks** (see [Managing Keys](#) on page 7).

Note: Authenticating your phone allows you to use it as a key to access Model 3. To use the phone hands-free, access your phone's contacts, play media from it, etc., you must also pair and connect to it using the Bluetooth settings (see [Phone](#) on page 93).

Note: Model 3 can connect to three phones simultaneously. Therefore, if more than one phone is detected and you want to use, or authenticate, a different phone, move the other connected phone(s) out of range or turn off its Bluetooth setting.

Note: Unlike the mobile app, once a phone has been authenticated, it no longer requires an internet connection to communicate with Model 3. Authenticated phones communicate with Model 3 using Bluetooth.

Note: Although Bluetooth typically communicates over distances of up to approximately 30 feet (9 meters), performance can vary based on the phone you are using, environmental interference, etc.

Note: If multiple vehicles are linked to the Tesla Account, you must switch the mobile app to the Model 3 that you want to access before you can use the phone as a key.



Key Card

Tesla provides you with two Model 3 key cards, designed to fit in your wallet. Model 3 reads a key card only when placed within very close proximity (an inch or two) to one of its card readers. Card readers are located on the driver's side door pillar and on the center console.

To use a key card to unlock or lock Model 3, position the card as illustrated and tap it against the card reader located below the Autopilot camera on the driver's side door pillar. When Model 3 detects the key card, the exterior lights flash and the doors unlock or lock.

Note: You may need to physically touch the driver's side door pillar with the key card, and you may need to hold it against the transmitter for one or two seconds.

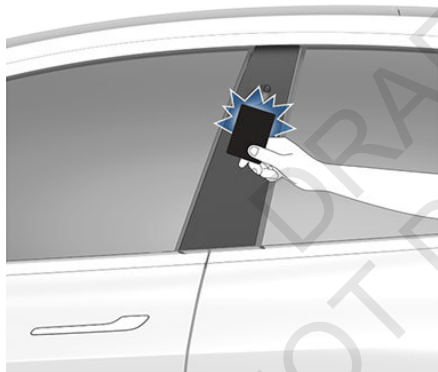

Once inside, power up Model 3 by pressing the brake pedal within two minutes of scanning the key card (see [Starting and Powering Off](#) on page 37). If you wait longer than two minutes, you must re-authenticate by placing the key card near the card reader located behind the cup holders on the center console. When your key card is detected, your two minute authentication period restarts.

Note: You must position the key card within an inch or two of a card reader to allow Model 3 to read it. You may need to physically touch the center console or driver's side door pillar with the key card, and you may need to hold it against the transmitter for one or two seconds.

Note: Walk Away Lock operates only when using an authenticated phone. When you walk away from Model 3 carrying only your key card, Model 3 does not automatically unlock/

lock, even if this feature is turned on (see [Walk Away Lock](#) on page 10).

! Caution: Always carry your key card with you in your purse or wallet to use as a backup in case your authenticated phone has a dead battery, or is lost or stolen.

Managing Keys

To display a list of all keys that can access Model 3, touch **Controls** > **Locks**.

When you no longer want a phone to access Model 3 (for example, you lost it or upgraded to a new one), touch its associated trash icon to remove it. When you remove a phone, the Tesla mobile app displays a notification.

Note: The list of keys is hidden when Model 3 is in Valet mode.

Mobile App

In addition to using the mobile app to authenticate a phone as your Model 3 key, you can use it to:

- Lock or unlock Model 3 doors and trunks remotely.
- Check charging progress and receive notifications when charging has started, has been interrupted, is near completion, or is complete.
- Heat or cool Model 3 before driving (even when it is parked in a garage).
- Locate Model 3 with directions, or monitor its movement across a map.
- Flash the exterior lights or honk the horn to find Model 3 when parked.
- Enable/disable Valet mode.
- Start Model 3 remotely.
- Park or unpark Model 3 using Summon.
- Receive notifications if the security alarm is triggered.
- Receive notifications when a software update is available or scheduled (see [Software Updates](#) on page 104).

Note: To allow the mobile app to communicate with Model 3, the phone must be connected to the internet and mobile access must be enabled (touch **Controls** > **Safety & Security** > **Settings** > **Allow Mobile Access** on the touchscreen).

Note: If multiple vehicles are linked to the Tesla Account, you must switch to the Model 3 that you want to access in the mobile app before the phone can be used as a key.



Note: To take advantage of new and improved features, download updated versions of the mobile app as they become available.

⚠ Caution: Tesla does not support the use of third party applications to contact Model 3.

DRAFT
DO NOT DISTRIBUTE



Keyless Locking and Unlocking

Locking and unlocking Model 3 is easy and convenient. Just carry your authenticated phone with you. Model 3 recognizes the presence of an authenticated phone and automatically unlocks when you press a door handle, and locks when you leave (see [Walk Away Lock](#) on page 10).

Note: If you don't have your authenticated phone with you (or if the phone's battery is dead or its Bluetooth setting is turned off), place the key card against the driver's side door pillar to manually unlock or lock Model 3 (see [Keys](#) on page 6).

Using Exterior Door Handles

Use your thumb to push the wide part of the door handle. The handle pivots toward you, and you can open the door by pulling the handle or pulling the edge of the door.



The handle retracts automatically.



When a door or trunk is open, the touchscreen displays the Door Open indicator light.

Opening Doors from the Interior

Model 3 doors are electrically powered. To open a door while sitting inside, press the button located at the top of the interior door handle.

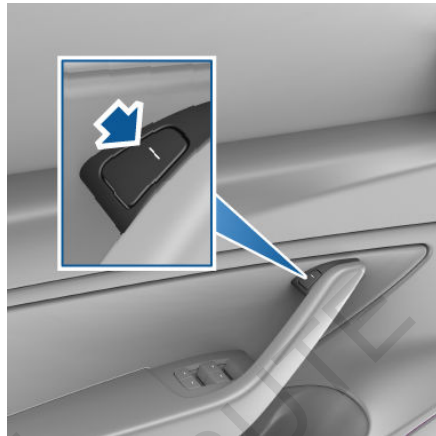

Note: To prevent children from opening the rear doors, turn on child protection locks (see [Child Protection Lock](#) on page 10).

In the unlikely situation that Model 3 has no power, these electrically powered buttons at the top of the door handles no longer work. Instead, pull up the manual door release located in front of the window switches on the front doors.

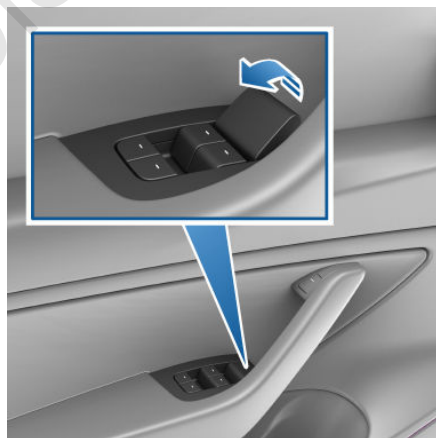

Note: Only front doors are equipped with a manual door release.

⚠ Caution: The manual door release is designed to be used only in situations when Model 3 has no power. Whenever Model 3 has power, use the button located at the top of the interior door handle.



Interior Locking and Unlocking

While sitting inside Model 3, you can lock and unlock all doors and trunks by touching the lock icon on the touchscreen (you do not need an authenticated phone or key card).



The icon changes to indicate whether doors are locked or unlocked.

You can also unlock the doors by pressing the Park button on the end of the gear selector a second time. Pressing this button once engages the Park gear and pressing it again unlocks the doors.

Walk Away Lock

Doors and trunks can automatically lock whenever you walk away carrying your authenticated phone. When the doors lock, the exterior lights flash once.

Model 3 does not automatically lock if:

- An authenticated phone is detected inside Model 3.
- You are not using an authenticated phone as the key and walk away carrying the key card. When using the key card you must manually lock Model 3 by tapping the key card against the door pillar (see [Keys](#) on page 6).
- A door or trunk is not fully closed.

To turn this feature on or off, touch **Controls > Locks > Settings > Walk Away Lock**.

Note: If all doors are closed and Model 3 was automatically unlocked by your authenticated phone, walk-away locking is temporarily suspended for one minute. If you open a door within this minute, it will not re-lock until all the doors are closed and you have walked away with the authenticated phone.

Child Protection Lock

Model 3 has child protection locks on the rear doors to prevent them from being opened using the interior release buttons. On the touchscreen, touch **Controls > Locks > Child Lock**.

Note: It is recommended that you turn child protection locks on whenever children are seated in the rear seats.

Unlock on Park

When you stop Model 3 and engage the Park gear, you can choose to unlock all doors. To turn this feature on or off, touch **Controls > Locks > Settings > Unlock on Park**.

Note: If set to **OFF**, you can unlock all doors by pressing the Park button a second time after engaging the Park gear.



Opening and Closing

Press down on a switch to lower the associated window. Window switches operate at two levels:

- To lower a window fully, press the switch all the way down and immediately release.
- To lower a window partially, press the switch gently and release when the window is where you want it.

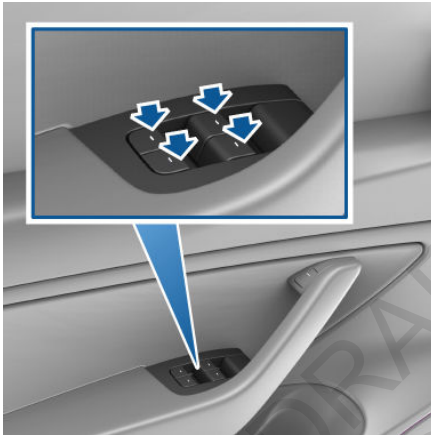

Similarly, pull a switch to raise the associated window:

- To raise a window fully, pull the switch all the way up and immediately release.
- To raise a window partially, pull the switch gently and release when the window is where you want it.

Warning: Before closing a window, it is the driver's responsibility to ensure that all occupants, especially children, do not have any body parts extended through the window's opening. Failure to do so can cause serious injury.

Locking Rear Windows

To prevent passengers from using the rear window switches, touch **Controls > Quick Controls > Window Lock**. To unlock the rear windows, touch **Window Lock** again.

Warning: To ensure safety, it is recommended that you lock the rear window switches whenever children are seated in the rear seats.

Warning: Never leave children unattended in Model 3.



Opening

To open the rear trunk, do one of the following then pull the rear trunk open:

- Touch the associated **OPEN** button on the touchscreen.
- Touch the trunk button on the mobile app.
- With Model 3 unlocked, press the switch located under the rear trunk's exterior handle.

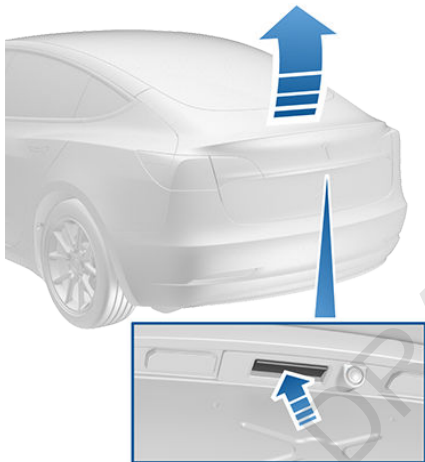

When a door or trunk is open, the touchscreen displays the Door Open indicator light.

To open the trunk from inside Model 3 in the unlikely situation that Model 3 has no power, see [Interior Emergency Trunk Release](#) on page 12.

- ⚠ **Warning:** Before opening or closing the rear trunk, it is important to check that the area around the trunk is free of obstacles (people and objects).

Load Limits

Secure all cargo before moving Model 3, and place heavy cargo in the lower trunk compartment.

- ⚠ **Caution:** To avoid damage, never load more than 130 lbs (60 kg) on the rear load floor (above the lower trunk compartment) or more than 130 lbs (60 kg) in the lower trunk compartment. Doing so can cause damage.

Closing

To close the rear trunk, push it downward until you hear the latch click into place.

Note: Model 3 is equipped with pull cups to assist with lowering the rear trunk.



- ⚠ **Warning:** Before driving, ensure that the trunk is securely latched in the fully-closed position by lifting up on the bottom edge and confirming there is no movement.

Accessing the Cargo Area

To access the cargo area inside the rear trunk, pull up the strap at the rear of the cargo cover. You can then fold the cargo cover forward or remove it from Model 3.



- ⚠ **Caution:** Never load more than 130 lbs (60 kg) on the rear load floor (above the lower trunk compartment) or more than 130 lbs (60 kg) in the lower trunk compartment. Doing so can cause damage.

Interior Emergency Trunk Release

An illuminated mechanical release located inside the rear trunk allows you to open the rear trunk from the inside if Model 3 has no electrical power. This mechanical release also allows a person locked inside to get out.

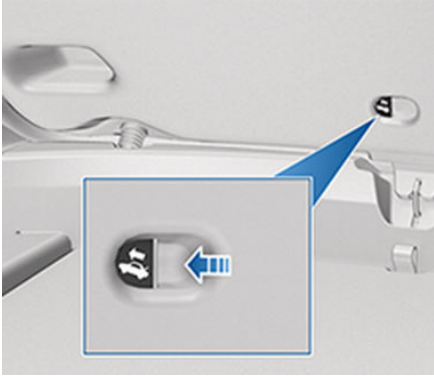

1. Firmly push the illuminated button in the direction of the arrow to release the latch.
2. Push the rear trunk open.

Note: The button glows for several hours after a brief exposure to ambient light.

- ⚠ Warning:** Do not allow children to play inside the trunk or become locked inside. An unrestrained child could suffer serious injury or death in a crash. A child could suffer heat exhaustion if trapped in the vehicle, especially without climate control on.



Opening

To open the front trunk:

1. Ensure that the area around the hood is free of obstacles.
2. Touch the associated **OPEN** button on the touchscreen or touch the front trunk button on the mobile app.
3. Pull the hood up.

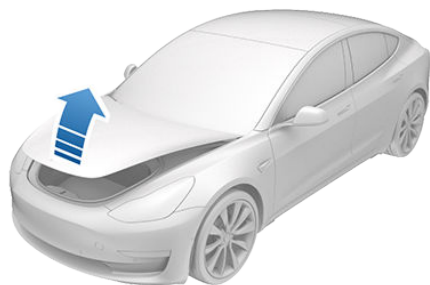

When a door or trunk is open, the touchscreen displays the Door Open indicator light.

Warning: Before opening or closing the hood, it is important to check that the area around the hood is free of obstacles (people and objects). Failure to do so may result in damage or serious injury.

Note: The front trunk locks whenever closed and you lock Model 3 using the touchscreen, mobile app, key card, you leave Model 3 carrying your authenticated phone (if Walk-Away Lock is turned on), or if Valet mode is active (see [Valet Mode](#) on page 33).

Closing

The Model 3 hood is not heavy enough to latch under its own weight and applying pressure on the front edge or center of the hood can cause damage.

To properly close the hood:

1. Lower the hood until the striker touches the latches.
2. Place both hands on the front of the hood in the areas shown (in green), then press down firmly to engage the latches.
3. Carefully try to lift the front edge of the hood to ensure that it is fully closed.

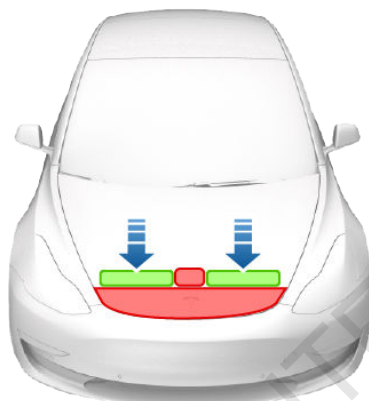

Caution: To prevent damage:

- Apply pressure only to the green areas shown. Applying pressure to the red areas can cause damage.
- Do not close the hood with one hand. Doing so applies concentrated force in one area and can result in a dent or crease.
- Do not apply pressure to the front edge of the hood. Doing so can crease the edge.
- Do not slam or drop the hood.

Warning: Before driving, you must ensure that the hood is securely latched in the fully closed position by carefully trying to lift the front edge of the hood upward and confirming there is no movement.

Interior Emergency Release

An illuminated interior release button inside the front trunk allows a person locked inside to get out.



Press the interior release button to open the front trunk, then push up on the hood.



Note: The interior release button glows following a brief exposure to ambient light.

- ⚠ Warning:** People should never climb inside the front trunk. Never shut the front trunk when a person is inside.
- ⚠ Warning:** Care should be taken to ensure that objects inside the front trunk do not bump against the release button, causing the trunk to accidentally open.

Opening with No Power

In the unlikely event that Model 3 has no 12V power, you will be unable to open the front trunk using the touchscreen or mobile app. To open the front trunk in this situation:

1. Locate an external 12V power supply (such as a portable jump starter).
2. Release the tow eye cover by pressing firmly on the top right perimeter of the cover until it pivots inward, then gently pulling the raised section toward you.

Note: The tow eye cover is connected to the vehicle's red positive (+) terminal.

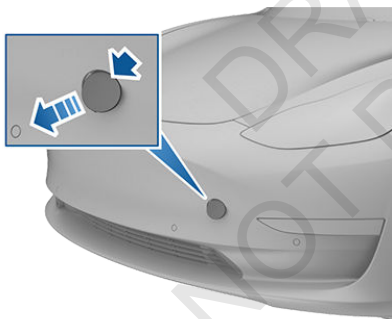

3. Pull the two wires out of the tow eye opening to expose both terminals.

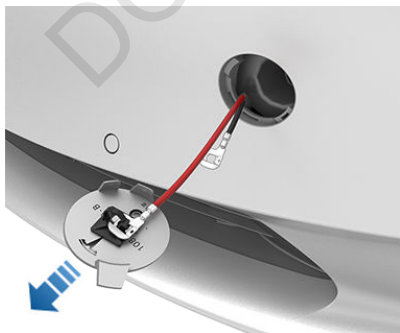

4. Connect the 12V power supply's red positive (+) cable to the red positive (+) terminal.
5. Connect the 12V power supply's black negative (-) cable to the black negative (-) terminal.



Note: Applying external 12V power to these terminals only releases the hood latches. You cannot charge the 12V battery using these terminals.

6. Turn on the external power supply (refer to the manufacturer's instructions). The hood latches are immediately released and you can now open the hood to access the front trunk area.
7. Disconnect both cables, beginning with the black negative (-) cable.
8. If pulling Model 3 onto a flatbed truck, do not replace the tow eye cover yet. Otherwise, replace the tow eye cover by inserting the wires into the tow eye opening and aligning the tow eye cover into position and turning it into place.





Glovebox

To open the glovebox, touch **Controls** > **Glovebox** on the bottom corner of the touchscreen. The glovebox automatically opens and its light turns on.

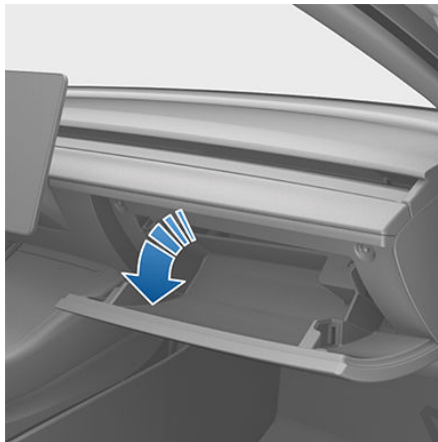

To close the glovebox, push it upward until it clicks into its closed position.

Note: If you leave the glovebox open for approximately five minutes, its light automatically turns off.

Note: The glovebox locks whenever closed and you lock Model 3 using the mobile app, key card, you leave Model 3 carrying your authenticated phone (if Walk-Away Lock is turned on), or if Valet mode is active (see [Valet Mode](#) on page 33). It does not lock when Model 3 is locked by touching the lock icon on the touchscreen.

Warning: When driving, keep the glovebox closed to prevent injury to a passenger if a collision or sudden stop occurs.

12V Power Socket

Your Model 3 has a power socket located in the center console's rear compartment. Power is available whenever the touchscreen is powered on.

The power socket is suitable for accessories requiring up to 12A continuous draw (16A peak).

Warning: The power socket and an accessory's connector can become hot.

Caution: Do not attempt to jump start Model 3 using the 12V power socket. Doing so can result in damage.

Rear Console

Your Model 3 has a rear console integrated in the center of the rear seat back. Pull the console down to access the rear cup holders, or use it as an armrest.



Coat Hangers

Your Model 3 has a coat hanger on each side of the vehicle in the rear row. Push the coat hanger to release it. Push it again to retract it.



Additional Interior Storage Areas

Your Model 3 has these additional storage areas:

- Storage compartments are located below the armrest on the door panels.



Correct Driving Position

The seat, head support, seat belt and airbags work together to maximize your safety. Using these correctly ensures greater protection.



Position the seat so you can wear the seat belt correctly, while being as far away from the front airbag as possible:

1. Sit upright with both feet on the floor and the seat back reclined no more than 30 degrees.
2. Make sure you can easily reach the pedals and that your arms are slightly bent when holding the steering wheel. Your chest should be at least 10 inches (25 cm) from the center of the airbag cover.
3. Place the shoulder section of the seat belt mid-way between your neck and your shoulder. Fit the lap section of the belt tightly across your hips, not across your stomach.

Model 3 seats include integrated head supports that cannot be adjusted or removed.

Folding Rear Seats

Model 3 has a split rear seat that can fold forward.

Before folding, remove items from the seats and the rear footwell. To allow the rear seat backs to fold completely flat, you may need to move the front seats forward.

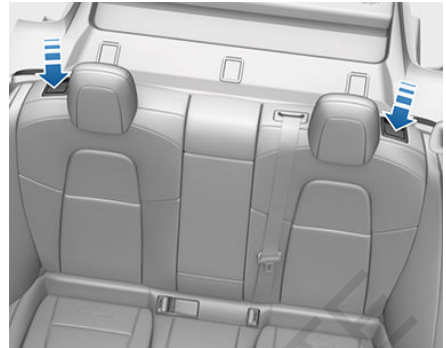

To fold a rear seat, pull the corresponding lever and fold the seat forward.



Raising Rear Seats

Before raising a rear seat, make sure that the seat belts are not trapped behind the backrest.

Pull the seat back upward until it locks into place.

To confirm that the seat back is locked in the upright position, try pulling it forward.

⚠ Warning: Always ensure the seat backs are locked in their upright position. Failure to do so increases the risk of injury.



Head Supports

The front seats and outer rear seats include integrated head supports that are not adjustable.

The rear center seat includes an adjustable head support that can be raised, lowered, or removed. The head support should always be raised and locked into position (so that the center is aligned with the center of the ears) when occupied by a passenger that is not in a child safety seat.



The head support in the rear center seat should always be lowered when a seat belt retained child safety seat is installed. See [Raising/Lowering the Rear Center Head Support](#) on page 18.

Warning: Ensure that all head supports are positioned correctly before sitting in, or operating, Model 3 to minimize the risk of severe injury or death in the event of a collision.

Raising/Lowering the Rear Center Head Support

To raise the head support, lift it until you hear it click into place. Push down on the head support to ensure that it is secure.

To lower the head support, press and hold the button on the outer base of the right post and press the head support down.

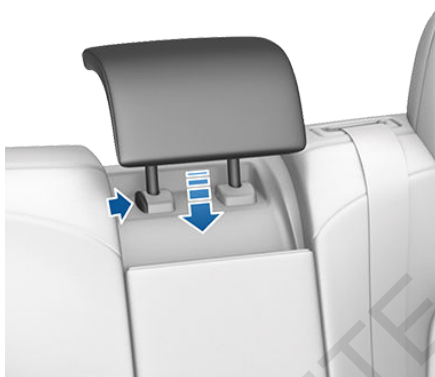

Removing/Installing the Rear Center Head Support

To remove the head support:

1. Raise the head support (see [Raising/Lowering the Rear Center Head Support](#) on page 18).
2. Press and hold the button on the outer base of the right post.
3. Insert a short, flat object (such as a small flat head screwdriver) into the opening on the inside base of the left post and pull the head support upwards.



To install the head support:

1. With the front of the head support facing forward, insert both posts into the corresponding holes on the backrest.
2. Press down on the head support until you hear it click into place.
3. Pull up on the head support to ensure that it is secure.

Warning: Ensure that the head support is installed properly before anyone occupies the rear center seat. Failure to do so increases the risk of injury or death if a collision occurs.



Seat Heaters

The front seats are equipped with heating pads that operate at three levels from 3 (highest) to 1 (lowest). To operate the seat heaters, see [#unique_84](#).

- Warning:** To avoid burns resulting from prolonged use, individuals who have peripheral neuropathy, or whose capacity to feel pain is limited because of diabetes, age, neurological injury, or some other condition, should exercise caution when using the climate control system and seat heaters.

Seat Covers

- Warning:** Do not use seat covers in Model 3. Doing so could restrict deployment of the seat-mounted side air bags if a collision occurs. It can also reduce the accuracy of the occupant detection system.

DRAFT
DO NOT DISTRIBUTE



Wearing Seat Belts

Using seat belts and child safety seats is the most effective way to protect occupants if a collision occurs. Therefore, wearing a seat belt is required by law in most jurisdictions.

Both the driver and passenger seats are equipped with three-point inertia reel seat belts. Inertia reel belts are automatically tensioned to allow occupants to move comfortably during normal driving conditions. To securely hold child safety seats, all passenger seating positions are equipped with an automatic locking retractor (ALR) that, by pulling the seat belt beyond the length needed for a typical adult occupant, locks the belt into place until the seat belt is unbuckled (see [Installing Seat Belt Retained Child Seats](#) on page 25).

The seat belt reel automatically locks to prevent movement of occupants if Model 3 experiences a force associated with hard acceleration, braking, cornering, or an impact in a collision.



The seat belt reminder on the touchscreen alerts you if a seat belt for an occupied seat is not fastened. If the belt remains unfastened, the reminder flashes and an intermittent chime sounds. If all occupants are buckled up and the reminder stays on, re-fasten seat belts to ensure they are correctly latched. Also remove any heavy objects (such as a briefcase) from an unoccupied seat. If the reminder light continues to stay on, contact Tesla.

To Fasten a Belt

1. Ensure correct positioning of the seat.
2. Draw the belt out smoothly, ensuring the belt lays flat across the pelvis, chest and mid-point of your collar bone, between the neck and shoulder.

3. Insert the latch plate into the buckle and press together until you hear a click indicating it is locked in place.

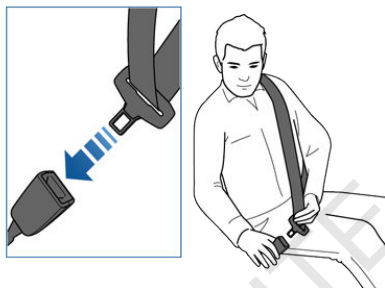

4. Pull the belt to check that it is securely fastened.
5. Pull the diagonal part of the belt toward the reel to remove excess slack.

To Adjust the Shoulder Anchor Height

Model 3 is equipped with an adjustable shoulder anchor for each front seat to ensure that the seat belt is positioned correctly. The seat belt should lay flat across the mid-point of your collar bone while in the correct driving position. Adjust the height of the shoulder anchor if the seat belt is not positioned correctly:

1. Press and hold the button on the shoulder anchor to release the locking mechanism.
2. While holding the button, move the shoulder anchor up or down as necessary so that the seat belt is positioned correctly.

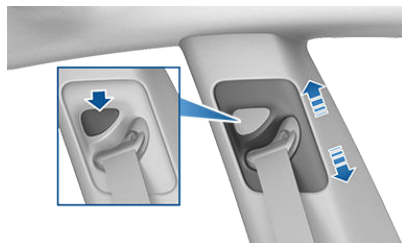

3. Release the button on the shoulder anchor so that it locks into position.
4. Without pressing the button, pull on the seat belt webbing and attempt to move the shoulder anchor downwards to check that it is locked into position.

- ⚠ Warning:** Ensure that the seat belt is positioned correctly and that the shoulder anchor is locked into position before driving. Riding in a moving vehicle with the seat belt positioned incorrectly or with the shoulder anchor not locked into position can reduce the effectiveness of the seat belt in a collision.

To Release a Belt

Hold the belt near the buckle to prevent the belt from retracting too quickly, then press the button on the buckle. The belt retracts automatically. Ensure there is no obstruction that prevents the belt from fully retracting. The belt should not hang loose. If a seat belt does not fully retract, contact Tesla.

Wearing Seat Belts When Pregnant

Do not put the lap or shoulder sections of the seat belt over the abdominal area. Wear the lap section of the belt as low as possible across the hips, not the waist. Position the shoulder portion of the belt between the breasts and to the side of the abdomen. Consult your doctor for specific guidance.



- ⚠ Warning:** Never place anything between you and the seat belt to cushion the impact in the event of a collision.

Seat Belt Pre-tensioners

The front seat belts are equipped with pre-tensioners that work in conjunction with the airbags in a severe frontal collision. The pre-tensioners automatically retract both the seat belt anchor and the seat belt webbing, reducing slack in both the lap and diagonal portions of the belts, resulting in reduced forward movement of the occupant.

The rear outboard seats are equipped with shoulder pre-tensioners to retract the seat belt webbing to reduce forward movement of the occupant.

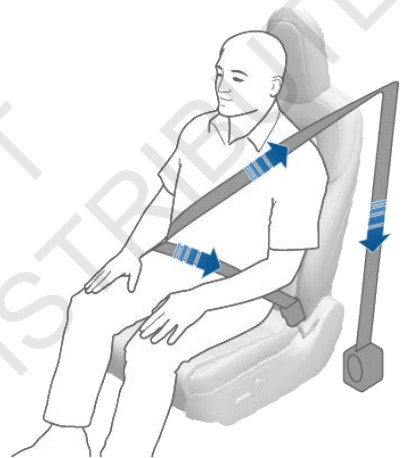

If the pre-tensioners and airbags did not activate in an impact, this does not mean they malfunctioned. It usually means that the strength or type of force needed to activate them was not present.

- ⚠ Warning:** Once the seat belt pre-tensioners have been activated, they must be replaced. After any collision, have the airbags, seat belt pre-tensioners and any associated components checked and, if necessary, replaced.

Testing Seat Belts

To confirm that seat belts are operating correctly, perform these three simple checks on each seat belt.

1. With the seat belt fastened, give the webbing nearest the buckle a quick pull. The buckle should remain securely locked.



2. With the belt unfastened, unreel the webbing to its limit. Check that unreeling is free from snags, and visually check the webbing for wear. Allow the webbing to retract, checking that retraction is smooth and complete.
3. With the webbing half unreeled, hold the tongue plate and pull forward quickly. The mechanism should lock automatically and prevent further unreeling.

If a seat belt fails any of these tests, contact Tesla immediately.

Seat Belt Warnings

- Warning:** Seat belts should be worn by all occupants at all times, even if driving for a very short distance. Failure to do so increases the risk of injury or death if a collision occurs.
- Warning:** Secure small children in a suitable child safety seat. Always follow the child safety seat manufacturer's instructions when installing.
- Warning:** Ensure that all seat belts are worn correctly. An improperly worn seat belt increases the risk of injury or death if a collision occurs.
- Warning:** Do not wear seat belts over hard, fragile or sharp items in clothing, such as pens, keys, eyeglasses, etc. The pressure from the seat belt on such items can cause injury.
- Warning:** Seat belts should not be worn with any part of the strap twisted.
- Warning:** Each seat belt assembly must be used by one occupant only. It is dangerous to put a seat belt around a child being carried on an occupant's lap.
- Warning:** Seat belts that have been worn in a collision must be inspected or replaced by Tesla, even if damage to the assembly is not obvious.
- Warning:** Seat belts that show signs of wear (such as fraying), or have been cut or damaged in any way, must be replaced by Tesla.
- Warning:** Avoid contaminating a seat belt's components with any chemicals, liquids, grit, dirt or cleaning products. If a seat belt fails to retract or latch into the buckle, it must be replaced immediately. Contact Tesla.

- Warning:** Do not make modifications or additions that can prevent a seat belt mechanism from taking up slack, or that can prevent a seat belt from being adjusted to remove slack. A slack belt greatly reduces occupant protection.
- Warning:** Do not make modifications that can interfere with the operation of a seat belt, or that can cause a seat belt to become inoperable.
- Warning:** When seat belts are not in use, they should be fully retracted and not hanging loose. If a seat belt does not fully retract, contact Tesla.



Guidelines for Seating Children

Your Model 3 seat belts are designed for adults and larger children. You must restrain infants and small children in the rear row seats only, and you must use a suitable child safety seat appropriate for the child's age, weight, and size.

Never use child safety seats in the front row passenger seat.

Warning: Never seat a child on a seat with an ACTIVE AIRBAG in front of it. DEATH or SERIOUS INJURY to the child can occur.

Refer to the following label fitted to the sun visors.

Note: The image shown below is representative only and may not be identical to the label in your vehicle.





Choosing a Child Safety Seat

All children age 12 and under should ride in the rear (second row) seats. Always use a child safety seat suitable for a young child's age and weight.

	Infants	Toddlers	Young children
Age	Birth to 1 year*	Over 1 year*	4 years and older, and less than 57 in. (145 cm) tall
Weight	Up to at least 20 lbs (9 kg)*	Over 20 lbs (9 kg) (minimum) and up to 40 lbs (18 kg)*	Over 40 lbs (18 kg)
Type of child safety seat	Rear facing (or convertible)	Forward facing (or convertible)*	Seat belt retained booster seat
Seat position	Rear facing only*	Forward facing*	Forward facing
Recommended attachment method	If combined weight of child and safety seat is up to 65 lbs (29 kg), attach using either LATCH** (lower anchor only) or the seat belt only.*** If combined weight of child and safety seat is over 65 lbs (29 kg), attach using the seat belt only.***	If combined weight of child and safety seat is up to 65 lbs (29 kg), attach using either LATCH** (both lower anchors and top tether anchor), or the seat belt and upper tether strap.*** If combined weight of child and safety seat is over 65 lbs (29 kg), attach using the seat belt and upper tether strap.***	Attach booster seats using the seat belt only.
<p>* Many child safety seats currently available allow children to ride rear-facing using the child safety seat's integrated 5-point harness for a longer period of time BASED UPON SPECIFIC HEIGHT AND WEIGHT LIMITS. Keep your child in a rear facing seat for as long as possible. CHECK THE CHILD SAFETY SEAT MANUFACTURER'S INSTRUCTIONS AND CAREFULLY FOLLOW ALL INSTRUCTIONS</p> <p>** LATCH - Lower Anchors and Tethers for Children. In Canada, this is also called Lower Universal Anchorage System (LUAS), or CANFIX.</p> <p>*** Subject to instructions provided by the child safety seat manufacturer.</p>			

Warning: Laws that govern how and where children should be carried when traveling in a vehicle are subject to change. It is the driver's responsibility to keep up to date on, and comply with, all current regulations in the region(s) where Model 3 is driven. To check the child passenger safety laws for states in the U.S., go to: http://www.ghsa.org/html/stateinfo/laws/childsafety_laws.html.



Seating Larger Children

If a child is too large to fit into a child safety seat, but too small to safely fit into the standard seat belts, use a booster seat appropriate for the child's age and size. Carefully follow the manufacturer's instructions to secure the booster seat.

Installing Child Safety Seats

There are two general methods used to install child safety seats:

- Seat belt retained - these seats are secured using the vehicle's seat belts (see [Installing Seat Belt Retained Child Seats](#) on page 25).
- LATCH retained - these seats can attach to anchor bars built into the vehicle's rear seats (see [Installing LATCH Child Seats](#) on page 25).

Check the child safety seat manufacturer's instructions and the table at [Child Safety Seats](#) on page 23 to determine which installation method to use. Some child safety seats can be installed using either method. Always follow the child safety seat manufacturer's instructions.

Installing Seat Belt Retained Child Seats

First, make sure that the child safety seat is appropriate for the weight, height, and age of the child.

Avoid dressing the child in bulky clothing and do not place any objects between the child and the restraint system.

Adjust harnesses for every child, every trip.

To securely hold child safety seats, all passenger seating positions are equipped with an automatic locking retractor (ALR) that, by pulling the seat belt beyond the length needed for a typical adult occupant, locks the belt into place until the seat belt is unbuckled and the webbing is fully retracted. The ALR mechanism operates as a ratchet, winding in slack and preventing the seat belt from extending any further until it has been completely rewound. When installing a child safety seat, engage the belt's automatic locking retractor by pulling the seat belt webbing until it is fully extended. The ALR system engages only when the seat belt is at its maximum extension point.

Note: An automatic locking retractor disengages only when the seat belt is unbuckled and fully retracted. The belt can then be worn as a normal belt, sliding freely in and out and locking tight only in an emergency. Once disengaged, the belt must be fully extended to re-engage the locking mechanism whenever you install a child safety seat.

Always follow the detailed instructions provided by the child safety seat manufacturer. General guidelines are provided below.

1. Place the child safety seat in Model 3, and fully extend the seat belt. Route and buckle the seat belt in accordance with the child safety seat manufacturer's instructions.

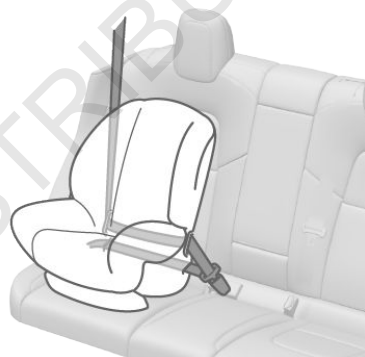

2. Allow the seat belt to retract, and remove all slack in the seat belt while firmly pushing the child safety seat into the Model 3 seat.
3. If the seat belt retained child safety seat has an upper tether, attach it to the back of the seat (see [Attaching Upper Tether Straps](#) on page 26).

Installing LATCH Child Seats

Lower LATCH anchors are provided in the second row outboard seats. The anchors are located between the seat's back rest and rear cushion. The exact location of each anchor is identified by a child safety seat identification button, illustrated below. The button is located on the seat back, directly above its associated anchor.



Install LATCH child safety seats in the outboard seating positions only. Use only a seat belt retained seat in the center position.

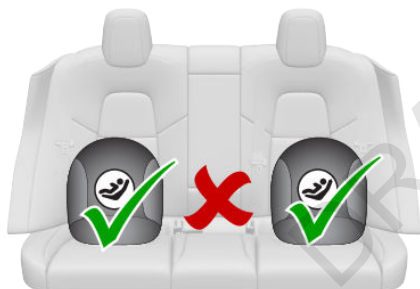

To install a LATCH child safety seat, slide the safety seat latches onto the anchor bars until they click into place. Carefully read and follow the instructions provided by the child safety seat manufacturer.



Once installed, test the security of the installation before seating a child. Attempt to twist the child safety seat from side to side and try to pull it away from the seat, then check to ensure the anchors remain securely in place.

Note: Lower LATCH anchors should not be used with child seats or booster seats that have an integrated safety belt in situations where the combined weight of the child plus the child restraint is more than 65 lbs (29 kg). In these situations, use the safety belt instead.

Attaching Upper Tether Straps

If an upper tether strap is provided, attach its hook to the anchor point located on the shelf behind the rear seating positions.

Warning: Tighten upper tether straps according to the instructions provided by the manufacturer of the child safety seat.

Warning: USE ONLY SEAT BELT RETAINED CHILD SAFETY SEATS IN THE CENTER SEATING POSITION.

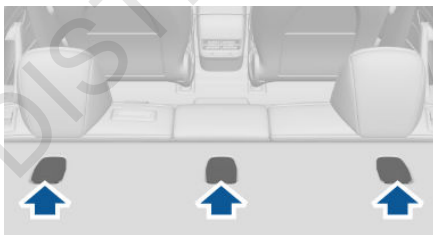

To access an anchor point, press down on the back of its cover.

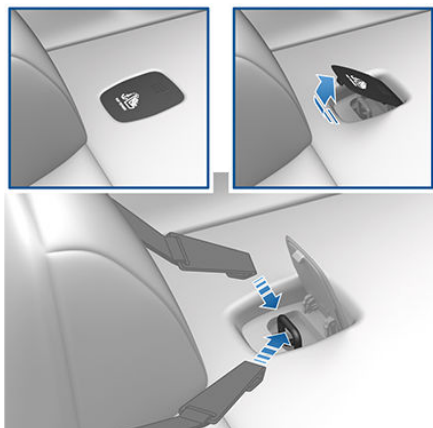



For dual-strap tethers, position a strap on each side of the head support.

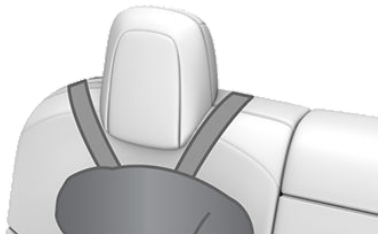

For single-strap tethers at the outboard seating positions, run the strap over the outside-facing side of the head support (i.e. same side of the head support as the seat belt retraction mechanism).

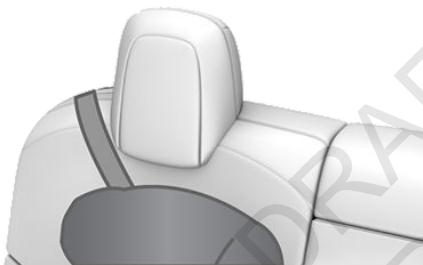

For a single-strap tether in the center seating position, fully lower the head support (see [Raising/Lowering the Rear Center Head Support](#) on page 18) and run the strap over the top center of the head support.

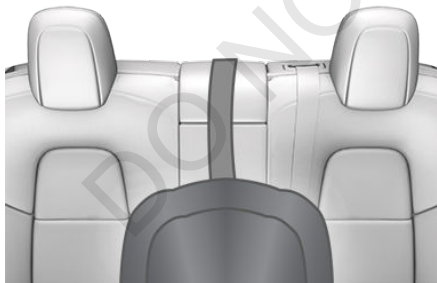

Testing a Child Safety Seat

Before seating a child, always make sure the child safety seat is not loose:

1. Hold the child safety seat by the belt path and try to slide the safety seat from side to side and front to back.





2. If the seat moves more than one inch (2.5 cm), it is too loose. Tighten the belt or reconnect the LATCH retained child safety seat.
3. If you are unable to reduce slack, try a different seat location or try another child safety seat.

Child Safety Seat Warnings

- ⚠ Warning:** Extreme hazard! Do not seat a child on the front passenger seat even if you are using a child safety seat. This seat has an airbag in front of it. Although this airbag is disabled when Model 3 detects a lightweight passenger, do not rely on technology to protect your child.
- ⚠ Warning:** Child restraint systems are designed to be secured in vehicle seats by lap belts or the lap belt portion of a lap-shoulder belt. Children could be endangered in a crash if their child restraints are not properly secured in the vehicle.
- ⚠ Warning:** According to collision statistics, children are safer when properly restrained in the rear seating positions than in the front seating positions.
- ⚠ Warning:** Do not use a forward facing child safety seat until your child weighs over 20 lbs (9 kg) and can sit independently. Up to the age of two, a child's spine and neck are not sufficiently developed to avoid injury in a frontal impact.
- ⚠ Warning:** Do not allow a baby or infant to be held on a lap. All children should be restrained in an appropriate child safety seat at all times.
- ⚠ Warning:** To ensure children are safely seated, follow all instructions provided in this document and by the manufacturer of the child safety seat.
- ⚠ Warning:** Children should ride in a rear facing child safety seat using the seat's integrated 5-point harness for as long as possible.
- ⚠ Warning:** Do not use seat belt extenders on a seat belt that is being used to install a child safety seat or booster seat.
- ⚠ Warning:** When seating larger children, make sure the child's head is supported and the child's seat belt is properly adjusted and fastened. The shoulder portion of the belt must be away from the



face and neck, and the lap portion must not be over the stomach.

-  **Warning:** Never attach two child safety seats to one anchor point. In a collision, one anchor point may be incapable of securing both seats.
-  **Warning:** Child restraint anchors are designed to withstand only those loads imposed by correctly fitted child restraints. Under no circumstances are they to be used for adult seat belts, harnesses, or for attaching other items or equipment to the vehicle.
-  **Warning:** Always check harnesses and tether straps for damage and wear.
-  **Warning:** Never leave a child unattended, even if the child is secured in a child safety seat.
-  **Warning:** Never use a child safety seat that has been involved in a collision. Have the seat inspected or replaced as described in the child safety seat manufacturer's instructions.

DRAFT
DO NOT DISTRIBUTE



Location of Airbags

Airbags are located in the approximate areas shown here. Airbag warning information is printed on the sun visors.

Model 3 is equipped with an airbag and lap/shoulder belt at both front outboard seating positions. The airbag is a supplemental restraint at those seating positions. All occupants, including the driver, should always wear their seat belts whether or not an airbag is also provided at their seating position to minimize the risk of severe injury or death in the event of a crash.

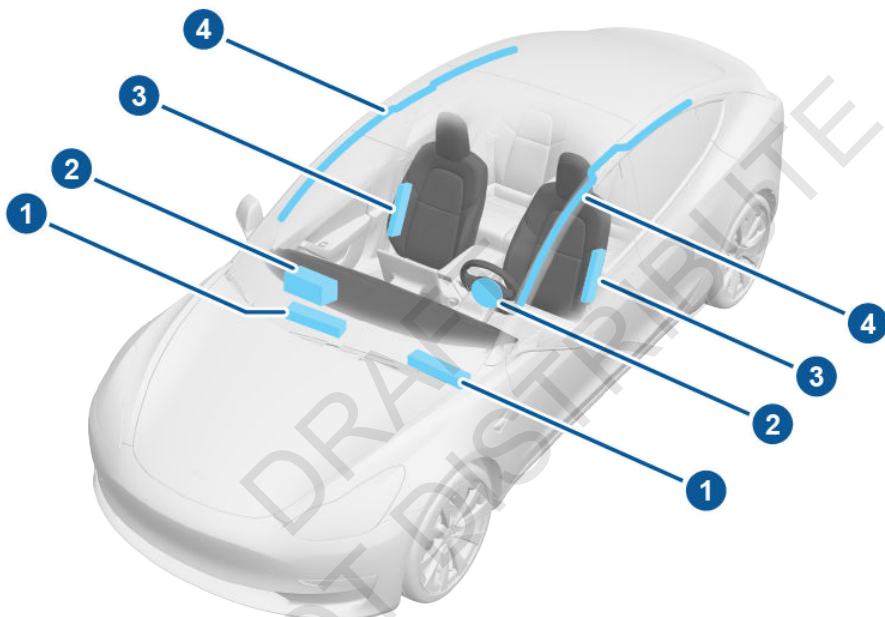

1. Knee airbags
2. Front airbags
3. Seat-mounted side airbags
4. Curtain airbags



How the Airbags Work

Airbags inflate when sensors detect an impact that exceeds deployment thresholds. These thresholds are designed to predict the severity of a crash in time for the airbags to help protect the vehicle's occupants.

Airbags inflate instantly with considerable force accompanied by a loud noise. The inflated bag, together with the seat belts, limits movement of occupants to reduce the risk of injury.

Front airbags are not ordinarily designed to inflate in rear collisions, rollovers, minor front or side collisions, heavy braking, or driving over bumps and potholes. Therefore, significant superficial damage can occur to the vehicle without the airbags inflating or, conversely, a relatively small amount of structural damage can cause airbags to inflate.

If you are planning to modify your vehicle for a person with disabilities in a way that may affect the airbag system, contact Tesla.

Types of Airbags

Model 3 has the following types of airbags:

- **Advanced front airbags:** The front airbags are designed to reduce airbag related injuries if children or small adults are riding in the front seats. On the driver's side, the front airbag works with a seat position sensor that adjusts the inflation level based on the seating position of the occupant. On the passenger's side, the airbag responds to a sensing system in the seat that determines whether or not the passenger side front airbag inflates, and optimizes the inflation level based on the weight of the occupant. Follow all warnings related to seating a child on the front passenger seat.
- **Knee airbags:** Knee airbags and the front airbags work together. The knee airbags limit the forward motion of the front seat occupants by restricting leg movement, thereby positioning the occupants so that the front airbags work more effectively.
- **Seat-mounted side airbags:** There is a seat-mounted side airbag in the front seats. Seat-mounted side airbags protect the thorax region of the torso and the pelvis. They inflate in the event of severe side impact or severe offset frontal impact. The seat-mounted side airbags on both the impacted and non-impacted side of the vehicle will inflate. When the backrest of an outboard seat is fully folded in the forward position, its associated side airbag does not inflate.
- **Curtain airbags:** Curtain airbags help protect the head and typically inflate only if a severe side impact occurs, or if the vehicle rolls over. Curtain airbags on both the impacted and non-impacted side of the vehicle will inflate.



Passenger Front Airbag

Model 3 has an occupancy sensor in the front passenger seat that controls the status of the airbags based on the weight of the occupant. If the passenger airbag is OFF, it will not inflate when a collision occurs, and the passenger airbag off indicator displays in the top right corner of the touchscreen. If the passenger airbag is ON, it will inflate when a collision occurs, and its status does not display in the top right corner of the touchscreen.

PASSENGER
AIRBAG OFF

The Passenger Airbag Off indicator displays in the top right corner of the touchscreen only when the front passenger airbag is turned off.

Note: The occupancy sensor system meets the regulatory requirement of FMVSS 208 and automatically detects when inflating the passenger front airbags would be unnecessary or potentially harmful.

Weight in front passenger seat	Passenger airbag status
Empty	OFF
Up to 20 lbs/9 kg	OFF
20-100 lbs/9-45 kg*	OFF* or ON**
Over 100 lbs/45 kg	ON**
<p>*Values are approximate. A weight detected near the threshold can cause the airbag status to occasionally turn on and off depending on seating position and physique.</p> <p>**The absence of the passenger airbag off indicator in the top right corner of the touchscreen indicates that the passenger airbag is ON and will inflate in the event of a collision.</p>	

Note: It takes approximately six seconds after you power on Model 3 for the occupancy sensor to report accurate status of the front passenger airbag. As a result, when you first power on Model 3, even in situations when it should be OFF because the passenger seat is either empty or carrying a weight of 20 lbs (9 kg) or less, the touchscreen can take up to six seconds to display the passenger airbag off indicator. If it fails to do so, contact Tesla

service immediately and seat passengers in the rear seating positions only.

If the passenger airbag is permanently off, even when the seat is empty, contact Tesla immediately.

To make sure the sensing system can correctly detect occupancy status, eliminate the following:

- Objects lodged under the seat.
- Heavy objects sitting on the seat (briefcase, large purse).
- Objects wedged between the seat back and seat cushion.
- Cargo interfering with the seat.
- After market items attached to, or sitting on, the seat (covers, mats, blankets, etc.).

These conditions can interfere with the occupancy sensor. If you have eliminated the above possibilities, and the airbag status is still incorrect, ask passengers to ride in the rear seats and contact Tesla to have the airbag system checked.

Note: The front passenger seat's sensing system affects the operation of the passenger front and side airbags only. The other passenger airbags are not affected.

Warning: Never seat a child on the front passenger seat, even if the passenger airbag is off. All occupants age 12 and under must ride in the rear seats (see [Child Safety Seats](#) on page 23).

Warning: To ensure accuracy of the occupant detection system, do not make any modifications to the front passenger seat.

Warning: Do not use seat covers on Model 3. Doing so could restrict deployment of the seat-mounted side airbags if a collision occurs. It can also reduce the accuracy of the occupant detection system, if equipped.

Inflation Effects

Warning: When airbags inflate, a fine powder is released. This powder can irritate the skin and should be thoroughly flushed from the eyes and from any cuts or abrasions.

After inflation, the airbags deflate to provide a gradual cushioning effect for the occupants and to ensure the driver's forward vision is not obscured.



If airbags have inflated, or if your vehicle has been in a collision, your vehicle requires servicing before it will power up. In addition, your airbags, seat belt pre-tensioners and any associated components must be checked, and if necessary, replaced. Contact Tesla Service immediately.

In a collision, in addition to the airbags inflating:

- Doors unlock.
- Hazard warning lights turn on.
- Interior lights turn on.
- High voltage is disabled.

Note: In some collision situations, even if airbags have not inflated, your vehicle's high voltage Battery may be disabled and you will be unable to power up and drive. Contact Tesla Service immediately.

Airbag Warning Indicator



The airbag indicator on the touchscreen remains lit if the airbag system is malfunctioning. The only time this indicator should light up is briefly when Model 3 first powers up, in which case it turns off within a few seconds. If it remains lit, contact Tesla immediately and do not drive.

Airbag Warnings

- Warning:** Do not place objects over or near airbags because any such objects could cause harm if the vehicle is in a crash severe enough to cause the airbag to inflate.
- Warning:** All occupants, including the driver, should always wear their seat belts, whether or not an airbag is also provided at their seating position, to minimize the risk of severe injury or death in the event of a collision.
- Warning:** Front seat occupants should not place their arms over the airbag module, as an inflating airbag can cause fractures or other injuries.
- Warning:** Airbags inflate with considerable speed and force, which can cause injury. To limit injuries, ensure that occupants are wearing seat belts and are correctly seated, with the seat positioned as far back as possible. The National Highway Traffic Safety Administration (NHTSA) recommends a minimum

distance of 10" (25 cm) between an occupant's chest and an airbag.

- Warning:** Do not use a child safety seat or seat young children on a seat with an operational airbag in front of it. Doing so can cause injury or death if the airbag inflates.
- Warning:** To ensure correct inflation of the side airbags, maintain an unobstructed gap between an occupant's torso and the side of Model 3.
- Warning:** Passengers shouldn't lean their heads against doors. Doing so can cause injury if a curtain airbag inflates.
- Warning:** Do not allow passengers to obstruct the operation of an airbag by placing feet, knees or any other part of the body on or near an airbag.
- Warning:** Do not attach or place objects on or near the front airbags, the side of the front seats, the headliner at the side of the vehicle, or any other airbag cover that could interfere with inflation of an airbag. Objects can cause serious injury if the vehicle is in a collision severe enough to cause the airbag to inflate.
- Warning:** Following inflation, some airbag components are hot. Do not touch until they have cooled.



Creating a Driver Profile

When you first adjust the driver's seat, steering wheel, or driver's side mirror, the touchscreen prompts you to create a driver profile to save these adjustments. Your profile also saves some of the preferences you make using the touchscreen's Controls windows.



To add a new driver profile, touch the driver profile icon at the top of the touchscreen. Then touch **Add New Driver**, type the driver's name and touch **Create Profile**. Follow the onscreen instructions to save the seating position to the driver profile. You can also check the **Use Easy Entry** checkbox if you want to save (or use existing) Easy Entry settings in which the driver's seat and the steering wheel are automatically adjusted to make it easy to enter and exit Model 3.

If you change the position of the steering wheel, driver's seat, or driver's side mirror after you have saved or chosen a driver profile, the touchscreen prompts you to save the new position or restore the previously saved position (other settings are automatically saved). To change a setting without saving or restoring, just ignore the prompt.

To adjust Model 3 based on a driver's profile, touch the driver profile icon and choose the driver name. The saved adjustments are automatically made.

Note: Valet mode is a built-in driver profile used to limit speed and restrict access to some Model 3 features (see [Valet Mode](#) on page 33).

Easy Entry

You can define an Easy Entry setting that moves the steering wheel and driver's seat to make it easy to enter and exit Model 3. Any driver can use the Easy Entry setting by associating it with their driver's profile. When the Easy Entry setting is associated with a driver's profile, the steering wheel and driver's seat automatically adjust when the park gear is engaged and the driver's seat belt is unbuckled, allowing an easy exit from the vehicle. When returning to the vehicle and stepping on the brake pedal, settings automatically adjust back to the settings used by the most recent driver profile.

To use **Easy Entry** with a driver profile, ensure the **Use Easy Entry** checkbox is checked.

Restoring a Driver's Profile



To adjust Model 3 based on a driver's profile, touch the driver profile icon on the touchscreen's status bar. Then choose the driver and Model 3 is adjusted based on the settings that have been saved to the chosen driver profile.

See What's Saved

To see what settings are associated with a driver profile, touch the driver profile icon on the touchscreen's status bar. Then touch **See what's saved**. A popup window lists all the settings that are saved to driver profiles.

Note: The settings that are associated with driver profiles may vary depending on the version of software currently installed on your Model 3.

Valet Mode

When Model 3 is in Valet mode, the following restrictions apply:

- Speed is limited to 70 mph (113 km/h).
- Maximum acceleration and power are limited.
- Front trunk and glovebox are locked.
- Home and Work locations are not available in the navigation system.
- Voice commands are disabled.
- Traffic-Aware Cruise Control is disabled
- The Mobile Access setting is disabled.
- HomeLink (if applicable in your market region) is not accessible.
- Driver Profiles are not accessible.
- Summon is disabled.
- The touchscreen does not display the list of keys that can access Model 3 (see [Managing Keys](#) on page 7).
- Wi-Fi and Bluetooth are disabled. When Model 3 is in Valet mode, you cannot pair new Bluetooth devices or view or delete existing paired devices.

Note: If a Bluetooth paired device or a known Wi-Fi network is within operating range (approximately 30 feet or 9 meters) of Model 3 in Valet mode, Model 3 will connect to it.



Starting Valet Mode

With Model 3 in Park, touch the driver profile icon (located next to the Tesla “T” on the touchscreen), then touch **Valet Mode**.

The first time you enter Valet mode, you will be prompted to create a 4-digit PIN that you will use to cancel Valet mode.

When Valet mode is active, the touchscreen displays the word **Valet** above the driving speed and the Valet mode driver profile displays on the touchscreen.

You can also use the mobile app to start and cancel Valet mode (provided Model 3 is in Park). When using the mobile app, you do not need to enter a PIN because you are already required to log into the app using your Tesla Account credentials.

Note: If you forget your PIN, reset it from inside Model 3 by entering your Tesla Account credentials (which also cancels Valet mode). You can also reset your PIN using the mobile app.

Canceling Valet Mode

With Model 3 in Park, touch the **Valet Mode** driver icon on the touchscreen's status bar, then enter your 4-digit PIN.

When you cancel Valet mode, all settings associated with the most recently used driver profile and climate control settings are restored, and all features are available.

Note: You do not need to enter a PIN to cancel Valet mode from the mobile app.



Scroll Buttons

A scroll button is located on each side of the steering wheel. Each button has a wheel that you can roll up or down. You can also press the button straight in, to the right, or to the left, typically using your thumb.

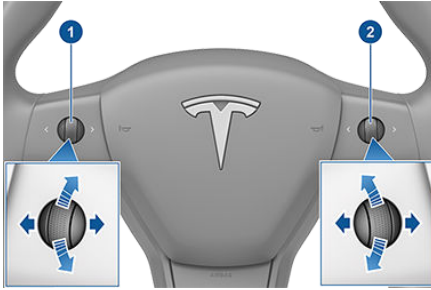

1. Use the left scroll button to:

- Control the volume. Press the scroll button to mute/unmute the volume, roll the scroll wheel up to increase the volume, or down to decrease the volume.

Note: The scroll button adjusts the volume for media, navigation instructions or phone calls based on what is currently in use. As you adjust volume, the touchscreen displays the volume level and whether you are adjusting volume for media, navigation or phone calls.

- Push the scroll button to the right to go to the next/previous song, station, or favorite (depending on what's playing). Push the scroll button to the left to go to the previous.
- Adjust the position of the exterior mirrors (see [Adjusting Exterior Mirrors](#) on page 36).
- Adjust the angle of the headlights (see [Headlight Adjustments](#) on page 43).

2. Use the right scroll button to:

- Speak a voice command. Press the button to initiate a voice command (see [Using Voice Commands](#) on page 99).
- Adjust your set speed and the distance you want to maintain from a vehicle traveling ahead of you (see [Traffic-Aware Cruise Control](#) on page 58).

Note: The arrows associated with the scroll buttons are backlit in low ambient lighting conditions. To turn this backlighting on or off, touch **Controls > Lights > Settings > Steering Wheel Lights**.

To restart the touchscreen, press and hold both scroll buttons until after the touchscreen turns black, releasing when the Tesla logo appears. See [Restarting the Touchscreen](#) on page 37.

Adjusting Steering Effort

You can adjust the feel and sensitivity of the steering system to suit your personal preference:

- On the touchscreen, touch **Controls > Driving > Steering Mode**.
- Choose a steering option:
 - Comfort** - Reduces the effort required to turn the wheel. In town, Model 3 feels easier to drive and park.
 - Standard** - Tesla believes that this setting offers the best handling and response in all conditions.
 - Sport** - Increases the effort required to turn the wheel. When driving at higher speeds, Model 3 feels more responsive.

The only way to really know which option you like best is to try them.

Horn

To sound the horn, press the center pad on the steering wheel.

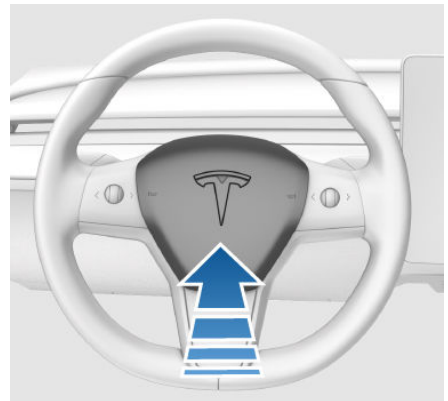



Adjusting Exterior Mirrors

Adjust the exterior mirrors by touching **Controls** > **Quick Controls** > **Mirrors**. You can choose which mirror you would like to adjust by selecting **Left** or **Right** on the touchscreen. Use the left scroll button on the steering wheel to adjust the mirror to its desired position:

Note: In addition to using the touchscreen, you can change which mirror you are adjusting by pressing the left scroll button.

- To move the mirror up or down, roll the left scroll button up or down.
- To move the mirror inward or outward, press the left scroll button to the left or right.

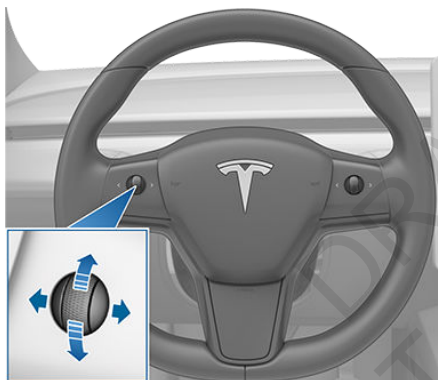

The driver's side mirror automatically dims in low lighting conditions (for example, when driving at night or through a tunnel) in proportion to the level of glare from the headlights of a vehicle behind you (except when in Reverse).

You can fold the mirrors inward for parking in tight spaces by touching **Controls** > **Quick Controls** > **Fold**. The mirrors remain folded until your driving speed reaches 31 mph (50 km/h), or until you touch **Fold** again to unfold the mirrors.

Note: You cannot fold a mirror if your driving speed exceeds 31 mph (50 km/h).

Rear View Mirror

The rear view mirror is adjusted manually. Except when in Reverse, the rear view mirror automatically dims in proportion to the level of glare from the headlights of a vehicle behind you.

Vanity Mirrors

To expose and illuminate the vanity mirror, fold the sun visor downwards, then use the tab to lower the mirror cover. When you close the mirror cover, the light turns off.

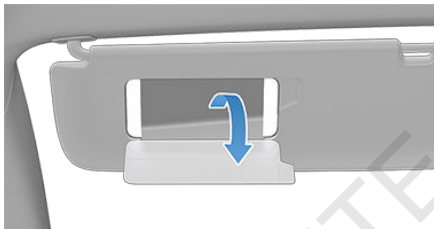



Starting

When you open a door, Model 3 powers on the touchscreen and you can operate all controls.

To drive Model 3:

1. **PRESS THE BRAKE PEDAL** - Model 3 powers on and is ready to drive.
2. **SELECT A GEAR** - Move the gear lever all the way down for Drive and all the way up for Reverse. See [Shifting Gears](#) on page 38.

Everything you need to know when driving Model 3 displays on the touchscreen.

Drive Disabled - Requires Authentication

If Model 3 does not detect a key when you press the brake (an authenticated phone is not detected, or 30 seconds has passed since you used the key card), the touchscreen displays a message telling you that driving requires authentication.

If you see this message, place the key card behind the cup holders on the top of the center console where the RFID transmitter can read it. The 30 second authentication window restarts and you can start Model 3 by pressing the brake pedal.

A number of factors can affect whether Model 3 can detect an authenticated phone (for example, the phone's battery is low or dead and is no longer able to communicate using Bluetooth).

Always keep your authenticated phone and a key card with you. After driving, your authenticated phone or key card is needed to restart Model 3 after it powers off. And when you leave Model 3, you must bring your authenticated phone or key card with you to lock Model 3, either manually or automatically.

Powering Off

When you finish driving, shift into Park by pressing the button on the end of the gear selector. The parking brake automatically engages and all systems keep operating. When you leave Model 3 with your authenticated phone and key card, it powers off automatically, turning off the touchscreen.

Model 3 also powers off automatically after being in Park for 15 minutes, even if you are sitting in the driver's seat.

Although usually not needed, you can power off Model 3 while sitting in the driver's seat, provided the vehicle is not moving. Touch **Controls > Safety & Security > Vehicle Power > Power Off**. Model 3 automatically powers back on again if you press the brake pedal or touch the touchscreen.

Note: Model 3 automatically shifts into Park whenever it is determined that you are exiting the vehicle, even when you shift into Neutral before exiting. To keep Model 3 in Neutral, you will need to activate Transport Mode (see [Instructions for Transporters](#) on page 146).

Restarting the Touchscreen

If your touchscreen is unresponsive or demonstrates unusual behavior, restart it by shifting into Park then pressing and holding both scroll buttons on the steering wheel until the touchscreen turns black, releasing when the Tesla logo appears. Within approximately 30 seconds, the touchscreen restarts. If the touchscreen is still unresponsive or demonstrating unusual behavior, contact Tesla.

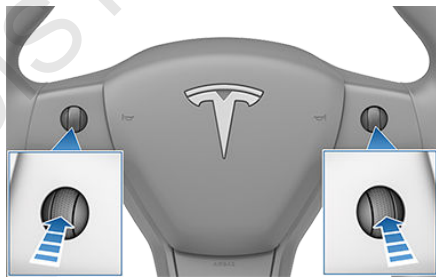

Note: Restarting the touchscreen does not power Model 3 off and on.

⚠ Warning: Paying attention to road and traffic conditions must always be the driver's highest priority. To ensure the safety of vehicle occupants as well as other road users, restarting the touchscreen should be done only when the vehicle is in Park.



Shifting Gears

When Model 3 is in Park, you must press the brake to shift to another gear.

Move the lever up or down to change gears.



If you try to shift into a gear that the current driving speed prohibits, a chime sounds and the gear does not change.

Reverse

Push the lever all the way up and release. You can only shift into Reverse when Model 3 is stopped or moving less than 5 mph (8 km/h). If moving less than 1 mph (1.6 km/h), you must press the brake.

Neutral

Push the lever up or down to the first position and hold it there for more than 1 second to shift into Neutral. Neutral allows Model 3 to roll freely when you are not pressing the brake pedal.

If Model 3 is in Park and you use the touchscreen to release the parking brake (**Controls > Safety & Security**), Model 3 shifts into Neutral (see [Parking Brake](#) on page 47).

Model 3 automatically shifts into Park when you exit. To leave Model 3 in Neutral, use the touchscreen to engage Transport Mode (see [Instructions for Transporters](#) on page 146).

Drive

Push the lever all the way down and release. You can shift into Drive when Model 3 is stopped or moving less than 5 mph (8 km/h) in Reverse. If Model 3 is moving less than 1 mph (1.6 km/h), you must press the brake to shift into Drive.

Note: When in Drive, push the lever all the way down and release to enable Traffic-Aware Cruise Control (see [Traffic-Aware Cruise Control](#) on page 58). Push the lever all the way down twice in quick succession to enable Autosteer (see [Autosteer](#) on page 64).

Park

Press the end of the gear selector while Model 3 is stopped. Whenever Model 3 is in Park, the parking brake is applied.



Model 3 automatically shifts into Park whenever:

- Model 3 determines that you are exiting the vehicle.
- You connect a charge cable.

To make it convenient to pick up passengers, you can also unlock all doors at any time by shifting into Park then pressing the Park button a second time.

Overview

The left side of the touchscreen displays the status of Model 3 at all times. What you see depends on whether the vehicle is:

- Parked (shown below).
- Driving (see [Driving Status](#) on page 40).
- Charging (see [Charging Status and Settings](#) on page 109).

When Model 3 is parked, the status area shows the gear, estimated range, and an overhead view of the car with buttons you can touch to open the trunks and charge port door. When you press the brake, Model 3 powers up and indicator lights flash briefly along the top. Unless an indicator light applies to the current situation (for example, a seat belt is not fastened), it should turn off. If an indicator light fails to turn on or off, contact Tesla.

Note: The following image is provided for demonstration purposes only. Depending on vehicle options, software version, and market region, the information displayed may be slightly different.

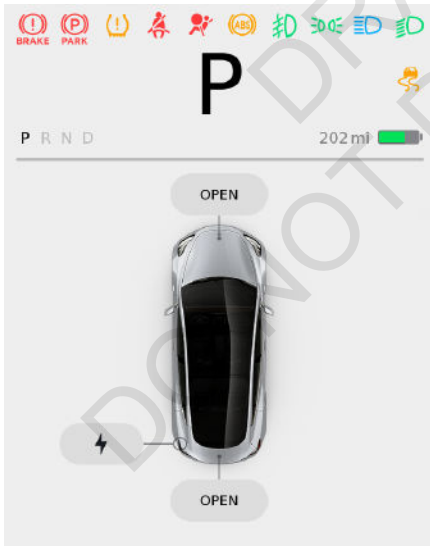

Indicator Lights

The following indicator lights illuminate to advise you or alert you of a specific status or condition.



A brake system fault is detected or the brake fluid level is low. See [Brakes](#) on page 46. Contact Tesla immediately.



The parking brake is manually applied. See [Parking Brake](#) on page 47.



A parking brake fault is detected. Contact Tesla. See [Parking Brake](#) on page 47.



Tire pressure warning. The pressure of a tire is out of range. If a fault with the Tire Pressure Monitoring System (TPMS) is detected, the indicator flashes. View tire pressures in the "Cards" area, located toward the bottom on the left side of the touchscreen, as described in [Touchscreen Overview](#) on page 4. For a TPMS fault, contact Tesla. See [Tire Care and Maintenance](#) on page 113.



A seat belt for an occupied front seat is not fastened. See [Seat Belts](#) on page 20.



Airbag safety. If this indicator does not flash on briefly when Model 3 prepares to drive, or if it remains on, contact Tesla immediately. See [Airbag Warning Indicator](#) on page 32.



An ABS (Anti-lock Braking System) fault is detected. See [Brakes](#) on page 46. Contact Tesla immediately.



Front fog lights (if equipped). See [Lights](#) on page 42.



Parking lights (side marker lights, tail lights, and license plate lights) are on. See [Lights](#) on page 42.



Low beam headlights are on.



High beam headlights are on.



Electronic stability control systems are actively minimizing wheel spin by controlling brake pressure and motor power (indicator flashes). See [Traction Control](#) on page 48. If this indicator stays illuminated, a fault is detected (contact Tesla immediately).



Electronic stability control systems are no longer minimizing wheel spin. See [Traction Control](#) on page 48.



Vehicle Hold is actively applying the brakes. See [Vehicle Hold](#) on page 51.



A door or trunk is open. See [Doors](#) on page 9, [Rear Trunk](#) on page 12, or [Front Trunk](#) on page 14.



Flashes green when the left turn signal is operating. Both turn signal indicators flash green when the hazard warning flashers are operating.



Flashes green when the right turn signal is operating. Both turn signal indicators flash green when the hazard warning flashers are operating.

Driving Status

When Model 3 is driving (or ready to drive), the touchscreen shows your current driving status and a real-time visualization of the road as detected by the Autopilot components (see [About Autopilot](#) on page 55).

Note: The following illustration is provided for demonstration purposes only. Depending on vehicle options, software version, and market region, the information displayed may be slightly different.

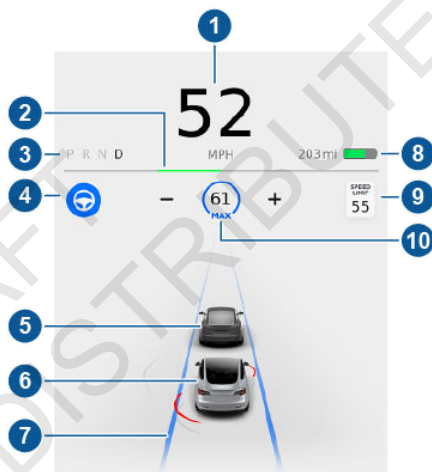

- Driving speed.
- On the energy bar, black (or white in night brightness) represents energy being used during acceleration and green indicates energy being gained through regenerative braking. A dashed line appears on the energy bar when power available for acceleration or power that can be gained by regenerative braking is being limited. Model 3 limits power for many reasons. Here are just a few examples:
 - Acceleration may be limited when the Battery is reaching a low state of charge or if the powertrain is hot.
 - Both acceleration and regenerative braking may be limited when the ambient temperature is either very warm or cool.
 - Regenerative braking may be limited when the Battery is fully charged.
- Currently selected gear: Park, Reverse, Neutral, or Drive.



4. Autosteer (if equipped). When Autosteer is available but you haven't activated it, the icon is gray. When Autosteer is actively steering Model 3, the icon is blue.
5. The car in front of you (if applicable).
6. Your Model 3. Colored lines radiate from the image of your Model 3 as objects are detected (other motorists, guard rails, etc.). The location of the lines correspond to the location of the detected object. The color of the lines (white, yellow, orange, or red) represents the object's proximity to Model 3, with white being the farthest and red being very close and requiring your immediate attention. See [Lane Assist](#) on page 74.
7. When Autosteer is active (if equipped) and detecting the driving lane, the lane is highlighted in blue (see [Autosteer](#) on page 64).
8. Total estimated driving distance (or energy) available. Instead of driving distance, you can display the percentage of battery energy remaining. To do so, touch **Controls > Display > Settings > Energy Display > Energy** (see [Controls and Settings](#) on page 81).

Note: When anticipating when you need to charge, use range estimates as a general guideline only.

Note: In cold weather, some of the stored energy in the Battery may not be available until the Battery warms up. When this happens, a portion of the Battery meter is blue and the driving distance value has a snowflake image next to it. If Model 3 is plugged in, you can heat your Battery using wall power by turning on climate control using the mobile app. When the Battery warms up, the blue portion on the meter and the snowflake image are no longer displayed.
9. The detected speed limit (see [Speed Assist](#) on page 79).
10. The set cruising speed. When Traffic-Aware Cruise Control (if equipped) is available but you haven't set a cruising speed, the icon is gray and the speed is not shown (see [Traffic-Aware Cruise Control](#) on page 58).

 **Warning:** Pay attention to important alert messages that display on the car status window. Ignoring these messages can result in serious injury or death.



Controlling Lights

Touch **Controls** > **Lights** on the touchscreen to control most of the lights.

In addition to the lights that you can control from the touchscreen, Model 3 has convenience lights that operate automatically based on what you are doing. For example, in low ambient lighting conditions, interior lights, marker lights, tail lights, and puddle lights turn on when you unlock Model 3, when you open a door, and when you shift into Park. They turn off after a minute or two or when you shift into a driving gear or lock Model 3.

1. Exterior lights (headlights, tail lights, side marker lights, parking lights, and license plate lights) are set to AUTO each time you start Model 3. When set to AUTO, exterior lights automatically turn on when driving in low lighting conditions. If you change to a different setting, lights always revert to AUTO on your next drive.

Touch one of these options to temporarily change the exterior light setting:

- OFF - Exterior lights turn off until you manually turn them back on or until the next time you drive. If daytime running lights are required in your region, the exterior lights used for this purpose are always on when Drive gear is engaged.
- PARKING - Only the side marker lights, parking lights, tail lights and license plate lights turn on.

Note: If daytime running lights are required in your region, the exterior lights used for this purpose are always on whenever a driving gear (Drive or Reverse) is engaged.

- ON - Exterior lights turn on.

Warning: Always ensure that your headlights are on during low visibility conditions. Failure to do so may result in a collision.

2. If you turn on DOME LIGHTS, all interior dome (map) lights turn on when you unlock Model 3, open a door upon exiting, or shift into P (Park). They turn off after 60 seconds, when you lock Model 3, or when you shift into a driving gear. If set to AUTO, dome lights turn on only when little or no light is detected.

You can also manually turn an individual dome light on or off by pressing its lens. If you manually turn a dome light on, it turns off when Model 3 powers off. If Model 3 was already powered off when you manually turned the light on, it turns off after 60 minutes.



3. If you turn on AMBIENT LIGHTS, interior ambient lights turn on whenever the headlights are on.

Note: To control the backlighting on the steering wheel buttons, touch **Controls** > **Lights** > **Settings** > **Steering Wheel Lights**. If off, they do not turn on when headlights are on.

High Beam Headlights

Push the left-hand steering column lever away from you and release to turn the high beam headlights on continuously. To cancel, pull the lever toward you.

To briefly flash the high beam headlights, pull the lever towards you and release.



The following indicator lights are visible on the touchscreen to show the status of the headlights:

 Low beam headlights are on.

 High beam headlights are on.

Headlights After Exit

When you stop driving and park Model 3 in low lighting conditions, the exterior lights automatically turn on. They automatically turn off after one minute or when you lock Model 3.

To turn this feature on or off, touch **Controls** > **Lights** > **Settings** > **Headlights after Exit**.

When Headlights After Exit is turned off, headlights turn off when you engage the Park gear.

Headlight Adjustments

You can adjust the angle of the headlights to accommodate the load you are carrying. For example, in situations when you are carrying a significant amount of weight in the rear trunk, you may need to lower the angle of the headlights to avoid creating glare for other drivers. To adjust the headlights, touch **Controls** > **Service** > **Adjust Headlights**, then follow the onscreen instructions. You can choose which headlight you would like to adjust by selecting it on the touchscreen.

Warning: Proceed with caution when adjusting headlights. Tesla has carefully calibrated the position of the headlights



to be in an optimum position for most driving scenarios. Tesla recommends that you do not adjust headlights unless you are familiar with how headlights should be adjusted. Once adjusted, you will be unable to automatically restore them to their originally calibrated position. Contact Tesla for assistance when adjusting headlights.

Turn Signals

The turn signals flash three times or continuously, depending on how far up or down you move the lever. Lightly push the turn signal lever up or down for a three-flash sequence. For a continuous signal, push the lever fully up or down.



The turn signals stop operating when canceled by the steering wheel or after moving the lever in the opposite direction.

-  The corresponding turn signal indicator lights up on the touchscreen when a turn signal is operating. You also hear a clicking sound.
- 

Warning: If you have purchased the optional Enhanced Autopilot or Full Self-Driving Capability packages and Traffic-Aware Cruise Control is active, engaging a turn signal can cause Model 3 to accelerate when using Traffic-Aware Cruise Control in specific situations (see [Overtake Acceleration](#) on page 61). If is active, engaging a turn signal may cause Model 3 to change lanes (see [Auto Lane Change](#) on page 67).



Hazard Warning Flashers

To turn on the hazard warning flashers, press the button located above the rear view mirror. All turn signals flash. Press the button again to turn off the hazard warning flashers.



Note: Hazard warning flashers operate even when Model 3 cannot detect a key (authenticated phone or key card).

DRAFT
DO NOT DISTRIBUTE



Wipers

To perform a single wipe with the windshield wipers, press and immediately release the button on the end of the left-hand steering column lever.

To adjust the continuous wiper settings, touch the windshield wiper icon on the touchscreen (which also displays the current state of the wipers) or swipe to the windshield wiper "Card" on the touchscreen (see [Touchscreen Overview](#) on page 4).

Note: When you operate the wipers, the headlights automatically turn on (if they were not on already).

⚠ Caution: To avoid damaging the hood, ensure that the hood is fully closed before activating the windshield wipers.

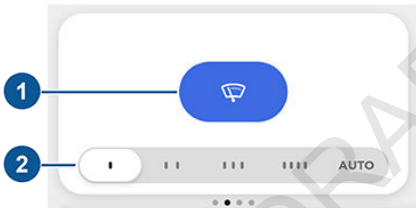

1. Turn the wipers on or off.
2. Adjust the speed of the wipers.
 - **1:** Intermittent, slow
 - **2:** Intermittent, fast
 - **3:** Continuous, slow
 - **4:** Continuous, fast
 - **AUTO:** Model 3 detects whether or not it is raining. When the wipers are set to AUTO and liquid is detected on the windshield, Model 3 determines the optimal frequency at which they should wipe. If Model 3 detects no liquid on the windshield, the wipers do not wipe.

Note: The AUTO setting is currently in BETA. If uncertain about using the AUTO setting while in the BETA phase, Tesla recommends operating the wipers manually (set them to one of the first four positions), as necessary.

Note: If the AUTO setting is selected but becomes unavailable, the wipers change to the manual setting (one of the first four positions) that is closest to the latest determined AUTO wiping frequency. If the latest wiping frequency cannot be determined, the wipers turn off.

⚠ Caution: Ensure the wipers are off before washing Model 3 to avoid the risk of damaging the wipers.

Periodically check and clean the edge of the wiper blades. If a blade is damaged, replace it immediately. For details on checking and replacing wiper blades, see [Wiper Blades and Washer Jets](#) on page 122.

⚠ Caution: Remove ice from the windshield before turning the wipers on. Ice has sharp edges that can damage the rubber on the blades.

⚠ Caution: In harsh climates, ensure that the wiper blades are not frozen or adhered to the windshield.

Washers

Fully press and hold the button on the end of the left-hand steering column lever to spray washer fluid onto the windshield. While spraying the windshield, the wipers turn on. After releasing the button, the wipers perform two additional wipes, then a third wipe a few seconds later.



Periodically top up washer fluid (see [Topping Up Washer Fluid](#) on page 125).



Braking Systems

Warning: Properly functioning braking systems are critical to ensure safety. If you experience a problem with the brake pedal, brake caliper, or any component of a Model 3 braking system, contact Tesla immediately.

Model 3 has an anti-lock braking system (ABS) that prevents the wheels from locking when you apply maximum brake pressure. This improves steering control during heavy braking in most road conditions.

During emergency braking conditions, the ABS constantly monitors the speed of each wheel and varies the brake pressure according to the grip available.

The alteration of brake pressure can be felt as a pulsing sensation through the brake pedal. This demonstrates that the ABS is operating and is not a cause for concern. Keep firm and steady pressure on the brake pedal while experiencing the pulsing.



The ABS indicator flashes briefly on the touchscreen when you first start Model 3. If this indicator lights up at any other time, an ABS fault has occurred and the ABS is not operating. Contact Tesla. The braking system remains fully operational and is not affected by an ABS failure. However, braking distances may increase.



If the touchscreen displays this indicator at any time other than displaying briefly when you first start Model 3, a brake system fault is detected or the brake fluid level is low. Contact Tesla immediately.

Emergency Braking

In an emergency, fully press the brake pedal and maintain firm pressure, even on low traction surfaces. The ABS varies the braking pressure to each wheel according to the amount of traction available. This prevents wheels from locking and ensures that you stop as safely as possible.

Warning: Do not pump the brake pedal. Doing so interrupts operation of the ABS and can increase braking distance.

Warning: Always maintain a safe distance from the vehicle in front of you and be

aware of hazardous driving conditions. While the ABS can improve stopping distance, it cannot overcome the laws of physics. It also does not prevent the danger of hydroplaning (where a layer of water prevents direct contact between the tires and the road).

Automatic Emergency Braking automatically applies full braking in situations where a collision is considered imminent (see [Automatic Emergency Braking](#) on page 77).

Warning: Automatic Emergency Braking is not designed to prevent a collision. At best, it can minimize the impact of a frontal collision by attempting to reduce your driving speed. Depending on Automatic Emergency Braking to avoid a collision can result in serious injury or death.

Brake Wear

Model 3 brake pads are equipped with wear indicators. A wear indicator is a thin metal strip attached to the brake pad that squeals as it rubs against the rotor when the pad wears down. This squealing sound indicates that the brake pads have reached the end of their service life and require replacement. To replace the brake pads, contact Tesla Service.

Warning: Neglecting to replace worn brake pads damages the braking system and can result in a braking hazard.

Regenerative Braking

Whenever Model 3 is moving and your foot is off the accelerator, regenerative braking slows down Model 3 and feeds any surplus energy back to the Battery.

By anticipating your stops and reducing or removing pressure from the accelerator pedal to slow down, you can take advantage of regenerative braking to increase driving range. Of course, this is no substitute for regular braking when needed for safety.

Note: If regenerative braking is aggressively slowing Model 3 (such as when your foot is completely off the accelerator pedal at highway speeds), the brake lights turn on to alert others that you are slowing down.

Warning: In snowy or icy conditions Model 3 may experience traction loss during regenerative braking, particularly when in the **Standard** setting and/or not using winter tires. Tesla recommends



using the **Low** setting (see [To Set the Regenerative Braking Level](#) on page 47) in snowy or icy conditions to help maintain vehicle stability.

The amount of energy fed back to the Battery using regenerative braking can depend on the current state of the Battery and the charge level setting that you are using. For example, regenerative braking may be limited if the Battery is already fully charged or if the ambient temperature is too cold.

Note: If regenerative braking is limited, a dashed line displays on the energy bar (see [Driving Status](#) on page 40).

To Set the Regenerative Braking Level

You can use the touchscreen to change the level of regenerative braking:

1. Touch **Controls > Driving > Regenerative Braking**.
2. Choose from two levels:
 - **Standard:** Provides the standard amount of regenerative braking. When you release the accelerator, Model 3 slows down, reducing the need to use the brakes.
 - **Low:** Limits regenerative braking. When you release the accelerator, Model 3 takes longer to slow down and coasts further than if set to Standard.

Parking Brake

The parking brake automatically engages when you shift Model 3 into Park, and releases when you shift into any other gear.



Note: The parking brake operates on the rear wheels only, and is independent of the pedal-operated brake system.

Warning: In snowy or icy conditions the rear wheels may not have sufficient traction to prevent Model 3 from sliding down a slope, particularly if not using winter tires. Avoid parking on hills in snowy or icy conditions. However, if parking in such conditions is absolutely

necessary, have a second person place wheel chocks under the front wheels before releasing the brake pedal.

Use the touchscreen to manually release the parking brake (which also shifts Model 3 into Neutral):

1. Touch **Controls > Safety & Security**.
2. Press the brake pedal, then touch **Parking Brake**. If Model 3 was previously in Park, it shifts into Neutral.



The parking brake indicator lights up on the touchscreen whenever you use the touchscreen to manually apply the parking brake.



If an electrical issue occurs with the parking brake, an amber parking brake fault message displays at the top of the touchscreen.



Caution: In the unlikely event that Model 3 loses electrical power, you cannot access the touchscreen and are therefore unable to release the parking brake without first jump starting Model 3 (see [Instructions for Transporters](#) on page 146).



How It Works

The traction control system constantly monitors the speed of the front and rear wheels. If Model 3 experiences a loss of traction, the system minimizes wheel spin by controlling brake pressure and motor power. By default, the traction control system is on. Under normal conditions, it should remain on to ensure maximum safety.



This indicator flashes on the touchscreen whenever the traction control system is actively controlling brake pressure and motor power to minimize wheel spin. If the indicator stays on, a fault is detected with the traction control system. Contact Tesla Service.

Warning: If the above indicator remains illuminated in situations in which you have not enabled Slip Start (described next), the traction control system may not be operating correctly. Contact Tesla Service immediately.

Warning: Traction control cannot prevent collisions caused by driving dangerously or turning too sharply at high speeds.

Allowing Wheel Slip

To allow the wheels to spin at a limited speed, you can enable Slip Start. Slip Start can be enabled at any speed, however it is less effective at higher speeds.

Under normal conditions, Slip Start should not be enabled. Enable it only in circumstances where you deliberately want the wheels to spin, such as:

- Starting on a loose surface, such as gravel or snow.
- Driving in deep snow, sand or mud.
- Rocking out of a hole or deep rut.

To allow the wheels to spin, touch **Controls** > **Driving** > **Traction Control** > **Slip Start**.



The touchscreen displays an alert message when Slip Start is enabled.

Although Slip Start is automatically disabled the next time you start Model 3, it is strongly recommended that you disable it immediately after the circumstances that required you to enable it have passed.

Note: Slip Start cannot be enabled when you are actively using Traffic-Aware Cruise Control.



How Park Assist Works

Model 3 has several sensors designed to detect the presence of objects. When driving slowly in Drive or Reverse (for example, when parking), the sensors alert you if an object is detected in close proximity of your Model 3. Objects are only detected in the direction of the gear you selected; front objects in Drive, rear objects in Reverse.

⚠ Warning: You may not be alerted if Model 3 rolls freely in the opposite direction of the gear you selected (for example, you will not receive an alert if Model 3 rolls backwards down a hill while in Drive).

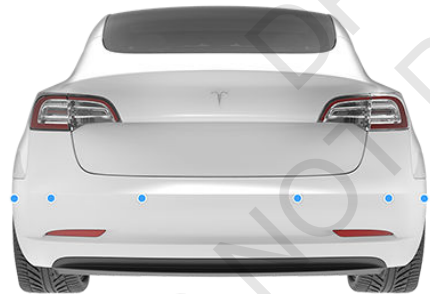
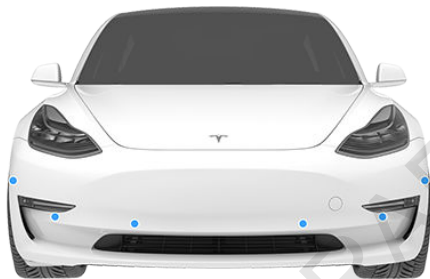

The sensors are activated when driving slower than 5 mph (8 km/h).

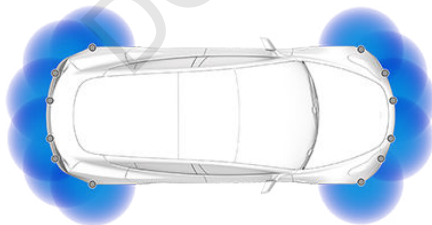

⚠ Warning: Never depend on Park Assist to inform you if an area you are approaching is free of objects and/or people. Several external factors can reduce the

performance of Park Assist, causing either no readings or false readings (see [Limitations and False Warnings](#) on page 50). Therefore, depending on Park Assist to determine if Model 3 is approaching an obstruction can result in damage to the vehicle and/or objects, and can potentially cause serious injury. Always inspect the area with your own eyes. When reversing, perform shoulder checks and use all mirrors. Park assist does not detect children, pedestrians, bicyclists, animals, or objects that are moving, protruding, located too far above or below the sensors, or too close or too far from the sensors. Park Assist is for guidance purposes only and is not intended to replace your own direct visual checks. It is not a substitute for careful driving.

Visual and Audio Feedback

When you shift to Reverse, the Park Assist view displays on the touchscreen, showing objects that are in close proximity to the front and rear of Model 3. This view closes when you shift into Drive unless an object is detected close to the front of Model 3, in which case the Park Assist view closes automatically when your driving speed exceeds 5 mph (8 km/h). When reversing, visual feedback also displays on the touchscreen, immediately below the camera view (see [Rear View Camera](#) on page 53). You can manually close the park assist view on the touchscreen by touching the **X** in the upper left corner.

When driving with the Camera app displayed on the touchscreen, you can switch to the Park Assist view when driving at speeds below 5 mph (8 km/h). Touch the button located in the upper left corner of the Camera app window. This is useful if you need assistance with parallel parking.

If chimes are turned on (see [Controlling Audible Feedback](#) on page 50), an audible beep sounds as you approach an object. You can temporarily mute the chime by pressing the scroll button on the left side of the steering wheel or by touching the mute button located on the bottom left corner of the Park Assist view.

Note: If a sensor is unable to provide feedback, the touchscreen displays an alert message.



⚠️ Caution: Keep sensors clean from dirt, debris, snow, and ice. Avoid using a high pressure power washer on the sensors and do not clean a sensor with a sharp or abrasive object that can scratch or damage its surface.

⚠️ Caution: Do not install accessories or stickers on or near the parking sensors.

Controlling Audible Feedback

You can use Park Assist with or without audible feedback. To turn chimes on or off, touch **Controls > Safety & Security > Settings > Park Assist Chimes**.

To mute the chimes temporarily, press the scroll button on the left side of the steering wheel or touch the mute button in the bottom left corner of the Park Assist view. The chimes are muted until you shift into a different gear or drive over 5 mph (8 km/h).

Limitations and False Warnings

The parking sensors may not function correctly in these situations:

- One or more of the parking sensors is damaged, dirty, or covered (such as mud, ice, or snow).
- The object is located below approximately 8 inches (20 cm) (such as a curb or low barrier).

⚠️ Caution: Shorter objects that are detected (such as curbs or low barriers) can move into the blind spot of the sensors. Model 3 cannot alert you about an object while it is in the blind spot of the sensors.

- Weather conditions (heavy rain, snow, or fog) are interfering with sensor operation.
- The object is thin (such as a sign post).
- A sensor's operating range has been exceeded.
- The object is sound-absorbing or soft (such as powder snow).
- The object is sloped (such as a sloped embankment).
- Model 3 has been parked in, or being driven in, extremely hot or cold temperatures.
- The sensors are affected by other electrical equipment or devices that generate ultrasonic waves.
- The object is located too close to the bumper.

- A bumper is misaligned or damaged.
- An object that is mounted to Model 3 is interfering with and/or obstructing the sensor (such as a bike rack or bumper sticker).
- Model 3 rolls freely in the opposite direction of the gear you selected (for example, you will not receive an alert if Model 3 rolls backwards down a hill while in Drive).

Other Parking Aids

In addition to Park Assist, when shifted into Reverse, the backup camera displays a view of the area behind Model 3 (see [Rear View Camera](#) on page 53).



When Model 3 is stopped, Vehicle Hold can continue to apply the brakes even after you remove your foot from the brake pedal. When driving on a hill or on a flat surface, brake as you normally would. After coming to a complete stop, simply press the brake pedal again (until the touchscreen displays the Vehicle Hold indicator light) to enable Vehicle Hold. You can then release the brake pedal and remain stopped, even on a hill.



This indicator displays on the touchscreen whenever Vehicle Hold is actively braking Model 3.

To disengage Vehicle Hold, press the accelerator pedal or press and release the brake pedal.

Note: Shifting into Neutral also disengages Vehicle Hold.

Note: After actively braking Model 3 for approximately ten minutes, Model 3 shifts into Park and Vehicle Hold cancels. Model 3 also shifts into Park if it detects that the driver has left the vehicle.



Driving Tips to Maximize Range

You can maximize your driving range using the same driving habits that you use to conserve fuel in a gasoline-powered vehicle. In addition to driving habits, energy consumption depends on environmental conditions (such as exceptionally cold or hot weather and driving on roads with steep hills). To get the maximum mileage from a charge:

- Slow down your driving and avoid frequent and rapid acceleration.
- If safe to do so, modulate the accelerator pedal instead of using the brake pedal when gradually slowing down. Whenever Model 3 is moving and you are not pressing the accelerator pedal, regenerative braking slows down Model 3 and feeds surplus energy back to the Battery (see [Regenerative Braking](#) on page 46).
- Keep tires at the recommended inflation pressures (see [Tire Care and Maintenance](#) on page 113).
- Lighten your load by removing any unnecessary cargo.
- Fully raise all windows.
- Limit the use of resources such as heating and air conditioning. Using seat heaters to keep warm is more efficient than heating the cabin.

The power meter on the touchscreen provides feedback on energy usage. With this feedback, you will soon become familiar with how driving habits and environmental conditions impact how much energy Model 3 is using.

Range Assurance

Model 3 helps protect you against running out of energy. Model 3 continuously monitors its energy level and proximity to known charging locations.

When you are at risk of driving beyond the range of known charging locations, the touchscreen displays a message giving you the opportunity to display a list of charging locations that are within range. When you select a charging location from the list, Model 3 provides navigation instructions and the turn-by-turn direction list displays the predicted amount of energy that will remain when you arrive at the charging destination.



Camera Location

Model 3 is equipped with a rear view camera located above the rear license plate.

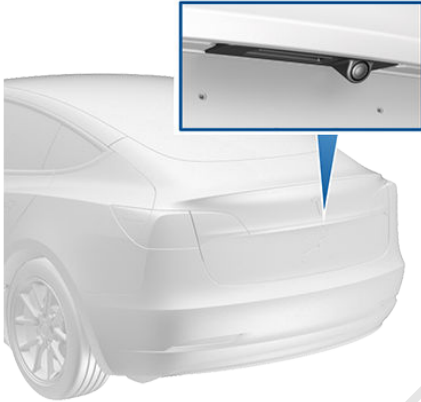

Whenever you shift into Reverse, the touchscreen displays the view from the camera. Lines show your driving path based on the position of the steering wheel. These lines adjust appropriately as you move the steering wheel.

Note: Visual feedback from the parking sensors displays on the touchscreen (see [Park Assist](#) on page 49).



To display the view from the camera any time, touch the camera icon on the touchscreen.

Warning: Never depend on the rear view camera to inform you if the area behind you is free of objects and/or people when reversing. The camera may not detect objects or barriers that can potentially cause damage or injury. In addition, several external factors can reduce the performance of the camera, including a dirty or obstructed lens. Therefore, depending on the rear view camera to determine if Model 3 is approaching an obstruction can result in damage to the vehicle and/or objects, and can potentially cause serious injury. Always inspect the area with your own eyes. When reversing, perform shoulder checks and use all mirrors. Use the camera for guidance purposes only. It is not intended

to replace your own direct visual checks and is not a substitute for careful driving.

Cleaning the Camera

To ensure a clear picture, keep the camera lens clean, and free of obstructions. Remove any buildup of dirt by occasionally wiping the camera lens with a soft damp cloth.

Caution: Do not use chemical-based or abrasive cleaners. Doing so can damage the surface of the camera lens.



Camera Location

Model 3 is equipped with a camera in the cabin. The camera is not currently active, but might be used in potential future features which could be added to Model 3 with software releases.



Cleaning the Camera

Keep the camera lens clean, and free of obstructions. Remove any buildup of dirt or dust by occasionally wiping the camera lens with a soft damp cloth.

⚠ Caution: Do not use chemical-based or abrasive cleaners. Doing so can damage the surface of the camera lens.

DO NOT DRAFT
DO NOT DISTRIBUTE



How It Works

Your Model 3 includes the following Autopilot components that actively monitor the surrounding roadway:

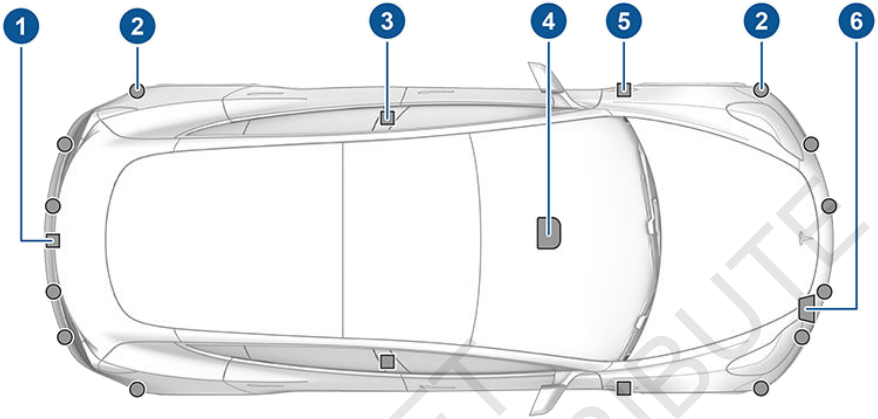

1. A camera is mounted above the rear license plate.
2. Ultrasonic sensors are located in the front and rear bumpers.
3. A camera is mounted in each door pillar.
4. Three cameras are mounted to the windshield above the rear view mirror.
5. A camera is mounted to each front fender.
6. Radar is mounted behind the front bumper on the side of the vehicle.

Model 3 is also equipped with high precision electronically-assisted braking and steering systems.



Features

These Autopilot safety features are available on all Model 3 vehicles:

- Lane Assist (see [Lane Assist](#) on page 74).
- Collision Avoidance Assist (see [Collision Avoidance Assist](#) on page 76).
- Speed Assist (see [Speed Assist](#) on page 79).

These convenience features, designed to reduce driver workload, are available only if your Tesla vehicle is equipped with the optional Enhanced Autopilot or Full Self-Driving Capability packages:

- Traffic-Aware Cruise Control (see [Traffic-Aware Cruise Control](#) on page 58).
- Autosteer (see [Autosteer](#) on page 64).
- Auto Lane Change (see [Auto Lane Change](#) on page 67).

You can enable/disable Autopilot features and in some cases, control how they work. To access settings for Autopilot features, touch **Controls > Autopilot > Settings**.

Calibration

Model 3 must maneuver with a great deal of precision when Autopilot features are being used. Therefore, before some features (for example, Traffic-Aware Cruise Control or Autosteer) can be used for the first time, some cameras must complete a self-calibration process.

Calibration typically completes after driving 20-25 miles (32-40 km), but the distance varies depending on road and environmental conditions. Driving on a straight road with highly-visible lane lines allows Model 3 to calibrate quicker. When calibration is complete, the features are available for use the next time you drive (i.e. you must stop and shift into Park before you can use the features). Contact Tesla if your Model 3 has not completed the calibration process after driving 100 miles (160 km).

Note: If you attempt to use a feature that is not available until the calibration process is complete, the feature will not be enabled and the touchscreen displays a message.

Note: Model 3 repeats the calibration process if the cameras are serviced by Tesla and in some cases, after a software update.

Limitations

Many factors can impact the performance of Autopilot components, causing them to be unable to function as intended. These include (but are not limited to):

- Poor visibility (due to heavy rain, snow, fog, etc.).
- Bright light (due to oncoming headlights, direct sunlight, etc.).
- Damage or obstructions caused by mud, ice, snow, etc.
- Interference or obstruction by object(s) mounted onto the vehicle (such as a bike rack).
- Obstruction caused by applying excessive paint or adhesive products (such as wraps, stickers, rubber coating, etc.) onto the vehicle.
- Narrow or winding roads.
- A damaged or misaligned bumper.
- Interference from other equipment that generates ultrasonic waves.
- Extremely hot or cold temperatures.

Warning: The list above does not represent an exhaustive list of situations that may interfere with proper operation of Autopilot components. Never depend on these components to keep you safe. It is the driver's responsibility to stay alert, drive safely, and be in control of the vehicle at all times.

Caution: If a windshield replacement is needed, take your vehicle to Tesla Service. This will ensure appropriate handling and mounting of the camera(s). Failure to do so can cause one or more Autopilot features to malfunction.

Cleaning Cameras and Sensors

To ensure the various Autopilot components can provide information that is as accurate as possible, keep them clean and free of obstructions or damage. Occasionally remove any buildup of dirt by wiping the components with a soft cloth dampened with warm water.

Caution: Do not use chemical-based or abrasive cleaners. Doing so can damage surfaces.

Caution: Avoid using a high-pressure power washer.

Caution: Do not clean an ultrasonic sensor or camera lens with a sharp or



abrasive object that can scratch or damage its surface.

DRAFT
DO NOT DISTRIBUTE



Note: Traffic-Aware Cruise Control is a BETA feature.

If you have purchased the optional Enhanced Autopilot or Full Self-Driving Capability package, the forward looking cameras and the radar sensor are designed to determine when there is a vehicle in front of you in the same lane. If the area in front of Model 3 is clear, Traffic-Aware Cruise Control maintains a set driving speed. When a vehicle is detected, Traffic-Aware Cruise Control is designed to slow down Model 3 as needed to maintain a selected time-based distance from the vehicle in front, up to the set speed. Traffic-Aware Cruise Control does not eliminate the need to watch the road in front of you and to manually apply the brakes when needed.

Traffic-Aware Cruise Control is primarily intended for driving on dry, straight roads, such as highways and freeways. It should not be used on city streets.

Warning: Traffic-Aware Cruise Control is designed for your driving comfort and convenience and is not a collision warning or avoidance system. It is your responsibility to stay alert, drive safely, and be in control of the vehicle at all times. Never depend on Traffic-Aware Cruise Control to adequately slow down Model 3. Always watch the road in front of you and be prepared to take corrective action at all times. Failure to do so can result in serious injury or death.

Warning: Although Traffic-Aware Cruise Control is capable of detecting pedestrians and cyclists, never depend on Traffic-Aware Cruise Control to adequately slow Model 3 down for them. Always watch the road in front of you and be prepared to take corrective action at all times. Failure to do so can result in serious injury or death.

Warning: Do not use Traffic-Aware Cruise Control on city streets or on roads where traffic conditions are constantly changing.

Warning: Do not use Traffic-Aware Cruise Control on winding roads with sharp curves, on icy or slippery road surfaces, or when weather conditions (such as heavy rain, snow, fog, etc.) make it inappropriate to drive at a consistent speed. Traffic-Aware Cruise Control does not adapt driving speed based on road and driving conditions.

Operating Traffic-Aware Cruise Control

To use Traffic-Aware Cruise Control, you must be driving at least 18 mph (30 km/h), unless a vehicle is detected ahead of you. If a vehicle is detected ahead of you, you can use Traffic-Aware Cruise Control at any speed, even when stationary, provided you are at least 5 feet (150 cm) away from the vehicle.

The minimum set speed is 18 mph (30 km/h). The maximum set speed is 90 mph (150 km/h). It is the driver's responsibility to cruise at a safe speed based on road conditions and speed limits.

The touchscreen displays a gray speedometer icon to indicate that Traffic-Aware Cruise Control is available but is not currently active. The number shown in gray is determined by Speed Assist (see [Controlling Speed Assist](#) on page 79).

When driving at your desired speed, set the cruising speed by moving the gear lever fully down once then releasing.

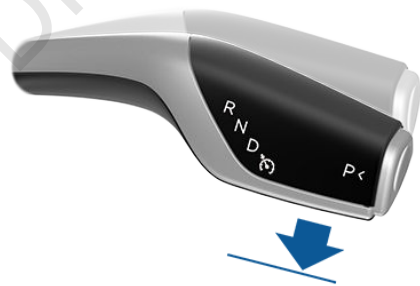

The gray speedometer icon on the touchscreen gets larger, turns blue, and displays the set speed to indicate that Traffic-Aware Cruise Control is active.

Note: The minimum set speed is 18 mph (30 km/h). The maximum set speed is 90 mph (150 km/h). It is the driver's responsibility to cruise at a safe speed based on road conditions and speed limits.



You can now release the accelerator pedal and allow Traffic-Aware Cruise Control to maintain your set speed. When no vehicle is detected ahead, Traffic-Aware Cruise Control maintains the set speed. If a vehicle is detected, Traffic-Aware Cruise Control maintains your chosen following distance, up to the set speed, accelerating and decelerating Model 3 as needed. When the vehicle you are following is no longer detected, Traffic-Aware Cruise Control accelerates up to the set speed. Traffic-Aware Cruise Control also adjusts the speed as appropriate when entering and exiting curves.

You can manually accelerate at any time when driving at a set speed using Traffic-Aware Cruise Control. But when you release the accelerator, Model 3 returns to the set speed.

When following a vehicle, Traffic-Aware Cruise Control remains active at low speeds, even if Model 3 comes to a standstill. When the vehicle is moving again, Traffic-Aware Cruise Control resumes operating at your current set speed. However, under the following circumstances, Traffic-Aware Cruise Control goes into a **HOLD** state instead of resuming, and the touchscreen displays a message indicating that you need to resume cruise control:

- You have been at a standstill for 5 minutes.
- The driver's seat belt is unbuckled.
- Model 3 detects a pedestrian nearby (the **HOLD** state may clear when the pedestrian is no longer close by).
- Model 3 suddenly loses visibility of the vehicle you are following.
- The ultrasonic sensors detect an obstacle in front of Model 3.

To resume Traffic-Aware Cruise Control, press the accelerator pedal.

In right hand traffic, engaging the right turn signal when driving in the right-most lane within 164 feet (50 meters) of an exit (on a controlled access road only, such as a highway or freeway), causes Traffic-Aware Cruise Control to assume you are exiting. As a result, Traffic-Aware Cruise Control begins to slow down the vehicle. Likewise in left hand traffic, when engaging the left turn signal when driving in the left-most lane within 164 feet (50 meters) of an exit. The onboard Global Positioning System (GPS) determines if you are driving in a region with right or left hand traffic. In situations where GPS data is unavailable (for example, if there is inadequate signal), engaging the turn signal near an exit does not cause Traffic-Aware Cruise Control to slow down Model 3.

Note: If Traffic-Aware Cruise Control is not active and you move the gear lever fully down twice in quick succession, Autosteer activates if enabled (see [Autosteer](#) on page 64) and the set speed changes to either your current driving speed, or remains at the current set speed (whichever is greater).

Note: When Traffic-Aware Cruise Control is actively slowing down Model 3 to maintain the selected distance from the vehicle ahead, the brake lights turn on to alert other road users that you are slowing down. You may also notice slight movement of the brake pedal. However, when Traffic-Aware Cruise Control is accelerating Model 3, the accelerator pedal does not move.

Warning: Due to limitations inherent in the onboard GPS, you may experience situations in which Traffic-Aware Cruise Control slows down the vehicle, especially near highway exits where a curve is detected and/or you are actively navigating to a destination and not following the route.

Warning: Traffic-Aware Cruise Control cannot detect all objects and may not brake/decelerate for stationary vehicles or objects, especially in situations when you are driving over 50 mph (80 km/h) and in situations where a vehicle you are following moves out of your driving path and a stationary vehicle or object is in front of you. Always pay attention to the road ahead and stay prepared to take immediate corrective action. Depending on Traffic-Aware Cruise Control to avoid a collision can result in serious injury or death. In addition, Traffic-Aware Cruise Control may react to vehicles or objects that either do not exist or are not in the



lane of travel, causing Model 3 to slow down unnecessarily or inappropriately.

Warning: Traffic-Aware Cruise Control may be unable to provide adequate speed control because of limited braking capability and hills. It can also misjudge the distance from a vehicle ahead. Driving downhill can increase driving speed, causing Model 3 to exceed your set speed (and potentially the road's speed limit). Never depend on Traffic-Aware Cruise Control to slow down the vehicle enough to prevent a collision. Always keep your eyes on the road when driving and be prepared to take corrective action as needed. Depending on Traffic-Aware Cruise Control to slow the vehicle down enough to prevent a collision can result in serious injury or death.

Warning: Traffic-Aware Cruise Control may occasionally cause Model 3 to brake when not required or when you are not expecting it. This can be caused by closely following a vehicle ahead, detecting vehicles or objects in adjacent lanes (especially on curves), etc.

Adjust your following distance

To adjust the following distance you want to maintain between your Model 3 and a vehicle traveling ahead of you, press the right scroll button to the left or right to choose a setting from 1 (the closest following distance) to 7 (the longest following distance). Each setting corresponds to a time-based distance that represents how long it takes for Model 3, from its current location, to reach the location of the rear bumper of the vehicle ahead of you.

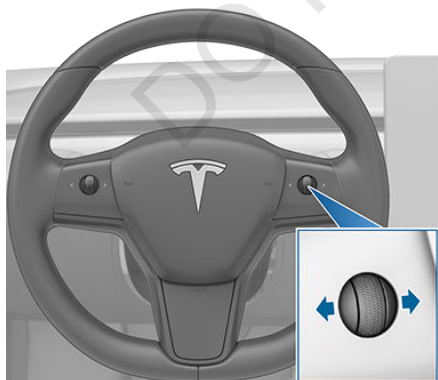

To display and adjust the setting for the following distance on the touchscreen at any time, touch **Controls > Autopilot > Cruise Follow Distance**. Adjust the following distance by touching plus (+) or minus (-) buttons.



As you adjust the following distance, the touchscreen displays the current setting.



Note: Your setting is retained until you manually change it.

Warning: It is the driver's responsibility to determine and maintain a safe following distance at all times. Do not rely on Traffic-Aware Cruise Control to maintain an accurate or appropriate following distance.

Warning: Never depend on Traffic-Aware Cruise Control to adequately slow down Model 3 to avoid a collision. Always watch the road in front of you and stay prepared to take immediate corrective action.

Cruising at the Speed Limit

Traffic-Aware Cruise Control makes it easy to cruise at the speed limit. You can cruise at the speed limit that is currently being determined by Speed Assist (see [Speed Assist](#) on page 79). To do so, move the gear lever fully down once then release. When you release, your cruising speed is set to the speed that is determined by Speed Assist, taking into consideration any offset you have specified. If you are already driving faster than the speed limit when you pull the lever, the set speed does not adjust to the speed limit—it adjusts to your current driving speed.

Note: When you adjust the cruising speed based on the speed limit, the set speed does not change when the speed limit changes. You must move the gear lever fully down once then release to cruise at the new speed limit. You can also manually adjust your cruising speed at any time (see [Changing the Set Speed](#) on page 61).

Note: Your set speed will use your current driving speed or the previous set speed



(whichever is greater) when you move the gear lever fully down once then release.

Note: If Speed Assist is unable to determine a speed limit, your set speed does not change when you move the gear lever fully down once then release.

Warning: Do not rely on Speed Assist or Traffic-Aware Cruise Control to determine an accurate or appropriate cruising speed. Always cruise at a safe speed based on road conditions and applicable speed limits.

Changing the Set Speed

To change the set speed while using Traffic-Aware Cruise Control, roll the right scroll wheel up (to increase) or down (to decrease) the set speed until your desired set speed is displayed. Slowly rolling the scroll wheel changes the set speed in 1 mph (1 km/h) increments and quickly rolling the scroll wheel changes the set speed to the closest 5 mph (5 km/h) increment.

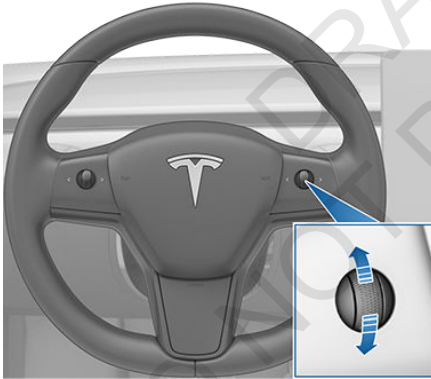

You can also use the touchscreen to change the set speed by touching the plus (+) or minus (-) next to the displayed set speed. A quick tap changes the set speed by 1 mph (1 km/h) and a press and hold changes the set speed to the closest 5 mph (5 km/h) increment. To increase/decrease to the next increment, you must release the plus (+) or minus (-) then press it again.



To cruise at the speed limit that is currently being determined by Speed Assist (including any offsets that you have set), move the gear lever fully down once then release. See [Speed Assist](#) on page 79.

Note: It may take a few seconds for Model 3 to reach the new cruising speed, assuming Model 3 does not detect a vehicle ahead driving slower than your set speed.

Overtake Acceleration

When following a vehicle with Traffic-Aware Cruise Control active, briefly engaging the turn signal (to indicate a move into the passing lane) accelerates Model 3 towards the vehicle ahead. By momentarily holding the turn signal lever up or down, you can quickly accelerate up to your set speed without having to press the accelerator pedal. The turn signal accelerates only when the following conditions are met:

- Traffic-Aware Cruise Control is operating and detects a vehicle in front of you.
- No obstacles or vehicles are detected in the target lane.
- Model 3 is traveling below the set speed, but over 45 mph (72 km/h).

Overtake Acceleration is intended as an aid when passing a vehicle ahead of you. When the turn signal is engaged, Traffic-Aware Cruise Control continues to maintain distance from the vehicle ahead, but allows you to drive slightly closer than your selected distance.

Acceleration cancels when:

- You reach your set cruising speed.
- Changing lanes takes too long.
- Model 3 gets too close to the vehicle ahead.

OR

- You disengage the turn signal.

Note: Overtake Acceleration occurs when you hold the turn signal in the momentary position (partially engaged). When you release the turn signal, Model 3 stops accelerating (in the same way as when you release the accelerator pedal) and resumes the set speed.

Warning: Overtake Acceleration can cancel for many unforeseen reasons in addition to those listed above (for example, lack of GPS data). Stay alert and never depend on Overtake Acceleration to increase your driving speed.



Warning: Overtake Acceleration increases your driving speed whenever the appropriate turn signal is engaged, and accelerates Model 3 closer to the vehicle ahead. Although Traffic-Aware Cruise Control continues to maintain distance from the vehicle ahead, it is important to be aware that your selected following distance is reduced when Overtake Acceleration is active, particularly in cases where it may not be your intention to overtake the vehicle you are following.

Canceling and Resuming

To manually cancel Traffic-Aware Cruise Control, move the gear lever up and release or press the brake pedal. The speedometer icon on the touchscreen turns gray to indicate that Traffic-Aware Cruise Control is not actively controlling your speed.

Note: If you hold the gear lever upward for more than 1 second, Model 3 shifts into Neutral after canceling Traffic-Aware Cruise Control.



To re-enable cruising at the current driving speed, move the gear lever fully down once then release.

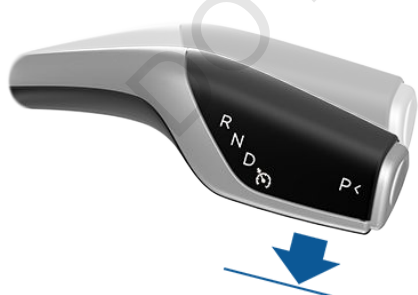

Note: When Traffic-Aware Cruise Control cancels, Model 3 does not coast. Instead, regenerative braking slows down Model 3 in

the same way as when you move your foot off the accelerator when driving without Traffic-Aware Cruise Control (see [Regenerative Braking](#) on page 46).

Warning: Traffic-Aware Cruise Control cancels, or may not be available, in the following situations:

- You press the brake pedal.
- Your driving speed drops below 5 mph (8 km/h) in situations when Model 3 does not detect a vehicle ahead within the specified distance.
- Your driving speed exceeds the maximum cruising speed of 90 mph (150 km/h).
- You shift Model 3 into a different gear.
- The driver's seat belt is unbuckled.
- A door is opened.
- The view from the radar sensor or camera(s) is obstructed. This could be caused by dirt, mud, ice, snow, fog, etc.
- The traction control setting is manually disabled or is repeatedly engaging to prevent wheels from slipping.
- The wheels are spinning while at a standstill.
- The Traffic-Aware Cruise Control system is failing or requires service.

When Traffic-Aware Cruise Control is unavailable or cancels, Model 3 no longer drives consistently at a set speed and no longer maintains a specified distance from the vehicle ahead.

Warning: Traffic-Aware Cruise Control can cancel unexpectedly at any time for unforeseen reasons. Always watch the road in front of you and stay prepared to take appropriate action. It is the driver's responsibility to be in control of Model 3 at all times.

Summary of Cruise Indicators

50

Traffic-Aware Cruise Control is available but is not actively controlling your speed until you activate it. The number shown in gray is determined by Speed Assist (see [Controlling Speed Assist](#) on page 79).



Traffic-Aware Cruise Control is operating and is either maintaining the set speed (no vehicle in front) or is maintaining a chosen following distance from a vehicle ahead (up to the set speed).



Model 3 has fully stopped but is in a **HOLD** state. If safe, press the accelerator pedal to resume cruising at the set speed.

Limitations

Traffic-Aware Cruise Control is particularly unlikely to operate as intended in the following types of situations:

- The road has sharp curves.
- Visibility is poor (due to heavy rain, snow, fog, etc.).
- Bright light (such as from oncoming headlights or direct sunlight) is interfering with the view of the camera(s).
- The radar sensor is obstructed (dirty, covered, etc.).
- The windshield is obstructing the view of the camera(s) (fogged over, dirty, covered by a sticker, etc.).

Warning: The list above does not represent an exhaustive list of situations that may interfere with proper operation of Traffic-Aware Cruise Control.



Note: Autosteer is a BETA feature.

If you have purchased the optional Enhanced Autopilot or Full Self-Driving Capability packages, you can use Autosteer to manage steering and speed under certain circumstances. Autosteer builds upon Traffic-Aware Cruise Control (see [Traffic-Aware Cruise Control](#) on page 58), intelligently keeping Model 3 in its driving lane when cruising at a set speed. Using the vehicle's camera(s), the radar sensor, and the ultrasonic sensors, Autosteer detects lane markings and the presence of vehicles and objects, steering Model 3 based on the lane markings and the vehicle directly in front of you.

Warning: Autosteer is a hands-on feature. You must keep your hands on the steering wheel at all times.

Warning: Autosteer is intended for use only on highways and limited-access roads with a fully attentive driver. When using Autosteer, hold the steering wheel and be mindful of road conditions and surrounding traffic. Do not use Autosteer on city streets, in construction zones, or in areas where bicyclists or pedestrians may be present. Never depend on Autosteer to determine an appropriate driving path. Always be prepared to take immediate action. Failure to follow these instructions could cause damage, serious injury or death.

Operating Autosteer

Before you can operate Autosteer, you must enable it by touching **Controls > Autopilot > Autosteer (Beta) > ON**.



To indicate that Autosteer is available (but not actively steering Model 3), the touchscreen displays a gray Autosteer icon.

To initiate Autosteer, move the gear lever fully down twice in quick succession.



Autosteer briefly displays a message on the touchscreen reminding you to pay attention to the road and be ready to take over at any time. To indicate that Autosteer is now actively steering Model 3, the touchscreen displays the Autosteer icon in blue. When Autosteer is able to detect lane markings, it also displays the driving lane in blue.

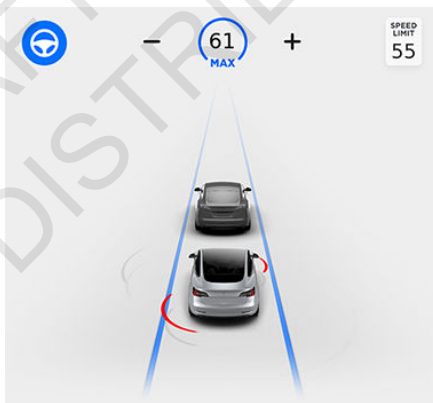

Note: To initiate Autosteer when there is no vehicle in front of you, you must be driving at least 18 mph (30 km/h) on a roadway with visible lane markings. If a vehicle is detected ahead of you, you can initiate Autosteer at any speed, even when stationary (if you are at least 5 feet (150 cm) away from the vehicle).

The touchscreen displays a message indicating that Autosteer is temporarily unavailable if you attempted to engage Autosteer when driving at a speed that is not within the speed required for Autosteer to operate. Autosteer may also be unavailable if it is not receiving adequate data from the camera(s) or sensors.

If Autosteer is unable to detect lane markings, the driving lane is determined based on the vehicle you are following.



In most cases, Autosteer attempts to center Model 3 in the driving lane. However, if the sensors detect the presence of an obstacle (such as a vehicle or guard rail), Autosteer may steer Model 3 in a driving path that is offset from the center of the lane.

Warning: Autosteer is not designed to, and will not, steer Model 3 around objects partially or completely in the driving lane. Always watch the road in front of you and stay prepared to take appropriate action. It is the driver's responsibility to be in control of Model 3 at all times.

Restricted Speed

Autosteer is intended for use only by a fully attentive driver on freeways and highways where access is limited by entry and exit ramps. If you choose to use Autosteer on residential roads, a road without a center divider, or a road where access is not limited, Autosteer may limit the maximum allowed cruising speed. The maximum allowed cruising speed on such roads is calculated based on the detected speed limit including a Speed Assist offset of up to +5 mph (10 km/h). Any Speed Assist offset above +5 mph (10 km/h) is rounded down to +5 mph (10 km/h). However, you can select a more restrictive cruising speed by reducing the speed limit offset (see [Controlling Speed Assist](#) on page 79) or by changing the set speed (see [Changing the Set Speed](#) on page 61).

In situations where the speed limit cannot be detected when Autosteer is engaged, Autosteer reduces your driving speed and limits the set speed to 45 mph (70 km/h). Although you can manually accelerate to exceed the limited speed, Model 3 may not brake for detected obstacles. Autosteer will slow down to the limited speed when you release the accelerator pedal. When you leave the road, or disengage Autosteer by using the steering wheel, you can increase your set speed again, if desired.

Hold Steering Wheel

Autosteer uses data from the camera(s), sensors, and GPS to determine how best to steer Model 3. When active, Autosteer requires you to hold the steering wheel. If it does not detect your hands on the steering wheel for a period of time, a flashing blue light appears at the top of the car status section of the touchscreen and the following message displays:



Hold Steering Wheel

Autosteer detects your hands by recognizing light resistance as the steering wheel turns, or from you manually turning the steering wheel very lightly (i.e., without enough force to retake control). When your hands are detected, the message disappears and Autosteer resumes normal operation.

Note: Autosteer may also sound a chime at the same time that the message is initially displayed.

Autosteer requires that you pay attention to your surroundings and remain prepared to take control at any time. If Autosteer still does not detect your hands on the steering wheel, the request escalates by sounding chimes that increase in frequency.

If you repeatedly ignore hands-on prompts, Autosteer displays the following message and is disabled for the rest of the drive. If you don't resume manual steering, Autosteer sounds a continuous chime, turns on the warning flashers, and slows the vehicle to a complete stop.



Autosteer Unavailable for the Rest of This Drive
Hold Steering Wheel to Drive Manually

For the rest of the drive, you must steer manually. Autosteer is available again after you stop and shift the vehicle into Park.

Take Over Immediately

In situations where Autosteer is unable to steer Model 3, Autosteer sounds a warning chime and displays the following message on the touchscreen:



Take Over Immediately

When you see this message, **TAKE OVER STEERING IMMEDIATELY.**

Canceling Autosteer

Autosteer cancels when:

- You start steering manually.
- You press the brake pedal.



- The maximum speed that Autosteer supports—90 mph (150 km/h)—is exceeded.
- You move the gear lever upwards.
- An Automatic Emergency Braking event occurs (see [Collision Avoidance Assist](#) on page 76).

When Autosteer cancels, it sounds chimes and the Autosteer icon either turns gray to indicate that Autosteer is no longer active, or disappears to indicate that it is not currently available.

Note: If Autosteer cancels because you started steering manually, Traffic-Aware Cruise Control remains active. Disengage Traffic-Aware Cruise Control as you normally would, by moving the gear lever upward or pressing the brake pedal.

Note: If you hold the gear lever upward for more than 1 second, Model 3 shifts into Neutral after canceling Autosteer.

To disable Autosteer so it is no longer available, touch **Controls > Autopilot > Autosteer (Beta) > OFF**.

Limitations

Autosteer is particularly unlikely to operate as intended when:

- Autosteer is unable to accurately determine lane markings. For example, lane markings are excessively worn, have visible previous markings, have been adjusted due to road construction, are changing quickly (lanes branching off, crossing over, or merging), objects or landscape features are casting strong shadows on the lane markings, or the road surface contains pavement seams or other high-contrast lines.
- Visibility is poor (heavy rain, snow, fog, etc.).
- A camera(s) or sensor(s) is obstructed, covered, or damaged.
- Driving on hills.
- Approaching a toll booth.
- Driving on a road that has sharp curves or is excessively rough.
- Bright light (such as direct sunlight) is interfering with the view of the camera(s).
- The sensors are affected by other electrical equipment or devices that generate ultrasonic waves.

Warning: Many unforeseen circumstances can impair the operation of Autosteer.

Always keep this in mind and remember that as a result, Autosteer may not steer Model 3 appropriately. Always drive attentively and be prepared to take immediate action.



- ⚠ Warning:** Auto Lane Change is designed to be used only when driving on restricted-access highways (i.e. with on-ramps and off-ramps).

If you have purchased the optional Enhanced Autopilot or Full Self-Driving Capability packages, you can use Auto Lane Change to move Model 3 into an adjacent lane without moving the steering wheel (which would cancel Autosteer). When both Traffic-Aware Cruise Control and Autosteer are active, Auto Lane Change intelligently steers Model 3 into an adjacent driving lane. Using the forward looking camera(s), the radar sensor, and ultrasonic sensors, Model 3 detects lane markings and the presence of other vehicles.

Auto Lane Change is designed for use on restricted-access highways with visible lane markings and under relatively predictable circumstances in which minimal steering and driver intervention is needed.

- ⚠ Warning:** It is the driver's responsibility to determine whether a lane change is safe and appropriate. Auto Lane Change cannot detect oncoming traffic in the target lane, especially fast moving vehicles from the rear. Therefore, before initiating a lane change, always check blind spots, lane markings, and the surrounding roadway to confirm it is safe and appropriate to move into the target lane.
- ⚠ Warning:** Never depend on Auto Lane Change to determine an appropriate driving path. Drive attentively by watching the road and traffic ahead of you, checking the surrounding area, and monitoring the touchscreen for warnings. Always be prepared to take immediate action.
- ⚠ Warning:** Do not use Auto Lane Change on city streets or on roads where traffic conditions are constantly changing and where bicycles and pedestrians are present.
- ⚠ Warning:** The performance of Auto Lane Change depends on the ability of the camera(s) to recognize lane markings.
- ⚠ Warning:** Do not use Auto Lane Change on winding roads with sharp curves, on icy or slippery roads, or when weather conditions (such as heavy rain, snow, fog, etc.) may be obstructing the view from the camera(s) or sensors.

- ⚠ Warning:** Failure to follow all warnings and instructions can result in serious property damage, injury or death.

Operating Auto Lane Change

Before you can operate Auto Lane Change, you must enable it by touching **Controls > Autopilot > Auto Lane Change > ON**.

Note: Before you can turn on Auto Lane Change, you must turn on Autosteer (see [Autosteer](#) on page 64). Without Autosteer, Auto Lane Change cannot operate.

Note: Your chosen setting is retained until you manually change it.

To change lanes using Auto Lane Change:

1. Perform visual checks to make sure it is safe and appropriate to move into the target lane.
2. Engage the appropriate turn signal.
3. Disengage the turn signal after you are in the target lane.

Auto Lane Change moves Model 3 into the adjacent lane in the direction indicated by the turn signal, provided the following conditions are met:

- The Auto Lane Change setting is turned on.
- The turn signal is engaged.
- Autosteer is actively steering Model 3.
- The ultrasonic sensors do not detect a vehicle or obstacle up to the center of the target lane.
- The lane markings indicate that a lane change is permitted.
- The view of the camera(s) is not obstructed.
- Lane Assist does not detect a vehicle in the blind spot (see [Lane Assist](#) on page 74).
- Midway through the lane change, Auto Lane Change can detect the outside lane marking of the target lane.
- Driving speed is at least 30 mph (45 km/h).

As the lane change is in progress, Overtake Acceleration is activated, allowing Model 3 to accelerate closer to a vehicle in front (see [Overtake Acceleration](#) on page 61). Midway through the lane change, Auto Lane Change must be able to detect the target lane's outside lane marking. If this lane marking cannot be detected, both Auto Lane Change and Autosteer will cancel.



Note: Auto Lane Change moves Model 3 one lane at a time. Moving into an additional lane requires you to engage the turn signal a second time after the first lane change is complete.

Warning: If Auto Lane Change aborts during a lane change (for example, Auto Lane Change cannot detect the outside of the target lane midway through the lane change), Model 3 returns to its original driving lane.

When Auto Lane Change is active, it is important to monitor its performance by watching the driving path in front of you and the surrounding area. Stay prepared to take over steering at any time. As you are crossing over into the adjacent lane, the touchscreen displays the lane marking as a dashed blue line. Once in your new lane, lane markings are displayed as solid blue lines again.

In situations where Auto Lane Change is unable to operate at optimal performance, or cannot operate due to inadequate data, the touchscreen displays a series of warnings. Therefore, when using Auto Lane Change, always pay attention to the touchscreen and be prepared to manually steer Model 3.

Warning: When Auto Lane Change is actively steering Model 3, the steering wheel moves accordingly. Any significant restriction of or force on the steering wheel's movement can cancel both Auto Lane Change and Autosteer.

Canceling Auto Lane Change

Auto Lane Change cancels when you manually move the steering wheel, press the brake pedal, or disengage the turn indicator before Model 3 crosses the markers on the existing lane.

To disable Auto Lane Change so it is no longer available, touch **Controls > Autopilot > Auto Lane Change > OFF**.

Limitations

Auto Lane Change is particularly unlikely to operate as intended in the following types of situations:

- Auto Lane Change is unable to accurately determine lane markings. For example, lane markings are excessively worn, have visible previous markings, have been adjusted due to road construction, are changing quickly (lanes branching off, crossing over, or merging), objects or landscape features are casting strong shadows on the lane markings, or the road surface contains pavement seams or other high-contrast lines.
- A vehicle is detected in your blind spot when you engage the turn signal.
- The road has sharp curves.
- Visibility is poor (due to heavy rain, snow, fog, etc.) or weather conditions are interfering with sensor operation.
- Bright light (oncoming headlights or direct sunlight) is interfering with the view of the camera(s).
- A sensor or camera is damaged or obstructed (such as by mud, fog, ice, snow, etc.).
- The sensors are affected by other electrical equipment or devices that generate ultrasonic waves.
- Model 3 is being driven very close to a vehicle in front of it, which is blocking the view of the camera(s).

Warning: Many unforeseen circumstances can impair the operation of Auto Lane Change. Always keep this in mind and remember that as a result, Auto Lane Change may not steer Model 3 appropriately. Always drive attentively and stay prepared to immediately take action at any time.



If you have purchased the optional Enhanced Autopilot or Full Self-Driving Capability package, Autopark uses data from the ultrasonic sensors and GPS to:

- Simplify parking on public roads by maneuvering Model 3 into parallel and perpendicular parking spaces. See [Parking on Public Roads](#) on page 69.
- Automatically park and retrieve Model 3 from outside the vehicle on a private residential property. See [Using Summon](#) on page 71.

Warning: Summon is a BETA feature. Please use this feature with caution, staying prepared to take immediate action at any time.

Warning: Autopark's performance depends on the ability of the ultrasonic sensors to determine the vehicle's proximity to curbs, objects, and other vehicles.

Parking on Public Roads

When driving, follow these steps to allow Autopark to maneuver Model 3 into a parking space:

1. When driving slowly on a public road, monitor the touchscreen to determine when Autopark has detected a parking space. When Autopark detects a potential parking space, the touchscreen displays a parking icon. Autopark detects parallel parking locations when driving below 15 mph (24 km/h) and perpendicular parking locations when driving below 10 mph (16 km/h).

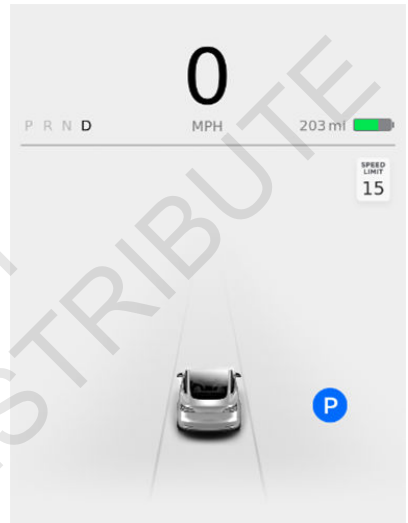

Note: The parking icon appears only if the vehicle's position and/or the circumstances of the surrounding area are such that Autopark can determine an appropriate driving path. If Autopark cannot determine an appropriate path (for example, when driving on a narrow street where moving into the parking space causes the front of the vehicle to extend into the adjacent lane), you can either reposition the vehicle, find a different parking space, or park manually.

2. Check to determine if the detected parking space is appropriate and safe. If so, pull forward and stop approximately a car length ahead of the parking space (as you normally would when parallel parking or when backing into a perpendicular parking space).
3. Release the steering wheel, shift Model 3 into Reverse, then touch **Start Autopark** on the touchscreen.
4. When parking is complete, Autopark displays the "Complete" message.



In situations where Autopark cannot operate due to inadequate sensor data, the touchscreen displays a message indicating that you must manually park Model 3.

Note: If you press the brake when Autopark is actively parking Model 3, the parking process pauses until you touch **Resume** on the touchscreen.

Note: Autopark detects potential perpendicular parking spaces that are at least 9.5 feet (2.9 meters) wide with a vehicle parked on each side. Autopark detects parallel parking spaces that are at least 20 feet (6 meters), but less than 30 feet (9 meters) long. Autopark does not operate on angled parking spaces.

Warning: Never depend on Autopark to find a parking space that is legal, suitable, and safe. Autopark may not always detect objects in the parking space. Always perform visual checks to confirm that a parking space is appropriate and safe.

Warning: When Autopark is actively steering Model 3, the steering wheel moves in accordance with Autopark's adjustments. Do not interfere with the movement of the steering wheel. Doing so cancels Autopark.

Warning: During the parking sequence, continually check your surroundings. Be prepared to apply the brakes to avoid vehicles, pedestrians, or objects.

Warning: When Autopark is active, monitor the touchscreen to ensure that you are aware of the instructions that Autopark is providing.

To Pause Parking

To pause Autopark, press the brake pedal once. Model 3 stops and remains stopped until you touch **Resume** on the touchscreen.

To Cancel Parking

Autopark cancels the parking sequence when you manually move the steering wheel, change gears, or touch **Cancel** on the touchscreen. Autopark also cancels parking when:

- The parking sequence exceeds the maximum of seven moves.
- Model 3 detects that the driver is exiting the vehicle.
- A door is opened.
- You press the accelerator pedal.
- You press the brake pedal while Autopark is paused.
- An Automatic Emergency Braking event occurs (see [Collision Avoidance Assist](#) on page 76).

Limitations

Autopark is particularly unlikely to operate as intended in these situations:

- The road is sloped. Autopark is designed to operate on flat roads only.
 - Visibility is poor (due to heavy rain, snow, fog, etc.).
 - The curb is constructed of material other than stone, or the curb cannot be detected.
 - The target parking space is directly adjacent to a wall or pillar (for example, the last parking space of a row in an underground parking structure).
 - One or more of the ultrasonic sensors is damaged, dirty, or obstructed (such as by mud, ice, or snow).
 - Weather conditions (heavy rain, snow, fog, or extremely hot or cold temperatures) are interfering with sensor operation.
 - The sensors are affected by other electrical equipment or devices that generate ultrasonic waves.
- Warning:** Many unforeseen circumstances can impair Autopark's ability to park Model 3. Keep this in mind and remember that as a result, Autopark may not steer Model 3 appropriately. Pay attention when parking Model 3 and stay prepared to immediately take control.



Using Summon

Note: Summon is a BETA feature. Summon is designed and intended for use only on a private residential property where the surrounding area is familiar and predictable. When using Summon, you must continually monitor the vehicle. It is the driver's responsibility to use this feature safely, responsibly, and as intended.

With Summon, you can move Model 3 in and out of a parking space from outside the vehicle using the mobile app. You can also customize Summon to park or retrieve Model 3 with a single touch of a button and to initiate parking automatically after you double-press the Park gear and exit the vehicle. Using data from the ultrasonic sensors, Summon maneuvers Model 3 forward or reverse into a parking space. When parking is complete Summon shifts Model 3 into Park. Parking is complete when:

- Model 3 detects an obstacle in its driving path (within a chosen distance).
 - Summon has moved Model 3 the maximum distance of 39 feet (12 meters).
- OR
- In the case of reversing, Summon has reached the maximum **Summon Distance**.

To use Summon:

- **FIRST TIME ONLY:** Enable Summon and customize how it works (see [Customizing Summon](#) on page 71).
- Position Model 3 for parking (see [Position the Vehicle for Parking](#) on page 72).
- Initiate the parking maneuver using the mobile app or by double-pressing the Park gear. Detailed instructions for each method are provided later.

You can summon Model 3 back to its original position if you previously Summoned it and the vehicle has remained in the Park gear. Then, using the mobile app, simply specify the opposite direction. Summon moves the vehicle along the original path provided the environment has not changed (i.e. no obstructions have been introduced). If obstacles are detected, Summon attempts to avoid the obstacles while staying as close as possible to its original path.

To cancel Summon and stop Model 3 at any time during a parking maneuver, use the mobile app, press any of the door handles, or (if sitting in the vehicle) interact with the steering wheel, brake pedal, accelerator pedal, or gear stalk.

Note: If you want Summon to move multiple times in the same direction, up to the maximum of 39 feet (12 meters), cancel Summon and then re-initiate the parking process, choosing the same direction.

Note: Summon can move Model 3 a short distance laterally to avoid an obstacle but in doing so, does not return the vehicle to its driving path (i.e. Summon does not attempt to move Model 3 around an obstacle).

Warning: Summon is unable to operate as intended if the ultrasonic sensors are obstructed by a vehicle bra, excessive paint, or adhesive products (such as wraps, stickers, rubber coating, etc.).

Warning: Model 3 cannot detect obstacles that are located lower than the bumper, very narrow (i.e. bicycles), or hanging from a ceiling. In addition, many unforeseen circumstances can impair Summon's ability to move in or out of a parking space and as a result, Summon may not appropriately steer Model 3. Therefore, you must continually monitor the vehicle's movement and surroundings and remain prepared to stop Model 3 at any time.

Customizing Summon

Before operating Summon, use the touchscreen to enable it. Touch **Controls > Autopilot > Summon > ON**.

Then touch **Customize** to specify how Summon operates whenever it parks or retrieves your vehicle:

- **Bumper Clearance:** Set the distance that you want Summon to stop from a detected object. For example, you may want Summon to stop within just a few inches of the garage wall. This distance applies only to objects detected directly in front of (when moving forward) or behind (when reversing) Model 3.
- **Summon Distance:** Specify the distance Model 3 travels when backing out of a parking space.
- **Side Clearance:** Allow Model 3 to enter and exit very narrow parking spaces.

Warning: Parking in a narrow space limits the ability of the sensors to accurately detect the location of obstacles, increasing the risk of damage to Model 3 and/or surrounding objects.



- **Require Continuous Press** (U.S. Only): By default, Summon requires that you press and hold a button on the mobile app to move the vehicle during the parking process. When you set Require Continuous Press to **NO**, you can:
 - Park Model 3 by simply double pressing the Park gear, specifying the direction on the touchscreen (if reversing), then exiting the vehicle.
 - Park or retrieve Model 3 with a single touch of a button on the mobile app.
- **Use Auto HomeLink** (if equipped): Set to **ON** if you want to activate HomeLink to open/close a programmed garage door that meets safety standards during the parking process. If enabled, the garage door automatically opens and closes when Model 3 enters or exits.

Note: This setting automatically opens and closes the garage door only when using Summon. To automate HomeLink in other situations (such as when driving), you must access the HomeLink device's main settings by touching the HomeLink icon on the top of the touchscreen (see [HomeLink Universal Transceiver](#) on page 101).

Warning: Do not use this setting with gates or with a garage door that does not meet safety standards. A garage door opener that does not have safety stop and reverse features (cannot detect an object in its path and then automatically stop and reverse) does not meet these standards. Using a garage door opener without these features increases the risk of injury or death.

Note: All settings associated with Summon are retained until you manually change them.

Position the Vehicle for Parking

Before operating Summon, align Model 3 laterally with the parking space so Model 3 can move straight into the space in either Drive or Reverse. You must also position Model 3 within 39 feet (12 meters) of the parking space (the maximum distance that Summon can move Model 3).

If applicable, open your garage door. As described earlier, this can be automated using Auto HomeLink (if equipped).

Note: Use Summon on flat driveways only where a raised concrete edge does not exceed approximately 1 in (2.5 cm).

Operating Summon with the Mobile App

On the mobile app, start Summon and hold down the forward or reverse button to move Model 3 into the parking space. (U.S. Only): If **Require Continuous Press** is set to **NO** (see [Customizing Summon](#) on page 71), you do not need to hold down the button, just touch and release.

Summon shifts Model 3 into Drive or Reverse (based on the direction you specified) and drives into or out from the parking space.

Note: Summon cancels if your phone enters sleep mode or is turned off.

Initiate Automatic Parking Before Exiting the Vehicle (U.S. Only)

If Require Continuous Press is set to **NO**, you can initiate the parking maneuver from inside Model 3 before exiting:

1. While sitting in Model 3 with the vehicle powered on, double press the Park gear.

The touchscreen displays a message indicating that Summon is engaged, and the touchscreen displays a popup window.

2. On the touchscreen, choose the direction of travel.
3. Exit Model 3 and close the door.

Note: All doors and trunks must be closed.

Note: To cancel the parking maneuver before exiting the vehicle, touch **Cancel** on the popup window.

Note: If no direction of travel was selected on the touchscreen, Model 3 will not attempt the parking maneuver after you exit the vehicle.

Summon now drives Model 3 into the parking space according to the direction you specified on the touchscreen.

Stopping or Canceling Summon

You can stop Model 3 at any time while Summon is active by using the mobile app. Summon also cancels when:

- A door handle is engaged or a door is opened.
- You interact with the steering wheel, brake pedal, accelerator pedal, or gear stalk.



- Model 3 detects an obstacle and cannot move forward for more than approximately two seconds.
- Summon has moved Model 3 the maximum distance of approximately 39 feet (12 meters).

Limitations

Summon is unlikely to operate as intended in the following types of situations:

- The road is sloped. Summon is designed to operate on flat roads only.
- Summon has detected a raised concrete edge when moving forward into the parking location. Summon does not drive over an edge that is higher than approximately 1 in (2.5 cm).
- One or more of the ultrasonic sensors is damaged, dirty, or obstructed (such as by mud, ice, or snow).
- Weather conditions (heavy rain, snow, fog, or extremely hot or cold temperatures) are interfering with sensor operation.
- The sensors are affected by other electrical equipment or devices that generate ultrasonic waves.

Note: Summon is disabled if Model 3 is in Valet mode (see [Valet Mode](#) on page 33).

⚠ Warning: The list above does not represent an exhaustive list of situations that may interfere with proper operation of Autopark's Summon feature. It is the driver's responsibility to remain in control of Model 3 at all times. Pay close attention whenever Summon is actively moving Model 3 and stay prepared to take immediate action. Failure to do so can result in serious property damage, injury or death.



The cameras monitor the markers on the lane you are driving in and the ultrasonic sensors monitor the surrounding areas and the blind spot for the presence of a vehicle or other objects.

When an object is detected in your blind spot or close to the side of Model 3 (such as a vehicle, guard rail, etc.), colored lines radiate from the image of Model 3 on the touchscreen. The location of the lines correspond to the location of the detected object. The color of the lines (white, yellow, orange, or red) represents the object's proximity to Model 3, with white being the farthest and red being very close and requiring your immediate attention. These colored lines only display when driving between approximately 7 and 85 mph (12 and 140 km/h). When Autosteer is active, these colored lines also display if driving slower than 7 mph (12 km/h). However, the colored lines do not display if Model 3 is at a standstill (for example, in heavy traffic).

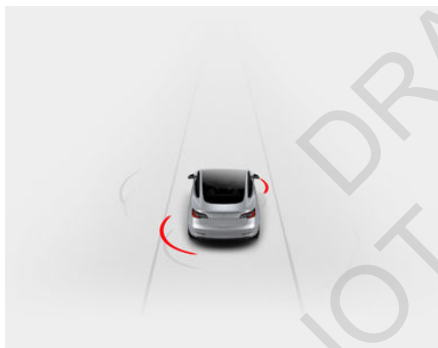

Lane Assist also warns you of undesired lane departures by vibrating the steering wheel slightly if a front wheel passes over a lane marking and the associated turn signal is off. This warning is active only when driving between approximately 36 and 90 mph (59 and 150 km/h). To turn this warning on or off, touch **Controls > Autopilot > Settings > Lane Departure Warning**. Your chosen setting is retained until you manually change it.

In addition to the warnings previously described, Lane Assist may provide steering interventions if Model 3 drifts into (or close to) an adjacent lane in which an object, such as a vehicle, is detected. In these situations, Model 3 automatically steers to a safer position in its driving lane. This steering is applied only when Model 3 is traveling between 30 and 85 mph (48 and 140 km/h) on major roadways with clearly visible lane markings. When Lane Assist applies a steering intervention, the touchscreen briefly displays a warning message.

Warning: Steering interventions are minimal and are not designed to move Model 3 out of its driving lane. Do not rely on steering interventions to avoid side collisions.

Warning: Lane Assist features are for guidance purposes only and are not intended to replace your own direct visual checks. Never depend on Lane Assist to inform you of unintentionally driving outside of the boundaries of the driving lane or informing you that an object or vehicle is in your blind spot or close to the side of your vehicle. Several external factors can reduce the performance of Lane Assist. It is the driver's responsibility to stay alert, pay attention to the driving lane and always be aware of other road users. Failure to do so can result in serious injury or death.

Warning: Lane Assist is designed to detect lane markings and may not detect the edge of a road, especially if the road has no curb. It is the driver's responsibility to drive attentively and stay within the boundaries of the driving lane.

Warning: Before changing lanes, always visually check the lane you are moving into by using side mirrors and performing the appropriate shoulder checks. Several factors can affect the performance of the Lane Assist warnings, resulting in lack of, or false warnings (see [Limitations and Inaccuracies](#) on page 74).

Limitations and Inaccuracies

Lane Assist cannot always clearly detect lane markings and you may experience unnecessary or invalid warnings in these situations:



- Visibility is poor and lane markings are not clearly visible (due to heavy rain, snow, fog, etc.). The exact detection zone of the ultrasonic sensors varies depending on environmental conditions.
- Bright light (such as from oncoming headlights or direct sunlight) is interfering with the view of the camera(s).
- A vehicle in front of Model 3 is blocking the view of the camera(s).
- The windshield is obstructing the view of the camera(s) (fogged over, dirty, covered by a sticker, etc.).
- Lane markings are excessively worn, have visible previous markings, have been adjusted due to road construction, or are changing quickly (for example, lanes branching off, crossing over, or merging).
- The road is narrow or winding.
- Objects or landscape features are casting strong shadows on lane markers.
- One or more of the ultrasonic sensors is damaged, dirty, or obstructed (such as by mud, ice, or snow).
- Weather conditions (heavy rain, snow, fog, or extremely hot or cold temperatures) are interfering with sensor operation.
- The sensors are affected by other electrical equipment or devices that generate ultrasonic waves.
- An object mounted to Model 3 (such as a bike rack or a bumper sticker) is interfering with or obstructing a sensor.
- Visibility is poor and lane markings are not clearly visible (due to heavy rain, snow, fog, etc.).
- Lane markings are excessively worn, have visible previous markings, have been adjusted due to road construction or are changing quickly (for example, lanes branching off, crossing over, or merging).

Lane Assist may not provide warnings, or may apply inappropriate warnings, in these situations:

- One or more of the ultrasonic sensors is damaged, dirty, or obstructed (such as by mud, ice, or snow).
- Weather conditions (heavy rain, snow, fog, or extremely hot or cold temperatures) are interfering with sensor operation.
- The sensors are affected by other electrical equipment or devices that generate ultrasonic waves.
- An object that is mounted to Model 3 is interfering with and/or obstructing a sensor (such as a bike rack or a bumper sticker).

In addition, Lane Assist may not steer Model 3 away from an adjacent vehicle, or may apply unnecessary or inappropriate steering, in these situations:

- You are driving Model 3 on sharp corners or on a curve at a relatively high speed.
- Bright light (such as from oncoming headlights or direct sunlight) is interfering with the view of the camera(s).
- You are drifting into another lane but an object (such as a vehicle) is not present.
- A vehicle in another lane cuts in front of you or drifts into your driving lane.
- Model 3 is traveling slower than 30 mph (48 km/h) or faster than 90 mph (145 km/h).

⚠ Warning: The lists above do not represent every possible situation that may interfere with Lane Assist warnings. Lane Assist may not operate as intended for many other reasons. To avoid a collision, stay alert and always pay attention to the roadway when driving Model 3 so you can anticipate the need to take corrective action as early as possible.



The following collision avoidance features are designed to increase the safety of you and your passengers:

- **Forward Collision Warning** - provides visual and audible warnings in situations when Model 3 detects that there is a high risk of a frontal collision (see [Forward Collision Warning](#) on page 76).
- **Automatic Emergency Braking** - automatically applies braking to reduce the impact of a frontal collision (see [Automatic Emergency Braking](#) on page 77).

Warning: Forward Collision Warning is for guidance purposes only and is not a substitute for attentive driving and sound judgment. Keep your eyes on the road when driving and never depend on Forward Collision Warning to warn you of a potential collision. Several factors can reduce or impair performance, causing either unnecessary, invalid, inaccurate, or missed warnings. Depending on Forward Collision Warning to warn you of a potential collision can result in serious injury or death.

Warning: Automatic Emergency Braking is not designed to prevent a collision. At best, it can minimize the impact of a frontal collision by attempting to reduce your driving speed. Depending on Automatic Emergency Braking to avoid a collision can result in serious injury or death.

Forward Collision Warning

The forward looking camera(s) and the radar sensor monitor the area in front of Model 3 for the presence of an object such as a vehicle, bicycle, or pedestrian. If a collision is considered likely unless you take immediate corrective action, Forward Collision Warning is designed to sound a chime and highlight the vehicle in front of you in red on the touchscreen. If this happens, **TAKE IMMEDIATE CORRECTIVE ACTION!**



Warnings cancel automatically when the risk of a collision has been reduced (for example, you have decelerated or stopped Model 3, or the object in front of your vehicle has moved out of your driving path).

If immediate action is not taken when Model 3 issues a Forward Collision Warning, Automatic Emergency Braking (if enabled) may automatically apply the brakes if a collision is considered imminent (see [Automatic Emergency Braking](#) on page 77).

By default, Forward Collision Warning is turned on. To turn it off or adjust its sensitivity, touch **Controls > Autopilot > Settings > Forward Collision Warning**. Instead of the default warning level of **Medium**, you can turn the warning **Off**, or you can choose to be warned **Late** or **Early**.

Note: Your chosen setting for Forward Collision Warning is retained until you manually change it.

Warning: The camera(s) and sensors associated with Forward Collision Warning are designed to monitor an approximate area of up to 525 feet (160 meters) in your driving path. The area being monitored by Forward Collision Warning can be adversely affected by road and weather conditions. Use appropriate caution when driving.

Warning: Forward Collision Warning is designed only to provide visual and audible alerts. It does not attempt to apply the brakes or decelerate Model 3. When seeing and/or hearing a warning, it is the driver's responsibility to take corrective action immediately.



- ⚠️ **Warning:** Forward Collision Warning may provide a warning in situations where the likelihood of collision may not exist. Stay alert and always pay attention to the area in front of Model 3 so you can anticipate whether any action is required.
- ⚠️ **Warning:** Forward Collision Warning operates only when driving between approximately 7 mph (10 km/h) and 90 mph (150 km/h).
- ⚠️ **Warning:** Forward Collision Warning does not provide a warning when the driver is already applying the brake.

Automatic Emergency Braking

The forward looking camera(s) and the radar sensor are designed to determine the distance from an object (vehicle, motorcycle, bicycle, or pedestrian) traveling in front of Model 3. When a frontal collision is considered unavoidable, Automatic Emergency Braking is designed to apply the brakes to reduce the severity of the impact.

When Automatic Emergency Braking applies the brakes, the touchscreen displays a visual warning and sounds a chime. You may also notice abrupt downward movement of the brake pedal. The brake lights turn on to alert other road users that you are slowing down.

Emergency Braking in Progress

If driving 29 mph (46 km/h) or faster, the brakes are released after Automatic Emergency Braking has reduced your driving speed by 25 mph (40 km/h). For example, if Automatic Emergency Braking applies braking when driving 56 mph (90 km/h), it releases the brakes when your speed has been reduced to 31 mph (50 km/h).

Automatic Emergency Braking operates only when driving between approximately 7 mph (10 km/h) and 90 mph (150 km/h).

Automatic Emergency Braking does not apply the brakes, or stops applying the brakes, when:

- You turn the steering wheel sharply.
- You press and release the brake pedal while Automatic Emergency Braking is applying the brakes.

- You accelerate hard (the pressure on the accelerator pedal increases from below 90% to above 90%) while Automatic Emergency Braking is applying the brakes.
- The vehicle, motorcycle, bicycle, or pedestrian is no longer detected ahead.

Automatic Emergency Braking is always enabled when you start Model 3. To disable it for your current drive, touch **Controls** > **Autopilot** > **Settings** > **Automatic Emergency Braking** > **OFF**.

⚠️ **Warning:** It is strongly recommended that you do not disable Automatic Emergency Braking. If you disable it, Model 3 does not automatically apply the brakes in situations where a collision is considered likely.

⚠️ **Warning:** Automatic Emergency Braking is designed to reduce the severity of an impact. It is not designed to avoid a collision.

⚠️ **Warning:** Several factors can affect the performance of Automatic Emergency Braking, causing either no braking or inappropriate or untimely braking. It is the driver's responsibility to drive safely and remain in control of the vehicle at all times. Never depend on Automatic Emergency Braking to avoid or reduce the impact of a collision.

⚠️ **Warning:** Automatic Emergency Braking is designed to reduce the impact of frontal collisions only and does not function when Model 3 is in Reverse.

⚠️ **Warning:** Automatic Emergency Braking is not a substitute for maintaining a safe traveling distance between you and the vehicle in front of you.

⚠️ **Warning:** The brake pedal moves downward abruptly during automatic braking events. Always ensure that the brake pedal can move freely. Do not place material under or on top of the Tesla-supplied driver's floor mat (including an additional mat) and always ensure that the driver's floor mat is properly secured. Failure to do so can impede the ability of the brake pedal to move freely.

Note: For advance notice of an Automatic Emergency Braking event, turn on Forward Collision Warning (see [Forward Collision Warning](#) on page 76). When turned on, you hear a chime and see a collision warning on the touchscreen if a collision is considered likely. Then, if you do not take immediate



corrective action, a collision is considered imminent and Automatic Emergency Braking applies braking to reduce driving speed. If enabled, Automatic Emergency Braking applies braking when a collision is considered inevitable, even if Forward Collision Warning is turned off.

Limitations and Inaccuracies

Collision Avoidance features cannot always detect all objects, vehicles, bikes, or pedestrians, and you may experience unnecessary, inaccurate, invalid, or missed warnings for many reasons, particularly if:

- The road has sharp curves.
- Visibility is poor (due to heavy rain, snow, fog, etc.).
- Bright light (such as from oncoming headlights or direct sunlight) is interfering with the view of the camera(s).
- The radar sensor is obstructed (dirty, covered, etc.).
- The windshield is obstructing the view of the camera(s) (fogged over, dirty, covered by a sticker, etc.).

⚠ Warning: The limitations previously described do not represent an exhaustive list of situations that may interfere with proper operation of Collision Avoidance Assist features. These features may fail to provide their intended function for many other reasons. It is the driver's responsibility to avoid collisions by staying alert and paying attention to the area beside Model 3 so you can anticipate the need to take corrective action as early as possible.

⚠ Caution: If a fault occurs with a Collision Avoidance Assist feature, Model 3 displays an alert. Contact Tesla Service.



How Speed Assist Works

When the Speed Limit Warning is turned on, the touchscreen displays a speed limit as determined by GPS data. You can touch this speed limit sign to automatically change the set speed to the detected speed limit (including any offsets that you have set). Warnings (described later) take effect when you exceed this limit.

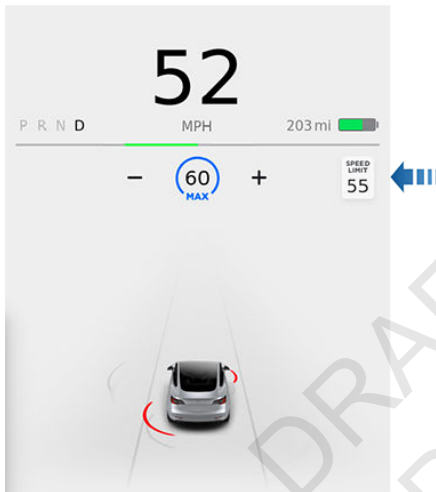

In situations where Speed Assist is unable to determine a speed limit (for example, speed limit signs and GPS data are not available at the current location), or if Speed Assist is uncertain that an acquired speed limit is accurate (for example, although a speed limit sign was initially detected, some time has passed before a subsequent sign has been detected), the touchscreen may not display a speed limit sign and warnings do not take effect.

If you set the speed limit warning to **Display** (see [Controlling Speed Assist](#) on page 79) and exceed the determined speed limit, the speed limit sign on the touchscreen increases in size.

If you set the speed limit warning to **Chime** (see [Controlling Speed Assist](#) on page 79) and exceed the determined speed limit, the speed limit sign on the touchscreen increases in size and Model 3 also sounds a warning chime.

Note: Speed limit warnings go away after ten seconds, or when Model 3 slows down below the specified limit.

Warning: Do not rely on Speed Assist to determine the appropriate speed limit or driving speed. Always drive at a safe speed based on traffic and road conditions.

Controlling Speed Assist

To adjust the Speed Limit Warning setting, touch **Controls > Autopilot > Settings > Speed Limit Warning**, then choose one of these options:

- **Off** - Speed limit warnings do not display and chimes are not sounded.
- **Display** - Speed limit signs display on the touchscreen and the sign increases in size when you exceed the determined limit.
- **Chime** - In addition to the visual display, a chime is sounded whenever you exceed the determined speed limit.

You can also specify how the speed limit is determined:

- **Relative** - The speed limit is determined automatically based on detected traffic signs and GPS data. If desired, you can set a speed limit offset (+ or -) if you want to be alerted only when you exceed the offset speed limit by a specified amount. For example, you can increase the offset to +10 mph (10 km/h) if you only want to be warned when you exceed the speed limit by 10 mph (10 km/h).
- **Absolute** - Manually specify any speed limit between 20 and 140 mph (30 and 240 km/h).

Note: GPS data is not always accurate. The GPS can miscalculate a road's location and provide the speed limit for a directly adjacent road that may have a different speed limit. For example, the GPS can assume Model 3 is on a freeway or highway when it is actually on a nearby surface street, and vice versa.

Note: Your chosen setting is retained until you manually change it.

Limitations and Inaccuracies

Speed Assist may not be fully functional or may provide inaccurate information in these situations:

- The speed limits stored in the GPS database are incorrect or outdated.
- Model 3 is being driven in an area where GPS data is not available.



- A road or a speed limit has recently changed.

⚠ Warning: The list above does not represent an exhaustive list of situations that may interfere with proper operation of Speed Assist. Speed Assist may fail to provide warnings for many other reasons.

DRAFT
DO NOT DISTRIBUTE



Overview



Touch **Controls** on the bottom left corner of the touchscreen to control features and customize Model 3 to suit your preferences. The Controls window (shown below) appears over the map. Touch an option on the left side of the window to display the associated controls and settings. By default, Quick Controls displays to make it easy to access commonly used settings.



To close the Controls window, touch the **X** in the top left corner or touch **Controls** again.



To access **Settings** associated with a Controls window (if applicable), touch the gear icon in the top right corner of a Controls window.

Note: Throughout this owner's manual, Settings is used when referring to this gear icon.

Note: The following illustration is for demonstration purposes only. Depending on vehicle options, software version and market region, the options available may be different.

1. List of available controls. When you select an item from this list, its associated controls display in the main viewing area.
2. Main viewing area. The options available for your chosen controls category display here.

Quick Controls

Quick Controls gives you access to these commonly used features:

- Control the exterior lights.
- Adjust the mirrors (see [Adjusting Exterior Mirrors](#) on page 36).
- Fold the mirrors (see [Mirrors](#) on page 36).
- Lock the rear window switches (see [Windows](#) on page 11).
- Adjust the brightness of the display.

Lights

Control exterior and interior lights (see [Lights](#) on page 42).

Touch **Settings** to customize the following:

- **Headlights after Exit:** If on, the headlights remain on when you stop driving and park Model 3 in low lighting conditions. They automatically turn off after one minute or when you lock Model 3.
- **Steering Wheel Lights:** If on, the arrows associated with the scroll buttons on the steering wheel are backlit when the headlights are turned on.



Locks

Display a list of keys that can access Model 3, remove phone keys (see [Managing Keys](#) on page 7), and customize how you want door locks to behave:

- **Window Lock:** Lock the rear window switches (see [Windows](#) on page 11).
- **Child Lock:** If on, safety locks prevent the rear doors from being opened from inside the vehicle (see [Child Protection Lock](#) on page 10).

Touch **Settings** to customize the following:

- **Unlock on Park:** If on, doors automatically unlock when you engage the Park gear (see [Interior Locking and Unlocking](#) on page 10).
- **Walk Away Lock:** If on, doors automatically lock when you walk away from the vehicle, carrying your authenticated phone with you (see [Walk Away Lock](#) on page 10).

Display

Manually control the brightness and the **DAY** (light background) or **NIGHT** (dark background) setting of the touchscreen. When set to **AUTO**, the brightness changes automatically between day and night brightness based on ambient lighting conditions.

Brightness: Drag the slider to manually control the brightness level of the touchscreen. When **Auto** brightness is on, the touchscreen is further adjusted based on both the surroundings and by learning your preferences (i.e. it remembers the type of manual adjustments you make).

Screen Clean Mode: Disable the touchscreen momentarily for cleaning purposes.

Touch **Settings** to customize how units are displayed:

- **Time Format:** Choose if time is displayed in 12 or 24 hour format.
- **Energy Display:** Display remaining energy and charging units as either a percentage of battery energy remaining, or as an estimate of the distance that you can drive.
- **Distance:** Choose if miles or kilometers are used when displaying range, speed, energy, trip meters, map searches and navigation routes.
- **Temperature:** Choose if temperature is displayed in °C or °F.
- **Tire Pressure:** Choose if tire pressures are displayed in BAR or PSI.

Note: In some regions, you can also select the language displayed on the touchscreen and the language used for navigation.



Driving

Acceleration: Adjust the amount of acceleration. **Chill** limits acceleration for a slightly smoother and gentler ride, whereas **Standard** provides the normal level of acceleration.

Note: When Chill is selected, **Chill** displays on the touchscreen above the driving speed.

Steering Mode: Adjust the amount of effort required to turn the steering wheel. Sport feels more responsive whereas Comfort feels easier to drive and park (see [Adjusting Steering Effort](#) on page 35).

Regenerative Braking: When you release the accelerator when driving, regenerative braking slows Model 3 and feeds any surplus energy back to the Battery. If set to **LOW**, Model 3 does not slow down as quickly, but also feeds less energy back to the Battery (see [Regenerative Braking](#) on page 46).

Note: Regardless of the setting selected, the energy gained by regenerative braking is reduced if the Battery is full, or is extremely cold or hot (in which case, surplus energy is used to heat or cool it).

Traction Control: Turn slip start on to allow wheels to spin (see [Traction Control](#) on page 48).

Creep: When on, Model 3 applies forward torque in Drive and backwards torque in Reverse when you release the brake pedal (similar to a conventional vehicle with an automatic transmission). The torque moves the vehicle slowly on flat roads, but may require you to press the accelerator pedal in some situations (for example, when on a steep hill or driveway). When off, Model 3 is free rolling when you let your foot off the brake pedal and the motor does not apply torque until the accelerator pedal is pressed. You can adjust this setting only when Model 3 is in Park.

⚠ Warning: Never rely on Creep to apply enough torque to prevent your vehicle from rolling down a hill. Always apply brakes to remain stopped or the accelerator to proceed up the hill. Failure can result in property damage and/or a collision.



Autopilot

Control the features that provide a safer and more convenient driving experience (see [About Autopilot](#) on page 55).

- **Cruise Follow Distance:** Adjust the following distance you want to maintain between Model 3 and a vehicle traveling ahead of you (available only if your Model 3 is equipped with Enhanced Autopilot) (see [Traffic-Aware Cruise Control](#) on page 58).
- **Autosteer (Beta):** Enable the auto steering feature (available only if your Model 3 is equipped with Enhanced Autopilot) (see [Autosteer](#) on page 64).
- **Auto Lane Change:** Enable Model 3 to change lanes when using Autosteer when you enable a turn signal (available only if your Model 3 is equipped with Enhanced Autopilot) (see [Auto Lane Change](#) on page 67).

Touch **Settings** to customize the following:

- **Speed Limit Warning:** Specify the type of warnings, if any, you receive when you exceed the detected speed limit (see [Speed Assist](#) on page 79).
- **Speed Limit:** Specify if you want Speed Assist to use a relative (with offset) or an absolute speed limit (see [Speed Assist](#) on page 79).
- **Offset:** If relative speed limit is selected, set a speed limit offset if you want to be alerted only when you exceed the offset speed limit by a specified amount (see [Speed Assist](#) on page 79).
- **Forward Collision Warning:** Specify if and when you want to receive visual and audible warnings in situations where there is a high risk of a frontal collision (see [Collision Avoidance Assist](#) on page 76).
- **Lane Departure Warning:** Specify if you want the steering wheel to vibrate slightly if a front wheel passes over a lane marking and the associated turn signal is off (see [Lane Assist](#) on page 74).
- **Automatic Emergency Braking:** Specify if you want Model 3 to automatically apply braking when a frontal collision is imminent (see [Collision Avoidance Assist](#) on page 76).

Safety & Security

You can manually apply and release the parking brake (see [Parking Brake](#) on page 47) and power off Model 3 (see [Powering Off](#) on page 37).

Touch **Settings** to customize the following:

- **Park Assist Chimes:** If on, you will hear an audible beep when approaching an object while parking (see [Park Assist](#) on page 49).
- **Security Alarm:** Enable the security alarm (see [Security Settings](#) on page 100).
- **Allow Mobile Access:** Allow Tesla's mobile applications to access your Model 3 (see [Mobile App](#) on page 7).
- **Data Sharing:** Allow sharing of road measurement data (see [Data Sharing](#) on page 153).



- Service**
- Wiper Service Mode:** Make wiper blades easy to access (see [Wiper Blades and Washer Jets](#) on page 122).
 - Adjust Headlights:** Make adjustments to the level of the headlights to accommodate a load you are carrying (see [Headlight Adjustments](#) on page 43).
 - ⚠ Caution:** Headlights should only be adjusted by Tesla Service.
 - Towing:** Prepare Model 3 for towing by keeping it in Neutral (which disengages the parking brake and prevents damage to the rear motor that is caused by wheels turning as Model 3 is pulled onto a flatbed truck). See [Instructions for Transporters](#) on page 146.
 - Owner's Manual:** Display this manual.
 - Note:** You can also access the manual by touching the Tesla "T".
- Glovebox** Open the glovebox (see [Glovebox](#) on page 16).

Naming Your Vehicle

To further personalize your Tesla vehicle, you can name it. The name you give your Model 3 will appear in the mobile app and on the touchscreen. To name your vehicle, touch the Tesla "T" at the top center of the touchscreen, then touch **Name Your Vehicle**.

When you save, **Name Your Vehicle** is replaced by the name you provided. You can touch the name at any time to rename your vehicle.



Controlling Climate

The primary climate controls are always available at the bottom of the touchscreen. To turn the climate control system on, touch the fan icon or touch the up or down arrow to adjust the cabin temperature.

By default, climate control is set to the Auto setting, which maintains optimum comfort in all but the most severe weather conditions. When you adjust the cabin temperature in the Auto setting, the system automatically adjusts the heating, air conditioning, air distribution, air circulation, and fan speed to maintain the cabin at your selected temperature. To override the Auto setting, touch the fan icon then manually change your settings in the window that appears (see [Customizing Climate Control](#) on page 87).

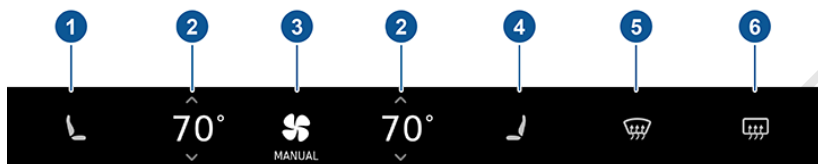

1. Driver's seat heater. Seat heaters operate at three setting levels from 3 (highest) to 1 (lowest). When operating, the associated seat icon displays twisting lines that turn red to indicate the setting level.
2. Touch the up or down arrow to change the cabin temperature. To apply a temperature setting to both the driver and passenger side at the same time, touch **SYNC TEMP** on the temperature popup that appears when you touch an arrow.
3. Climate control setting (fan icon). Touch to turn on climate control. The default setting is AUTO where heating, air conditioning, air distribution, and fan speed automatically adjust to maintain your desired cabin temperature. Touch to display a popup where you can manually customize the settings to suit your preferences (see [Customizing Climate Control](#) on page 87). The current setting (Auto or Manual) displays below the fan icon.
4. Front passenger seat heater. Seat heaters operate at three setting levels from 3 (highest) to 1 (lowest). When operating, the associated seat icon displays twisting lines that turn red to indicate the setting level.
5. The windshield defroster distributes air flow to the windshield. Touch once to defog the windshield (the button turns blue). Touch a second time to defrost the windshield (the button turns red and the heating and fan operate at maximum levels). Touch a third time to turn off and restore the air distribution, heating, and fan to their previous settings.
6. The rear window defroster warms up the rear window. Touch to turn on. Touch a second time to turn off. If the rear window defroster is on continuously for 15 minutes, it automatically turns off.

Warning: To avoid burns resulting from prolonged use, individuals who have peripheral neuropathy, or whose capacity to feel pain is limited because of diabetes, age, neurological injury, or some other condition, should exercise caution when using the climate control system and seat heaters.



Customizing Climate Control

To override the Auto setting, touch the fan icon then manually change any of the settings in the popup that appears.

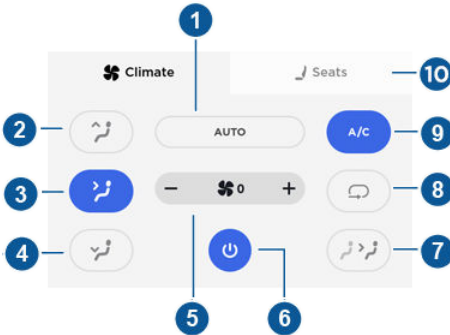

1. Touch **AUTO** to change all settings back to the Auto settings.
2. Touch to turn the windshield vents on or off.
3. Touch to turn the face-level vent on or off.

Note: When you turn on the face-level vent, you can use the grid on each side of the climate control settings window to specify how you want the face-level vent to direct air flow (see [Operating the Face-Level Vent](#) on page 88).

4. Touch to turn the foot-level vents on or off.

Note: When air is directed to the foot-level vents, air continues to flow to the windshield vents to assist in defogging. When air is directed to the face-level vents, no air flows to the windshield.

5. Touch + or - to increase or decrease the speed of the fan.

Note: Adjusting the fan speed may change the selected setting for how air is drawn into Model 3 in order to increase or reduce air flow.

6. Touch to turn the climate control system off.
7. Touch to turn air flow to the rear cabin area on or off. When on, air flows from the vent located at the back of the center console.
8. Touch to choose how air is drawn into Model 3. If on, air inside Model 3 is recirculated. If off, outside air is drawn into Model 3.
9. Touch to turn the air conditioning system on or off. Turning it off reduces cooling, but saves energy.

Note: Because Model 3 runs much quieter than a gasoline-powered vehicle, you may notice the sound of the air conditioning compressor as it is operating. To minimize noise, reduce the fan speed.

10. If equipped with the premium package, touch **Seats** to access controls for both front and rear seat heaters.



Operating the Face-Level Vent

Model 3 has a unique horizontal face-level vent that spans the width of the dashboard. Using the touchscreen, you can pinpoint exactly where you want to direct the air flowing from this vent when heating or cooling the cabin area.

When the face-level vent is turned on (see [Customizing Climate Control](#) on page 87), you can control the driver and passenger side separately using the corresponding grids that appear on each side of the climate control settings window.

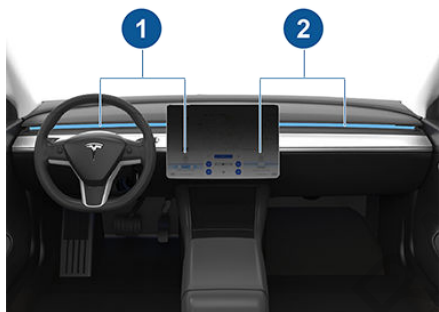

1. Driver vent and control grid
2. Passenger vent and control grid



Simply drag the oblong or circle(s) on the control grid to direct air flow from the corresponding vent to wherever you want it. You can also touch a location on the grid to move the oblong or circle(s) to that location.

Note: The line across the center of the grid represents the center of the headrest on the corresponding front seat.

This example illustrates how moving the single oblong in the driver's side control grid to the top left directs all air from the driver's vent upwards and to the left of the driver.



You can toggle between having the air flow from the vent in a single direction (represented on the control grid by an oblong shape) or in two mirrored directions (represented on the control grid by two circles). To do so, touch the combine/split icon. The icon changes based on whether air flow is combined or split.

-  When air flow from the vent is combined, touching the split icon causes the air to flow in two directions. The control grid will then display two circles.
-  When air flow from the vent is split, touching the combine icon causes the air to flow in a single direction. The control grid will then display a single oblong.

When splitting the vent, the two circles on the control grid move in unison—when you move one of the circles, the other circle mirrors it. For example, when you move a circle to direct air inward (towards your face) or outward (away from your face), the other circle moves accordingly.

This example illustrates how moving the two circles in the driver's side control grid to the bottom outward corners directs the air in two directions, downward and outward (on either side of the headrest).



Note: When you split a vent into two separate air flows, the air flow in each direction is not as strong as when all air is flowing in a single direction.

Note: Outside air is drawn into Model 3 through the grill in front of the windshield. Keep the grill clear of obstructions, such as leaves and snow.



Climate Control Operating Tips

- You can direct the face-level vents toward the windows to help defrost or defog them.
- When you use the mobile app to turn on the climate control system, it automatically turns off after 30 minutes. To cool or heat the cabin for a longer period, you must turn it on again.
- If the climate control system is louder than you prefer, manually reduce the fan speed.
- In addition to cooling the interior, the air conditioning compressor also cools the Battery. Therefore, in hot weather, the air conditioning compressor can turn on even if you turned it off. This is normal because the system's priority is to cool the Battery to ensure it stays within an optimum temperature range to support longevity and optimum performance.
- To ensure the climate control system operates efficiently, close all windows and ensure that the exterior grill in front of the windshield is free of ice, snow, leaves, and other debris.
- In very humid conditions, it is normal for the windshield to fog slightly when you first turn on the air conditioning.
- It is normal for a small pool of water to form under Model 3 when parked. Extra water produced by the dehumidifying process is drained underneath.

Cabin Air Filter

Model 3 has an air filter that prevents pollen, industrial fallout, road dust and other particles from entering through the vents. The air filter should be replaced when necessary. Contact Tesla.



Overview

Touch the **Media Player** app to listen to FM or Internet radio, stream music or podcasts (if available), or play audio files from a Bluetooth or USB-connected device.

Available source content displays across the top of Media Player: Radio, Streaming, TuneIn, and Phone. An additional source, USB, displays when you insert a flash drive into a USB port in the front console. Touch a source to browse the content available for your chosen source.

You can use the Now Playing view, which displays at the bottom of Media Player, to control what's currently playing (for example, pausing/playing, skipping to the next track/station, etc.). You can also use the Now Playing view to mark what's playing as a favorite (see [Favorites and Recent](#) on page 91), and access recently played and favorite stations, music, and podcasts. You can maximize and minimize the Now Playing view simply by touching the up or down arrow in the top right corner.

Volume Control

Roll the scroll wheel on the left side of the steering wheel up or down to increase or decrease volume respectively. The scroll wheel adjusts the volume for media, navigation instructions, or phone calls, based on what is currently being heard through the speakers. If you're listening to a song, audio file, or podcast, and you receive a phone call or if the navigation system is speaking directions, the song, audio file, or podcast is muted temporarily.

You can also adjust the volume by touching the arrows associated with the speaker icon on the bottom of the touchscreen.

To mute the volume, press the left scroll button.

Note: Pressing the left scroll button during a phone call mutes both the sound and your microphone.

Audio Settings



Press the equalizer icon at the top of Media Player to access audio settings for tone and balance.

To adjust any of the five frequency bands (Bass, Bass/Mid, Mid, Mid/Treble, and Treble) touch **Tone** and drag the corresponding slider up or down the decibel (dB) bar.

To adjust balance, touch **Balance** and drag the center circle of the cross bars to the location in Model 3 where you want to focus the sound.

Searching within Media Player

You can search across all types of source content, or you can limit your search to a particular source. Search results can include content from:

- TuneIn
- Streaming Radio
- USB content

To search, touch anywhere in Media Player's search bar and enter the name of the song, album, artist, podcast, playlist, or station you want to search for. Select a filter to narrow the scope of your search to a specific source, or leave it at its default setting to include results from all sources.

Note: You can also search hands-free using voice commands (see [Using Voice Commands](#) on page 99).

If you are using TuneIn, you can browse content by category from the Browse area of the TuneIn source. You can browse content by location, local radio, talk radio, favorites, and other categories. To return from browsing or to select another category to browse, simply touch **TuneIn** at the top of Media Player.

FM Radio

If it is available in your location, Media Player provides FM radio service that you can select from the Radio source. To tune the radio to a specific frequency, choose a frequency and then touch the next or previous arrows to move from one frequency to the next (or previous). You can also tap or drag your finger on the tuner to the desired frequency. The bars on the left side of the frequency number indicate the strength of the signal for the chosen frequency. Touch **HD** to play high definition versions of available frequencies.

Mark a radio station as a favorite to display it on the Radio source for easy access (see [Favorites and Recent](#) on page 91).



Internet Radio

Internet radio services are accessed over a data connection. To use Internet radio, touch Media Player's **Streaming** or **Tuneln** source, browse through the available categories and/or stations, and then touch what you want to play. When browsing through a large category such as genres, a second browse page displays. Use the left arrow button on the left side of Media Player to return to the prior page, or tap on the source again to return to the main browse page.

With your Personal Streaming Radio account, you can create a radio station of your favorite songs and songs that are similar to your favorites. When you like a song by touching **thumbs up**, it is added to your Favorites and is used to tune your listening profile so that similar songs are also added to your Favorites station. If you dislike a song by touching **thumbs down**, the song is removed from your Favorites station.

Note: Your Favorites station is linked to your Personal Streaming Radio account for the car.

To play the next (and in some cases previous) available station, episode, or track being provided by an Internet radio service, touch the next (or previous) arrows on the Now Playing view.

You can also use voice commands (only available when speaking the English language) to play a specific song, artist, or album from an Internet radio service (see [Using Voice Commands](#) on page 99).

When you are listening to internet radio, you can do the following on the Now Playing view:

- Touch the **thumbs up** or **thumbs down** icon (if available) to like or dislike any song or podcast. When you like a song, the radio station plays similar songs. When you dislike a song, the song won't be played again.
- Touch the **DJ** icon (if available) to include commentary for the content you are streaming. DJ commentary includes music history and behind-the-scenes stories.
- Touch the **Favorites** icon to save the radio station or podcast as a favorite (see [Favorites and Recent](#) on page 91).
- Touch any number to access digital radio stations (if available). Digital radio stations provide higher quality sound and, in some cases, different programming than their analog equivalents.

- Touch the **right arrow** to view a list of tracks for a podcast or playlist.

By default, Tuneln uses a Tesla account that has been set up for you. To sign in to a different Tuneln account, scroll to the bottom of the **Tuneln** source, touch **Sign In**, and enter your log in information.

Note: When playing a Tuneln podcast, you can rewind or fast forward to any location in the podcast. On the Now Playing view, drag the arrow below the slider bar to the desired location.

Note: Tesla also provides you with a complimentary Streaming Personal Radio account for four years. To use your own Slacker Plus or Premium account instead, scroll to the bottom of the **Streaming** source, enter your credentials, touch **Use High Bitrate** to stream higher quality sound (if your Model 3 is equipped with the optional Ultra High Fidelity Sound package), and then touch **LOGIN**. To switch back to your Tesla account, simply touch **USE TESLA ACCOUNT**; you don't need to enter a user name or password for your Tesla account. You can purchase your own Slacker Plus or Premium account at www.slacker.com. Model 3 does not support basic (free) Slacker services.

Favorites and Recent

Your favorite stations and audio files always display at the top of Media Player and on the Now Playing view. Regardless of which source you have selected, you have easy access to your favorites from all sources (Streaming, Tuneln, Phone, or USB). You can maximize or minimize source content simply by swiping.

Your USB favorites are available from the Now Playing view in a Favorites folder (you may need to scroll to see the folder). Your first USB favorite plays when you touch the **Favorites** folder in the Now Playing view. Use the next or previous arrows to scroll through your USB favorites.



To add a currently playing radio station, podcast, or audio file to your Favorites list, touch the **Favorites** icon on the Now Playing view. You may need to first expand the Now Playing view by touching the up arrow in the top right corner.



To delete a favorite, touch the highlighted **Favorites** icon. You can also delete one or more favorites on the bottom of the Now Playing view by pressing and holding a favorite. An **X** appears on all favorites. Touch the **X** associated with the favorite(s) you want to delete.

To see selections that you have recently played, touch **Recent** on the Now Playing view. Your recently played selections are updated continuously so you don't need to delete them.

Note: Selections you play on FM radio stations do not display in your Recent selections.

Playing Media from Devices

You can play audio files from a USB-connected flash drive or from a Bluetooth-connected device (like a phone). When you connect a USB flash drive, Media Player displays the flash drive's source content. When you connect a Bluetooth-capable device, the name of the device displays on the Phone source. After connecting a USB flash drive or Bluetooth device, touch the song, album, or playlist you want to play.

To play the next song in a selected playlist or album, touch the previous or next arrows on the Now Playing view. You can also shuffle tracks in a playlist or repeat a playlist or track using the shuffle/repeat icons displayed below the album cover art.

USB Connected Flash Drives

Connect a flash drive to one of the USB connections (see [Interior Storage and Electronics](#) on page 16). Touch **Media Player > USB**, and then touch the name of the folder that contains the song you want to play. After you display the contents of a folder on the USB connected flash drive, you can touch the right arrow in the Now Playing view to display your songs in a list. Touch any song in the list to play it. Or use the previous and next arrows in the Now Playing view to scroll through your songs.

Note: To play media from a USB connection, Model 3 recognizes flash drives only. You can play media from other types of devices (such as an iPod) by connecting to the device using Bluetooth.

Note: Media Player supports USB flash drives with FAT32 formatting (NTFS and exFAT are not currently supported).

Bluetooth® Connected Devices

If you have a Bluetooth-capable device such as a phone that is paired and connected to Model 3 (see [Pairing a Bluetooth Phone](#) on page 93), you can play audio files stored on it. You can also stream a music service from it (for example, Pandora or Spotify). Choose Media Player's **Phone** source, touch **Connect Phone**, touch the name of your Bluetooth-connected device, and then touch **CONNECT**.

Your Bluetooth device begins playing the audio file that is currently active on your device, and Media Player displays the Now Playing view. If no audio file is playing on your device, select the audio file you want to listen to from your device. After an audio file begins to play in Media Player, you can then use Media Player's controls to play other tracks.

Note: To play media from a Bluetooth-connected device, ensure that access to the device's media is turned on (see [Phone](#) on page 93).

Note: Unpairing the phone (see [Unpairing a Bluetooth Phone](#) on page 94) has no effect on using the phone as a key. To forget an authenticated phone, see [Keys](#) on page 6.



Bluetooth[®] Compatibility

You can use your Bluetooth-capable phone hands-free in Model 3 provided your phone is within operating range. Although Bluetooth typically supports wireless communication over distances of up to approximately 30 feet (9 meters), performance can vary based on the phone you are using.

Before using your phone with Model 3, you must pair it. Pairing sets up Model 3 to work with your Bluetooth-capable phone (see [Pairing a Bluetooth Phone](#) on page 93).

You can pair up to ten Bluetooth phones. Model 3 always automatically connects to the last phone that was used (provided it is within range). If you want to connect to a different phone, see [Connecting to a Paired Phone](#) on page 94.

Note: On many phones, Bluetooth turns off if the phone's battery is low.

Note: In addition to phones, you can also pair Bluetooth-enabled devices with Model 3. For example, you can pair an iPod Touch or an iPad or Android tablet to stream music.

Pairing a Bluetooth Phone

Pairing allows you to use your Bluetooth-capable phone hands-free to make and receive phone calls, access your contact list, recent calls, etc. It also allows you to play media files from your phone. Once a phone is paired, Model 3 connects to it whenever it is within range.

Note: Authenticating your phone to use as a Model 3 key (see [Keys](#) on page 6) does not also allow you to use the phone hands-free, play media from it, etc. You must also pair it as described here.

To pair a phone, follow these steps while sitting inside Model 3:

1. Ensure both the touchscreen and the phone are powered on.
2. On the touchscreen's status bar, touch the Bluetooth icon.
3. On your phone, enable Bluetooth and set it to discoverable.
4. On the Model 3 touchscreen, touch **Start Search**. The touchscreen searches for, then displays, the list of the Bluetooth devices within operating distance.

5. On the Model 3 touchscreen, touch the name of the phone you want to pair. Within a few seconds, both the touchscreen and the phone display a randomly generated number.
6. Check that the number on your phone matches the number on the touchscreen. Then, on your phone, confirm that you want to pair.
7. If prompted on your phone, specify whether you want to allow Model 3 to access your contacts and media files. You can enable and disable access to contacts at any time, as described next.

When paired, Model 3 automatically connects to it, and the Bluetooth symbol next to the phone's name on the touchscreen's Bluetooth settings screen is colored blue to indicate that the phone is connected.

Accessing Contacts and Recent Calls

Once paired, use the Bluetooth settings screen (touch the Bluetooth icon on the touchscreen's status bar) to specify whether you want to allow Model 3 to access your phone's contacts and recent calls.

If access is turned on, you can see your list of contacts and recent calls on the Model 3 touchscreen. Touch **Phone > Contacts** or **Phone > Recents**. You can then touch a contact to call the contact or to navigate to the contact's location (if an address is included in the contact's information).

Note: Before contacts can be accessed, you may need to either set your phone to allow access, or respond to a popup on your phone to confirm that it is OK to access contacts. This varies depending on the type of phone you are using. For details, refer to the owner documentation provided with your phone.

Note: You can turn access to your contacts and recent calls on or off at any time by displaying the Bluetooth settings screen, choosing the phone, and then changing the setting associated with contacts and recent calls.



Unpairing a Bluetooth Phone

If you want to disconnect your phone and use it again later, simply touch **Disconnect** on the Bluetooth settings screen. If you do not want to use your phone with Model 3 again, touch **Forget This Device**. Once you forget a device, you need to pair it again if you want to use it with Model 3 (see [Pairing a Bluetooth Phone](#) on page 93).

Note: Your phone automatically disconnects whenever you leave Model 3.

Note: Unpairing the phone has no effect on using the phone as a key. To forget an authenticated phone, see [Keys](#) on page 6.

Connecting to a Paired Phone

Model 3 automatically connects with the last phone to which it was connected, provided it is within operating range and has Bluetooth turned on. If the last phone is not within range, it attempts to connect with the next phone that it has been paired with.

To connect to a different phone, touch the Bluetooth icon on the touchscreen's status bar. The Bluetooth window displays a list of paired phones. Choose the phone you want to connect to, then touch **Connect**. If the phone you want to connect to is not listed, follow the instructions on [Pairing a Bluetooth Phone](#) on page 93.

When connected, the Bluetooth symbol next to the phone's name on the touchscreen's Bluetooth settings screen is colored blue.

Making a Phone Call

To make a phone call, open the phone app, then either:

- Choose a number from your contact or recent calls list (touch **Contacts** or **Recent Calls**, then, in cases where there is more than one number for a contact, touch the number you want to dial).

Note: Ensure that access to the phone's contacts is turned on (see [Accessing Contacts and Recent Calls](#) on page 93).

- Enter a number using the onscreen dialer (touch **Dialer**, enter the phone number, then touch **Call**).
- Speak a voice command (see [Using Voice Commands](#) on page 99).

Note: If it is safe and legal to do so, you can also initiate a call by dialing the number or

selecting the contact directly from your phone. Your phone may prompt you to choose which speakers you want to use for the call.

Note: You can also make a phone call by touching a pin on the map and choosing the phone number (if available) on the popup window (see [Maps and Navigation](#) on page 95).

Receiving a Phone Call

When your phone receives an incoming call, a popup on the touchscreen displays the caller's number. If the caller is in your phone's contact list and Model 3 has access to your contacts, the popup displays the caller's name.

Touch one of the options on the touchscreen to **Answer** or **Ignore** the call.

Note: Depending on the phone you are using and what speakers you used for your most recent call, your phone may prompt you to choose which speakers you want to use for the incoming call.



Overview

The touchscreen displays a map at all times. Hold and drag a finger to move the map in any direction. Rotate the map in any direction using two fingers.

Touch these icons to set the map's orientation and track your location:



North Up - North is always at the top of the screen.



Heading Up - The direction you are driving is always at the top of the screen. The map rotates as you change direction. This icon has an integrated compass that indicates the direction you are driving.

Note: Some of the icons that display on the map disappear after a few seconds when not in use. Touch anywhere on the map to display them.

When you rotate or move the map, your current location is no longer tracked. The message "Tracking Disabled" displays briefly next to the map orientation icon and the icon turns gray. To re-enable tracking, touch the map orientation icon.

Touch the + and - icons to zoom the map in and out on your current or chosen location. When you zoom in or out using these icons, tracking remains enabled.

Touch these icons to customize what the map displays:



Display/hide satellite imagery.



Display/hide traffic conditions. Green lines indicate no traffic; orange lines indicate light traffic; red lines indicate moderate traffic; and pink lines indicate heavy traffic. To ensure traffic is easy to identify along a navigation route, green traffic lines display under the blue route line, whereas orange, red, and pink traffic lines display on top of the blue route line.



Display/hide charging locations and a popup list that includes the city and proximity of the corresponding stations on the map. Charging locations include Tesla Superchargers, destination chargers, and public chargers that you have used previously. See [Charging Locations](#) on page 96.



Display map/navigation settings:

- Touch **Trip Planner** to minimize the time you spend driving and charging (see [Trip Planner](#) on page 97).
- Touch **Online Routing** to be automatically rerouted to avoid heavy traffic (see [Routing Preferences](#) on page 97).
- Touch **Always Show Estimated Round Trip Energy** to include an estimate of your round trip energy usage in the turn-by-turn direction list when navigating to a destination (see [Predicting Energy Usage](#) on page 97).

When you touch a pin on the map, the chosen location is centered on the map, and a popup window provides information about the location. Use the popup window to navigate to the location, to call the location (if a phone number is available) and to add or remove the location from your list of favorite destinations (see [Favorite Destinations](#) on page 98).

Drop a pin anywhere on the map by pressing and holding your finger on a location on the map.

Navigating

Touch **Navigate**, or speak a voice command (see [Using Voice Commands](#) on page 99), to navigate to a location. You can enter or speak an address, landmark, business, etc. You can also choose a saved **Home**, **Work**, or **Favorite** destination, or select from a list of recent locations, searches (the most recently used locations display at the top), and charging stations you have visited.



When you touch **Navigate**, and specify a location, the touchscreen zooms out to provide an overview of the route you need to travel, and, after the route is calculated, the touchscreen zooms back in to your starting point and begins to provide spoken instructions. Depending on the map's zoom level, you might not be able to see the entire route. To display the entire route, touch the route overview icon:



The route overview icon displays when a navigation route is active. Touch this icon to display the current leg of your trip or to change the orientation of the map (see [Overview](#) on page 95).

When navigating, the touchscreen also displays a turn-by-turn direction list. At the bottom of this list is the estimated mileage, driving time, and arrival time. Note the following about the turn-by-turn direction list:

- If the battery energy remaining after completion of a round trip is less than ten percent, or if a round trip consumes a significant amount of battery energy, a round trip estimate of the energy you will use displays at the bottom of the turn-by-turn direction list (you may need to scroll down to see it).
- Note:** You can display a round trip energy estimate for all trips (see [Predicting Energy Usage](#) on page 97).
- If charging is needed to reach your destination and Trip Planner is enabled, Supercharger stops are included (see [Trip Planner](#) on page 97).
 - If you won't have enough energy, and there is no Supercharger on the route, an alert tells you that charging is required to reach your destination.
 - Each turn is preceded by the distance to the maneuver.
 - Touch the volume icon to adjust or mute the volume of the spoken navigation instructions.

Note: You can also change the volume of the navigation instructions by using the scroll wheel on the left side of the steering wheel while navigation directions are being spoken.

Note: If a data connection is not available, onboard maps allow you to navigate to any location, but you must enter the location's exact and complete address.

Charging Locations

Superchargers are displayed on the map by default, represented by red pins that you can touch to display more information about the Supercharger location, navigate to it, or mark it as a favorite. When you touch the pin for a Supercharger location on the map, information about the Supercharger location is displayed, including the total number of Superchargers, the number of Superchargers available, the address of the Supercharger, and its approximate distance from you. The popup also displays amenities that are available at the Supercharger location, including restrooms, restaurants, lodging, shopping, and Wi-Fi.

In addition to Superchargers, you can display all charging stations on the map by touching the charging icon. When you touch this icon, the map displays Superchargers, destination chargers, and any public charging stations that you have previously used. Display details about a charging location by touching its pin:



The Supercharger location is operational. At locations that have multiple superchargers, a row of bars displays above the icon, with each bar representing a supercharger. This provides a quick visual to indicate how many superchargers are in use. If a supercharger is in use, the bar is filled in.



The Supercharger location may be out of operation or is operating at a reduced capacity. Touch the pin to display details.



The location is equipped with a Tesla Wall Connector. Touch to display more information such as usage restrictions and available charge current.



Predicting Energy Usage

When navigating to a destination, Model 3 helps you anticipate your charging needs by calculating the amount of energy that remains when you reach your destination. The calculation is an estimate based on driving style (predicted speed, etc.) and environmental factors (elevation changes, weather, etc.). When you initiate a navigation route, the touchscreen displays this calculation at the bottom of the turn-by-turn direction list. Thereafter, you can display it by touching the area at the bottom of the turn-by-turn direction list.

Throughout your route, Model 3 monitors energy usage and updates the calculation. A popup warning displays at the bottom of the turn-by-turn direction list in these situations:

- A yellow warning displays when you have very little energy remaining to reach your destination and should drive slowly to conserve energy. For tips on conserving energy, see [Getting Maximum Range](#) on page 52.
- A red warning displays when you must charge to reach your destination.

If you always want to know if you have enough energy for round trips, you can choose to display the round trip energy calculation at the bottom of the turn-by-turn direction list. Touch the **Settings** icon on the map, and then touch **Always Show Estimated Round Trip Energy**. If this setting is not enabled, an estimate of your round trip energy usage displays at the bottom of the turn-by-turn direction list only if the estimated energy remaining after completion of the round trip is less than ten percent, or if the round trip consumes a significant amount of your available energy.

Routing Preferences

Model 3 detects real-time traffic conditions and automatically adjusts the estimated driving and arrival times based on traffic. In situations where traffic conditions will delay your estimated time of arrival, and an alternate route is available, the navigation system can reroute you to your destination. To turn this feature on and off, touch the **Settings** icon on the map, and then touch **Online Routing**. You can also specify the minimum amount of minutes that must be saved before you are rerouted by touching the arrows associated with the **Re-Route If It Saves More Than** setting. You can specify up to thirty minutes as the number of minutes that must be saved.

Trip Planner

Trip Planner helps you take longer road trips with confidence. If reaching your destination requires charging, Trip Planner routes you through the appropriate Supercharger locations. Trip Planner selects a route and provides charging times to minimize the amount of time you spend driving and charging. To enable Trip Planner, touch the **Settings** icon on the map, and then touch **Trip Planner**.

When Trip Planner is enabled and charging is required to reach your destination, the turn-by-turn direction list includes Supercharger stops, a recommended charging time at each Supercharger, and an estimate of how much energy will be available when you arrive at the first Supercharger.

To remove Supercharger stops and display only directions, touch **Remove charging stops** (at the bottom of the list of directions). To add Supercharger stops to the directions, touch **Add charging stops**.

While charging at a Supercharger stop, the charging screen displays the remaining charging time needed for your trip (or for your next stop). If you charge for a shorter or longer length of time, the charging time for subsequent Supercharger stops is adjusted.

Note: If a Supercharger located on your route experiences an outage, Trip Planner displays a notification and reroutes you to a different Supercharger location.



If Trip Planner estimates that you won't have enough energy for your round trip, and there are no Superchargers available on your route, Trip Planner displays an alert at the top of the turn-by-turn direction list. Trip Planner also displays an empty battery icon and the amount of additional energy needed for your trip.

Favorite Destinations

If you frequently drive to a destination, you may want to add it to your Favorites list to avoid having to enter the location's name or address each time. When you add a destination as a Favorite, you can easily navigate to it by touching **Navigate** > **Favorites** and selecting it from the list.



To add a location to your Favorites list, touch its pin on the map and, in the popup window that appears, touch the Favorites icon, then confirm that you want to add the location to your Favorites list. When a location is on your Favorites list, its icon is colored blue. To remove a favorite, touch the icon again and confirm that you want to remove the location from your Favorites list.

Home and Work Destinations

Navigation also has easy access placeholders for your **Home** and **Work** locations located at the top of the navigation list. Based on your usage patterns, you may be prompted to save a location as Home or Work.

Once a Home or Work location is saved, Model 3 may prompt you to navigate to your Work location in the mornings and to your Home location in the evenings and tell you how long it will take to arrive, based on current traffic conditions. To navigate to the prompted destination, simply press **NAV TO WORK** or **NAV TO HOME**.

To add or edit the location associated with Home or Work, press and hold the shortcut button, then enter a new address in the popup window. To delete, press and hold the shortcut button, then touch **CLEAR HOME** or **CLEAR WORK**.

Map Updates

As updated maps become available, they are automatically sent to Model 3 over Wi-Fi. To ensure you receive them, periodically connect Model 3 to a Wi-Fi network (see [Connecting to Wi-Fi](#) on page 103). The touchscreen displays a message informing you when new maps are installed.



You can use voice commands to:

- Call a contact.
- Navigate to a location.
- Listen to Internet music.



To initiate a voice command, tap the microphone button on the touchscreen. When you hear the tone, speak your command. As you speak, the touchscreen displays an interpretation of your command. It also displays tips to remind you of the type of commands you can speak. When you finish speaking the command, tap the voice button again or simply wait.

Note: You can also initiate a voice command by pressing the right scroll button.

To call a contact on your Bluetooth-connected phone, say “Call” or “Dial”, followed by the contact’s first and/or last names. For example, “Call Joe” or “Call Joe Smith”.

To search for, or navigate to, a location, say “Where is”, “Drive to”, or “Navigate to”, followed by an address, business name, business category, or landmark. For example, “Where is Stanford University?”, “Drive to Tesla in Palo Alto”, or “Navigate to Starbucks on Homestead in Cupertino”.

If you defined a navigation address for your home or work location (see [Maps and Navigation](#) on page 95), you can use a voice command to navigate there by saying “Navigate home” or “Navigate to work”.

To listen to an Internet music service, say “Listen to” or “Play”, followed by the name of the song, album, artist, or combination. To improve voice recognition accuracy, provide multiple cues in your command, such as the artist plus the song (for example, “Listen to Yellow Brick Road” or “Play Yellow Brick Road by Elton John”).



About the Security System

If Model 3 does not detect an authenticated phone or the key card and a locked door or trunk is opened, an alarm sounds and the headlights and turn signals flash. To deactivate the alarm, press any button on the mobile app or tap your key card against the card reader located below the Autopilot camera on the driver's side door pillar.

To manually enable or disable the alarm system, touch **Controls > Safety & Security > Settings > Security Alarm**. When set to **ON**, Model 3 activates its alarm one minute after you exit, the doors lock, and an authenticated phone or key card is no longer detected.

DRAFT
DO NOT DISTRIBUTE



About HomeLink

If equipped, you can program the HomeLink^{ff} Universal Transceiver to operate up to three Radio Frequency (RF) devices, including garage doors, gates, lights, and security systems.

Programming HomeLink

1. Park Model 3 in front of the device you want to program, and have the device's remote control ready.

Note: Make sure you haven't reached the limit of learned remotes/vehicles. Most device receivers can learn up to five remotes/vehicles. If necessary, clear the receiver memory and restart the programming process. For information about clearing the receiver memory, refer to the owner documentation for your device.

2. On the touchscreen, touch the HomeLink icon on the top of the touchscreen.
3. Touch **Add New HomeLink**, then use the onscreen keyboard to enter a name for your HomeLink device.
4. Touch **Program**.
5. Follow the onscreen instructions.

Once programmed, you can operate the device by touching its corresponding HomeLink icon on the touchscreen's status bar. HomeLink remembers the location of your programmed devices. When you approach a known location, the HomeLink control on the touchscreen automatically drops down. When you drive away, it disappears.

Note: For security reasons, delete your HomeLink devices if you sell your Model 3 (see [Deleting a Device](#) on page 101).

Warning: Your device might open or close during programming. Before programming, make sure that the device is clear of any people or objects.

Warning: Do not use the HomeLink Universal Transceiver with a device that does not have safety stop and reverse features. Using a device without these safety features increases the risk of injury or death.

Auto Opening and Closing

To operate a HomeLink device without touching the touchscreen, you can automate the device to open as you approach and close as you drive away:

- Touch the HomeLink icon on the top of the touchscreen and choose the device you want to automate.
- Select the **Auto-open when arriving** checkbox.
- Touch the arrows to specify the distance you want your vehicle to be from the device before it opens.
- Select the **Auto-close when leaving** checkbox if you want the device to close as you drive away.

As you approach (or drive away from) a device that is set to operate automatically, the HomeLink status icon displays a count-down message to let you know when the device will automatically open. In situations where you don't want the device to automatically open or close, touch **Skip Auto-Open** or **Skip Auto-Close** at any time during the count-down message.

Resetting the Location of the HomeLink Device

If you experience situations in which you sometimes drive up to your HomeLink device and it doesn't open, or the HomeLink icon on the touchscreen's status bar does not display the dropdown when you approach the device, you may need to reset the device's location. To do so, park as close as possible to the HomeLink device (garage door, gate, etc.) and display the HomeLink settings page by touching the HomeLink icon on the top of the touchscreen. Touch the name of the device you want to reset, then **Reset Location**.

Deleting a Device

To delete a HomeLink device, touch the HomeLink icon on the top of the touchscreen. Touch the name of the device you want to delete, then touch **Delete**.

Troubleshooting HomeLink

When programming a HomeLink device, the touchscreen walks you through a two-part programming process:



1. Model 3 records the signal from the remote. The touchscreen instructs you to stand in front of the vehicle, point the remote at the front bumper and press and hold the button until the headlights flash. When the headlights flash, Model 3 has learned the remote and you can touch **Continue** on the touchscreen. If the headlights do not flash, refer to the following guidelines.
 2. The device's receiver learns Model 3. The touchscreen instructs you to press the **LEARN** button on the device's receiver. If training the receiver does not work, refer to the following guidelines.
- Make sure you are pressing the receiver's **LEARN** button. Most receivers have two buttons and a LED. One button is a **RESET** button and the other is a **LEARN** button. Pressing the **LEARN** button usually causes the LED to flash. For instructions on how to put the receiver into learning mode, refer to the owner documentation provided with the HomeLink device.
 - Most devices stay in learning mode for only three to five minutes. Immediately after pressing the device's **LEARN** button, follow the instructions displayed on the touchscreen.

Note: Only devices that are equipped with a "rolling code" remote need to learn Model 3. If you have an old device that is not equipped with a "rolling code" remote, the device does not need to learn Model 3 and you can skip this part of the process. You can also skip this part if your receiver is "Quick-Train" compatible.

Headlights do not flash

- Check the batteries in the remote. It is a good idea to replace the batteries before you start programming.
- Hold the remote against the front bumper, with the button pressed, approximately 6 in (15 cm) to the left of the Tesla emblem. In some cases you must hold the button on the remote for up to three minutes.
- Check compatibility of the remote by contacting the HomeLink manufacturer (www.homelink.com).

After programming, the device does not work

- Park Model 3 with its front bumper as close as possible to the HomeLink device (garage door, gate, etc.).
- Make sure you haven't reached the device receiver's limit of learned remotes/cars. Most receivers can learn up to five remotes/cars. If the receiver's memory is full, you must clear the memory and restart the programming process. For instructions on how to clear the receiver's memory, refer to the owner documentation provided with the HomeLink device.



Note: Wi-Fi is not available at this time but is expected to be implemented in a near future software update.

Wi-Fi is available as a data connection method and is often faster than cellular data networks. Connecting to Wi-Fi is especially useful in areas with limited or no cellular connectivity. To ensure fast, reliable delivery of Model 3 updates (see [Software Updates](#) on page 104), Tesla recommends leaving Wi-Fi turned on and connected to a Wi-Fi network. To connect to a Wi-Fi network:

1. Touch the **LTE** (or **3G**) icon in the touchscreen status bar. Model 3 will start scanning and display the Wi-Fi networks that are within range.
2. Select the Wi-Fi network you want to use, enter the password (if necessary), then touch **Connect**.

You can also connect to a hidden network that isn't shown on the list of scanned networks. Just touch **Wi-Fi Settings** and enter the name of the network in the resulting dialog box.

Once you have connected to a network, Model 3 automatically connects whenever the network is within range. If more than one previously connected network is within range, Model 3 connects to the one most recently used.

Note: You can also use a mobile hotspot or your phone's Internet connection via Wi-Fi tethering.

Note: At Tesla Service Centers, Model 3 automatically connects to the Tesla Service Wi-Fi network.



Loading New Software

Model 3 updates its software wirelessly, providing new features throughout your term of ownership. Tesla recommends that you install software updates as soon as they are available. The first time you enter Model 3 after an update is made available, a scheduling window displays on the touchscreen. The scheduling window displays again at the end of your first driving session.

Note: Some software updates can take up to three hours to complete. Model 3 must be in Park while the new software is being installed. To ensure the fastest and most reliable delivery of software updates, leave the Wi-Fi turned on and connected whenever possible (see [Connecting to Wi-Fi](#) on page 103).

When a software update is available, a yellow clock icon appears on the touchscreen's status bar. Touch this clock icon to display the update window. You can then either:

- Schedule the update by setting the time you want the update to begin. Then touch **Set For This Time**. Once scheduled, the yellow clock icon changes to a white clock icon. You can reschedule the update any time before it begins.
- OR
- Touch **Install Now** to immediately start the update process.

If Model 3 is charging when the software update begins, charging stops. Charging resumes automatically when the software update is complete. If you are driving Model 3 at the scheduled update time, the update is canceled and you need to reschedule it.

Note: Over time, the touchscreen may display a software update window informing you to **SET FOR THIS TIME** or **INSTALL NOW**. This software update window will persist until you complete the installation of the software update. You must install all software updates as soon as they are available and any harm relating to the failure to install a software update will not be covered by the vehicle's warranty. Failure or refusal to install such updates may result in the inaccessibility of certain vehicle features (including incompatibility with digital media devices) or in Tesla being unable to diagnose and service your vehicle.

Note: If software updates are not installed, some vehicle features may become inaccessible and digital media devices may

become incompatible. Reverting to a previous software version is not possible.

If the touchscreen displays a message indicating that a software update was not successfully completed, contact Tesla.

Viewing Release Notes

When a software update is complete, learn about the new features by reading the release notes. To display release notes about your current software version at any time touch the Tesla "T" at the top center of the touchscreen, then touch **Release Notes**.

Tesla strongly recommends reading all release notes. They may contain important safety information or operating instructions regarding your Model 3.



High Voltage Components

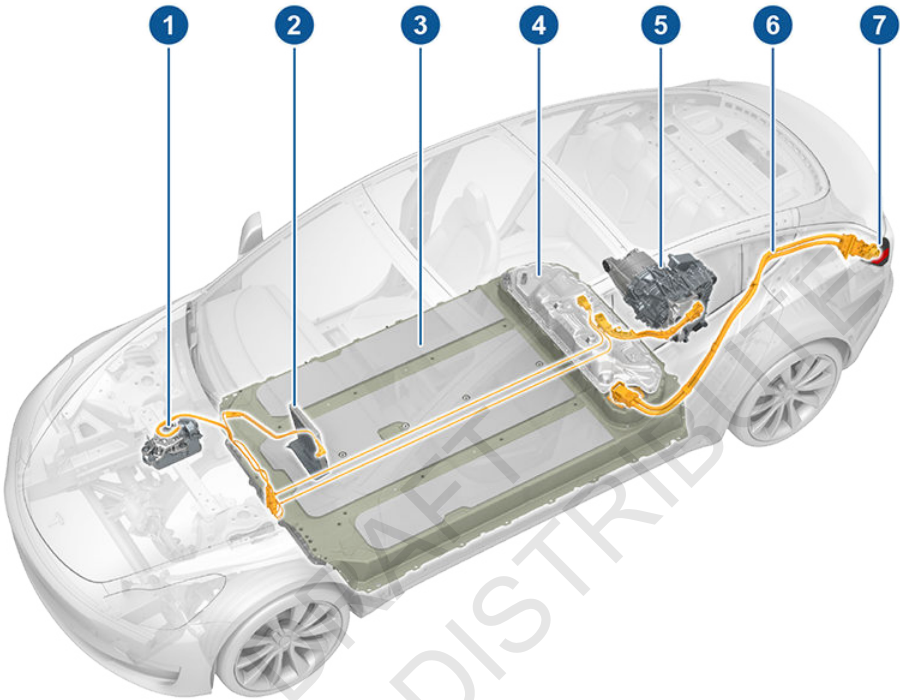

1. Air Conditioning Compressor
2. Cabin Heater
3. High Voltage Battery
4. High Voltage Battery Service Panel
5. Rear Motor
6. High Voltage Cabling
7. Charge Port

- ⚠ Warning:** The high voltage system has no user serviceable parts. Do not disassemble, remove or replace high voltage components, cables or connectors. High voltage cables are typically colored orange for easy identification.
- ⚠ Warning:** Read and follow all instructions provided on the labels that are attached to Model 3. These labels are there for your safety.
- ⚠ Warning:** In the unlikely event that a fire occurs, immediately contact your local fire emergency responders.



Charging Equipment

Charging equipment designed specifically to charge your Model 3 is available from Tesla. A Tesla Wall Connector, which installs in your garage, is the fastest way to charge Model 3 at home.

In several market regions, Model 3 is equipped with a Mobile Connector and the adapter(s) you need to plug into commonly used power outlets. When using the Mobile Connector, first plug the Mobile Connector into the power outlet, and then plug in Model 3. For more information about your Mobile Connector, see the Mobile Connector Owner's Manual (available on the touchscreen). Additional adapters can be purchased from Tesla.

In some regions, Tesla offers a J1772 adapter that allows you to connect Model 3 to commonly used public charging stations in that region. Connect the adapter to the charging station's charge cable, open the charge port door using the touchscreen (see [Charging Instructions](#) on page 108), and then plug in Model 3.

For more information on the charging equipment available for your region, go to www.tesla.com, choose your region, and then view the available charging options.

DRAFT
DO NOT DISTRIBUTE



About the Battery

Model 3 has one of the most sophisticated battery systems in the world. The most important way to preserve the Battery is to **LEAVE YOUR VEHICLE PLUGGED IN** when you are not using it. This is particularly important if you are not planning to drive Model 3 for several weeks. When plugged in, Model 3 wakes up when needed to automatically maintain a charge level that maximizes the lifetime of the Battery.

There is no advantage to waiting until the Battery's level is low before charging. In fact, the Battery performs best when charged regularly.

Note: If the Model 3 Battery becomes completely discharged in a situation in which towing is required, the owner is responsible for towing expenses. Discharge-related towing expenses are not covered under the Roadside Assistance policy.

The peak charging rate of the Battery may decrease slightly after a large number of DC Fast Charging sessions, such as those at Superchargers. To ensure maximum driving range and Battery safety, the Battery charge rate is decreased when the Battery is too cold, when the Battery's charge is nearly full, and when the Battery conditions change with usage and age. These changes in the condition of the Battery are driven by battery physics and may increase the total Supercharging duration by a few minutes over time.

Battery Care

Never allow the Battery to fully discharge. Even when Model 3 is not being driven, its Battery discharges very slowly to power the onboard electronics. On average, the Battery discharges at a rate of 1% per day. Situations can arise in which you must leave Model 3 unplugged for an extended period of time (for example, at an airport when traveling). In these situations, keep the discharge rates in mind to ensure that you leave the Battery with a sufficient charge level.

Discharging the Battery to 0% may permanently damage the Battery. To protect against a complete discharge, Model 3 enters a low-power consumption mode when the charge level drops to 5%. In this mode, the Battery stops supporting the onboard electronics to slow the discharge rate to approximately 4% per month. Once this low-power consumption mode is active, it is important to plug in Model 3 within two months to avoid Battery damage.

Note: When the low-power consumption mode is active, the auxiliary 12V battery is no longer being charged and can completely discharge within 12 hours. In the unlikely event that this occurs, you may need to jump start or replace the 12V battery before you can charge. In this situation, contact Tesla.

Temperature Limits

For better long-term performance, avoid exposing Model 3 to ambient temperatures above 140° F (60° C) or below -22° F (-30° C) for more than 24 hours at a time.

Battery Warnings and Cautions

Warning: The Battery has no parts that an owner or a non-Tesla authorized service technician can service. Under no circumstances should you open or tamper with the Battery. Always contact Tesla to arrange for Battery servicing.

Caution: If the Battery's charge level falls to 0%, you must plug it in. If you leave it unplugged for an extended period, it may not be possible to charge or use Model 3 without jump starting or replacing the 12V battery (see [Instructions for Transporters](#) on page 146 for instructions on how to jump start the battery). Leaving Model 3 unplugged for an extended period can also result in permanent Battery damage. If you are unable to charge Model 3, contact Tesla immediately.

Caution: The Battery requires no owner maintenance. Do not remove the coolant filler cap and do not add fluid. If the touchscreen warns you that the fluid level is low, contact Tesla immediately.

Caution: Do not use the Battery as a stationary power source. Doing so voids the warranty.



Opening the Charge Port

The charge port is located on the left side of Model 3, behind a door that is part of the rear tail light assembly. Park so that the charge cable easily reaches the charge port.

With Model 3 unlocked (or an authenticated phone is within range) and in Park, press and release the button on the Tesla charge cable to open the charge port door.



You can also open the charge port door using any of these methods:

- On the car status on the touchscreen, touch the charging icon.
- On the "Cards" area on the touchscreen, touch the charging icon, then press **OPEN CHARGE PORT**.
- Press the bottom of the charge port door when Model 3 is unlocked or an authenticated phone is nearby.

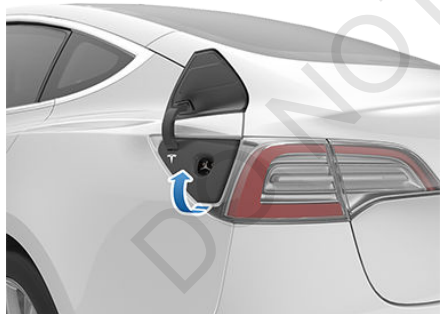

Note: The Tesla "T" lights up white when you open the charge port door. If you do not insert a charge cable into the charge port within a few minutes after opening the charge port door, the charge port door closes. If this happens, use the touchscreen to open the charge port door again.

Caution: Do not try to force the charge port door open.

Plugging In

If desired, use the touchscreen to change the charge limit and the charging current (see [Charging Status and Settings](#) on page 109).

To charge at a public charging station, attach an adapter to the station's charging connector. The most commonly used adapter(s) for each market region are provided. Depending on the charging equipment you are using, you may need to start and stop charging using a control on the charging equipment.

If you are using the Mobile Connector, plug it into the power outlet before plugging it into Model 3.

Align the connector to the charge port and insert fully. When the connector is properly inserted, charging begins automatically after Model 3:

- Engages a latch that holds the connector in place;
- Shifts into Park (if it was in any other gear);
- Heats or cools the Battery, if needed. If the Battery requires heating or cooling, you may notice a delay before charging begins.

Note: Whenever Model 3 is plugged in but not actively charging, it draws energy from the wall outlet instead of using energy stored in the Battery. For example, if you are sitting in Model 3 and using the touchscreen while parked and plugged in, Model 3 draws energy from the wall outlet instead of the Battery.

Caution: The connector end of the charge cable can damage the paint if dropped onto the vehicle.

During Charging

During charging, the charge port light (the Tesla "T" logo) pulses green, and the touchscreen displays the charging status. The frequency at which the charge port light pulses slows down as the charge level approaches full. When charging is complete, the light stops pulsing and is solid green.

Note: If Model 3 is locked, the charge port light does not light up.



If the charge port light turns red while charging, a fault is detected. Check the touchscreen for a message describing the fault. A fault can occur due to something as common as a power outage. If a power outage occurs, charging resumes automatically when power is restored.

Note: When charging, particularly at high currents, the refrigerant compressor and fan operate as needed to keep the Battery cool. Therefore, it is normal to hear sounds during charging.

Note: Air conditioning performance is generally not affected by charging. However, under certain circumstances (for example, you are charging at high currents during a particularly warm day), the air coming from the vents may not be as cool as expected and a message displays on the touchscreen. This is normal behavior and ensures that the Battery stays within an optimum temperature range while charging to support longevity and optimum performance.

⚠ Warning: Never spray liquid at a high velocity (for example, if using a pressure washer) towards the charge port while charging. Failure to follow these instructions can result in serious injury or damage to the vehicle, charging equipment, or property.

Stopping Charging

Stop charging at any time by disconnecting the charge cable or touching **Stop Charging** on the touchscreen.

Note: To prevent unauthorized unplugging of the charge cable, Model 3 must be unlocked or able to recognize your authenticated phone before you can disconnect the charge cable.

To disconnect the charge cable:

1. Press and hold the button on a Tesla connector to release the latch. You can also touch **Stop Charging** on the charging screen (see [Charging Status and Settings](#) on page 109).
2. Pull the connector from the charge port.

Note: The charge port automatically closes within approximately 10 seconds of removing the connector from the charge port.

⚠ Caution: Tesla strongly recommends leaving Model 3 plugged in when not in use. This maintains the Battery at the optimum level of charge.

Charge Port Light

- **WHITE:** The charge port door is open. Model 3 is ready to charge and the connector is not inserted, or the latch is released and the connector is ready to be removed.
- **BLUE:** Model 3 detects that a connector has been plugged in, but charging has not started. Either Model 3 is preparing to charge, or a charging session is scheduled to begin at a specified future time.
- **BLINKING GREEN:** Charging is in progress. As Model 3 approaches a full charge, the frequency of the blinking slows.
- **SOLID GREEN:** Charging is complete.
- **SOLID AMBER:** The connector is not fully plugged in. Realign the connector to the charge port and insert fully.
- **BLINKING AMBER:** Model 3 is charging at a reduced current (AC charging only).
- **RED:** A fault is detected and charging has stopped. Check the touchscreen for a fault message.

Charging Status and Settings

The charging screen displays on the touchscreen whenever the charge port door is open.



To display charge settings at any time, touch the charging icon on the "Cards" area on the touchscreen.

The charging screen displays a representative image of the status of the Battery and information about your charging session including:

- Charging rate (in kilowatt hours, miles per hour, or kilometers per hour, depending on your display setting).
- Added energy or estimated increase in driving distance achieved so far in this charging session (in kilowatt hours, miles per hour, or kilometers per hour, depending on your display setting).
- Current supplied/available from the connected power supply.
- Voltage supplied by the charge cable.

Note: To access the setting to change how energy units are displayed, touch **Controls > Display > Settings > Energy Display**.



Note: The following illustration is provided for demonstration purposes only and may vary slightly depending on software version and market region.

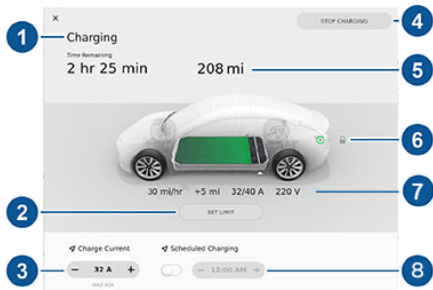

1. Charge status messages (such as Charging, Charging Scheduled) display here. While charging, the estimated time remaining to achieve your set limit is also displayed.
2. Adjust the charge limit by touching **Set Limit**, and drag the arrow to move the charge limit setting. The setting you choose applies to immediate and scheduled charging sessions.

3. The current automatically sets to the maximum current available from the attached charge cable, unless it was previously reduced to a lower level. If needed, touch the - or + buttons to change the current (for example, you may want to reduce the current if you are concerned about overloading a domestic wiring circuit shared by other equipment). It is not possible to set the charging current to a level that exceeds the maximum available from the attached charge cable. When you change the current, Model 3 remembers the location. If you charge at the same location, you do not need to change it again.

Note: If Model 3 is charging and detects unexpected fluctuations in input power, the charging current is automatically reduced by 25%. For example, a 40 amp current is reduced to 30 amps. This automatic current reduction increases robustness and safety in situations when an external problem exists (for example, a home wiring system, receptacle, adapter or cord is unable to meet its rated current capacity). As a precaution, when Model 3 automatically reduces current, it saves the reduced current at the charging location. Although you can manually increase it, Tesla recommends charging at the lower current until the underlying problem is resolved and the charging location can provide consistent power.

4. Touch to open the charge port door or to start (or stop) charging.
5. Displays the total estimated driving distance or energy percentage (depending on your display setting) available.
6. Shows if the charge cable is locked in the charge port or not. If Model 3 is not charging, you can touch the lock icon to unlock the charge cable from the charge port.
7. Charging rate per hour, estimated increase in driving distance (or energy) achieved so far in this charging session, current supplied/available from the connected power supply, and voltage supplied by the charge cable.



8. Set a recurring charging schedule for the location. When you set a scheduled charging time, Model 3 displays the set time when you are parked at the scheduled location. If, at the scheduled time, Model 3 is not plugged in at the location, charging starts as soon as you plug it in, provided you plug it in within six hours of the scheduled time. If plugged in after six hours, charging does not start until the scheduled time on the next day. To override this setting, touch **Start Charging** or **Stop Charging** (see item 4).

Note: If charging at a Tesla Supercharger, the charging screen also displays information about your previous or current Supercharger session (see [Supercharger Usage Fees and Idle Fees](#) on page 111).

Supercharger Usage Fees and Idle Fees

When charging using a Tesla supercharger, PAID SUPERCHARGING information displays at the bottom of the charging screen. This information includes the location, the time that charging started, and an estimate of how much the session will cost. When you stop charging, the final cost displays until a new Supercharging session begins.

When charging at a Tesla supercharger, you are subject to idle fees. Idle fees are designed to encourage drivers to move their vehicle from the Supercharger when charging is complete and are in effect whenever at least half of the Superchargers at a site are occupied. The Tesla mobile app notifies you when charging nears completion, and again when charging is complete. Additional notifications are sent if idle fees are incurred. Idle fees are waived if you move your vehicle within five minutes of charging completion.

Log into your Tesla Account to view fees and details about Supercharger sessions, set up a payment method, and make payments. Once a payment method is saved, fees are automatically paid from your account.



Service Intervals

Regular maintenance is the key to ensuring the continued reliability and efficiency of your Model 3.

Rotate the tires every 6,250 miles (10,000 km). Maintain the correct tire pressures. It is also important to perform the daily and monthly checks described below.

Note: View tire pressures in the "Cards" area, located toward the bottom on the left side of the touchscreen, as described in [Touchscreen Overview](#) on page 4.

Model 3 should be serviced by Tesla-certified technicians. Damages or failures caused by maintenance or repairs performed by non-Tesla certified technicians are not covered by the warranty.

Daily Checks

- Check the Battery's charge level, displayed on the touchscreen or mobile app.
- Check the condition and pressure of each tire (see [Tire Care and Maintenance](#) on page 113).
- Check that all exterior lights, horn, turn signals, and wipers and washers are working.
- Check the operation of the brakes, including the parking brake.
- Check the operation of the seat belts (see [Seat Belts](#) on page 20).
- Look for abnormal fluid deposits underneath Model 3 that might indicate a leak. It is normal for a small pool of water to form (caused by the air conditioning system's dehumidifying process).

Monthly Checks

- Check the mileage to determine if the tires need to be rotated (every 6,250 miles (10,000 km)), and check the condition and pressure of each tire (see [Tire Care and Maintenance](#) on page 113).
- Check windshield washer fluid level and top up if necessary (see [Topping Up Washer Fluid](#) on page 125).
- Check that the air conditioning system is operating correctly (see [Climate Controls](#) on page 86).

Warning: Contact Tesla immediately if you notice any significant or sudden drop in fluid levels or uneven tire wear.

Fluid Replacement Intervals

Do not change or top up the Battery coolant or brake fluid. Tesla service technicians replace fluids at the regularly scheduled service intervals:

- Brake fluid. Every 2 years or 25,000 miles (40,000 km), whichever comes first.
- Battery coolant. Every 4 years or 50,000 miles (80,000 km), whichever comes first.

Note: Any damage caused by opening the Battery coolant reservoir is excluded from the warranty.

High Voltage Safety

Your Model 3 has been designed and built with safety as a priority. However, be aware of these precautions to protect yourself from the risk of injury inherent in all high-voltage systems:

- Read and follow all instructions provided on the labels that are attached to Model 3. These labels are there for your safety.
- The high voltage system has no user-serviceable parts. Do not disassemble, remove or replace high voltage components, cables or connectors. High voltage cables are colored orange for easy identification.
- If a collision occurs, do not touch any high voltage wiring, connectors, or components connected to the wiring.
- In the unlikely event that a fire occurs, immediately contact your local fire emergency responders.

Warning: Always disconnect the charge cable before working underneath Model 3, even if charging is not in progress.

Warning: Keep your hands and clothing away from cooling fans. Some fans operate even when Model 3 is powered off.

Warning: Some fluids (battery acid, Battery coolant, brake fluid, windshield washer additives, etc.) used in vehicles are poisonous and should not be inhaled, swallowed, or brought into contact with open wounds. For your safety, always read and follow instructions printed on fluid containers.



Maintaining Tire Pressures

Keep tires inflated to the pressures shown on the Tire and Loading Information label, even if it differs from the pressure printed on the tire itself. The Tire and Loading Information label is located on the center door pillar and is visible when the driver's door is open.

Note: If your Model 3 is fitted with Tesla accessory wheels or tires, some information may be different from the labels on the vehicle. See [Accessory Wheels and Tires](#) on page 127.



The Tire Pressure indicator light on the touchscreen alerts you if one or more tires is under- or over-inflated.

The Tire Pressure indicator light does not immediately turn off when you adjust tire pressure. After inflating the tire to the recommended pressure, you must drive over 15 mph (25 km/h) for more than 10 minutes to activate the Tire Pressure Monitoring System (TPMS), which turns off the Tire Pressure indicator light.

If the indicator light flashes for one minute whenever you power on Model 3, a fault with the TPMS is detected (see [TPMS Malfunction](#) on page 118).

Note: Display tire pressures in the "Cards" area, located toward the bottom on the left side of the touchscreen. You can also choose whether you want to display tire pressures using BAR or PSI by touching **Controls** > **Display** > **Settings** > **Tire Pressure**.

Checking and Adjusting Tire Pressures

Follow these steps when tires are cold and Model 3 has been stationary for over three hours:

1. Remove the valve cap.
2. Firmly press an accurate tire pressure gauge onto the valve to measure pressure.
3. If required, add or remove air to reach the recommended pressure.

Note: You can release air by pressing the metal stem in the center of the valve.

4. Re-check pressure using the tire gauge.
5. Repeat steps 3 and 4 as necessary until the tire pressure is correct.
6. Replace the valve cap to prevent dirt from entering. Periodically check the valve for damage and leaks.

Warning: Under-inflation is the most common cause of tire failures and can cause a tire to overheat, resulting in severe tire cracking, tread separation, or blowout, which causes unexpected loss of vehicle control and increased risk of injury. Under-inflation also reduces the vehicle's range and tire tread life.

Warning: Check tire pressures using an accurate pressure gauge when tires are cold. It takes only about one mile (1.6 km) of driving to warm up the tires sufficiently to affect tire pressures. Parking the vehicle in direct sunlight or in hot weather can also affect tire pressures. If you must check warm tires, expect increased pressures. Do not let air out of warm tires in an attempt to match recommended cold tire pressures. A hot tire at or below the recommended cold tire inflation pressure is dangerously under-inflated.

Warning: Do not use any tire sealant other than the type provided in a Tesla tire repair kit. Other types can cause tire pressure sensors to malfunction. If your Model 3 did not include a tire repair kit, you can purchase one from Tesla.



Inspecting and Maintaining Tires

Regularly inspect the tread and side walls for any sign of distortion (bulges), foreign objects, cuts or wear.

Warning: Do not drive Model 3 if a tire is damaged, excessively worn, or inflated to an incorrect pressure. Check tires regularly for wear, and ensure there are no cuts, bulges or exposure of the ply/cord structure.

Tire Wear

Adequate tread depth is important for proper tire performance. Tires with a tread depth less than 4/32" (3 mm) are more likely to hydroplane in wet conditions and should not be used. Tires with a tread depth less than 5/32" (4 mm) do not perform well in snow and slush and should not be used when driving in winter conditions.

Model 3 is originally fitted with tires that have wear indicators molded into the tread pattern. When the tread has been worn down to 4/32" (3 mm), the indicators start to appear at the surface of the tread pattern, producing the effect of a continuous band of rubber across the width of the tire. For optimal performance and safety, Tesla recommends replacing tires before the wear indicators are visible.

Tire Rotation, Balance, and Wheel Alignment

Tesla recommends rotating the tires every 6,250 miles (10,000 km).

Unbalanced wheels (sometimes noticeable as vibration through the steering wheel) affect vehicle handling and tire life. Even with regular use, wheels can get out of balance. Therefore, they should be balanced as required.

If tire wear is uneven (on one side of the tire only) or becomes abnormally excessive, check the alignment of wheels.

Note: When replacing only two tires, always install the new tires on the rear.

Punctured Tires

A puncture eventually causes the tire to lose pressure, which is why it is important to check tire pressures frequently. Permanently repair or replace punctured or damaged tires as soon as possible.

Your tubeless tires may not leak when penetrated, provided the object remains in the tire. If, however, you feel a sudden vibration or ride disturbance while driving, or you suspect a tire is damaged, immediately reduce your speed. Drive slowly, while avoiding heavy braking or sharp steering and, when safe to do so, stop the vehicle. Arrange to have Model 3 transported to a Tesla Service Center, or to a nearby tire repair center.

Note: In some cases, you can temporarily repair small tire punctures (under 1/4" (6 mm)) using an optional tire repair kit available from Tesla. This allows you to slowly drive Model 3 to Tesla or to a nearby tire repair facility.

Warning: Do not drive with a punctured tire, even if the puncture has not caused the tire to deflate. A punctured tire can deflate suddenly at any time.

Flat Spots

If Model 3 is stationary for a long period in high temperatures, tires can form flat spots. When Model 3 is driven, these flat spots cause a vibration which gradually disappears as the tires warm up and regain their original shape.

To minimize flat spots during storage, inflate tires to the maximum pressure indicated on the tire wall. Then, before driving, release air to adjust tire pressure to the recommended levels.

Improving Tire Mileage

To improve the mileage you get from your tires, maintain tires at the recommended tire pressures, observe speed limits and advisory speeds, and avoid:

- Pulling away quickly, or hard acceleration.
- Fast turns and heavy braking.
- Potholes and objects in the road.
- Hitting curbs when parking.
- Contaminating tires with fluids that can cause damage.



Replacing Tires and Wheels

Tires degrade over time due to the effects of ultraviolet light, extreme temperatures, high loads, and environmental conditions. It is recommended that tires are replaced every six years, or sooner if required.

Wheel and tires are matched to suit the handling characteristics of the vehicle. Replacement tires must comply with the original specification. If tires other than those specified are used, ensure that the load and speed ratings marked on the tire equal or exceed those of the original specification.

Ideally, you should replace all four tires at the same time. If this is not possible, replace the tires in pairs, placing the new tires on the rear. Always balance the wheel after replacing a tire.

If you replace a wheel, the TPMS (Tire Pressure Monitoring System) sensors need to be reset to ensure they provide accurate warnings when tires are under- or over-inflated (see [Automatic Resetting of TPMS Sensors](#) on page 117).

Warning: For your safety, use only tires and wheels that match the original specification. Tires that do not match the original specification can affect the operation of the TPMS.

Warning: Never exceed the speed rating of your vehicle's tires. The speed rating is shown on the sidewall of your tires (see [Understanding Tire Markings](#) on page 139).

Asymmetric Tires

Model 3 tires are asymmetric and must be mounted on the wheel with the correct sidewall facing outward. The sidewall of the tire is marked with the word OUTSIDE. When new tires are installed, make sure that the tires are correctly mounted on the wheels.



Warning: Road holding is seriously impaired if the tires are incorrectly installed on the wheels.

Removing and Installing Aero Covers

If your Model 3 is equipped with aero covers, you must remove them to access the lug nuts. To remove an aero cover, grasp it firmly and pull it toward you.

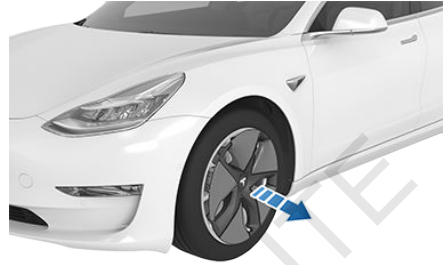

To install an aero cover, align it into position so that the notch is aligned with the tire's valve stem and then push firmly around its perimeter until it fully snaps into place.





Removing and Installing Lug Nut Covers

If your Model 3 is equipped with lug nut covers, you must remove them to access the lug nuts.

To remove a lug nut cover:

1. Insert the curved part of the lug nut cover tool (located in your glovebox) into the hole at the base of the Tesla "T".



2. Maneuver the lug nut cover tool so that it is fully inserted into the hole in the lug nut cover.
3. Twist the lug nut cover tool so that the curved part is touching the middle of the lug nut cover.
4. Firmly pull the lug nut tool away from the wheel until the lug nut cover is released.

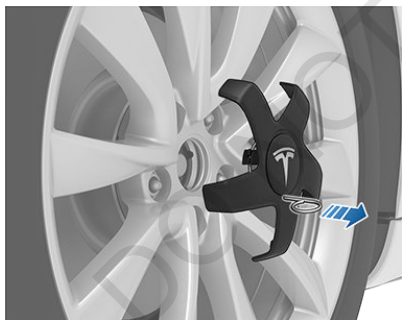

To install the lug nut cover, align it into position and push firmly until it fully snaps into place.

Seasonal Tire Types

Summer Tires

Your vehicle may be originally equipped with high performance summer tires or all season tires. Tesla recommends using winter tires if driving in cold temperatures or on roads where snow or ice may be present. Contact Tesla for winter tire recommendations.

Warning: In cold temperatures or on snow or ice, summer tires do not provide adequate traction. Selecting and installing the appropriate tires for winter conditions is important to ensure the safety and optimum performance of your Model 3.

All-Season Tires

Your Model 3 may be originally equipped with all-season tires. These tires are designed to provide adequate traction in most conditions year-round, but may not provide the same level of traction as winter tires in snowy or icy conditions. All-season tires can be identified by "ALL SEASON" and/or "M+S" (mud and snow) on the tire sidewall.

Winter Tires

Use winter tires to increase traction in snowy or icy conditions. When installing winter tires, always install a complete set of four tires at the same time. Winter tires must be the same size, brand, construction and tread pattern on all four wheels. Contact Tesla for winter tire recommendations.



Winter tires can be identified by a mountain/snowflake symbol on the tire's sidewall.

When driving with winter tires, you may experience more road noise, shorter tread life, and less traction on dry roads.

Driving in Low Temperatures

Tire performance is reduced in low ambient temperatures, resulting in reduced grip and an increased susceptibility to damage from impacts. Performance tires can temporarily harden when cold, causing you to hear rotational noise for the first few miles (kilometers) until the tires warm up.



Using Tire Chains

Tesla has tested and approved the following tire chains to increase traction in snowy conditions. Tire chains should only be installed on the rear tires.

Tire Size	Recommended Chain
18"	PEWAG SERVO SPORT RSS 76
19"	PEWAG SERVO RS 77

- ⚠ Caution:** If your Model 3 is equipped with aero covers, you must remove them before installing tire chains (see [Removing and Installing Aero Covers](#) on page 115). Failure to do so can cause damage not covered by the warranty.

When installing tire chains, follow the instructions provided by the tire chain manufacturer. Mount them as tightly as possible.

When using tire chains:

- Drive slowly. Do not exceed 30 mph (48 km/h).
- Avoid heavily loading Model 3 (heavy loads can reduce the clearance between the tires and the body).
- Remove the tire chains as soon as conditions allow.

Note: Tire chains are prohibited in some jurisdictions. Check local laws before installing tire chains.

- ⚠ Caution:** Using non-recommended tire chains, or using tire chains on other sized tires can damage the suspension, body, wheels, and/or brake lines. Damage caused by using non-recommended tire chains is not covered by the warranty.
- ⚠ Caution:** Do not use tire chains on the front tires.
- ⚠ Caution:** Ensure that the tire chains cannot touch suspension components or brake lines. If you hear the chains making unusual noises that would indicate contact with Model 3, stop and investigate immediately.

Tire Pressure Monitoring

Each tire should be checked monthly when cold and inflated to the recommended pressures that are printed on the Tire and Loading Information label located on the driver's door pillar (see [Maintaining Tire Pressures](#) on page 113). If your vehicle has tires of a different size than the size indicated on the vehicle placard or tire inflation pressure label, determine the proper tire inflation pressure for those tires.

As an added safety feature, your vehicle has been equipped with a TPMS that displays a tire pressure telltale (Tire Pressure Warning) on the touchscreen when one or more of your tires is significantly under- or over-inflated. Accordingly, when the Tire Pressure indicator light displays on the touchscreen to alert you about tire pressure, stop and check your tires as soon as possible, and inflate them to the proper pressure (see [Maintaining Tire Pressures](#) on page 113). Driving on a significantly under-inflated tire causes the tire to overheat and can lead to tire failure. Under-inflation also reduces range efficiency and tire tread life, and may affect the vehicle's handling and stopping ability.



If Model 3 detects a fault with the TPMS, this indicator flashes for one minute whenever you power on Model 3.

Note: Installing accessories that are not approved by Tesla can interfere with the TPMS.

- ⚠ Warning:** The TPMS is not a substitute for proper tire maintenance, including manually checking tire pressures and regularly inspecting the condition of tires. It is the driver's responsibility to maintain correct tire pressure, even if under- or over-inflation has not reached the level for the TPMS to trigger the Tire Pressure Warning on the touchscreen.

Automatic Resetting of TPMS Sensors

After replacing one or more wheels (but not after replacing a tire or rotating wheels), the TPMS sensors are reset to ensure tire pressure warnings are accurate. TPMS sensors reset automatically after driving over 15 mph (25 km/h) for longer than 10 minutes.

Note: After replacing a wheel, false tire pressure warnings may display before you've



driven 15 mph (25 km/h) for longer than 10 minutes.

Replacing a Tire Sensor

If the Tire Pressure warning indicator displays frequently, contact Tesla to determine if a tire sensor needs to be replaced. If a non-Tesla Service Center repairs or replaces a tire, the tire sensor may not work until Tesla performs the setup procedure.

TPMS Malfunction

Model 3 has also been equipped with a TPMS malfunction indicator to indicate when the system is not operating properly.



The TPMS malfunction indicator is combined with the tire pressure indicator light. When the system detects a malfunction, the indicator flashes for approximately one minute after Model 3 powers on, and then remains continuously lit. This sequence continues upon subsequent vehicle start-ups as long as the malfunction exists. When the TPMS malfunction indicator is on, the system might not be able to detect or signal under- and over-inflated tires as intended.

TPMS malfunctions can occur for a variety of reasons, including installing replacement or alternate tires or wheels that prevent the TPMS from functioning properly. Always check the TPMS malfunction indicator light after replacing one or more tires or wheels on your vehicle to ensure that the replacement tires or wheels allow the TPMS to continue to function properly.

Note: If a tire has been replaced or repaired using a different tire sealant than the one available from Tesla, and a low tire pressure is detected, it is possible that the tire sensor has been damaged. Contact Tesla to have the fault repaired as soon as possible.



Cleaning the Exterior

To prevent damage to the paint, immediately remove corrosive substances (bird droppings, tree resin, dead insects, tar spots, road salt, industrial fallout, etc.). Do not wait until Model 3 is due for a complete wash. If necessary, use denatured alcohol to remove tar spots and stubborn grease stains, then immediately wash the area with water and a mild, non-detergent soap to remove the alcohol.

Follow these steps when washing the exterior of Model 3:

1. Rinse Thoroughly

Before washing, flush grime and grit from the bodywork using a hose. Flush away accumulations of mud in areas where debris easily collects (such as wheel arches and panel seams). If salt has been used on the highways (such as during winter months), thoroughly rinse all traces of road salt from the underside of the vehicle.

2. Hand Wash

Hand wash Model 3 using a clean soft cloth and cold or lukewarm water containing a mild, high-quality car shampoo.

3. Rinse with Clean Water











After washing, rinse with clean water to prevent soap from drying on the surfaces.

4. Dry Thoroughly and Clean Exterior Glass

After washing and rinsing, dry thoroughly with a chamois.

Clean windows and mirrors using an automotive glass cleaner. Do not scrape, or use any abrasive cleaning fluid on glass or mirrored surfaces.

Cautions for Exterior Cleaning

-  **Caution:** Do not use windshield treatment fluids. Doing so can interfere with wiper friction and cause a chattering sound.
-  **Caution:** Do not use hot water or detergents.
-  **Caution:** Do not wash in direct sunlight.
-  **Caution:** If using a pressure washer, maintain a distance of at least 12" (30 cm) between the nozzle and the surface of Model 3. Keep the nozzle moving and do not concentrate the water jet on any one area.
-  **Caution:** Do not aim water hoses directly at window, door or hood seals, or through wheel apertures onto brake components.
-  **Caution:** Avoid using tight-napped or rough cloths, such as washing mitts.
-  **Caution:** If washing in an automatic car wash, use Touchless car washes only. These car washes have no parts (brushes, etc.) that touch the surfaces of Model 3. Using any other type of car wash could cause damage that is not covered by the warranty.
-  **Caution:** Ensure the wipers are off before washing Model 3 to avoid the risk of damaging the wipers.
-  **Caution:** Do not use chemical based wheel cleaners. These can damage the finish on the wheels.
-  **Caution:** Avoid using a high pressure power washer on the camera(s) or parking sensors (if equipped) and do not clean a sensor or camera lens with a sharp or abrasive object that can scratch or damage its surface.
-  **Warning:** Never spray liquid at a high velocity (for example, if using a pressure washer) towards the charge port while Model 3 is charging. Failure to follow these instructions can result in serious injury or damage to the vehicle, charging equipment, or property.



Cleaning the Interior

Frequently inspect and clean the interior to maintain its appearance and to prevent premature wear. If possible, immediately wipe up spills and remove marks. For general cleaning, wipe interior surfaces using a soft cloth (such as microfiber) dampened with a mixture of warm water and mild non-detergent cleaner (test all cleaners on a concealed area before use). To avoid streaks, dry immediately with a soft lint-free cloth.

Interior Glass

Do not scrape, or use any abrasive cleaning fluid on glass or mirrored surfaces. This can damage the reflective surface of the mirror and the heating elements in the rear window.

Airbags

Do not allow any substance to enter an airbag cover. This could affect correct operation.

Dashboard and Plastic Surfaces

Do not polish the upper surfaces of the dashboard. Polished surfaces are reflective and could interfere with your driving view.

Polyurethane Seats

Wipe spills as soon as possible using a soft cloth moistened with warm water and non-detergent soap. Wipe gently in a circular motion. After cleaning, allow the seats to air dry.

Cloth Seats

Wipe spills as soon as possible using a soft cloth moistened with warm water and non-detergent soap. Wipe gently in a circular motion. Then wipe dry using a soft, lint-free cloth. Vacuum the seats as needed to remove any loose dirt.

Carpets

Avoid over-wetting carpets. For heavily soiled areas, use a diluted upholstery cleaner.

Seat Belts

Extend the belts to wipe. Do not use any type of detergent or chemical cleaning agent. Allow the belts to dry naturally while extended, preferably away from direct sunlight.





Touchscreen

Clean the touchscreen using a soft lint-free cloth specifically designed to clean monitors and displays. Do not use cleaners (such as a glass cleaner) and do not use a wet wipe or a dry statically-charged cloth (such as a recently washed microfiber). To wipe the touchscreen without activating buttons and changing settings, you can enable clean mode. Touch **Controls** > **Display** > **Screen Clean Mode**. The display darkens to make it easy to see dust and smudges.

Chrome and Metal Surfaces

Polish, abrasive cleaners or hard cloths can damage the finish on chrome and metal surfaces.

Cautions for Interior Cleaning

-  **Caution:** Using solvents (including alcohol), bleach, citrus, naphtha, or silicone-based products or additives on interior components can cause damage.
-  **Caution:** Statically-charged materials can cause damage to the touchscreen.
-  **Warning:** If you notice any damage on an airbag or seat belt, contact Tesla immediately.
-  **Warning:** Do not allow any water, cleaners, or fabric to enter a seat belt mechanism.
-  **Warning:** Exposure to chemical cleaners can be hazardous and can irritate eyes and skin. Read and observe the instructions provided by the manufacturer of the chemical cleaner.

Polishing, Touch Up, and Body Repair

To preserve the cosmetic appearance of the body, you can occasionally treat the paint surfaces with an approved polish containing:

- Very mild abrasive to remove surface contamination without removing or damaging the paint.
- Filling compounds that fill scratches and reduce their visibility.
- Wax to provide a protective coating between the paint and environmental elements.



Regularly inspect the exterior paint for damage. Treat minor chips and scratches using a paint touch-up pen (available for purchase from Tesla). Use the touch-up pen after washing but before polishing or waxing.

Repair rock chips, fractures or scratches. Body repairs should be performed only by a Tesla approved body shop. Contact Tesla for a list of approved body shops.

- ⚠ Caution:** Do not use cutting pastes, color restoration compounds, or polishes containing harsh abrasives. These can scour the surface and permanently damage the paint.
- ⚠ Caution:** Do not use chrome polish or other abrasive cleaners.

Using a Car Cover

To preserve the cosmetic appearance of the body when Model 3 is not being used, use a genuine Tesla car cover. Car covers can be purchased from Tesla. See [Parts and Accessories](#) on page 127.

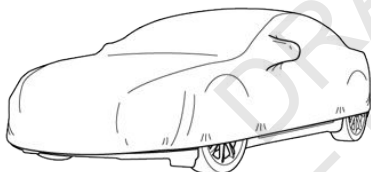

- ⚠ Caution:** Use only a Tesla-approved car cover when Model 3 is plugged in. Using a non-Tesla car cover can prevent the Battery from being adequately cooled during charging.

Floor Mats

To extend the life of your carpet and make them easier to clean, use genuine Tesla floor mats (see [Parts and Accessories](#) on page 127). Maintain floor mats by regularly cleaning them and checking that they are properly attached. Replace floor mats if they become excessively worn.

- ⚠ Warning:** To avoid potential interference with a foot pedal, ensure that the driver's floor mat is securely fastened, and never place an additional floor mat on top of it. Floor mats should always rest on top of the vehicle carpeting surface and not on another floor mat or other covering.



Checking and Replacing Wiper Blades

⚠ Caution: Wiper blades do not lock into a lifted position. When cleaning or replacing a wiper blade, lift the wiper arm only a short distance from the windshield, just far enough to access the blade. Do not lift a wiper arm beyond its intended position. Doing so can cause damage that is not covered by the warranty.

To make wiper blades easy to access, turn off the wipers, shift Model 3 into Park, then use the touchscreen to move them to the service position. Touch **Controls > Service > Wiper Service Mode > ON**.

Note: Wipers automatically return to their normal position when you shift Model 3 out of Park.

Periodically check and clean the edge of the wiper blade and check the rubber for cracks, splits and roughness. If damaged, replace the blade immediately to prevent damage to the glass.

Contaminants on the windshield, or on the wiper blades, can reduce the effectiveness of the wiper blades. Contaminants include ice, wax spray from car washes, washer fluid with bug and/or water repellent, bird droppings, tree sap, and other organic substances.

Follow these guidelines for cleaning:

- Clean the windshield using non-abrasive glass cleaner.
- Lift the wiper arm a short distance away from the windshield, just far enough to access the wiper blade, then wipe the blade clean using isopropyl (rubbing) alcohol or washer fluid.

If the wipers remain ineffective after cleaning, replace the wiper blades.

Note: For optimum performance, replace the wiper blades at least once a year.

To replace the wiper blades:

1. Turn off the wipers, shift Model 3 into Park, then use the touchscreen to move the wipers to the service position. Touch **Controls > Service > Wiper Service Mode > ON**.

Note: The wipers must be off to turn Wiper Service Mode on.

2. Lift the wiper arm a short distance away from the windshield, just far enough to access the wiper blade.

3. Hold the wiper arm (the wiper arm does not lock into a lifted position) and press the locking tab while sliding the blade down the arm.

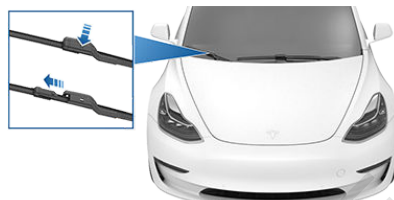

4. If necessary, temporarily place a towel between the wiper arm and windshield to avoid scratching the windshield.
5. Align the new blade on the wiper arm and slide it toward the hooked end of the arm until it locks into place.
6. Place the wiper arm against the windshield.
7. Turn Wiper Service Mode off.

If the problem persists with new blades, clean the windshield and wiper blades by wiping them with a soft cloth or sponge moistened with warm water and non-detergent soap. Then, rinse the windshield and wiper blades with clean water. The windshield is clean when water beads do not form.

⚠ Caution: Only use cleaning products approved for use on automotive glass and rubber. Inappropriate products can cause damage or smears, and create glare on the windshield.

⚠ Caution: Only install replacement blades that are identical to the original blades. Using inappropriate blades can damage the wiper system and windshield.

Cleaning Washer Jets

The position of the windshield washers is set at the factory and should never need adjusting.

If a windshield washer becomes blocked, use a thin strand of wire to clear any blockages from the nozzle.

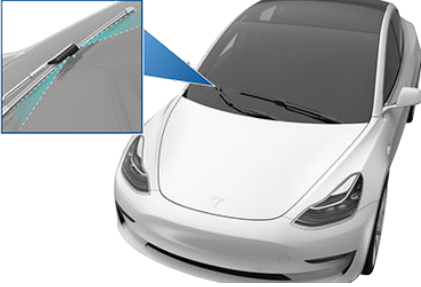

- ⚠ Warning:** Do not operate the washers while cleaning Model 3. Windshield washer fluid can irritate eyes and skin. Read and observe the washer fluid manufacturer's instructions.

DRAFT
DO NOT DISTRIBUTE



Removing the Maintenance Panel

To check fluid levels, remove the maintenance panel:

1. Open the hood.
2. Pull the maintenance panel upward to release the clips that hold it in place.

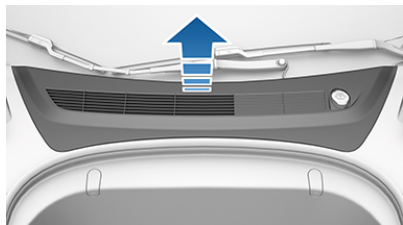

3. If checking the battery coolant, remove the cabin intake trim panel by pulling it upwards to release the clips that hold it in place.

Caution: The maintenance panel protects the front trunk from water. When re-attaching, make sure it is fully seated.

Checking Battery Coolant

If the quantity of fluid in the cooling system drops below the recommended level, the touchscreen displays a warning message. Stop driving Model 3 as soon as safety permits and contact Tesla.

Fluid Level Check

DO NOT REMOVE THE FILLER CAP AND DO NOT ADD FLUID. Doing so can result in damage not covered by the warranty.

Do Not Top Up Battery Coolant

Warning: Battery coolant can be hazardous and can irritate eyes and skin. Under no circumstances should you remove the filler cap and/or add coolant. If the touchscreen warns you that the fluid level is low, contact Tesla immediately.

To maximize the performance and life of the Battery, the cooling system uses a specific mixture of G-48 ethylene-glycol coolant (HOAT). Contact Tesla for more specific information about the coolant.

Checking Brake Fluid

Warning: Contact Tesla immediately if you notice increased movement of the brake pedal or a significant loss of brake fluid. Driving under these conditions can result in extended stopping distances or complete brake failure.



The Brake indicator on the touchscreen alerts you if the quantity of fluid in the brake reservoir drops below the recommended level. If it displays while driving, stop as soon as safety permits by gently applying the brakes. Do not continue driving. Contact Tesla immediately.

Topping Up the Brake Fluid

Do not top up your brake fluid. The following instructions are provided for information purposes and future reference only:

1. Clean the filler cap before removing it to prevent dirt from entering the reservoir.
2. Unscrew the cap and remove it.
3. Top up the reservoir to the MAX mark using the appropriate brake fluid.
4. Replace the filler cap, ensuring it is fully secured.

Warning: Only use new fluid from a sealed air-tight container. Never use previously used fluid or fluid from a previously opened container—fluid absorbs moisture which decreases braking performance.

Warning: Brake fluid is highly toxic. Keep containers sealed and out of the reach of children. In the event of accidental consumption, seek medical attention immediately.

Caution: Brake fluid damages painted surfaces. Immediately soak up any spills with an absorbent cloth and wash the area with a mixture of car shampoo and water.



Topping Up Washer Fluid

The only reservoir into which you can add fluid is the washer fluid reservoir, which is located behind the front trunk. When the level is low, a message displays on the touchscreen.

- ⚠ Caution:** Do not add formulated washer fluids that contain water repellent or bug wash. These fluids can cause streaking, smearing, and squeaking or other noises.

Operate the washers periodically to check that the nozzles are clear and properly directed. See [Wipers and Washers](#) on page 45.

To top up the washer fluid:

1. Open the hood.
2. Clean around the filler cap before opening it to prevent dirt from entering the reservoir.
3. Open the filler cap.

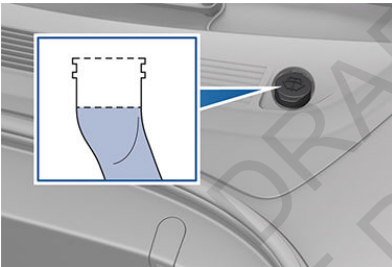

4. Fill the reservoir until the fluid level is visible just below the filler neck.
5. Replace the filler cap.

Note: Some national or local regulations restrict the use of Volatile Organic Compounds (VOCs). VOCs are commonly used as antifreeze in washer fluid. Use a washer fluid with limited VOC content only if it provides adequate freeze resistance for all climates in which you drive Model 3.

- ⚠ Caution:** Under no circumstances do you need to inspect or top up other fluid reservoirs. Two additional fluid reservoirs are located next to the washer fluid, but underneath the maintenance panel. In the unlikely event that you see a message on the touchscreen that one of these fluid levels is low, stop driving Model 3 as soon as safe to do so, and contact Tesla.
- ⚠ Caution:** Do not spill washer fluid on body panels. Doing so can cause damage. Wipe up spills immediately and wash the affected area with water.

- ⚠ Warning:** In temperatures below 40° F (4° C), use a washer fluid with antifreeze. In cold weather, using a washer fluid without antifreeze can impair visibility through the windshield.
- ⚠ Warning:** Windshield washer fluid can irritate eyes and skin. Read and observe the instructions provided by the washer fluid manufacturer.



Jacking Procedure

Follow the steps below to lift Model 3. Ensure that any non-Tesla repair facility is aware of these lifting points.

1. Position Model 3 centrally between the lift posts.
2. Position the lift arm pads under the designated body lift points at the locations shown.

⚠ Warning: DO NOT position the lift arm pads under the Battery or side rails, as shown in red.

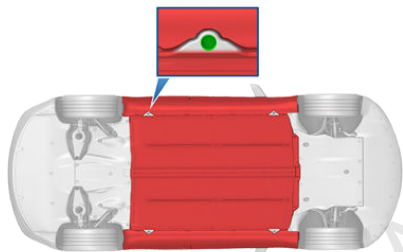

3. Adjust the height and position of the lift arm pads to ensure that they are correctly located.
4. With assistance, raise the lift, ensuring the lift arm pads remain in their correct positions.

⚠ Warning: Never raise Model 3 when the charge cable is connected, even if charging is not in progress.

⚠ Warning: Do not work on an incorrectly supported vehicle. Doing so can cause serious damage, bodily injury, or death.

⚠ Caution: DO NOT lift from under the Battery. Place the lift arm pads under the designated body lift points only. The locations shown are the only approved lifting points for Model 3. Lifting at any other points can cause damage. Damage caused by incorrectly lifting Model 3 is not covered by the warranty.



Parts, Accessories, and Modifications

Use only genuine Tesla parts and accessories. Tesla performs rigorous testing on parts to ensure their suitability, safety, and reliability. Purchase these parts from Tesla, where they are professionally installed and where you can receive expert advice about modifications to Model 3. Accessories are available for purchase from Tesla stores or online at www.tesla.com/shop.

Tesla is unable to assess parts manufactured by other distributors and therefore accepts no responsibility if you use non-Tesla parts on Model 3.

- ⚠ Warning:** Installing non-approved parts and accessories, or performing non-approved modifications, can affect the performance of Model 3 and the safety of its occupants. Any damage caused by using or installing non-approved parts, or by performing non-approved modifications, is not covered by the warranty.
- ⚠ Warning:** Tesla does not accept liability for death, personal injury or damage that occurs if you use or install non-approved accessories or make non-approved modifications.

Accessory Wheels and Tires

If your Model 3 is fitted with Tesla accessory wheels or tires, the Gross Axle Weight Rating (GAWR), wheel, tire, and loading information may be different from the labels shown on the vehicle. Refer to the relevant following section for updated information.

Note: If your vehicle is not fitted with Tesla accessory wheels or tires (it is fitted with the factory original wheels and tires, including Tesla genuine replacement parts), refer to the labels attached to the center door pillar for the most accurate information for your Model 3.

20" Sport Wheels



Wheels	Location	Width (in)	Offset (mm)
20"	Front/Rear	8.5	40

Tires (front/rear)	Size	Tire Pressure
Michelin, Pilot Sport 4S (PS4S)	235/35ZR20	42 PSI (290 kPa)*

*Increase the tire pressure to 44 PSI (300 kPa) prior to driving 136 mph (220 kph) or faster.

GAWR		
Front	2407 lbs	1,092 kg
Rear	2,767 lbs	1,255 kg



19" Sport Wheels



18" Aero Wheels



Wheels	Location	Width (in)	Offset (mm)
19"	Front/Rear	8.5	40

Wheels	Location	Width (in)	Offset (mm)
18"	Front/Rear	8.5	40

Tires (front/rear)	Size	Tire Pressure
Continental, ProContact RX	235/40R19	42 PSI (290 kPa)*
Hankook Ventus S1 Evo3	235/40R19	42 PSI (290 kPa)*
Pirelli Winter Sottozero 3	235/40R19	42 PSI (290 kPa)

Tires (front/rear)	Size	Tire Pressure
Michelin, Primacy MXM4	235/45R18	42 PSI (290 kPa)
Michelin, Pilot Sport 4 (PS4)	235/45R18	42 PSI (290 kPa)
Pirelli Winter Sottozero Serie II	235/45R18	42 PSI (290 kPa)

*Increase the tire pressure to 44 PSI (300 kPa) prior to driving 134 mph (215 kph) or faster.

GAWR		
Front	2,447 lbs	1,110 kg
Rear	2,767 lbs	1,255 kg

GAWR		
Front	2,447 lbs	1,110 kg
Rear	2,840 lbs	1,288 kg



Body Repairs

If Model 3 is in a collision, contact Tesla to ensure that it is repaired with genuine Tesla parts. Tesla has selected and approved body shops that meet strict requirements for training, equipment, quality, and customer satisfaction.

Some repair shops and insurance companies might suggest using non-original equipment or salvaged parts to save money. However, these parts do not meet Tesla's high standards for quality, fit and corrosion resistance. In addition, non-original equipment and salvaged parts (and any damage or failures they might cause) are not covered by the warranty.

Using RFID Transponders

When attaching an RFID transponder (used by many automated toll systems) inside Model 3, place the transponder on the right side of the rear view mirror as shown. This ensures best results and minimizes any obstruction to your driving view.

Note: You can also attach a weather-proof transponder to the front license plate.





Vehicle Identification Number

You can find the VIN at the following locations:

- Touch the Tesla "T" at the top center of the touchscreen. The popup window displays the VIN.
- Stamped on a plate located at the top of the dashboard. Can be seen by looking through the windshield.



- Printed on the Vehicle Certification label, located on the door pillar. Can be seen when the driver's door is open.



Emission Control Label

The emission control label is located on the opening face of the rear trunk.

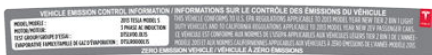



Load Capacity Labeling

It is important to understand how much weight your Model 3 can safely carry. This weight is called the vehicle capacity weight and includes the weight of all occupants, cargo and any additional equipment added to your Model 3 since it was manufactured.

Two labels attached to the center door pillar indicate how much weight Model 3 can safely carry. Labels are visible when the front door is open.

Note: If your Model 3 is fitted with Tesla accessory wheels or tires, some information may be different from the labels on the vehicle. See [Accessory Wheels and Tires](#) on page 127.

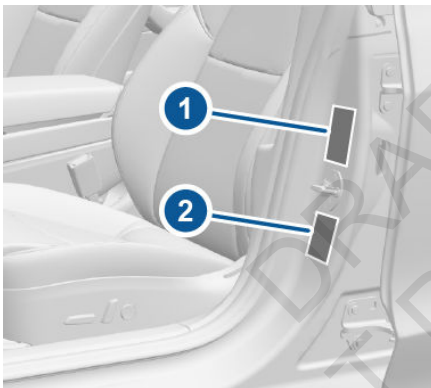

1. Tire and Loading Information Label
2. Vehicle Certification Label

Warning: Overloading Model 3 has an adverse effect on braking and handling, which can compromise your safety or cause damage.

Caution: Never load more than 55 lbs (25 kg) in the front trunk. Doing so can cause damage.

Caution: Never load more than 130 lbs (60 kg) on the rear load floor (above the lower trunk compartment) or more than 130 lbs (60 kg) in the lower trunk compartment. Doing so can cause damage.

Caution: Never store large amounts of liquid in Model 3. A significant spill can cause electrical components to malfunction.

Tire and Loading Information Label

The Tire and Loading Information label provides:

- The maximum number of occupant seating positions.
- The maximum vehicle capacity weight.
- The size of the original tires.
- The cold inflation pressures for the original front and rear tires. These pressures are recommended to optimize ride and handling characteristics.

U.S. and Canada:

TIRE AND LOADING INFORMATION
RENSEIGNEMENTS SUR LES PNEUS ET LE CHARGEMENT

SEATING CAPACITY/NOMBRE DE PLACES - TOTAL X FRONT/AVANT X REAR/ARRIÈRE X
LE POIDS TOTAL DES OCCUPANTS ET DU CHARGEMENT NE DOIT JAMAIS DÉPASSER

TIRE/PNEU	FRONT/AVANT	REAR/ARRIÈRE	SPARE/DE SECOURS
ORIGINAL TIRE SIZE/ TAILLE DES PNEUS D'ORIGINE	depends on vehicle model	depends on vehicle model	NONE/AUCUN
COLD TIRE PRESSURE/ PRESSION DES PNEUS À FROID	depends on vehicle model	depends on vehicle model	NONE/AUCUN

SEE OWNER'S MANUAL FOR ADDITIONAL INFORMATION. VOIR LE MANUEL DE L'USAGER POUR PLUS DE RENSEIGNEMENTS.

Mexico:

INFORMACIÓN DE NEUMÁTICOS Y DE CARGA

NÚMERO TOTAL DE PLAZAS - ADELANTE 2 ATRÁS
EL PESO COMBINADO DE LOS OCUPANTES Y LA CARGA NUNCA DEBE EXCEDER

NEUMÁTICO	DELANTERO	TRASERO	REFACCIÓN
TAMANO DE NEUMÁTICO ORIGINAL			N/A
PRESIÓN DE INFLADO PARA LLANTAS EN FRO			N/A

CONSULTE EL MANUAL DEL PROPIETARIO PARA MÁS INFORMACIÓN

Never change this label, even if you use different tires in the future.

Note: If Model 3 is loaded to its full capacity, double check all tires to ensure they are inflated to their recommended pressure levels.

Vehicle Certification Label

The Vehicle Certification label provides:

- GVWR - Gross Vehicle Weight Rating. The maximum allowable total mass of Model 3. This is calculated as the weight of Model 3, all passengers, fluids, and cargo.
- GAWR FRT and GAWR RR - Gross Axle Weight Rating for the front and rear axles. The GAWR is the maximum distributed weight that each axle can support.

MFD BY TESLA, INC. WITH TIRES			
GAWR	TESLA		
GAWR FRT	WITH TIRES	RIM	COLD TIRE PRESSURE
GAWR RR	WITH TIRES	RIM	COLD TIRE PRESSURE
THIS VEHICLE CONFORMS TO ALL APPLICABLE U.S. FEDERAL MOTOR VEHICLE SAFETY, BUMPER, AND THEFT PREVENTION STANDARDS IN EFFECT ON THE DATE OF MANUFACTURE SHOWN ABOVE.			

Caution: To prevent damage, never load Model 3 so that it is heavier than GVWR or exceeds the individual GAWR weights.

Calculating Load Limits

1. Locate the statement “The combined weight of occupants and cargo should never exceed XXX kg or XXX lbs” on the “Tire and Loading Information” label.
2. Determine the combined weight of all occupants that will ride in the vehicle.
3. Subtract the combined weight of the occupants from XXX kg or XXX lbs (see Step 1).
4. The resulting figure equals the available cargo load capacity. For example, if the “XXX” amount equals 1400 lbs (635 kg) and there will be five 150 lb (68 kg) passengers in the vehicle, the amount of available cargo capacity is 650 lbs (1400 - 750 (5 x 150) = 650 lbs) or 295 kg (635 - 340 (5 x 68) = 295 kg).
5. Determine the combined cargo weight being loaded on the vehicle. That weight must not exceed the available cargo load capacity calculated in Step 4.

Warning: Trunks are the preferred places to carry objects. In a collision, or during hard braking and sharp turns, loose items in the cabin could injure occupants.

Example Load Limit Calculations

How much cargo Model 3 can carry depends on the number and weight of passengers. The following calculated load limit examples assume passengers weigh 150 lbs (68 kg). If passengers weigh more or less, available cargo weight decreases or increases respectively.

Driver and one passenger

Description	Total
Vehicle capacity weight	954 lbs (433 kg)
Subtract occupant weight (2 x 150 lbs/68 kg)	300 lbs (136 kg)
Available cargo weight	654 lbs (297 kg)

Driver and four passengers

Description	Total
Vehicle capacity weight	954 lbs (433 kg)
Subtract occupant weight (5 x 150 lbs/68 kg)	750 lbs (340 kg)
Available cargo weight	204 lbs (93 kg)

The cargo weight should be distributed between the front and rear trunks.

Caution: Do not exceed the maximum front trunk load weight of 55 lbs (25 kg).

Caution: Never load more than 130 lbs (60 kg) on the rear load floor (above the lower trunk compartment) or more than 130 lbs (60 kg) in the lower trunk compartment. Doing so can cause damage.

Towing a Trailer

Warning: Do not use Model 3 for towing purposes. Model 3 does not currently support towing. Towing can cause damage and increase the risk of a collision.

Caution: Using Model 3 for towing before Tesla-approved towing components and accessories are available may void the warranty.

Roof Racks

Model 3 supports the use of Tesla-approved roof racks using a Tesla mounting accessory. To install roof racks, you must use this accessory and you must use only roof rack systems that have been approved by Tesla. Failure to do so can cause significant damage.



Note: Mounting accessories and roof rack systems may not be available at time of vehicle purchase.

DRAFT
DO NOT DISTRIBUTE



Exterior Dimensions

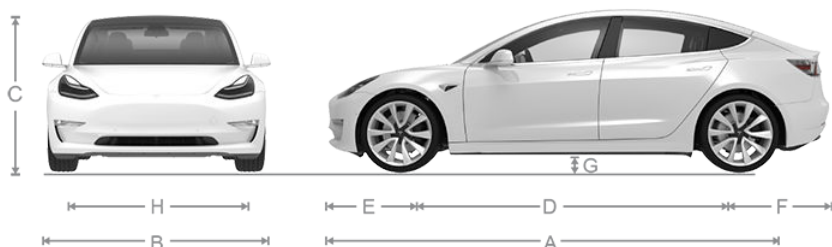

A	Overall Length	184.8 in	4,694 mm
B	Overall Width (including mirrors)	82.2 in	2,088 mm
	Overall Width (including folded mirrors)	76.1 in	1,933 mm
	Overall Width (excluding mirrors)	72.8 in	1,849 mm
C	Overall Height - coil suspension	57 in	1,443 mm
D	Wheel Base	113.2 in	2,875 mm
E	Overhang - Front	33 in	841 mm
F	Overhang - Rear	39 in	978 mm
G	Ground Clearance - coil suspension	5.5 in	140 mm
H	Track - Front	62 in	1,580 mm
	Track - Rear	62 in	1,580 mm

Note: Values are approximate. The dimensions can vary depending on vehicle configuration and various other factors.

Interior Dimensions

Leg Room	Front	42.7 in	1,085 mm
	Rear	35.2 in	894 mm
Shoulder Room	Front	56.3 in	1,430 mm
	Rear	54 in	1,372 mm
Hip Room	Front	53.4 in	1,356 mm
	Rear	52.4 in	1,331 mm

Cargo Volume

Total enclosed cargo volume	15 cu ft
-----------------------------	----------



Weights

Curb Weight* - Long Range Battery	3,838 lbs	1,741 kg
GVWR** - Long Range Battery	4,801 lbs	2,178 kg
Gross Vehicle Weight Distribution - Long Range Battery	Front: 44.5%	Rear: 55.5%
Gross Axle Weight Rating - Front	2,447 lbs	1,110 kg
Gross Axle Weight Rating - Rear: 18" wheels	2,840 lbs	1,288 kg
Gross Axle Weight Rating - Rear: 19" wheels	2,767 lbs	1,255 kg
Trailer Towing	Not permissible	
*Curb Weight = weight of the vehicle with correct fluid levels, no occupants and no cargo		
**GVWR = Gross Vehicle Weight Rating		

**Transmission**

Type	Single speed fixed gear
Gearbox Ratio	9:1

Brakes

Type	4-wheel anti-lock braking system (ABS) with Electronic Brake Force Distribution, Integrated Advanced Stability Control and Electronic Accelerator pedal actuated regenerative braking system
Calipers	Front: Four piston fixed Rear: Integrated Electronic Parking Brake Sliding
Rotor Diameters (ventilated)	Front: 12.6"/320 mm Rear: 13.2"/335 mm
Front Rotor thickness	New: 0.98"/25 mm Service limit: 0.91"/23 mm
Rear Rotor thickness	New: 0.79"/20 mm Service limit: 0.71"/18 mm
Front Brake Pad Thickness (excluding back plate)	New: 0.393"/10 mm Service limit: 0.110"/2.8 mm
Rear Brake Pad Thickness (excluding back plate)	New: 0.354"/9 mm Service limit: 0.078"/2 mm
Parking brake	Electrically actuated parking brake integrated into rear caliper

Suspension

Front	Independent, double wishbone, coil spring/telescopic damper, sway bar
Rear	Independent, multi-link, coil spring/telescopic damper

Battery - 12V

Rating	33 amp hour or higher
Voltage and Polarity	12V negative (-) ground

Battery - High Voltage

Type	Liquid-cooled lithium ion (Li-ion)
------	------------------------------------



Nominal Voltage	350 V DC
Temperature Range	Do not expose Model 3 to ambient temperatures above 140° F (60° C) or below -22° F (-30° C) for more than 24 hours at a time.

DRAFT
DO NOT DISTRIBUTE



Wheel Specifications

Wheel Diameter	Location	Width (in)	Offset (mm)
18"	Front/Rear	8.5	40
19"	Front/Rear	8.5	40

Lug Nut Torque	129 lb. ft (175 Nm)
Lug Nut Socket Size	21 mm
Note: For instructions on how to jack/lift Model 3, see Jacking and Lifting on page 126.	

Tire Specifications

Tire Size	Location	Size
18"	Front/Rear	P235/45R18
19"	Front/Rear	P235/40R19
Tire pressures vary depending on the type of tires fitted. Refer to the tire pressures printed on the Tire and Loading Information label. This label is located on the center door pillar and is visible when the driver's door is open (see Maintaining Tire Pressures on page 113).		
Winter tires can be purchased from a Tesla store.		

Understanding Tire Markings

Laws require tire manufacturers to place standardized information on the sidewall of all tires. This information identifies and describes the fundamental characteristics of the tire. It also provides the tire identification number (TIN) for certification of safety standards, and in case of a recall.



1	Tire category. P indicates that the tire is for passenger vehicles.
2	Tire width. This 3-digit number is the width (in millimeters) of the tire from sidewall edge to sidewall edge.
3	Aspect ratio. This 2-digit number is the sidewall height as a percentage of the tread width. So, if the tread width is 205 mm, and the aspect ratio is 50, the sidewall height is 102 mm.
4	Tire construction. R indicates that the tire is of Radial ply construction.
5	Wheel diameter. This 2-digit number is the diameter of the wheel rim in inches.
6	Load index. This 2 or 3-digit number is the weight each tire can support. This number is not always shown.
7	Speed rating. When stated, indicates the maximum speed (in mph) at which the tire can be used for extended periods. Q=99 mph (160 km/h), R=106 mph (170 km/h), S=112 mph (180 km/h), T=118 mph (190 km/h), U=124 mph (200 km/h), H=130 mph (210 km/h), V=149 mph (240 km/h), W=168 mph (270 km/h), Y=186 mph (300 km/h).
8	Tire composition and materials. The number of plies in both the tread area and the sidewall area indicates how many layers of rubber coated material make up the structure of the tire. Information is also provided on the type of materials used.
9	Maximum tire load. The maximum load which can be carried by the tire.
10	Maximum permissible inflation pressure. This pressure should not be used for normal driving.



11	U.S. DOT Tire Identification Number (TIN). Begins with the letters DOT and indicates that the tire meets all federal standards. The next 2 digits/letters represent the plant code where it was manufactured, and the last 4 digits represent the week and year of manufacture. For example, the number 1712 is used to represent the 17th week of 2012. The other numbers are marketing codes used at the manufacturer's discretion. This information can be used to contact consumers if a tire defect requires a recall.
12	Treadwear grade. This number indicates the tire's wear rate. The higher the treadwear number is, the longer it should take for the tread to wear down. A tire rated at 400, for example, lasts twice as long as a tire rated at 200.
13	Traction grade. Indicates a tire's ability to stop on wet roads. A higher graded tire should allow you to stop your vehicle in a shorter distance than a tire with a lower grade. Traction is graded from highest to lowest as AA, A, B, and C.
14	Temperature grade. The tire's resistance to heat is grade A, B, or C, with A indicating the greatest resistance. This grading is provided for a correctly inflated tire, which is being used within its speed and loading limits.

DRAFT
DO NOT DISTRIBUTE



Uniform Tire Quality Grading

The following information relates to the tire grading system developed by the National Highway Traffic Safety Administration (NHTSA), which grades tires by tread wear, traction and temperature performance. Tires that have deep tread, and winter tires, are exempt from these marking requirements.

Where applicable, quality grades are found on the tire's sidewall between the tread shoulder and maximum section width. For example:

- TREADWEAR 180
- TRACTION AA
- TEMPERATURE A

The quality grades are described next.

Note: In addition to the marking requirements, passenger car tires must conform to Federal Safety Requirements.

Treadwear

The treadwear grade is a comparative rating based on the wear rate of the tire when tested under controlled conditions on a specified government test course.

For example, a tire graded 150 wears one and a half times better on a government test course than a tire graded 100. The relative performance of tires depends on the actual conditions of their use, however, and can depart significantly from the norm due to variations in driving habits, service practices, road characteristics, and climate.

Traction

The traction grades, from highest to lowest, are: AA, A, B, and C. These grades represent a tire's ability to stop on wet pavement as measured under controlled conditions on test surfaces of asphalt and concrete. A tire marked C might have poor traction performance.

Warning: Defective tires are dangerous. Do not drive if a tire is damaged, excessively worn, or is inflated to an incorrect pressure. The safety of the vehicle and occupants can be adversely affected. Check tires regularly for wear and to ensure there are no cuts, bulges or exposure of the ply/cord structure.

Warning: The traction grade assigned to the tire is based on straight-ahead braking tests, and does not include:

acceleration, cornering, hydroplaning or peak traction characteristics.

Temperature

The temperature grades are A (the highest), B, and C, representing the tire's resistance to the generation of heat and its ability to dissipate heat when tested under controlled conditions on a specified indoor laboratory test wheel. Sustained high temperature can cause the tire to degenerate and reduce tire life, and excessive temperature can lead to sudden tire failure.

The grade C corresponds to the minimum level of performance that all passenger car tires must meet under the Federal Motor Safety Standard No. 109. Grades B and A represent levels of performance on the laboratory test wheel that exceed the minimum requirements.

Warning: A tire's temperature grade is established for a tire that is properly inflated and not overloaded. Excessive speed, under-inflation, or excessive loading, either separately or in combination, can cause heat buildup and possible tire failure.



Tire and Loading Glossaries

General Wheel and Tire Terms

Accessory Weight	The combined weight (in excess of those items replaced) of items available as factory installed equipment.
Bead	The inner edge of a tire that is shaped to fit to the rim and form an air tight seal. The bead is constructed of steel wires which are wrapped, or reinforced, by the ply cords.
Cold Tire Pressure	The air pressure in a tire that has been standing in excess of three hours, or driven for less than one mile.
Curb Weight	The weight of a standard vehicle, including any optional equipment fitted, and with the correct fluid levels.
Gross Vehicle Weight	The maximum permissible weight of a vehicle with driver, passengers, load, luggage, and equipment.
kPa (kilo pascal)	A metric unit used to measure pressure. One kilo pascal equals approximately 0.145 psi.
Maximum Inflation Pressure	The maximum pressure to which the tire should be inflated. This pressure is given on the tire side wall in psi (lbf/in ²). ⚠ Caution: This pressure marked on the tire is the maximum allowed by the tire manufacturer. It is not the pressure Tesla recommends using for Model 3.
Maximum Loaded Vehicle Weight	The sum of curb weight, accessory weight, vehicle capacity weight, and production options weight.
Production Options Weight	The combined weight of options installed which weigh in excess of 3 lb more than the standard items that they replaced, and are not already considered in curb or accessory weights.
PSI (lbf/in ²)	Pounds per square inch (the unit used to measure tire pressure).
Recommended Tire Inflation Pressure	Tire inflation pressure, established by Tesla, which is based on the type of tires that are mounted on the vehicle at the factory. This information can be found on the Tire and Loading Information label located on the door pillar.
Rim	The metal support for a tire, or tire and tube, upon which the tire beads are seated.
Vehicle Capacity Weight	The number of seats multiplied by 150 lbs plus the rated amount of load/luggage.

Load Carrying Definitions

Normal occupant weight	68 kilograms (150 lbs) times the number of occupants specified in the second column of the tables for calculating load limits (see Vehicle Loading on page 131).
Occupant distribution	Distribution of occupants in a vehicle.
Passenger car tire	A tire intended for use on passenger cars, multipurpose passenger vehicles, and trucks, that have a gross vehicle weight rating (GVWR) of 10,000 pounds or less.



Rim diameter	Nominal diameter of the bead seat.
Rim size designation	Rim diameter and width.
Rim type designation	The manufacturing industry's designation for a rim by style or code.
Rim width	Nominal distance between the rim's flanges.
Vehicle maximum load on the tire	Load on an individual tire that is determined by distributing to each axle its share of the maximum loaded vehicle weight and dividing by two.
Vehicle normal load on the tire	Load on an individual tire that is determined by distributing to each axle its share of the curb weight, accessory weight, and normal occupant weight and dividing by two.

Pneumatic Radial Tire Definitions

Bead separation	A breakdown of the bond between components in the bead.
Bias ply tire	A pneumatic tire in which the ply cords that extend to the beads are laid at alternate angles substantially less than 90 degrees to the center line of the tread.
Carcass	The tire structure, except tread and sidewall rubber which, that when inflated, bears the load.
Chunking	The breaking away of pieces of the tread or sidewall.
Cord	The strands forming the plies in the tire.
Cord separation	The parting of cords from adjacent rubber compounds.
Cracking	Any parting within the tread, sidewall, or inner liner of the tire extending to cord material.
Extra load tire	A tire designed to operate at higher loads and higher inflation pressure than the corresponding standard tire.
Groove	The space between two adjacent tread ribs.
Inner liner	The layer(s) forming the inside surface of a tubeless tire that contains the inflating medium within the tire.
Inner liner separation	The parting of the inner liner from cord material in the carcass.
Load rating	The maximum load that a tire is rated to carry for a given inflation pressure.
Maximum load rating	The load rating for a tire at the maximum permissible inflation pressure for that tire.
Measuring rim	The rim on which a tire is fitted for physical dimension requirements.
Open splice	Any parting at any junction of tread, sidewall, or inner liner that extends to the cord material.
Outer diameter	The overall diameter of an inflated new tire.



Overall width	The linear distance between the exteriors of the sidewalls of an inflated tire, including elevations due to labeling, decorations, or protective bands or ribs.
Ply	A layer of rubber-coated parallel cords.
Ply separation	A parting of rubber compound between adjacent plies.
Pneumatic tire	A mechanical device made of rubber, chemicals, fabric and steel or other materials, that, when mounted on an automotive wheel, provides the traction and contains the gas or fluid that sustains the load.
Radial ply tire	A pneumatic tire in which the ply cords that extend to the beads are laid at substantially 90 degrees to the center line of the tread.
Reinforced tire	A tire designed to operate at higher loads and at higher inflation pressures than the corresponding standard tire.
Section width	The linear distance between the exteriors of the sidewalls of an inflated tire, excluding elevations due to labeling, decoration, or protective bands.
Sidewall	The portion of a tire between the tread and bead.
Sidewall separation	The parting of the rubber compound from the cord material in the sidewall.
Snow tire	A tire that attains a traction index equal to or greater than 110, compared to the ASTM E1136-93 (re-approved 2003, incorporated by reference, see §571.5) Standard Reference Test Tire when using the snow traction test as described in ASTM F1805-00 (incorporated by reference, see §571.5), and that is marked with an Alpine Symbol specified in S5.5(i) on at least one sidewall.
Test rim	The rim on which a tire is fitted for testing, and may be any rim listed as appropriate for use with that tire.
Tread	The portion of a tire that comes into contact with the road.
Tread rib	A tread section running around the circumference of a tire.
Tread separation	The pulling away of the tread from the tire carcass.
Tread wear indicators (TWI)	The projections within the principal grooves designed to give a visual indication of the degrees of wear of the tread.
Wheel-holding fixture	The fixture used to hold the wheel and tire assembly securely during testing.



Tesla Roadside Assistance is available to you, 24 hours a day, 365 days a year, for the duration of your warranty period.

When contacting Tesla Roadside Assistance, please provide:

- The Vehicle Identification Number (VIN). The VIN is displayed when you touch the Tesla "T" at the top of the touchscreen. The VIN can also be seen on the upper dashboard by looking through the driver's side of the windshield.
- Your exact location.
- The nature of the problem.

Tesla Roadside Assistance is available to speak with roadside service professionals 24/7/365 to answer any questions and explain the proper procedure for transporting your Model 3.

Regional Phone Number(s)

Mexico: [1-800-228-8145](tel:1-800-228-8145)

United States and Canada: [1-877-79TESLA](tel:1-877-79TESLA) ([1-877-798-3752](tel:1-877-798-3752))

Note: The phone number is also available by touching the Tesla "T" at the top center of the touchscreen.

DRAFT
DO NOT DISTRIBUTE



When Transporting Model 3

Always transport Model 3 with all four tires off the ground. A flatbed truck or comparable transport vehicle is recommended. A wheel lift and dolly can be used only when transporting Model 3 for a maximum of 15 miles (25 km), provided the driving speed does not exceed 45 mph (70 km/h). When transporting, whether on a flatbed truck or using a wheel lift and dolly, Model 3 can face either direction.

Do not transport Model 3 using any other method unless specified by Tesla. Follow the steps provided and observe all warnings and cautions. Damage caused by transporting your vehicle is not covered by the warranty.

Note: The following illustrations are for demonstration purposes only.



Never tow Model 3 with the tires contacting the ground, even for short distances. Doing so can cause significant damage. In addition, before pulling Model 3 onto a flatbed truck, you must use the touchscreen to enable Transport Mode. Transport Mode keeps Model 3 in Neutral, allowing the tires to turn freely. Transport Mode also prevents damage that would be caused when the tires turn as you pull Model 3 onto a flatbed truck. Do not attempt to use Transport Mode to tow Model 3 with the tires on the ground. Transport Mode can prevent damage only when used for a limited time and speed, and for a very short distance, such as when you pull Model 3 onto a flatbed truck. If you are unable to activate Transport Mode, you must use self-loading dollies or tire skates to prevent the tires from turning as you pull Model 3 onto a flatbed truck.

Warning: TOWING MODEL 3 WITH THE TIRES CONTACTING THE GROUND CAN CAUSE OVERHEATING AND DAMAGE TO THE REAR MOTOR.

Warning: To prevent damage and overheating of the rear motor when rolling or winching Model 3 onto a flatbed truck, you must either enable Transport Mode or use self-loading dollies or tire

skates. Do not allow the tires to turn without Transport Mode enabled.

Note: Tesla is not responsible for any damage caused by transporting Model 3, including personal or property damage caused by using self-loading dollies or tire skates.

Warning: Model 3 is equipped with high voltage components (see [High Voltage Components](#) on page 105). Before transporting Model 3 as a result of an event (such as a collision) that may have compromised a high voltage component, it is important to assume that these components are energized. Always follow high voltage safety precautions (wearing personal protective equipment, etc.) until emergency response professionals have evaluated the vehicle and can accurately confirm that all high voltage systems are no longer energized. Failure to do so may result in serious injury or death.

Activate Transport Mode

Transport Mode keeps Model 3 in Neutral (which disengages the parking brake) while preventing damage to the rear motor as the wheels turn when pulling Model 3 onto a flatbed truck. The following are required to enable Transport Mode:

- 12V power is required. You are unable to use the touchscreen to activate Transport Mode if Model 3 has no 12V power. See [Jump Starting the 12V Battery](#) on page 148 for instructions on how to jump start the 12V battery.
- Model 3 must detect a valid key (authenticated smartphone or key card). If a key is not detected, the Transport Mode button on the touchscreen is grayed out. See [Keys](#) on page 6.

To activate Transport Mode:

1. Shift into Park.
2. Chock the tires or otherwise ensure Model 3 is stable.
3. Press and hold the brake pedal, then on the touchscreen touch **Controls** > **Service** > **Towing**. A message displays reminding you of how to properly transport Model 3.
4. Hold the **Transport Mode** button until it turns blue. Model 3 is now free-rolling and can be rolled or winched.

To cancel Transport Mode, shift Model 3 into Park.



- ⚠ **Caution:** Transport Mode automatically cancels and the parking brake is applied if Model 3 is rolled faster than 5 mph (8 km/h), 12V power is low, or if Transport Mode has been continuously enabled for 20 minutes. Model 3 sounds its horn to warn you that Transport Mode is about to cancel.

Pull onto the Flatbed Truck

Note: If Model 3 has no 12V power, you need an external 12V power supply to open the hood or use the touchscreen. See [If Model 3 Has No Power](#) on page 148.

1. Activate Transport Mode.
2. Locate the tow eye. The tow eye is located under the carpet in the front trunk.



3. Release the tow eye cover by pressing firmly on the top right perimeter of the cover until it pivots inward, then gently pulling the raised section toward you.

Note: The tow eye cover is connected to the vehicle's red positive (+) terminal.

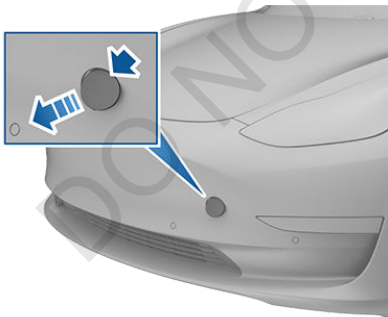

4. Fully insert the tow eye into the opening, then turn it **counter-clockwise** until securely fastened.

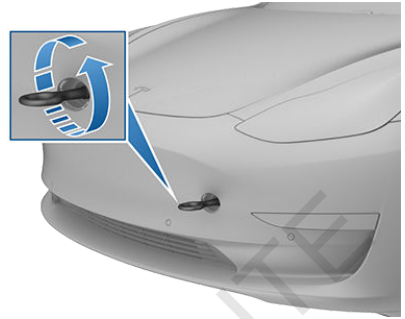

5. Attach the winch cable to the tow eye.
 - ⚠ **Caution:** Before pulling, make sure the tow eye is securely tightened.
6. Pull Model 3 slowly onto the flatbed truck.
7. Shift Model 3 into Park by pressing the button on the end of the gear selector.
8. Remove the tow eye and return it to its location in the front trunk.

Note: The tow eye is required to pull Model 3 onto a flatbed truck. When not being used, always keep the tow eye in its storage location in the front trunk. If you lose the tow eye, contact Tesla.

9. Replace the tow eye cover by inserting the wires into the tow eye opening and aligning the tow eye cover into position and turning it into place.

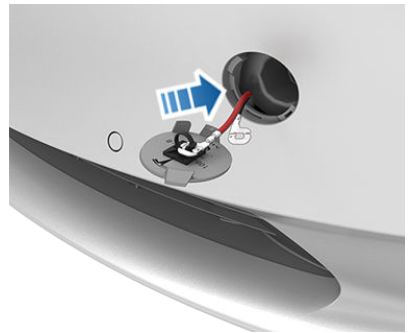

Secure the Tires

The vehicle's tires must be secured onto the truck using the eight-point tie-down method.



- Ensure any metal parts on the tie-down straps do not contact painted surfaces or the face of the wheels.
- Do not place tie-down straps over body panels or through the wheels.



⚠ Caution: Attaching tie-down straps to the chassis, suspension or other parts of the vehicle's body may cause damage.

If Model 3 Has No Power

If Model 3 has no 12V power, perform the following steps to open the hood or jump start the auxiliary 12V battery.

Jump Starting the 12V Battery

⚠ Caution: Model 3 cannot be used to jump start another vehicle. Doing so can result in damage.

Note: If jump starting Model 3 using another vehicle, refer to that vehicle manufacturer's instructions. The following instructions assume an external 12V power supply (such as a portable jump starter) is used.

⚠ Caution: Avoid short circuits when jump starting Model 3. Connecting cables to the wrong terminals, touching leads together, etc. can result in damage to Model 3.

1. Open the hood (see [Opening with No Power](#) on page 15).

2. Remove the maintenance panel by pulling it upwards to release the trim clips that hold it in place.

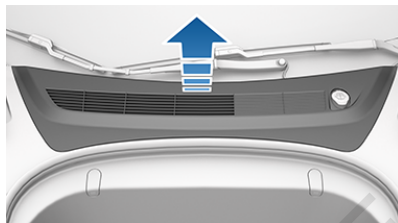

3. Remove the cabin intake trim panel by pulling it upwards to release the trim clips that hold it in place.

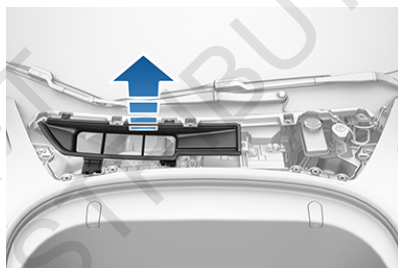

4. Connect the 12V power supply's red positive (+) cable to the red positive (+) terminal on the 12V battery.

⚠ Caution: To avoid damaging Model 3, do not allow the positive cable to contact other metal components, such as the battery tie-down bracket.

5. Connect the 12V power supply's black negative (-) cable to the black negative (-) terminal on the 12V battery.

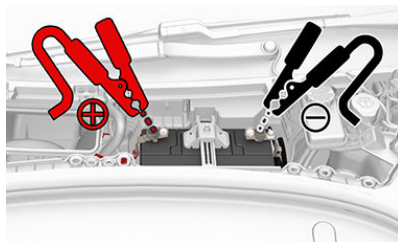

6. Turn on the external power supply (refer to the manufacturer's instructions). Touch the touchscreen to wake it up.

Note: It may take several minutes to receive enough power to wake up the touchscreen.



7. When external 12V power is no longer required, disconnect both cables from the terminals on the 12V battery, beginning with the black negative (-) cable.
8. Replace the cabin intake trim panel by placing it back in its original location and pressing down until it is secure.
9. Replace the maintenance panel by placing it back in its original location and pressing down until it is secure.
10. Close the hood.

DRAFT
DO NOT DISTRIBUTE



Easter Eggs

But wait, there's more! Below is a list of the Easter Eggs that have been discovered so far and how to access them. Alternatively, touch the Tesla "T" (top center of the touchscreen) then drag the **About Your Tesla** box downwards for one-touch access to all discovered Easter Eggs.

For This...	Do This...
Santa Mode	"What have you been longing for?" Enjoy the holidays year-round with this one! Simply initiate a voice command (see Using Voice Commands on page 99) and say "Ho Ho Ho". Or, if you are feeling extra sour, you can say "Ho Ho Ho Not Funny" instead.
Rainbow Road	Feeling nostalgic? Need more cowbell? Visit Rainbow Road by moving the gear lever fully down four times in quick succession while Autosteer is enabled.
Sketchpad	Triple-tap the Tesla "T" (top center of the touchscreen) and channel your inner Picasso. Show us what you got! Touch Publish to submit your artistic compositions to Tesla for critiquing.
Mars	Press and hold the Tesla "T" (top center of the touchscreen) then enter mars in the access code popup. The map shows your Model 3 as a rover on the Martian landscape, and the About Your Tesla box displays SpaceX's interplanetary spaceship.
The Answer to the Ultimate Question of Life, The Universe, and Everything	Rename your car to 42 (see Naming Your Vehicle on page 85) and notice the new name of your Model 3.



Document Applicability

Owner information is updated regularly to reflect updates to your vehicle. However, in some cases, recently released features may not be described. To display information about recently released features, view the Release Notes on the touchscreen. Release Notes are displayed on the touchscreen after a software update, and can be displayed at any time by touching the Tesla "T" at the top of the touchscreen, then touching the Release Notes link. If information related to how to use the touchscreen conflicts with information in the Release Notes, the Release Notes take precedence.

Illustrations

Illustrations are provided for demonstration purposes only. Depending on vehicle options, software version, region of purchase, and specific settings, your vehicle may appear slightly different. Although the owner information is applicable to both right-hand drive and left-hand drive vehicles, many illustrations show only left-hand drive vehicles. However, the essential information that the illustrations are providing is correct.

Errors or Inaccuracies

All specifications and descriptions are known to be accurate at time of publishing. However, because continuous improvement is a goal at Tesla, we reserve the right to make product modifications at any time. To communicate any inaccuracies or omissions, or to provide general feedback or suggestions regarding the quality of this owner information, send an email to OwnersManualFeedback@Tesla.com.

Location of Components

Owner information may specify the location of a component as being on the left or right side of the vehicle. As shown, left (1) and right (2) represent the side of the vehicle when sitting inside.

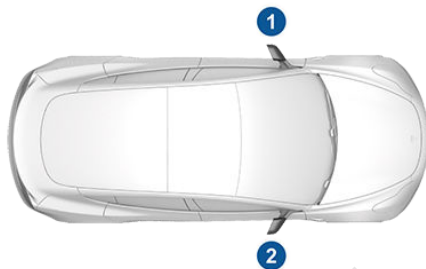

Copyrights and Trademarks

All information in this document and all vehicle software is subject to copyright and other intellectual property rights of Tesla, Inc. and its licensors. This material may not be modified, reproduced or copied, in whole or in part, without the prior written permission of Tesla, Inc. and its licensors. Additional information is available upon request. Tesla uses software created by the Open Source community. Please visit Tesla's Open Source software website at www.tesla.com/opensource. The following are trademarks or registered trademarks of Tesla, Inc. in the United States and other countries:

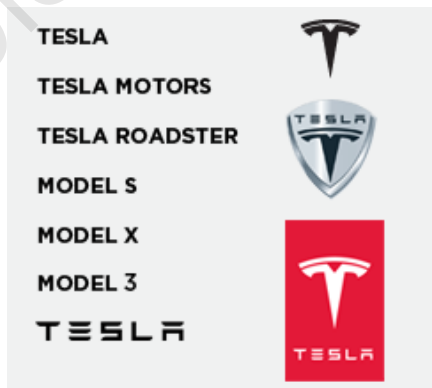

All other trademarks contained in this document are the property of their respective owners and their use herein does not imply sponsorship or endorsement of their products or services. The unauthorized use of any trademark displayed in this document or on the vehicle is strictly prohibited.



Event Data Recorder (EDR)

Model 3 is equipped with an event data recorder (EDR). The main purpose of an EDR is to record, in certain crash or near crash-like situations, such as an air bag deployment or hitting a road obstacle, data that will assist in understanding how a vehicle's systems performed. The EDR is designed to record data related to vehicle dynamics and safety systems for a short period of time, typically 30 seconds or less. The EDR in Model 3 is designed to record data such as:

- How various systems in your vehicle were operating;
- Whether or not the driver and passenger safety belts were buckled/fastened;
- How far (if at all) the driver was depressing the accelerator and/or brake pedal; and,
- How fast the vehicle was traveling.

The data can help provide a better understanding of the circumstances in which crashes and injuries occur.

Note: EDR data is recorded by your vehicle only if a non-trivial crash situation occurs; no data is recorded by the EDR under normal driving conditions and no personal data (e.g., name, gender, age, and crash location) is recorded. However, other parties, such as law enforcement, could combine the EDR data with the type of personally identifying data routinely acquired during a crash investigation.

To read data recorded by an EDR, special equipment is required, and access to the vehicle or the EDR is needed. In addition to the vehicle manufacturer, other parties, such as law enforcement, that have the special equipment, can read the information if they have access to the vehicle or the EDR.

Vehicle Telematics

Model 3 is equipped with electronic modules that monitor and record data from various vehicle systems, including the motor, Autopilot components, Battery, braking and electrical systems. The electronic modules record information about various driving and vehicle conditions, including braking, acceleration, trip and other related information regarding your vehicle. These modules also record information about the vehicle's features such as charging events and status, the enabling/disabling of various systems, diagnostic trouble codes, VIN, speed, direction and location.

The data is stored by the vehicle and may be accessed, used and stored by Tesla service technicians during vehicle servicing or periodically transmitted to Tesla wirelessly through the vehicle's telematics system. This data may be used by Tesla for various purposes, including, but not limited to: providing you with Tesla telematics services; troubleshooting; evaluation of your vehicle's quality, functionality and performance; analysis and research by Tesla and its partners for the improvement and design of our vehicles and systems; and as otherwise may be required by law. In servicing your vehicle, Tesla can potentially resolve issues remotely simply by reviewing your vehicle's data log.

Tesla's telematics system wirelessly transmits vehicle information to Tesla on a periodic basis. The data is used as previously described and helps ensure the proper maintenance of your vehicle. Additional Model 3 features may use your vehicle's telematics system and the information provided, including features such as charging reminders, software updates, and remote access to, and control of, various systems of your vehicle.

Tesla does not disclose the data recorded in your vehicle to any third party except when:

- An agreement or consent from the vehicle's owner (or the leasing company for a leased vehicle) is obtained.
- Officially requested by the police or other authorities.
- Used as a defense for Tesla in a lawsuit.
- Ordered by a court of law.
- Used for research purposes without disclosing details of the vehicle owner or identification information.



- Disclosed to a Tesla affiliated company, including their successors or assigns, or our information systems and data management providers.

In addition, Tesla does not disclose the data recorded to an owner unless it pertains to a non-warranty repair service and in this case, will disclose only the data that is related to the repair.

Data Sharing

For quality assurance and to support the continuous improvement of advanced features such as Autopilot, Tesla measures road segment data of all participating vehicles. All Tesla vehicles can learn from the experience of the billions of miles that Tesla vehicles have driven. Although Tesla shares this data with partners that contribute similar data, the data does not include any personally identifiable information about you or your vehicle. To allow data sharing, touch **Controls > Safety & Security > Settings > Data Sharing**, touch the **Yes** buttons to confirm that you agree to allow Tesla to collect the associated type of data, then submit your response.

Note: Although Model 3 uses GPS in connection with driving and operation, as discussed in this owner's manual, Tesla does not record or store vehicle-specific GPS information. Consequently, Tesla is unable to provide historical information about a vehicle's location (for example, Tesla is unable to tell you where Model 3 was parked/traveling at a particular date/time).

Quality Control

You might notice a few miles/km on the odometer when you take delivery of your Model 3. This is a result of a comprehensive testing process that ensures the quality of your Model 3.

The testing process includes extensive inspections during and after production. The final inspection takes place at Tesla and includes a road test conducted by a technician.

California Proposition 65

- Warning:** Certain vehicle components contain or emit chemicals known to the State of California to cause cancer and birth defects or other reproductive harm. In addition, certain fluids contained in

vehicles and certain products of component wear contain or emit chemicals known to the State of California to cause cancer and birth defects or other reproductive harm.

- Warning:** Certain components of this vehicle such as airbag modules and seat belt pre-tensioners may contain Perchlorate Material. Special handling may be required for service or vehicle end of life disposal. See www.dtsc.ca.gov/hazardouswaste/perchlorate.
- Warning:** Battery posts, terminals, and related accessories contain lead and lead compounds. Wash hands after handling.



Contacting Tesla

For detailed information about your Model 3, go to www.tesla.com, and log on to your Tesla Account, or sign up to get an account.

If you have any questions or concerns about your Model 3, call 1-877-79TESLA (1-877-798-3752).

Note: You can also use voice commands to provide feedback to Tesla. Say "Note", "Report", "Bug note", or "Bug report" followed by your brief comments. Model 3 takes a snapshot of its systems, including your current location, vehicle diagnostic data, and screen captures of the touchscreen. Tesla periodically reviews these notes and uses them to continue improving Model 3.

Reporting Safety Defects - US

If you believe that Model 3 has a defect which could cause a crash or could cause injury or death, you should immediately inform the National Highway Traffic Safety Administration (NHTSA) in addition to notifying Tesla.

If NHTSA receives similar complaints, it may open an investigation. If it finds that a safety defect exists in a group of vehicles, it may order a recall and remedy campaign. However, NHTSA cannot become involved in individual problems between you, your dealer, or Tesla.

To contact NHTSA, you may call the Vehicle Safety Hotline toll-free at 1-888-327-4236 (TTY: 1-800-424-9153); go to www.safercar.gov; or write to: Administrator, National Highway Traffic Safety, 1200 New Jersey Avenue SE., Washington, DC 20590. You can also obtain other information about motor vehicle safety from www.safercar.gov.

Reporting Safety Defects - Canada

If you believe that your Model 3 has a defect which could cause a crash or could cause injury or death, you should immediately inform Transport Canada, in addition to notifying Tesla. To contact Transport Canada, call their toll-free number: 1-800-333-0510.



Passive Entry System

Certification Labels

Pillar Endpoint:

 Tesla, Inc.
Model: 1089773
FCC ID 2AEIM-1089773
IC: 20098-1089773
This device complies with Part 15 of the FCC Rules. Operation is subject to the following two conditions: (1) this device may not cause harmful interference, and (2) this device must accept any interference received, including interference that may cause undesired operation.
CAN ICES-3 (B)/NMB-3(B)

 Tesla, Inc.
Model: 1089773E
FCC ID 2AEIM-1089773E
IC: 20098-1089773E
This device complies with Part 15 of the FCC Rules. Operation is subject to the following two conditions: (1) this device may not cause harmful interference, and (2) this device must accept any interference received, including interference that may cause undesired operation.
CAN ICES-3 (B)/NMB-3(B)

Center Console:

 Tesla, Inc.
Model: 1089774
FCC ID 2AEIM-1089774
IC: 20098-1089774
This device complies with Part 15 of the FCC Rules. Operation is subject to the following two conditions: (1) this device may not cause harmful interference, and (2) this device must accept any interference received, including interference that may cause undesired operation.
CAN ICES-3 (B)/NMB-3(B)

Fascia Endpoint:

 Tesla, Inc.
Model: 1089775
FCC ID 2AEIM-1089775
IC: 20098-1089775
This device complies with Part 15 of the FCC Rules. Operation is subject to the following two conditions: (1) this device may not cause harmful interference, and (2) this device must accept any interference received, including interference that may cause undesired operation.
CAN ICES-3 (B)/NMB-3(B)



FCC Certification

Component	Mfr	Operating Freq (MHz)	Tested For	FCC ID
Pillar Endpoint 1089773 Pillar Endpoint 1089773E	Tesla	13.56 and 2400	US Canada	2AEIM-1089773 2AEIM-1089773E
Center Console 1089774	Tesla	13.56 and 2400	US Canada	2AEIM-1089774
Fascia Endpoint 1089775	Tesla	2400	US Canada	2AEIM-1089775

Per FCC IDs 2AEIM-1089773, 2AEIM-1089773E, 2AEIM-1089774, and 2AEIM-1089775 the Model 3 passive entry devices listed above comply with Part 15 of the FCC rules. Operation is subject to the following two conditions:

1. This device may not cause harmful interference, and
2. This device must accept any interference received, including interference that may cause undesired operation.

Changes or modifications not expressly approved by Tesla could void your authority to operate the equipment.

Important Note:

FCC Radiation Exposure: This equipment complies with FCC radiation exposure limits for an uncontrolled environment.

 **Caution:** This equipment and its antennas must not be co-located or operated with any other antenna or transmitter.

IC Certification

The following device components are used in vehicles in Canada:

- Device Component Numbers: 1089773, 1089773E, 1089774, and 1089775
- Device Manufacturer: Tesla

Per 20098-1089773, 20098-1089773E, 20098-1089774, and 20098-1089775, this device complies with Industry Canada's license-exempt RSS standard(s). Operation is subject to the following two conditions:

1. This device may not cause harmful interference, and
2. This device must accept any interference received, including interference that may cause undesired operation.

IMPORTANT NOTE: IC Radiation Exposure Statement

This equipment complies with IC RSS-102 radiation exposure limits set forth for an uncontrolled environment.

Cet équipement est conforme aux limites d'exposition aux rayonnements IC établies pour un environnement non contrôlé.

CAN ICES-3 (B)/NMB-3(B).

Le présent appareil est conforme aux CNR d'Industrie Canada applicables aux appareils radioexempts de licence. L'exploitation est autorisée aux deux conditions suivantes : (1) l'appareil ne doit pas produire de brouillage, et (2) l'utilisateur de l'appareil doit accepter tout brouillage radioélectrique subi, même si le brouillage est susceptible d'en compromettre le fonctionnement.



Tire Pressure Monitoring System

FCC ID: KR5S180052092

IC: 7812D-S180092

The tire pressure monitoring system (TPMS) complies with Part 15 of the FCC rules and RSS-210 of Innovation, Science and Economic Development Canada. Operation is subject to the following two conditions:

1. This device may not cause harmful interference, and
2. This device must accept any interference received, including interference that may cause undesired operation.

Changes or modifications not expressly approved by Tesla could void your authority to operate the equipment.

HomeLink

This device complies with Part 15 of the FCC rules, RSS-210 Industry Canada, and with EU Directive 2014/53/EU.

Operation is subject to the following conditions:

- This device may not cause harmful interference.
- This device must accept any interference received, including interference that may cause undesired operation.

Any changes or modifications to the device not expressly approved by the manufacturer or Tesla could void your authority to operate the equipment.

Radio Frequency Information

This equipment has been tested and found to comply with the limits for a Class B digital device, pursuant to Part 15 of the FCC Rules. These limits are designed to provide reasonable protection against harmful interference in a residential installation. This equipment generates, uses and can radiate radio frequency energy and, if not installed and used in accordance with the instructions, may cause harmful interference to radio communications. However, there is no guarantee that interference will not occur in a particular installation. If this equipment does cause harmful interference to radio or television reception, which can be determined by turning the equipment off and on, try to correct the interference by one or more of the following measures:

- Reorient or relocate the receiving antenna.
- Increase the separation between the equipment and receiver.
- Connect the equipment into an outlet on a circuit different from that to which the receiver is connected.
- Consult the dealer or an experienced radio/TV technician for help.



A

- ABS (Anti-lock Braking System) 46
- absolute speed limit 79
- access panel, removing 124
- accessories
 - plugging into power socket 16
- aero covers 115
- air circulation 87
- air conditioning 86
- air distribution 87
- air filter 89
- air vents 88
- airbags 29
- alarm 100
- all-season tires 116
- Always Show Estimated Round Trip Energy 97
- ambient lights 42
- anti-lock braking (ABS) 46
- audio
 - equalizer 90
 - immersive sound 90
 - playing files 90
 - steering wheel scroll button 35
 - volume control 90
- auto fold 36
- Auto Lane Change 67
- auto tilt 36
- AUTO wipers 45
- automatic emergency braking 77
- Autopark 69
- Autopilot
 - automatic emergency braking 76
 - Autopark 69
 - Autosteer 64
 - blind spot warning 74
 - collision avoidance assist 76
 - forward collision warning 76
 - overtake acceleration 58
 - overview 55
 - side collision warning 74
 - speed assist 79
 - speed limit warning 79
 - staying within speed limits 79
 - Traffic-Aware Cruise Control 58
- Autopilot components 55
- Autosteer 64

B

- backup camera 53
- battery (12V)
 - complete discharge 107
 - specifications 136
- Battery (high voltage)
 - care of 107
 - coolant 124
 - specifications 136

- Battery (high voltage) (continued)
 - temperature limits 107
- blind spot warning 74
- Bluetooth
 - devices, playing audio files from 92
 - general information 93
 - phone, pairing and using 93
- body repairs 129
- body touch up 120
- brake fluid replacement 112
- brakes
 - automatic in emergencies 77
 - fluid level 124
 - overview of 46
 - specifications 136

C

- cabin camera 54
- cabin temperature control 86
- California Proposition 65 153
- camera (rear view) 53
- cameras (autopilot) 55
- car cover 121
- car washes 119
- card 7
- cargo area 12
- cargo volume 134
- carpets, cleaning 120
- CE certifications 155
- CHAdMO 106
- chains 117
- charge port 108
- charge port light 109
- charging
 - charge settings 109
 - charging status 109
 - components and equipment 105
 - instructions 108
 - public charging stations 106
 - scheduling 109
- charging locations, finding 96
- child protection
 - disabling rear window switches 11
- child protection locks 10
- child seats
 - installing and using 23
- cleaning 119
- climate controls 86
- coat hangers 16
- collision avoidance assist 76
- console
 - 12V power socket 16
 - rear 16
- contact information
 - roadside assistance 145
 - Tesla 154
- coolant



- coolant (continued)
 - Battery, checking level of [124](#)
 - Battery, replacement interval [112](#)
- copyrights [151](#)
- cruise control [58](#)

D

- dashboard overview [2](#)
- data recording [152](#)
- data sharing [152](#)
- declarations of conformity [155](#)
- delivery mileage [153](#)
- devices
 - Bluetooth, playing audio files [92](#)
 - playing audio files from [92](#)
- dimensions [134](#)
- dome (map) lights [42](#)
- door handles [9](#)
- door labels [131](#)
- doors
 - Child Lock [10](#)
 - exterior door handles [9](#)
 - interior locking and unlocking [10](#)
 - keyless entry [9](#)
 - locking [9](#)
 - opening from exterior [9](#)
 - opening from interior [9](#)
 - Unlock on Park [10](#)
 - unlocking [9](#)
 - Walk Away Lock [10](#)
- Drive gear [38](#)
- driver
 - profiles [33](#)
- driving
 - seating position [17](#)
 - starting [37](#)

E

- Easter Eggs [150](#)
- easy entry, driver profile [33](#)
- EDR (event data recorder) [152](#)
- electric parking brake [47](#)
- emergency braking [76](#)
- emergency flashers [44](#)
- emission label [130](#)
- energy
 - gained from regenerative braking [46](#)
 - range information [39](#)
- energy use predictions (navigating) [97](#)
- event data recording [152](#)
- exterior
 - car cover [121](#)
 - cleaning [119](#)
 - dimensions [134](#)
 - lights [42](#)

- exterior (continued)
 - overview [3](#)
 - polishing, touch up, & repair [120](#)

F

- fan speed, interior [87](#)
- favorite destinations [98](#)
- Favorites (Media Player) [91](#)
- Favorites (navigation) [95](#)
- FCC certifications [155](#)
- features, downloading new [104](#)
- firmware (software) updates [104](#)
- flash drives, playing audio files from [92](#)
- flashers, warning [44](#)
- floor mats [121](#)
- fluids
 - replacement intervals [112](#)
 - reservoirs, checking [124](#)
- fog lights [42](#)
- forward collision warning [76](#)
- front passenger detection [31](#)
- front trunk [14](#)

G

- garage doors, opening [101](#)
- gates, opening [101](#)
- GAWR [131](#)
- gears [38](#)
- glovebox [16](#)
- Gross Axle Weight Rating [131](#)
- Gross Vehicle Weight Rating [131](#)
- ground clearance [134](#)
- GVWR [131](#)

H

- hazard warning flashers [44](#)
- head supports [18](#)
- headlights
 - after exit [43](#)
 - controlling [42](#)
 - high beams [42](#)
- heating [86](#)
- high beam headlights [42](#)
- high voltage
 - Battery specifications [136](#)
 - components [105](#)
 - safety [112](#)
- hills, stopping on [51](#)
- hitches [132](#)
- Home location [98](#)
- HomeLink
 - FCC certification [157](#)
 - programming and using [101](#)



hood 14
horn 35
hub caps 115

I

IC certifications 155
identification labels 130
interior
 cleaning 120
 dimensions 134
 lights 42
 overview 2
 temperature control 86
Internet radio 91

J

J1772 106
jacking 126
jump starting 148

K

key
 FCC and IC certifications 155
key card 7
keyless entry 9
keys
 deleting phone authenticated phones 7
 displaying a list of 7
 overview 6

L

label
 Tire and Loading Information 131
 vehicle certification 131
lane assist 74
lane change, automatic 67
lane departure warning 74
LATCH child seats, installing 25
lifting 126
lights
 hazard warning 44
 headlights after exit 43
 turn signals 43
load limits 131
location tracking 95
locking 9
lug nut covers 116

M

maintenance
 brake fluid, checking 124
 cleaning 119
 daily and monthly checks 112
 fluid replacement intervals 112
 panel, removing 124
 replacing wiper blades 122
 service intervals 112
 tires 113
 washer fluid, topping up 125
 washer jets, cleaning 122
map orientation 95
map updates 98
mats 121
media 90
mileage upon delivery 153
mirrors 36
mobile app 7
Mobile Connector
 description 106
 using 108
modifications 127
my car does what? 150

N

naming 85
navigating 95
NCC certifications 155
Neutral gear 38
NHTSA, contacting 154

O

occupancy sensor 31
odometer 5
offset from speed limit 79
Online Routing 97
opening hood without power 148
overhang dimensions 134
overtake acceleration 58
Owner Information, about 151

P

Park Assist 49
Park gear 38
parking brake 47
parking, automatic 69
parts replacement 127
passenger detection 31
passenger front airbag 31
phone



- phone (continued)
 - authenticating as a key [6](#)
 - pairing and using [93](#)
 - removing as a key [7](#)
- phone key [6](#)
- PIN [33](#)
- power socket [16](#)
- power windows [11](#)
- powering on and off [37](#)
- Proposition 65 [153](#)
- public charging stations [106](#)

R

- radar [55](#)
- radio [90](#)
- Radio Frequency information [155](#)
- range
 - regenerative braking [46](#)
- range assurance [52](#)
- Re-route [97](#)
- rear seats, folding and raising [17](#)
- rear view camera [53](#)
- rear window switches, disabling [11](#)
- Recent (Media Player) [91](#)
- Recents (navigation) [95](#)
- regenerative braking [46](#)
- relative speed limit [79](#)
- release notes [104](#)
- restarting the touchscreen [37](#)
- Reverse gear [38](#)
- RFID transponders [127](#)
- roadside assistance [145](#)
- roof racks [132](#)
- rotating tires [114](#)
- Round Trip Energy (navigating) [97](#)
- Routing Preferences [97](#)

S

- safety defects, reporting [154](#)
- safety information
 - airbags [32](#)
 - child seats [27](#)
 - seat belts [22](#)
- seat belts
 - cleaning [120](#)
 - in a collision [21](#)
 - overview of [20](#)
 - pre-tensioners [21](#)
 - wearing when pregnant [21](#)
- seat covers [19](#)
- seat heaters [86](#)
- seating capacity [131](#)
- seats
 - heaters [86](#)
- security settings [100](#)

- sensors [55](#)
- service data recording [152](#)
- service intervals [112](#)
- shifting gears [38](#)
- side collision warning [74](#)
- slip start [48](#)
- smartphone
 - authenticating as a key [6](#)
 - removing as a key [7](#)
- software updates [104](#)
- software version [5](#)
- specifications
 - cargo volume [134](#)
 - dimensions [134](#)
 - exterior [134](#)
 - interior [134](#)
 - tires [138](#)
 - weights [135](#)
 - wheels [138](#)
- speed assist [79](#)
- speed limit warning [79](#)
- stability control [48](#)
- starting [37](#)
- steering wheel
 - adjusting position [35](#)
 - adjusting sensitivity [35](#)
 - buttons [35](#)
 - lights, controlling [42](#)
 - scroll buttons [35](#)
- steering, automatic [64](#)
- Streaming radio [91](#)
- summer tires [116](#)
- Summon [69](#)
- supercharging
 - described [111](#)
 - idle fees [111](#)
 - pay-per-use fees [111](#)
- suspension specifications [136](#)

T

- telematics [152](#)
- temperature
 - Battery (high voltage), limits [107](#)
 - cabin, controls for [86](#)
 - outside [39](#)
 - tires [141](#)
- tie-down straps [147](#)
- Tire and Loading Information label [131](#)
- tire noise [116](#)
- Tire Pressure Monitoring System
 - FCC certification [157](#)
 - overview of [117](#)
- tire pressures, checking [113](#)
- tires
 - all-season [116](#)
 - balancing [114](#)
 - chains [117](#)



- tires (continued)
 - inspecting and maintaining [114](#)
 - pressures, how to check [113](#)
 - quality grading [141](#)
 - replacing [115](#)
 - replacing a tire sensor [118](#)
 - rotation [114](#)
 - specification [138](#)
 - summer [116](#)
 - temperature grades [141](#)
 - tire markings [139](#)
 - traction grade [141](#)
 - treadwear grade [141](#)
 - winter [116](#)
- toll system transponders, attaching [127](#)
- touch up body [120](#)
- touchscreen
 - clean mode [120](#)
 - cleaning [120](#)
 - overview [4](#)
 - restarting [35](#)
 - software updates [104](#)
- tow eye, locating [147](#)
- towing a trailer [132](#)
- towing instructions [146](#)
- TPMS
 - FCC certification [157](#)
 - overview of [117](#)
- Tracking Disabled [95](#)
- traction control [48](#)
- trademarks [151](#)
- Traffic-Aware Cruise Control [58](#)
- trailer hitches [132](#)
- transmission specifications [136](#)
- transponders, attaching [127](#)
- Transport Canada, contacting [154](#)
- Transport Mode [146](#)
- transporting [146](#)
- Trip Planner [97](#)
- trunk, front [14](#)
- trunk, rear [12](#)
- TuneIn radio [91](#)
- turn signals [43](#)

U

- ultrasonic sensors [55](#)
- uniform tire quality grading [141](#)
- Unlock On Park [10](#)
- unlocking [9](#)
- USB devices
 - playing audio files from [92](#)

V

- Valet mode [33](#)
- vehicle certification label [131](#)

- Vehicle Hold [51](#)
- Vehicle Identification Number (VIN) [130](#)
- vehicle loading [131](#)
- ventilation [88](#)
- VIN (Vehicle Identification Number) [130](#)
- volume control [4](#)
- volume control (media) [90](#)

W

- Walk Away Lock [10](#)
- Wall Connector [106](#)
- warning flashers [44](#)
- washer fluid, topping up [125](#)
- washer jets, cleaning [122](#)
- washers, using [45](#)
- weight specifications [135](#)
- wheel chocks [147](#)
- wheels
 - aero covers, removing and installing [115](#)
 - alignment [114](#)
 - lug nut covers, removing and installing [116](#)
 - replacing [115](#)
 - specifications [138](#)
 - torque [138](#)
- Wi-Fi, connecting to [103](#)
- windshield washer fluid, topping up [125](#)
- winter tires [116](#)
- wiper blades, replacing [122](#)
- wipers, using [45](#)
- Work location [98](#)