



Coca-Cola
Freestyle™ Dispenser
CREW GUIDE

POUR

Coca-Cola
Freestyle™

TABLE OF CONTENTS



Coca-Cola Freestyle Dispenser Overview and Use

Coca-Cola Freestyle Dispenser Introduction 3 - 4

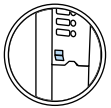

Power the Dispenser On/Off..... 5



Pour a Beverage 6



Use the ADA Interface 7



Daily Tasks

Conduct a Taste Test 8



Check and Refill Ice 9

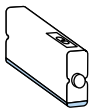

Check Cartridge Level 10

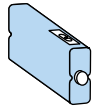

Daily Tasks (continued)

Change a Cartridge 11 - 12

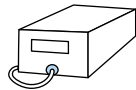

Check and Change High Fructose Corn Syrup (HFCS 65) 13

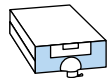

Check Non-Nutritive Sweetener Blend (NNS)..... 14

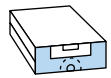

Change Non-Nutritive Sweetener Blend (NNS)..... 15



Preparing for Daily Cleaning Tasks 16

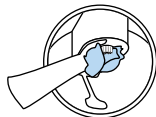

Clean Nozzle 17



Clean Ice Lever, Cup Rest, Drip Tray and Exterior Surfaces 18



Weekly Tasks

Clean NNS Compartment and Connector 19

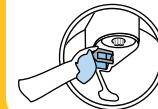

Clean Ice Chute 20



Monthly Tasks

Clean Ice Bin 21



Manager Tasks

Lock the Dispenser 22
Unlock the Dispenser 23



Troubleshooting

Troubleshooting 24 - 26



Frequently Asked Questions (FAQ's)

FAQ's 27

Freestyle Dispenser: Exterior

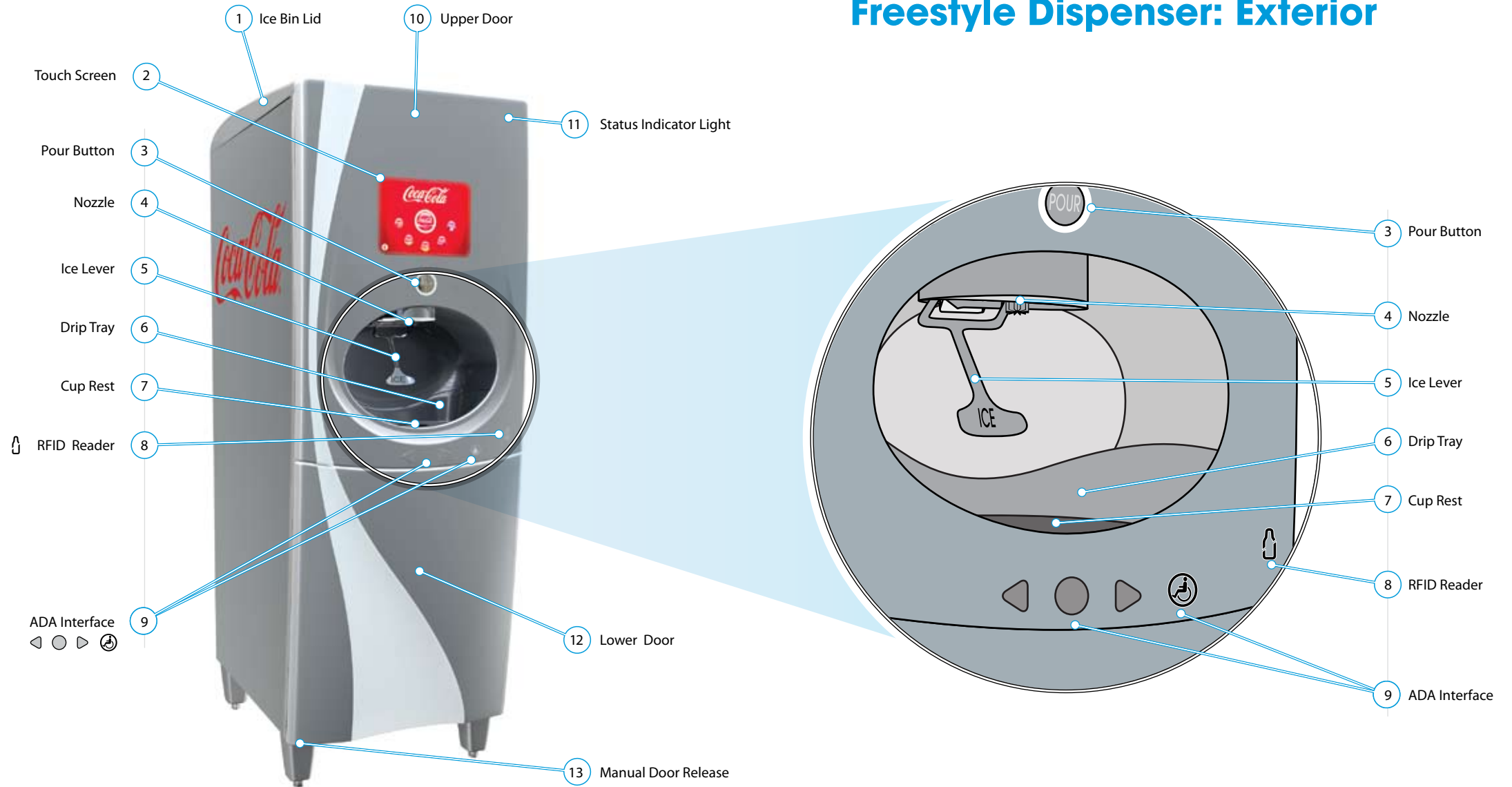

Interior Components

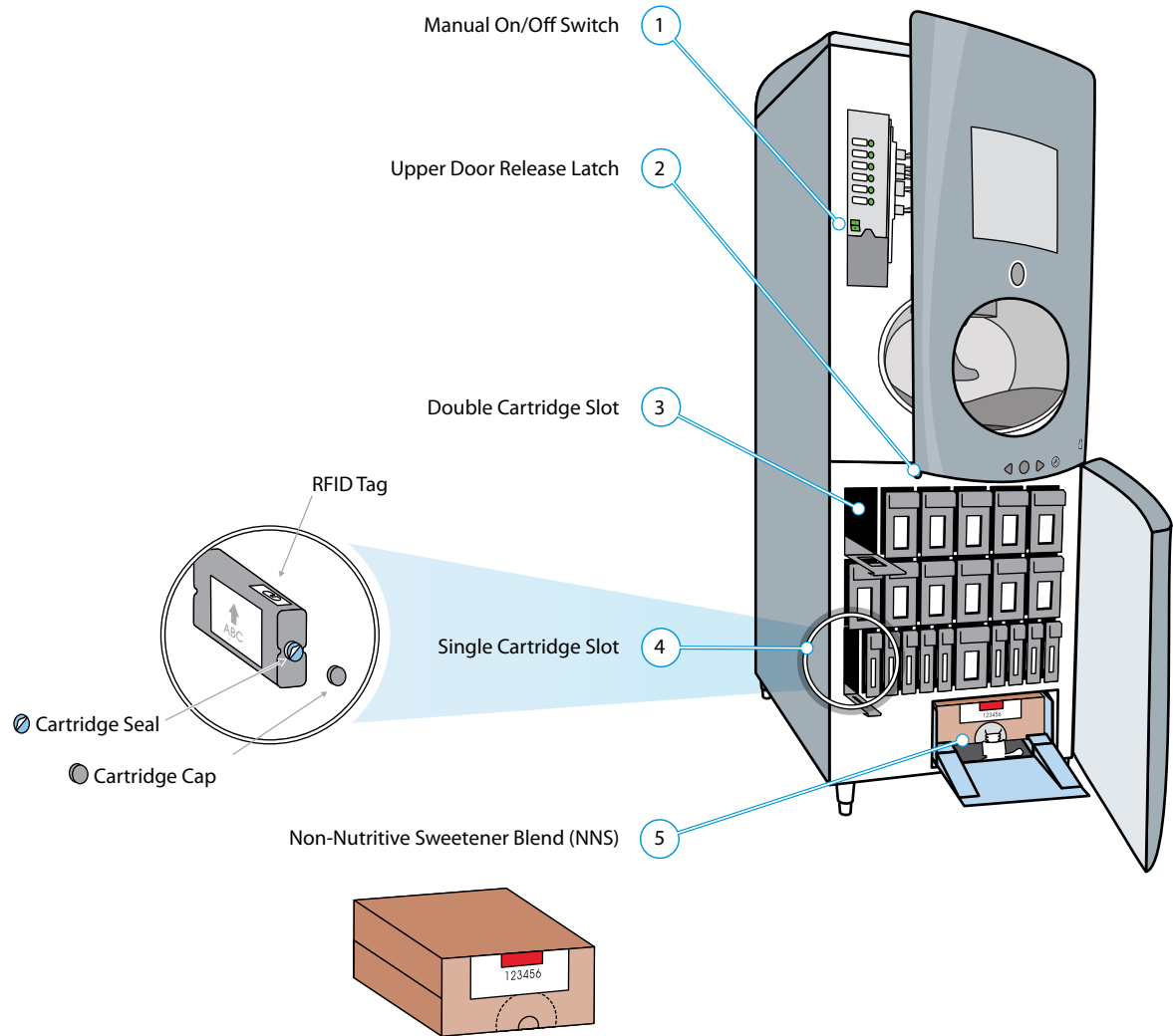

Backroom Components

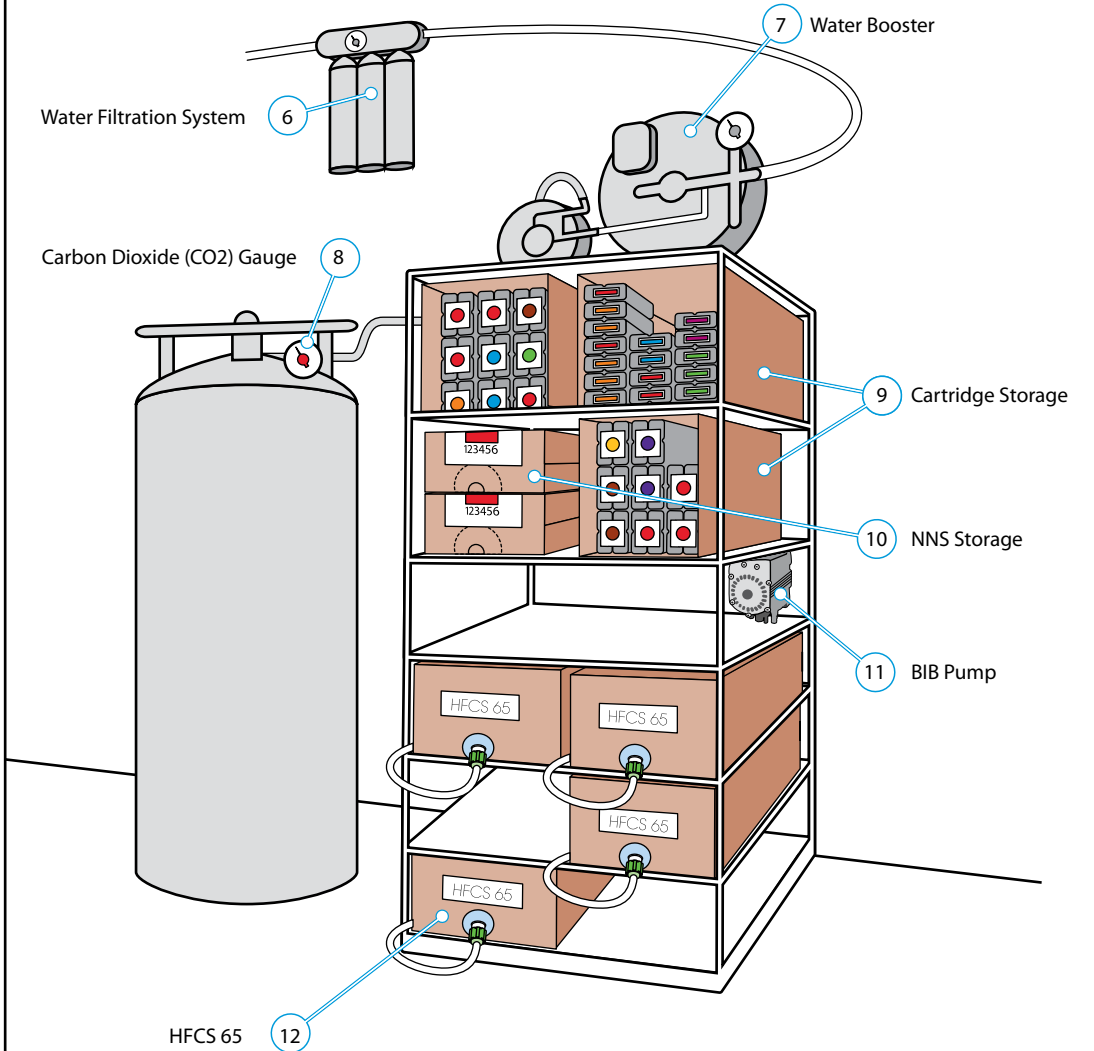

 **CAUTION: DO NOT power on or off the Coca-Cola Freestyle dispenser** unless told to do so in this guide, or by a Coca-Cola technician.

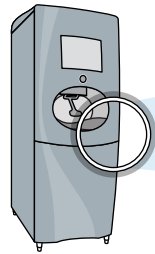

1 Open the lower door in one of 3 ways.

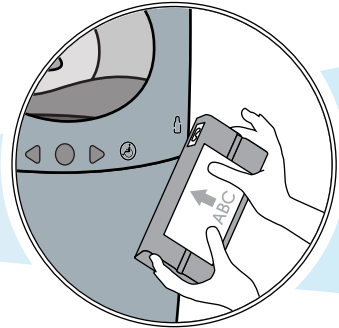

A

Scan a cartridge over the RFID Reader.

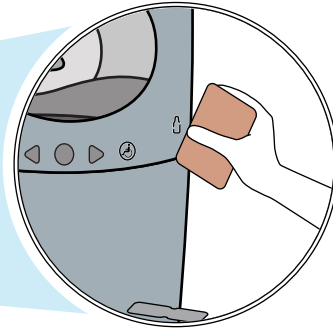

B

Scan a Manager Key Card over the RFID Reader.

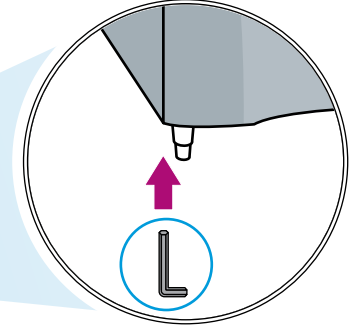
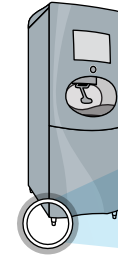

C

Insert a long, thin, sturdy tool (such as an Allen wrench) in the small hole at the bottom of the lower door.



CAUTION: Only use this method if the door cannot be opened by scanning a cartridge or Manager Key Card over the RFID Reader.

2 Lower door opens.

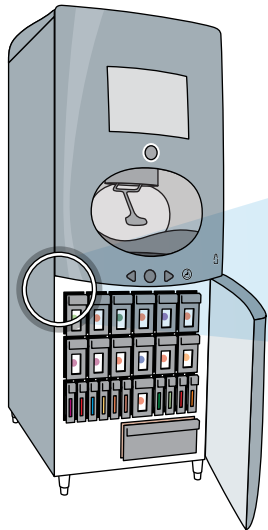

3 Press the upper door release button.

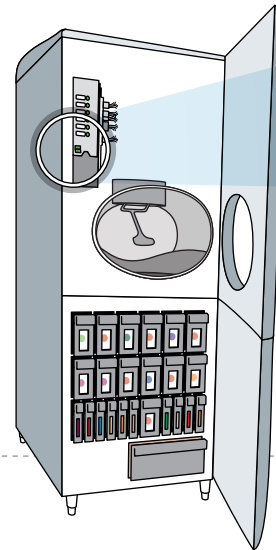
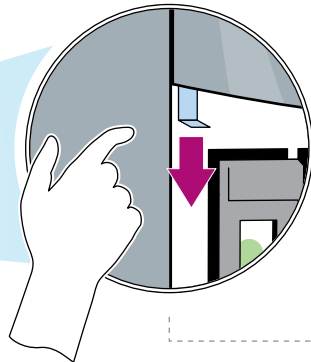

4 Locate and press the power button "on" or "off" as applicable.

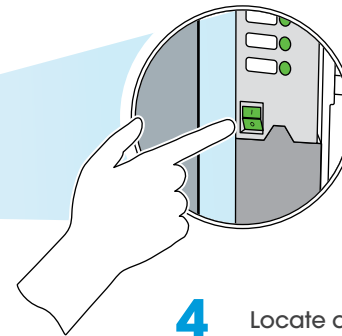

5 Close door securely.

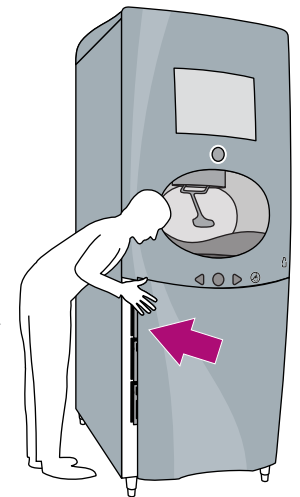

This screen appears when unit has not been used for a period of time.

To choose a beverage, touch the screen anywhere.

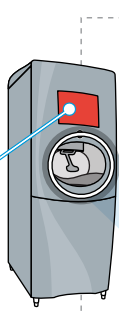

1 Place cup against ice lever and push to dispense ice.
Coca-Cola recommends 1/3 cup of ice.

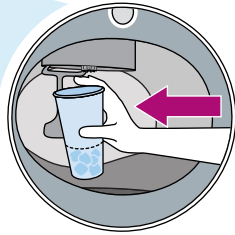

2 This screen appears when the screen is touched or the ice lever is pressed.

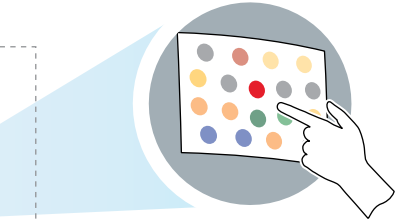

3 Touch beverage brand / flavor.
Note: touch screen will reset after 8 seconds if a drink is not poured.

4 This screen appears when a specific brand is selected.

5 To change beverage selection, touch the back button.

6 Pulsing lighted POUR button indicates ready to pour.
Press and hold POUR button to dispense drink.
Release POUR button when desired fill level is reached.

Pulsing lighted ring on the screen indicates selected beverage choice.

Touch secondary flavor (if desired).

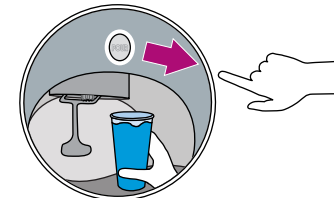
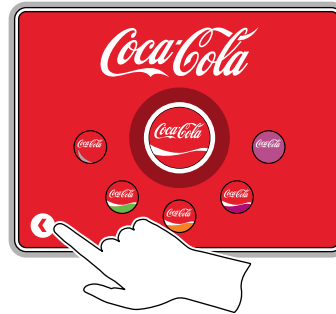
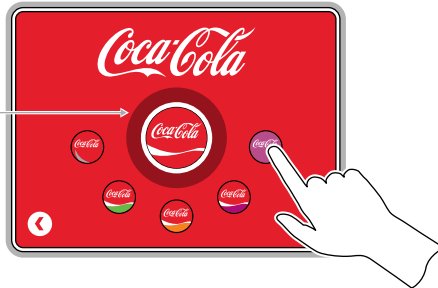



The ADA interface allows people with disabilities (such as those in wheelchairs) to use the Coca-Cola Freestyle dispenser without having to reach the touch screen.

There are three buttons on the ADA Interface.

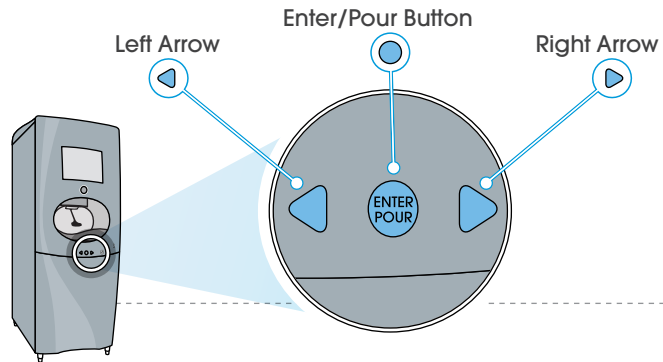

1 To begin, press the Enter/Pour button to show the ADA screen.

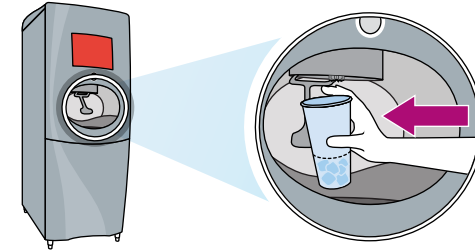

2 Place cup against ice lever and push to dispense ice.

Coca-Cola recommends 1/3 cup of ice.



3 Use the Left Arrow ◀ and Right Arrow ▶ buttons to scroll through available brands. A ring will appear around the active brand.

Press the Enter/Pour button to make a selection.

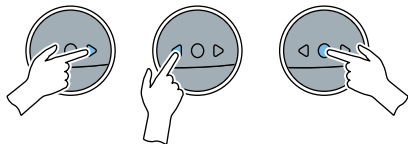

4 Use the Left ◀ and Right Arrow ▶ Buttons to scroll through the available brand flavors. Press the Enter/Pour button to make a selection.

To leave the ADA interface, use the Arrow Buttons ◀ ▶ to navigate to the Exit Button (wheelchair icon), then press the Enter/Pour Button (or touch the Exit Button on screen).

To go back a screen, use the Arrow Buttons ◀ ▶ to navigate to the Back Button (circle with dot), then press the Menu Button (or touch the Back Button on screen).

5 The pulsing lighted Enter/Pour button indicates ready to pour.

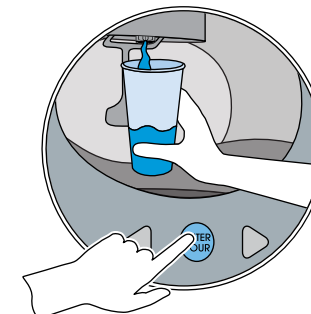
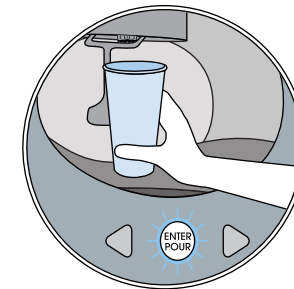

Press and hold the Enter/Pour button to dispense drink.

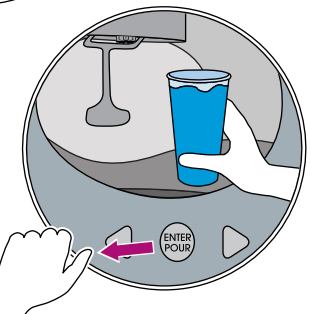

Release the Enter/Pour button when desired fill level is reached.



1 To perform a taste test before serving customers, fill a cup with 8 ounces of a carbonated soft drink — **without ice** — and discard.

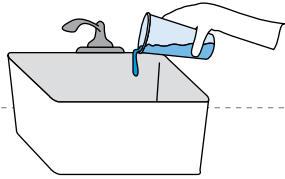

2 Fill a cup with 8 ounces of the same flavor carbonated soft drink — **again without ice** — and taste.

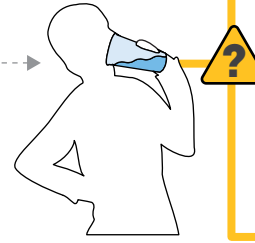

	Is the drink cold?		
	Is it carbonated?		
	Does it taste right?		

3 Repeat steps 1 and 2 for the three main brands offered on the dispenser: **Coca-Cola, Diet Coke and Sprite.**

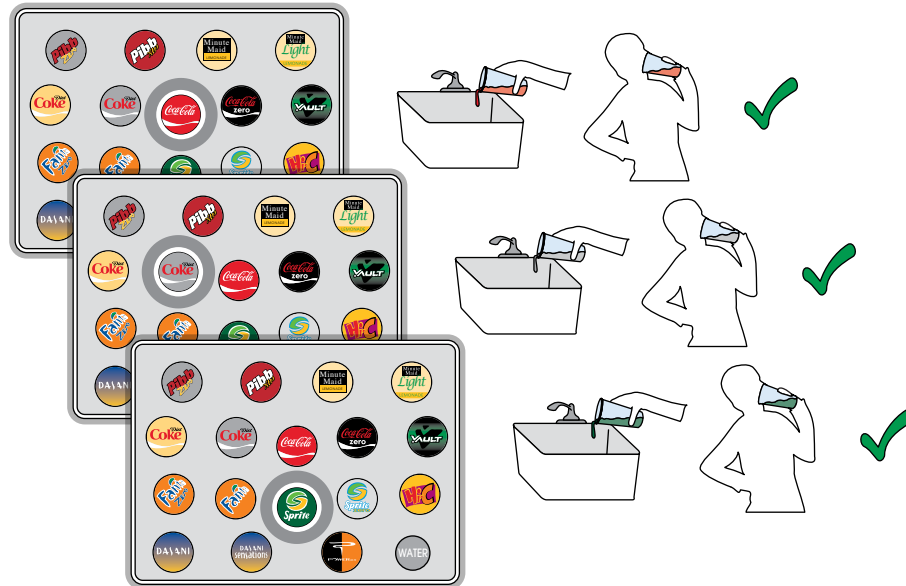

If the soft drink is warm, flat or has an off-taste or odor, refer to “Troubleshooting” on page 25 of this guide for assistance.

Troubleshooting



Check Ice Level



CAUTION:
If there is an ice maker on top of the Coca-Cola Freestyle dispenser, follow established procedures for checking the ice level.



1

Stand on a step stool to reach, lift and remove ice bin lid.

2

Check to see if ice is in full contact with the cold plate at the bottom of the ice bin, and the ice bin is *at least* 1/3 full.

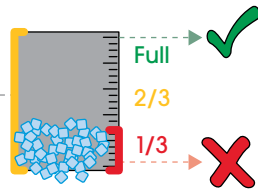

Refill Ice

1

Fill a bucket with ice.

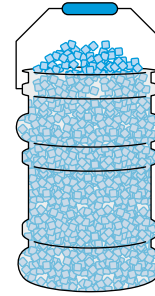

CAUTION:
Follow store safety procedures when lifting anything heavy, like ice.



CAUTION:
Large chunks can damage the Coca-Cola Freestyle dispenser.



2

Stand on a step stool to reach, lift and remove ice bin lid.

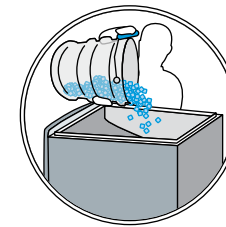

3

Pour ice into ice bin; repeat as needed to fill bin.



4

Replace ice bin lid.

1 Touch the Coca-Cola brand image on the screen.

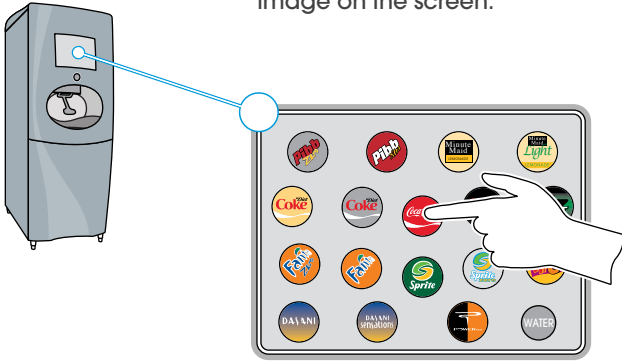

2 Touch the three (3) areas of the Coca-Cola image in the order shown to access "Crew Mode" on the touch screen.

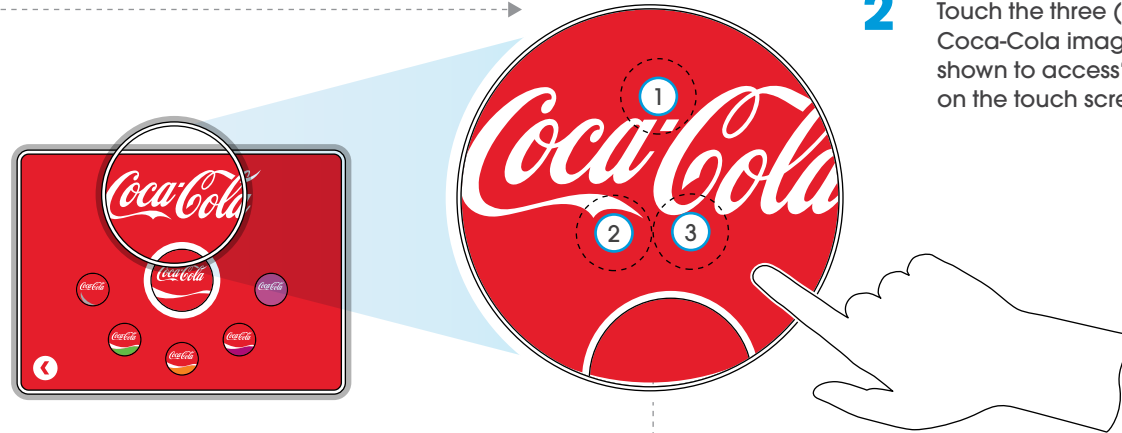

3 Check cartridge gauge levels.

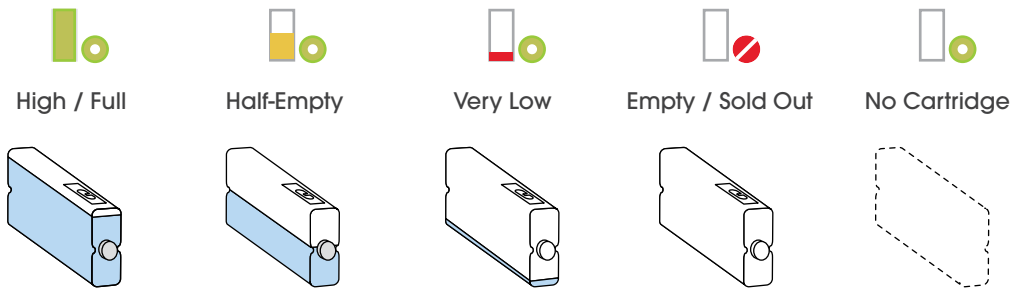

DAILY TASKS | CHANGE A CARTRIDGE

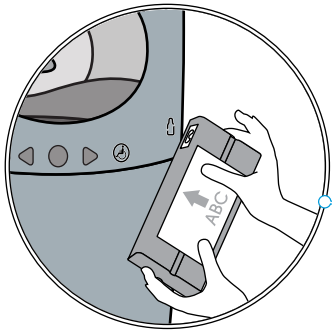

- 1** Scan cartridge with RFID tag facing the RFID reader on the upper door.

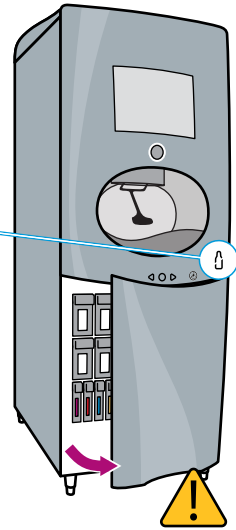

CAUTION:
Lower door will release open.

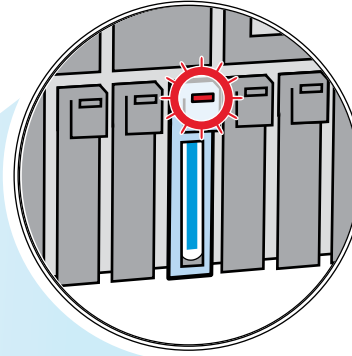
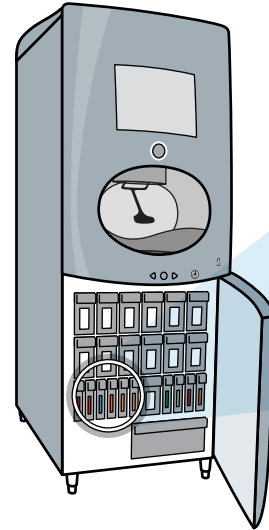

- 2** Find cartridge to change.
All empty cartridges are red; the one just scanned will flash red for 10 seconds.

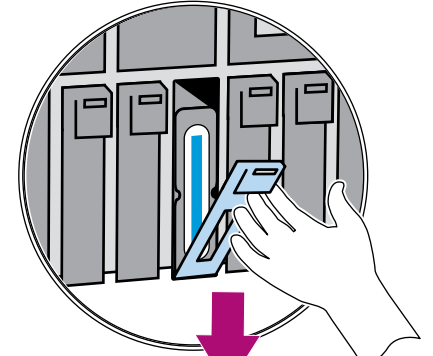

- 3** Open cartridge slot door (door pulls down).

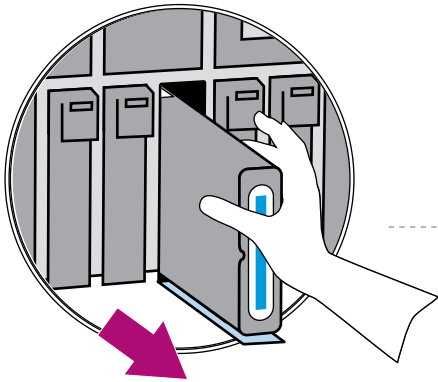

- 4** Empty cartridge will come out partially.
Remove the cartridge.



- 5** Use an approved sanitizer solution and a clean cloth to clean the overflow area.

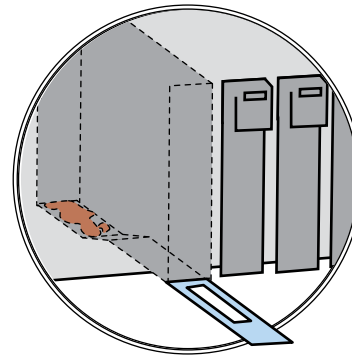

- 6** Inspect the cartridge overflow area for any excess drips or fluid.

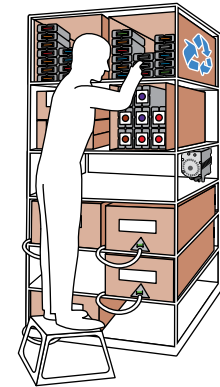

- 7** Place the empty cartridges in a storage box.
Empty cartridges will be picked up by a courier each week and returned to Coca-Cola for recycling.

8 Remove cap from new cartridge.

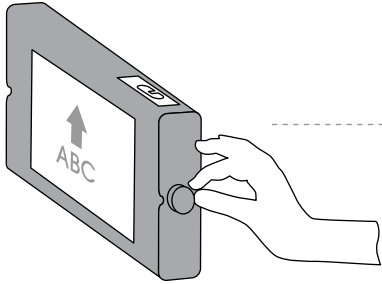

9 Remove paper seal from the new cartridge by grabbing the tab and peeling back.

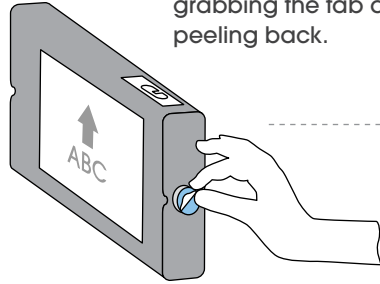

10 Insert cartridge in the slot with the RFID tag facing in. The label on the side of the cartridge should be facing up. Gently push the cartridge until the slot door is engaged.

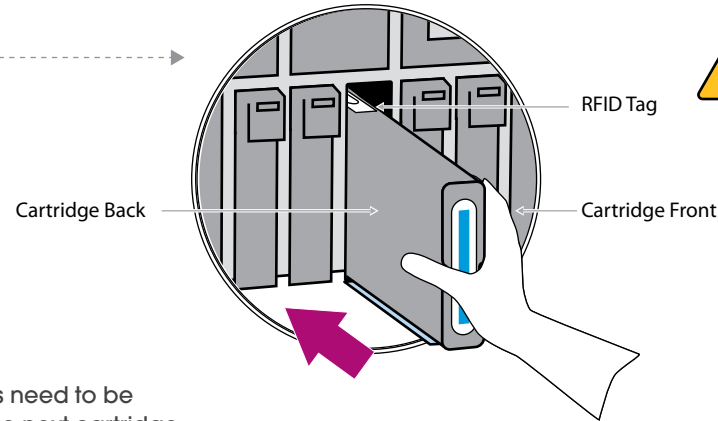

CAUTION: Do not force or push the cartridge once the slot door is engaged.

11 Close the slot door to push the cartridge in the rest of the way. The light on the slot will turn solid green if installed correctly.

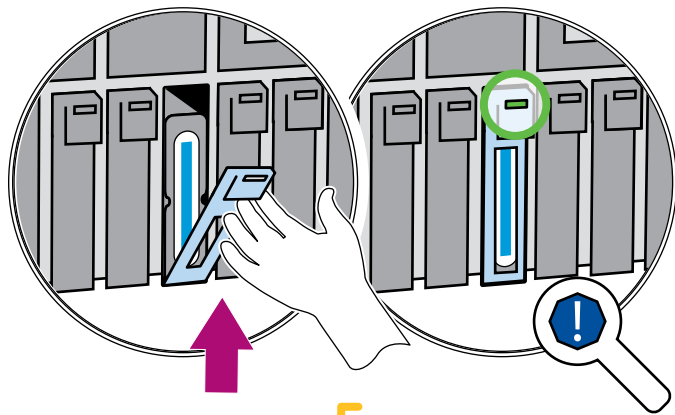

CAUTION: If the light does not turn solid green, refer to page 24 in the "Troubleshooting" section for additional information.

12 If more cartridges need to be replaced, scan the next cartridge over the RFID reader. The slot for the scanned cartridge will blink.

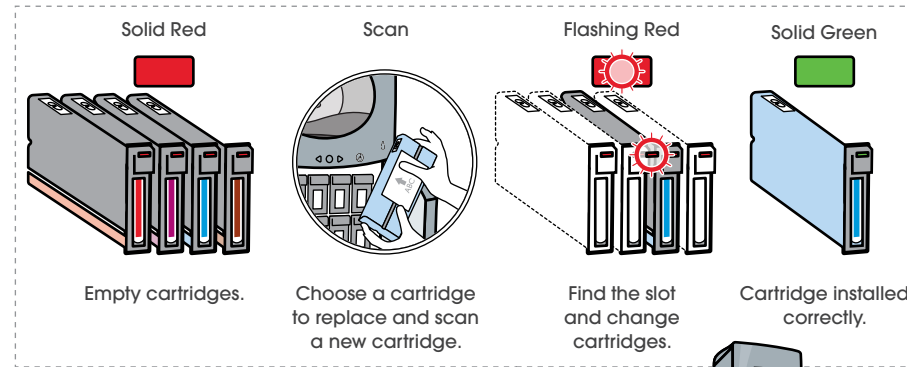

Close the lower door when finished.



13 If the contents of a cartridge get on your hands, wash them right away to prevent staining. If the contents of a cartridge spill on the floor or inside of the Coca-Cola Freestyle dispenser, clean the areas right away.



Check HFCS 65

- 1 Lift the HFCS 65 box to see how much product is left.

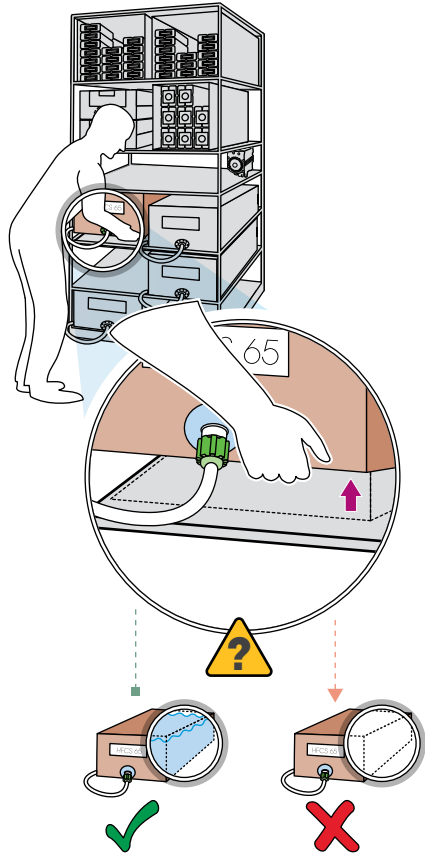

Change HFCS 65

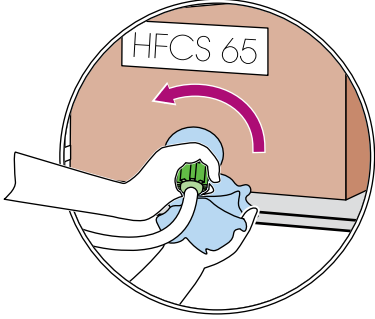
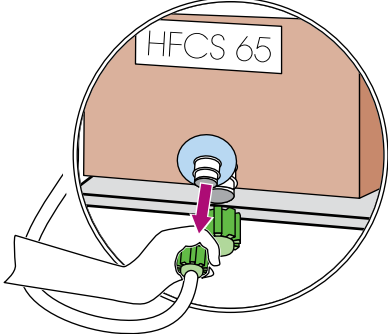
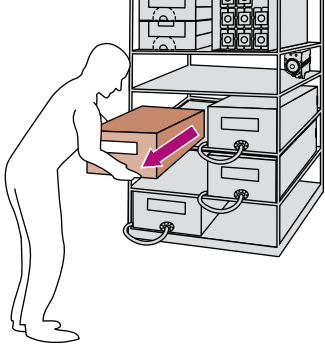
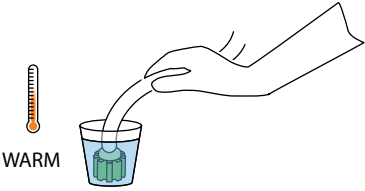
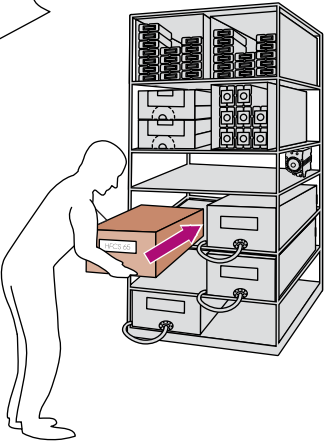
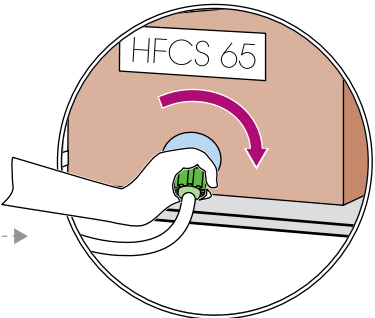
- 1 Hold a cloth beneath the connector to catch any spills. Turn connector counter-clockwise to loosen.
 
- 2 Remove connector from the HFCS 65 box.
 
- 3 Remove the empty HFCS 65 box from the rack.
 
- 4 Rinse the connector in a cup of warm water.
 
- 5 Place new box of HFCS 65 on rack.
 
- 6 Attach the connector to the fitment and turn clockwise to tighten.
 

Open the box and pull out the fitment.

CAUTION: Do not use sharp objects to open the box.



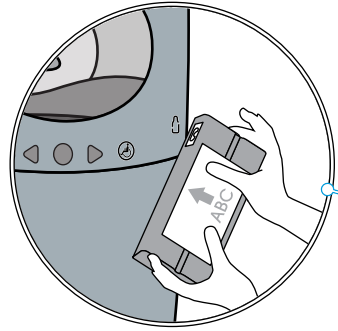

1 Open the lower door by scanning a cartridge or a Manager Key Card over the RFID reader.

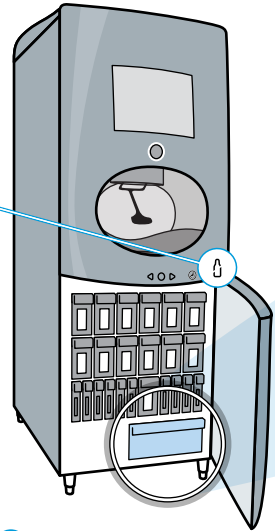

2 Locate NNS compartment.

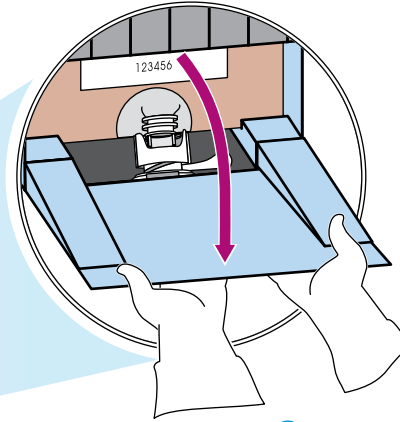

3 Pull down front door of NNS compartment, side tray out.

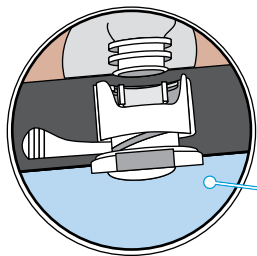
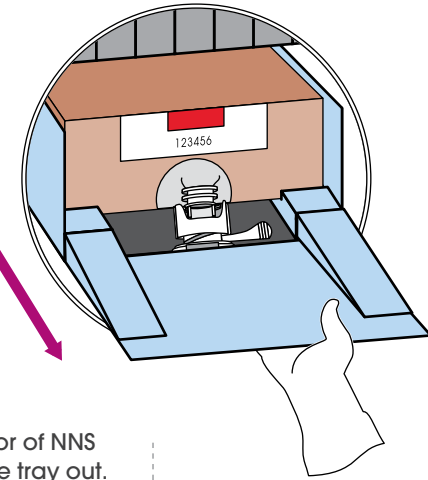

4 Release lever from right to left.

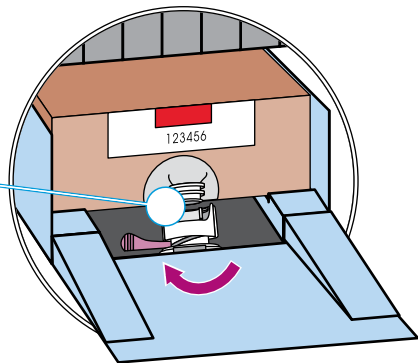

5 Lift NNS box and feel bag inside to determine product level.

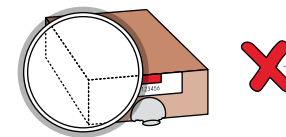
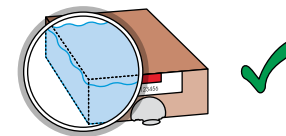
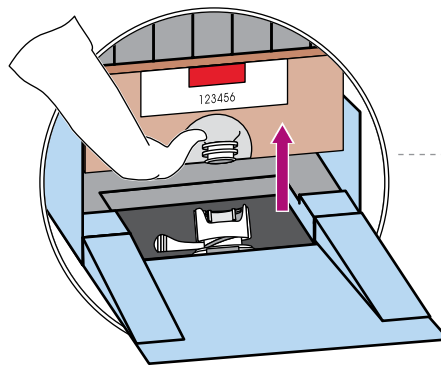

1 Open the lower door by scanning a cartridge or a Manager Key Card over the RFID reader.

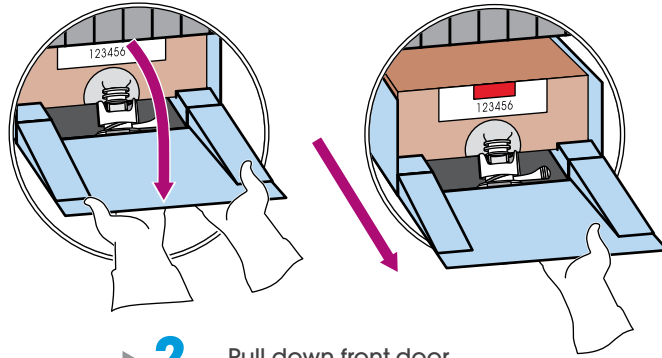
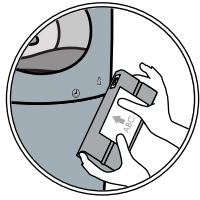

2 Pull down front door of NNS compartment, slide tray out.

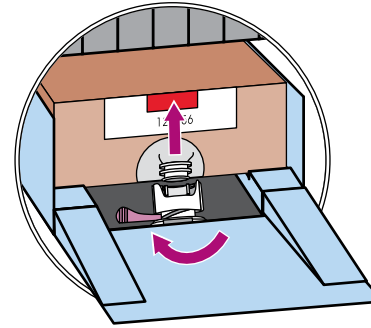

3 Release lever from right to left.

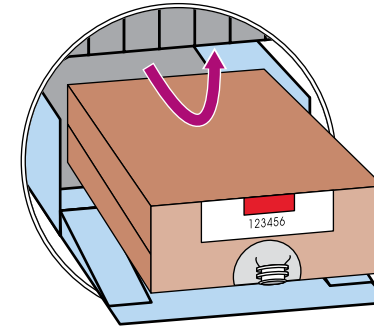

4 Remove empty NNS package.

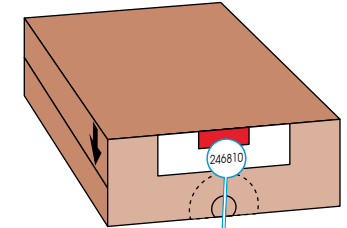

5 If prompted on the touch screen, enter the six digit code from the top of the new NNS box.

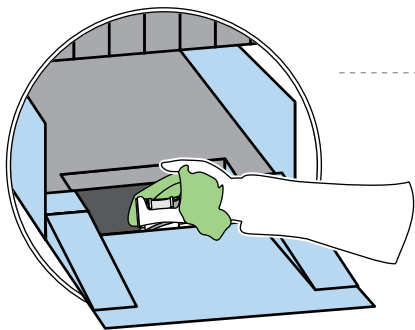

7 Use an approved sanitizer solution and a clean cloth to clean the connector area on the compartment door.

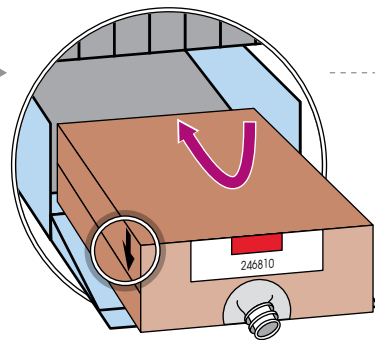

8 Remove cap from the new NNS package. Place box in the compartment with the arrows on the package facing **down**.

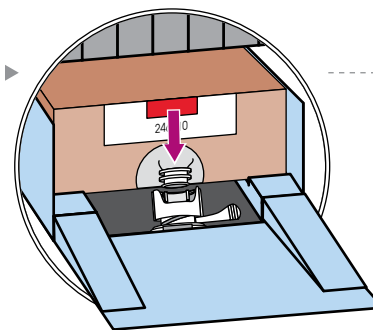

9 Attach the NNS connector into the fitting.

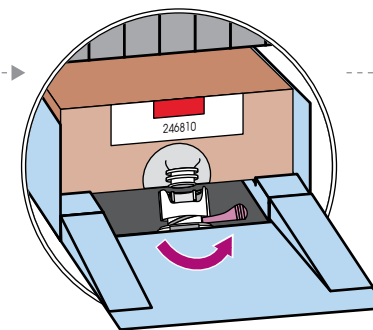

10 Move lever from the left to the right to secure.

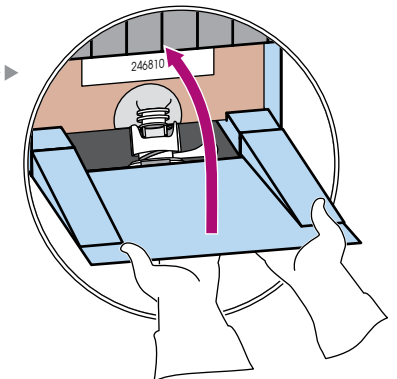

11 Slide the tray back into the compartment. Lift up the door to close. Close the lower door when finished.

Prepare a 100ppm chlorine sanitizer solution for daily cleaning tasks.

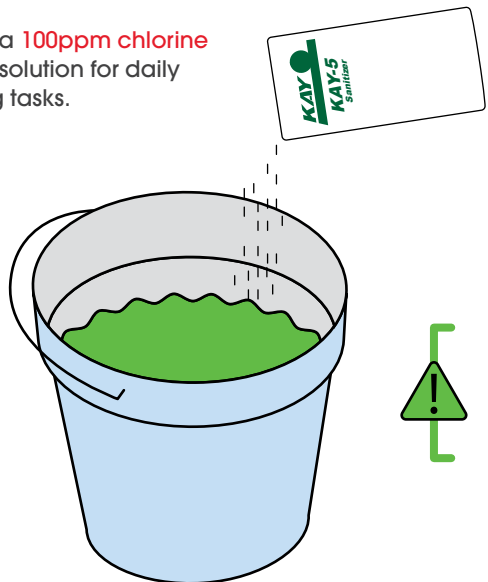

TIP: Kay-5 Sanitizer, cleaning brush and replacement nozzle can be ordered by calling **1-888-538-2653**.



Coca-Cola recommends Kay-5® Sanitizer, or a comparable food-grade chlorine sanitizer.

If using Kay-5 brand, add 1 oz. packets of Kay-5 to 2.5 gallons of clean warm water in a clean, 5-gallon bucket.



CAUTION: When using a chlorinated detergent other than Kay-5, follow the instructions to produce a 100ppm chlorine sanitizer solution.



CAUTION:

DO NOT use bleach, dish detergent, or any unapproved chemicals!



DO NOT soak any parts overnight.



DO NOT use scouring pads, steel wool or any abrasive material. It will scratch the surface and result in rusting/pitting.



DO NOT use paper towels. They may break apart and clog the drain.



DO NOT pour hot liquids (>125°F-51.6°C) into the drain.



HOT



DAILY TASKS | CLEAN NOZZLE

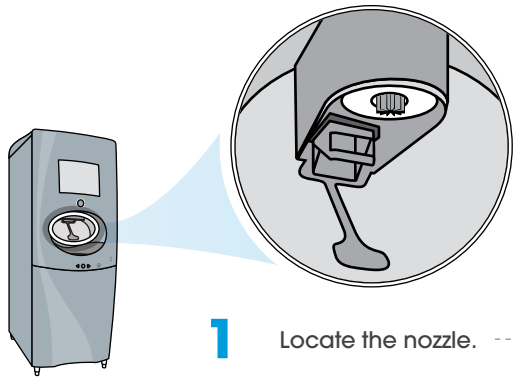

1 Locate the nozzle.

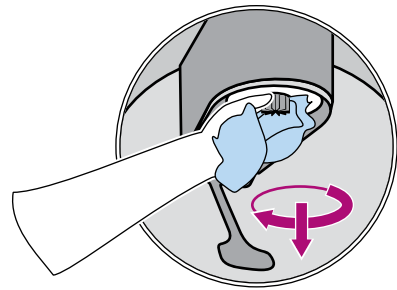

2 Using a cloth to protect fingers, twist nozzle counter-clockwise, and then pull down to remove.

3 Place the nozzle in a clean sink and rinse with warm, drinkable water.

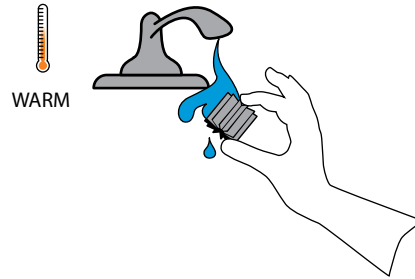

4 Place the nozzle in the prepared sanitizer solution.

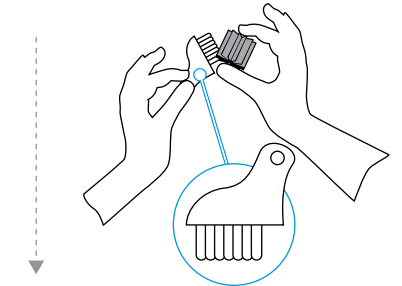
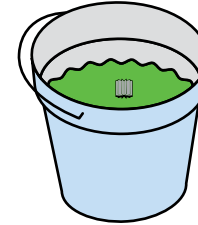

5 Scrub the nozzle using the brush shown.

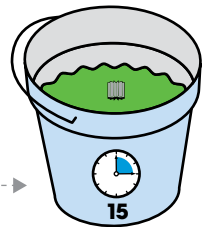

6 Soak the nozzle in the sanitizer solution for 15 minutes.



CAUTION:
DO NOT soak
nozzle overnight.

7 Use a clean brush or cloth and the rest of the sanitizer solution to wipe underneath the valve where the nozzle connects (A), as well as the chrome cover (B) of the nozzle area.

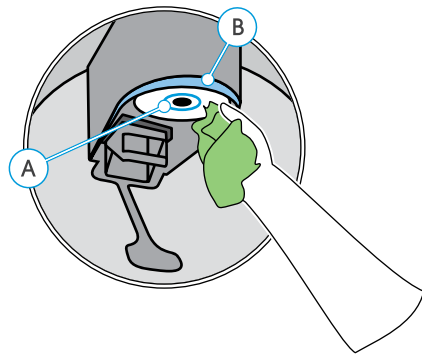

8 Allow the nozzle to air dry. Use a cloth to put the nozzle back in place, and then turn clockwise to lock.

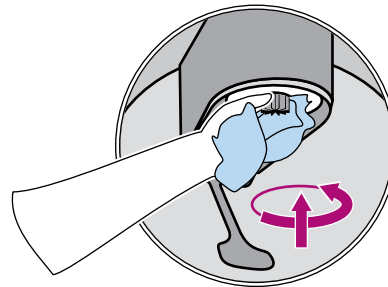

9 Conduct a taste test by following the steps outlined on the "Conduct a Taste Test" page 8.

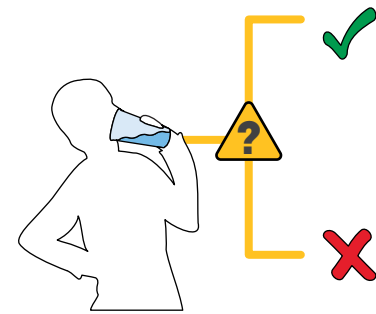

If drink taste is satisfactory, the nozzle cleaning task is complete.

If an off-taste is noted, refer to "Troubleshooting" on pages 25-26 of this guide for assistance.

Troubleshooting



DAILY TASKS | CLEAN ICE LEVER, CUP REST, DRIP TRAY AND EXTERIOR SURFACES

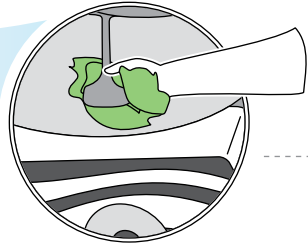

1 Using a clean cloth and approved sanitizer solution, wash the ice lever and allow solution to run down the drain.

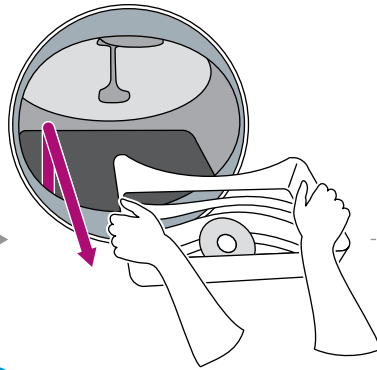

2 Remove the cup rest.

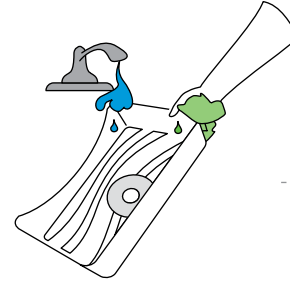

3 Wash the cup rest in a sink using an approved sanitizing solution.



4 Wash the drip tray using a clean cloth and an approved sanitizing solution. Rinse and allow sanitizing solution to run down the drain.

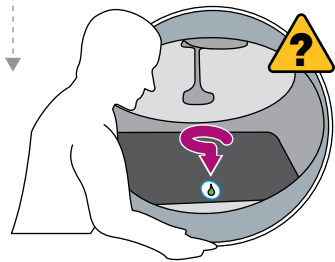

5 Ensure the drain empties properly.

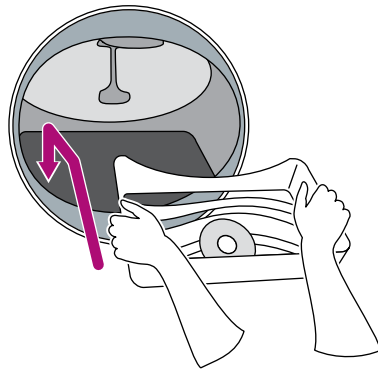

6 Replace the cup rest in the drip tray.

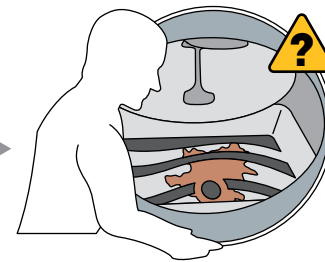

7 Check the cup rest periodically throughout the day and clean as needed.

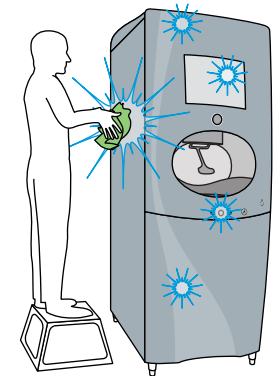

8 Using a clean cloth and approved sanitizer solution, wipe all exterior surfaces, including upper and lower cabinet doors, touch screen, and ADA interface area.

WEEKLY TASKS | CLEAN NNS COMPARTMENT AND CONNECTOR

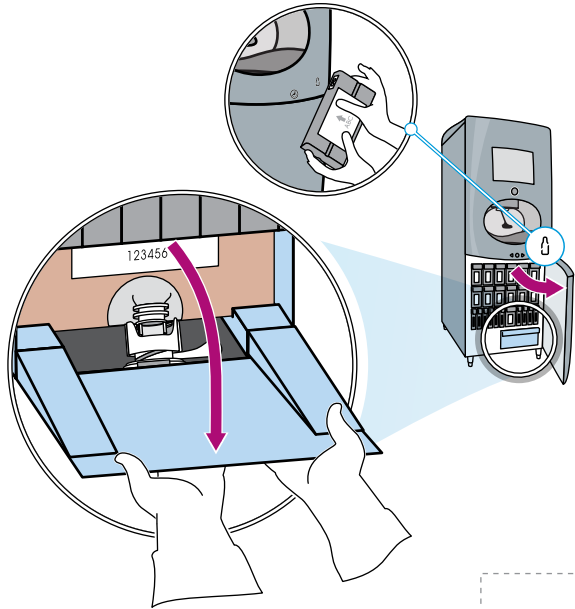

1 This cleaning task should be completed on a weekly basis.

This task should also be done whenever you notice crystals forming on the NNS connector.

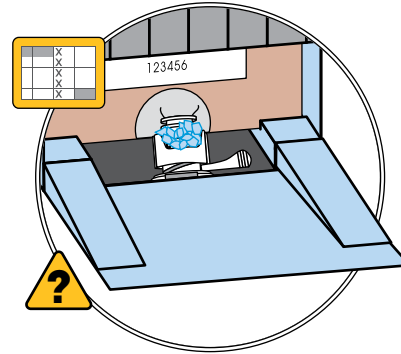

2 Remove the NNS box from compartment.
Refer to "Change Non Nutritive Sweetener Blend (NNS)" on page 19 for instructions.

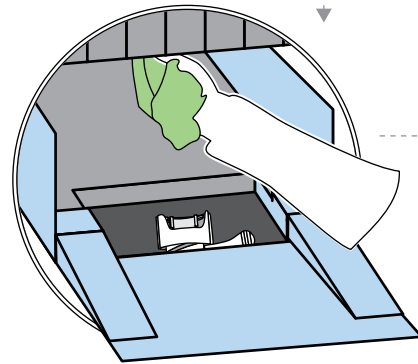
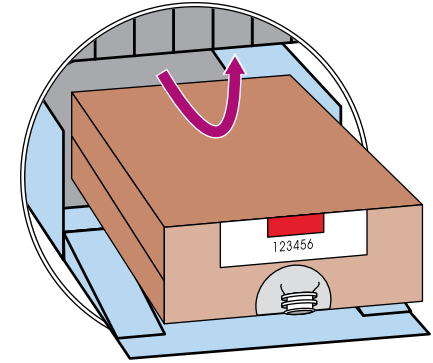

3 Use a clean cloth and sanitizer solution to clean the NNS compartment.

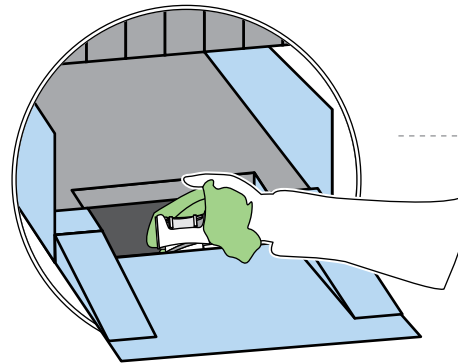

4 Use a clean cloth and sanitizer solution to clean the NNS connector.

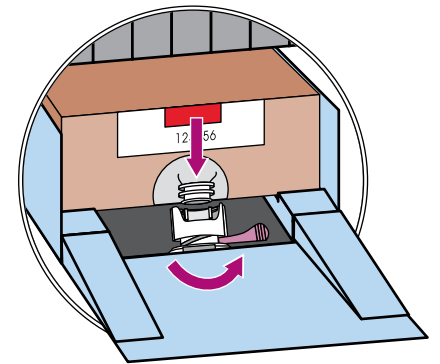
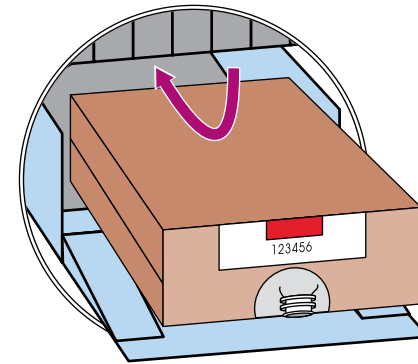

5 Return the NNS box to the compartment and reconnect it.
Refer to "Change Non Nutritive Sweetener Blend (NNS)" on page 15 for instructions.

WEEKLY TASKS | CLEAN ICE CHUTE



CAUTION:

If there is an ice maker on top of the Coca-Cola Freestyle dispenser, follow established procedures for cleaning the ice bin.

1

Turn off power to the dispenser.

Refer to "Power the Dispenser On/Off" on page 5 for instructions.

Unplug the unit.

To make sure that no mechanical parts move during cleaning.

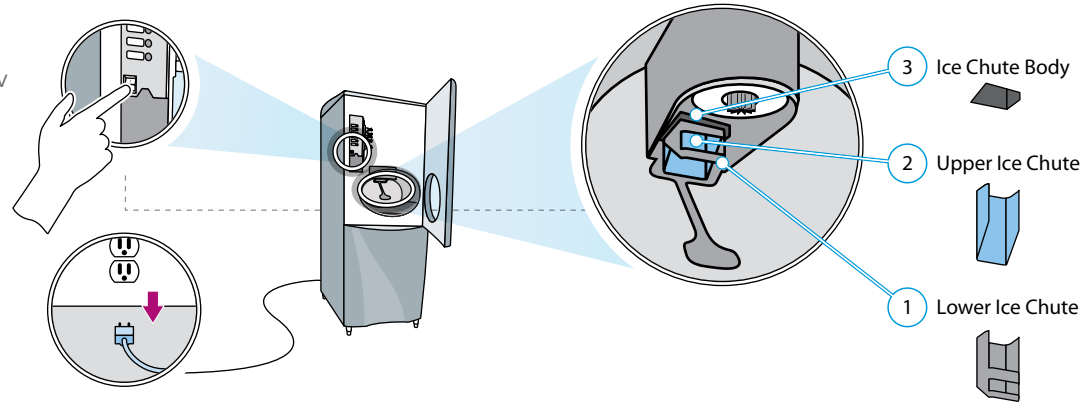

2

Remove the lower chute by carefully pulling on the front lip of the lower chute. It should disengage and pull forward.

3

Remove the upper chute by carefully pulling on the upper lip of the upper chute. It should disengage and pull forward.

4

Wash upper and lower chute with sanitizing solution.



5

Use a clean, sanitized towel or cloth to wipe the ice chute body area.

6

Reinstall the upper ice chute by pushing up and into the ice chute body until a **click** sound is made.

7

Reinstall the lower ice chute by pushing up and into the bottom of the upper ice chute until a **click** sound is made.

8

Plug the unit back in to the electrical outlet.

Turn on power to the dispenser.

Test to ensure the dispenser is operating properly.

Refer to "Power the Dispenser On/Off" on page 5 for instructions.

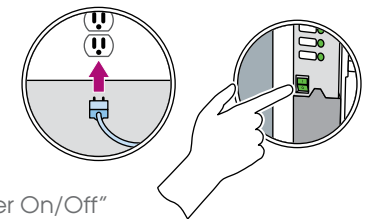

CAUTION:

DO NOT use paper towels. They may break apart and clog the ice bin.

1 Remove the ice bin lid.

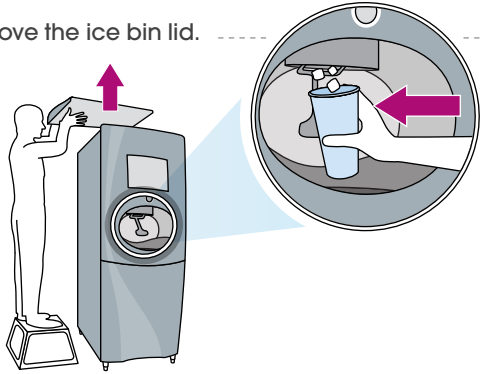

2 Empty the ice bin by pressing the ice lever and dispensing ice out the chute until the ice bin is empty.

It is recommended that this task be completed when the ice level is already low, so there isn't much in the bin to empty out.



CAUTION: If there is an ice maker on top of the Coca-Cola Freestyle dispenser, follow established procedures for cleaning the ice bin.

3

Turn off power to the dispenser.

Refer to "Power the Dispenser On/Off" on page 5 for instructions.

Unplug the unit.

To make sure that no mechanical parts move during cleaning.

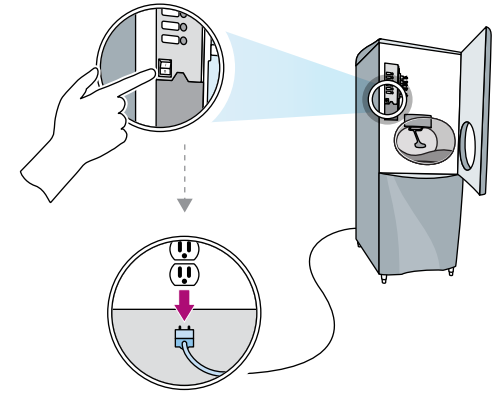

4 Rinse the inside of the ice bin with warm water until all ice pieces are gone.

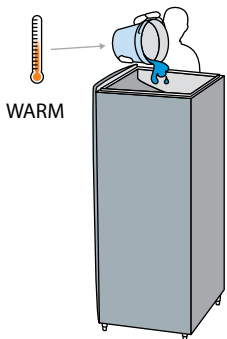

5

Soak a clean cloth or towel in warm sanitizer solution and then wipe the insides of the ice bin.



CAUTION: **DO NOT use paper towels.** They may break apart and clog the ice bin.

6

Rinse the ice bin thoroughly with clean water.

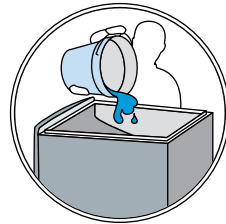

7

Allow the ice bin to air dry before refilling with ice.

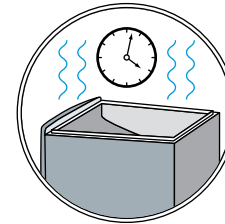

8

Refill the unit with ice.

Refer to "Check and Refill Ice" on page 9 for instructions.

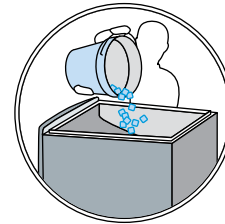

9

Replace the ice bin lid.

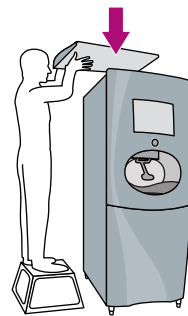

10

Plug the unit back in to the electrical outlet.

Turn on power to the dispenser.

Refer to "Power the Dispenser On/Off" on page 5 for instructions.

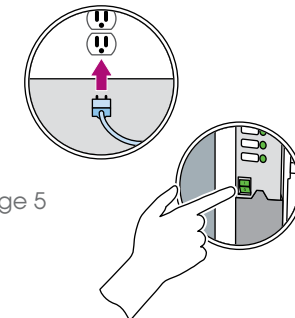

Managers can lock the Coca-Cola Freestyle dispenser to prevent drinks from being poured without having to manually power off the unit.



NOTE:
If you have lost the Manager Password provided during installation, please call **1-888-538-2653** for assistance.

1 Touch the Coca-Cola brand image on the screen.

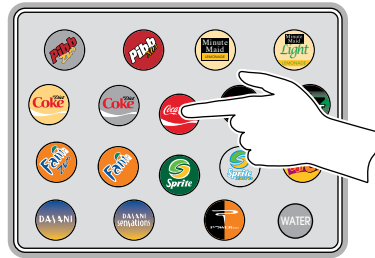

2 Touch the three (3) areas of the Coca-Cola image in the order shown to access "Crew Mode" on the touch screen.

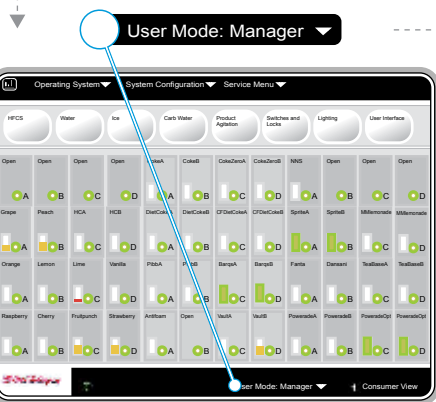
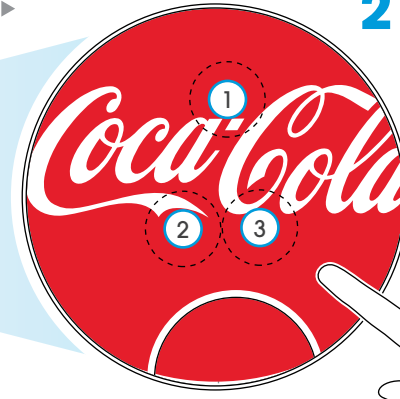

3 Touch the **Current Mode** area at the bottom of the screen and select **Manager Mode**.

***** Enter

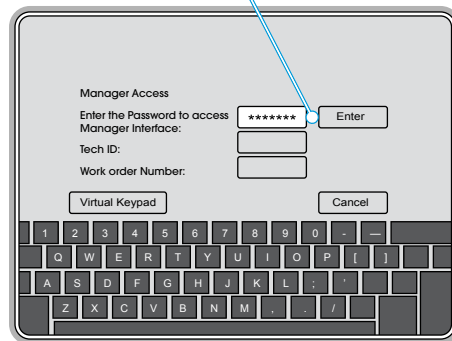

4 Using the Virtual Keypad, enter the Manager password provided for your location, and then press **Enter**.

Service Menu
Lock Dispenser

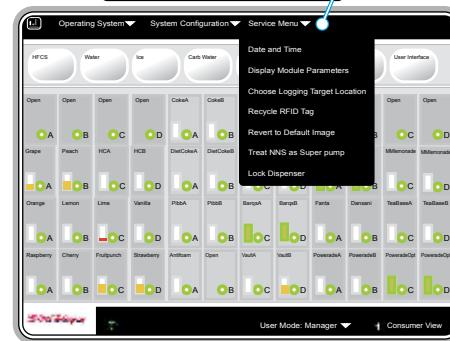

5 Touch **Service Menu**, then select **Lock Dispenser**.

The dispenser will remain locked until unlocked by a manager.

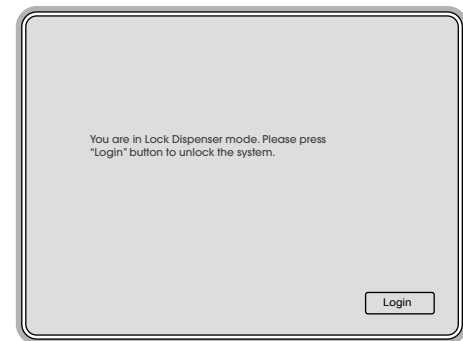

NOTE:
If the screen is touched during Lock Dispenser mode, a warning will appear.



NOTE:
If the screen is touched during Lock Dispenser mode, a warning will appear.

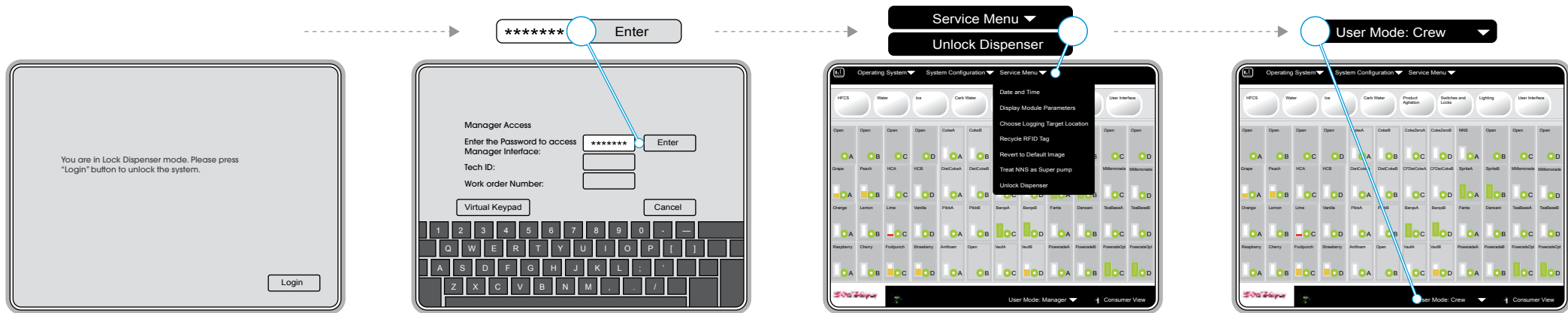

1 Touch **Login**.

2 Using the Virtual Keypad, enter the Manager password provided for your location, and then press **Enter**.

3 Touch **Service Menu**, then select **Unlock Dispenser**.

4 To return to Crew Mode, touch **Manager Mode** and select **Crew Mode** from the menu.

TROUBLESHOOTING



If you have a problem with the Coca-Cola Freestyle dispenser, first use the troubleshooting steps in this guide to try to fix the problem. If you are unable to fix the problem yourself, call **1-888-538-2653** for assistance.

Please note any error codes displayed on the dispenser and have your store phone number and address available when you call.

Accessing the Crew Interface

Enter **Crew Mode** to check cartridge levels by touching the "triangle" on the Coke screen.

Refer to "Check Cartridge Level" on page 10 for instructions.

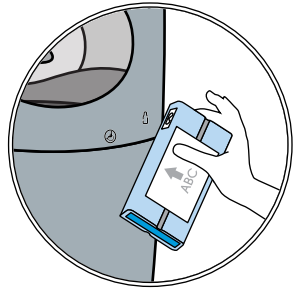
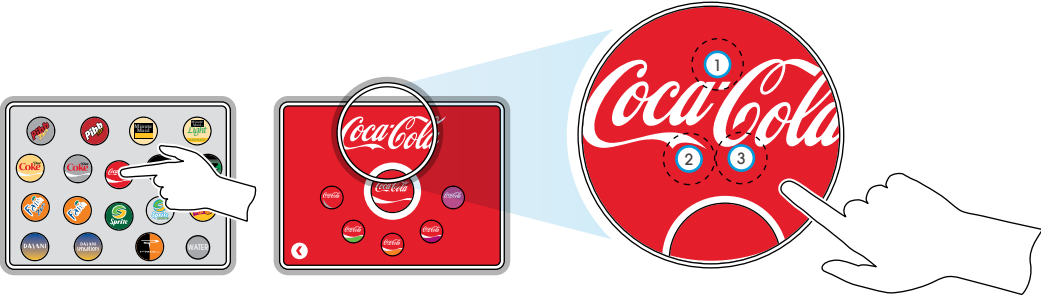

Status Lights

The status lights on each of the cartridge slots in the dispenser cabinet illuminate and flash or remain solid to indicate different information

The lower dispenser door must be opened to view the status lights. You may need to refer to this chart when changing cartridges.

<p>Solid Red</p>	<p>Flashing Red</p>	<p>Solid Green</p>	<p>Alternating Red/Green (along with beep and on-screen message)</p>	<p>Off</p>
<p>Cartridge in the slot is empty, but it is not the cartridge that was just scanned.</p>	<p>The slot associated with the cartridge that was just scanned.</p>	<p>Cartridge installed correctly.</p>	<p>An incorrect cartridge has been inserted in the slot.</p>	<p>No tag is being read by the RFID reader.</p>
				<p>Possible causes for this would include:</p> <ul style="list-style-type: none"> No RFID tag on the cartridge. A damaged RFID tag on the cartridge. A damaged RFID Reader.

“Sold Out” Indicators on Touch Screen

A brand is sold out when it appears “gray” on the screen.

The Coca-Cola brand is sold out in the examples shown here.

Refer to “Change a Cartridge” on page 11 for instructions on replacing cartridges.



Warm Drinks

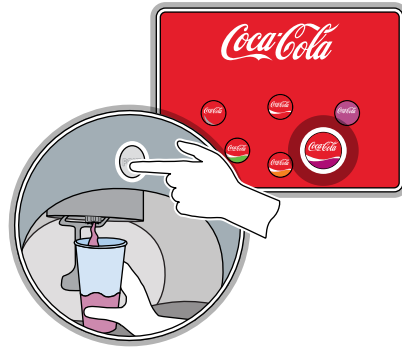

1 Dispense any flavor drink without ice and discard.

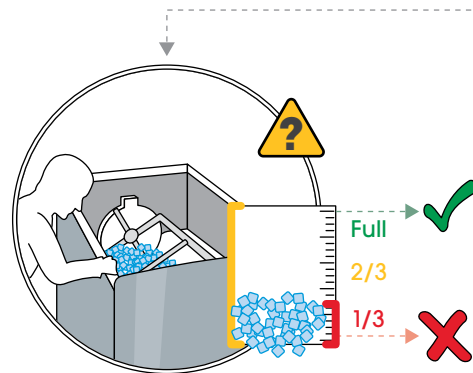

4 Make sure the ice bin is at least 1/3 full and that ice is in contact with the cold plate at the bottom of the ice bin.

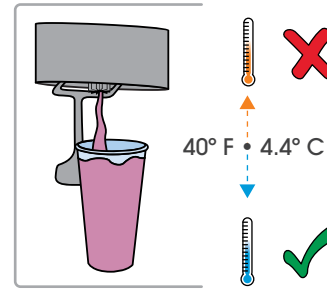

2 Dispense the same drink again without ice and check the beverage temperature with a digital thermometer. The temperature of the soft drink should be less than 40° Fahrenheit/4.4° Celsius.

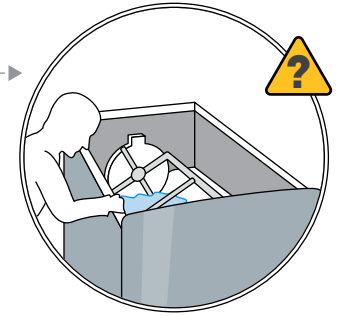

3 Open the ice bin and look for melted ice. Drain any standing water.

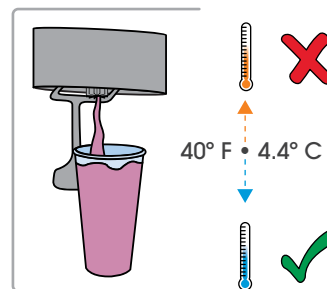

5 Dispense the same drink again without ice and check the beverage temperature with a digital thermometer. The temperature of the soft drink should be less than 40° Fahrenheit/4.4° Celsius.

If the problem persists, call 1-888-538-2653 for assistance.

Please note any error codes displayed on the dispenser, and have your store phone number and address available when you call.

Foamy Drinks

- 1 Check beverage temperature as outlined in "Troubleshooting, Warm Drinks" on page 25.

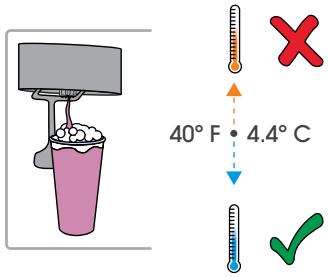

- 2 Wait 20 minutes.



- 3 Check beverage temperature again.

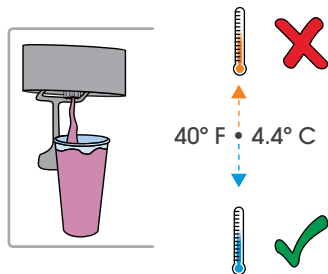

Flat Drinks

- 1 Check beverage temperature as outlined in "Troubleshooting, Warm Drinks" on page 25.

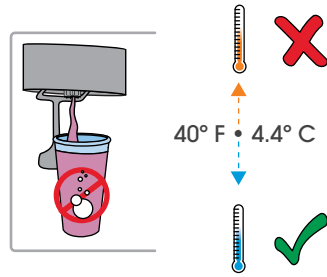

- 2 Check CO2 pressure to ensure it reads 75 PSI.

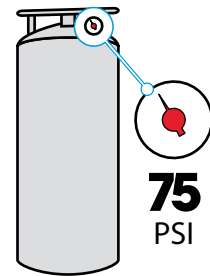

No Ice Dispensing

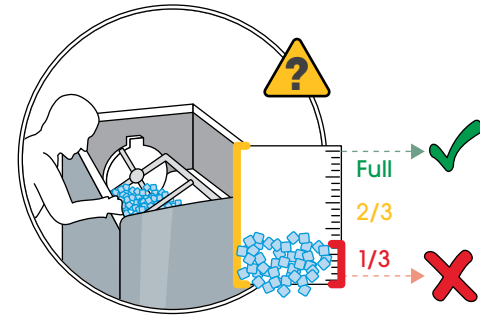

- 1 Check ice bin for ice, and refill if necessary.

Refer to "Check and Refill Ice" on page 9 for instructions.

If the problem persists, call 1-888-538-2653 for assistance.



Please note any error codes displayed on the dispenser, and have your store phone number and address available when you call.

Other Problems

- 4 If you experience problems that are either not described in this guide, or cannot be resolved with basic troubleshooting, call **1-888-538-2653** for assistance.

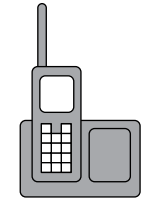

Please note any error codes displayed on the dispenser, and have your store phone number and address available when you call.

FREQUENTLY ASKED QUESTIONS (FAQ'S)



GENERAL QUESTIONS

Q. What is the Coca-Cola Freestyle dispenser?

A. The Coca-Cola Freestyle dispenser is the first in a family of new dispensers that uses micro-dosing technology to offer more than 100 sparkling and still beverage brands from a single freestanding unit. The new unit has approximately the same footprint as today's six-or eight-valve dispensers.

Q. How does the Coca-Cola Freestyle dispenser work?

A. It creates branded beverages by creating a precise recipe of concentrated ingredients with water and sweetener. The proprietary micro-dosing nozzle blends the beverage at the point where it is dispensed.

Q. What is the drink quality of the Coca-Cola Freestyle dispenser?

A. Because the beverage components are stored separately until the moment of dispensing, each drink poured is fresh tasting and aromatic. The micro-dosing and nozzle technologies enable the Coca-Cola Freestyle dispenser to recreate specific brand formulas, so the consumer essentially receives a drink that is made to order.

Q. How is the Coca-Cola Freestyle dispenser different from today's fountain dispenser?

A. It does not use syrup. Rather, the Coca-Cola Freestyle dispenser mixes concentrated flavors with sweetener and water at the nozzle to make beverages. Ingredients are stored in the dispenser cabinet itself.

Q. What is micro-dosing?

A. Micro-dosing is a technology used to pump and meter fluids with a high degree of accuracy. It is commonly used in medical applications.

Q. How was the Coca-Cola Freestyle dispenser designed?

A. The equipment was thoughtfully designed from the inside out, taking into consideration the interaction experiences of the consumer, customer and technician. The goal was to communicate the heritage of the Company as the original fountain beverage company, while also exceeding consumer expectations in an increasingly digital world.



QUESTIONS CREW MEMBERS MAY HAVE

Q. Can I put a Coke cartridge in another slot if I am out of the other flavor?

A. No. Each slot is dedicated to a particular drink ingredient, flavor or sweetener. If you do place the incorrect cartridge in a slot, the RFID reader will not recognize the cartridge. This ensures there is no cross-contamination in the tubing, and protects consumers who may have an allergy to a particular ingredient.

Q. I need to order cartridges. What is the ordering process?

A. Cartridges can be ordered quickly and easily on the Coca-Cola Smart™ website, which is: <http://cokesmart.coke.com>.

You will need to register for an account before you can login and place your first order. The registration process is described in the Coca-Cola Smart Start guide that was sent to you prior to installation.



QUESTIONS CONSUMERS MAY HAVE

Q. How many Coca-Cola brands and flavor options are available on the Coca-Cola Freestyle dispenser?

A. 100+ sparkling and still brands can be served from the Coca-Cola Freestyle dispenser. Freestyle offers a wide range of categories, including diet and light sparkling beverages, flavored waters, sports drinks, lemonades, and the complete Coca-Cola trademark family - Coca-Cola, Diet Coke, Coke Zero and Caffeine Free Diet Coke.

Q. Are all of these brands available in supermarkets or other retail locations?

A. Many of these offerings are available at retail, but some have been created for this new dispenser only. If you are curious about which brands are available at retail, send us an e-mail at https://secure.thecocacola.com/ssldocs/mail/eQuery_other.shtml.

Q. What if I want something I don't see here?

A. You can provide feedback to The Coca-Cola Company by going to www.CokeFeedback.com.

Regulatory Compliance:

FCC Class A Warning

NOTE: This equipment has been tested and found to comply with the limits for a Class A digital device, pursuant to Part 15 of the FCC rules. These limits are designed to provide reasonable protection against harmful interference when the equipment is operated in a commercial environment. This equipment generates, uses and can radiate radio frequency energy and, if not installed and used in accordance with the instruction manual, may cause harmful interference to radio communications. Operation of this equipment in a residential area is likely to cause harmful interference in which case the user will be required to correct the interference at his own expense.

FCC Notice (for U.S. Customers):

This device complies with Part 15 of the FCC Rules:

Operation is subject to the following conditions:

- 1. This device may not cause harmful interference, and*
- 2. This device must accept any interference received, including interference that may cause undesired operation*

*Changes and Modifications not expressly approved by **The Coca-Cola Company** can void your authority to operate this equipment under Federal Communications Commission's rules.*

This device complies with Industry Canada license-exempt RSS standard(s). Operation is subject to the following two conditions: (1) this device may not cause interference, and (2) this device must accept any interference, including interference that may cause undesired operation of the device.