



GARAGE DOOR OPENER MODELS

PowerMax® 1200/1500, SC 1200/1500, TriloG™ 1200/1500, PowerLift® 900, GPower™ 900,
SilentMax® 1000/1200, CB 1000/1200, IntelliG® 1000/1200

SCREW/BELT/CHAIN DRIVES



OPERATION & MAINTENANCE MANUAL

Includes INTELLICODE® Remote Control. Safe-T-Beam® System must be installed to close door.

For use only with residential sectional or one piece overhead garage doors.

Homelink® and Car2U® compatible.



Need help or have questions? DO NOT RETURN to the store. Call us: 800-354-3643

For Answers and Assistance:

1.800.354.3643

or visit www.geniecompany.com

**SAVE THIS MANUAL FOR FUTURE REFERENCE
INSTALLER: LEAVE THIS MANUAL WITH HOMEOWNER**

WARNING

To reduce the risk of injury to persons or damage to property – Use this opener only with a one-piece or sectional door.

Genie, Genie logo, Intellicode, Safe-T-Beam, IntelliG, PowerMax, PowerLift, ChainMax and SilentMax are registered trademarks TriloG and GPower are trademarks of GMI Holdings, Inc., dba The Genie Company
Homelink is a registered trademark of Johnson Controls Technology Company. Car2U is a registered trademark of Lear Corporation. ©The Genie Company 2012, 10/2012

38267501809

Table of Contents

TRANSMITTER COMPLIANCE STATEMENT

Transmitters comply with all United States and Canadian legal requirements as of the date of manufacture. No warranty is made that they comply with all legal requirements of any other jurisdiction. If transmitters are to be used in another country, the importer must determine compliance with any local laws and regulations which may differ from United States and Canadian requirements prior to use.

Los transmisores cumplen con todas las reglamentaciones legales de los Estados Unidos y del Canadá, en la fecha de fabricación. Ninguna garantía se da que cumplan con todas las reglamentaciones legales de ninguna otra jurisdicción. Si los transmisores se van a utilizar en otro país, el importador debe determinar si cumplen con las reglamentaciones y leyes locales que puedan ser diferentes a las reglamentaciones de los Estados Unidos y del Canadá, antes de usar los mismos.

Les émetteurs sont conformes à la réglementation américaine et canadienne à compter de leur date de fabrication. Aucune garantie n'est stipulée indiquant qu'ils sont conformes à toutes les prescriptions juridiques d'autres autorités. Si les émetteurs sont utilisés dans d'autres pays, il incombe à l'importateur d'en déterminer leur conformité aux lois et règles locales pouvant différer de celles des États-Unis et du Canada avant toute utilisation desdits émetteurs.

Sendegeräte entsprechen allen gesetzlichen Bestimmungen in den USA und Kanada zum Zeitpunkt der Herstellung. Wir übernehmen keine Gewährleistung für die Einhaltung aller gesetzlichen Bestimmungen in anderen Ländern. Sollen Sendegeräte in anderen Ländern eingesetzt werden, so muss der Importeur vor dem Gebrauch sicherstellen, dass die Sendegeräte auch solchen lokalen Bestimmungen entsprechen, welche von den Bestimmungen der USA und Kanadas abweichen.

截止于制造日期,传动装置符合美国和加拿大的所有法律要求。不提供传动装置符合任何其他司法地区所有法律要求之担保。如果传动装置需在任何其他国家使用,进口商必须在使用之前确定装置符合与美国和加拿大要求不同之所有地方法规条例。

截止于制造日期,传动装置符合美国和加拿大的所有法律要求。不提供传动装置符合任何其他司法地区所有法律要求之担保。如果传动装置需在任何其他国家使用,进口商必须在使用之前确定装置符合与美国和加拿大要求不同之所有地方法规条例。

截止于制造日期,传动装置符合美国和加拿大的所有法律要求。不提供传动装置符合任何其他司法地区所有法律要求之担保。如果传动装置需在任何其他国家使用,进口商必须在使用之前确定装置符合与美国和加拿大要求不同之所有地方法规条例。



Need help or have questions? Call 800-354-3643. DO NOT RETURN to the store.

1	Safety Information	
	Safety Notifications	3
	Important Safety Instructions.....	3
2	Features	
	Safety	4
	Opener.....	4
	Infrared Protection Function	4
3	Required Programming	
	Introduction.....	5
	Overview of Powerhead Controls.....	5
	Travel Limits	
	Closing Garage Door (DOWN Limits).....	6
	Opening Garage Door (UP Limits).....	7
	Wall Console Overview	8
	Series III Wall Consoles with Black Buttons .	8
	Series II Wall Consoles with White Buttons .	8
	Force and Speed Control.....	9
	Contact Reverse Test	9
	Remotes	10
4	Optional Programming	
	Keypad.....	12
	Clearing Memory for Remotes.....	13
5	One Piece Doors	
	Attaching Door Bracket to Door	14
	Attaching Door Arm to Door Bracket.....	14
6	Maintenance and Adjustments	
	Maintenance Safety.....	15
	Regular Maintenance	15
	Corrective Maintenance.....	16
	Adjustment Guides	17
7	Wiring Diagram	19
8	Troubleshooting	20
9	Warranty	22

SAVE THESE INSTRUCTIONS

READ AND FOLLOW ALL INSTRUCTIONS

1 Safety Information

OVERVIEW OF POTENTIAL HAZARDS READ THIS SAFETY INFORMATION

CONVENTIONS USED IN THESE INSTRUCTIONS

Garage doors are large, heavy objects that move with the help of springs under high tension and electric motors. Since moving objects, springs under tension, and electric motors can cause injuries, your safety and the safety of others depend on you reading the information in this manual. If you have questions or do not understand the information presented, call your nearest trained door system technician or visit our website at www.geniecompany.com

The following safety alert symbol and signal words are used throughout this manual to call attention to and identify different levels of hazard and special instructions.



This is the safety alert symbol. This symbol alerts you to potential hazards that can kill or hurt you and others.

All safety messages will follow the safety alert symbol and the word "DANGER", "WARNING", or "CAUTION".

- **DANGER** indicates an imminently hazardous situation which, if NOT avoided, will result in death or serious injury.
- **WARNING** indicates a potentially hazardous situation which, if NOT avoided, could result in death or serious injury.
- **CAUTION** indicates a potentially hazardous situation which, if NOT avoided, may result in injury or property damage.
- The word **NOTE** is used to indicate important steps to be followed or important considerations.

IMPORTANT SAFETY INSTRUCTIONS

Potential Hazard	Effect	Prevention
	⚠ WARNING Could result in Death or Serious Injury	Keep people clear of opening while door is moving. DO NOT allow children to play with the door opener. DO NOT operate a door that jams or one that has a broken spring.
	⚠ WARNING Could result in Death or Serious Injury	Turn OFF power before removing opener cover. When replacing cover, make sure wires are NOT pinched or near moving parts. Opener must be fully grounded.
	⚠ WARNING Could result in Death or Serious Injury	DO NOT try to remove, install, repair or adjust springs or anything to which door spring parts are fastened, such as, wood blocks, steel brackets, cables or other like items. Installations, repairs and adjustments must be done by a trained door system technician, using proper tools and instructions.

IMPORTANT INSTALLATION INSTRUCTIONS

⚠ WARNING

TO REDUCE THE RISK OF SEVERE INJURY OR DEATH

READ AND FOLLOW ALL SAFETY, INSTALLATION AND OPERATION INSTRUCTIONS. If you have any questions or do not understand an instruction, call The Genie® Company or your local Genie® Factory Authorized Dealer.

- **DO NOT** install operator on an improperly balanced door. An improperly balanced door could cause severe injury. Repairs and adjustments to cables, spring assembly, and other hardware must be made by a trained service person using proper tools and instructions.
- Remove all ropes, and disable all locks connected to the door before installing operator.
- Where possible, install the door opener 7 feet or more above the floor. For products having an emergency release, mount the emergency release within reach, but at least 6 feet above the floor and avoiding contact with vehicles to avoid accidental release.
- **DO NOT** connect the operator to the source of power until instructed to do so.
- Locate the wall console button: A) Within sight of door. B) At a minimum height of 5 feet so small children cannot reach it. C) Away from all moving parts of the door.
- Install the entrapment WARNING label next to the wall button or console, in a prominent location. Install the emergency release tag on, or next to, the emergency release handle.
- The operator must reverse when the door contacts a 1-1/2 inch high object on the floor at the center of the doorway. This is about the size of a 2" x 4" board laid flat.

2

Features

Begin here **ONLY AFTER** completing assembly and installation of the opener. Review the Assembly and Installation poster to ensure all steps have been performed.

Contact your Genie® Professional Dealer for an installation poster, if needed, or call 1-800-35GENIE. You may also visit www.geniecompany.com to download a PDF file.

SAFETY FEATURES

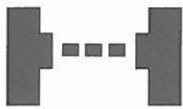

Safe-T-Beam® (STB) Non-Contact Reversing System

Puts an invisible beam across the door opening. The door stops and reverses to the full open position if anything passes through the beam. LED indicator lights on the powerhead and on the STBs provide a self-diagnostic code if an operational problem exists.

Safe-T-Reverse® Contact Reversing System

Automatically stops and reverses a closing door within two seconds of contact with an object.

Automatic ForceGuard™ Control

Automatically sets the force required to fully open and close the door for maximum safety.

Watch Dog™ Monitoring System

Monitors the Safe-T-Beam® system to ensure proper functionality and will automatically stop and reverse a closing door if a problem is detected.



Manual Emergency Release

Manually releases door from door opener. Used during a power failure or other emergency to allow manual opening and closing of door.



SmartSet™ Electronic Programming

Easily adjust the programming to reduce opening speed to a desired rate, vary limits and force, and program new remotes.



Automatic Lighting System

Two bulb lighting system supplies light for safer evening exits and entries. Turns **ON** when door is activated and automatically turns **OFF** 4 minutes later.



Integrated Motion Detection (Not available on all models)

Some units have motion detection built into the powerhead. Lights automatically turn **ON** when motion is detected for much safer movement through the garage. Lights will turn **OFF** after 4 minutes of no motion.

OPENER FEATURES



INTELLICODE® Access Security System

A new generation superior encryption system that enhances the security of the door opener by continuously changing the access code each time the remote is used. The door opener responds to each new code only once. An access code copied from a working system and tried again, will not control the door opener.



Wall Console

Operates door opener from inside garage. The wall console has an indicator light with: Open/Close, Sure-Lock™, and independent light control buttons.



Home Link® and Car2U® compatible. Refer to the programming instructions on page 11.



NOTE: Use this manual **ONLY** after completing assembly and installation of opener. Review Assembly/Installation Instructions poster. Check that all steps have been completed.

Contact your Genie® Professional Dealer for an Assembly/Installation Instructions poster, if needed, or call 1-800-35GENIE. You can also go to www.geniecompany.com to download a printable file.

INFRARED PROTECTION FUNCTION

1. The Safe-T-Beam® has no effect on the door during an opening cycle.
2. If the Safe-T-Beam® detects an obstruction when trying to close the door, it will not allow the door to close.
3. When the garage door is closing, if Safe-T-Beam® is interrupted by a person or obstacle, the garage door will stop its downward travel and reverse automatically to its fully opened position.
4. If the Safe-T-Beam® System fails, loses power, or is installed improperly, press and hold the wall console "open/close" button until the door reaches its fully closed position. If you release the "open/close" button on the wall console during the closing movement, the door will reverse automatically to its fully-opened position.

3

Required Programming

NOTE: Before you begin programming, check to make sure there are no objects in the garage door opening.

INTRODUCTION

Now that your Genie garage door opener is installed, you will want to program the opener so that the door opens and closes properly and all remote devices operate correctly. The following steps guide you through setting your opener so it functions properly for you.

The following information will take you through programming your opener's functional settings for use.

There are only 2 "required" programming processes you will need to follow to set up your garage door opener for operation:

1. "TRAVEL LIMITS"
2. "REMOTE PROGRAMMING"

Term Definitions:

Travel Limits programming allows you to set how far your door travels up or down in opening and closing your garage door.

Remote Programming synchronizes your remote control devices (remotes, wall console, and keypad) with the powerhead.

Force Control refers to how much power is needed to move (open/close) your particular door and does NOT require programming.

Speed Control refers to how fast or slow your opener opens and closes your particular door and is preset at the factory. This function does NOT require programming.

There are 4 programs (The 2 "Factory Set" programs are unlikely to need changes.)

1. Door Travel Limits Program
 - This program is used to set how far your door travels up and down.
2. Remote Programs (Default menu)
 - These show you how to program your remotes to synch with additional remote control devices, wall consoles, keypads, and the powerhead.
3. Door Force Program (Factory Set)
 - This program is only used for minor adjustments under certain circumstances.
4. Door Speed Program (Factory Set)
 - This program does not require manually initiated changes.

NOTE: The 3 programming buttons are for programming ONLY. These buttons should NOT be used to operate the opener once the Required Programming section has been successfully completed.

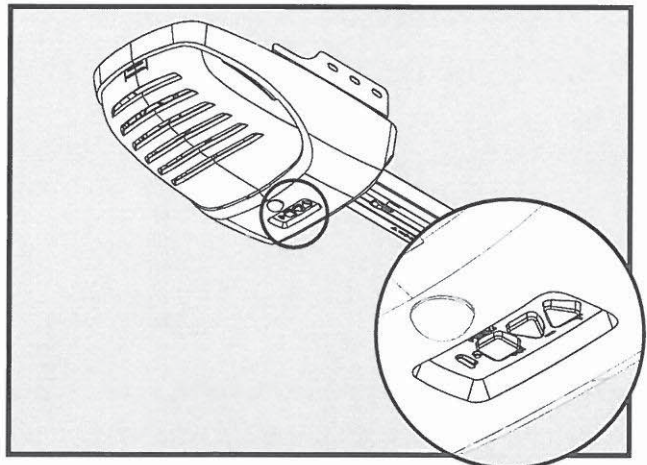



OVERVIEW OF POWERHEAD CONTROLS

This section describes the programming functions on the powerhead of the opener. Use the following information to familiarize yourself with the buttons, LED indicators and products used to program functions.

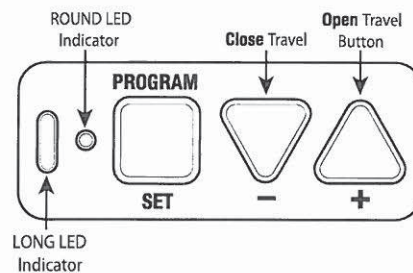
Powerhead: There are 3 programming buttons and 2 LED lights on the powerhead. Each of the buttons is used to enter and complete the setup programming. The LED lights indicate status or a function change by illuminating ON, OFF, or ON FLASHING in one of three different colors: blue, red or purple.



Located on bottom of Powerhead.

-  Enters into and selects programming menus.
-  Multi-function; move door during programming and advance through menus

3

Required Programming

TRAVEL LIMITS

WARNING

- Make sure doorway is in view and clear of obstacles and people to avoid injury or damage to property.
- DO NOT operate this unit from wall console before **LIMITS** are set. Severe damage to the opener can occur.
- The shuttle **MUST** be engaged to carriage **BEFORE** setting limits. See Installation Poster (if provided) or call Customer Service at 1-800-35GENIE or visit www.geniecompany.com

NOTE: If shuttle/bullet has **NOT** been engaged to carriage, do so now. See page 16.

NOTE: Before setting limits confirm wall console red indicator light (or backlight) is ON. If not illuminated, check for correct wiring or the Sure-Lock switch may be activated.

Closing Garage Door (Down Limits)

- 1 Lift the door open by hand until the shuttle/bullet engages the carriage on the rail.

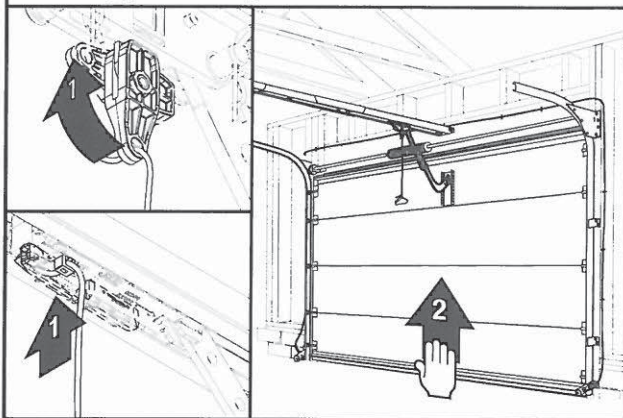

- 2 Press and hold the down arrow button (-) for 2 seconds until the long LED comes on blue (round LED remains off).

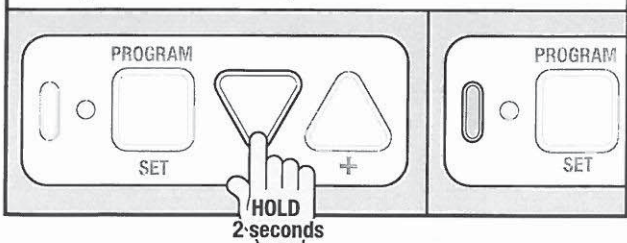

- 3 Release down arrow button (-) and the long LED will begin flashing.

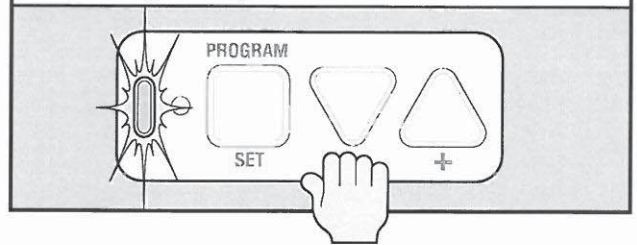

- 4 Press and hold the down arrow button (-) until garage door is fully closed on floor, then release.

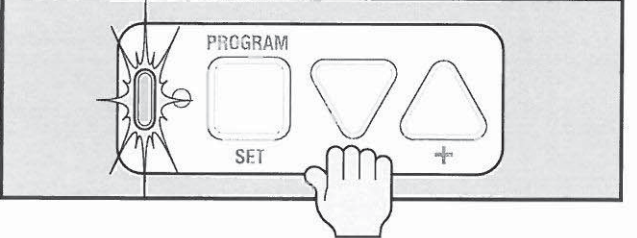
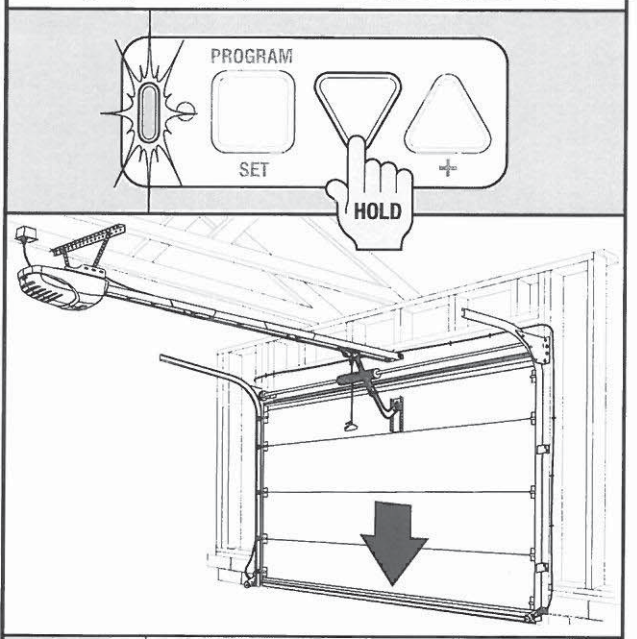

NOTE: You have **30 seconds** to execute each step. If you see **two solid red or flashing LEDs on the Powerhead**, you have run out of time and must go back to the beginning of the step and start over. You can restart as many times as necessary to complete each step.

(continued next page)

3

Required Programming

5 Press and release the Program Set button (both LEDs flash blue and go off).

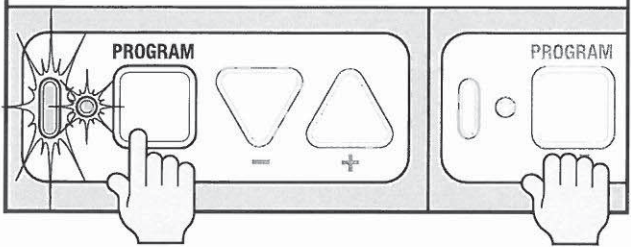

The DOWN (closed) limit is programmed.

Opening Garage Door (Up Limits)

NOTE: Beginning with garage door closed is recommended but not necessary.

6 Press and hold the up arrow button (+) for 2 seconds until the long LED light comes on blue (round LED remains off).

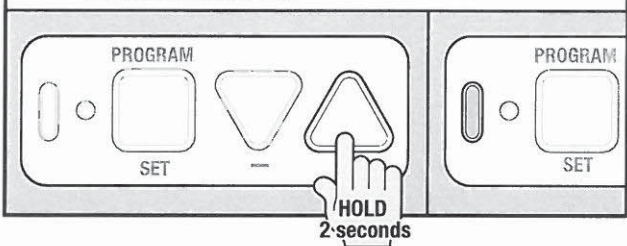

8 Press and hold the up arrow button (+) until door is fully open, then release. Watch carriage as it approaches the power head to avoid contact with powerhead.

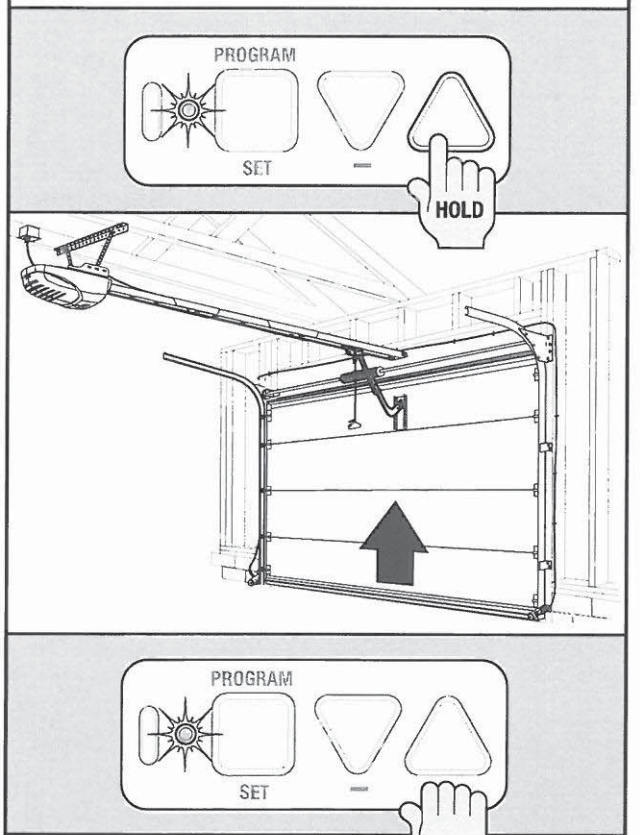

7 Release up arrow button (+) and the round LED will begin flashing.

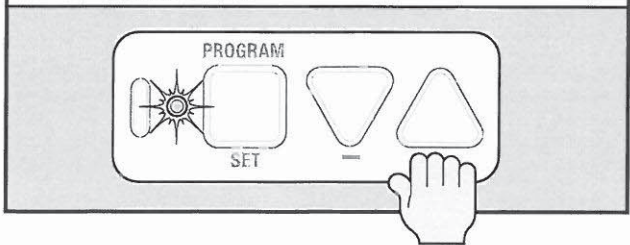

9 Press and release the Program Set button (both LEDs flash blue and go off).

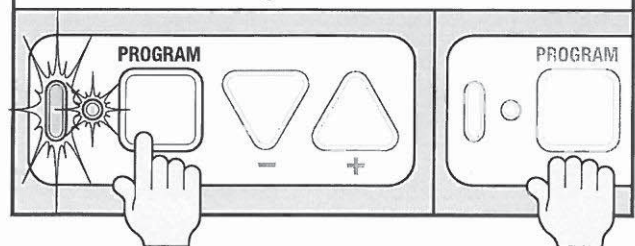

The UP (open) limit is programmed.

BOTH DOOR LIMITS ARE NOW PROGRAMMED.

3

Required Programming

WALL CONSOLE / Overview

This opener has a serial number sticker in which the serial numbers begin with 10 or higher.

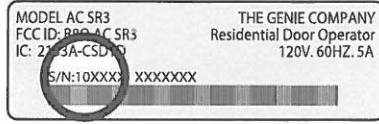

Wall consoles from other manufacturers may not work with openers of these serial number groups. Use only the wall console provided with this unit. Each wall console has three buttons.

In your carton you will find one of the following wall consoles:

Series II Wall Consoles with White Buttons

Indicator Light

Large white button will display Red when wall console is properly wired and Sure-Lock™ is OFF. When Sure-Lock™ is ON, this light is off

Open/Close Button

Use this button to open or close garage door. When Sure-Lock™ is ON, the Open/Close button will CLOSE the door only.

NOTE: Constant button pressure in the CLOSE mode will override STB fault in the powerhead and close door.

Independent Light Control Button

Use this button to turn powerhead lights ON. Powerhead lighting will remain ON until this button is pressed again or a door action has been completed.

NOTE: If opener has a Motion Detector sensor, it will keep powerhead lights ON as long as motion is detected.

Sure-Lock™ Button

When Sure-Lock™ is ON, the powerhead cannot be activated by the wall console or a remote.

- Press and release (or until red light goes off) to activate Sure-Lock™.
- Press and release to turn Sure-Lock™ OFF.

Open/Close Button
Opens and closes door from inside garage.

Indicator Light
-Red indicator backlight is ON.
-When Sure-Lock™ is ON, the indicator light is OFF

Sure-Lock™ Button
- LOCK disables controls after door is completely closed.
- UNLOCK allows controls to work normally.

Independent Light Control Button
Controls door opener lights from inside garage.

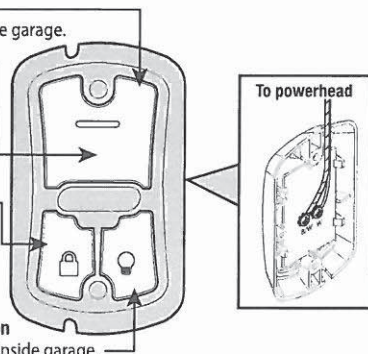

Series III Wall Consoles with Black Buttons

Indicator Light

Indicator light will display Red when wall console is properly wired and Sure-Lock™ is OFF. When Sure-Lock™ is ON, indicator light flashes.

Open/Close Button

Use this button to open or close garage door. When Sure-Lock™ is ON, the Open/Close button will CLOSE the door only.

NOTE: Constant button pressure in the CLOSE mode will override STB fault in the powerhead and close door.

Independent Light Control Button

Use this button to turn powerhead lights ON. Powerhead lighting will remain ON until this button is pressed again or a door action has been completed.

NOTE: If opener has a Motion Detector sensor, it will keep powerhead lights ON as long as motion is detected.

Sure-Lock™ Button

When Sure-Lock™ is ON, the powerhead cannot be activated by the wall console or a remote.

- Press and hold for 5 seconds (or until Indicator Light flashes) to activate Sure-Lock™.
- Press and release to turn Sure-Lock™ OFF.

Open/Close Button
Opens and closes door from inside garage.

Indicator Light
-Red indicator light is always ON.
-When Sure-Lock™ is ON, the indicator light flashes.

Sure-Lock™ Button
- LOCK disables controls after door is completely closed.
- UNLOCK allows controls to work normally.

Independent Light Control Button
Controls door opener lights from inside garage.

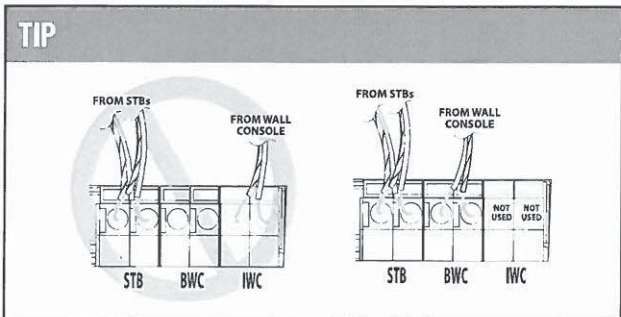
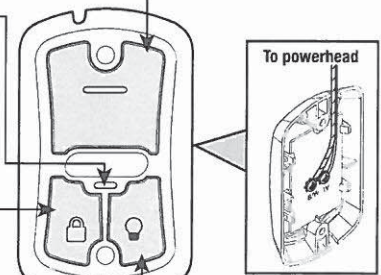

3

Required Programming

Force and Speed Control

These controls are factory programmed and automatically set themselves when you use the Wall Console to open and close the garage door for the first time. The door **MUST** complete a full cycle from open to close and close to open before it is fully set.

NOTE: Force or Speed controls **DO NOT** require programming. Force and Speed Limits are factory set and rarely require adjustments. Making adjustments to these settings is covered in "Maintenance & Adjustments" Section of this manual (pages 17-18).

10 Open and close your garage door using the Wall Console Open/Close button.

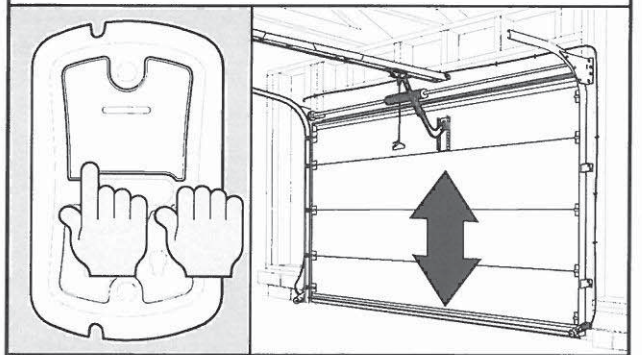

NOTE: Using these functions for the first time automatically sets the Force needed to open and close your garage door.

FORCE AND SPEED CONTROL ARE NOW SET.

Contact Reverse Test

NOTE: The Limit and Force settings **MUST BE COMPLETED** before performing the Contact Reverse Test.

11 Open the garage door using the Open/Close button on the Wall Console.

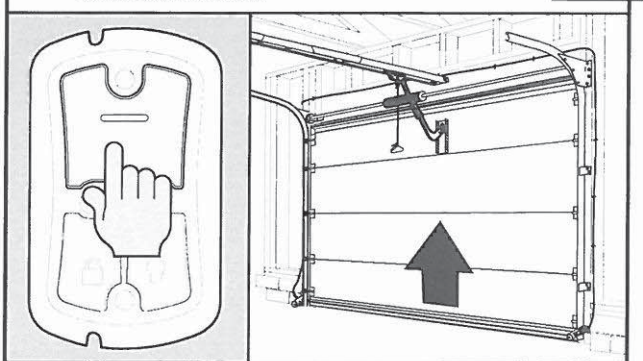

12 Lay a 2" x 4" board flat under the center of the door opening.

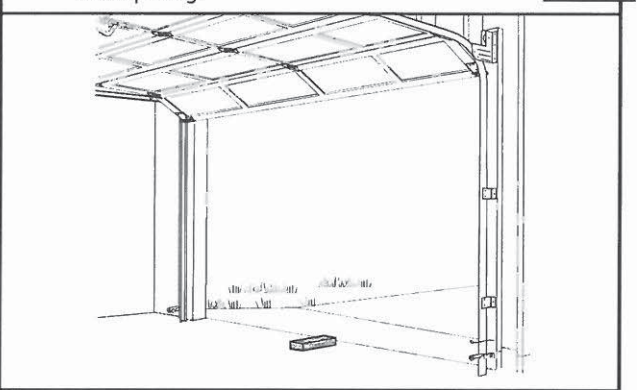

13 Close the garage door using the Open/Close button on the Wall Console.

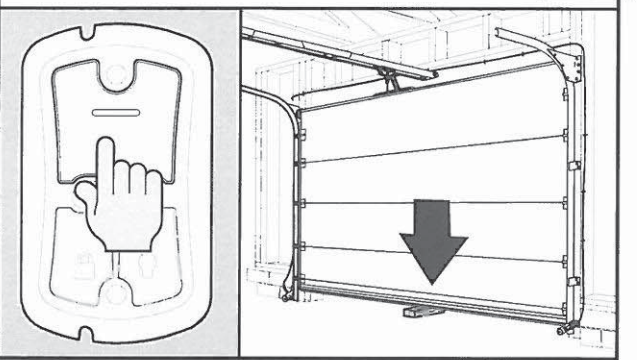

When the door contacts the board, it should stop and reverse direction within 2 seconds to the fully OPEN position. Red LED lights on the powerhead will begin to flash with the reversal of the door. The next cycle will clear the lights.

Contact Reverse Adjustment

If the door stops before contacting the board or if it does not reverse direction to fully open after contact with the board, it may be due to improperly set DOWN limits.

Repeat the Setting the Down Limit steps 1-5 to make certain the door is closing tight to the floor.

Repeat step 10 to set force limits.

Then repeat the WALL CONSOLE/Contact Reverse Test, steps 11-13.

Repeat this process as needed until door passes the Contact Reverse Test. For further help, refer to MAINTENANCE and ADJUSTMENTS, Regular Maintenance, pages 15-18.

3

Required Programming

REMOTES

NOTE: The following instructions are for the remote control transmitters ("Remotes") provided with this opener. This Remote is preset for use with the Intellicode® Access Security System.

NOTE: You have **30 seconds** to execute each step. If you see **two flashing red LEDs on the Powerhead**, you have run out of time and must go back to the beginning of the step and start over. You can restart as many times as necessary to complete each step.

NOTE: Each button on each Remote must be programmed separately, following these steps.

- 14** Press and hold the Program Set button (the round LED turns blue).

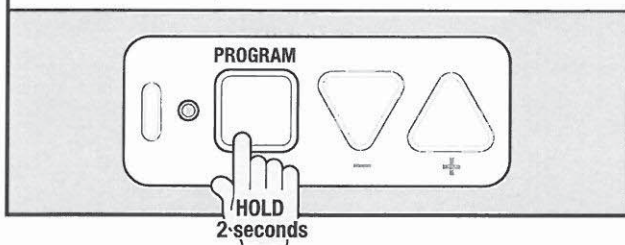

- 15** Release the Program Set button (the long LED begins flashing purple).

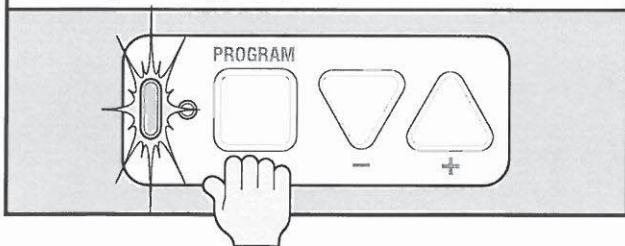

NOTE: This Remote Transmitter will operate older model Genie® openers, and programs in the same manner as your older remotes. Additionally, your older remote transmitters will operate this new model opener after programming, using the procedure on these pages.

- 16** Remove protective film for battery from remote.

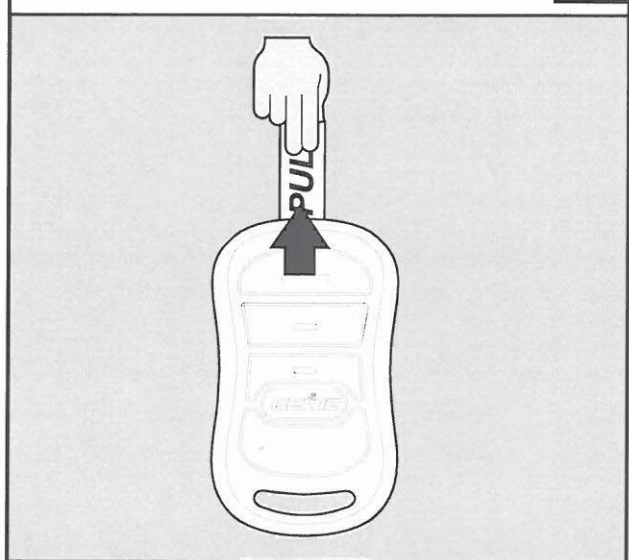

- 17** Press and release the button you have chosen on the Remote (long LED comes on purple).

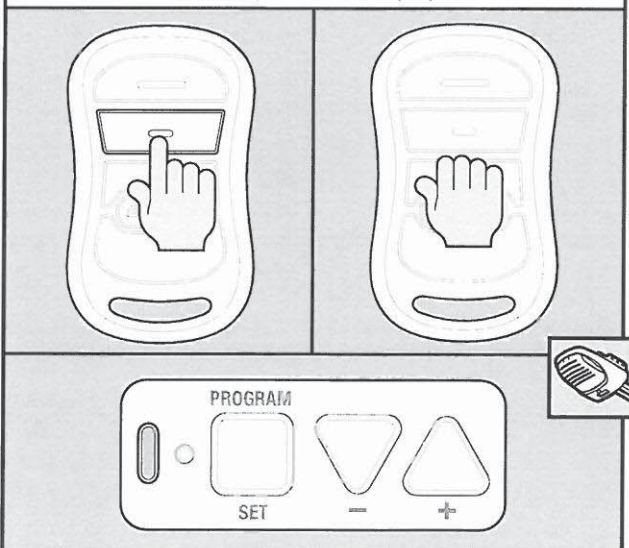

NOTE: Do NOT hold Remote too close to the Powerhead when programming Remote buttons.

(continued next page)

3

Required Programming

18 Press and release the same button on the remote (both LED's flash blue and then turn off).

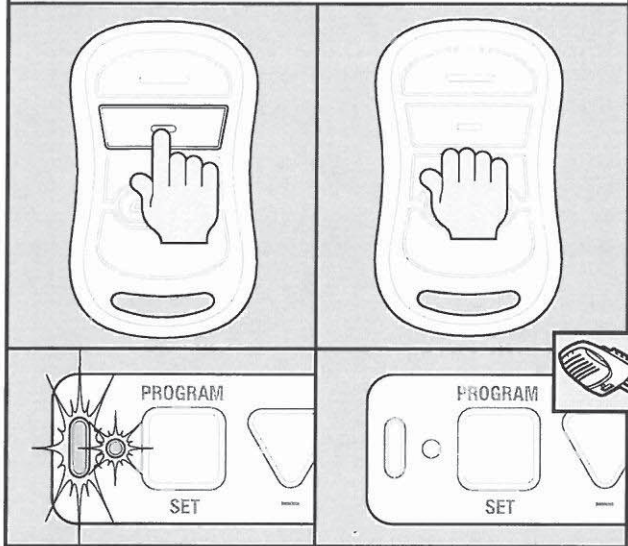

The Remote button is now programmed.

Repeat as necessary for additional Remotes.

To program the same Remote for other garage door openers, repeat the steps above using one of the other two Remote buttons.

Each Remote can be programmed for three door openers.

BASIC PROGRAMMING IS COMPLETE AND YOUR GARAGE DOOR IS READY TO USE!

NOTE: For Car2U and HomeLink, park the car outside the garage with the ignition key in the "Accessory" position. Follow the Car2U or HomeLink instruction to set the button in the car to Genie mode.

19 Press and release the same button on the remote (the door should open or close).

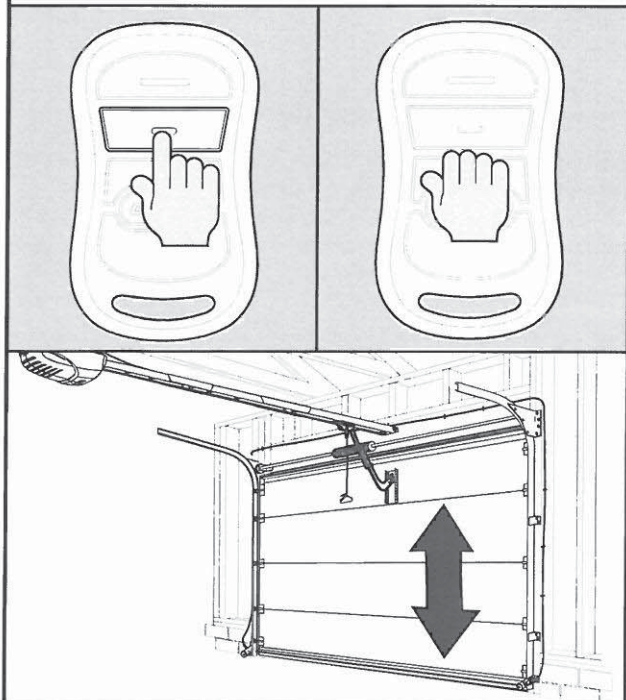

FCC and IC CERTIFIED

This device complies with FCC Part 15 and Industry Canada license exempt RSS standard(s). Operation is subject to the following two conditions: (1) this device may not cause interference, and (2) this device must accept any interference, including interference that may cause undesired operation of the device. This equipment generates, uses and can radiate radio frequency energy and, if not installed and used in accordance with the instructions, may cause harmful interference to radio communications. However, there is no guarantee that interference will not occur in a particular situation. If this equipment does cause harmful interference to radio or television reception, which may be determined by turning the equipment OFF and ON, the user is encouraged to try and correct the interference by one or more of the following measures: (a) Re-orient or relocate the receiver antenna, (b) Increase the separation between the opener and receiver, (c) Connect the opener into an outlet on a circuit different from that to which the receiver is connected, and (d) Consult your local dealer. Any modification or changes to this equipment which are not expressly approved by the manufacture could void the user's authority to operate the equipment.