



M A R L E Y

**QUICK START GUIDE
EXODUS**

INSIDE THE BOX

EM-FH051 V20

L'intérieur du carton / Dentro de la caja / In der Verpackung /
All'interno dell'imballaggio



A.

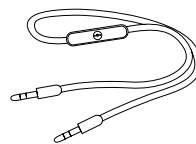

C.



D.

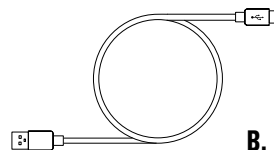

B.

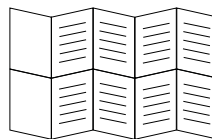

E.



F.

LEGEND

A. Headphones

B. Charging Cable

C. Aux Cable With

Microphone And 1-Button
Remote

D. Stash Bag

E. Warranty Information

F. Quick Start Guide

G. Welcome Cards

H. Sticker



G.



H.



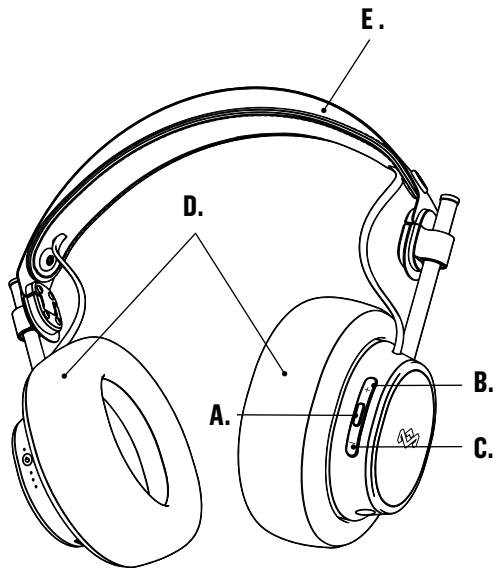



Composants / Componentes / Komponenten / Component



LEGEND

- | | |
|---------------------------------------|------------------------|
| A. Play/Pause + Answer / Hang up Call | F. Power On/Off |
| B. Volume Up/Track Forward | G. USB-C Charging Port |
| C. Volume Down/Track Backward | H. 3.5 Line In Port |
| D. Earcups | I. Headband Adjustment |
| E. Headband | |

STATUS

-  Low Power
-  Charging
-  Pairing Mode
-  Bluetooth® Not
-  Connected
-  Bluetooth® Connected

LED INDICATION

-  Blinking
-  On
-  Fast Blinking
-  Fast Blinking
-  Bluetooth®
-  Blue Light

POWER ON/OFF

Allumer/Eteindre / Encendido/Apagado / Ein/Aus /
Accensione/Spegnimento

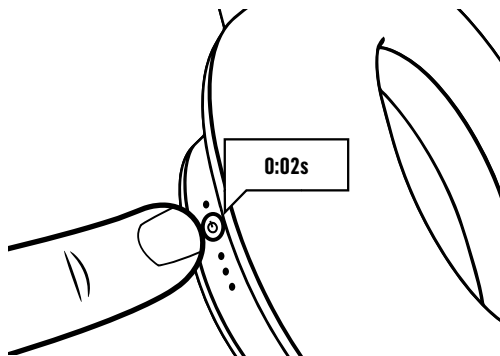

PAIR DEVICE

Coupler Appareil / Vincular Dispositivo / Mit Gerat Kopplen /
Accopia Dispositivo

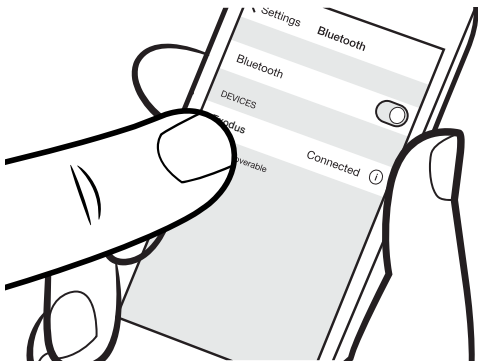

PAIR NEW DEVICE

EM-FH051 V20

Coupler Nouvel Appareil / Vincular Nuevo Dispositivo / Mit Neun
Gerat Koppeln / Accoppia Nuovo Dispositivo

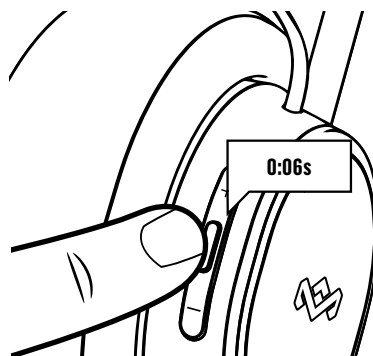

CLEAR PARING

Effacer le Couplage / Borrarr Vincular / Löschen eines
Bluetooth®-Geräts / Elimina l'associazione

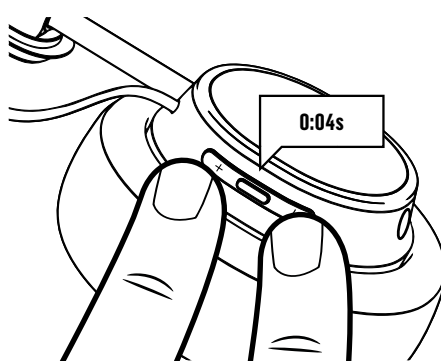

MUSIC CONTROL 🎵

Contrôle de la Musique / Control de la Musica / Kontrolle der Musik / Controllo della Musica

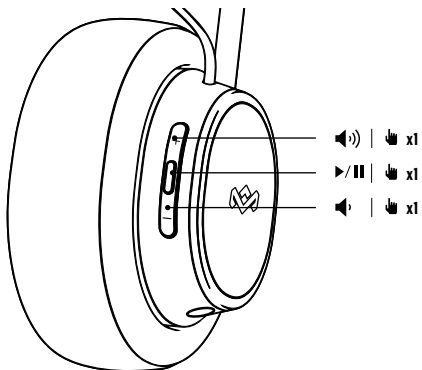

MAKE/END PHONE CALLS ☎️

EM-FH051 V20

Repondre/Fin / Responder/Colgar / Annehmen/Beenden / Risposta/Fine

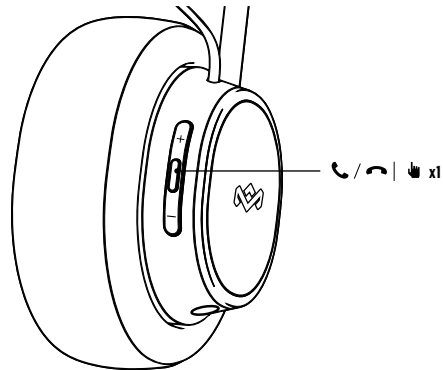

ACTIVATE VOICE ASSISTANT 🗣️

Activer l'assistant vocal / Activar el asistente de voz / Assistenten aktivieren / Attivare l'assistente Vocale

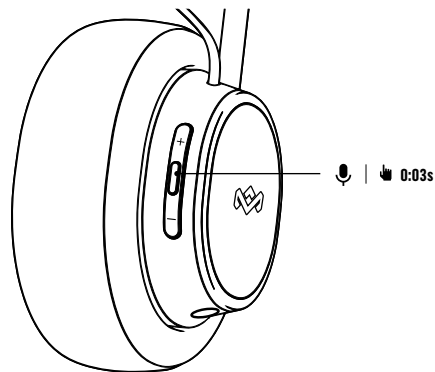
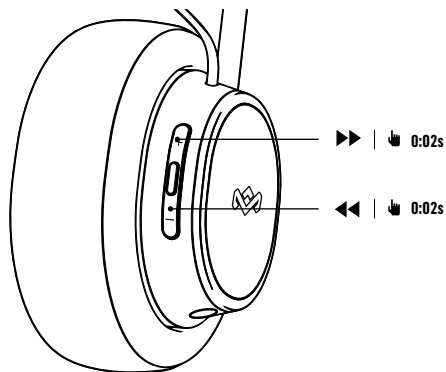

3.5 STEREO LINE IN JACK

Câble Audio Aux Jack 3.5 / Conector De 3,5 Mm En Línea / Cavo Da 3,5 Mm / 3,5Mm Klinke

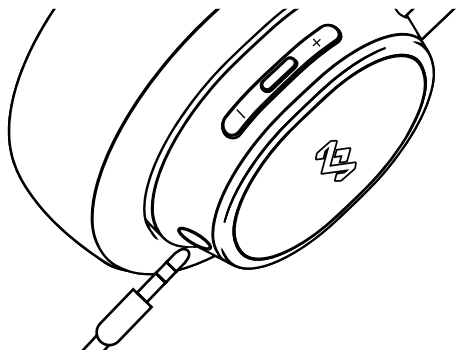







CHARGING

Conformité / Conformidad / Beachtung / Conformità



STATUS

-  Low Power
-  Charging
-  Pairing Mode
-  Bluetooth® Not
-  Connected
-  Bluetooth® Connected

LED INDICATION

-  Blinking
-  On
-  Fast Blinking
-  Fast Blinking
-  Bluetooth®
-  Blue Light



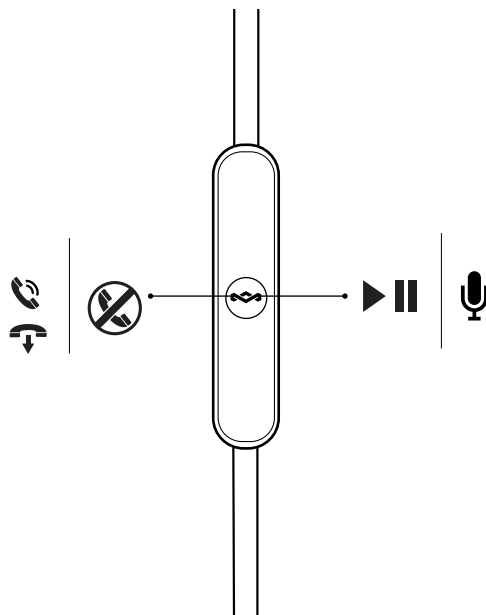

CABLE FUNCTIONALITY

EM-FH051 V20





Fonctionnalité Du Câble / Funcionalidad De Cable / Funzionalità Del Cavo / Kabel Funktionalität



LEGEND

-  Answer Call
-  End Call
-  Reject call
-  Play/Pause
-  Voice Siri/Google

ACTION

-  x1
-  x1
-  0:02s
-  x1
-  0:03s

COMPLIANCE INFO



Conformité / Conformidad / Beachtung / Conformità

EXODUS

READ ALL INSTRUCTIONS BEFORE USE AND SAVE THESE INSTRUCTIONS FOR FUTURE REFERENCE.

This equipment has been tested and found to comply with the limits for a Class B digital device, pursuant to part 15 of the FCC Rules. These limits are designed to provide reasonable protection against harmful interference in a residential installation. This equipment generates uses and can radiate radio frequency energy and, if not installed and used in accordance with the instructions, may cause harmful interference to radio communications. However, there is no guarantee that interference will not occur in a particular installation. If this equipment does cause harmful interference to radio or television reception, which can be determined by turning the equipment off and on, the user is encouraged to try to correct the interference by one or more of the following measures:

- Reorient or relocate the receiving antenna.
- Increase the separation between the equipment and receiver.
- Connect the equipment into an outlet on a circuit different from that to which the receiver is connected.
- Consult the dealer or an experienced radio/TV technician for help.

This device complies with FCC radiation exposure limits set forth for an uncontrolled environment.

This device complies with Part 15 of the FCC Rules. Operation is subject to the following two conditions: (1) this device may not cause harmful interference, and (2) this device must accept any interference received, including interference that may cause undesired operation.

FCC RF EXPOSURE STATEMENT:

This transmitter must not be co-located or operating in conjunction with any other antenna or transmitter.

CAUTION!

Any changes or modifications not expressly approved by the party responsible for compliance could void the user's authority to operate the equipment.

ISED STATEMENT

This device complies with Innovation, Science, and Economic Development Canada license-exempt RSS standard(s). Operation is subject to the following two conditions: (1) this device may not cause interference, and (2) this device must accept any interference, including interference that may cause undesired operation of the device.

Le présent appareil est conforme aux CNR d'Innovation, Sciences et Développement économique Canada applicables aux appareils radio exempts de licence. L'exploitation est autorisée aux deux conditions suivantes : (1) l'appareil ne doit pas produire de brouillage, et (2) l'utilisateur de l'appareil doit accepter tout brouillage radioélectrique subi, même si le brouillage est susceptible d'en compromettre le fonctionnement.

The device complies with RF exposure guidelines, users can obtain Canadian information on RF exposure and compliance.

Les utilisateurs peuvent sur l'exposition aux radiofréquences et la conformité et compliance d'acquiescer les informations correspondantes. Utilisateurs peut obtenir l'information canadienne sur l'exposition et la conformité de fr.

This Class B digital apparatus complies with Canadian ICES-003.

Cet appareil numérique de classe B est conforme à la norme nmb - 003 du Canada.

ISED RF EXPOSURE STATEMENT:

The device is compliance with RF exposure guidelines, users can obtain Canadian information on RF exposure and compliance.

LE PRÉSENT APPAREIL EST CONFORME

EM-FH051 V20

Après examen de ce matériel aux conformités ou aux limites d'intensité de champ RF, les utilisateurs peuvent sur l'exposition aux radiofréquences et la conformité et compliance d'acquiescer les informations correspondantes.

BATTERY REPLACEMENT STATEMENT IN EUROPE

Your Exodus includes a rechargeable battery designed to last the lifetime of the product. In the unlikely event that you should require a replacement battery please contact Customer Services who will supply details of the warranty and out-of-warranty replacement battery service.

BATTERY DIRECTIVE

 This symbol indicates that batteries must not be disposed of in the domestic waste as they contain substances which can be damaging to the environment and health. Please dispose of batteries in designated collection points.

WEEE EXPLANATION

 This marking indicates that this product should not be disposed with other household wastes throughout the EU. To prevent possible harm to the environment or human health from uncontrolled waste disposal, recycle it responsibly to promote the sustainable reuse of material resources.

Hereby, FKA Brands Ltd, declares that this radio equipment is in compliance with the essential requirements and other relevant provisions of Directive 2014/53/EU. A copy of the Declaration of Conformity can be obtained from www.thehouseofmarley.co.uk/declaration-of-conformity

FR. EXODUS

LIRE TOUTES LES INSTRUCTIONS AVANT UTILISATION. LES CONSERVER POUR POUVOIR LES CONSULTER ULTÉRIEUREMENT.

REMPLACEMENT DES PILES

Votre enceinte Exodus comprend une batterie rechargeable conçue pour durer aussi longtemps que le produit. Dans le cas improbable où vous seriez obligé de recourir à une batterie de rechange, veuillez contacter le Service Clientèle qui vous informera sur la garantie de votre produit et le remplacement hors garantie.

DIRECTIVE RELATIVE AUX PILES ET AUX ACCUMULATEURS

 Ce symbole indique que les piles et les accumulateurs ne doivent pas être jetés avec les déchets ménagers car ils contiennent des substances pouvant être préjudiciables pour la santé humaine et l'environnement. Veuillez utiliser les points de collecte mis à disposition pour vous débarrasser des piles et accumulateurs usagés.

EXPLICATION WEEE

 Le symbole indique que le produit ne doit pas être éliminé avec les autres déchets ménagers dans toute l'Union Européenne. L'élimination incontrôlée des déchets pouvant porter préjudice à l'environnement ou à la santé humaine, veuillez le recycler de façon responsable. Vous favoriserez ainsi la réutilisation durable des ressources matérielles.

FKA Brands Ltd déclare par la présente que cet équipement radio est conforme aux exigences essentielles et autres dispositions pertinentes de la Directive 2014/53/EU. Pour obtenir un exemplaire de la Déclaration de conformité, s'adresser à www.thehouseofmarley.co.uk/declaration-of-conformity

NL. EXODUS

ALLE INSTRUCTIES LEZEN ALVORENS HET PRODUCT IN GEBRUIK TE NEMEN. DEZE INSTRUCTIES ZORGVULDIG BEWAREN.

BATTERIJEN VERVANGEN

De Exodus komt met een oplaadbare batterij die is ontworpen om net zolang als het product zelf mee te gaan. In het onwaarschijnlijke geval dat u een nieuwe batterij nodig hebt, kunt u contact opnemen met de klantendienst. De medewerkers van de klantendienst zullen u dan informatie geven over het vervangen van batterijen, al dan

niet uit hoofde van garantie.

RICHTLIJN INZAKE BATTERIJEN

 Dit symbool betekent dat batterijen niet met het huisvuil weggegooid mogen worden, omdat ze stoffen bevatten die schadelijk kunnen zijn voor het milieu en de gezondheid. Lever batterijen op een aangewezen inzamelpunt in.

UITLEEF OVER AEEA

 Deze markering geeft aan dat dit product binnen de EU niet met ander huisvuil mag worden weggegooid. Om eventuele schade aan het milieu of de menselijke gezondheid door het ongecontroleerd wegwerpen van afval te voorkomen, dient dit apparaat op verantwoorde wijze gerecycled te worden om duurzaam hergebruik van materiaalbronnen te bevorderen.

Hierbij verklaart FKA Brands Ltd. dat deze radioapparatuur voldoet aan de essentiële vereisten en andere relevante voorschriften van Directive 2014/53/EU.

Een kopie van de conformiteitsverklaring kan worden verkregen via

www.thehouseofmarley.co.uk/declaration-of-conformity

IT EXODUS

LEGGERE INTEGRALMENTE LE PRESENTI ISTRUZIONI PRIMA DELL'USO.
CONSERVARE LE PRESENTI ISTRUZIONI PER CONSULTAZIONI SUCCESSIVE.

SOSTITUZIONE DELLA BATTERIA

Il tuo sistema Exodus include una batteria ricaricabile la cui durata corrisponde alla vita utile del prodotto. Nella remota eventualità che ti occorra una batteria di ricambio, contatta il Servizio Clienti che ti fornirà i dettagli del servizio relativo alla batteria sostitutiva in garanzia e non in garanzia.

DIRETTIVA RELATIVA ALLE BATTERIE

 Questo simbolo indica che le batterie devono essere smaltite separatamente dai rifiuti domestici poiché contengono sostanze potenzialmente nocive per l'ambiente e la salute umana. Smaltire le batterie negli appositi centri di raccolta.

SPIEGAZIONE DIRETTIVA RAE

 Questo simbolo indica che il prodotto non deve essere smaltito assieme agli altri rifiuti domestici in tutti i Paesi dell'Unione Europea. Al fine di evitare un eventuale danno ambientale e alla salute umana derivante dallo smaltimento dei rifiuti non controllato, riciclare il prodotto in maniera responsabile per promuovere il riutilizzo sostenibile delle risorse materiali.

Con la presente, FKA Brands Ltd dichiara che l'apparecchiatura radio in oggetto è conforme ai requisiti essenziali e ad altre disposizioni pertinenti della Direttiva 2014/53/EU. È possibile richiedere una copia della Dichiarazione di conformità scrivendo all'indirizzo www.thehouseofmarley.co.uk/declaration-of-conformity

SP EXODUS

LEA TODAS LAS INSTRUCCIONES ANTES DE USAR. GUARDE ESTAS INSTRUCCIONES PARA REFERENCIA FUTURA.

REEMPLAZO DE BATERÍAS

Su Exodus incluye una batería recargable diseñada para funcionar durante la vida útil del producto. En el improbable caso de que necesite un reemplazo de batería, comuníquese con Servicios al Cliente, donde le suministrarán los detalles del servicio de reemplazo de baterías con garantía y sin garantía.

DIRETTIVA RELATIVA A LAS PILAS

 Este símbolo indica que las pilas no se deben eliminar con la basura doméstica ya que contienen sustancias que pueden ser perjudiciales para el medio ambiente y la salud. Deshágase de las pilas en los puntos de recogida que existen para ese fin.

EXPLICACIÓN RAE

 Este símbolo indica que este artículo no se debe tirar a la basura con otros residuos domésticos en ningún lugar de la UE. A fin de prevenir los efectos perjudiciales que la eliminación sin control de los residuos puede tener sobre el medio ambiente o la salud de las personas, le rogamos que los recicle de forma responsable para fomentar la reutilización sostenible de los recursos materiales.

Por la presente, FKA Brands Ltd declara que este dispositivo de radio está en conformidad con los requisitos esenciales y otras disposiciones relevantes de

la directiva 2014/53/EU. Si desea una copia de la declaración de conformidad, solicítela a www.thehouseofmarley.co.uk/declaration-of-conformity

FIN EXODUS

LUE KAIKKI OHJEET ENNEN KÄYTTÖÄ. SÄILYTÄ NÄMÄ OHJEET TULEVAA TARVETTA VARTEN. TÄRKEÄT VAROTOIMENPITEET:

AKUN VAIHTO

Exodus -kaiuttimessa on ladattava akku, joka on suunniteltu kestämaan yhtä pitkään kuin itse kaiutin. Jos akku kuitenkin täytyy vaihtaa, ota yhteyttä asiakaspalveluun, mistä saat tiedot takuun piiriin kuuluvan akun ja takuun ulkopuolisen akun korvaavasta toimituspalvelusta.

AKKUJA KOSKEVA DIREKTIVI

 Tämä symboli tarkoittaa, että akkuja ei saa hävittää talousjätteen mukana, koska ne sisältävät aineita, jotka voivat olla vahingollisia ympäristölle ja terveydelle. Yle akut niille tarkoitettuihin keräyspisteisiin.

WEEE-SELITYS

 Tämä merkki tarkoittaa, että tätä tuotetta ei saa hävittää muiden talousjätteiden mukana missään Eumaassa. Kontrollioimattomasta jätteiden hävittämisestä mahdollisesti aiheutuvien ympäristöhaittojen tai terveysvaarojen estämiseksi hävitä tämä tuote vastuullisesti edistääksesi materiaalivarojen uudelleenkäyttöä. FKA Brands Ltd. vakuuttaa, että tämä radiolaitte on direktiivien 2014/53/EU vaatimusten ja muiden siihen liittyvien säädösten mukainen. Kopion vaatimustenmukaisuusvakuutuksesta voi tilata lähettämällä sähköpostia osoitteeseen www.thehouseofmarley.co.uk/declaration-of-conformity

DE EXODUS

LESEN SIE SICH VOR DER BENUTZUNG ALLE HINWEISE GUT DURCH. BEWAHREN SIE DIESE HINWEISE GUT AUF.

BATTERIEWECHSEL

Ihr Exodus enthält eine wiederaufladbare Batterie, die für die gesamte Lebensdauer der Lautsprecher halten sollte. In dem unwahrscheinlichen Fall, dass Sie die Batterie ersetzen müssen, wenden Sie sich bitte an unseren Kundendienst, der Sie über die Einzelheiten zum Ersatz der Batterie im Garantiefall und außerhalb der Garantie informieren wird.

BATTERIE RICHTLINIE

 Dieses Symbol weist darauf hin, dass die Batterien nicht mit dem gewöhnlichen Hausmüll entsorgt werden dürfen, da sie Stoffe enthalten, die sich auf Umwelt und Gesundheit schädlich auswirken können. Entsorgen Sie die Batterien bitte an den hierfür vorgesehenen Sammelstellen.

WEEE-ERKLÄRUNG

 Diese Kennzeichnung weist darauf hin, dass dieses Produkt innerhalb der EU nicht mit anderem Hausmüll entsorgt werden soll. Damit durch unkontrollierte Abfallentsorgung verursachte mögliche Umwelt- oder Gesundheitsschäden verhindert werden können, entsorgen Sie dieses Produkt bitte ordnungsgemäß und fördern Sie damit eine nachhaltige Wiederverwendung der Rohstoffe.

Hiermit erklärt die FKA Brands Ltd., dass dieses Funkgerät in Übereinstimmung mit den wesentlichen Anforderungen und anderen entsprechenden Bestimmungen der Richtlinie 2014/53/EU geliefert wird. Eine Kopie der Konformitätserklärung ist über www.thehouseofmarley.co.uk/declaration-of-conformity

TR EXODUS

KULLANMADAN ÖNCE TÜM TALİMATLARI OKUYUN. BU TALİMATLARI DAHA SONRA BAKIYORMAK ÜZERE SAK.

PİL DEĞİŞTİRME

Exodus'ınızda, ürünün ömrü boyunca yetecek şekilde tasarlanmış şarj edilebilir pil bulunmaktadır. Pili değiştiriminizin gerekmesi durumunda, lütfen, size garanti kapsamı ve garanti kapsamı dışında olan pil değiştirme hizmet detaylarını verecek Müşteri Hizmetleriyle teması geçin.

PİL DİREKTİFİ

 Bu sembol, çevreye ve sağlığa karşı zararlı olabilen maddeler içerebileceği için pillerin ev atılmaması gerektiği gösterir. Lütfen, pilleri belirtilen toplama

noctallarna atin.

WEEE AÇIKLAMASI

 Bu işaret bu ürünün AB genelinde diğer ev atıklarıyla birlikte atılmaması gerektiğini belirtir. Kontrolsüz atığın çevre veya insan sağlığına olası zararları engellemek için sorumlu bir dönüştürülmesini ve malzeme kaynaklarının sürdürülebilir şekilde yeniden kullanılmasını sağlar.

İş bu vesileyle, FKA Brands Ltd, bu telsiz ekipmanının 2014/53/EU Yönergesinin temel gereksinimleri ve diğer ilgili hükümleriyle uyumlu olduğunu beyan eder. Uygunluk Beyanı'nın bir kopyası

www.thehouseofmarley.co.uk/declaration-of-conformity

SV EXODUS

LÄS DESSA INSTRUKTIONER OCH BEHÅLL DEM FÖR ENKEL REFERENS.

LÄS ALLA INSTRUKTIONERNA FÖRE ANVÄNDNING. SPARA DESSA INSTRUKTIONER FÖR FRAMTIDA REFERENS.

BYTE AV BATTERI

Din Exodus inkluderar ett återuppladdningsbart batteri som är designat att vara under produktens livslängd. Om du osannolikt skulle behöva byta batteriet, kontakta kundtjänst som kommer att ge dig information om garantin och batteribytestjänst utanför garantin.

BATTERIFÖRESKRIFT

 Denna symbol indikerar att batterier inte får avyttras bland hushållsoppor eftersom de innehåller substanser som kan skada miljön och hälsan. Avyttra batterier endast vid designerade samlingspunkter.

WEEE-FÖRKLARING

 Denna markering indikerar att denna produkt inte får avyttras med annat hushållsavfall inom EU. För att förhindra möjlig skada på miljön eller person från okontrollerat avfallsavyttrande, återvinna på ansvarsfullt vis för att främja det fortsatta återanvändandet av materialresurser.

Härmed deklarerar FKA Brands Ltd att denna radioustrüstning är förenlig med nödvändiga krav och andra relevanta bestämmelser i direktivet 2014/53/EU. En kopia av förenlighetsdeklarationen kan erhållas från www.thehouseofmarley.co.uk/declaration-of-conformity

RU EXODUS

ПРОЧИТАЙТЕ ВСЕ ИНСТРУКЦИИ ПЕРЕД ИСПОЛЬЗОВАНИЕМ. СОХРАНИТЕ ЭТИ ИНСТРУКЦИИ ДЛЯ ДАЛЬНЕЙШЕГО ИСПОЛЬЗОВАНИЯ.

ЗАМЕНА БАТАРЕЙКИ

Динамик Exodus содержит аккумулятор, срок службы которого соответствует сроку службы продукта. Если возникнет необходимость в замене аккумулятора, что маловероятно, обратитесь в службу поддержки. Ее персонал предоставляет гарантийное обслуживание и осуществляет замену аккумуляторов (на замену аккумуляторов действие гарантии не распространяется).

ИНСТРУКЦИИ К БАТАРЕИ

 Данный символ означает, что батареи не следует утилизировать совместно с бытовым мусором, поскольку они содержат вещества, способные нанести вред окружающей среде и здоровью. Утилизируйте батареи в специально предназначенных для этого приемных пунктах.

ПОЯСНЕНИЕ WEEE

 Данная маркировка означает, что в странах Европы не допускается утилизировать прибор вместе с другими бытовыми отходами. Чтобы не нанести ущерба окружающей среде и здоровью населения в результате неверной утилизации отходов, прибор следует сдать на переработку, чтобы обеспечить экологичное повторное использование материальных ресурсов.

Компания FKA Brands Ltd настоящим подтверждает соответствие данного радиооборудования основным требованиям и другим применимым положениям Директивы 2014/53/EU. Копия Декларации соответствия можно

получить по электронному адресу:

www.thehouseofmarley.co.uk/declaration-of-conformity

EM-FH051 V20

DK EXODUS

LÆS HELE VEJLEDNINGEN IGENNEM FØR BRUG. GEM DENNE VEJLEDNING TIL SENERE BRUG.

UDSKIFTNING AF BATTERI

Din Exodus indeholder et genopladeligt batteri, som er beregnet til at vare hele produktets levetid. Hvis det usandsynlige skulle ske, og du har brug for et nyt batteri, bedes du kontakte Kundservice, som kan informere dig om udskiftning af batteri, både så længe garantien gælder og senere.

BATTERIDIREKTIV

 Dette symbol indikerer, at batterier ikke må bortskaffes med husholdningsaffald, da de indeholder stoffer, der kan være miljø- og helbredskskadelige. Bortskaf venligst batterier på udpegede indsamlingssteder.

WEEE FORKLARING

 Denne afmærkning angiver, at dette produkt ikke må bortskaffes med andet husholdningsaffald inden for EU. For at forhindre mulig skade for miljøet eller menneskers sundhed på grund af ukontrolleret affaldsbortskaffelse, skal det genanvendes på ansvarlig vis for at fremme den bæredygtige genanvendelse af materielle ressourcer.

FKA Brands Ltd erklærer hermed, at dette radioudstyr efterlever de essentielle krav og andre relevante bestemmelser i direktiv 2014/53/EU. En kopi af Overensstemmelseserklæringen kan fås hos

www.thehouseofmarley.co.uk/declaration-of-conformity

NO EXODUS

LES ALLE INSTRUKSJONENE FØR BRUK. TA VARE PÅ DISSE INSTRUKSJONENE FØR FREMTIDIG REFERANSE.

SKIFTE BATTERI

Exodus enheten din har et oppladbart batteri som er konstruert for å vare like lenge som produktet. Skulle det uforutsett skje at du trenger et nytt batteri, ta kontakt med kundetjenesten som vil gi deg informasjon om garantien og utskifting-service for batteri når garantien har utgått.

BATTERIDIREKTIV

 Dette symbolet indikerer at batteriene ikke må kastes sammen med vanlig husholdningsavfall da de inneholder substanser som kan skade miljøet og helsen. Vær venlig å kaste batterier i angitte oppsamlingspunkter.

WEEE FORKLARING

 Denne merkingen indikerer at innen EU skal dette produktet ikke kastes sammen med annet husholdningsavfall. For å forebygge mulig skade på miljøet eller menneskelig helse forsøkes det å ukontrollert avfallstopping, skal produktet gjenvinnes ansvarlig for å støtte holdbar gjenbruk av materialressurser.

FKA Brands Ltd, erklærer herved at dette radioutstyret samsvarer med nødvendige krav og andre relevante forholdsregler i direktiv 2014/53/EU. En kopi av konformitetserklæringen er tilgjengelig fra

www.thehouseofmarley.co.uk/declaration-of-conformity

EL EXODUS

ΔΙΑΒΑΣΤΕ ΟΛΕΣ ΤΙΣ ΟΔΗΓΙΕΣ ΠΡΙΝ ΤΗ ΧΡΗΣΗ. ΦΥΛΑΞΤΕ ΑΥΤΕΣ ΤΙΣ ΟΔΗΓΙΕΣ ΓΙΑ ΜΕΛΛΟΝΤΙΚΗ ΑΝΑΦΟΡΑ.

ΑΝΤΙΚΑΤΑΣΤΑΣΗ ΜΠΑΤΑΡΙΑΣ

To χείριο Exodus περιλαμβάνει μια επαναφορτιζόμενη μπαταρία ειδικά σχεδιασμένη ώστε να διαρκεί για όλη την ωφέλιμη ζωή του προϊόντος. Στην απίθανη περίπτωση που θα χρειαστείτε μπαταρία αντικατάστασης, επικοινωνήστε με την Εξυπηρέτηση Πελατών, η οποία θα σας δώσει λεπτομέρειες για αντικατάσταση της μπαταρίας εντός και εκτός εγγύησης.

ΟΔΗΓΙΑ ΓΙΑ ΤΙΣ ΜΠΑΤΑΡΙΕΣ

 Το σύμβολο αυτό υποδεικνύει ότι οι μπαταρίες δεν πρέπει να απορρίπτονται μαζί με οικιακά απορρίμματα, καθώς περιέχουν ουσίες που μπορεί να είναι

επιβλαβείς για το περιβάλλον και την υγεία. Απορρίψτε τις μπαταρίες στα καθορισμένα σημεία συλλογής.

ΕΠΕΞΗΓΗΣΗ ΑΗΘΕ

 Αυτή η σήμανση επισημαίνει ότι αυτό το προϊόν δεν πρέπει να απορριφτεί με άλλα οικιακά απόβλητα σε όλη την ΕΕ. Για να μην προκληθεί ζημιά στο περιβάλλον ή στην υγεία λόγω μη ελεγχόμενης απόρριψης αποβλήτων, ανακυκλώστε το υπεύθυνα, προάγοντας τη βιώσιμη επαναχρησιμοποίηση των υλικών πόρων.

Με το παρόν, η FKA Brands Ltd δηλώνει ότι αυτός ο αούρματος εξοπλισμός συμμορφώνεται με τις ουαυδεις απαιτήσεις και τις άλλες σχετικές προβλέψεις της Οδηγίας 2014/53/ΕΕ. Μπορείτε να αποκτήσετε ένα αντίγραφο της Δήλωσης Συμμόρφωσης αν επικοινωνήσετε με τη διεύθυνση

www.thehouseofmarley.co.uk/declaration-of-conformity

CZ EXODUS

PŘED POUŽITÍM ZAŘÍZENÍ SI PŘEČTĚTE VŠECHNY POKYNY. POKYNY USCHOVEJTE PRO BUDOUCÍ NAHLÉDNUTÍ.

VÝMĚNA BATERIE

Jednotka Exodus obsahuje nabíjecí baterii, která by měla být funkční po celou dobu životnosti produktu. Pokud by však bylo třeba baterii vyměnit, kontaktujte zákaznickou službu, která vám poskytne podrobné informace o záruční a mimozáruční výměně baterie.

POKYNY K BATERII

 Tento symbol znamená, že baterie nesmí být likvidována vyhozením do domácího odpadu, protože obsahuje látky, jež mohou poškodit životní prostředí a zdraví. Za účelem likvidace baterie odevzdejte na určeném sběrném místě.

VYSVĚTLENÍ OZEZ

 Tato značka udává, že výrobek nesmí být na území EU vyřazen z běžným domácím odpadem. Pro prevenci možné znečištění životního prostředí a újmě na zdraví osob nekontrolovaným odpadem recyklujte výrobek odpovídáním způsobem.

Společnost FKA Brands Ltd tímto prohlašuje, že toto rádiově vybavení je ve shodě se základními požadavky a dalšími relevantními ustanoveními směrnice 2014/53/EU. Kopii prohlášení o shodě získáte na adrese www.thehouseofmarley.co.uk/declaration-of-conformity

HU EXODUS

HASZNÁLTAL ELŐTT ÖLVASSA EL AZ UTASÍTÁSOKAT, ÉS A KÉSŐBBI HASZNÁLATHOZ TEGYE EL EZEKET.

AZ AKKUMULÁTOR CSERÉJÉ

A Exodus újratölthető akkumulátor tartalmaz, amit úgy terveztek, hogy kitartson a termék teljes élettartamáig. Ha mégis szüksége lenne egy cseresakumulátorra, lépjen kapcsolatba az Ügyfélszolgálattal, ahol tájékoztatást adnak a jótállásban foglalt és a jótálláson kívüli eső akkumulátorcserével kapcsolatban.

ELEMEKRE VONATKOZÓ IRÁNYELV

 Ez a szimbólum azt jelzi, hogy az elemek nem dobhatók háztartási hulladék közé, mivel olyan anyagokat tartalmaznak, amelyek károsak lehetnek a környezetre és az egészségre. Kérjük, vigye a használt elemeket a kijelölt gyűjtőhelyre.

WEÉE-MAGYARÁZAT

 Ez a jelölés azt jelzi, hogy ezt a terméket az Európai Unióban nem szabad a háztartási hulladék közé dobni. Az ellenőrzetlen hulladékkezelésből származó környezeti vagy egészségügyi kár elkerülése végett, és a tárgyi készletek fenntartható kezelése jegyében felelősségteljesen hasznosítsa újra.

A FKA Brands Ltd. kijelenti, hogy ez a rádióberendezés elegendő tesz a 2014/53/EU irányelv szükséges követelményeinek és egyéb vonatkozó rendelkezéseinek. A Megfelelőségi nyilatkozat másolatát a

www.thehouseofmarley.co.uk/declaration-of-conformity

PT EXODUS

LEIA TODAS AS INSTRUÇÕES ANTES DE UTILIZAR. CONSERVE ESTAS INSTRUÇÕES PARA REFERÊNCIA FUTURA.

SUBSTITUIÇÃO DA BATERIA

O seu Exodus inclui uma bateria vitalícia recarregável. Na hipótese pouco provável de necessitar de substituir a bateria, contacte o Serviço de Apoio ao Cliente, que lhe irá disponibilizar informações sobre o serviço de substituição da bateria ao abrigo da garantia e fora da cobertura da garantia.

INSTRUÇÕES RELATIVAMENTE ÀS PILHAS

 Este símbolo indica que as pilhas não podem ser eliminadas juntamente com o lixo doméstico, dado que contêm substâncias que podem ser prejudiciais para o meio ambiente e a saúde. As pilhas devem ser eliminadas nos pontos de recolha designados.

EXPLICAÇÃO DA REE

 Esta marcação indica que o produto não deve ser eliminado juntamente com outros resíduos domésticos em toda a UE. Para impedir possíveis danos ambientais ou à saúde humana resultantes de uma eliminação não controlada dos resíduos, este produto deverá ser reciclado de forma responsável de modo a promover a reutilização sustentável dos recursos materiais.

Desta forma, o FKA Brands Ltd, declara que este equipamento de rádio está em conformidade com os requisitos essenciais outras provisões relevantes da Diretiva 2014/53/EU. É possível obter uma cópia da Declaração de Conformidade através do www.thehouseofmarley.co.uk/declaration-of-conformity

SK EXODUS

PRED POUŽITÍM ZARIADENIA SI PREČÍTAJTE VŠETKY POKYNY. POKYNY USCHOVAJTE NA NAHLADNUTIE V BUDÚCNOSTI.

VÝMENA BATERIE

V reproduktore Exodus sa nachádza vymeniteľná batéria navrhnutá tak, aby jej životnosť zodpovedala životnosti produktu. Ak sa stane (hoci je to nepravdepodobné), že budete potrebovať náhradnú batériu, obráťte sa na pracovníkov oddelenia služieb zákazníkom, ktorí vám poskytnú podrobné informácie o servise náhradnej batérie vykonávanom v rámci záručnej lehoty a aj po jej skončení.

POKYNY OHĽADNE BATERIE

 Tento znak znamená, že batérie sa nesmú likvidovať spolu s domácim odpadom, pretože obsahujú látky, ktoré môžu znečistiť životné prostredie alebo poškodiť zdravie. Batérie likvidujte v strediskách určených pre zber odpadu.

WEÉE POPIS

 Tento symbol znamená, že výrobok by sa v rámci celej EU nemá vyhadzovať do domáceho odpadu. Aby nedošlo k možnému znečisteniu životného prostredia alebo poškodeniu zdravia v dôsledku nekontrolovaného odpadu, je potrebné pristupovať k recyklovaniu zodpovedne a propagovať tak opätovné použitie zdrojových materiálov.

Spoločnosť FKA Brands Ltd. týmto vyhlasuje, že toto rádiové zariadenie je v súlade so základnými požiadavkami a ďalšími relevantnými ustanoveniami Smernice 2014/53/EÚ. Kópiu vyhlásenia o zhode získate na adrese www.thehouseofmarley.co.uk/declaration-of-conformity

PL EXODUS

PRZED UŻYCIEM NALEŻY PRZECZYTAĆ CAŁĄ INSTRUKCJĘ. INSTRUKCJĘ NALEŻY ZACHOWAĆ NA PRZYSZŁOŚĆ.

WYMIANA BATERII

Głośnik Exodus został wyposażony w baterie wielokrotnego ładowania o żywotności porównywalnej z żywotnością produktu. W przypadku wystąpienia sytuacji wymagającej wymianę baterii należy skontaktować się z działem obsługi klienta, który zapewni informacje dotyczące gwarancji oraz usługi wymiany baterii nieobjętej gwarancją.

DYREKTYWA DOT. BATERII

Ten symbol oznacza, że baterii nie można wyrzucać wraz z odpadami domowymi, ponieważ baterie zawierają substancje, które mogą być szkodliwe dla środowiska oraz zdrowia. Baterie należy dostarczyć do wyznaczonych punktów zbiórki.

OBJASNIENIE WIEE

Ten znak wskazuje, że na obszarze UE przyrzędu nie wolno pozbywać się wyrzucając do śmieci domowych. Aby chronić środowisko i zdrowie, którym zagraża nieodpowiednia utylizacja odpadów, przyrząd należy recyklingować, aby umożliwić odzysk materiałów, z których został wykonany.

Niniejszym firma FKA Brands Ltd oświadcza, że to urządzenie radiowe jest zgodne z podstawowymi wymaganiami oraz innymi właściwymi postanowieniami Dyrektywy 2014/53/EU. Kopię Deklaracji zgodności można uzyskać pod **www.thehouseofmarley.co.uk/declaration-of-conformity**

BG EXODUS

ПРОЧЕТЕТЕ ВСИЧКИ ИНСТРУКЦИИ ПРЕДИ УПОТРЕБА И ГИ ЗАПАЗЕТЕ ЗА БЪДЕЩА СПРАВКА.

ПРЕДУПРЕЖДЕНИЕ: БАТЕРИИТЕ (КУТИЯТА С БАТЕРИИ ИЛИ ПОСТАВЕНИТЕ БАТЕРИИ) НЕ ТРЯБВА ДА СЕ ИЗЛАГАТ НА ПРЕКАЛЕНО ЗАТОПЛЯНЕ КАТО СЛЪНЧЕВА ТОПЛИНА, ОГЪН ИЛИ ДРУГИ ПОДОБНИ. ВНИМАНИЕ: ОПАСНОСТ ОТ ЕКСПЛОЗИЯ АКО БАТЕРИЯТА НЕ Е ПОСТАВЕНА ПРАВИЛНО. ЗАМЕНЕТЕ ЕДИНСТВЕНО СЪС СЪЩИЯ ИЛИ С ПОДОБЕН ВИД.

ЗАМЯНА НА БАТЕРИЯТА:

Вашият Exodus включва зареждащи се батерии, предназначени да издържат през целия живот на продукта. В малко вероятния случай, когато се наложи замяна на батерията, моля свържете се с отдела за клиентско обслужване, който ще Ви осигури информация за гаранцията и услугата за замяна на батерията извън гаранция.

ДИРЕКТИВА ЗА БАТЕРИЯТА

Този символ показва, че батериите не трябва да се изхвърлят с битовите отпадъци, защото съдържат вещества, които може да са опасни за околната среда и за здраве. Моля, изхвърляйте батериите на предначинените за тази цел места.

ОБЕО ОБЯСНЕНИЕ

Това маркиране показва, че този продукт не трябва да се изхвърля с други битови отпадъци в границите на ЕС. За предотвратяване на евентуална щета за околната среда или за човешкото здраве поради неконтролно изхвърляне на батерията, рециклирайте го отговорно, за да съдействате за екологичната многократна употреба на материалите ресурси.

С настоящето, FKA Brands Ltd, декларира, че това радиосъоръжение е в съответствие на основните изисквания и на други необходими условия на Директива 2014/53/EU. Копие от Декларацията за съответствие може да бъде получено от

www.thehouseofmarley.co.uk/declaration-of-conformity

RO EXODUS

CITITI TOATE INSTRUCȚIUNILE ÎNAINTE DE UTILIZARE ȘI PĂSTRAȚI-LE PENTRU A LE CONSULTA ÎN VIITOR.

ÎNLOCUIREA BATERILOR

Difuzorul Exodus include un acumulator conceput să reziste pe toată durata de viață a produsului. În cazul imprevizibil în care ați fi obligat să înlocuiți acumulatorul, contactați Serviciul Clienți care vă va informa cu privire la garanția produsului dumneavoastră și la înlocuirea acumulatorului după expirarea garanției.

DIRECTIVA PRIVIND BATERIILE ȘI ACUMULATORII

Acest simbol indică faptul că nu este permis să se arunce bateriile și acumulatorii cu deșeurile menajere deoarece conțin substanțe care pot dăuna mediului și sănătății. Vă recomandăm să predați bateriile și acumulatorii uzați la punctele de colectare puse la dispoziție.

EXPLICAȚIA DEEE

Acest simbol indică faptul că acest produs nu trebuie eliminat împreună cu alte deșeurii menajere pe teritoriul UE. Pentru a preveni posibile prejudicii asupra mediului sau sănătății umane din cauza eliminării necontrolate a deșeurilor, reciclați-l cu responsabilitate pentru a favoriza reutilizarea durabilă a resurselor materiale.

FKA Brands Ltd declară că acest dispozitiv radio este în conformitate cu cerințele esențiale și alte prevederi relevante ale Directivei 2014/53/EU. Un exemplar al Declarației de conformitate poate obținut de la **www.thehouseofmarley.co.uk/declaration-of-conformity**

AR EXODUS

اقرأ الإرشادات والفهمها قبل استخدام المنتج وبخطة الاحتفاظ بها للرجوع إليها.

استبدال البطارية

يحتوي نظام Exodus على بطارية قابلة لإعادة الشحن مدمجة خصيصاً لاستمرار على مدار عمر المنتج. في حالة احتياجك لبطارية بديلة، وهو أمر بعيد الاحتمال، يرجى الاتصال بخدمة العملاء حيث يمكنك الحصول على التفاصيل حول خدمة استبدال البطارية داخل الضمان أو خارجة.

تعليمات البطارية

يشير هذا الرمز إلى أن البطاريات ينبغي عدم التخلص منها مع سائر المخلفات المنزلية لأنها تحتوي على مواد قد تضر بالبيئة والصحة. يرجى التخلص من البطاريات في أماكن التجميع المخصصة.

مخلفات الأجهزة الكهربائية / الإلكترونية

يشير هذا الرمز إلى أن المنتج ينبغي عدم التخلص منه مع سائر المخلفات المنزلية الأخرى في جميع أنحاء الاتحاد الأوروبي لتفادي احتمال وقوع الضرر على البيئة أو الصحة البشرية بسبب التخلص من النفايات بطرق غير خاضعة للضوابط. يرجى إعادة تدويرها على نحو مسؤول لتعزيز إعادة الاستغلال المستدام المبرمة. FKA Brands Ltd يوجه أن هذا الجهاز الإلكتروني يتوافق مع المتطلبات اللازمة وغيره من الأحكام ذات الصلة من الأمر الإرشادي ٢٠١٤/٥٢/EU ويمكن الحصول على نسخة من إعلان المطابقة على **www.thehouseofmarley.co.uk/declaration-of-conformity**

CN EXODUS

使用之前請閱讀所有指南並妥善保存以備未來參考

更換電池

Exodus 隨帶一個可充電電池。設備使用期內無需更換電池。當您因某種特殊原因需要更換電池時，請與客服聯繫。客服人員將為您提供詳細的保修期內和保修期後更換電池的服務說明。

廢舊電池的處理

此符號表示電池不得與家庭廢物一起丟棄，因為電池含有對環境和健康有害的成分。請將廢舊電池送至指定的收集處。

歐共體廢棄電子電器設備指南(WEEE) 釋釋

此標識表示在歐共體內本產品不得與家庭廢物一起丟棄。無控制的廢物丟棄有害環境或健康，必須避免。請盡力回收廢舊設備，使其持續得以再生利用。

FKA分銷有限公司在此聲明，此無線設備符合2014/53/EU指南的基本要求和其它相關條款。請訪問www.thehouseofmarley.co.uk/declaration-of-conformity以獲取合規聲明的副本。

NCC WARNING MESSAGE

低功率電波輻射性電機管理辦法

第十二條 經型式認證合格之低功率射頻電機，非經許可，公司、商號或使用者均不得擅自變更頻率、加大功率或變更原設計之特性及功能。

第十四條 低功率射頻電機之使用不得影響飛航安全及干擾合法通信；經發現有干擾現象時，應改善至無干擾時方得繼續使用。前項合法通信，指依電信法規定作業之無線電通信。

ID EXODUS

BACA SEMUA PETUNJUK SEBELUM PENGGUNAAN DAN SIMPAN PETUNJUK INI UNTUK RUJUKAN DI MASA MENDATANG.

PENGGANTIAN BATERAI

Exodus Anda mencakup baterai isi ulang yang dirancang untuk bisa dipakai selama masa pakai produk. Apabila Anda memerlukan baterai pengganti, hubungi Layanan Pelanggan yang akan memberikan detail tentang layanan baterai pengganti garansi dan di luar garansi.

ARAHAN BATERAI

Simbol ini menunjukkan bahwa baterai tidak boleh dibuang bersama sampah rumah tangga karena mengandung zat yang dapat merusak lingkungan dan kesehatan. Buang baterai di tempat pengumpulan yang telah ditentukan.

PENJELASAN WEWE

Tanda ini menunjukkan bahwa produk ini tidak boleh dibuang bersama sampah rumah tangga lain di seluruh UE. Untuk mencegah kemungkinan bahaya pada lingkungan atau kesehatan manusia dari pembuangan limbah yang tidak terkendali, daur ulang produk ini secara bertanggung jawab untuk mempromosikan penggunaan kembali sumber daya bahan secara berkelanjutan.

FKA Brands Ltd dengan ini menyatakan bahwa peralatan radio ini mematuhi persyaratan penting dan ketentuan relevan lainnya dari Arahan 2014/53/EU. Salinan Pernyataan Kepatuhan bisa diperoleh dari

www.thehouseofmarley.co.uk/declaration-of-conformity



To prevent possible hearing damage, do not listen at high volume levels for long periods. Full instruction and warranty details can be found at <http://www.thehouseofmarley.com/instructionbooks>

Con el fin de evitar lesiones auditivas, se aconseja no escuchar a un volumen excesivamente alto durante un periodo prolongado. Para ver los detalles completos y las excepciones, consulte <http://www.thehouseofmarley.com/instructionbooks>

Afin d'éviter tout dommage auditif possible, ne pas écouter à un volume sonore élevé pendant une période prolongée. Pour les informations complètes et les exceptions, rendez-vous sur <http://www.thehouseofmarley.com/instructionbooks>.

Um mögliche Hörschäden zu vermeiden, stellen Sie die Lautstärke nicht über einen längeren Zeitraum sehr hoch ein. Weitere Informationen und Ausnahmen erhalten Sie hier <http://www.thehouseofmarley.com/instructionbooks>.

Per evitare possibili danni all'udito, non ascoltare audio a livelli elevati di volume per lunghi periodi. Per tutti i dettagli e le eccezioni, visitare il sito <http://www.thehouseofmarley.com/instructionbooks>



인증받은자의 상호: (주)디얼에이씨인터내셔널
제품명/모델명: 특정소출력무선기기(무선데이터통신시스템용무선기기)/
EM-FH051

제조사 및 제조국가: FKA Distributing Co., LLC / China

인증번호: R-C-DMV-EM-FH051

제품명 (Product name): Over-ear-headphone

모델명 (Model): EM-FH051

무선 방식 (Operation Frequency): Bluetooth® (2402 – 2480 MHz)

채널 (Radio Channel): 79channels for BT3.0; 40channels for BLE

무선 채널 (Bluetooth® Mode): BT: 4.2

출력 (Output Power): 3mW

안테나 이득 (Antenna Gain): -1.18dB

변조 형식 (Modulation Type): GFSK, π/4-DQPSK, 8DPSK

전원 (Power Supply): 3.7 V

Marley and the Marley logo are registered trademarks of Fifty-Six Hope Road Music Limited and the use of such marks by House of Marley is under license. The Bluetooth® word mark and logos are registered trademarks owned by Bluetooth® SIG, Inc. and any use of such marks by House of Marley is under license.

Operating frequency bands: 2402 – 2480MHz
Max Power Transmitted: 2.34dBm for BT3.0, 6.51dBm for BT4.0

DISTRIBUTED BY:
The House of Marley, LLC
3000 North Pontiac Trail, Commerce Township,
MI 48390 USA

Distributed in Europe by FKA Brands Ltd.,
Somerhill Business Park, Five Oak Green Rd,
Tonbridge, Kent TN11 0GP, UK.

EM-FH051



IB-EMFH051
© 2018 House of Marley, LLC.
All Rights Reserved.



QUICK START GUIDE EXODUS

HouseofMarley.com



BOB MARLEY™
MARLEY™
BOBMARLEY.COM

©Fifty-Six Hope Road Music Ltd., ©2011-2018.
Right of Publicity and Persona Rights.
Fifty-Six Hope Road Music Ltd. EM-JA015

Marley, the Marley logo, Bob Marley and the Bob Marley logo are registered trademarks of Fifty-Six Hope Road Music Limited and any use of such marks by House of Marley is under license. The Bluetooth (use Rball next to it) word mark and logos are registered trademarks owned by Bluetooth SIG, Inc. and any use of such marks by House of Marley is under license.