



VS-600 Resident Unit Manual



For the VS-600 Resident Unit

November 2009
Revision 0.1 (PRELIMINARY)

Telecor Inc.
1114 Westport Cr.
Mississauga, Ontario
Canada, L5T 1G1

Tel: (905) 564-0801
Fax: (905) 564-0806
www.telecor.com

LIMITED WARRANTY

Telecor Inc. warrants all products bearing the Telecor name to be free from defects of material and workmanship under normal use and service for a period of one year from date of delivery. Telecor will repair or replace (at our option), free of charge, any unit that is found to be defective and returned to us under warranty. Telecor warrants all other products made by others, and distributed by us, to be covered by the manufacturers' warranty period.

This warranty shall not apply to any Telecor products that have been subject to misuse, neglect, accident, modification, water, fire, lightning, paint, or used in violation of instructions furnished, repaired or altered outside of the factory. This warranty does not cover batteries, bulbs, fuses or damage caused by batteries used in connection with the product. Telecor reserves the right to make the final decision on whether there is a defect in materials or workmanship, and whether or not the product returned is within the warranty period.

This warranty covers bench repairs only. Telecor will not be responsible for any costs incurred involving on-site service calls. Repair or replacement by others, fire, transportation, labour charges, indemnity, etc., are not covered by this warranty and no responsibility for same will be assumed by us. Our liability does not extend to consequential damage.

AUTHORIZED REPAIR STATION:

All participating Distributors and Dealers are authorized to accept Telecor products for return to us for repair or replacement, or customers may return goods to us directly, providing that return authorization has been obtained.

U.S. customers are required to ship any returns or repairs to:

Telecor Inc.
2434 Jerauld Avenue
Niagara Falls, New York
USA, 14305

** U.S. customers must not
return products to Canada*

Canadian and all International customers are required to ship any returns or repairs to:

Telecor Inc.
1114 Westport Crescent
Mississauga, Ontario
Canada, L5T 1G1

For details on Telecor's Return Policy, see our Published Merchandise Return Policy.

E:\VS-Care\VS-600 Manual.doc/AD

© Copyright 2009 by Telecor Incorporated. All rights reserved. No part of this publication may be reproduced in any form, or by any means, without the prior written permission of Telecor Incorporated.

Telecor Inc. makes no representation of warranties with respect to this manual. Further, Telecor reserves the right to make changes in the specifications of the products described in this manual at any time without notice, and without obligation of Telecor to notify any persons of such revisions or changes.

Windows XP and Windows Vista are Registered Trademarks of Microsoft in the United States and other countries.

www.telecor.com

FCC Notice

PRODUCT NAME: VS-600 Resident Unit (VS-600)
FCC Registration Number: R73ERS001

PRODUCT NAME: VS-600 Wireless Pendant (VS-600-WP)
FCC Registration Number: R73ERS002

PRODUCT NAME: VS-600 Wireless Pull Cord (VS-600-WC)
FCC Registration Number: R73ERS003

FCC RULES: THIS PRODUCT HAS BEEN TESTED TO COMPLY WITH FCC PART 15, SUBPART B, CLASS B – UNINTENTIONAL RADIATORS

OPERATING ENVIRONMENT: FOR USE IN RESIDENTIAL AREAS

FCC Compliance Statement:

This device complies with Part 15 of the FCC Rules. Operation is subject to the following two conditions: (1) this device may not cause harmful interference and (2) this device must accept any interference received, including interference that may cause undesired operation.

FCC Notice:

This equipment has been tested and found to comply with the limits for a Class B digital device, pursuant to Part 15 of the FCC Rules. These limits are designed to provide reasonable protection against harmful interference when the equipment is operated in a residential environment. This equipment generates, uses, and can radiate radio frequency energy and, if not installed and used in accordance with the instruction manual, may cause harmful interference to radio communications.

FCC Warning:

Warning: The user is cautioned that changes or modifications to the unit, not expressly approved by the manufacturer, could void the user's FCC or other authority to operate the equipment.

The Party Responsible for Product Compliance:

Telecor Inc.
1114 Westport Crescent
Mississauga, Ontario
Canada, L5T 1G1

TABLE OF CONTENTS

A. Introduction.....	A-1
A.1 VS-600 Resident Unit Overview	A-1
A.2 Overview of Peripheral Devices.....	A-2
B. VS-600 Programming	B-1
B.1 Resident Unit Diagnostic Procedure	B-1
B.2 Configuring the Resident Unit for Programming	B-2
B.3 Using Resident Unit Configuration Software	B-2
B.3.1 Options Tab	B-3
B.3.1.1 Numbers Tab	B-3
B.3.1.2 Supervision Numbers Tab.....	B-4
B.3.1.3 Misc. Tab.....	B-5
B.3.2 Saving Programming Information to a File.....	B-5
B.3.3 Prog./Config. Tab.....	B-6
B.3.4 Wireless Tool Tab.....	B-8
B.3.5 Log File Tab.....	B-9
B.4 Speech Param. Tab.....	B-9
B.5 Creating Dial Strings.....	B-10
B.5.1 Default Dial String Table	B-11
B.6 Configuring the Resident Unit for Common Areas.....	B-12
C. Installation.....	C-1
C.1 Installing Dome Lights	C-1
C.2 Powering Dome Lights	C-3
C.3 Mounting the Power Supply Unit	C-4
C.3.1 Book Mount Installation.....	C-4
C.3.2 Picture Mount Installation.....	C-5
C.4 Connecting PSU to Resident Units to Power Dome Lights.....	C-6
C.5 Installing the Wired Pull Cord Station	C-7
C.6 Enabling Wireless Pendant or Wireless Pull Cord Operation	C-7
C.7 Wiring a Smoke Detector.....	C-8
C.8 Wiring and Mounting Resident Unit	C-9

A. Introduction

This manual describes the VS-600 Resident Unit and the peripheral devices available for use with it. It explains the diagnostic procedures and programming steps that must be completed prior to installation.

A.1 VS-600 Resident Unit Overview

The VS-600 Resident Unit is designed to allow hands-free and two-way communication between the resident and an attendant. The Unit includes a Call Button to initiate calls to a designated administrative staff location, a Call Cancel Button, a Volume Control, and Menu and Activity Information Buttons. A built-in jack provides the ability to plug in a call cord, allowing the resident to remotely initiate a call from the bedside.



Resident Unit (front view)

The Unit is equipped with four status LEDs: Line, Activities, Menu, and Fault. The Line LED illuminates when a call is initiated from the unit. When it illuminates in conjunction with the Fault LED, it indicates a fault in the line. The Activities LED flashes when the Activities button is pressed, and the Menu LED flashes when the Menu button is pressed to confirm selection. The Fault LED illuminates and the unit signals a tone over the speaker to indicate a possible fault in the Unit or the need for battery replacement.

The Unit can receive and decode signals from Wireless Pendants and Wireless Pull Cord Stations and initiate calls to a designated administrative staff location. Each Pendant and Pull Cord Station transmits a unique digital signal known only to the VS-600 Unit in the resident's room. This provides assurance as to the exact origin of the call. The VS-600 has a reception range of up to 50 feet (line of sight) from the Pendant or Pull Cord Station.

The Unit has an input provision for the connection of an external call-in device such as a Wired Pull Cord Station, which provides call capabilities from resident bathrooms and showers. The input can be assigned to one of six priority levels to clearly identify the origin of the call and distinguish it from a cord call or a call initiated from the Unit's call button.

With the addition of a Dome Light Module, the Unit has the ability to connect to a Dome Light outside the resident's door, providing visual indication to staff of calls originating from the resident's room. The Dome Light consists of three individual and different-colored lamps that illuminate in distinct patterns to identify priority and the call-in device that the call originated from.

The Resident Unit is line powered from the single line station ports, eliminating the need for an external power supply. The Unit is designed for installation into a standard 3-gang electrical back box with 3-9/32" mounting centers.

A.2 Overview of Peripheral Devices

Described below are the peripheral devices that can function with the Resident Unit.

Wireless Pendant

The Wireless Pendant is worn by a VS-600 Resident user to allow him or her to move freely about a room yet have the ability to place a call. Calls are initiated by pressing a red call button on the Pendant.



Wireless Pull Cord Station

The Wireless Pull Cord Station offers the VS-600 Resident user the flexibility of being able to position a Pull Cord Station anywhere in the room. This makes it ideal for strategically positioning near furniture or in a bathroom or shower. It makes it a cost effective "Add on" to the system without costly installation or wiring upgrades.



Calls are initiated by pulling on the nylon pull cord. A call assurance LED illuminates briefly and a soft tone sounds at the Station to confirm the placement of the call. The call can be canceled at the Station by pressing a cancel button. An illuminated LED and a tone at the Station confirm the cancellation of the call.

The Wireless Pull Cord Station is suitable for surface mounting directly to a wall. No backbox or special mounting hardware is required.

NC-C1 Call Cord

A traditional Call Cord that plugs into the VS-600 Resident Unit to provide the convenience of being able to initiate a call remotely from a bedside.



Wired Pull Cord Station

The Wired Pull Cord Station provides call capabilities from resident bathrooms and showers. The Station connects to the input on the VS-600 Resident Unit. Calls are initiated by pulling on the Station's nylon call cord, and annunciate at the attendant's telephone with a unique call priority. The call can be canceled at the Resident Unit or from the attendant's telephone.



NC1-LD3 Dome Light

The Dome Light is typically located outside the door of a room containing a VS-600 Resident Unit to provide a visual indication of calls originating from within the room. When a resident initiates a call, a LED in the Dome Light illuminates. The Dome Light contains three LEDs with white, red and green filters. Each lamp color represents a different call type that originates from the Resident Unit's call button or call cord, a Pull Cord Station, or a Pendant.



B. VS-600 Programming

B.1 Resident Unit Diagnostic Procedure

Before programming and installing a Resident Unit, its diagnostic procedure first must be completed. To run the diagnostic procedure, plug the battery pack onto the two-pin header labeled BATTERY.

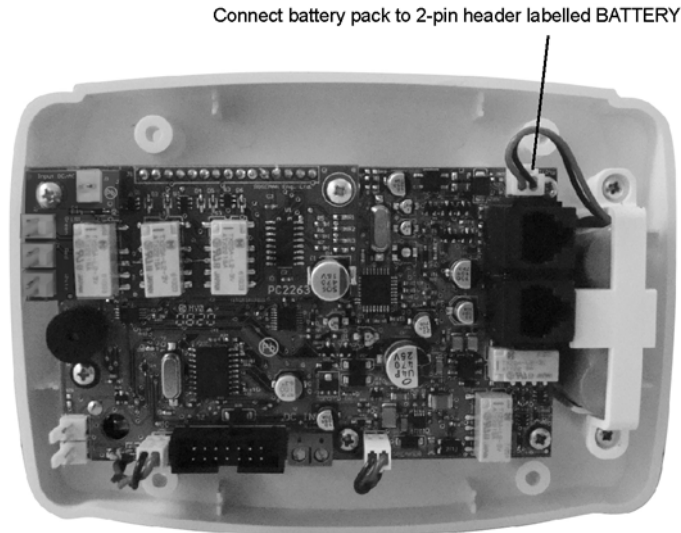

Once plugged in, the Unit should perform the following actions:

1. The four front LEDs and the Cancel button light up momentarily, then the line and fault LEDs flash and the unit beeps. This indicates that the battery is functioning and the unit has booted up properly.
2. The unit sounds three long beeps followed by three short beeps. This indicates that the unit has gone through the cancellation routine, which prepares the unit for standby mode.
3. The unit checks if a telephone line has been connected to the upper LINE jack, closest to the battery connector. After approximately five minutes, if a line still has not been connected, the line and fault LEDs will flash and the unit will sound three short beeps.

Note: When the unit is in standby mode (idle, not in operation), it performs Diagnostic Check 3 every five minutes. In working mode (the unit is in operation), it performs Diagnostic Check 3 continuously.

If all of the above actions have been performed, proceed with *Resident Unit Programming section B.2*. If the unit fails to perform the above actions, contact Telecor VS-Care Technical Support to request an RA.

B.2 Configuring the Resident Unit for Programming

The VS-600 Resident Unit is programmed to operate in conjunction with the PBX using the Resident Unit configuration software. The Resident Unit programming cable (sold separately) plugs into the resident unit's programming port and an available USB port of a PC running the Resident Unit configuration software.

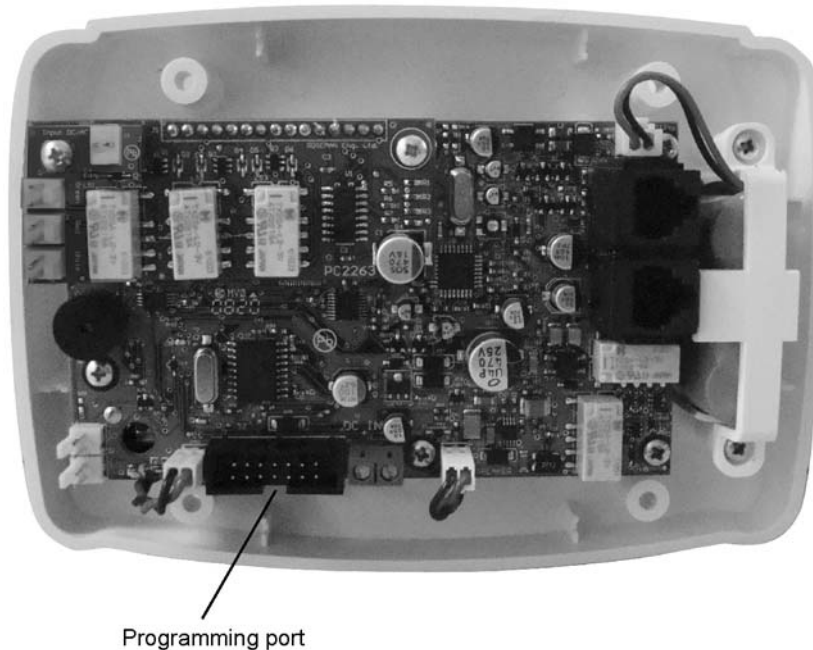

B.3 Using Resident Unit Configuration Software

When a resident unit or peripheral device such as a call cord or pendant makes a call, the resident unit notifies the PBX what type of call device is making the call, and dials a number according to the type of device making the call. This information is configured in the resident unit configuration software and uploaded to the resident unit.

The Resident Unit configuration software is an application that works with Microsoft Windows XP and Windows Vista[®] operating systems.

The Resident Unit configuration program consists of five tabs: **Options**, **Prog./Config.**, **Wireless Tool**, **Log File**, and **Speech Param.** The **Options** tab is further divided into **Numbers**, **Supervision Numbers**, and **Misc** (Miscellaneous) tabs. The **Options**, **Prog./Config.**, and **Speech Param.** tabs contain settings for adjusting the behaviour of the resident unit. The **Wireless Tool** and **Log File** tabs are used to download and review operational information from the resident unit for troubleshooting.

B.3.1 Options Tab

The **Options Tab** shows the configuration options of the resident unit. The options tab is split into two main areas: **Set Number** and **Parameters**. The **Set Number** area contains the dial strings, priority and dome light settings for each call device and for the menu and activities buttons. The Parameters area allows you to check the resident unit's battery and internal clock.

The **Options Tab** is subdivided into three tabs: **Numbers**, **Supervision Numbers**, and **Misc.** The **Numbers Tab** contains dial string, priority, and dome light settings for different call-in devices. The **Supervision Numbers Tab** contains dial strings for situations triggered from supervision. The **Misc.** tab contains dial string settings not covered in the previous tabs.

Use the **Options Tab** when you want to change dome light assignments, call phone destinations, or call priorities.

B.3.1.1 Numbers Tab

The **Numbers Tab** contains the dial strings that the resident unit calls when a device makes a call-in.

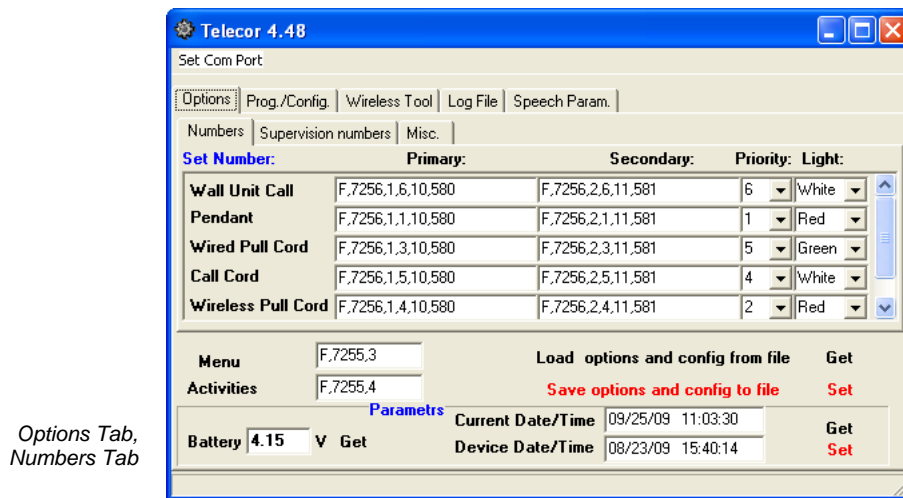

Options Tab,
Numbers Tab

Primary: The Primary boxes contain the primary dial string that the resident unit will call when a particular device makes a call-in.

Secondary: The Secondary boxes contain the secondary or rollover dial string that the resident unit will call when a particular device makes a call-in and the primary contact does not answer. This number will only be dialed if the "Redial Primary num." box is checked on the Prog./Config. tab.

A dial string based on a required dial scheme must be entered into the **Primary** and **Secondary** boxes. For an explanation of a dial string example, refer to *Creating Dial Strings, section B.5*.

Priority: A call device can be assigned a priority from 1 (highest) to 6 (lowest). For example, if a resident presses the call button, it dials the assigned phone number and alerts the destination. If the resident then triggers a higher-priority device, such as a call pendant, the call from the call

button will be cancelled because of its lower priority, and the higher-priority device will dial its assigned number.

Note: When a call device is triggered, there will be a delay of approximately five seconds before the destination is alerted. If the resident activates a higher priority device within five seconds of activating a lower priority device, the lower priority device will still be first to alert the destination.

Light: From the drop-down box, select which color in the dome light will illuminate when a call is made by the call device. Options are none, red, green, or white.

Menu: The dial string that the resident unit will call when someone presses the Menu button.

Activities: The dial string that the resident unit will call when someone presses the Activities button.

Battery: To check the resident unit's battery, click **Get** below the **Battery** box. The current battery voltage level will appear in the box. If the voltage level is below 3.6 V, replace the battery.

Current Date/Time: The current date and time of your computer clock. Click **Set** to synchronize the resident unit clock with your computer clock. The format is dd/MM/yy HH:mm:ss where dd is the day, MM is the month, yy is the year, HH is the hour in 24-hour format, mm is the minute, and ss is the second.

Device Date/Time: The date and time of the device's internal clock. Click **Get** to retrieve the resident unit's internal time. The format is dd/MM/yy HH:mm:ss where dd is the day, MM is the month, yy is the year, HH is the hour in 24-hour format, mm is the minute, and ss is the second.

B.3.1.2 Supervision Numbers Tab

The **Supervision Numbers Tab** contains dial strings for situations triggered from battery or device supervision.

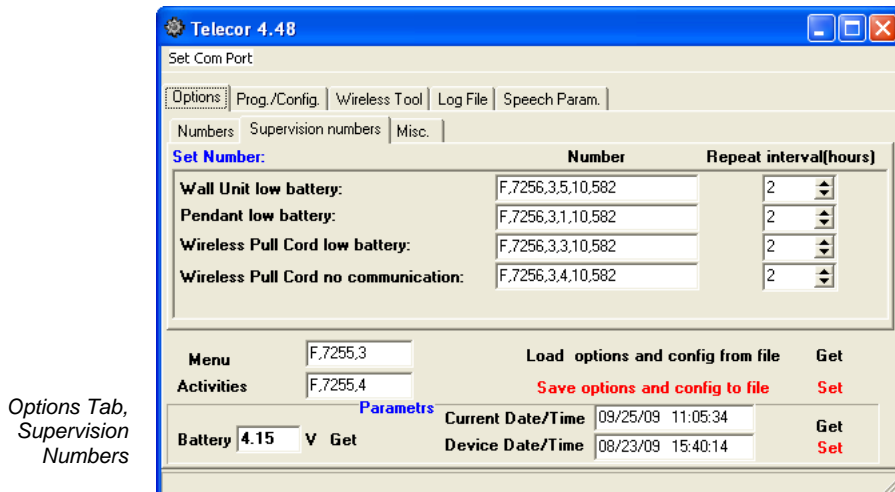

Wall Unit low battery: The dial string the unit will call when the resident unit's battery is low.

Pendant low battery: The dial string the unit will call when a pendant’s battery is low.

Wireless Pull Cord low battery: The dial string the unit will call when a wireless pull cord unit’s battery is low.

Wireless Pull Cord no communication: The dial string the unit will call when it loses contact with the wireless pull cord.

Repeat interval (hours): The resident unit will redial the dial string after a certain number of hours as long as the triggering condition is present.

For an explanation of a dial string example, refer to *Creating Dial Strings, section B.5*.

B.3.1.3 Misc. Tab

The **Misc.** tab contains dial string settings not covered in the other tabs.

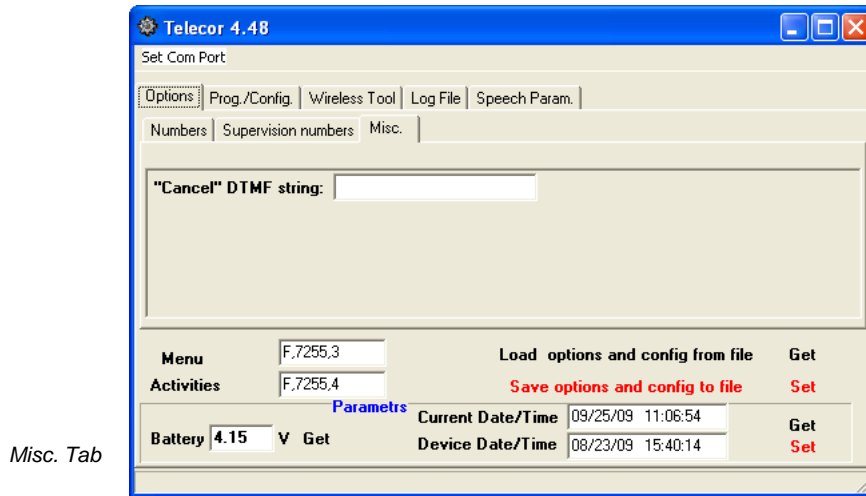

“Cancel” DTMF string: The dial string the resident unit calls when the cancel button is pressed.

For an explanation of a dial string example, refer to *Creating Dial Strings, section B.5*.

B.3.2 Saving Programming Information to a File

You can save the current settings from the Options and Prog./Config. tabs to a file. This is useful for quickly programming multiple resident units with the same settings.

To save the current configuration settings to a file, click **Save options and config to file**, type a file name for your configuration file, then click **Save**.

To load configuration settings from a file, click **Load options and config from file**, select your configuration file, then click **Open**.

Click **Get** beside **Load options and config from file** to download the settings from the resident unit.

Click **Set** beside **Save options and config to file** to upload the current settings to the resident unit.

B.3.3 Prog./Config. Tab

The **Prog./Config. Tab** contains programming and configuration settings for the resident unit. Use this tab to change the desired behaviour when a call goes unanswered, to upgrade the resident unit software, to configure the unit for use in a common area, or configure whether a call from the unit can be cancelled by dialling *9 at the destination.

Note: In a majority of installations, these settings do not need to change.

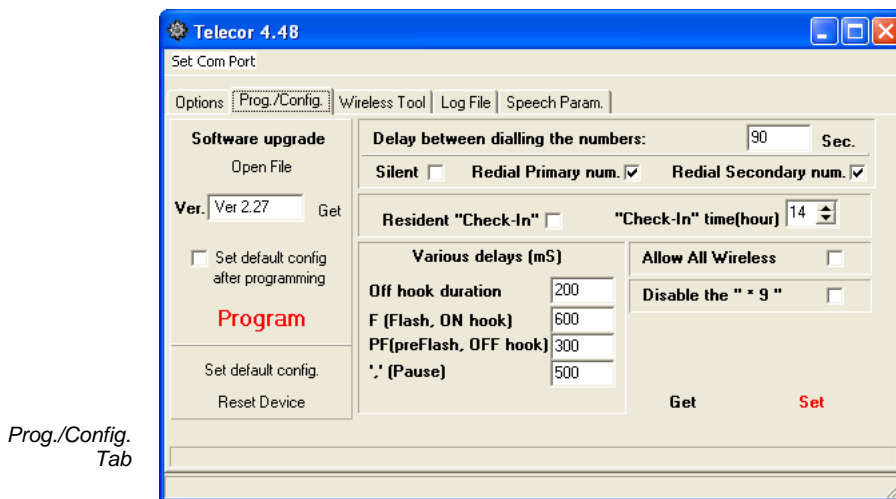

Software upgrade: This section is used to upgrade the resident unit software. It should not be used unless instructed to do so by Telecor Technical Support.

Delay between dialling the numbers: After dialling a number, the number of seconds to wait before dialling the secondary or rollover number if the call is unanswered.

Silent: Check the box to make the resident unit dial the phone voice server silently when a device makes a call. If unchecked, you will hear the DTMF tones while the resident unit dials a call.

Redial Primary num. (Redial secondary number if primary number does not answer): Check this box to enable the device to redial or rollover to the secondary number after dialling the primary number if the primary number does not answer. See the table on the next page for an explanation of this feature.

Redial Secondary num. (Redial primary number if secondary number does not answer): Check this box to enable the device to redial or rollover to the primary number after dialling the secondary number if the secondary number does not answer. See the table on the next page for an explanation of this feature.

The following table describes the effects of checking the Redial Primary or Redial Secondary boxes:

Redial Primary	Redial Secondary	Result
<input type="checkbox"/>	<input type="checkbox"/>	<ol style="list-style-type: none"> 1. Resident unit dials primary number. 2. Resident unit waits for the call to be answered or for the time in delay to elapse. 3. If the call is unanswered, the resident unit ends the call (hangs up).
<input checked="" type="checkbox"/>	<input type="checkbox"/>	<ol style="list-style-type: none"> 1. Resident unit dials primary number. 2. Resident unit waits for the call to be answered or for the time in delay to elapse. 3. Resident unit dials secondary number. 4. Resident unit waits for the call to be answered or for the time in delay to elapse. 5. If the call is unanswered, the resident unit ends the call (hangs up).
<input type="checkbox"/>	<input checked="" type="checkbox"/>	<ol style="list-style-type: none"> 1. Resident unit dials primary number. 2. Resident unit waits for the call to be answered or for the time in delay to elapse. 3. If the call is unanswered, the resident unit ends the call (hangs up).
<input checked="" type="checkbox"/>	<input checked="" type="checkbox"/>	<ol style="list-style-type: none"> 1. Resident unit dials primary number. 2. Resident unit waits for the call to be answered or for the time in delay to elapse. 3. Resident unit dials secondary number. 4. Resident unit waits for the call to be answered or for the time in delay to elapse. 5. If the call is unanswered, the resident unit dials the primary number again (goes back to step 1).

Resident “Check-In”: Not used.

“Check-In” time(hour): Not used.

Various Delays (ms): These values are set by default and should not be changed unless instructed to do so by Telecor Technical Support.

Allow All Wireless: Check this box to allow the resident unit to accept calls from all wireless devices without needing them to be programmed first. See section B.6 for more information about configuring a resident unit for use in a common area.

Disable the “ * 9 ”: Check this box to disallow someone from cancelling a call from the resident unit by dialing *9 at the destination station. Note that *9 can still be used to interrupt the playing of menu entrées or activity schedules.

Click **Get** to download the settings from the resident unit.

Click **Set** to upload the current settings to the resident unit.

B.3.4 Wireless Tool Tab

The **Wireless Tool Tab** allows you to view a list of wireless devices programmed on the resident unit. A resident unit can support up to 4 wireless pendants and 4 wireless pull cords, for a total of 8 devices.

If the maximum number of devices are programmed in the resident unit, one must be removed before a new one can be programmed. Use this tab to deprogram devices from the resident unit.

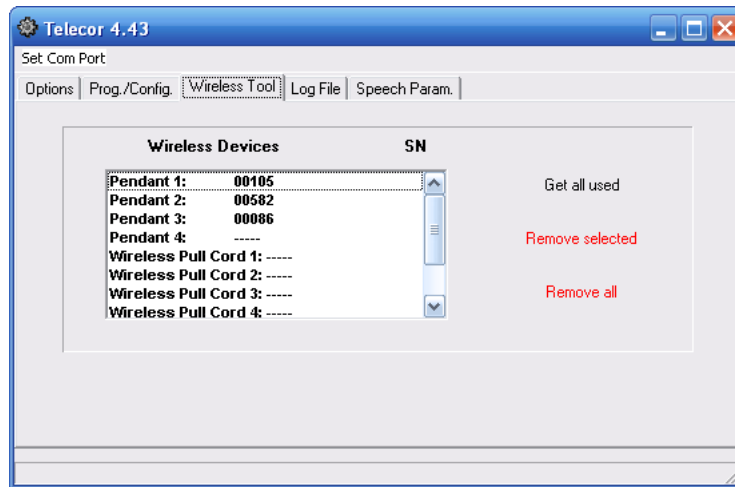

Wireless Tool Tab

Click **Get all used** to download a list of devices programmed on the resident unit. The list shows the devices' serial numbers.

To remove a device, select a device in the list and click **Remove selected** to remove the device.

To remove all the programmed devices from the resident unit, click **Remove all**.

For information about programming wireless pendants and pull cords in the resident unit, refer to section C.6.

The resident unit can be configured to accept calls from all wireless devices without needing them to be programmed first. See section B.6 for more information about configuring a resident unit for use in a common area.

B.3.5 Log File Tab

The **Log File Tab** allows you to review the resident unit's log file. The log file is used for troubleshooting, but you will not need to access this tab in most situations. The log file stores the dates, times, and descriptions of the last 50 events.

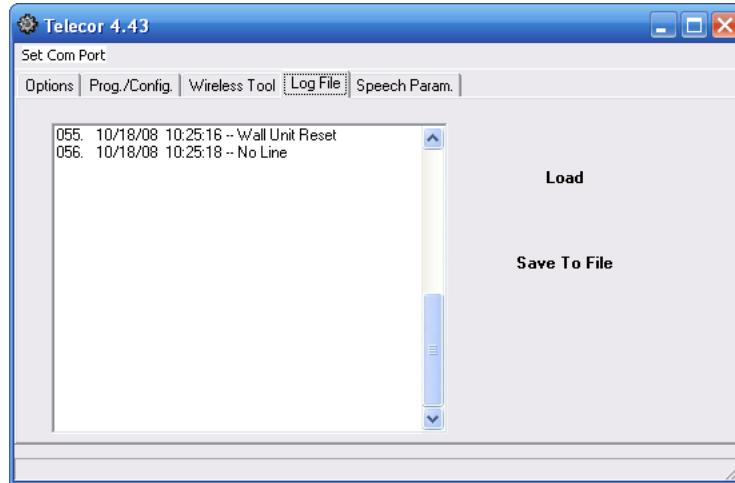

Log File Tab

Click **Load** to download the log file from the resident unit.

Click **Save to File** to save the log file to a disk. Type a file name, then click **Save**.

B.4 Speech Param. Tab

The **Speech Param. Tab** allows you to adjust the resident unit's audio settings. Use this tab to adjust microphone volume, speaker volume, or voice switching settings.

Note: In a majority of installations, these settings do not need to change.

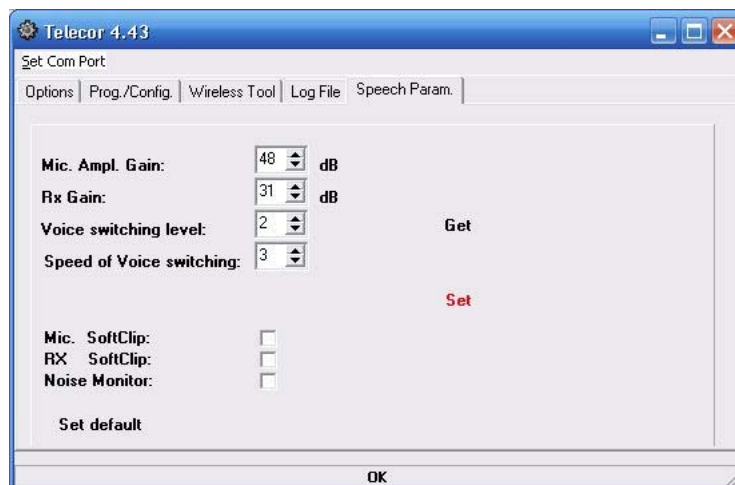

Speech Param.
Tab

Mic. Ampl. Gain: Microphone amplifier gain. This value ranges from 39 to 54 dB and the default is 48 dB. Click the up or down arrows to increase or decrease the microphone volume.

Rx Gain: Speaker gain. This value ranges from 22 to 37 dB and the default is 31 dB. Click the up or down arrows to increase or decrease the speaker volume.

Voice switching level: The noise level required to switch the speaker from talk to listen. This value ranges from from 1 to 4 and the default is 2. Click the up or down arrows to adjust the level.

Speed of Voice switching: Controls the speed of the speaker switching from talk to listen. This value ranges from 1 to 4 and the default is 3. Click the up or down arrows to adjust the switching speed.

Mic. SoftClip: Not used.

RX SoftClip: Not used.

Noise Monitor: Not used.

Click **Set default** to restore the settings to their default values.

Click **Get** to download the settings from the resident unit.

Click **Set** to upload the current settings to the resident unit.

B.5 Creating Dial Strings

This section contains an explanation of a sample dial string when used with a Telecor PBX.

In this example, the dial string in the Primary or Secondary column for a device is made up of six comma-separated parts. The comma indicates a half-second pause. The dial string lets the resident unit notify the phone voice server when a device makes a call. Below is an example primary dial string for the call button:

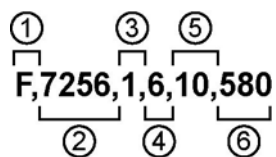

Dial String part 1: The dial string begins with **F**, which performs a hook flash.

Dial String part 2: The resident unit sends the call to an Auto Attendant. In the example, **7256** sends the call to Auto Attendant 19.

Dial String part 3: Notes whether the call is a primary or secondary/rollover call. In the example, **1** is for a primary call and **2** is for a secondary or rollover call.

Dial String part 4: Notes what type of call device is making the call according to the following chart:

Pendant:	1
Wireless Pull Cord:	2
Wired Pull Cord:	3
Sensor:	4
Call Cord:	5
Call Button:	6
Smoke Detector	7
Spare	8

Note: The Resident Unit should only be used as an ancillary notification device for smoke detectors. Ensure that the smoke detector is connected to a code-approved alarming device.

Dial String part 5: Identifies a Page Zone will announce the call. In this example, Page Zone 10.

Dial String part 6: Identifies the station that the call-in will ring. In this example, station 580.

B.5.1 Default Dial String Table

The following table lists default primary and secondary dial strings for each type of call device.

Call Device	Primary Dial String	Secondary Dial String
Wall Unit Call	F,7256,1,6,10,580	F,7256,2,6,11,581
Call Cord	F,7256,1,5,10,580	F,7256,2,5,11,581
Wired Pullcord	F,7256,1,3,10,580	F,7256,2,3,11,581
Pendant	F,7256,1,1,10,580	F,7256,2,1,11,581
Wireless Pull Cord	F,7256,1,2,10,580	F,7256,2,2,11,581
Sensor	F,7256,1,4,10,580	F,7256,2,4,11,581
Smoke Detector	F,7256,1,7,10,580	F,7256,2,7,11,581
Spare	F,7256,1,8,10,580	F,7256,2,8,11,581

Note: The Resident Unit should only be used as an ancillary notification device for smoke detectors. Ensure that the smoke detector is connected to a code-approved alarming device.

B.6 Configuring the Resident Unit for Common Areas

To configure a resident unit to work in a common area, ensure that the **Allow All Wireless** option is checked in the **Prog./Config. Tab** of the programming software.

This will allow the resident unit to receive signals from wireless peripherals (pull cords and pendants) without needing them to be programmed first.

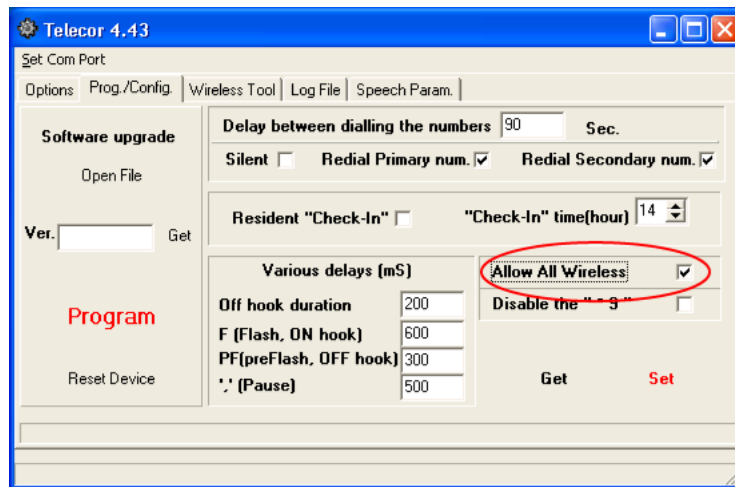

*Prog./Config.
Tab*

C. Installation

This section describes how to install and wire the Resident Unit, Dome Light, and Wired Pull Cord Station. It also explains how to enable the Pendant and Wireless Pull Cord Station for operation. Before installing the Resident Unit, the Dome Light and Wired Pull Cord station must first be installed and connected to the rear of the unit

C.1 Installing Dome Lights

Dome Lights are wall-mounted either above or beside room doorways. The Dome Light measures 4.5" high by 2.75" wide by 1.5" deep. It is mounted to a backbox using the provided two 6-32 x 1" Pan Head Phillips machine screws. The recommended backbox is a Steel City CWLE-3/4 or equivalent.

The connections from the Dome Light to the Resident Unit are shown in the diagram below. Dome Lights are powered by the T3-PSU-4 Power Supply Unit (*see Powering Dome Lights, section C.2*).

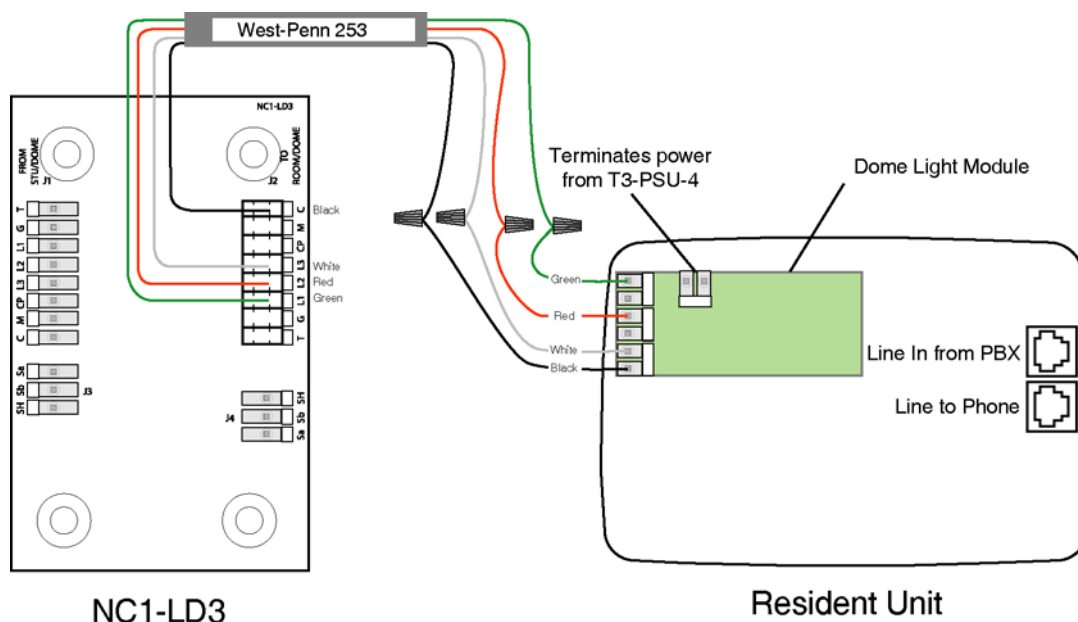

- Material Required:**
- 8-pin Mas-Con Connector Kits without pigtails (purchased separately, part# CK-25-8.1-24)
 - 3 2-pin Mas-Con Connectors with pigtails (provided)
 - Mas-Con Crimping Tool with 0.100" nose (purchased separately, part # MCT)¹
 - West-Penn 253 cable (not provided)

To connect the Resident Unit to the Dome Light, complete the following steps:

1. Connect the three 2-pin Mas-Con connectors with pigtails according to the diagram below.

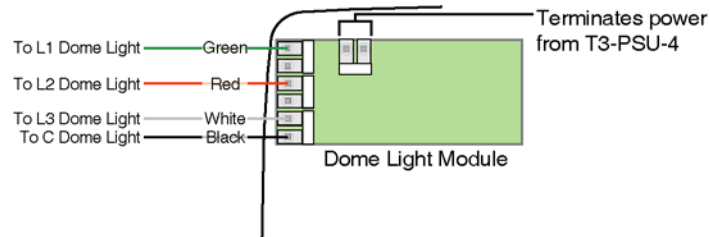

2. Using the 8-pin Mas-Con connector, terminate the wires of the West-Penn 253 cable to the NC1-LD3 dome light according to the diagram below. Connect the green wire to **L1**, the red wire to **L2**, the white wire to **L3**, and the black wire to **C**.

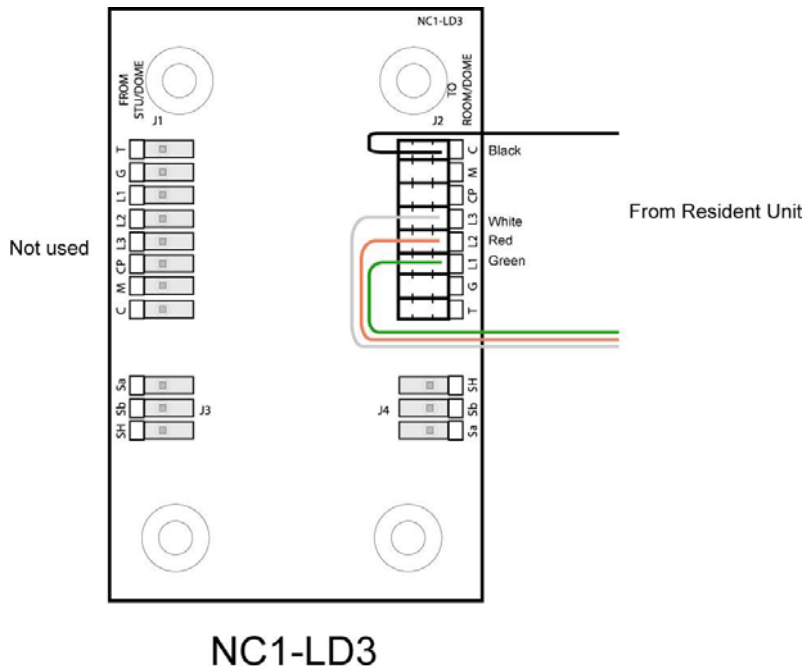

3. Connect the wires from the dome light to the pigtails from the resident unit's dome light module. Refer to the previous page for a diagram.

¹ Telecor offers the Panduit Hand Tool (Part number: MCT-100F), or the Panduit Manual Hand Tool (Part number: MCT) with Nose Section (Part number: CTD-100F).

C.2 Powering Dome Lights

The T3-PSU-4 external Power Supply Unit is a 24VDC, 4A continuous power supply able to power multiple dome lights. The PSU is connected to the Resident Units using a 1-pair 18-gauge stranded cable, with no shield (West Penn 224 or equivalent).

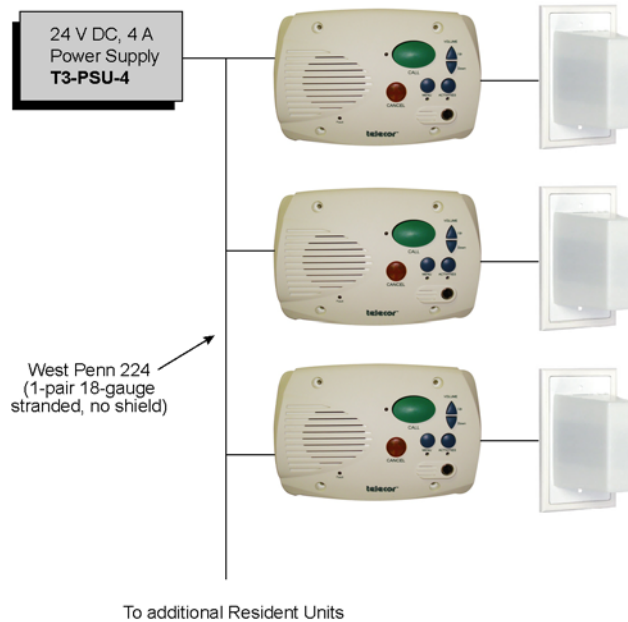

Each NC1-LD3 dome light draws 90 mA. Use the chart below to determine how many Power Supply Units are required for the number of Resident Units.

Dome Lights	PSUs
1-44	1 PSU
45-88	2 PSUs
89-133	3 PSUs

Note: Line loss may be a factor depending on the distance between Resident Units and PSUs. If the wiring length between the devices is great, an additional PSU may be required.

C.3 Mounting the Power Supply Unit

The PSU is wall-mounted using either a Book Mount Kit or Picture Mount Kit. The PSUs are of universal design, allowing for different wall-mounting positions. The PSU must be mounted close to a power outlet.

C.3.1 Book Mount Installation

Materials Required:

- Power Supply Book Mount Kit (purchased separately, part# T3-PSU-WMK-B)
- Two #10 wall-mounting screws with anchors (not provided)
- Four 6-32 1/4" PSU mount screws (provided with mount kit)

1. Place two screws and anchors in the wall corresponding to the Book Mount holes (13" apart). Ensure that the anchors are correctly chosen for the wall material and screw size, and that the wall, screw, anchor combination will securely support the weight of the T3-PSU (7 lbs.)
2. Place the Book Mount over the screws and tighten the screws to secure Book Mount into place.
3. Place the PSU into the Book Mount and secure into place with four PSU mount screws (two screws on each side).

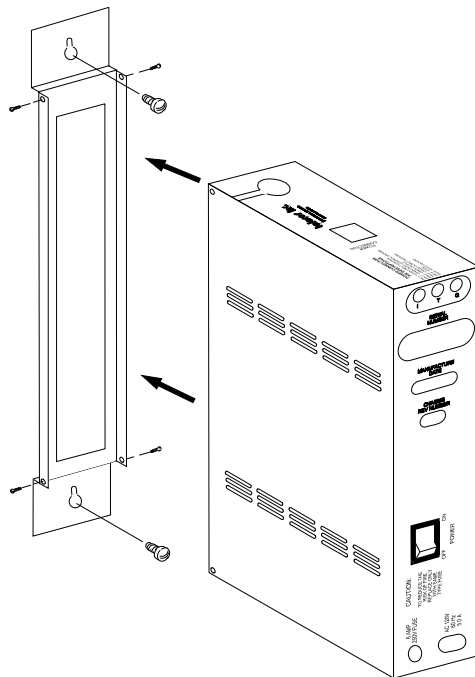

OVERALL DIMENSIONS

10-1/2 inches from wall
14-1/2 inches high (including Book Mount)
2-1/2 inches across

C.3.2 Picture Mount Installation

Materials Required:

- Power Supply Picture Mount Kit (purchased separately, part# T3-PSU-WMK-P)
- Four #10 wall-mounting screws with anchors (not provided)
- Six 6-32 1/4" PSU mount screws (provided with mount kit)

1. Place four screws and anchors in the wall corresponding to the Picture Mount holes (8 3/4" apart horizontal and 8 1/2" apart vertical). Ensure that the anchors are correctly chosen for the wall material and screw size, and that the wall, screw, anchor combination will securely support the weight of the T3-PSU (7 lbs.)
2. Place the Picture Mount frame over the screws and tighten the screws to secure Picture Mount frame into place.
3. Place the PSU into the Picture Mount and secure into place with six PSU mount screws (three screws on each side).

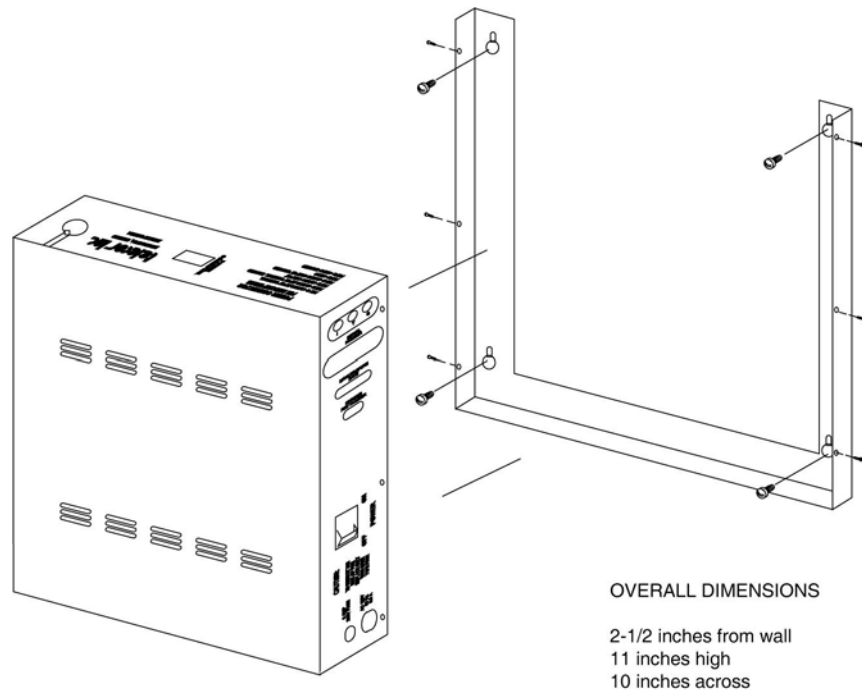

C.4 Connecting PSU to Resident Units to Power Dome Lights

As noted, the T3-PSU-4 external Power Supply Unit is a 24VDC, 4A continuous power supply that powers multiple Dome Lights. Before making any connections with the PSU, first refer to the table on *page C-3* to determine the number of PSUs required for the system. A 2-pin connector with pigtails is provided for connecting the dome light module to the power supply. The PSU connects to additional Resident Units using a 1-pair 18-gauge stranded cable, with no shield (West Penn 224 or equivalent).

1. Splice the +24V wire (RED) from the CHAP-T3-PSU-EXT to the red pigtail wire.
2. Splice the Ground wire (BLACK) from the CHAP-T3-PSU-EXT to the black pigtail wire.
3. Plug the 2-pin connector to the power terminals on the Dome Light Module of the Resident Unit shown in the diagram below.
4. Cap off the unused YELLOW, BLUE, ORANGE, and GRAY wires of the CHAP-T3-PSU-EXT.
5. Run the cable to the next Resident Unit and splice it to the appropriate terminals. Repeat this step for each subsequent Resident Unit.

Note: If another PSU is required along the Resident Unit line, the connections for the subsequent Resident Units are the same.

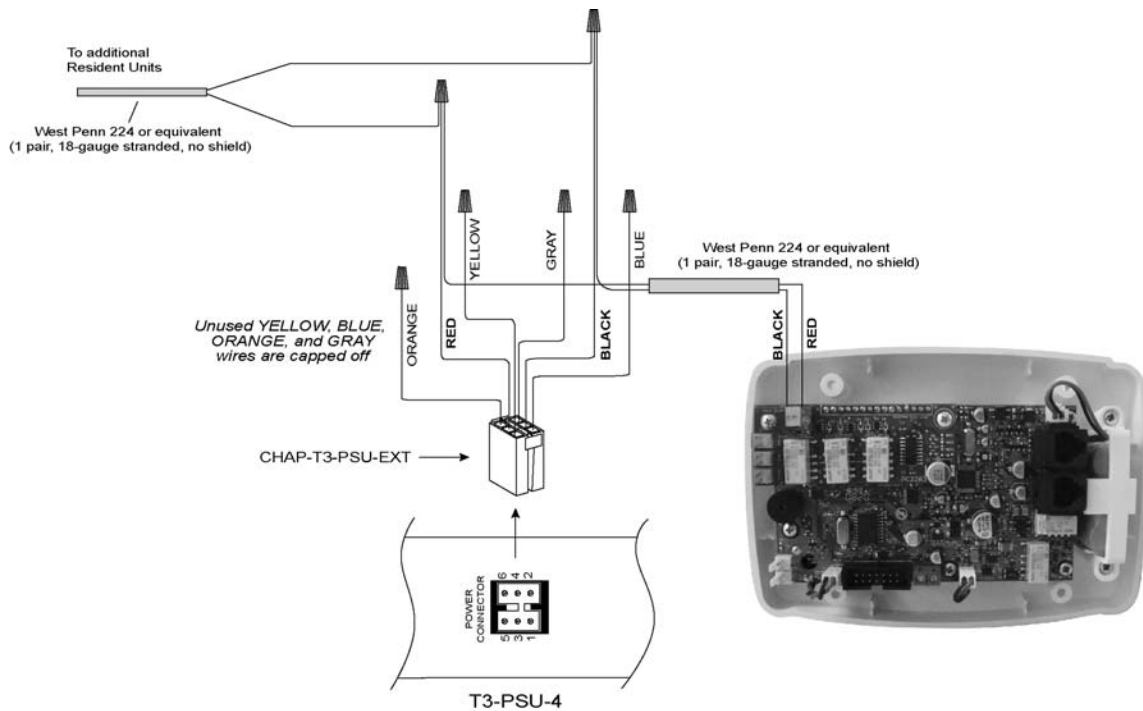

C.5 Installing the Wired Pull Cord Station

The Wired Pull Cord Station is designed for wall mounting onto a standard one-gang electrical box with 3-9/32" mounting centers. The unit connects to the terminals marked **JSW9**, shown in the diagram below.

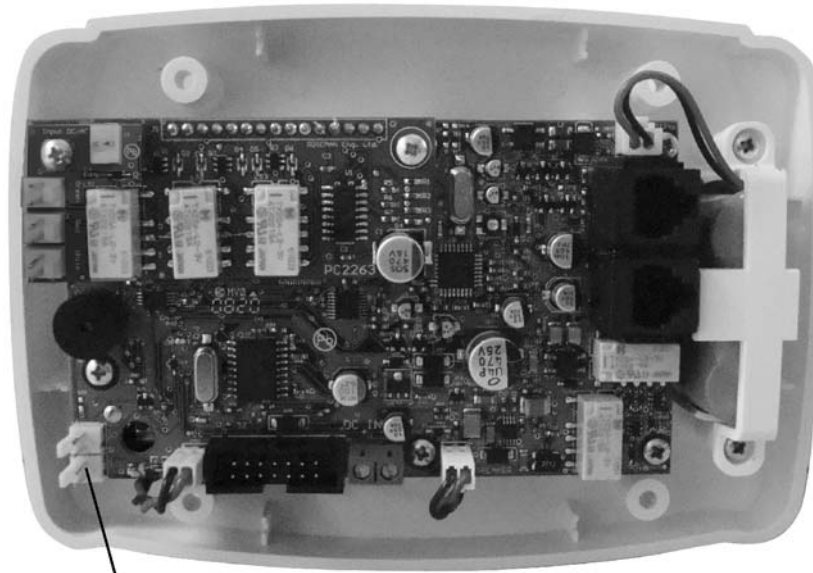

Terminates Wired Pull Cord Station

C.6 Enabling Wireless Pendant or Wireless Pull Cord Operation

To enable a Wireless Pendant or Wireless Pull Cord to operate in conjunction with a VS-600 Resident Unit, complete the following steps:

1. Simultaneously press and hold the **Volume Up** and **Volume Down** buttons on the Resident Unit until you hear a beep.
2. Verify that the **Menu** and **Activities** LEDs are blinking alternately after the beep.
3. For a Wireless Pendant, press its button. For a Wireless Pull Cord, pull the cord. On receiving the wireless device signal, the Resident Unit will play a long beep, and the Fault and Line LEDs will flash once.
4. When finished enabling devices, press **Cancel**.

Note: You can assign up to 4 wireless pendants and 4 wireless pull cords to each resident unit, for a total of 8 devices.

C.7 Wiring a Smoke Detector

The Resident Unit has a connector that supports a normally-open dry contact, such as a smoke detector. The detector connects to the terminals marked **JSW10**, shown in the diagram below.

Note: The Resident Unit should only be used as an ancillary notification device for smoke detectors. Ensure that the smoke detector is connected to a code-approved alarming device.

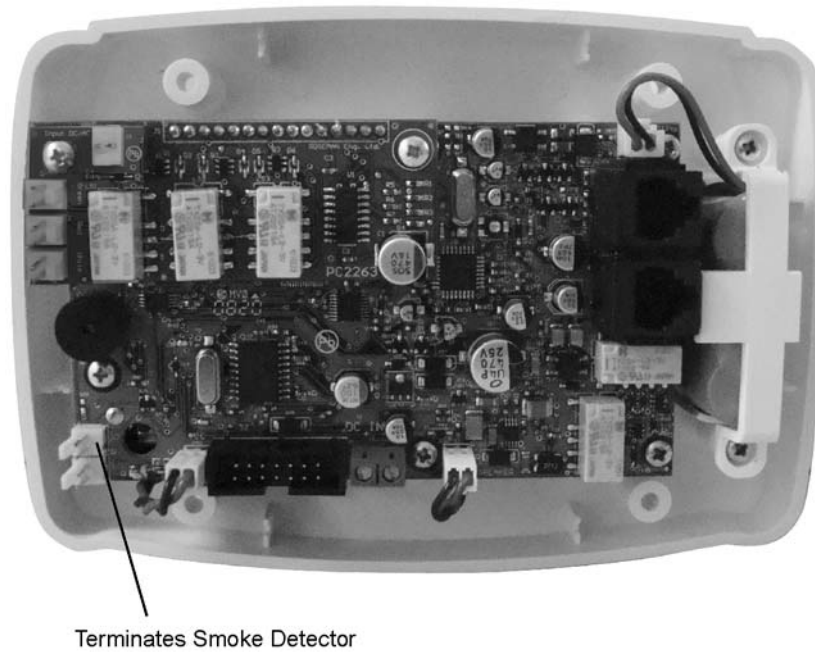

C.8 Wiring and Mounting Resident Unit

Before wiring and mounting a Resident Unit ensure its diagnostic procedure has been performed (*section B.1*) and that it has been properly programmed (*section B.2*).

The VS-600 Resident Units are installed onto standard 3-gang backboxes, with a minimum depth of 2.5". The rear of the unit has two standard RJ-11 jacks. Holding the unit right side up, the upper jack terminates to a PEU station port and the lower jack terminates onto the Tip and Ring terminals on the back of a phone wall plate. The resident telephone then connects to this wall plate. See diagram on next page for overall view of configuration described above.

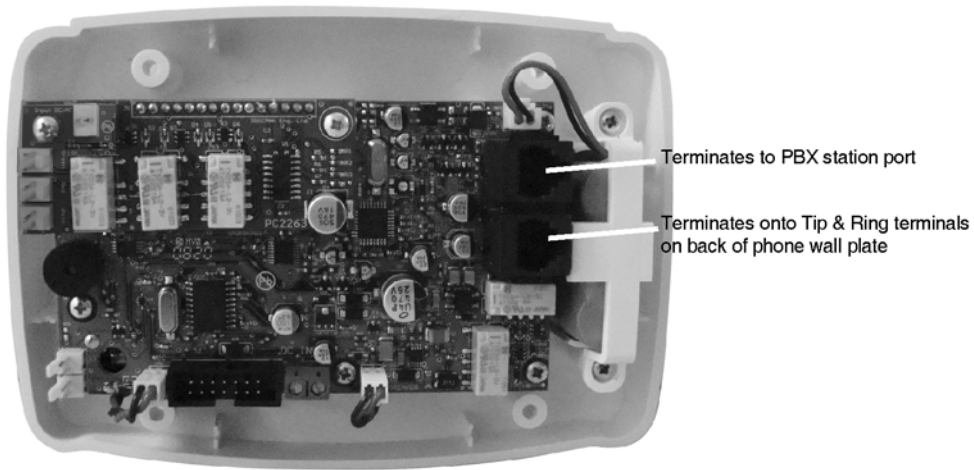

USOC (Universal Service Ordering Code) is the wiring standard that should be followed for installing the Resident Unit. Wiring should adhere to the color code for USOC 2-conductor (analog/voice) telecommunication lines as shown below.

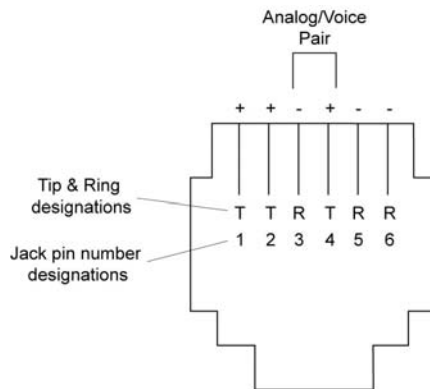

USOC Wiring

Cable	Wall Plate Jack
White w/ blue stripe	Green
Blue w/ white stripe	Red

*Resident Unit
Installation Overview*

