

Thrane & Thrane A/S

Aero-HSD⁺

User Manual

Copyright© Thrane & Thrane A/S

ALL RIGHTS RESERVED

Information in this document is subject to change without notice and does not represent a commitment on the part of Thrane & Thrane A/S.

© 2003 Thrane & Thrane A/S. All rights reserved. Printed in Denmark.

Trademark Acknowledgements:

WinPoET is a trademark of iVasion, a RouterWare Company.

Company addresses:

- Denmark:
Thrane & Thrane A/S,
Lundtoftegårdsvej 93 D,
DK-2800 Lyngby,
Denmark

Tel: +45 39 55 88 00
- USA:
LandSea Systems, Inc.
509 Viking Drive, Suites K, L and M
Virginia Beach, VA 23452
USA

Tel: +1 757 463-9557

Document no. TT98-119959-A.

Release date: 12 December 2003

Table of Contents

1.	About the Manual	7
1.1.	Overview	7
1.2.	Audience	8
1.3.	Software Version.....	8
1.4.	Related Documentation.....	9
2.	Introduction.....	11
2.1.	The Inmarsat Aero Service.....	11
2.1.1.	Overview.....	11
2.1.2.	Service Explanation	14
2.2.	The Aero-HSD ⁺ System	16
2.2.1.	Features	16
2.2.2.	System Components.....	17
2.3.	The Full Feature Handset	21
2.3.1.	Display and LEDs.....	22
2.3.2.	Function Buttons	25
2.3.3.	Alpha-Numeric Buttons.....	29
2.4.	The Auxiliary Handset.....	31
2.4.1.	LEDs.....	32
2.4.2.	Function Buttons	32
2.4.3.	Numeric Buttons	34
2.5.	Other Handset Types	36
2.5.1.	Sigma ⁷ or 2.4 GHz Cordless phone	36
3.	Getting started.....	37
3.1.	Initialising the System.....	37
3.1.1.	To Power on the System.....	37
3.1.2.	To Power off the System.....	38
3.2.	Pin Codes.....	39
4.	Operation	41
4.1.	Menu Navigation.....	41
4.2.	Using the Full Feature Handset.....	43
4.2.1.	Making a H+ Call from the Handset	43

Table of Contents

4.2.2.	Making a Call Using the Phone Book.....	44
4.2.3.	Using the Quick Dial Function	44
4.2.4.	Redialling a Number	44
4.2.5.	Making Internal Calls.....	45
4.2.6.	Transferring a Call.....	46
4.2.7.	Making a Conference Call.....	47
4.3.	Using the Auxiliary Handset	48
4.3.1.	Making a Call.....	48
4.3.2.	Storing a Phone Number.....	49
4.3.3.	Recalling a Phone Number from Memory	51
4.3.4.	Transferring a Call.....	52
4.3.5.	Redialling a Number	52
4.3.6.	Muting the Microphone.....	52
4.4.	Using the Sigma ⁷ Handset.....	53
4.4.1.	Making a Call.....	53
4.5.	Using the 2.4 GHz Cordless Handset	54
4.5.1.	Making a Call.....	54
4.6.	Other Call Functions	55
4.6.1.	Making a Call from an ISDN Phone	55
4.6.2.	Sending a Fax Using H+.....	55
4.6.3.	Sending a Fax Using HSD.....	56
4.6.4.	Calling the Terminal.....	57
4.7.	The Menus.....	58
4.7.1.	Phone Book.....	58
4.7.2.	HandsetSetup	60
4.7.3.	Ring Profile	65
4.7.4.	Lock System.....	65
4.7.5.	Logon Menu	66
4.7.6.	System Setup	73
4.7.7.	Status	84
5.	PC Connection	89
5.1.	ISDN and MPDS Overview	89
5.2.	Setup of Data Equipment	90
5.2.1.	Hardware connection.....	90
5.2.2.	Setting up MPDS via Ethernet and PPPoE.....	92
5.2.3.	Setting up ISDN.....	96
5.2.4.	Setting up a Router.....	100

5.2.5. Setting up a H+ Modem Connection 100

5.3. Connecting to the Network..... 102

6. Troubleshooting..... 103

6.1. Overview 103

6.2. Error codes 104

6.2.1. BITE Errors 104

6.2.2. Cause Codes 105

6.3. List of Cause Codes 106

6.3.1. Logon Cause Codes 106

6.3.2. Cause Codes after Logon..... 108

Appendix A - Menu Tree..... 111

Glossary..... 113

Index 119

This page is intentionally left blank

1. About the Manual

1.1. Overview

Congratulations on purchasing your Aero-HSD⁺ product. The Aero-HSD⁺ system makes it possible for you to communicate from virtually any ocean region in the world using the Inmarsat Swift64 and H⁺ service established by Inmarsat.

This manual has the following chapters:

Chapter **2 Introduction** - an overview of the Inmarsat Aero system and its services. Also a brief description of the Aero-HSD⁺ system.

Chapter **3 Getting started** - a description of how to start up the system and the use of pin codes.

Chapter **4 Operation** - a detailed description of the menu system in the terminal, and a description of the call functions.

Chapter **5 PC** - a description of how to set up a computer for use with the Aero-HSD⁺ system.

Chapter **6 Troubleshooting** - a short troubleshooting guide and a description of the error messages that may appear in the handset. Also a list of Cause codes, and information on where to get further help if necessary.

Appendix A - Menu Tree

1.2. Audience

This manual is a user manual for the Aero-HSD+ System.

The audience of the manual includes aircraft personnel and users of the system.

1.3. Software Version

This manual was written for the Aero-HSD+ System with the following software:

Aero-HSD+ Application Code version 1.01.

1.4. Related Documentation

Apart from the User Manual, the following related documentation applies to the Aero-HSD+ system:

Title	Document Number
Aero-HSD+ Quick Guide Contains short instructions for the daily use of the Aero-HSD+ system.	TT-99-119960
Aero-HSD+ Installation and Maintenance Manual Contains extensive information for the personnel who install the system in the aircraft.	TT-98-113625
Sigma ⁷ Telephone Handset Manual (by International Communications Group)	PN# 500114
2.4 GHz Cordless, Installation Manual (by International Communications Group)	PN# 500484
"AeroROUTER 700" (by International Communications Group)	PN# 500420

This page is intentionally left blank

2. Introduction

2.1. The Inmarsat Aero Service

2.1.1. Overview

The Inmarsat Swift64 (also called High Speed Data or HSD) and H+ services are based on 4 Geo-stationary 3rd generation satellites situated above the equator. Geo-stationary means that the satellites are always located in the same position, i.e. they rotate at the same speed as that of the earth. Each satellite covers a certain area (footprint) and supports a number of powerful spot-beams making the service available in virtually all ocean regions on the earth between approximately 70°N and 70°S.

Note: the ISDN and MPDS services are only available on Aero-HSD⁺ systems when the aircraft is positioned inside an area with Spot Beam coverage.

The 4 Geo-Stationary Inmarsat Satellites

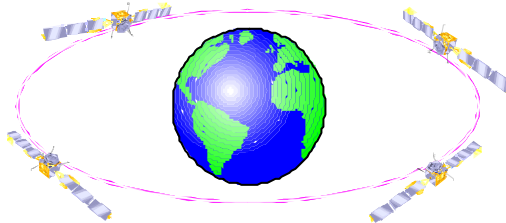

The satellites are your connection to the worldwide networks, and they are managed by the Network Co-ordination Stations (NCSs), run by Inmarsat. The primary

functions of the NCSs are to constantly keep track of which terminals are logged on to the system, and assign a free channel when a call is made.

The gateway between the public network and the satellites is operated by Land Earth Stations (LES) for the high speed data communication or Ground Earth Stations (GES) for the global voice, fax and PC modem data capabilities. The LES and GES are run by different operators around the world.

The services supported by the Inmarsat Fleet comprise:

- **High speed services (64 kbit/s)**
 - 64 kbit/s universal data
 - 56 kbit/s data
 - Speech
 - 3.1 kHz audio
 - MPDS (Mobile Packet Data Service)

- **Low speed services (2.4 kbit/s)**
 - Voice
 - Fax
 - Data
 - Packet Data Channel

For a more detailed explanation of the services, please refer to the section **Service Explanation** on page 14.

The above mentioned services allow for a wide range of applications. Examples are shown below.



Important notice: Before a terminal can be used on the network, it has to be commissioned by one of the Inmarsat Service Providers (ISPs). For further information on commissioning, refer to our site www.tt.dk/aero/isp

2.1.2. Service Explanation

The H+ services have a lower tariff than the high speed services, which are high quality audio or high speed data services and thus require more bandwidth.

2

High Speed Services

The **64 kbit/s UDI** (Unrestricted Digital Information) service enables the bi-directional transmission of data to and from terrestrial 64 kbit/s **ISDN** and **MPDS** networks. The **56 kbit/s DATA** service is similarly used to make a connection to 56 kbit/s ISDN networks, which are primarily used in North America.

The **Speech** and **3.1 kHz audio** services make it possible to establish high quality analogue connections with quality equal to terrestrial analogue connections via digital networks/switches. The **Speech** service is used for high quality voice connections, whereas **3.1 kHz audio** can be used to transfer analogue signals between fax machines and modems with an analogue 2-wire interface. The 3.1 kHz audio service is transparent, and is suitable for all analogue applications including secure telephones.

The **MPDS service** is a packet data service where the tariff depends on the amount of data transmitted. This service is a more cost-effective solution for web browsing, and other applications where there is no need for constant transmission of data in both directions. It is also suitable for applications where a constant connection is required, because the user is no longer charged the "per minute rate".

H+ Services

The H+ service supports near terrestrial-quality **Voice** at 4.8 kbit/s, over two different physical channels in both global- and spot beam. This means that the user is able to have 2 voice connections up at all times. This can be two incoming, two outgoing or one incoming and one outgoing connection. This service is less expensive than an ISDN connection, with only a small cost in voice-quality.

Besides using the two voice-channels for voice, one or both of the channels can be used for a **modem** or **fax** connection. In both circumstances, the maximum bit rate is 2.4kbit/s. The fax or modem can be connected to the two-wire interface. If a fax or modem uses a channel, this channel cannot be used for voice at the same time.

H+ also provides a low speed **packet data** mode, which allows data transfers at up to 1.2 kbit/s. This service can be used by an AFIS, ACARS or CMU to send data over the satellite link.

2.2. The Aero-HSD⁺ System

2.2.1. Features

2

The Aero-HSD⁺ System is a unique multi-channel solution, combining the global voice, fax and PC modem data capabilities of the Inmarsat Aero H+ service with the Inmarsat Swift64 aeronautical High Speed Data service.

The Aero-HSD+ system provides the following features:

- One 64 kbit/s High Speed Data channel
- 2 global voice, fax and PC modem data channels
- 1 channel for cockpit data
- ISDN for large file transmissions, videophone etc.
- MPDS “pay by the bit” – well suited for Internet, e-mails etc.
- RS-422/Ethernet for airborne server/IP router
- STE/STU for secure, encrypted transmissions
- ARINC 741 antenna compatibility
- Small, compact and light-weight system
- Easily upgraded to the next generation Inmarsat high speed satellite platform (BGAN)

2.2.2. System Components

The Aero-HSD+ System includes the following system components:

- TT-5035A Satellite Data Unit (SDU)
- TT-5014A High Power Amplifier (HPA)
- TT-5035A-001 Configuration module (CM)
- TT-5620A Full Feature Handset
- TT-5622A Full Feature Cradle
- TT-5621B Auxiliary Handset
- TT-5622B Auxiliary Cradle
- Accessories (manual, software, etc.)

A minimum working system has at least a TT-5035A SDU, TT-5035A-001 CM, TT-5014A HPA, one TT-5620A Full Feature Handset, one TT-5622A Full Feature Cradle plus a High Gain Antenna system.

A full system may comprise up to six handsets, two of which are using the 2-wire POTS interfaces, which can also be used for faxes, PC modems, headset interface etc.

Instructions on how to assemble the system are found in the Installation and Maintenance Manual, together with specifications and information on wiring.

The Aero HSD+ system with various options



2

The TT-5035A Satellite Data Unit (SDU) and the TT-5014A High Power Amplifier (HPA)



TT-5035A Satellite Data Unit (SDU)

The SDU is the controlling unit of the Aero-HSD⁺ system. A Configuration Module (CM) and all the interfaces, except for the maintenance port, are located on the rear of the TT-5035A Satellite Data Unit (SDU).

TT-5014A High Power Amplifier (HPA)

The High Power Amplifier (HPA) is a Linear High Power Amplifier capable of amplifying the transmission signals of all 4 Aero-HSD⁺ channels simultaneously.

2

TT-5620A Full Feature Handset and TT-5622A Full Feature Cradle

The Full Feature Handset is used to configure the system and to make and receive calls. See section 2.3 for a description of buttons, LED's and display of the handset.



TT-5621B Auxiliary Handset and TT-5622B Auxiliary Cradle

The Auxiliary Handset is used to receive and to make calls.



2.3. The Full Feature Handset

The Full Feature Handset is the primary interface for the Aero-HSD⁺ system. With the Full Feature Handset you can dial numbers, view error and status messages, and configure the transceiver. For information on how to use the full feature handset, see **Using the Full Feature Handset** on page 42.



The Handset is divided into the following 3 inter-working sections.

- The Liquid Crystal Display (LCD) and Light Emitting Diodes (LED) section. This section gives you visual indications about the operation and status of the system.
- The Function buttons section. This section enables you to interact with the software menu system of the transceiver.
- The Alpha-Numeric section. This section enables you to dial and to enter data into the transceiver.

All 3 sections are explained in detail in the following pages.

2.3.1. Display and LEDs

The following picture shows the top of the handset with the display and LEDs. The LCD can be adjusted for contrast and is backlit for viewing in dim light or at night.



The LCD display is graphically shown below:

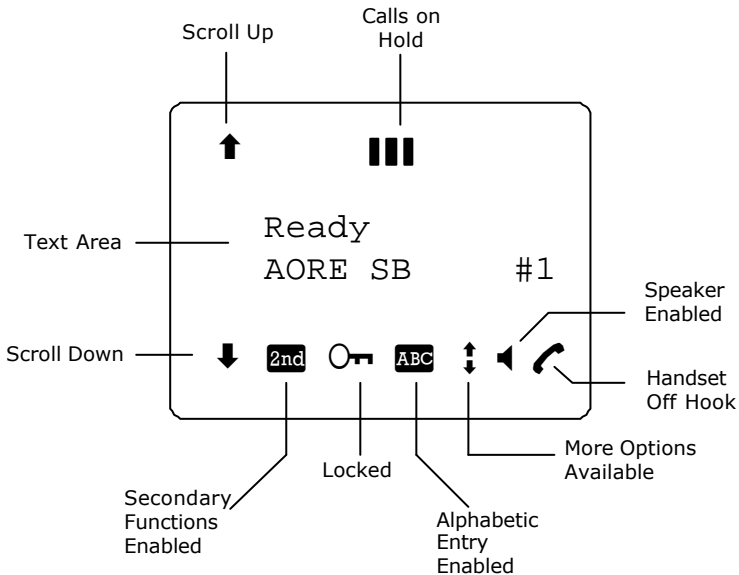





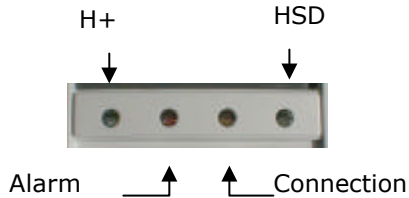









The display contains a set of symbols which, together with the 4 LEDs situated below the display, continuously indicate the current status.

There are four LEDs below the LCD display.



- **H+** LED (GREEN): The H+ LED indicates that the system is logged on to H+ services.
- **Alarm** LED (RED): The Alarm LED illuminates when the system detects a fatal or essential fault. A fault code is also shown in the display.
- **Connection** LED (AMBER): The Connection LED flashes when the handset is ringing. When a connection is established the LED is turned off.
- **HSD** LED (GREEN): The HSD LED indicates that the system is logged on to HSD services.

The below list shows the meaning of each of the various symbols, that may appear in the display.

Symbol	Meaning
	More menu entries above.
	Calls on hold. Each bar represents a call on hold. Example: 3 bars=3 calls on hold.
	More menu entries below.
	The  key has been pressed. The 2 nd function will be used for next button pressed.
	A valid pin code is required to use the terminal.
	The keypad is in alpha mode. Alpha mode is used to enter letters (for example names in the phone book). Note: This symbol does not indicate capital letters. The  button is used to toggle the Caps lock function.
	The value in a menu must be selected between certain predefined values by means of the  and  keys.
	The speaker. You can turn the external speaker on and off by pressing  . The  symbol is displayed in the LCD when the speaker is on.
	The handset is off hook







2.3.2. Function Buttons









The Function buttons enable you to enter the menu system of the transceiver and change various settings.



















2

Each button is described in detail on the following pages.

Symbol	Meaning
	<p>Exit button:</p> <ul style="list-style-type: none">• In the Menu system, pressing Exit brings you back one level until the menu is completely exited.• When you are asked YES or NO by the system, pressing Exit is interpreted as a NO response.• When you are entering data into the transceiver, pressing Exit cancels the entry.
	<p>Speaker button: This button turns the external speaker on and off.</p>
	<p>OK button:</p> <ul style="list-style-type: none">• When in the main screen display, pressing OK enters the menu system.• When in the menu system, pressing OK enters the selected menu.• When entering data, such as phone numbers or pin codes, pressing OK applies the entry.• When you are asked YES or NO by the system, pressing OK is interpreted as a YES response.
	<p>Clear button: This is a dual function button. The primary function is to clear the last entered digit.</p> <p>Secondary function: Insert. This function is accessed by pressing  followed by .</p> <p>The insert function is used to insert new phone book entries, etc.</p>



Symbol	Meaning
	<p>Scroll up button: Also a dual function button. The primary function is to enable you to scroll up to menu items not shown on the 2-line display of the LCD.</p> <p>Secondary function: Edit. Allows you to edit previously entered information, for example phone book entries.</p>
	<p>The primary function of this button is to toggle between normal mode and alpha numeric mode.</p> <p>Secondary function: Delete. Allows you to delete previously entered information, for example phone book entries.</p>
	<p>The 2nd function of the next key pressed will be applied.</p>
	<p>Scroll down button: The primary function is to enable you to scroll down to menu items not shown on the 2-line display of the LCD.</p> <p>Secondary function: Mute turns the handset microphone on/off.</p>
	<ul style="list-style-type: none"> • When pressed after a number,  initiates a call. • When pressed during a phone call,  ends the call. • When pressed without a connection and without any numbers entered,  shows a list of the ten last dialed numbers. When pressed again,  dials the selected number.



A number of keys have a 2nd function. The following table gives a total overview of all the 2nd functions.

Key	Function
 	Enters the top level of the menu system.
 	Transfers the call to a specified handset.
 	Places a call on hold.
 	Joins other handsets to a call.
 	Inserts an entry, for example in the phone book.
 	Edits an existing entry, for example in the phone book.
 	Deletes an existing entry, for example in the phone book.
 	Mute. Turns the handset microphone on/off.

2.3.3. Alpha-Numeric Buttons

The keypad can be in normal (numeric) mode or alpha mode. Normal mode is used to enter digits (phone numbers) whereas alpha mode is used to enter letters (such as names in the phone book).

The  button is used to switch between the two modes. The  symbol in the display indicates that the handset is in alpha mode. In alpha mode you can use each of the numeric keys and the  button to select between subsets of the alphabet and certain special characters.

To enter a character, press the key a number of times until the wanted character is shown in the display. For example, to insert the letter C, you press the  button 3 times in alpha mode. The  button is used as a Caps lock toggle when the handset is in alpha mode.



Below is an overview of the relevant keys in alpha mode.

Key Available characters or functions in alpha mode

 - ? ! , . : ' \$ () + / 1

 A B C 2

 D E F 3

 G H I 4

 J K L 5

 M N O 6

 P Q R S 7

 T U V 8

 W X Y Z 9

 Special function

 <space>

 Caps lock toggle

2.4. The Auxiliary Handset

The auxiliary handset provides an optional interface for voice calls.

For information on how to use the auxiliary handset, see Using the Auxiliary Handset on page 48.



The auxiliary handset is divided into the following 3 sections.

- The Light Emitting Diodes (LED) section. This section gives you visual indications about the operation and status of the system.
- The Function buttons section. This section gives you access to a few call functions, such as transfer of calls, memory etc.
- The Alpha-Numeric section. This section enables you to dial numbers.

All 3 sections are explained in detail in the following pages.

The auxiliary handset also provides a volume control placed on the side of the handset.

2

2.4.1. LEDs

There are two LEDs on the auxiliary handset.

The left green LED lights constantly when the handset is off-hook.















The right green LED flashes to indicate that the handset is ringing. When a connection is established, the LED is turned off.

2.4.2. Function Buttons

The function buttons enable you to transfer calls, redial, store and recall phone numbers, and mute the microphone.



Each button is described in detail below.

Key	Function
	Store number. This button is used to store phone numbers.
	Memory. This button is used to recall phone numbers from the memory.
	Transfer call. This button is used to transfer an incoming call to another handset.
	Memory location 1. (Same function as  )
	Memory location 2. (Same function as  )
	Memory location 3. (Same function as  )
	Redial. This button is used to redial the last dialled number.
	Mute. This button is used to mute the microphone.
	Toggle hook. This button is used to toggle between on-hook and off-hook.

2.4.3. Numeric Buttons

The numeric buttons are primarily used to dial numbers or to enter numbers to be stored into the memory.





Below is an overview of the relevant numeric keys.

Key Available Characters or Functions

1	1
2 _{abc}	2 a b c
3 _{def}	3 d e f
4 _{ghi}	4 g h i
5 _{jkl}	5 j k l
6 _{mno}	6 m n o

Key Available Characters or Functions

 7 p q r s

 8 t u v

 9 w x y z

 * Special function

 0

 # This button is used to indicate the end of a phone number/activate a call.



2.5. Other Handset Types

For information on other types of handset, see the User Manual for the handset.

2.5.1. Sigma⁷ or 2.4 GHz Cordless phone

For information on how to make a call using the Sigma⁷ or 2.4 GHz Cordless phone, refer to the sections **Using the Sigma7 Handset** on page 53 and **Using the 2.4 GHz Cordless Handset** on page 54.

3. Getting started

3.1. Initialising the System

3.1.1. To Power on the System

The Aero-HSD+ system is powered by the aircraft power system, and is powered up along with the aircraft.

The display and all LED's on the handset will light up for a few seconds.

Below is an example of the normal readout of the handset display, while the SDU is booting.

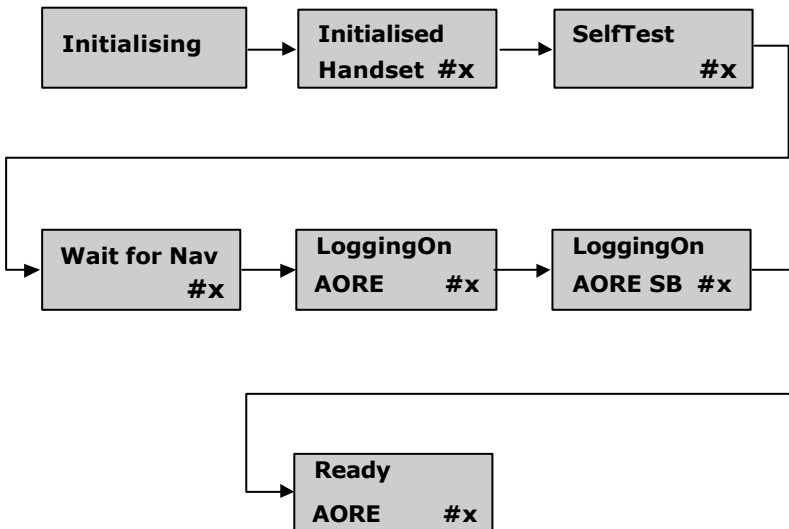

When the display shows "Ready", the system is ready to use.

The H+ LED indicates that H+ services are logged on, and the HSD LED indicates that HSD services are logged on.

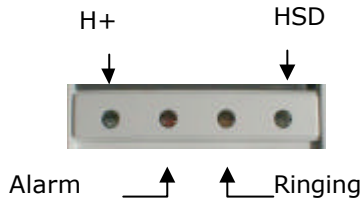

3

Note: If the system does not log on automatically, the reason may be that the Logon policy is set to User Demand. In this case you have to log on using the Logon menu. For further information, see Logon Menu on page 66.

3.1.2. To Power off the System

The system is automatically powered off along with the aircraft.

Some aircrafts are provided with a "SatCom on/off" button, which can be used to power off the system while the aircraft is powered.

If the aircraft does not provide a "SatCom on/off" button, you can use the circuit breaker to power off the system.

3.2. Pin Codes.

For some of the functionality of the terminals, access is restricted by a pin code. Three different kinds of user pin codes are used in the system:

- one pin code for the Normal user,
- one for the Super User and
- one for the Service Provider.

Common for all pin code types is that the length must be between 4 and 8 digits and that they contain digits between 0 and 9.

Normal User Pin code

The normal everyday user can make and receive calls, access the phone book, choose an ocean region and a default LES and GES, and read the alarm log and status.

A Normal User will typically be the day-to-day user of the system. All additional setup has to be carried out by a Super User or a Service Provider.

Super User Pin code

The Super User has the same rights as the Normal User. In addition, the Super User can access certain super user functions. A Super User will typically be a person responsible for setting up and maintaining the system.

Service Provider Pin code

The Service Provider has access to all functionality accessible through the handset.

Only Thrane & Thrane and/or the supplier of the equipment normally know this pin code.

3

This page is intentionally left blank

4. Operation

4.1. Menu Navigation

This section describes how to access the menu system using the buttons and display of the Full Feature Handset.

To access the menus, press **OK** or **2nd** **1^{Menu}**.

When you are in the menu system you may also press **2nd** **1^{Menu}** to reach the top level of the menus.

To scroll through the menus, use the **↑Edn** and **↓Mute** keys.

To enter the selected menu, press **OK**.

To go back to the previous level in the menu system, press **Exit**.

To reach a specific item in the menu system, press **2nd** **1^{Menu}** and a number corresponding to the entry level.

Example: Press **2nd** **1^{Menu}** **5_{jkl}** to access the 'Logon' menu (which is the 5th entry in the main menu).

There are 4 different levels of access to the menus:

- Users without a pin code
- Normal User
- Super User
- Service Provider.

The normal everyday functions can be used without entering any pin codes.

The **Normal User** has access to normal everyday functions and to make changes to these.

A **Super User** has the same rights as the Normal User, but can additionally access a few extra settings that are not available to the Normal User.

The **Service Provider** menu can only be accessed by the supplier or Thrane & Thrane.

The Normal User, Super User and Service Provider menus are protected by pin codes. You will be prompted for a pin code when entering a function that is restricted by pin codes.

The complete Menu Tree is found in Appendix A - Menu Tree.

All the menus are described in The Menus on page 58.

4.2. Using the Full Feature Handset

Any call made from the system uses one of the service types H+ voice, ISDN or 3.1 kHz audio.



Before making a call, make sure the display shows "Ready" and that the service LEDs (H+ and/or HSD) are lit.

4.2.1. Making a H+ Call from the Handset

The service type used for a call from the handset is the service type configured as default for this handset and the LES or GES operator used will be the default LES or GES operator.

To make a call from the Full Feature handset, type in the phone number as if you were making an international call (with the prefix 00 for automatic international calls).

Example: To dial the number of Thrane & Thrane (+45 39558800), press the number:

0 0 for international calls, 4^{Fax} 5^R for country code, then 3^{Aren} 0^{Ani} 5^R 5^R 8^{Tuv} 8^{Tuv} 0 0, followed by ,  or . The display on the terminal handset shows how the call proceeds.

You hang up by pressing . After hanging up, the display shows the duration of the call.

Example:

**Connected:
00:01:59**





The Phone Book can also be used to initiate a call, either by selecting an entry in the phone book or by using the Quick Dial function.

4.2.2. Making a Call Using the Phone Book



The phone book can be used to initiate a call.

For information on how to insert or edit entries in the phone book, see Phone Book on page 58.



To make a call using the phone book, do as follows:

1. Press  or  to access the phone book from the main display, or enter the menu system and select PhoneBook.
2. Find the entry you need, either by scrolling the list with  or , or by pressing  followed by the first letter of the entry.





Example: To find an entry with the name Jones, press  followed by .

3. Press ,  or  to dial the selected number.

4.2.3. Using the Quick Dial Function

To use the Quick Dial function, press one of the  →  keys and hold it down for 1 sec. Each key is a shortcut to a user-defined entry in the phone book. For further information, see the section **QuickDial** on page 78.

4.2.4. Redialling a Number

To call the last used number, press  to show a list of the last ten numbers dialled from the handset. Scroll through the list and press ,  or  to establish a call to the selected number.

4.2.5. Making Internal Calls

It is possible to make internal calls between any of the POTS phones and Full Feature handset interfaces.

To initiate an internal call, press the interface code in the table below followed by .

Note: The Interface Code is shown in the right bottom corner of the display of the Full Feature Handsets.

Interface	Interface Code
Full Feature Handset #1	1
Full Feature Handset #2	2
Full Feature Handset #3	3
Full Feature Handset #4	4
POTS phone #1	5
POTS phone #2	6

Example: To call Full Feature Handset number 3, press

 .





To make an internal call to all handsets,

press    .

4.2.6. Transferring a Call

It is possible to receive a call on a handset and transfer the call to another handset.

Use the following procedure to make a Call transfer:

1. When an incoming call is received, answer the call as usual with  or simply lift the handset from the cradle.
2. Place the call on hold with .
3. Dial the Interface Code of the desired handset, e.g.  for Handset #2.
4. Initiate handset to handset call with . You have now established an active call from handset to handset, and you can give a short message.
5. Route the incoming call to the new handset with , or by just placing the handset in the cradle.

4.2.7. Making a Conference Call

It is possible to make conference calls between more handsets.

Use the following procedure to make a Conference Call.

4. When a call is already established, place the call on hold with **2nd** **0**^{hold}.
5. Dial the desired handset e.g. **2**_{abc} for handset #2.
6. Initiate handset to handset call with **#**^{join}.
7. Join all three handsets with **2nd** **#**^{join}.

To join more handsets, repeat step 1 to 4.

4.3. Using the Auxiliary Handset

4.3.1. Making a Call

Making a call from a normal 2-wire POTS phone connected to one of the two analogue POTS phone interfaces is done in the same way as a call from a standard telephone. Just remember to press the -key after the number to signal to the terminal, that the number is complete.

Example: To call Thrane & Thrane in Denmark (country code 45) first establish a connection by pressing  or taking the handset off the cradle. Then press the following keys on the phone:

            

Internal calls are made the same way as with the Full Feature handset. For information on how to make an internal call between the handsets, see Making Internal Calls on page 45.













4.3.2. Storing a Phone Number

The auxiliary handset can store up to 10 phone numbers, in memory location 0 to 9. The **M1**, **M2** and **M3** keys can be used for accessing memory location 1, 2 and 3, whereas the other locations are accessed using the MEM key followed by the number of the location.



To store a phone number in the memory using the **M1**, **M2** and **M3** keys, do as follows:

1. Press  or take the handset off the cradle.
2. Press **STO**.
3. Enter the phone number you want to store, including country code.
4. Press **STO**.
5. Press **M1**, **M2** or **M3** depending on the memory location you want to save the number in.
The number is now available in the memory location you selected.

Example: To save the phone number of Thrane & Thrane in memory location 2, take the handset off the cradle and press the following keys:

STO
           
STO
M2

To store a phone number in the memory using the number keys, do as follows:

1. Press  or take the handset off the cradle.
2. Press .
3. Enter the phone number you want to store, including country code.
4. Press .
5. Press one of the keys 0 to 9, depending on the memory location you want to save the number in. The number is now available in the memory location you selected.

Example: To save the phone number of Thrane & Thrane in memory location 8, take the handset off the cradle and press the following keys:



           







4.3.3. Recalling a Phone Number from Memory

To recall a phone number from memory location 1, 2 or 3 using the **M1**, **M2** and **M3** keys, do as follows:

1. Press  or take the handset off the cradle.
2. Press **M1**, **M2** or **M3**, depending on which memory location you want.
The number saved in the memory location is dialled.

Example: To call the number saved in memory location 3, first establish a connection by pressing  or taking the handset off the cradle. Then press **M3**. The number saved in memory location 3 is dialled.

To recall a phone number from memory using the **MEM** key, do as follows:

3. Press  or take the handset off the cradle.
4. Press **MEM** followed by the number of the memory location you want.
The number saved in the memory location is dialled.





Example: To call the number saved in memory location 8, first establish a connection by pressing  or taking the handset off the cradle. Then press **MEM** **8_{tuv}**. The number saved in memory location 8 is dialled.

Note: Pressing **M1** has the same effect as pressing **MEM** **1**.

4.3.4. Transferring a Call



It is possible to receive a call on a handset and transfer the call to another handset.

Use the following procedure to make a Call transfer:



6. When an incoming call is received, answer the call as usual with  or simply lift the handset from the cradle.
7. Place the call on hold with .
8. Dial the Interface Code of the desired handset, e.g.  for Handset #2.
9. Initiate handset to handset call with .
You have now established an active call from handset to handset, and you can give a short message.
10. Route the incoming call to the new handset by pressing , or placing the handset in the cradle.

4

4.3.5. Redialling a Number

To call the last dialled number, first establish a connection by pressing  or taking the handset off the cradle. Then press  followed by .

4.3.6. Muting the Microphone

To mute the microphone of the handset, press . To return to normal microphone function, press  again.

4.4. Using the Sigma⁷ Handset

4.4.1. Making a Call

To make a call using the Sigma⁷ handset, type in the phone number as if you were making an international call (with the prefix 00 for automatic international calls), and press the "On" key.

Example: To dial the number of Thrane & Thrane (+45 39558800), press the number:

"00" for international calls, "45" for country code, then "39558800", followed by the "On" key.

To hang up, press the "Off" key or place the handset in the cradle.

To answer a call, press the "On" key.

For further information on the functions of the Sigma⁷ handset, refer to:

"Sigma⁷ Telephone Handset Manual", PN# 500114

4.5. Using the 2.4 GHz Cordless Handset

4.5.1. Making a Call

To make a call using the 2.4 GHz Cordless handset, type in the phone number as if you were making an international call (with the prefix 00 for automatic international calls), and press the "TALK" key.

Example: To dial the number of Thrane & Thrane (+45 39558800), press the number:

"00" for international calls, "45" for country code, then "39558800", followed by the "TALK" key.

To hang up, press the "END" key or place the handset in the cradle.

To answer a call, press the "TALK" key.

For further information on the functions of the 2.4 GHz Cordless handset, refer to:

"2.4 GHz Cordless, Installation Manual", PN# 500484

4.6. Other Call Functions

4.6.1. Making a Call from an ISDN Phone

Making a call from a phone connected to the ISDN interface is similar to making a call from the POTS handset, that is, you have to press  to indicate the end of the number.

Example: To call Thrane & Thrane in Denmark (country code 45) first establish a connection by pressing .or taking the handset off the cradle. Then press the following keys on the phone:









4.6.2. Sending a Fax Using H+

Important: Before sending or receiving fax messages, make sure the ground fax unit is in "Overseas" mode.

Your installation determines whether your fax unit uses H+ or HSD.

To send a fax from one of the two analogue POTS phone interfaces, use the prefix 01 followed by the called fax number including the country code, followed by .

Example: To call Thrane & Thrane in Denmark (country code 45) press the following keys on the fax:

4.6.3. Sending a Fax Using HSD

Important: Before sending or receiving fax messages, make sure the ground fax unit is in "Overseas" mode.

Your installation determines whether your fax unit uses H+ or HSD.

To send a fax using HSD (e.g. via ISDN)::, use the prefix 00 followed by the called fax number including the country code, followed by .

Example: To call Thrane & Thrane in Denmark (country code 45) press the following keys on the fax

0 0 4 5 3 9 5 5 8 8 8 8 #

4.6.4. Calling the Terminal

Calling the terminal or a device connected to the terminal is similar to making international calls. The specific Inmarsat Mobile Number (IMN)¹ has to be preceded by one of the five possible international access codes. This code depends on whether you know which area the terminal is within or not:

870: Area of terminal not known
(Requires that the LES or GES supports Mobility Management).

871: AORE

872: POR

873: IOR

874: AORW

To call the IMN-number on a terminal situated in IOR, dial +873 followed by the IMN number (where the “+” stands for the IDD (International Direct Dialing) Prefix – which is 00 for many countries).

The different IMN numbers can be obtained from the ISP.

¹ A terminal may have more IMN numbers, as different services exist and more devices may be connected to the different hardware interfaces of the terminal.





4.7. The Menus

This section describes each of the menus in the system. For an overview of all the menus, see Appendix A - Menu Tree.

4.7.1. Phone Book

The **Phone Book** contains 99 entries, which can be used for making phone calls. You can edit, delete or insert entries.

To access the Phone Book menu, you can:

- press  or  from the main display, or
- press  to enter the main menu, scroll to **Phone Book** and press .

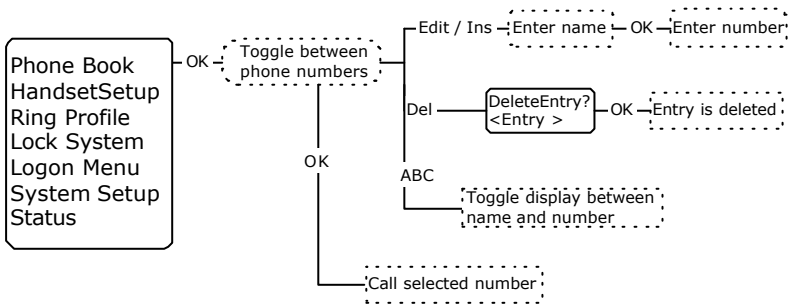

Each entry holds the following information:



- Name
- Telephone number

The telephone number must include call prefix for automatic calls and international access code. The telephone number can hold up to 24 digits.

The name can hold up to 24 characters.





The list of entries in the phone book is sorted alphabetically.

An entry in the phone book is displayed as a name if in alpha mode or as a telephone number if in normal mode.

To dial from the phonebook, use   to select an entry and press ,  or  to dial.

Hint: You may also go directly to a specific entry by pressing  followed by the first letter of the entry.

To insert a new entry in the phone book, do as follows:

1. From within the Phone Book menu, press   and enter the name of the new entry followed by .
2. Enter the phone number including country code and press .





Example: In this example the number to Thrane & Thrane, 004539558800, is inserted.

THRANE 



You **edit or delete an entry** by selecting the entry in the phone book and pressing   or   respectively.

4.7.2. HandsetSetup

The **HandsetSetup** menu is used for adjusting the light and sound settings of the handset.

The **HandsetSetup** menu has the following submenus:



- Silent
- Contrast
- Light
- Key Beep
- Single Ring
- Common Ring
- Ring Volume
- Phone Volume
- ComfortNoise

Each of the submenus is described in the following pages.

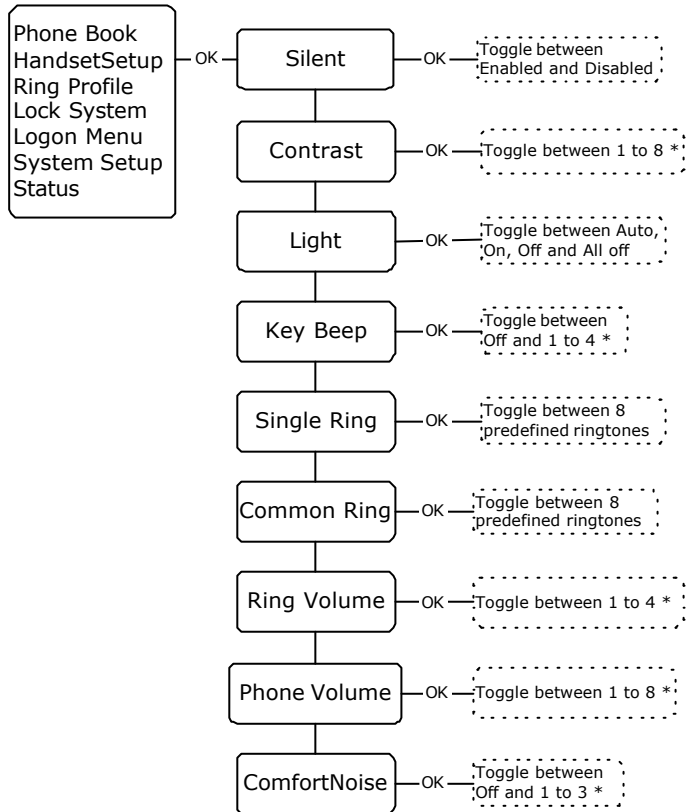

To access the HandsetSetup menu, enter the main menu, scroll down to **HandsetSetup** and press **OK**.



Silent: Select Silent to view or change the Silent setting of the handset.



Use  and  to toggle between Enabled and Disabled. Enabled turns off the ring tone of the handset.

Contrast: Select Contrast to view or change the contrast setting of the handsets.

Use  and  to adjust the contrast and  to confirm.

The value can be between * and *****.

Light: Select Light to view or change the light setting of the handsets.

Use  and  to scroll between the settings and  to confirm..



The value can be Auto | On | Off | All Off.

The following table shows the function of the light settings.

Setting	Display Backlight	LEDs
Auto	Activated on event	Normal function
On	Always on	Normal function
Off	Always off	Normal function
All Off	Always off	Always off



Key Beep: (A “beep” sound when a key is pressed).

Select Key Beep to view or change the Key Beep setting of the handsets.

Use  and  to adjust the Key Beep and  to confirm..



The value can be Off or between * and ****.

Single Ring (Direct call ring tone): Select Single Ring to view or change the ring tone setting of the current handset.

Use  and  to scroll through the ring tones and  to select.



You can choose between 8 predefined ring tones.

Common Ring (Broadcast call ring tone): Select Common Ring to view or change the common ring tone setting of all the handsets.

Use  and  to scroll through the ring tones and  to select.



You can choose between 8 predefined ring tones.

Ring Volume: Select Ring Volume to view or change the Ring Volume setting of the handset.

Use  and  to adjust the Ring Volume and  to confirm.



The value can be Off or between * and ****.

Phone Volume: Select Phone Volume to view or change the Volume setting for the phones.

Use  and  to adjust the Phone Volume and  to confirm.

The value can be Off or between * and ****.

ComfortNoise: (A background noise to verify that the line is connected). Select ComfortNoise to view or change the Comfort Noise setting of the handset.

Use  and  to adjust the Comfort Noise and  to confirm.

The value can be Off or between * and ***.

4.7.3. Ring Profile

The **Ring Profile** menu allows you to select from a list of predefined ring profiles. A ring profile applies to the entire system and determines the ring settings of each unit in the system.

To access the Ring Profile menu, enter the main menu, scroll down to **Ring Profile** and press **OK**.

Use **↑^{Edit}** and **↓^{Mute}** to scroll through the ring profiles and **OK** to select.

Note: If the "Chime/Lamps Inhibit" function is used in the installation, the "TakeOfLandng" profile is automatically activated during takeoff and landing.

For information on how to change the ring profiles, see the section System Setup on page 73.

4.7.4. Lock System

The **Lock System** menu can be used to lock the phone.

Do as follows:

To lock the phone, enter the main menu, scroll down to **Lock System**, press **OK** and enter the Normal User Pin code.

To unlock the phone, press **OK** and enter the Normal User Pin code.

4.7.5. Logon Menu

The **Logon Menu** is used to log on or off the system, or to change the Logon settings.

The **Logon Menu** has the following sub menus:

- Manual Logon
- Custom Logon
- Auto Logon
- Renew Logon
- Logoff
- Settings (see Settings on page 68)

To access the Logon Menu, enter the main menu, scroll down to **Logon Menu** and press **OK**.

4

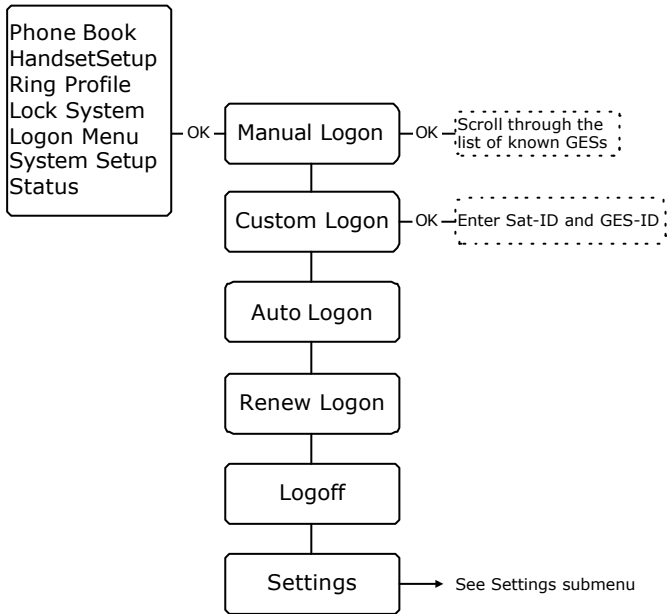

Manual Logon:

Note: Before logging on manually, make sure the Logon Policy is set to User Demand. To change the Logon Policy, select Settings from the Logon menu and then Logon Policy. You can toggle between User Demand and Automatic and select with **OK**.

Select **Manual Logon** to select the GES manually from the list of known GESs.

Use **↑** Edit and **↓** Mute to scroll through the list and **OK** to select.

Custom Logon:

Note: Before making a Custom Logon, make sure the Logon Policy is set to User Demand. To change the Logon Policy, select Settings from the Logon menu and then Logon Policy. You can toggle between User Demand and Automatic and select with **OK**.

Select **Custom Logon** to manually enter the Sat-ID and GES-ID you want to use for logging on.

For instance, you can use this menu if you need to log on to a GES which is not in the list of known GESs.

Enter the Sat-ID and GES-ID and press **OK** to confirm.

Auto Logon: Select **Auto Logon** to log on automatically to the most appropriate GES.

Renew Logon: Select **Renew Logon** to log off and then on again.

Logoff: Select Logoff to log off the system. To log on again you have to use the logon menu.

Settings: See the section Settings on page 68.

Settings

From the Settings submenu you can change the logon policy and view or change the lists of preferred GESs and LESs.

The **Settings** menu has the following sub menus:



- Logon Policy
- H+ GES
- ISDN LES
- MPDS LES

Each of the submenus is described in the following pages.

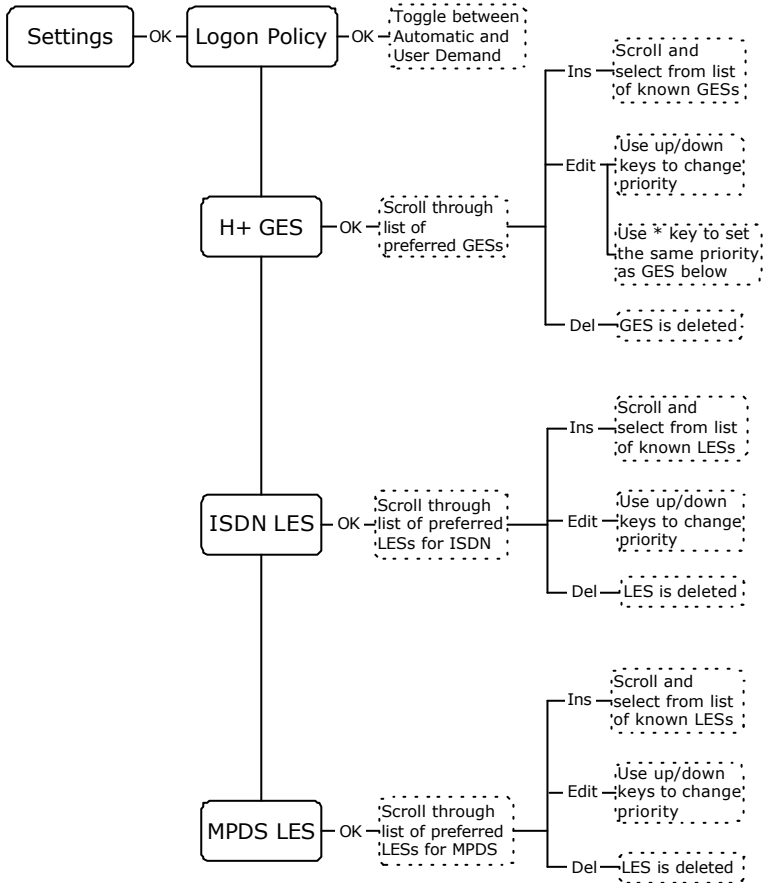
To access the Settings submenu, enter the **Logon Menu**, scroll down to **Settings** and press **OK**.



Logon Policy: Select **Logon Policy** to display or change the logon policy.









Use  and  to toggle between Automatic and User Demand.

- **Automatic:** The system automatically logs on when it is powered up.
- **User Demand:** When the system is powered up you have to enter the Logon menu to log on to the system.

H+ GES: Select **H+ GES** to view or change the list of preferred GESs for H+ transmission.

The H+ GES list is a list of the preferred GES operators to use as gateway to the terrestrial network.

Important: If you are using the list of preferred GESs you must always select at least one GES from each Ocean region with top priority, i.e. with the same priority as the GESs of the other ocean regions.

1. To **add a GES** to the list, press  , scroll through the list of known GESs and use  to select the GES you want to add.
2. To **delete a GES** from the list, scroll to the GES you want to delete and press  .
3. To **change the priority** of a GES, scroll to the GES you want to change and press  . Use  or  to move the GES to the right priority.

Note: Priority no. 1 is the highest priority!

4. To **assign the same priority** to two GESs, do as follows:

- Scroll to the GES you want to change and press **2nd** **↑** *Edit*.
- Move the GES to just above the GES with the priority you want.
- Press **2nd** **↑** *Edit* followed by **Route**.
The two GESs should now have the same priority.

ISDN LES: Select **ISDN LES** to view or change the list of preferred LESs for ISDN transmission. The ISDN LES list is a list of the preferred LES operators to select as gateway to the terrestrial network.

1. To **add a LES** to the list, press **2nd** **C** *Ins*, scroll through the list of known LESs and use **OK** to select the LES you want to add.
2. To **delete a LES** from the list, scroll to the LES you want to delete and press **2nd** **Ⓚ** *Del*.
3. To **change the priority** of a LES, scroll to the LES you want to change and press **2nd** **↑** *Edit*. Use **↑** *Edit* or **↓** *Mute* to move the LES to the right priority.

Note: Priority no. 1 is the highest priority!

MPDS LES: Select **MPDS LES** to view or change the list of preferred LESs for MPDS transmission. The MPDS LES list is a list of the preferred LES operators to select as gateway to the terrestrial network

1. To **add a LES** to the list, press **2nd** **C/Ins**, scroll through the list of known LESs and select the LES you want to add.
2. To **delete a LES** from the list, scroll to the LES you want to delete and press **2nd** **8/Del**.
3. To **change the priority** of a LES, scroll to the LES you want to change and press **2nd** **↑/Edit**. Then use **↑/Edit** or **↓/Mute** to move the LES to the right priority.

4.7.6. System Setup

The **System Setup** menu is used for viewing and changing system parameters such as ring profiles, pin codes etc.

The **System Setup** menu has the following submenus:

- Ring Profiles (see **RingProfiles** on page 76)
- QuickDial (see **QuickDial** on page 78)
- Disclose Pos
- Fax Setup
- Pin Setup (see **Pin Setup** on page 79)
- Configure (see **Configure** on page 80)

Each of the submenus is described in the following pages.

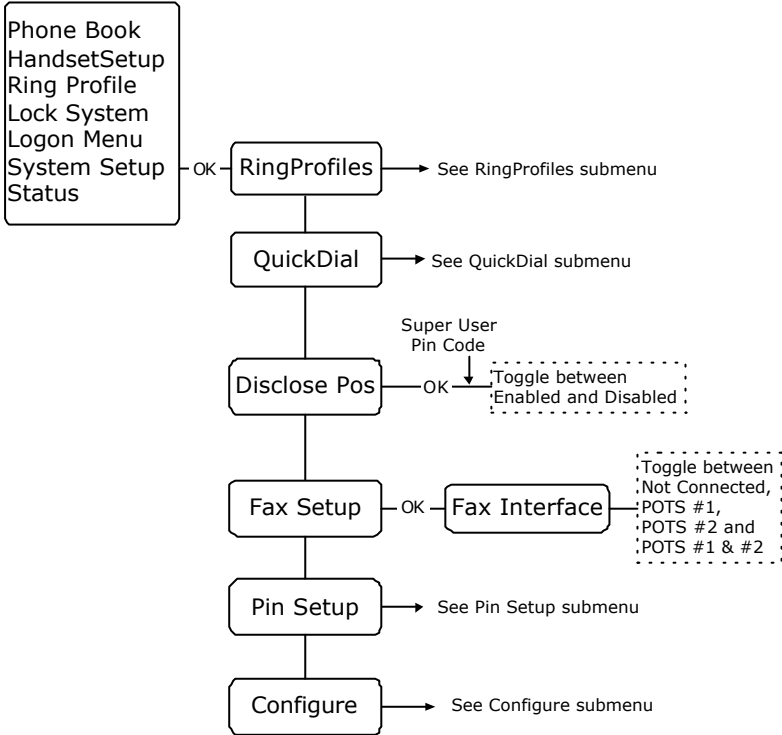

To access the System Setup menu, enter the main menu, scroll down to **System Setup** and press **OK**.



4

Disclose Pos: Select Disclose Pos to view or change the Disclose Position status.



Note: A Super User pin code is required to change the Disclose Position status.

Use  and  to toggle between Enabled and Disabled.

If you select Enabled, the position of the aircraft will be disclosed to the earth station for use in the Inmarsat network.

If you select Disabled, only the ID of the current spot beam is disclosed.

Fax Setup: Select Fax setup to determine which interface should not ring on a broadcast call.

Use  and  to scroll through the interface options and select with .

You may select:

- POTS #1
- POTS #2
- POTS #1 & #2, or
- Not Connected

RingProfiles

The **RingProfiles** submenu is used to view or change the Ring Profiles of the system. You can have up to 5 ring profiles. One of the profiles "TakeOfLandng", is predefined.

Note: If the "Chime/Lamps Inhibit" function is used in the installation, the "TakeOfLandng" profile is automatically activated during takeoff and landing.

To access the RingProfiles submenu, enter the **System Setup** menu, scroll down to **RingProfiles** and press **OK**.

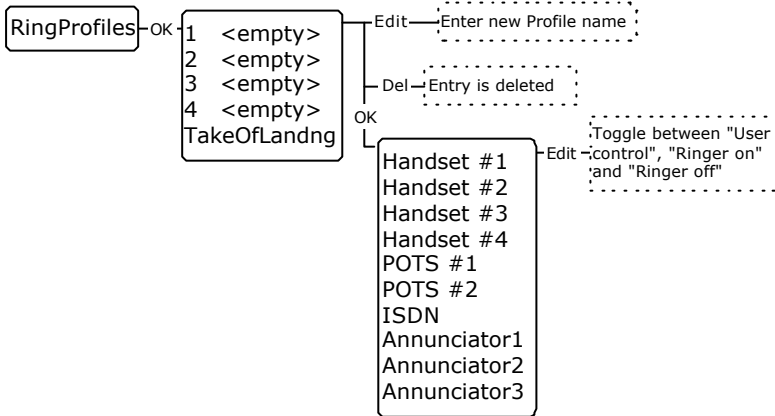



To **change the name** of a profile, scroll to the profile, press **2nd** **↑** **Edit** and enter the new name.



To **change the contents** of a profile, do as follows:

1. Select the profile using **OK**.
2. Scroll to the device you want to change the settings for, and select it with **OK**.

4

3. Use  and  to toggle between User Control, Ringer On and Ringer Off.

Note: "User Control" is only applicable to Handset #1 through #4. This means you can configure each of the handsets #1 through #4 separately. For the remaining devices, "User Control" has the same function as "Ringer On".

To **delete** a profile, scroll to the profile you want to delete and press  .

Below is an explanation of the Annunciators:

Annunciator1 (Call Annunciator): This Annunciator is used for signalling incoming voice calls. The Annunciator is "flashing" like the Connection LED on a 4-wire handset and is turned off when the call is answered or terminated by initiator.

Annunciator2 (Fax Annunciator): This Annunciator is used for signalling incoming faxes. The Annunciator is "steady ON" until a receipt for the fax has been given in the handset.

Annunciator3 (Service Annunciator): This Annunciator is used for indicating service availability. The Annunciator is "steady ON" when H+ service is available.

QuickDial

The **QuickDial** submenu is a list of 1-digit numbers for quick dialling of up to 9 favourite phone numbers.

To access the QuickDial submenu, enter the **System Setup** menu, scroll down to **QuickDial** and press **OK**.

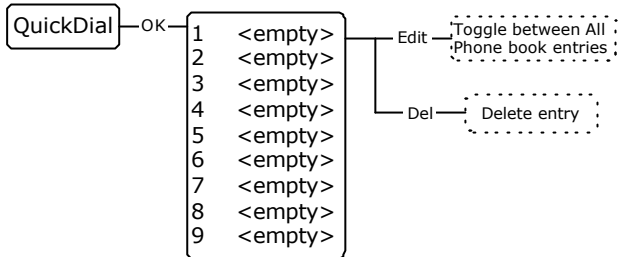

4

To **edit a quick dial entry**, do as follows:

1. Scroll to the quick dial number you want to change and press **2nd** **F**.
2. Scroll through the phonebook to the phone number you want to use with the selected quick dial number.
3. Press **OK** to select the phone number.

To **delete a quick dial entry**, scroll to the quick dial number you want to delete and press **2nd** **Del**.

Pin Setup

The **Pin Setup** submenu is used for disabling or changing Pin codes.

To access the Pin Setup submenu, enter the **System Setup** menu, scroll down to **Pin Setup** and press **OK**.

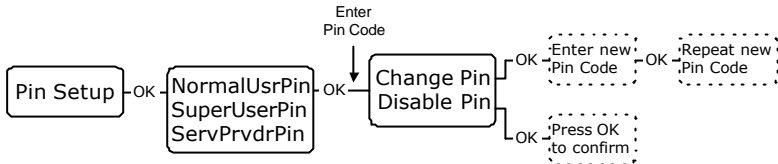

To access the pin codes you want to change or disable, do as follows:

1. Scroll to the pin code type you want to change or disable
2. Enter the current pin code for the selected type.
3. Toggle between Change Pin and Disable Pin and use **OK** to select the function.

Change Pin: Choosing **Change Pin** you will be prompted for a new Pin code. Enter a new Pin code of 4 to 8 digits and use **OK** to accept the code. When you are prompted to re-enter the Pin code, enter the code again and accept with **OK**.

Disable Pin: Select **Disable Pin** to disable the Pin code you entered. Press **OK** to confirm the deletion.

Configure

The **Configure** submenu is used for configuring the handset type and the lists of known GESs, LESs and satellites.

Note: A Service Provider pin code is required to access the settings in the Configure menu.

The Configure menu has the following submenus:



- Handset Type
- Known GESs
- Known LESs
- Init Sat



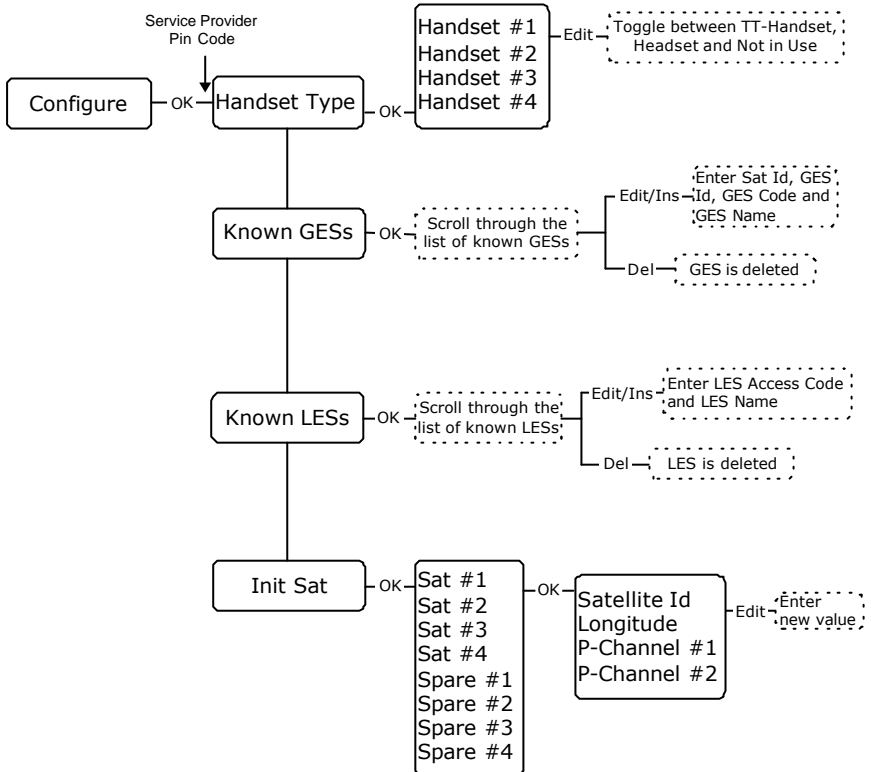

Each of the submenus is described in the following pages.

To access the Configure submenu, enter the **System Setup** menu, scroll down to **Configure** and press **OK**.

















Handset Type: Select **Handset Type** to view or change the type of the handsets.

Use  and  to scroll through the list of handsets.

To **change the handset type**, select the handset you want to change and press  . Use  and  to scroll between TT-Handset, Headset and Not in Use, and press  to select.

Note: The Headset selection is only for future use.

Known GESs: Select **Known GESs** to view or change the list of known GESs.

1. To **add a GES** to the list, press   and enter:
 Satellite ID, followed by 
 GES ID, followed by 
 GES Code, followed by 
 GES Name, followed by 
2. To **delete a GES** from the list, scroll to the GES you want to delete and press  .
3. To **edit a GES**, scroll to the GES you want to change and press  . Enter:
 Satellite ID, followed by 
 GES ID, followed by 
 GES Code, followed by 
 GES Name, followed by 

Known LESs: Select **Known LESs** to view or change the list of known LESs.

1. To **add a LES** to the list, press $\text{2nd} \text{C}^{Ins}$, and enter:
LES Access (the Global LES Access Code), followed by OK
LES Name, followed by OK
2. To **delete a LES** from the list, scroll to the LES you want to delete and press $\text{2nd} \text{8}^{Del}$.
3. To **edit the LES information**, scroll to the LES you want to change and press $\text{2nd} \text{↑}^{Edit}$. Enter:
LES Access (the Global LES Access Code), followed by OK
LES Name, followed by OK

Init Sat: Select **Init Sat** to view or change the list of satellites.

1. To **edit the satellite information**, scroll to the satellite you want to change and press OK . Enter:
Satellite ID, followed by OK
Longitude, followed by OK
The frequency for P-Channel #1, followed by OK
The frequency for P-Channel #2, followed by OK
2. To **delete a satellite** from the list, scroll to the satellite you want to delete and press $\text{2nd} \text{8}^{Del}$.

4.7.7. Status

The **Status** submenu is used for viewing signal strength, LAN status, navigation data, active errors, serial numbers and software versions.

The Status menu has the following submenus:

- Channels
- Nav data
- SDU
- SW version
- LAN
- Active Error

Each of the submenus is described in the following pages.

To access the Status menu, enter the main menu, scroll down to **Status** and press **OK**.

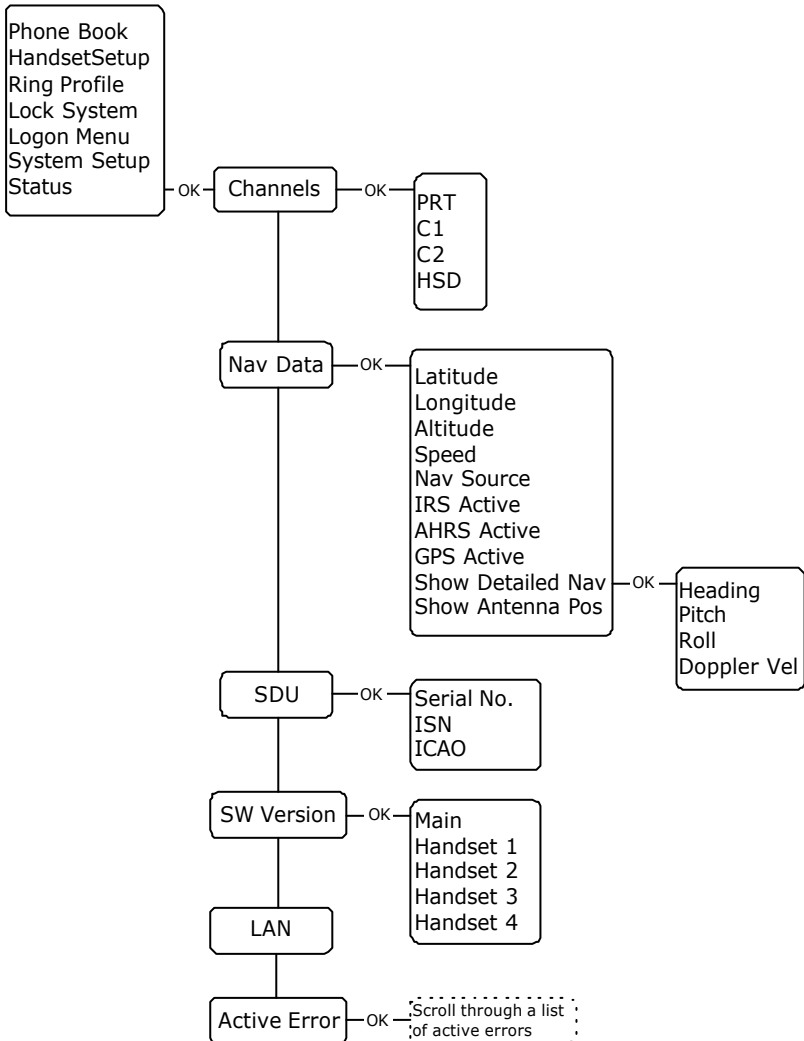

Channels: Select **Channels** to display the signal strength (C/No in dBHz) of:

- PRT (P-channel)
- C1 (H+ voice channel)
- C2 (H+ voice channel)
- HSD (HSD channel)

Use  and  to select among the channels.

Note: For the channels to work properly, the value of the signal strength should be above the values mentioned below:

P-Channel: above 35 dBHz

C-Channels: above 42 dBHz

HSD-Channel: above 54 dBHz



If there is no signal, the display shows NA@NA.

Nav data: Select **Nav data** to display the navigation data:

- **Latitude** (as degrees, minutes, seconds)
- **Longitude** (as degrees, minutes, seconds)
- **Altitude** (in feet)
- **Speed** (ground speed in knots)
- **Nav source** – the source used for navigation; can be IRS or AHRS+GPS
- **IRS Active** – shows whether or not the IRS is active
- **AHRS Active** – shows whether or not the AHRS is active
- **GPS Active** – shows whether or not the GPS is active

Show Detailed Nav

- Heading – (0 to 360 degrees)
- Pitch (in degrees U or D (up or down))
- Roll (in degrees L or R (left or right))
- Doppler Velocity - the speed of the aircraft relative to the satellite, given in knots.
- **Show Antenna Pos** – the position of the antenna in degrees relative to the attitude of the aircraft, given as the Azimuth (horizontal position) and the Elevation (vertical position).

Use  and  to select among the Navigation parameters and  to enter the **Show Detailed Nav** menu.



SDU: Select **SDU** to display:

- Serial no. (Serial number of the SDU)
- ISN (Inmarsat Serial number)
- ICAO (ICAO Address)



Use  and  to scroll through the numbers.

SW version: Select **SW version** to display the version number of:

- Main software
- Handset 1 firmware
- Handset 2 firmware
- Handset 3 firmware
- Handset 4 firmware

Use  and  to scroll through the software.

LAN: Select LAN to view the status of the network. Status can be "LAN link is up" or "LAN link is down".

Active error: Select Active error to display information of any active errors. If there is more than one error, use  and  to scroll through the error list.

5. PC Connection

5.1. ISDN and MPDS Overview

Please note: ISDN and MPDS services are only available on Aero-HSD⁺ systems when the aircraft is positioned inside an area with Spot Beam coverage.

Mobile Packet Data Service (MPDS) and Integrated Services Digital Network (ISDN) are both services that enable the mobile user to connect to the Internet. The maximum data transfer rate is 64 kbit/s.

The difference between the Mobile ISDN and MPDS is that with Mobile ISDN you are charged for connection time and with MPDS you are charged for Mbits transferred. This means that for applications like Web browsing, email services, IP/LAN connectivity and small to medium size file transfer, the MPDS will be the most economic and convenient solution.

While in MPDS or ISDN mode the terminal is flagged busy in the Inmarsat network, i.e. it is not able to receive any ISDN calls, until it returns to normal idle mode.

For information on how to set up the computer and transceiver for an **MPDS** connection, see section 5.2.2 **Setting up MPDS via Ethernet and PPPoE.**

For information on how to set up the computer and transceiver for an **ISDN** connection, see section 5.2.3 **Setting up ISDN.**

5.2. Setup of Data Equipment

5.2.1. Hardware connection

The illustrations below show typical hardware setups for MPDS and ISDN data connections.

MPDS Ethernet Hardware Connection.



For an MPDS over Ethernet session, connect a LAN cable between the Ethernet port of the computer and the Ethernet port on the Aero-HSD+ system.

ISDN Hardware Connection.



The ISDN connection is made by connecting an ISDN modem (or Terminal Adapter) to the computer. See the manufacturer's installation guide for details on how to do this. Connect the modem to the Aero-HSD+ system via an ISDN cable. The appropriate modem driver must be installed on the computer. See the manufacturer's installation guide for details on how to do this.

ISDN / MPDS Hardware Connection through Router



For an ISDN/MPDS connection through a router, connect a LAN cable between the Ethernet port of the computer and an Ethernet port on the router. Follow the setup guide from the router supplier.

5.2.2. Setting up MPDS via Ethernet and PPPoE

This chapter describes the set-up and operation of MPDS connections via Ethernet and PPPoE using various PPPoE clients.

Windows XP with built-in PPPoE client

Prerequisites

The PC must have an Ethernet adapter and Windows XP installed and both must be operational. There must be a network connection between the PC and the Aero HSD+ system.

Setting up the Connection

1. From the "Start" menu select "Settings" then "Network Connections" and then "Create New Connection".
This brings up the "New Connection Wizard".
2. Click "Next".
3. Select "Connect to the Internet" and click "Next".
4. Select "Setup my connection manually" and click "Next".
5. Select "Connect using broadband connection requiring user name and password" and click "Next".
6. Type a name for the connection, e.g. "MPDS via PPPoE" and click "Next".
7. Select "Anyone" and click "Next".

8. Type a random user name and password and click "Next".
9. Select the shortcut on desktop option.
10. Click "Finish".
11. Now click the new shortcut on the desktop named "MPDS via PPPoE". The Aero-HSD⁺ system should now connect to MPDS.

Note:

Because of the relatively long set-up time for an MPDS connection, the PPPoE connection may some times time out.

Windows 2000 and WinPoET™ PPPoE client

(Tested under MS Windows 2000)

The MPDS connection via Ethernet and PPPoE can be established using various PPPoE clients. For this example WinPoET client was used.

Prerequisites

The computer must have a working Ethernet adapter.

Windows Dial-Up Networking (DUN) must be installed.

Installation

The WinPoET program is contained in a self extracting zip-file.

1. Double click the icon, and installation begins.
2. Click 'OK' and 'Next' a few times to accept license agreement and accept rebooting the computer (only older windows versions.)
3. To make the first connection with WinPoET, click the start button, and find the new program folder 'iVasion'.
4. In 'iVasion', press 'WinPoET' and 'WinPoET dialer'.



5. Enter random user name and password, and click connect.

5

The status field tells you how far you have reached in the connection process.

The phases of a successful connection are:

- Click Connect to start the connection process.
- Connecting to communications device.
- Starting authentication process.
- Starting projection phase.
- Authentication completed successfully
- Connected

After the first connection, WinPoET creates a 'WinPoET Connection' in the 'Network and dial-up connections' folder that can be used with the standard Windows DUN system (Automatic dialling and disconnection etc.).

5.2.3. Setting up ISDN

The Aero-HSD⁺ transceiver is connected to ISDN equipment via an ISDN cable.

The example below shows how to setup an Internet connection via ISDN.

1. Connect an ISDN modem to the ISDN interface.
2. Connect the modem to a PC, via a PCMCIA Card.
3. Follow the modem manufacturer's installation instructions for the appropriate operating system.

For the following example, a Lasat Unique 1280i ISDN modem was installed under Windows 98.

Step 1: Install a modem

1. From the Control Panel select Modems and add a modem.
2. Let Windows detect the modem automatically.

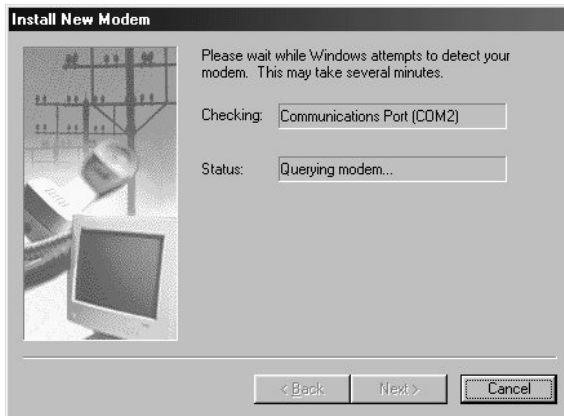

When the modem is detected, the following window appears.

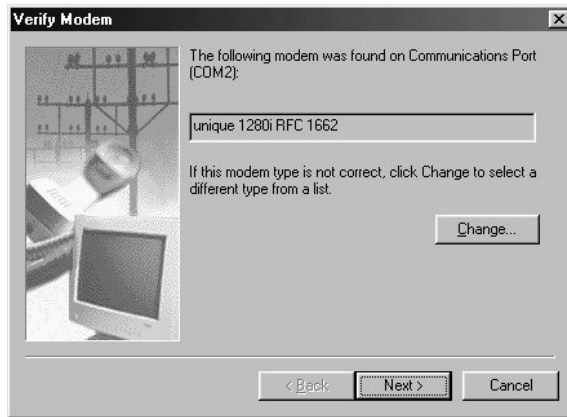

3. Verify that the modem is installed.

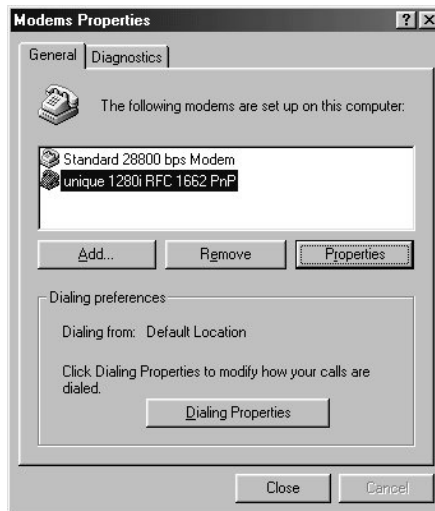

Step 2: Create a Dial-up connection

1. Open Dial-up Networking from My computer and click "Make new connection".
2. Give the connection a recognizable name e.g. ISDN Connection.

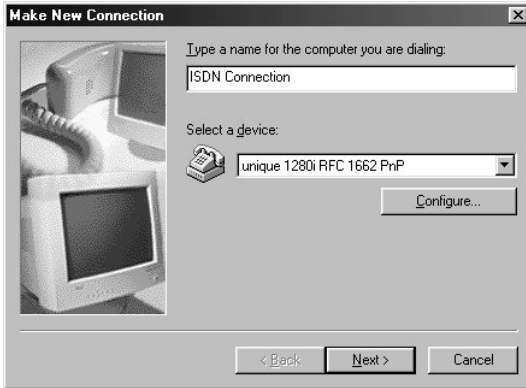

3. Select the Lasat modem defined during step 1 as the dial up device.
4. Enter the telephone number to the Internet Service Provider. Remember country code and area code if necessary.

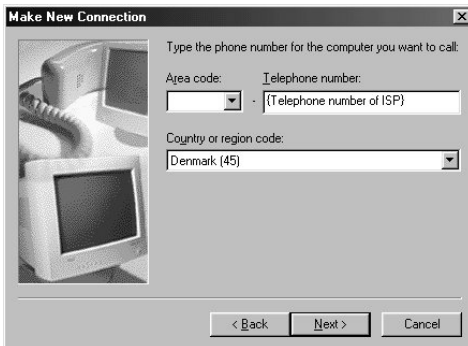

5

5. Include TCP/IP as allowed network protocol and use TCP/IP settings (Server assigned IP address, Server assigned name server addresses etc.) as recommended by the ISP.

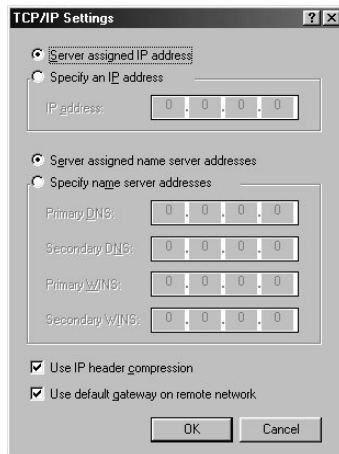
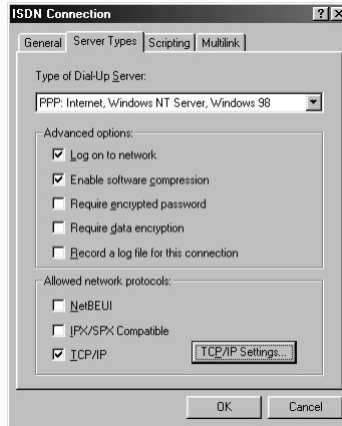

After this, the connection can be made as described in section 5.3.

5.2.4. Setting up a Router

For information on how to set up a router, see Chapter 3 in the manual "AeroROUTER 700" PN# 500420.

5.2.5. Setting up a H+ Modem Connection

With the Aero-HSD+ modem connection, you can use any application supporting modem speeds at 2400 bps and a satellite delay of 200 ms.

Do as follows to set up the modem:

1. Connect the modem to the Satcom (Satcom connection #5 or #6).
2. On the desktop, double click "My computer".
3. Double-click "Dial-up networking".
4. Double-click "Make new connection".
5. Type a name for the connection (e.g. "2400 BPS via AERO-HSD+").
6. Select the modem to use.
7. Click Next.
For an outgoing call, in the phone number, the international prefix "00" must be replaced by "02", to indicate a modem data call.
8. Click Next.
9. Click Finish.

Advanced settings for the modem connection:

Type the AT command relevant for your modem to set the corresponding parameters in Extra settings window:

- Communication protocol: V22bis and V42bis
- Error correction: LAPM
- Guard tone: OFF (if possible)

NOTE: AT commands can be pre-programmed in nearly all modems. Contact your modem manufacturer for further information.

5.3. Connecting to the Network

A connection can be started automatically by an application like Internet Explorer or Outlook Express. The connection can also be established manually.

To establish the connection manually, do as follows:

1. In windows, open Dial-Up networking and double click the appropriate icon.
2. Enter username and password if necessary.
3. Click 'Connect'.

Wait for the connection to be completed, indicated by a 'Dial-up Networking' icon in the task bar tray.

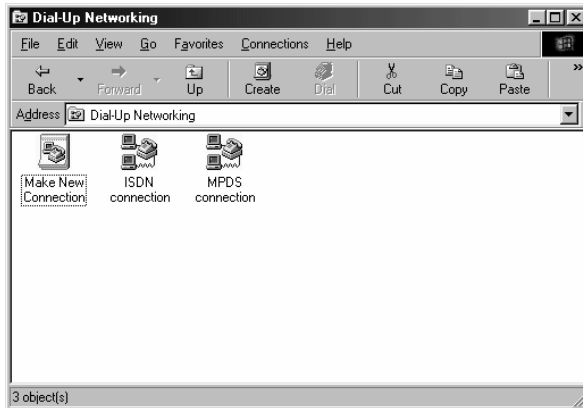

The connection can be disconnected by right-clicking the tray icon and choosing 'Disconnect'.

6. Troubleshooting

6.1. Overview

If case of a fault situation, first check that the H+ and/or HSD LEDs are lit, and that the display reads "Ready".

Also make sure that the transmission path is not obstructed, e.g. by buildings if the aircraft is on the ground.

The system is able to display various error codes to help you troubleshoot the system. The following sections provide an overview and a list of some of the error codes you may see in the display.

If you need further assistance, please call the supplier of the Aero-HSD+ System.

6.2. Error codes

If there is a fault, the type of fault and the fault code is displayed in the Full Feature Handset. Where possible the fault code is translated into plain text. Two types of fault codes are defined:

- BITE errors
- Cause Codes

For a complete list of BITE error codes and Cause Codes, please refer to the Installation and Maintenance Manual.

6.2.1. BITE Errors

A BITE error is a hardware error detected by the automatic error detection system in the Aero-HSD⁺ system.

The red LED on the handset indicates the presence of a fatal or essential BITE error.

A **fatal** BITE error means that you are logged off and cannot log on again.

An **essential** BITE error means that the functions are limited and one or more services are not available.

A **non-essential** BITE error means that there are minor errors, but all services are still available. The red LED on the handset will not indicate this type of error.

Please report any BITE errors to the Maintenance Responsible.

When a BITE error is present, the display toggles between the error code and the previous display contents.

The BITE error is shown in the second line of the display. A BITE error has a unique 4-character BITE code.

You can also view any active BITE errors in the Status menu under Active Error.

6.2.2. Cause Codes

A Cause Code describes a fault detected by the Earth Station during a call.

The cause codes can help you find the reason for an error. In most cases, errors are caused by a problem in the satellite network.

The Cause Code is displayed in the handset for a few seconds after the call is interrupted. If possible, the code is translated into plain text instead of the Cause Code. A Cause Code is a unique 4-character code.

The following section shows a list of cause codes with an explanation of the error message.

6.3. List of Cause Codes

Note: Cause Codes should not be mistaken for BITE error codes. See the previous page for an explanation of the two kinds of error codes.

6.3.1. Logon Cause Codes

The following list shows the cause codes that may appear during logon.

Display text	Description	Guidance
ClassReject	Class rejected	The GES proposes that the class is not supported
GlobChanLoss	Global channel loss	
GlobCunavlb	Global C channel not available at GES	
ManualLogRej	Manuel login rejected	Manual logon is not allowed when logon policy is automatic
NetworkFail	Network Failure	
NoGesSignal	No GES signal	
NoInitData	No valid system table available	
NoSatSignal	No satellite signal	Verify that there are no obstacles between the satellite and the AES antenna

Display text	Description	Guidance
NotAuthorizd	AES not authorized	Verify that the ICAO address used is correct. If it is, contact the service provider to verify that the ICAO address is registered.
OtherReason	Other Reason	
OutsideCover	Outside spot beam coverage	The AES is not under a spot beam of the specified GES
P/R/Tunavlb	Packet data channel unavailable	
PkdtaUnavlb	Packet data service unavailable	
SDUfailure	SDU failure	Check the current bite errors
SpotChanLoss	Spot channel loss	
TableFull	Table Full	
UserLogoff	User logoff	
VCC&dUnavlb	Voice not available at GES	
VoiceUnavlb	Voice Unavailable	
WrongGES	GES not existing	Check GES ID validity
WrongGESid	Wrong GES identifier	Check GES ID validity
WrongParam	Wrong Parameter	
WrongSatID	Wrong Satellite identifier	Check satellite ID validity

6.3.2. Cause Codes after Logon

The following list shows some of the cause codes that may appear when the system is logged on.

Display text	Inmarsat description
	Normal clearing
AddrComplete	Address complete
AESabsent	AES absent
AnalogFail	Analogue data equipment is not available
AnalogRate	Required analogue data rate is not supported
Busy	User busy
CallBared	Incoming calls are barred
CallPreempt	Call is pre-empted
CallRejected	Call is rejected
CardInvalid	Credit card type is not supported
CardRejected	Credit card number is rejected
ChanAbsent	Channel type is not implemented
ContFailure	Continuity failure
DigitalFail	Digital data equipment is not available
DigitalRate	Required digital data rate is not supported
GndDestFail	Destination out of service
Handover	Spot beam handover

Display text	Inmarsat description
InvalidAddr	Invalid/incomplete address
InvalidNumbr	Invalid number format
NetworkFail	Network is out of order
NoAnswer	No user is responding
NoChanAvail	No channel is available
NoCircuit	No circuit/channel is available
NoRoute	No route to destination
NoUnitAvail	No channel unit is available
SatDestFail	Destination out of service
ServiceType	Service type is not supported
SwitchBusy	Switching equipment congestion
UnassignedNo	Unassigned number
Unauthorized	AES not authorised
Undefined	Undefined cause
Unspecified	Normal, unspecified
User Busy	User is busy
VoiceTypeErr	Voice channel type is not supported
WrongNumber	Unassigned number

This page is intentionally left blank

Appendix A - Menu Tree

A

The next page shows an overview of the complete menu tree. For details on each menu, refer to the section **The Menus** on page 58.

Menu Tree

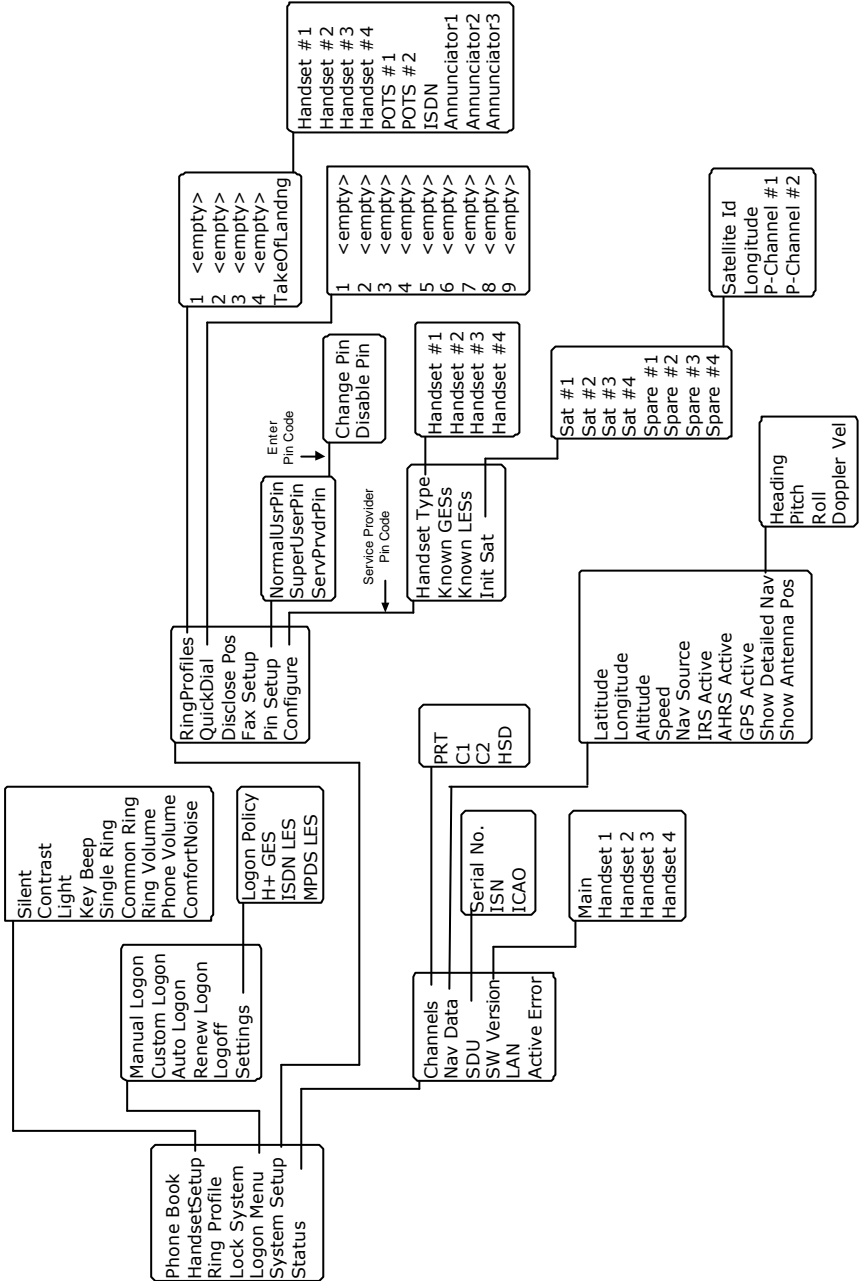

Glossary

ACARS	Aircraft Communication Addressing & Reporting System
AFIS	Automatic Flight Information Service
AHRS	Attitude and Heading Reference System
AORE	Atlantic Ocean Region East
AORW	Atlantic Ocean Region West
ATM	Air Traffic Management
baud	Modulation speed in a modem (baud \leq bit/s)
bit	binary digit
bit/s	bits per second (baud \leq bit/s)
BITE	Build In Test Equipment
C-channel	A channel which provides a bidirectional communications channel between ground and air. C-channels are typically used for voice communications.
CM	Configuration Module
CMU	Communications Management Unit
CNS	Communication Navigation Surveillance

Glossary

COM	Contraction Of Communication
DUN	Dial Up Network
FAX	Facsimile And Telefax
FMS	Flight Management System
GES	Ground Earth Station
GPS	Global Positioning System
H+	An Inmarsat aeronautic data and voice service
HGA	High Gain Antenna
HPA	High Power Amplifier
HSD	High Speed Data
HSU	High Speed Unit
ICAO	International Civil Aviation Organization
ID	Identification
IDD	International Direct Dialling
IMN	Inmarsat Mobile Number
Inmarsat	International Maritime Satellite Organisation
IOR	Indian Ocean Region
IP	Internet Protocol

IRS	Inertial Reference System
ISDN	Integrated Services Digital Network
ISN	Inmarsat Serial Number
ISP	Inmarsat Service Provider
LAN	Local Area Network
LCD	Liquid Crystal Display
LED	Light Emitting Diode
LES	Land Earth Station
MES	Mobile Earth Station
Modem	Modulate Demodulate
MPDS	Mobile Packet Data Service
MSN	Multiple Subscriber Number
NCS	Network Co-ordination Station
PC	Personal Computer
P-channel	A channel which provides a uni-directional dedicated communications channel from a Ground Earth Station (GES) to all aircrafts. Data packets are broadcast over this channel and addressed to a specific aircraft.
PIN	Personal Identification Number

Glossary

POR	Pacific Ocean Region
POTS	Plain Old Telephony System
PPPoE	Point-to-Point Protocol over Ethernet
PRT	The total system communications channel including the P-channel, R-channel and T-channel
R-channel	A channel which provides a uni-directional dedicated communications channel from aircraft to a GES. Access to this channel is contention mode, with the timing signal (for the transmission slots) being provided by the P-Channel.
RF	Radio Frequency
SCPC	Single Carrier per Channel
SDM	System Definition Manual
SDU	Satellite Data Unit
SLCV	Field in the Cause codes (Standard/Location/Class/Value)
STE	Secure Telephone Equipment
STU	Secure Telephone Unit
SW	Software

Swift64	An Inmarsat aeronautic High Speed Data service
TA	Terminal Adapter
T-channel	A channel which provides a uni-directional dedicated communications channel from aircraft to a GES. T-Channels are used to convey longer messages without the risk of conflict that arises on the R-Channel. T-Channels are allocated by a GES following a request received over the R-Channel.
TCP/IP	Transmission Control Protocol/Internet Protocol
TNID	Terrestrial Network ID
UDI	Unrestricted Digital Information
USB	Universal Serial Bus
WAN	Wide Area Network
Webcam	Web Camera
WLAN	Wireless Local Area Network

This page is intentionally left blank

Index

- 2nd functions..... 28
- 3.1 kHz audio 12, 14
- 56 kbit/s 12
 - DATA..... 14
- 64 kbit/s 12, 89
 - UDI..... 14
- Abbreviations 113
- Active error..... 88
- AHRS active 86
- Alpha mode 30
- Alpha-Numeric buttons..... 29
- Altitude..... 86
- Antenna position 87
- Auxiliary Cradle 20
- Auxiliary Handset 20
- BITE error codes..... 104
- Booting..... 37
- Call
 - Conference..... 47
 - From 2.4 GHz Cordless
 - phone..... 54
 - From auxiliary handset.... 48
 - From Full Feature handset43
 - From phone book..... 44
 - From POTS handset..... 48
 - From Sigma⁷ phone 53
 - Internal..... 45
 - Quick dial..... 44
 - To the terminal..... 57
 - Using ISDN 55
- Call transfer
 - Auxiliary handset..... 52
 - Full Feature handset..... 46
- Caps toggle29
- Cause codes.....105
 - List of.....106
- CDM17
- Change pin code.....79
- Channels
 - signal strength86
- ComfortNoise64
- Commission13
- Components of Aero-HSD+.17
- Conference call47
- Configuration.....80
- Contrast62
- Data.....12
- Detailed navigation.....87
- Dial-Up networking102
- Disable pin code79
- Disclose position75
- Display symbols24
- Documentation
 - Related9
- Doppler velocity87
- Email.....89
- Error
 - View active88
- Error codes104
 - BITE104
 - Cause codes.....105
 - List of.....106
- Fault
 - View active88
- Fax.....12
 - 3.1 kHz audio.....56

- H+55
- HSD56
- ISDN56
- Fax setup75
- Features of Aero-HSD+.....16
- File transfer89
- Full Feature Cradle20
- Full Feature Handset....20, 21
- Function buttons25
- Geo-stationary11
- GES.....12
 - List of known.....82
 - List of preferred.....70
- Glossary113
- GPS active86
- H+11
- Handset type.....82
- HandsetSetup60
- Heading.....87
- HPA.....19
- ICAO address87
- Inmarsat.....11
- Internal calls.....45
- International access codes.57
- Internet Explorer.....102
- IP/LAN89
- IRS active86
- ISDN89
 - Hardware setup91
 - Phone call.....55
 - Setup of connection.....96
- ISN87
- Key beep63
- Latitude.....86
- LCD.....22
- LEDs23
- LES12
 - List of known 83
 - List of preferred, ISDN 71
 - List of preferred, MPDS ... 72
- Light in handset..... 62
- Lock System..... 65
- Logoff..... 67
- Logon..... 66
 - Automatic..... 67
 - Custom 67
 - Manual..... 67
 - Policy..... 70
 - Renew..... 67
 - Settings 68
- Longitude..... 86
- Manuals
 - Other 9
- Memory
 - Auxiliary handset 49
- Menu
 - Accessing 41
 - Entering selected 41
 - Exiting..... 41
 - Overview..... 111
 - Scrolling through..... 41
 - Shortcuts 41
 - Tree 111
- Modem
 - H+ setup..... 100
- MPDS..... 12, 14, 89
 - Hardware setup..... 90
 - Setup using Ethernet and PPPoE 92
 - Windows 2000 and PPPoE93
 - Windows XP and PPPoE.. 92
- Navigation
 - Data 86
 - Show detailed..... 87

- Source 86
- NCS 11
- Normal User 39, 41
- Outlook Express 102
- Packet Data Channel..... 14
- Phone book..... 58
 - Delete entry 59
 - Dial from..... 59
 - Edit entry 59
 - Insert new entry 59
 - Making a call..... 44
- Phone volume 64
- Pin codes
 - Changing..... 79
 - Types 39
- Pin setup 79
- Pitch 87
- POTS phone 48
- Prefix..... 43
- Quick dial..... 78
 - Delete entry 78
 - Edit entry 78
 - Making a call..... 44
- Recalling a stored number
 - Auxiliary handset..... 51
- Redial
 - Auxiliary handset..... 52
 - Full Feature handset..... 44
- Ring profile
 - Defining..... 76
 - Selecting 65
- Ring tone
 - All handsets 63
 - Broadcast call..... 63
 - Current handset..... 63
 - Direct call..... 63
- Ring volume63
- Ringmode
 - Defining76
 - Selecting.....65
- Roll.....87
- Router
 - Hardware setup.....91
 - Setup.....100
- Satellites.....11
 - List of.....83
- SDU.....19
 - Serial number87
- Service Provider.....41
- Services14
- Signal strength86
- Silent function.....62
- Software version88
 - Applicable8
- Special characters.....29
- Speech.....12, 14
- Speed86
- Spot-beams11
- Status.....84
- Storing a phone number
 - Auxiliary handset.....49
- Super User.....39, 41
- SW version88
- Swift6411
- System components17
- System setup.....73
- Transferring a call
 - Auxiliary handset.....52
 - Full Feature handset.....46
- Troubleshooting.....103
- Voice12
- Web browsing89