

EXPLORER™ 500

User Manual

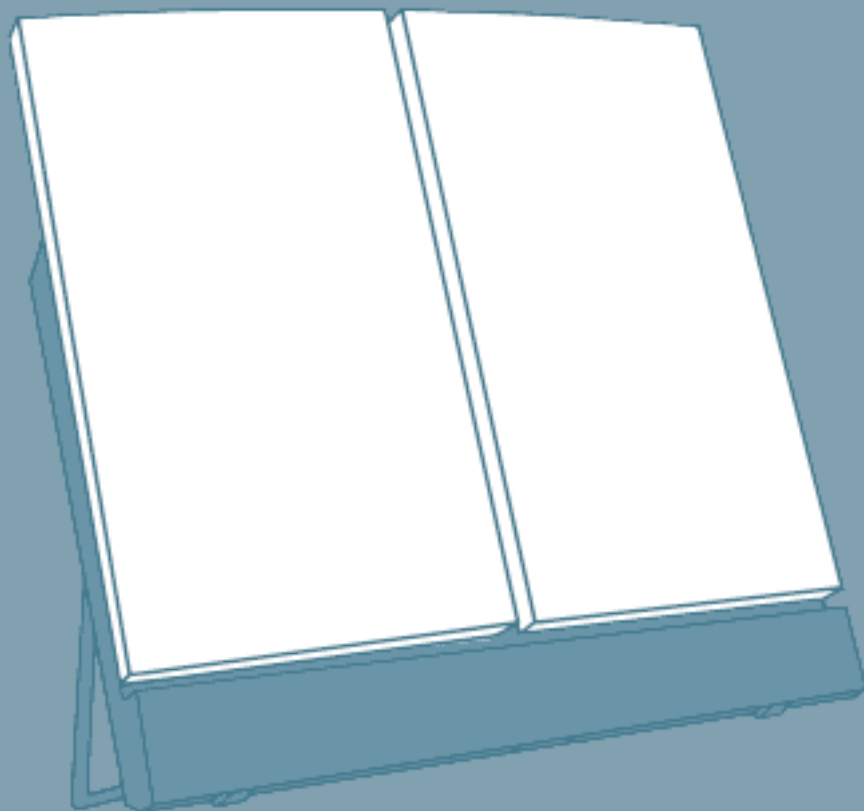

bgan | inmarsat 

Thrane & Thrane

Document number: TT 98-122274-E

Release date: August 24, 2005

Information in this document is subject to change without notice and does not represent a commitment on the part of Thrane & Thrane A/S.

Copyright

© 2005 Thrane & Thrane A/S. All rights reserved.

FCC Statement

This device complies with part 15 of the FCC Rules. Operation is subject to the following two conditions:

1. This device may not cause harmful interference, and
2. this device must accept any interference received, including interference that may cause undesired operation.

Part 15.21

Changes or modifications not expressly approved by the party responsible for compliance could void the user's authority to operate the equipment.

Note

The manufacturer is not responsible for any radio or TV interference caused by unauthorized modifications to this equipment. Such modifications could void the user's authority to operate the equipment.

Trademark Acknowledgements

- **EXPLORER** is a trademark of Thrane & Thrane A/S.
- **Bluetooth** is a registered trademark of Bluetooth SIG.
- **Windows** and **Outlook** are registered trademarks of Microsoft Corporation in the United States and other countries.
- **Inmarsat** is a registered trademark of the International Maritime Satellite Organisation (IMSO) and is licensed by IMSO to Inmarsat Limited and Inmarsat Ventures plc.
- Inmarsat's product names are either trademarks or registered trademarks of Inmarsat.
- Other product and company names mentioned in this manual may be trademarks or trade names of their respective owners.

Company Addresses

Denmark

Thrane & Thrane A/S
Lundtoftegårdsvej 93 D
DK-2800 Kgs. Lyngby
Denmark

T: +45 39 55 88 00
F: +45 39 55 88 88
www.thrane.com

Thrane & Thrane Aalborg A/S
Porsvej 2
DK-9200 Aalborg SV
Denmark

T: +45 39 55 88 00
F: +45 96 34 61 01
www.thrane.com

USA

Thrane & Thrane, Inc.
509 Viking Drive, Suites K, L and M
Virginia Beach, VA 23452
USA

T: +1(866) SATCOMS or
+1 (757) 463-9557
F: +1 (757) 463-9581
www.thrane.com

Safety Summary

The following general safety precautions must be observed during all phases of operation, service and repair of this equipment.

Failure to comply with these precautions or with specific warnings elsewhere in this manual violates safety standards of design, manufacture and intended use of the equipment. Thrane & Thrane A/S assume no liability for the customer's failure to comply with these requirements.

Do Not Operate in an Explosive Atmosphere

Do not operate the equipment in the presence of flammable gases or fumes. Operation of any electrical equipment in such an environment constitutes a definite safety hazard.

Keep Away from Live Circuits

Operating personnel must not remove equipment covers. Component replacement and internal adjustment must be made by qualified maintenance personnel. Do not replace components with the power cable connected. Under certain conditions, dangerous voltages may exist even with the power cable removed. To avoid injuries, always disconnect power and discharge circuits before touching them.

Do Not Service Alone

Do not attempt internal service or adjustments unless another person, capable of rendering first aid resuscitation, is present.

Do Not Substitute Parts or Modify Equipment

Because of the danger of introducing additional hazards, do not substitute parts or perform any unauthorized modification to the equipment.

Keep Away from Active Antenna Front

This device emits radio frequency energy when in transmit mode. To avoid injury, keep a minimum safety distance of 0.6 m from the antenna front.



Only Use Approved Batteries from Thrane & Thrane

Use of non approved batteries may result in explosion, fire, electrical shock or injury.

Observe Marked Areas

Under extreme heat conditions do not touch areas of the EXPLORER™ 500 that are marked with this symbol, as it may result in injury.



About the Manual

Intended Readers

This manual is a user manual for the EXPLORER™ 500. The readers of the manual include anyone who is using or intends to use the EXPLORER™ 500.

No specific skills are required to operate the EXPLORER™ 500. However, it is important that you observe all safety requirements listed in the **Safety Summary** in the beginning of this manual, and operate the EXPLORER™ 500 according to the guidelines in this manual.

Manual Overview

This manual has the following chapters:

- **Introduction** - an overview of the BGAN services and a brief description of the system.
- **Getting Started** - how to insert SIM card and battery, start up the unit, and how to navigate the display menus. Also a short guide to making the first call.
- **Using the Display and Keypad** - an overview of the display menu system and how to use the menus.
- **Using the Interfaces** - how to set up and use each interface.
- **Using the Web Interface** - how to use the built-in Web interface of the EXPLORER™ 500, including a description of the available menus and settings. Also advanced setup of interfaces using the Web interface.
- **Maintenance and Troubleshooting** – a short troubleshooting guide, how to update software and a description of the error messages that may appear in the handset. Also a list of system messages and information on where to get further help if necessary.

Table of Contents

	Safety Summary	iv
	About the Manual	v
Chapter 1	Introduction	
	Welcome	1-1
	In This Chapter	1-1
	The BGAN System	1-2
	The BGAN Services	1-4
	Overview of the EXPLORER™ 500	1-5
	Your EXPLORER™ 500	1-6
	Matrix of Services and Communication Interfaces	1-9
	What's Next?	1-9
Chapter 2	Getting Started	
	In This Chapter	2-1
	Unpacking and Assembling	2-1
	Connecting Cables	2-5
	Powering the EXPLORER™ 500	2-6
	Options for the Start-up Procedure	2-7
	Entering the PIN Code	2-9
	Pointing the Antenna	2-10
	Using an External Antenna	2-14
	Using a Fixed EXPLORER™ 500	2-14
	Making the First Call	2-15
	Receiving a Call	2-16
	Making the First Data Connection (LAN)	2-16
	What's Next?	2-16
Chapter 3	Using the Display and Keypad	
	In This Chapter	3-1
	Menu Overview	3-1
	Display Sequence at Start-up	3-3
	Navigating the Display and Keypad	3-5
	The Menus	3-7

Messages Menu	3-7
Calls Menu	3-7
Settings Menu	3-8
Properties Menu	3-11
Help Desk	3-13
Displaying Ongoing Transmission	3-13
Text Information in the Display	3-13
What's Next?	3-14
Chapter 4 Using the Interfaces	
In This Chapter	4-1
General	4-1
Tools for Setup and Use	4-1
Services and Interfaces	4-2
Turning an Interface on or off	4-3
Using a Phone or Fax Machine	4-4
Selecting the Voice Quality	4-4
Connecting an Analogue Phone or a Fax Machine	4-6
Connecting a Bluetooth Handset	4-6
Entering the PIN Code Using a Phone	4-7
Making or Receiving a Phone Call With the EXPLORER™ 500	4-8
Making a Call To the EXPLORER™ 500	4-9
Dialling Functions	4-9
Sending or Receiving a Fax Message	4-12
Using a Data Unit With the EXPLORER™ 500	4-13
Choosing an Interface for Data Connection	4-13
Using the LAN Interface	4-13
Using the USB Interface	4-14
Handling Bluetooth Device Access	4-17
Using a Data Unit with Bluetooth	4-18
Additional Interfaces	4-19
Using an External Antenna	4-19
Using the EXPLORER™ 500 Bluetooth Handset Charger	4-19
What's Next?	4-19

Chapter 5 Using the Web Interface

In This Chapter	5-1
The Web Interface	5-1
Accessing and Navigating the Web Interface	5-3
Entering the PIN Code in the Web Interface	5-4
Pointing Using Web Interface	5-4
Viewing the Status	5-5
Using the Phone Book	5-6
Handling Messages	5-8
Configuring Message Settings	5-10
Power up Behaviour	5-11
Setting the Display Contrast and Brightness	5-11
Turning Audio Indicators on or off	5-12
Enabling Activation of Stealth Mode	5-12
Overview of Network Settings	5-13
Configuring the LAN Interface	5-14
Configuring the USB Interface	5-15
Configuring the Bluetooth Data Interface	5-16
Changing or Disabling the PIN Code	5-17
Viewing Properties of the EXPLORER™ 500	5-18
Updating Software	5-19
Accessing the Help Desk	5-19
Generating a Diagnostic Report	5-20
What's Next?	5-20

Chapter 6 Maintenance and Troubleshooting

In This Chapter	6-1
Getting Support	6-1
Recharging the Battery	6-1
Options and Accessories	6-2
Upgrading Software	6-3
Troubleshooting Guide	6-4
Status Signalling	6-10
Error Messages	6-10
Log Files	6-11

Appendix A Technical Specifications

In This Appendix	A-1
General Specifications	A-1
Battery	A-2
Power Input	A-3
SIM Interface	A-3
Phone/Fax Interface	A-4
LAN Interface	A-5
USB Interface	A-6
Bluetooth Interface	A-7
Built-in Antenna	A-8
External Antenna	A-9
EXPLORER™ 500 Bluetooth Handset Charger Interface	A-10

Appendix B AT Commands

In This Appendix	B-1
Starting up an AT Command Session	B-1
List of Supported AT Commands	B-2

Glossary	Glossary-1
-----------------------	------------

Index	Index-1
--------------------	---------

Introduction

Welcome

Congratulations on the purchase of your EXPLORER™ 500!

The EXPLORER™ 500 is a broadband mobile terminal with integrated antenna, providing high-speed data and voice communication via satellite through the Broadband Global Area Network (BGAN).

Just plug in a phone, fax, laptop or PDA, or use the Bluetooth® interface, point the antenna towards the BGAN satellite - and you are online.

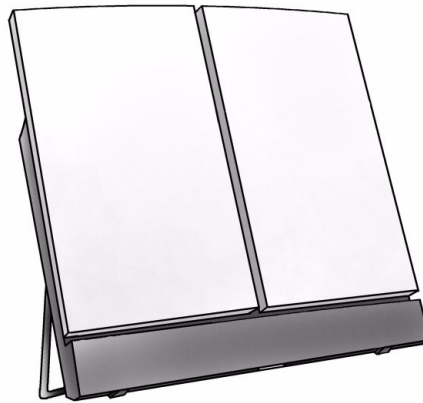

The flat, light-weight design of the EXPLORER™ 500 makes it easy to carry e.g. in the front pocket of a laptop bag.

Applications include:

- High-speed data access
- Phone and fax services
- Large file transfers
- Video conferencing and streaming
- Internet browsing
- Email
- VPN access to corporate servers

In This Chapter

This chapter gives an overview of the BGAN system and services, and introduces the EXPLORER™ 500.

It also gives an overview of the physical unit and its features and functions.

The BGAN System

What is BGAN?

The Broadband Global Area Network (BGAN) is a mobile satellite service that offers high-speed data (up to 492 kbps) and voice telephony. BGAN enables users to access e-mail, corporate networks and the Internet, transfer files and make telephone calls.

Coverage

The Inmarsat® BGAN services are based on geostationary satellites situated above the equator. Each satellite covers a certain area (footprint). The coverage map below shows the footprints of the BGAN system.

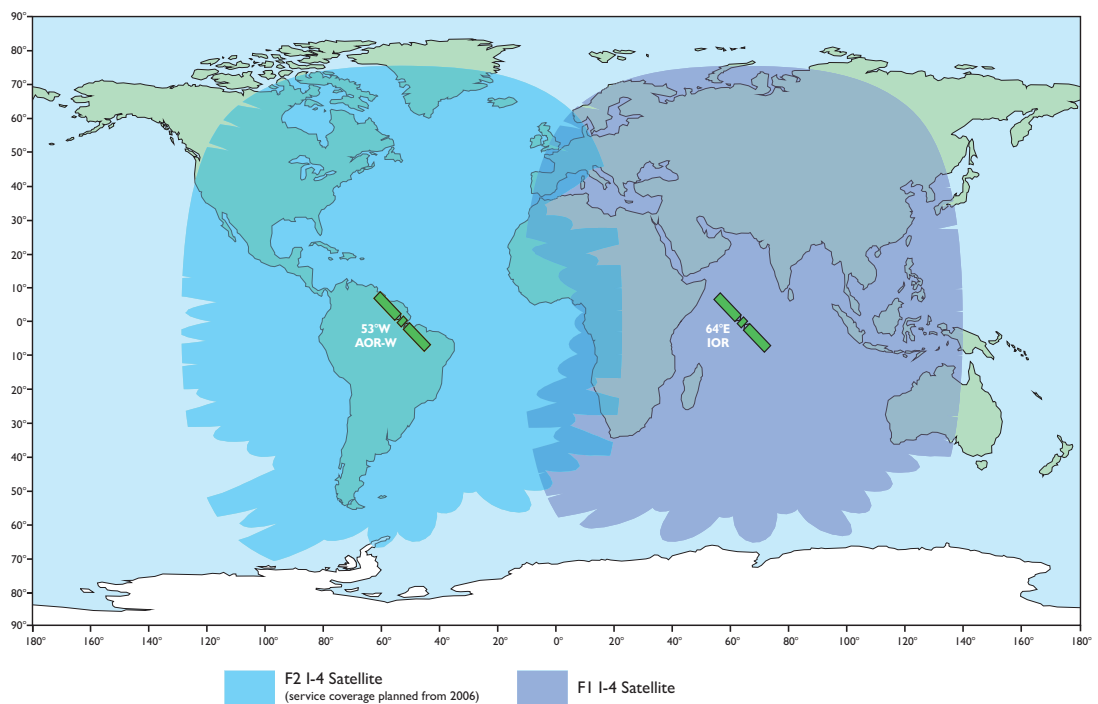

Note

The actual ability to obtain BGAN service in the coverage area depends on a number of factors, such as unobstructed view to the satellite, licensing conditions etc.

Inmarsat plans to launch a third satellite, F3, at a later stage, extending BGAN satellite coverage to virtually the entire surface of the earth.

Overview of the BGAN System

A complete BGAN system includes the EXPLORER™ 500 with connected peripherals, the BGAN satellite, and the Satellite Access Station (SAS). The satellites are the connection between your terminal and the SAS, which is the gateway to the worldwide networks (Internet, telephone network, cellular network, etc.).

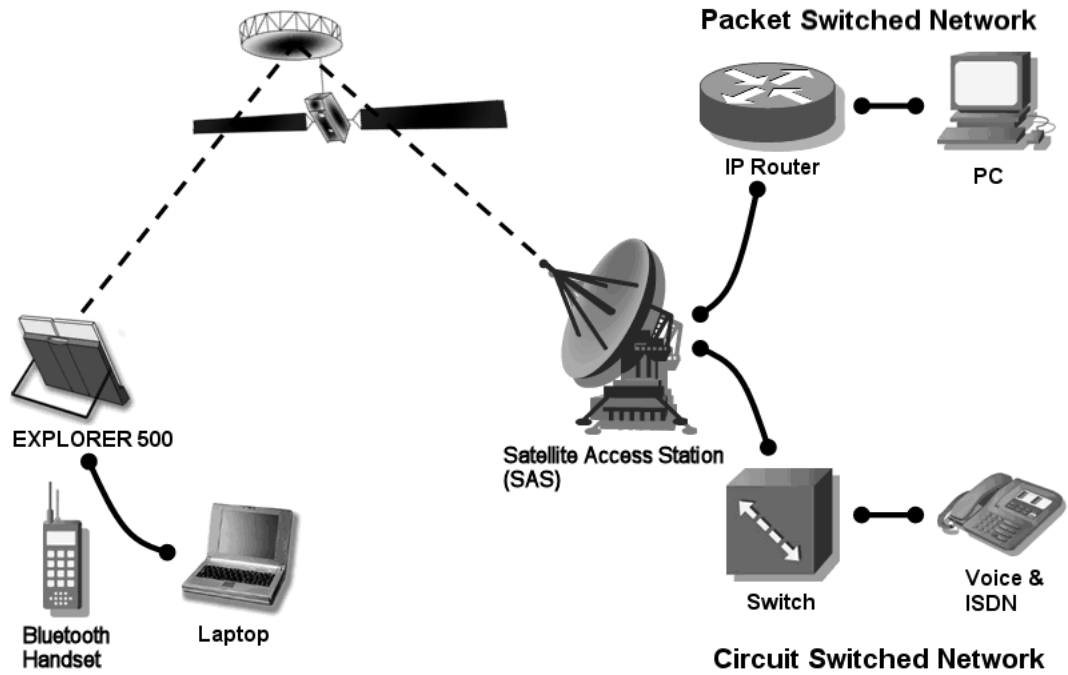

The BGAN Services

Supported Services

The services currently supported by BGAN comprise:

- IP connection to the Internet
- Dialed connection for voice, fax or data
- Short Messaging Service (SMS)

IP Service

The BGAN network supports different classes of data connection to the Internet.

- Using a **Standard data** connection, several users can share the data connection simultaneously. This type of connection is ideal for e-mail, file transfer, and internet and intranet access.
The user pays for the amount of data sent and received (per MB charge).
- Using a **Streaming data** connection, you get an exclusive, high-priority connection, ensuring seamless transfer of data. This type of connection is ideal for time critical applications like live video over IP.
The user pays for the duration of the connection (per minute charge).

Dialed Service

Two types of voice connection are available:

- **Standard voice:** A low-tariff connection for voice only. The voice signal is compressed to 4.0 kbps, which reduces the bandwidth use and subsequently the tariff.
- **Premium voice:** A high quality connection which can be used for voice, G.3 fax or PSTN modem.
The signal is uncompressed 3.1 kHz audio, which allows for optimum voice quality.

SMS Service

The BGAN system provides a Short Messaging Service (SMS) for sending and receiving SMS messages.

Supplementary Services

The BGAN system also provides the following Supplementary services:

- Call barring
- Call hold
- Call waiting
- Call forwarding
- Voice mail

Overview of the EXPLORER™ 500

Features

The EXPLORER™ 500 provides the following features:

- High speed data up to 464 kbps - shared bandwidth
- Support for streaming classes 32, 64 and 128 kbps
- Simultaneous voice and data
- Standard interfaces (LAN, USB, Bluetooth and phone/fax)
- Lightweight and portable design
- Easy setup and use
- Robust and durable design

Overview of Interfaces

The EXPLORER™ 500 provides a number of interfaces for connection of data equipment, fax devices and phones.

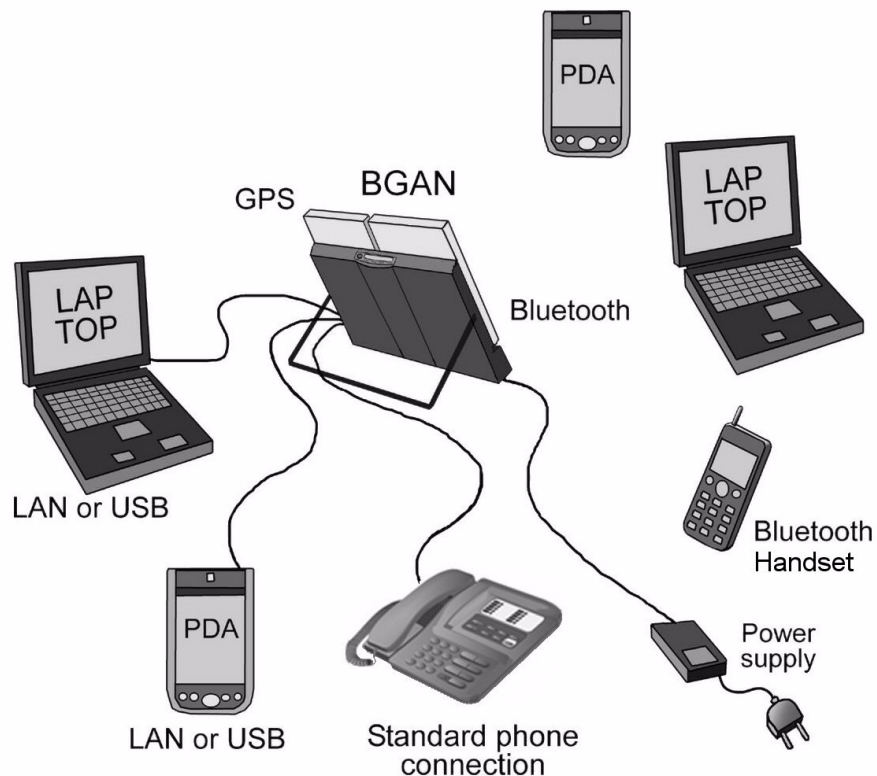

Using the **Interfaces** on page 4-1 describes how to use each of the available interfaces.

Power Saving

The EXPLORER™ 500 is designed to save power. This means that functions that are not currently used will automatically go into a “sleep mode” to save power.

In addition to the automatic power saving, you can turn each of the interfaces off if they are not currently used. Note, however, that you will not be able to use these interfaces until you turn them back on. For information on how to turn interfaces on and off, see **Turning an Interface on or off** on page 4-3.

Your EXPLORER™ 500

Overview

The EXPLORER™ 500 is a compact unit, comprising antenna, compass, display and keypad, all in one unit.

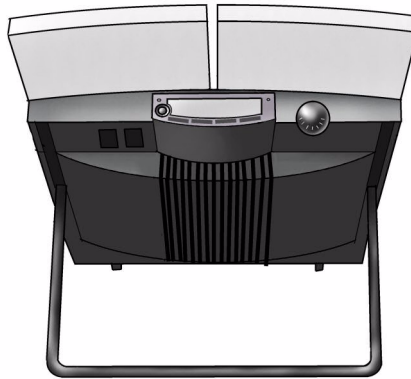

Display and Keypad

The EXPLORER™ 500 has a display and a keypad for displaying status and for changing simple parameters.



For information on how to use the keypad and display, and for an overview of the display menu system, see **Using the Display and Keypad** on page 3-1.

Light Indicators

The EXPLORER™ 500 has two light indicators next to the display: a green power indicator and a red message indicator.

Green Power Indicator

The function of the **green Power indicator** to the left of the display is as follows:

Behaviour of Green Indicator	Meaning
Short flash every 2 seconds	The EXPLORER™ 500 is on.
Steady light	The battery is charging.
Flashing rapidly	A charging error has occurred. For further information, refer to Troubleshooting Guide on page 6-4.
Off	No power.

Red Message Indicator

The function of the **red Message indicator** is as follows:

Behaviour of Red Indicator	Meaning
Flashing	A message is present in the display. Read the message and then acknowledge it by pressing OK . The red light will keep flashing after OK is pressed if: <ul style="list-style-type: none"> • there are more messages, or • the message is information of an error. For information on error messages, see Error Messages on page 6-10.
Off	No messages are present.

User Interfaces

The **keypad and display** is used for pointing the antenna, for displaying status and for changing simple parameters.

To obtain full access to all features and for ease-of-use, you should use a data unit (a PC, Laptop, PDA or similar) and one of the following:

- The built-in **Web interface**. The EXPLORER™ 500 has a built-in Web interface for easy configuration and daily use. The Web interface is accessed directly from a data unit connected to the EXPLORER™ 500, using a standard Internet browser. For information on the Web interface, see the chapter **Using the Web Interface**.
- The Inmarsat **Launch Pad**. Launch Pad is a PC application used to control terminals in the BGAN system. Launch Pad is provided on the Inmarsat CD ROM supplied with your EXPLORER™ 500. For information on how to use the Launch Pad, refer to the manual on the Inmarsat CD ROM.

Additionally, it is possible to control the EXPLORER™ 500 using AT Commands. Refer to the appendix **AT Commands**.

Antenna

The white part of the EXPLORER™ 500 is the antenna module. The antenna module comprises a GPS antenna, a BGAN antenna and a Bluetooth antenna.

Compass

The EXPLORER™ 500 also provides a compass to help positioning the antenna. For further information on how to use the compass, see **Pointing the Antenna** on page 2-10.

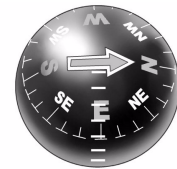

Battery

The EXPLORER™ 500 comes with a rechargeable battery, which is easily inserted in the terminal. The battery is automatically charged when power is applied to the EXPLORER™ 500. Steady green light indicates that the battery is charging.

SIM Card

The SIM card of the EXPLORER™ 500 is a standard SIM card, which is acquired from the Airtime provider.

The EXPLORER™ 500 requires a SIM card to go online and to access the settings of the EXPLORER™ 500. Without a SIM card you can only see the Main screen of the display system, showing battery status etc.

Matrix of Services and Communication Interfaces

The following table shows which services can be accessed from which interfaces, and which types of equipment can be used.

Service		Interface on the EXPLORER™ 500				
		Phone/Fax	Bluetooth	USB	LAN	Display/Keypad
Dialled Connection	Premium voice	Analogue telephone	Bluetooth handset			
		G.3 Fax machine				
	Standard voice	Analogue telephone	Bluetooth handset			
	Data	Data unit with modem	Data unit with Soft modem			
IP Connection	Data multi-user		Data unit		Data unit with Switch/Hub	
	Data single-user		Data unit	Data unit	Data unit	
SMS			Data unit	Data unit	Data unit	View only

What's Next?

This chapter has provided an overview of the BGAN system and of the EXPLORER™ 500.

The next chapters will go into more detail about how to set up and use the EXPLORER™ 500. The following chapter, **Getting Started**, explains how to unpack and start up the EXPLORER™ 500, and how to point the antenna in order to get the best possible signal.

Getting Started

In This Chapter

This chapter describes

- what is included in the delivery
- how to insert the battery and SIM card
- how to start up the EXPLORER™ 500 and make the first call

Unpacking and Assembling

Unpacking

Unpack the EXPLORER™ 500 and accessories.

Check that the following items are present:



Instruction Kit
Including:
- Getting Started
- Quick Guide
- Thrane & Thrane CD-ROM
- Inmarsat CD-ROM



AC/DC Power Supply



LAN Cable



Battery

Inserting the SIM Card

The EXPLORER™ 500 normally comes with the battery separated from the user terminal. If the battery is already inserted, remove it as described in **Removing the Battery** on page 2-3.

The SIM card is provided by your Airtime Provider. Insert the SIM card as follows:

1. Insert the SIM card into the SIM slot. Make sure the SIM card is positioned as shown!
2. Press gently until it clicks.

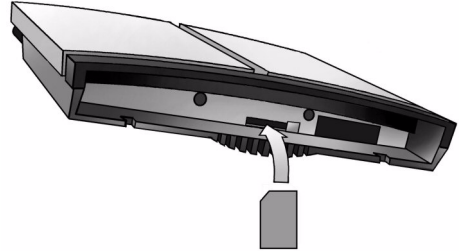

3. Slide the lock to close the SIM slot.

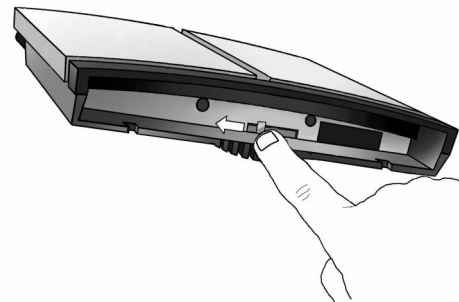

Inserting the Battery

Do as follows:

1. Insert the battery.
Make sure the battery is positioned correctly as shown.
2. Press gently until it locks.

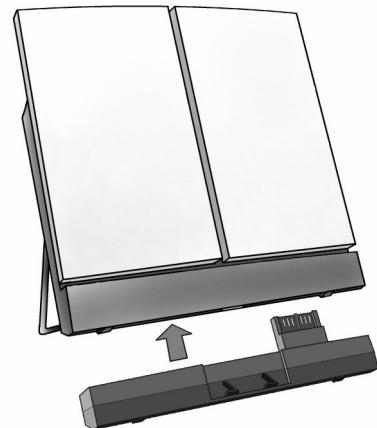

Note

Before using the EXPLORER™ 500 the first time, It is recommended to fully charge the battery.

To charge the battery, insert it into the EXPLORER™ 500 and connect the EXPLORER™ 500 to power.

The indicator left to the display is constantly green as long as the battery is charging. When the battery is fully charged, the green indicator is turned off. If the EXPLORER™ 500 is switched on, the green indicator will be flashing shortly every 2 seconds.

Removing the Battery

To remove the battery, do as follows:

1. Locate the slide lock at the bottom of the unit.
2. Slide the lock aside to release the battery from the unit.

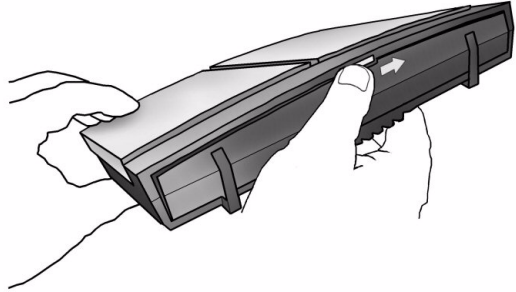

3. Remove the battery.

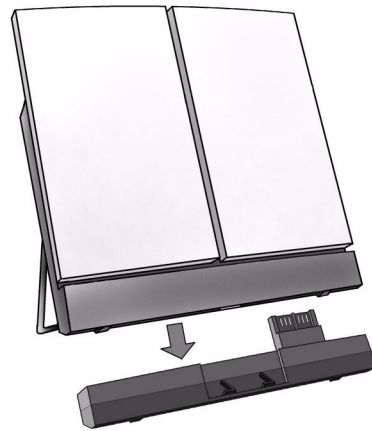

Removing the SIM Card

To remove the SIM card, first remove the battery as described in **Removing the Battery** on page 2-3.

Note

When the SIM card is removed, you cannot use the display menu system nor make calls or start data sessions.

Only emergency calls are allowed, and only if permitted by the network.

You can see the battery status and the signal strength in the display.

Remove the SIM card as follows:

1. Slide the lock aside to open the SIM slot as shown.

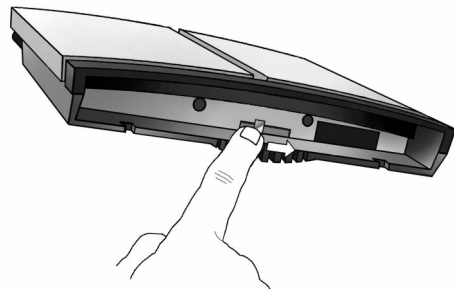

2. Gently press the SIM card and let it pop out of the slot.

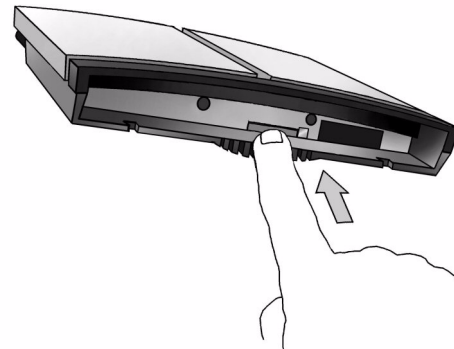

3. Remove the SIM card.

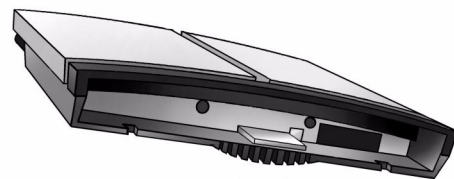

Connecting Cables

After inserting SIM card and battery, connect all relevant cables.

For information on how to connect to a specific interface, see the corresponding section in the chapter **Using the Interfaces**. However, connecting to power is described at the end of this section.

Important

Connect the cables before making the final adjustment of the antenna position. Otherwise you may accidentally move the antenna when you connect the cables.

Side Connector Panel

The connector panel is placed on the side of the EXPLORER™ 500 and has the following connectors:

- USB connector for data equipment
- Phone/fax connector for phone, fax or PSTN modem
- LAN connector for data equipment
- DC power connector (10-16 V DC) for connection to a 115/230 V AC/DC power supply or to a charger cable which connects to the cigarette lighter in a car.

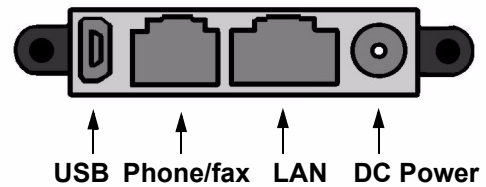

Rear Connectors

Apart from the connectors in the connector panel, the EXPLORER™ 500 has two connectors placed on the rear side of the EXPLORER™ 500:

- a connector for the Thrane & Thrane **external antenna**, marked **ANT** and
- a connector for **charging the EXPLORER™ 500 Bluetooth Handset**, marked **DC OUT**.

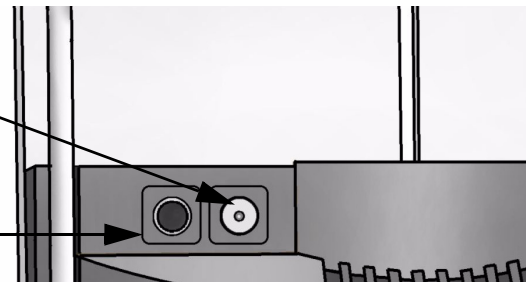

Before Connecting to Power

You can connect to power or use the battery delivered with your EXPLORER™ 500.

Refer to **Power Input** on page A-3 for specifications and pin-out for the DC power input.

If you are connecting to 115/230 V Mains, use the AC/DC power supply included with your EXPLORER™ 500.

You may also connect directly to the cigarette lighter socket in a car. A suitable charger cable is available from Thrane & Thrane.

Connecting to Power

You can connect the DC input to power without the battery inserted.

If the battery is inserted when you apply power to the EXPLORER™ 500, the battery is automatically charged.

Connecting to 115/230 V Mains: Connect the AC/DC power supply to the DC power input of the EXPLORER™ 500. Then connect the power cable between 115/230 V Mains and the AC/DC power supply.



Connecting to the cigarette lighter in a car: Connect the charger cable between the DC power input of the EXPLORER™ 500 and the cigarette lighter socket in the car.

Powering the EXPLORER™ 500

Switching On the EXPLORER™ 500

Note

The default behaviour of the EXPLORER™ 500 is to power up automatically when you connect the power cable. If you wish, you can change this power up mode, so that the EXPLORER™ 500 is only powered if the power button is pressed.

For further information on power up mode, see **Setting the Power up Mode** on page 3-10 or **Power up Behaviour** on page 5-11.

To switch on the EXPLORER™ 500, push the power button next to the display and hold it down for a second until the green Power indicator lights up.

Power Indicator
Power Button



To switch off the EXPLORER™ 500, push the power button again and hold it for a second, until the display shows “Switching off...”.

After switching on the EXPLORER™ 500 you will be prompted for a PIN code, unless the PIN code is disabled.

For information on how to disable the PIN code, see **Changing or Disabling the PIN Code** on page 5-17.



For information on the options after power on, see the next section.

Options for the Start-up Procedure

You have different options for the start-up procedure. Each of these options are briefly described in this section.

For information on how to enter PIN code and point the antenna, see the subsequent sections.

Overview of the Start-up Options

The following drawing shows the options available after power on. Note that if the use of PIN code is disabled, the display sequence is the same as after successfully entering the PIN code. This means that after power on, you will see the Signal strength screen.

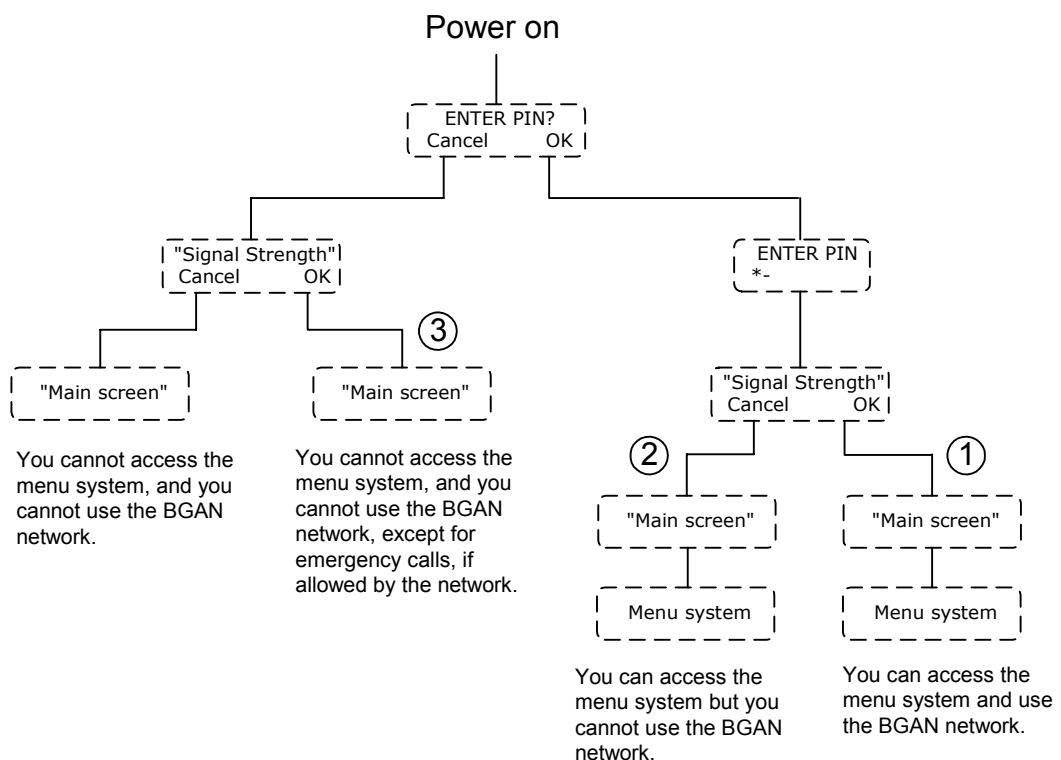

1: "Full" Procedure

After power on, enter the PIN code and then point the antenna.

In this mode you have full access to the EXPLORER™ 500, that is you can use the menu system and communicate on the BGAN network.

The display will show READY when the menu system is not activated.

2: “Off-line” Procedure

After power on, enter the PIN code, but cancel pointing.

In this mode you can use the menu system, but are not able to communicate on the BGAN network.

The display will show `POINT NOW?` when in the Main screen.

Press ▲ or ▼ to enter the menu system.

If you want to point the antenna later, press **OK** from the Main screen.

3: “Emergency” Procedure

After power on, cancel the PIN code and then point the antenna.

In this mode you can only place emergency calls, and only if permitted by the network. You are not able to access the menu system nor to communicate on the BGAN network (apart from emergency calls), until you enter the PIN code.

The display will show `ENTER PIN?`

If you press **OK** you can enter the PIN code. No other options are available from the keypad.

Entering the PIN Code

Overview

You have to enter a PIN code to use the EXPLORER™ 500, unless the use of PIN codes is disabled using the built-in Web interface of the EXPLORER™ 500 (see **Disabling the PIN Code** on page 5-17).

Note

The first time you are asked for a PIN code, you can choose to cancel (press **C**). If you cancel, you are asked again after pointing is completed. At that point you must enter the PIN code to be able to continue.

To Enter the PIN Code

To enter the PIN code using the display and keypad, do as follows:

1. When you are asked for a PIN code, press **OK**.
2. Press **▲** or **▼** a number of times until the first digit is correct.



3. Press **OK** to go to the next digit.
When **OK** is pressed, the previous digit is indicated by a *.



To correct an entered digit, press **C** to go back and use the **▲** and **▼** buttons again.

4. After entering the last digit with **OK**, press **OK** again to apply the PIN code.

Note

At this point the EXPLORER™ 500 may make a sound. This sound is used for pointing the antenna. To turn off the pointing sound, press **▲** or **▼**.

For further information on how to use the keypad and display, see **Using the Display and Keypad** on page 3-1.

Note

You can enter the PIN code using a phone or data unit connected to the EXPLORER™ 500. For further information, see **Entering the PIN Code Using a Phone** on page 4-7 or **Entering the PIN Code in the Web Interface** on page 5-4.

Wrong PIN Code

You have 3 attempts to enter the PIN code, before you are asked to enter the PUK code. The PUK code is supplied with your SIM card.

Enter the PUK code followed by a new PIN code of your own choice. The PIN code must be from 4 to 8 digits long.

If you enter a wrong PUK code 10 times, the SIM card will no longer be functional, and you have to contact your Airtime provider for a new SIM card.

Pointing the Antenna

The Importance of Pointing

In order to obtain the best possible signal at the lowest possible cost, it is important that the EXPLORER™ 500 antenna is pointed correctly towards the satellite.

Incorrect pointing may result in poor quality of the signal, and in some cases retransmission may be necessary, which could mean you will be paying more than necessary for your transmission.

The antenna must have a clear line of sight to the satellite, without any obstacles blocking the signal, and the pointing direction of the antenna should be as accurate as possible.

The next sections describe how to point the antenna for the best possible signal.

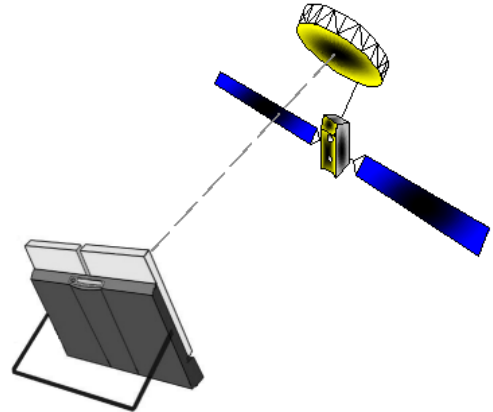

Pointing Data

If the position of the satellite in relation to the EXPLORER™ 500 is known, you can use the compass to roughly point the antenna in the right direction. If you know the **Azimuth** and the **Elevation**, you can use this data to adjust the antenna.

- The **Azimuth** is the horizontal rotation angle relative to North (moving clockwise).

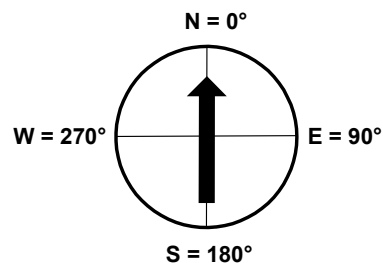

- The **Elevation** is the vertical rotation angle relative to horizontal. This means that an Elevation of 0° corresponds to the terminal being in an upright position, pointing towards the horizon.

The compass has 7 lines dividing the Elevation scale into 6 spaces. The space between two lines corresponds to 15°.

Front of Terminal



The Elevation is measured where the lines meet.

This compass shows an Elevation of 30° (2 spaces up from the first line) and an Azimuth of 270° (antenna pointing towards West)

Note

The above explanation assumes that the compass shows the exact orientation. Please take into consideration the possible deviation and variation that can occur, e.g. because of the location or the presence of magnetic objects.

Minimum Signal Strength

The following table shows the minimum signal strength required for different types of transmission.

Note These figures are only guidelines; they do not represent a guarantee of operation at the stated signal strength. Also, these figures are yet to be confirmed in practice.

Type of Service	Minimum Required Signal Strength
Standard Data	51 dBHz
Streaming 32 kbps	51 dBHz
Streaming 64 kbps	54 dBHz
Streaming 128 kbps	57 dBHz
Standard Voice	51 dBHz
Premium Voice	TBD

Pointing the Antenna Towards the Satellite

Important When pointing the antenna, **do not touch** the white antenna part of the EXPLORER™ 500. If you place your fingers on the antenna part, you will be blocking the signal, and the antenna will not work properly.

You can hold the support bracket and the battery module below the antenna while pointing the EXPLORER™ 500.

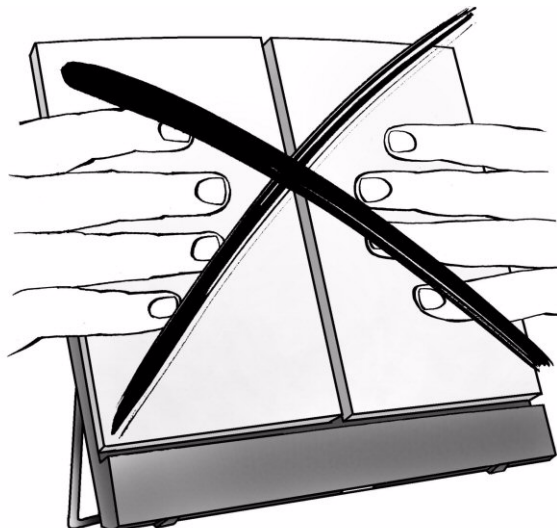

Do as follows to point the antenna:

1. While observing the built-in compass of the EXPLORER™ 500, rotate the EXPLORER™ 500 left or right until it points in the correct horizontal direction, known as the **Azimuth**. Refer to **Pointing Data** on page 2-10.

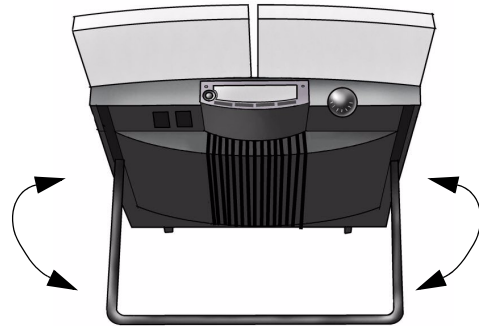

2. Tilt the EXPLORER™ 500 slowly up or down until it points in the correct vertical direction, known as the **Elevation**. Refer to **Pointing Data** on page 2-10.

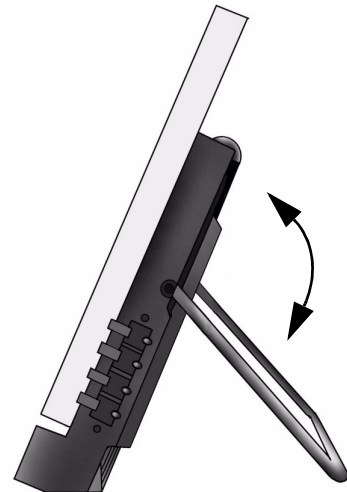

Note Make sure all cables are connected before fine adjusting the antenna position. If you connect cables after the final adjustment of the antenna position, you may accidentally move the antenna.

3. After passing the PIN code screen, the display shows the current satellite signal strength. Use this information to fine-adjust the antenna position as shown in step 1 and 2. Remember not to touch the antenna part.



Important When fine-adjusting the antenna, the display may take a while to update the signal strength. Wait a while after each move, to make sure the display is updated.

A sound also indicates the signal strength (if enabled). The frequency of the tone increases with the signal strength. To turn off the pointing sound, press ▲ or ▼.

Note If the right most part of the signal strength bar is grey, it indicates that the level has previously been higher than the current level.

4. When you have obtained the highest possible signal strength, press **OK** on the keypad. The EXPLORER™ 500 now tries to establish a connection to the BGAN network. The display shows the progress as follows:



- **SEARCHING:** The EXPLORER™ 500 searches for the network operator. Note that the search procedure can be very short, so you may not see this text.
- **ATTACHING:** The EXPLORER™ 500 is registering itself on the network.
- **READY:** The EXPLORER™ 500 is registered on the network and is ready to go online.

Note

The display may show a different text than **READY** if there is more important information to show. For example, the display will show **ENTER PIN?** if you pressed **C** at the first request for a PIN code.

Using an External Antenna

The EXPLORER™ 500 has a connector for attaching an external antenna.

Important Only use the specified antenna from Thrane & Thrane. The antenna and accessories for connecting to the EXPLORER™ 500 are listed in **Options and Accessories** on page 6-2.

The connector is placed at the back of the EXPLORER™ 500. For further information on the interface, see the technical specifications in **External Antenna** on page A-9.

Using a Fixed EXPLORER™ 500

You can keep the EXPLORER™ 500 in a fixed position, using the pole mount option.

Note The EXPLORER™ 500 is not suited for permanent outdoor installation. Use an external antenna if the installation is to be permanent.

Do as follows:

1. Mount the Pole Mount bracket on the EXPLORER™ 500 as shown.

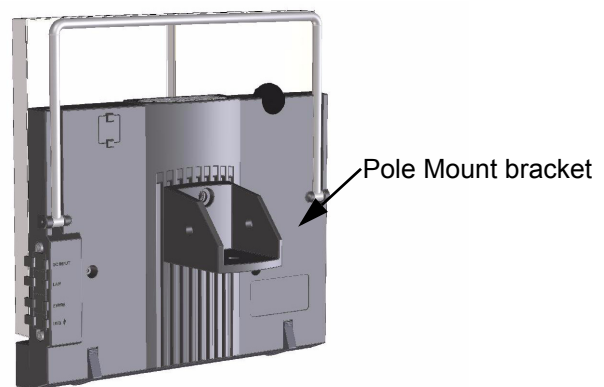

2. Mount the EXPLORER™ 500 on a pole.
3. Start up the EXPLORER™ 500 and point the antenna as described in **Pointing the Antenna Towards the Satellite** on page 2-11.
4. Accept the signal strength by pressing **OK** on the EXPLORER™ 500 keypad.

You only have to point the antenna once, when you mount it. Using a PC connected to the EXPLORER™ 500, you can set up the EXPLORER™ 500 to skip pointing at next power up. Refer to **Pointing at Power up** on page 5-11.

Making the First Call

After connecting cables, entering the PIN code and pointing the antenna, you are ready to make or receive the first call.

The following sections provide a short guide to making calls. For more detailed information, see **Making or Receiving a Phone Call With the EXPLORER™ 500** on page 4-8.

Making a Call From the EXPLORER™ 500

If you are using an analogue phone, it must be connected to the phone/fax interface of the EXPLORER™ 500. See **Before Connecting to the Phone/Fax Interface** on page 4-6.

If you are using a Bluetooth handset, the Bluetooth handset and the EXPLORER™ 500 must be paired and connected before you can make a call. See **Handling Bluetooth Device Access** on page 4-17.

To make a call from a phone connected to the EXPLORER™ 500, dial:

00 <country code> <phone number> followed by # or off-hook key (# on analogue phones, off-hook key on Bluetooth handsets).

Example: To call Thrane & Thrane in Denmark (+45 39558800) from an analogue phone, dial: **00 45 39558800 #**

Making a Call to the EXPLORER™ 500

To make a call to a phone connected to the EXPLORER™ 500, dial:

+870 <Mobile number>

- + is the prefix used in front of the country code for international calls. This is **00** when calling from countries in Europe and from many other countries.
- **Mobile number:** The mobile number of the EXPLORER™ 500 you are calling. The mobile numbers of the EXPLORER™ 500 are listed in the display menu system of the EXPLORER™ 500 under **PROPERTIES > MOBILE NUMBERS**.

Note | There are two voice numbers, one for Premium voice and one for Standard voice.

Example: If you are calling from Denmark and the terminal's Mobile number for Premium voice is 772112345, and you want to make a call to the terminal using Premium voice, dial: **00 870 772112345**

Making a Call from one EXPLORER™ 500 to Another EXPLORER™ 500

To make a call from a phone connected to one EXPLORER™ 500 to a phone connected to another EXPLORER™ 500, dial **00 870 <Mobile number>**.

Receiving a Call

To be able to receive a call with an analogue phone, the phone must be connected to the Phone/fax interface of the EXPLORER™ 500.

To be able to receive a call with a Bluetooth handset, the handset must be paired with the EXPLORER™ 500. For information on how to pair Bluetooth devices, see **Handling Bluetooth Device Access** on page 4-17.

Information of unanswered calls is stored in the call log of the EXPLORER™ 500.

Making the First Data Connection (LAN)

Note

For the LAN interface to work without any further setup, the data unit must be set up to obtain an IP address and a DNS server address automatically. To check these settings on your data unit, do as follows:

For Windows® XP (Classic Start menu), expand the **Start** menu and select **Settings > Network Connections > Local Area Connection**.

Then select **Internet Protocol (TCP/IP)** and click **Properties**.

Make sure both fields are set to obtain an address automatically.

Do as follows:

1. Connect the LAN cable to the network interface of your data unit.
A suitable cable is provided with your EXPLORER™ 500.
2. Connect the other end of the cable to the LAN connector on the EXPLORER™ 500.
3. Start up and point the EXPLORER™ 500 as described earlier in this chapter.
4. Power on the data unit.
5. When power up and pointing is completed, check the connection, e.g. by starting your Internet Browser.

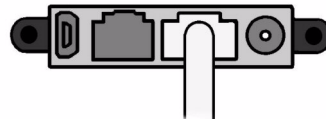

Note

You may have to disable the Proxy server settings in your browser. For further information, see **Browser Settings** on page 5-2.

What's Next?

After reading this chapter you should be able to start up the EXPLORER™ 500 and make a simple data or voice connection.

The next chapters provide more information on the user interfaces and the setup of the EXPLORER™ 500. The following chapter, **Using the Display and Keypad**, explains the display menu system, which is the basic tool for setting up the EXPLORER™ 500.

Using the Display and Keypad

In This Chapter

This chapter describes how to use the built-in display menu system of the EXPLORER™ 500.

It contains an overview of the entire menu system followed by a description of each menu. It also explains the symbols and messages that may appear in the display, and describes how to navigate using the keypad.

Menu Overview

Main Menu

The items of the main menu are:

- **Messages**
shows all incoming SMS messages and allows you to open or delete each message or delete all messages.
- **Calls**
shows missed, received and outgoing calls.
- **Settings**
allows you to restart the pointing procedure, set display brightness and contrast, set audio indications on or off, turn each interface on or off, enable or disable stealth mode (a terminal mode where lights and sound are off), set the power up mode and restore settings.
- **Properties**
shows which Bluetooth devices are known and accepted, and shows IP address, hardware and software numbers, IMEI number and mobile numbers. It also shows the alarm list and the GPS status.
- **Help Desk**
shows the phone number to the airtime provider.

For information on how to navigate in the menu system, see **Navigating the Display and Keypad** on page 3-5.

Menu Drawing

The below drawing shows an overview of the menus in the display menu system of the EXPLORER™ 500.

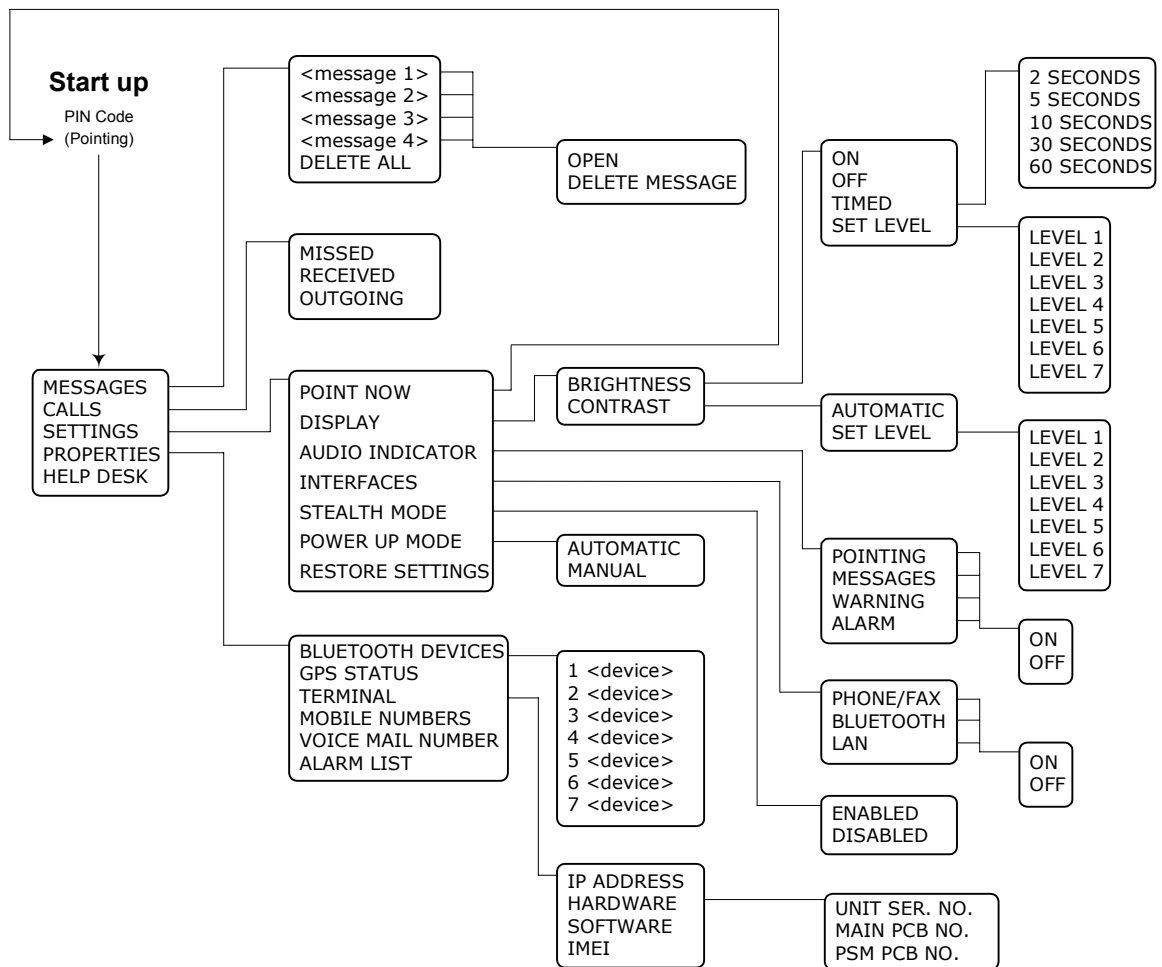

The next section shows an overview of the start-up sequence before entering the menu system, and the menus are further described in the following sections of this chapter.

Display Sequence at Start-up

There are different options for the start-up procedure. The below drawing shows the different sequences.

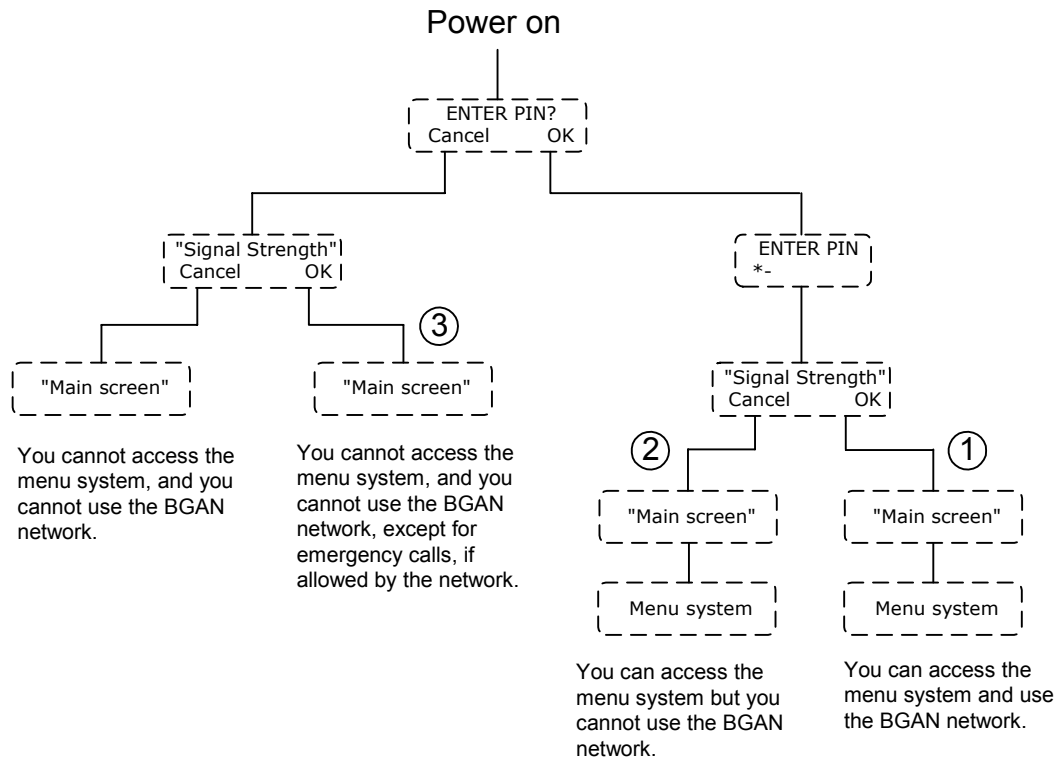

The complete startup procedure is described in the chapter **Getting Started**. This section only describes the behaviour of the display during startup.

PIN Code

Just after powering up the EXPLORER™ 500 you are asked if you want to enter the PIN code. You can press **OK** and enter the PIN code, or you can press **C** and wait until you are asked again after pointing.

Note

Until you enter the PIN code, you will not be able to enter the menu system nor to communicate on the BGAN network.

After entering the PIN code or pressing **C** to skip, you enter the pointing screen.

Pointing

The Pointing screen shows the signal strength.

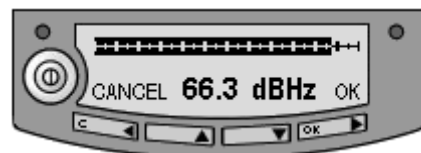

CANCEL: If you press **C**, you exit the pointing menu and the display shows the Main screen with the message **POINT NOW?**.

If the PIN code has been entered, you now have access to the menu system, but you will not be able to connect to the BGAN network, because the signal strength has not yet been accepted.

OK: When you press **OK**, the EXPLORER™ 500 tries to establish a connection to the BGAN network.

The display shows the progress in the Main screen as follows:

- **SEARCHING:** The EXPLORER™ 500 is searching for the network operator.
- **ATTACHING:** The EXPLORER™ 500 is registering itself on the BGAN network.
- **READY:** The EXPLORER™ 500 is registered on the network and is ready to go online.

Main Screen

The Main screen is shown after passing the PIN code and pointing screens, and anytime you leave the menu system.







The Main screen shows the most important status of the EXPLORER™ 500, such as battery status, signal strength, and general status.

The Main screen also shows icons for any interfaces that are turned on. In this example, all interfaces (Phone/fax, Bluetooth, USB and LAN) are turned on.



Display Symbols

Apart from the menu text, the display can show various symbols. Below is a list of the possible symbols with an explanation to each symbol.

Symbol	Explanation
	The battery charge level. When the level is too low (below 10%) the icon flashes. Recharge the battery as soon as possible. If no battery is inserted, the symbol is not shown in the display.
	The battery is charging.
	The signal strength. Minimum one bar is required to be able to make a Standard voice call.
	LAN interface is on.
	USB interface is on.
	Bluetooth interface is on.
	Phone/fax interface is on.

Navigating the Display and Keypad

Navigating with the Keypad

Note The PIN code must be entered before you can access the menu system.



- **To access the menu system from the Main screen,** press ▲ or ▼.
- **To move up and down in the current menu,** press ▲ or ▼.
- **To select the current menu item or setting,** press OK.
- **To escape the current menu/setting** and return to the previous level, press C.
- **To see the hidden part of long text strings,** press ►.

- To move backwards in the menu system, or in long text strings, press ◀.
- To adjust settings, press ▲ and ▼.

Short-Cuts

The following short-cuts are available in the menu system:

- To exit the menu system, press and hold **C** for one second. The display returns to the Main screen.
- To activate/deactivate **Stealth mode**, Press **C+OK**.¹
When stealth mode is activated, the display shows **STEALTH ACTIVATED** for a moment; then all lights and sounds are turned off.

Note ▶ For Stealth mode to be available, it must be enabled in the EXPLORER™ 500. Refer to **Enabling or Disabling Stealth Mode** on page 3-9.

- To turn **Pointing sound on/off**, Press ▲ or ▼ from the pointing screen.

Note ▶ This action only applies to the current pointing session. To turn the sound on or off for all pointing sessions, select **SETTINGS > AUDIO INDICATORS > POINTING** and select **ON** or **OFF**.

Display Text

When you have not entered the menu system, the Main screen shows the currently most important information. For further information, see **Text Information in the Display** on page 3-13.

CANCEL in the left side of the display means: Press **C** to cancel the current operation.

OK in the right side of the display means: Press **OK** to accept the current operation.

1. **C+OK** means: Press **C** and hold it while pressing **OK**.

The Menu

The following sections describe each of the menus in the menu system.

All available settings and status items are explained.

To access the menu system from the main screen, press ▲ or ▼.



Messages Menu

Viewing the List of Messages

To see the list of SMS messages, enter the menu system and select **MESSAGES**. The messages are listed with the name (if known) or the number of the sender.

An unopened envelope indicates an unread message and an opened envelope indicates a read message.

Use ▲ and ▼ to scroll through the list.

Opening or Deleting Received SMS Messages

In the **MESSAGES** list, select the message you want to open or delete and press **OK**. Then select one of the following:

- **OPEN** to open the selected message.
The display shows the time and the message contents. Use ▲ and ▼ to scroll through the message and details.
- **DELETE** to delete the selected message.

To delete all messages, go to the bottom of the list of messages and select **DELETE ALL**.

Calls Menu

To see a list of calls, select **CALLS** and then one of the following:

- **MISSED** to see a list of incoming calls that were not answered
- **RECEIVED** to see a list of incoming calls that were answered
- **OUTGOING** to see a list of outgoing calls

Note | Local calls are not registered.

Select a call from the list to see details, such as time, date and phone number.

When there are more than 100 calls in the list, the oldest calls are automatically deleted to make room for new calls.

Settings Menu

Point Now

Important | This function will cause interruption of any ongoing calls or sessions!

If you need to repoint the antenna after the first pointing process, select **SETTINGS > POINT NOW**.

This will bring you to the Pointing screen. See **Display Sequence at Start-up** on page 3-3, where the pointing screen is described.

Setting the Display Brightness

To adjust the brightness of the display, select **SETTINGS > DISPLAY > BRIGHTNESS**.

From this menu you can set the brightness of the display. Select one of the following:

- **ON** to turn the light on
- **OFF** to turn the light off
- **TIMED** to set how long the light should be on after the last key was pressed (2, 5, 10, 30 or 60 seconds)
- **SET LEVEL** to set the level of brightness

Setting the Display Contrast

To adjust the contrast of the display, select **SETTINGS > DISPLAY > CONTRAST**.

From this menu you can set the contrast of the display. Select one of the following:

- **SET LEVEL** to set the contrast manually
- **AUTOMATIC** to let the EXPLORER™ 500 automatically adjust the contrast according to the temperature.

Turning Audio Indicators On or Off

The EXPLORER™ 500 can make a sound to indicate an event.

You can turn each of these audio indicators on or off.

Select **SETTINGS > AUDIO INDICATOR** and select one of the following:

- **POINTING** - sound to indicate the signal level during pointing
- **MESSAGES** - sound to indicate that a message has arrived
- **WARNING** - sound to indicate that a warning is present
- **ALARM** - sound to indicate that an alarm is present

Then select **ON** or **OFF**.

Turning Interfaces On or Off

Each interface (except USB) can be turned off to save power.

Specially if the EXPLORER™ 500 is battery powered, it is a good idea to save power by turning unused interfaces off.

To turn an interface on or off, select **SETTINGS > INTERFACES** and select one of the following interfaces:

- **BLUETOOTH**
- **PHONE/FAX**
- **LAN**

Then select **ON** or **OFF**.

Enabling or Disabling Stealth Mode

In certain situations it may be important that the EXPLORER™ 500 is not seen nor heard.

When the EXPLORER™ 500 is in stealth mode, all lights and sounds are turned off. You can still use the terminal, and the display text is readable.

To enable or disable the use of stealth mode, select **SETTINGS > STEALTH MODE** and select one of the following:

- **ENABLED**
- **DISABLED**

Note | Enabling stealth mode will not put the terminal into stealth mode, it only enables the use of stealth mode.

To activate Stealth mode (after enabling Stealth mode), press **C+OK** on the keypad.

To deactivate Stealth mode, press **C+OK** again.

Setting the Power up Mode

As default, the EXPLORER™ 500 starts up automatically when you apply external power.

You can change this mode, so that you always have to press the power button to switch on the EXPLORER™ 500.

To set the power up mode, select

SETTINGS > POWER UP MODE and select one of the following:

- **AUTOMATIC** to have the EXPLORER™ 500 power up automatically when external power is applied.
- **MANUAL** to have the EXPLORER™ 500 power up only when the power button is pressed.

Restoring Settings

You can restore the settings made with keypad and display to default settings. Note, however, that the display contrast remains as is.

Important | Be careful - this function will overwrite all your settings from the display/ keypad, except display contrast!

To restore settings, select **SETTINGS > RESTORE SETTINGS**. Then press **OK**.

Properties Menu

Viewing Known Bluetooth Devices

You can view a list of the Bluetooth devices that have been accepted by the EXPLORER™ 500. The devices are listed with their Bluetooth name and local phone number.

The devices in this list can communicate with the EXPLORER™ 500 without any further setup.

To view the list of known Bluetooth devices, select **PROPERTIES > BLUETOOTH DEVICES**.

The devices are listed in the same order they were paired.

To see details on a specific Bluetooth device, select the device in the list and press **OK**.

Viewing the GPS Status

The display can show the current GPS status.

To view the GPS status, select **PROPERTIES > GPS STATUS**

The GPS status screen can vary, depending on the situation.

- If the GPS position has not yet been obtained, the display shows the status of each of the 16 GPS satellites as follows:



- If the GPS position is known, the display shows the GPS position, and whether it is a 2-dimensional or 3-dimensional position (2D fix or 3D fix).



- In some cases, the Satellite Access Station does not allow the position to be displayed to the user. If this is the case, the display shows GPS UNAVAILABLE.



Viewing Terminal Properties

You can view properties of the EXPLORER™ 500, such as IP address, hardware numbers, software version and IMEI number. When contacting Support, please include these numbers.

To view the properties, select **PROPERTIES > TERMINAL** and select one of the following options:

- **IP ADDRESS** to see the IP address of the built-in Web interface of the EXPLORER™ 500. The Web interface is a built-in web server used to configure and set up the EXPLORER™ 500. For further information on the Web interface, see **Using the Web Interface** on page 5-1.
- **HARDWARE** to see the serial number and PCB numbers of your EXPLORER™ 500.
- **SOFTWARE** to see the software version of the EXPLORER™ 500.
- **IMEI** to see the IMEI number (International Mobile Equipment Identity) of the EXPLORER™ 500. This is the unique mobile equipment number that identifies your EXPLORER™ 500.

Viewing Mobile Numbers

The **MOBILE NUMBERS** menu lists the mobile numbers to use when calling the EXPLORER™ 500.

Note | There are two voice numbers, one for Premium voice and one for Standard voice. For further information, see **Selecting the Voice Quality** on page 4-4.

To view the mobile numbers, select **PROPERTIES > MOBILE NUMBERS**.

Viewing the Voice Mail Number

The EXPLORER™ 500 informs you of any incoming voice mail through the display and through the Web interface.

The Voice mail service number is the number you call to hear your incoming voice mail. The Voice mail service number is stored on the SIM card.

To view the voice mail number, select **PROPERTIES > VOICE MAIL NUMBER**.

Alarm List

If an error is present in the system, an alarm will be issued.

When an alarm is issued, the display shows that there is an active alarm and the red indicator next to the display is flashing. If you press OK, the display returns to the Main screen, with the text **VIEW ALARM LIST?** If you press OK again, the list of currently active alarms appears.

You can always view the list of currently active alarms by entering the menu system and selecting **PROPERTIES > ALARM LIST**.

For further information on alarms, see **Error Messages** on page 6-10.

Help Desk

If you need support regarding airtime, you may call the Airtime Provider help desk.

To see the Help Desk number, select **HELP DESK** in the menu system.

The display will show the name and phone number of your airtime provider, if it is available on the SIM card.

If the information is not available on the SIM card, you can use the built-in Web interface of the EXPLORER™ 500 to store the help desk name and number. For further information, see **Accessing the Help Desk** on page 5-19.

Displaying Ongoing Transmission

Calls or Data sessions

When a call or data session is in progress, the display shows TRANSMITTING in the Main screen.



WARNING! When the display shows TRANSMITTING, stay clear of the antenna front! The antenna emits radio frequency energy when transmitting. Keep a minimum distance of 0.6 m from the antenna front.

Text Information in the Display

Types of Display Information

Text in the display can be:

- Information of received messages.
- Alarms.
- Status information.
- Request for action.

Received Messages

When messages arrive in your EXPLORER™ 500, the display indicates the number of new messages that have arrived. The messages can be SMS messages or notification of Voice mail.

- If the message is an SMS message, you can go directly to the message list by pressing **OK**.
- If the message is information of Voice mail, you can press **OK** or **C** to go back to the Main screen. The red message indicator will keep flashing until you have collected your Voice mail.
To hear your Voice mail, call the Voice mail service number provided by your Airtime Provider.

To see the Voice mail service number, select
PROPERTIES > VOICE MAIL NUMBER

Note

If you have a data unit connected to your EXPLORER™ 500, you can look up the Voice mail service number using the Web interface.
For further information, see **Viewing or Changing Voice Mail Service number** on page 5-10.

Alarms

When an alarm message appears in the display, you can press **OK** to remove it and go back to the Main screen. However, you have not removed the cause of the alarm.

As long as the cause of the alarm is still present, the Main screen will show `LIST ALARMS?` and the red indicator next to the display will be flashing.

To view the Alarm List, press **OK**. The alarm list shows any alarms that are currently active.

To see the name and the code of an alarm, select it from the list.

To view explanations for any alarms that may appear in the display, refer to the list of Cause codes in **Error Messages** on page 6-10.

Status Information

Status information in the display is normally shown in the lower line of the Main screen.

Examples of status information are: `READY`, `ATTACHING`, `TRANSMITTING`.

Request for Action

A request for action, if it is not an alarm, is shown in the lower line of the display. This could be e.g. `POINT NOW?` or `INSERT SIM`.

When the text is a question, press **OK** to accept.

What's Next?

This chapter has explained how to navigate in the display menu system and how to use it for basic setup of the EXPLORER™ 500.

The following chapter, **Using the Interfaces**, explains in detail how to set up and use each interface of the EXPLORER™ 500.

Using the Interfaces

In This Chapter

This chapter describes how to use the interfaces of the EXPLORER™ 500. For each connection type it describes how to connect cables and the necessary setup to establish a connection.

It does not describe advanced configuration of interfaces. For this type of information, refer to the “Configuring...” sections in the chapter **Using the Web Interface**.

General

Tools for Setup and Use

The display and keypad can be used for simple setup, but for enhanced use and for configuration of interfaces, you need to connect a data unit (PC, laptop, PDA or similar).

With a data unit and a browser, you can use the following applications to set up the EXPLORER™ 500:

The Web Interface of the EXPLORER™ 500

The Web interface is a built-in application for setting up and controlling the EXPLORER™ 500, using a connected data unit with a browser. For information on how to use the Web interface, see **Using the Web Interface** on page 5-1.

The Inmarsat Launch Pad

Launch Pad is a PC application for setting up terminals in the BGAN system. A CD ROM with the Launch Pad is included in the delivery. For information on how to use the Launch Pad, refer to the user manual provided with the Launch Pad.

Services and Interfaces

A variety of services can be accessed from different interfaces on the EXPLORER™ 500.

The following table shows the possible combinations of services and interfaces, and which types of equipment can be used.

Service		Interface on the EXPLORER™ 500				
		Phone/Fax	Bluetooth	USB	LAN	Display/Keypad
Dialled Connection	Premium voice	Analogue telephone	Bluetooth handset			
		G.3 Fax machine				
	Standard voice	Analogue telephone	Bluetooth handset			
	Data	Data unit with modem	Data unit with Soft modem			
IP Connection	Data multi-user		Data unit		Data unit with Switch/Hub	
	Data single-user		Data unit	Data unit	Data unit	
SMS			Data unit	Data unit	Data unit	View only

Turning an Interface on or off

By default, all interfaces are on. However, you can turn off the LAN interface, the Bluetooth interface and/or the Phone/Fax interface in order to save power.

Display and Keypad

To turn an interface on or off using the **display and keypad**, do as follows:

1. Enter the menu system.
From the Main screen, press ▲ or ▼.
2. Select **SETTINGS > INTERFACES**.
3. Select the interface you want to turn on or off.
4. Select **ON** or **OFF**.

Web interface

To turn an interface on or off using the **Web interface**, do as follows:

1. Access the Web interface.
For further information, see **The Web Interface** on page 5-1.
2. From the left navigation pane, select **Settings > Interfaces**.
3. Select the interface you want to turn on or off.
4. Select **On** or **Off**.

Using a Phone or Fax Machine

Selecting the Voice Quality

Definition

The phone connection can be either a Standard voice connection or a Premium voice connection.

In the Web interface you can set up which type of connection to use as default when you make or receive a call from the phone/fax interface or the Bluetooth interface.

Note | When connecting a fax or a modem you must use Premium voice.

Example: If you always have a fax connected to the phone/fax interface you can set this interface to Premium voice only. This will mean that if, for example, an incoming Standard voice call is received, the phone/fax interface will not ring.

Selecting the Default Outgoing Voice Quality

To select the default voice quality for outgoing calls, do as follows:

1. Access the Web interface.
For further information, see **The Web Interface** on page 5-1.
2. Select **Settings > Interfaces**.
3. Select **Phone/fax** or **Bluetooth**.
4. At **Outgoing calls**, select **Standard** or **Premium**.

Note | Up to 7 Bluetooth handsets can be connected. Remember to set the voice quality for each handset in the **Devices with access** list.

Overriding the Default Outgoing Voice Quality

To override the default setting for a specific outgoing call, do as follows:

- To use the **Standard voice** connection for the call, dial **1*** before the number
- To use the **Premium voice** connection for the call, dial **2*** before the number

Example: To make a call to Thrane & Thrane in Denmark (+45 39558800), forcing the connection to be Standard voice, dial: **1* 0045 39558800** followed by # if calling from an analogue phone, or off-hook key if calling from a Bluetooth handset.

Note | This will not change the default voice quality setting, but only the quality of the call in progress.

Phone Numbers for Incoming Premium and Standard Voice

Premium voice and Standard voice have separate phone numbers. This way, a person calling a phone connected to the EXPLORER™ 500 can select whether to use Premium or Standard voice, simply by using one of the two phone numbers.

Note

The voice quality you are using must be selected in the Web interface (refer to the next section).

To view the phone numbers for Standard voice and Premium voice, do one of the following:

- select **PROPERTIES > MOBILE NUMBERS** in the display menu system, or
- access the Web interface and select **Properties**. The numbers are listed under **Mobile numbers**. For further information, see **The Web Interface** on page 5-1.

For information on how to make a call to the EXPLORER™ 500, see **Making a Call To the EXPLORER™ 500** on page 4-9.

Selecting the Incoming Voice Quality

To select which voice qualities are accepted for an incoming call, do as follows:

1. Access the Web interface.
For further information, see **The Web Interface** on page 5-1.
2. Select **Settings > Interfaces**.
3. Select **Phone/fax** or **Bluetooth**.
4. At **Incoming Calls**, check **Standard** or **Premium** or both.

Note

Up to 7 Bluetooth handsets can be connected. Remember to set the voice quality for each handset in the **Devices with access** list.

If the voice quality used for a call to the terminal is not selected in the Web interface, the connected phone will not ring.

Connecting an Analogue Phone or a Fax Machine

Before Connecting to the Phone/Fax Interface

To connect a phone to the phone/fax interface, you need an analogue telephone cable with an RJ-11 connector. For specifications and pin-out, refer to **Phone/Fax Interface** on page A-4.

Connecting to the Phone/Fax Interface

1. Connect the cable to your phone.
2. Connect the other end of the cable to the phone/fax connector on the EXPLORER™ 500.

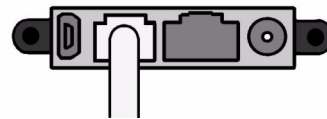

3. After power up and pointing, check the connection by making a phone call or sending a fax.
See **Making or Receiving a Phone Call With the EXPLORER™ 500** on page 4-8 or **Sending or Receiving a Fax Message** on page 4-12.

Note

If connection fails, check that the interface is on in the EXPLORER™ 500. If the analogue phone icon is not present in the display Main screen and in the Home window of the Web interface, the interface is off. See **Turning an Interface on or off** on page 4-3. If the interface is on, but connection fails, refer to **Troubleshooting Guide** on page 6-4.

Connecting a Bluetooth Handset

To use a Bluetooth handset with the EXPLORER™ 500, you first have to pair the two devices.

For information on pairing devices, see **Handling Bluetooth Device Access** on page 4-17.

The Bluetooth handset must be placed within a maximum distance of 100 m from the EXPLORER™ 500. Note that this is the absolute maximum distance; the actual maximum distance may be shorter, depending on the conditions.

For information on how to make and receive calls, see **Making or Receiving a Phone Call With the EXPLORER™ 500** on page 4-8.

Entering the PIN Code Using a Phone

Entering the PIN Code

If you have a phone connected to the EXPLORER™ 500, you can use it to enter the PIN code at start up, as an alternative to the keypad.

When the terminal is waiting for a PIN code, you will hear 2 beeps - pause - 2 beeps - etc.

You simply dial the PIN code the same way you would dial a phone number, that is:

- **For an analogue phone**, take the phone off hook and dial: <PIN> followed by #. When you hear a “busy” tone or a dialling tone, the PIN has been entered and you can put the phone back on hook.
- **For a Bluetooth handset**, dial: <PIN> and press off hook key. When you hear a “busy” tone or a dialling tone, the PIN has been entered and you can press the on hook key.

Wrong PIN Code

If, in stead of the busy tone or dialling tone, you hear 2 beeps - pause - 2 beeps - etc., it means the PIN code was wrong, and you have to try again.

If 3 wrong PIN codes have been entered, you will hear 3 beeps - pause - 3 beeps - etc. This means you have to dial the PUK code provided with your SIM card. With the phone off hook, dial the following:

<PUK> * <New PIN> * <New PIN> followed by # or off-hook key

Example: If the PUK code is 87654321 and the new PIN code is 1234, dial:

87654321 * 1234 * 1234 followed by # or off-hook key.

If 10 wrong PUK codes are entered, the SIM card will no longer be functional. Contact your Airtime Provider for a new SIM card.

Making or Receiving a Phone Call With the EXPLORER™ 500

Analogue Phone or Bluetooth Handset

If you are using an analogue phone, it must be connected to the phone/fax interface of the EXPLORER™ 500. Refer to **Before Connecting to the Phone/Fax Interface** on page 4-6.

If you are using a Bluetooth handset, the handset must be paired and connected with the EXPLORER™ 500.

For information on how to pair Bluetooth devices, see **Pairing Devices** on page 4-17.

Note

After dialling a phone number, you must activate the call. This is done as follows:

- Analogue phone: Dial # after the number.
- Bluetooth handset: Press the off-hook key after the number.

Making a Call

You have two options for making a call:

- **Short Dial:** If the number is in the phone book of the EXPLORER™ 500, you can use the Short Dial number followed by *:

Simply dial: <**Short Dial**> * followed by # or off-hook key.

The Short Dial numbers for your phone book entries are found in the first column of the phone book in the Web interface. See **Using the Phone Book** on page 5-6.

- **Manual Dial:** To make a call, dial:

00 <country code> <phone number> followed by # or off-hook key.

Example: To call Thrane & Thrane in Denmark (+45 39558800) from an analogue phone, dial: **00 45 39558800 #**

If there was an error establishing the connection, the Web interface and the display of the EXPLORER™ 500 show an error message. Refer to **Troubleshooting Guide** on page 6-4.

Receiving a Call

As default, all phones or fax machines connected to the phone/fax interface or the Bluetooth interface will be ringing when one of the mobile numbers is called. Note, however, that this behaviour may change if the voice quality settings have been changed in the Web interface. Refer to **Selecting the Incoming Voice Quality** on page 4-5.

Information of missed calls is stored in the call log of the EXPLORER™ 500.

Making a Call To the EXPLORER™ 500

To make a call to a phone connected to the EXPLORER™ 500, dial

+870 <Mobile number>

- **+** is the prefix used in front of the country code for international calls. This is **00** when calling from countries in Europe and from many other countries.
- **Mobile number:** To see your mobile numbers, use the display menu system and select **PROPERTIES > MOBILE NUMBERS**, or, if a data unit is connected, access the Web interface, select **Properties** and locate the **Mobile numbers** section. For further information on the Web interface, see **The Web Interface** on page 5-1.

Note | There are two Voice numbers, one for Premium voice and one for Standard voice.

Dialling Functions

Overview

There are a number of dialling functions available in the EXPLORER™ 500.

The following list shows the allocated special-purpose numbers for the EXPLORER™ 500.

Number	Function
0 *	Redial last called number on this interface.
00 *	Redial last answered call on this interface. Note: If the last answered number is an unlisted number, you will not be allowed to dial back.
One of the numbers 1-199 followed by *	Short dial phone numbers in SIM phone book.
200 followed by *	Local call Broadcast to all Bluetooth handsets. All connected Bluetooth handsets will ring. The first handset that answers, takes the call.
One of the numbers 201-299 followed by *	Local call to Bluetooth handset. The first Bluetooth handset that is paired with the EXPLORER™ 500 is assigned the number 201, the second is assigned 202 and so forth.
300 followed by *	Local call Broadcast to all analogue phones. (currently only one phone/fax interface is available)
One of the numbers 301-399 followed by *	Local call to analogue phone. (currently only 301)

Apart from these numbers, there are a few dialling prefixes:

- **1*** before a phone number will force the connection to use **Standard Voice**.
- **2*** before a phone number will force the connection to use **Premium Voice**.
- **R** is used during a call to indicate that the following key-presses should activate a function in relation to supplementary services.

Making Local Phone Calls

You can make local calls between phones connected to the EXPLORER™ 500.

For an overview of the numbers, see **Overview** on page 4-9.

To make a local call, dial

<**local number**> * followed by # or off-hook key.

Example: To make a call to the second Bluetooth handset that was connected, dial **202 * #**.

Note

You cannot make local calls between two Bluetooth handsets through the EXPLORER™ 500. You can only make a local call from an analogue phone to one or more Bluetooth handsets, or from a Bluetooth handset to the analogue phone.

Up to 7 Bluetooth handsets can be connected at the same time, but **only one call** can be active on the Bluetooth interface.

You can look up the local Bluetooth phone numbers in the display or in the Web interface.

- **Display:** Enter the menu system and select **PROPERTIES > BLUETOOTH DEVICES**. The list shows all accepted Bluetooth devices with local number and Bluetooth name.
- **Web interface:** Access the Web interface and select **Settings > Interfaces > Bluetooth**. The local phone numbers are listed in the **Devices with access** list.

Handling Waiting Calls

Note

The phone must have an R key to be able to use these functions.

During a call, if a second call attempts to make contact with you, a Call Waiting indication may be presented to you. If no action is taken, the waiting call is released after a time out period.

When you receive a Call Waiting indication, you have the following options:

- **To clear** the current call and accept the waiting call, press **R 1 #**, within the time out period.
- **To hold** the current call and accept the waiting call, press **R 2 #**, within the time out period.
- **To ignore** the waiting call, take no action.
- **To reject** the waiting call, press **R 0 #**, within the time out period.

Holding a Call

Note | The phone must have an R key to be able to use these functions.

During a call, you may place the initial call on hold while another call is made.

- **To place a call on hold**,
press **R 2 #**.
- **To place the existing call on hold and establish a new call**,
press **R** and dial the second phone number followed by **#**.
- **To shuttle** between the two calls,
press **R 2 #**, irrespective of whether the second call was acquired using Call Hold or acceptance of Call Waiting.
- **To clear the held call**, if no waiting call exists,
press **R 0 #**.
- **To clear an active call** and return to the held call,
press **R 1 #**. Note that this is only possible if no waiting call exists.

Making a Conference Call

Note | The phone must have an R key to be able to use these functions.

You can make a conference call between multiple parties.

Before making a conference call, you have to establish calls to two parties with one call active and the other on hold. See **Holding a Call** above.

- **To add the party on hold** to the conference call,
press **R 3 #**.
- **To add another remote party**, the same procedure applies:
Establish another call and place either this call or the existing multiparty call on hold. Press **R 3 #** to bring all these parties together in an enlarged multiparty call.
- **To choose one party for private communication**, putting the rest of the multiparty on hold,
press **R 2 <X> #**,
- where X is the sequential number of the party with which communication should be supported. The numbering is given by the sequence of setting up or receiving the calls (active, held or waiting), where 1 is the first call that is set up or received. Calls keep their number until they are released. New calls take the lowest available number.
- **To return to the multiparty**, with the previously active call placed on hold,
press **R 2 #**.
- **To release a specific party**,
press **R 1 <X> #**, where X is the sequential number as defined above.
- **To terminate the multiparty** and release all calls,
hang up.

Sending or Receiving a Fax Message

Note When sending or receiving fax messages over satellite, both fax units must be capable of handling longer delays without timing out. Some fax machines have an “Overseas” mode, which enables the unit to handle the long delays.

Sending a Fax Message

The fax machine must be connected to the phone/fax interface of the EXPLORER™ 500. Refer to **Before Connecting to the Phone/Fax Interface** on page 4-6.

Premium voice quality must be used. Refer to **Selecting the Default Outgoing Voice Quality** on page 4-4.

To send a fax from a fax machine connected to the terminal, dial:

00 <country code> <phone number> #

Example: To send a fax to Thrane & Thrane in Denmark (+45 39558888), dial: **00 45 39558888 #**

Note If Premium voice is not selected as default in the Web interface, you can dial 2 * before the number, to force the connection to use Premium voice. For further information, see **Selecting the Default Outgoing Voice Quality** on page 4-4.

Receiving a Fax Message

A fax machine connected to the EXPLORER™ 500 can only receive a fax with Premium voice quality. Refer to **Selecting the Incoming Voice Quality** on page 4-5.

Make sure the fax is sent to the Premium voice phone number and that Premium voice is selected for the interface in the Web interface.

Using a Data Unit With the EXPLORER™ 500

Choosing an Interface for Data Connection

The EXPLORER™ 500 has three types of interface for data connection: LAN, USB and Bluetooth. The following table shows some characteristics of each interface, to help you choose the right interface for your application.

Interface	Power Consumption	Amount of Setup	Range
LAN	High	None (or very little)	Up to 100 m of cable
USB	Low	Some setup necessary	Up to 5 m of cable
Bluetooth	Medium	Can be complicated, depending on operating system.	Wireless connection. Up to 100 m depending on the transmitter in the data unit and on the transmission conditions.

Using the LAN Interface

Before Connecting to the LAN Interface

To connect to the LAN interface, use a shielded cable mounted with an RJ-45 connector. The LAN interface is configured as MDI-X. This means that if you are connecting your data unit directly to the EXPLORER™ 500, you should use a **straight** cable. If you are connecting a switch to the EXPLORER™ 500, use a crossed cable.

For specifications, refer to **LAN Interface** on page A-5.

Note

For the LAN interface to work without any further setup, the data unit must obtain an IP address and a DNS server address automatically. To check these settings on your data unit, do as follows (in Windows XP):

Expand the **Start** menu and select **Settings > Network Connections > Local Area Connection**.

Click **Properties**, select **Internet Protocol (TCP/IP)** from the list and click **Properties**.

Make sure both fields are set to obtain an address automatically.

Connecting to the LAN interface

Do as follows:

1. Connect the LAN cable to the network interface of your data unit.
A suitable cable is provided with your EXPLORER™ 500.
2. Connect the other end of the cable to the LAN connector on the EXPLORER™ 500. After power up and pointing, the connection is automatically established. As default, the connection is a standard data connection.
Check the connection, e.g. by starting your Internet Browser.

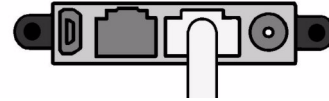

Note

If connection fails, check that the interface is on in the EXPLORER™ 500. If the LAN icon is not present in the display Main screen and in the Home window of the Web interface, the interface is off. See **Turning an Interface on or off** on page 4-3.
If connection still fails, refer to **Troubleshooting Guide** on page 6-4.

Using the USB Interface

First Time Setup of USB

If it is the first time you connect your data unit to the EXPLORER™ 500 using the USB interface, you must first install a driver.

1. Insert the Thrane & Thrane CD ROM provided with your EXPLORER™ 500
2. Locate and activate the USB driver setup file.

Note that if you intend to use the USB interface with the Inmarsat Launch Pad, you must also install the C-mux driver from the Inmarsat CD provided with your EXPLORER™ 500.

After installing the USB driver, create a dial-up connection as described in the following section.

Creating a Dial-up Connection

Do as follows:

Note

The following description is for **Windows XP**. If you are using a different operating system, the procedure may be different.

1. Select **Settings > Network Connections** from the **Start** menu.
2. Open the **New Connection Wizard**.
3. Select **Connect to the Internet**.

4. Select **Set up my connection manually**.
5. Select **Connect using a dial-up modem**.
6. Type a name for your connection.
7. When you are asked for a phone number, type:
 - *98# if you are going to connect to the Internet, and
 - *99# if you are going to connect to the built-in Web interface of the EXPLORER™ 500.

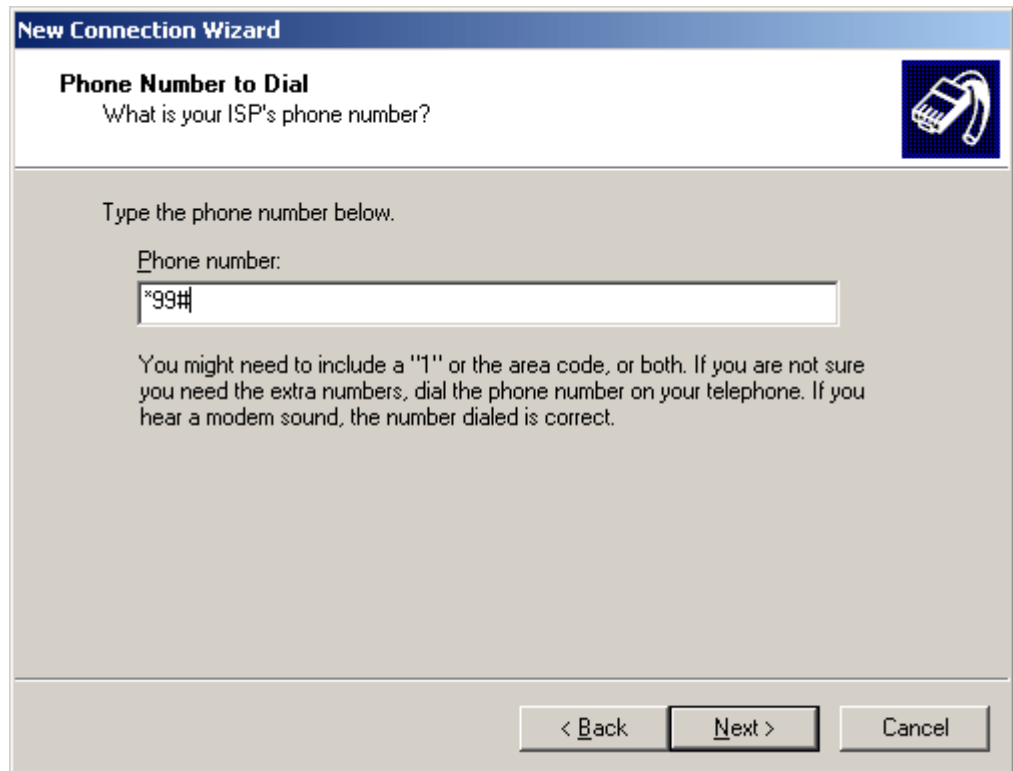

8. Finish the Wizard.

When you connect to the USB interface, you must open this dial-up connection to access the Internet or the Web interface.

Before Connecting

To connect to the USB interface, use a USB cable mounted with a USB Mini-B connector. For specifications, refer to **USB Interface** on page A-6.

Connecting to the USB Interface

If you are connecting your data unit to the USB interface for the first time, see **First Time Setup of USB** on page 4-14.

Note | If you intend to use the Launch Pad with the USB interface, you must first install the C-mux driver from the Inmarsat CD enclosed with the EXPLORER™ 500.

If the units have been connected before, do as follows:

1. Connect the USB cable to the USB port of your data unit.
2. Connect the other end of the cable to the USB connector on the EXPLORER™ 500.

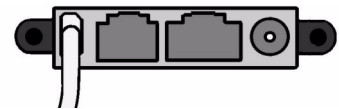

After power up and pointing, check the connection by opening your dial-up connection as follows:

Note | The following description is for **Windows XP**. If you are using a different operating system, the procedure may be different.

1. Select **Settings > Network Connections** from the **Start** menu.
2. Locate and open the dial-up connection created for this USB connection.
3. Click **OK** and wait for the connection to be established. Then start your Internet browser or mail program.

Note | If connection fails, refer to **Troubleshooting Guide** on page 6-4.

Handling Bluetooth Device Access

Important!

To be able to handle Bluetooth device access on the EXPLORER™ 500, you need to have a connected data unit with an Internet browser so you can access the Web interface.

Preparing the EXPLORER™ 500 for Bluetooth

To prepare the Bluetooth interface on the EXPLORER™ 500, do as follows:

1. Access the Web interface and select **Settings > Interfaces > Bluetooth**.
2. In the **UT device name** box, type in a name for your EXPLORER™ 500.
This name is shown to other Bluetooth devices, if the EXPLORER™ 500 is configured to be discoverable.
3. Next to **UT discoverable**, select **yes** or **no**.
 - If you select **yes**, the device name of the EXPLORER™ 500 is shown to other Bluetooth devices searching for devices.
 - If you select **no**, other Bluetooth devices will not see the EXPLORER™ 500 when searching for devices.

Pairing Devices

Note | The method for pairing devices may vary depending on your Bluetooth device. Consult your Bluetooth device documentation for information.

The Bluetooth interface can use various profiles for voice or data. For information on which profiles are supported, see **Bluetooth Interface** on page A-7.

If the Bluetooth interface uses a dial-up profile, you have to create a dial-up connection. For further information, see **Creating a Dial-up Connection** on page 4-14.

To pair new devices in your EXPLORER™ 500: TBD TBD TBD TBD

Viewing Devices with Access

To see a list of devices that have been paired with the EXPLORER™ 500, do as follows:

Select **PROPERTIES > BLUETOOTH DEVICES** in the display menu system, or:

1. Access the Web interface.
For further information, see **The Web Interface** on page 5-1.
2. Select **Settings > Interfaces > Bluetooth**.
The section **Devices with access** shows a list of devices that have been paired with the EXPLORER™ 500.

Unpairing Devices

To remove a device from the list of Devices with access, you have to use the Web interface. Do as follows:

1. Locate the **Devices with access** list as described in **Viewing Devices with Access** on page 4-17.
2. In the **Devices with access** list, click **Delete** next to the device you want to remove.

When the device is removed from the list, you have to pair it with the EXPLORER™ 500 again to make a connection.

Using a Data Unit with Bluetooth

Connecting a Data Unit to the Bluetooth Interface

Note | The procedure may vary depending on the Bluetooth interface in your data unit. Consult your Bluetooth manual for details.

If the two devices have not been connected before, you need to pair the devices. For further information, see **Handling Bluetooth Device Access** on page 4-17.

Note | If you intend to use the Inmarsat Launch Pad to access the EXPLORER™ 500 through the Bluetooth interface, you must first install the C-mux driver from the Inmarsat CD enclosed with the EXPLORER™ 500.

When the devices have been paired, do as follows to connect:

1. Power up your data unit and the EXPLORER™ 500.
2. Place the data unit close to the EXPLORER™ 500.
3. Turn on Bluetooth on your device.

If the devices are paired, the Bluetooth connection should now be established.

Note that if your Bluetooth connection is defined as a dial-up connection, you have to open the dial-up connection before you can access the internet or the Web interface.

Note | If connection fails, check that the interface is on in the EXPLORER™ 500. If the Bluetooth icon is not present in the display Main screen and in the Home window of the Web interface, the interface is off. See **Turning an Interface on or off** on page 4-3. If the interface is on, but connection fails, refer to **Troubleshooting Guide** on page 6-4.

Additional Interfaces

Using an External Antenna

You can connect an external antenna to the EXPLORER™ 500.

Important Only use the specified antenna from Thrane & Thrane. The antenna is listed in **Options and Accessories** on page 6-2.

The connector for the external antenna is located at the back of the EXPLORER™ 500.

For information on cable and connector type, refer to specifications in **External Antenna** on page A-9.

Using the EXPLORER™ 500 Bluetooth Handset Charger

Before Connecting

You can charge your Bluetooth handset using the DC charger interface of the EXPLORER™ 500.

Use the charger cable supplied with the Bluetooth handset.

For specifications on the charger interface, see **EXPLORER™ 500 Bluetooth Handset Charger Interface** on page A-10.

Connecting to the EXPLORER™ 500 Bluetooth Handset Charger Interface

Do as follows:

1. Connect the charger cable to the charging connector on the EXPLORER™ 500. The charging connector is placed on the rear side of the EXPLORER™ 500.
2. Connect the other end of the cable to your Bluetooth handset.

What's Next?

This chapter has described the basics of how to set up and use each interface.

The following chapter, **Using the Web Interface**, describes how to use the built-in Web interface for setting up and using the EXPLORER™ 500.

Using the Web Interface

In This Chapter

This chapter describes how to use the Web interface to operate, set up and configure the EXPLORER™ 500.

Initial configuration of interfaces is described in the chapter **Using the Interfaces** on page 4-1.

The Web Interface

What is the Web Interface?

The Web interface is a built-in Web server in the EXPLORER™ 500, used for operating, setting up and configuring the EXPLORER™ 500.

You can access the Web interface from a standard Internet browser, such as Internet Explorer 6.0 or later.

Connecting

Connect your data unit to the EXPLORER™ 500.

Make sure your data unit is set up for the interface you are planning to use for connecting to the EXPLORER™ 500. You can use LAN, USB or Bluetooth. See **Using the Interfaces** on page 4-1 for details.

To access the Web interface, an Internet browser must be installed on the data unit.

Important

If you are going to use USB or Bluetooth with Dial-up Networking to access the Web interface, you must use a dial-up connection with the phone number set to *99#. For further information, see **First Time Setup of USB** on page 4-14.

Browser Settings

The **Proxy server** settings in your browser must be disabled before accessing the Web interface.

Note Most browsers support disabling of the Proxy server settings for a specific IP address only, so you can disable Proxy server settings for the Web interface only, if you wish. Consult your browser help for information.

To disable the use of a Proxy server completely, do as follows:

- For Microsoft Internet Explorer, select **Tools > Internet Options > Connections > LAN Settings** and uncheck the box labelled **Use a proxy server for your LAN**. Then click **OK**.

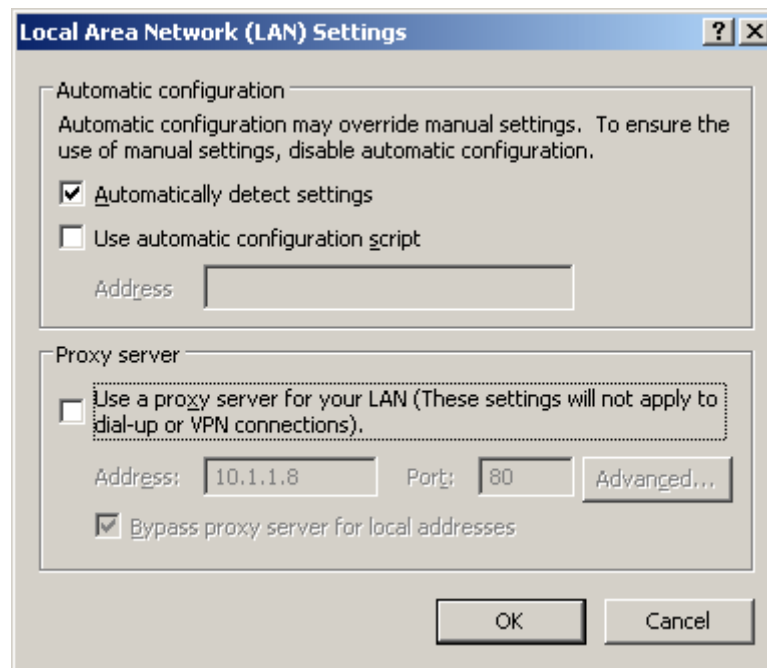

- For Safari, select **Safari** in the top menu bar and select **Preferences**. Then click **Change Settings** next to **Proxies**. Click **Configure** and select the **Proxies** tab. In the list, uncheck **Web Proxy (HTTP)**.

When the proxy server settings are disabled, close your browser.

You may need to change this setting back on return to your Internet connection.

Accessing and Navigating the Web Interface

Accessing the Web Interface

The Web interface is embedded in the EXPLORER™ 500.

To access the Web interface from a connected data unit, do as follows:

1. Start up the EXPLORER™ 500.
For further information, see **Getting Started** on page 2-1.
2. Open your browser and enter the IP address of the Web interface.
As standard, the IP address is **192.168.0.1**.
If your EXPLORER™ 500 uses a different IP address, you can look it up by entering the display menu system of the EXPLORER™ 500 and selecting **PROPERTIES > IP ADDRESS**.

Navigating the Web Interface

The Web interface consists of a navigation pane in the left side holding the main menus and a status field, an icon bar at the top, and a contents section with status and settings. The bar just below the icon bar shows the menu path to the currently selected menu item.

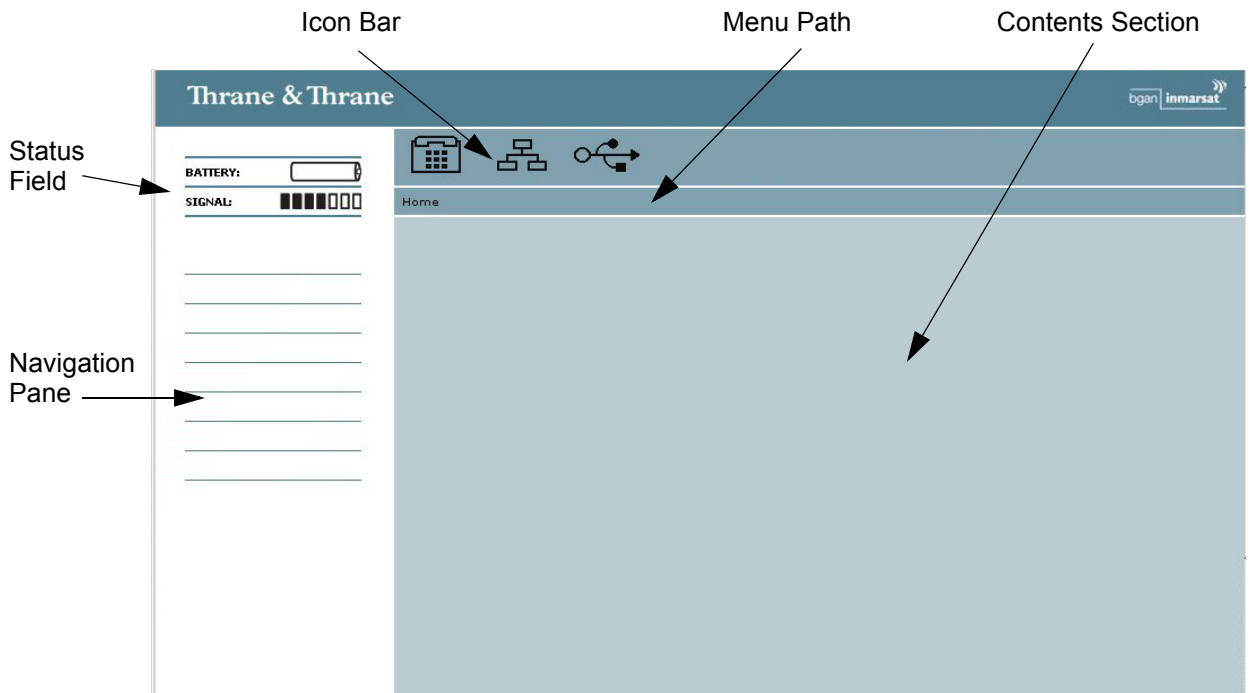

Note

During pointing, the entire window is replaced by a pointing window. When the signal strength is acknowledged and pointing is done (or pointing is cancelled), the Web interface returns to the Home page.

- **To expand a menu**, click the menu in the navigation pane.
- **To access status and settings**, click the relevant subject in the navigation pane. The status or settings are displayed in the main window.
- **To see the Site map**, click **Site map** in the navigation pane.
- **To return to the Home window** from anywhere in the system, click **Home**, either from the navigation pane or from the menu path below the icon bar.

Entering the PIN Code in the Web Interface

If a data unit is connected when you start up the EXPLORER™ 500, and the Web interface is accessed, you can enter the PIN code from the Web interface.

If the PIN code is not entered with the EXPLORER™ 500 keypad, the Web interface will ask for a PIN code when it is accessed.

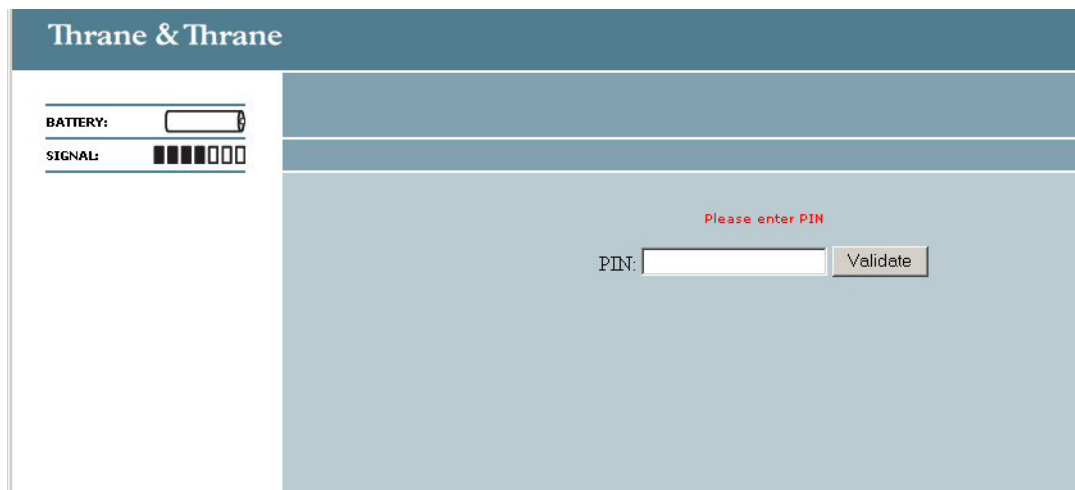

Type in the PIN code and press **OK**.

If you enter a wrong PIN code 3 times you are asked for a PUK code. For further information, see **Wrong PIN Code** on page 2-9.

Pointing Using Web Interface

After entering the PIN code, you will see the pointing window in the Web interface, if pointing is required.

Point the antenna as described in **Pointing the Antenna** on page 2-10, observing the signal strength in the Web interface.

When you have obtained the highest possible signal strength, click OK in the Pointing window.

Viewing the Status

At the top of the navigation pane of the Web interface, you can view the general status of the EXPLORER™ 500, such as battery level, signal strength and information on ongoing calls and sessions.

Icons in the top icon bar show which interfaces are turned on, and indicate incoming messages or alarms.

Note

During pointing, the entire window is replaced by a pointing window. When the signal strength is acknowledged and pointing is done (or pointing is cancelled), the Web interface returns to the Home window.

To view **status on total usage** (MB or time connected), select **Calls** from the left navigation pane in the Web interface. The Calls window shows total usage compared to limits.

Using the Phone Book

General Usage

With the phone book you can:

- look up phone numbers.
- look up short dial numbers for easy dialling from an analogue or Bluetooth handset.
- send an SMS message.

When sending an SMS message from data equipment using the Web interface, you can select the number directly from the phone book. For further information, see **Sending an SMS Message From the EXPLORER™ 500** on page 5-8

- modify or delete existing names and phone numbers, or enter new names and phone numbers.

Accessing the Phone Book

To access the phone book, select **Phone book** from the left navigation pane.

The phone book shows all the entries with an entry number, phone number and name.

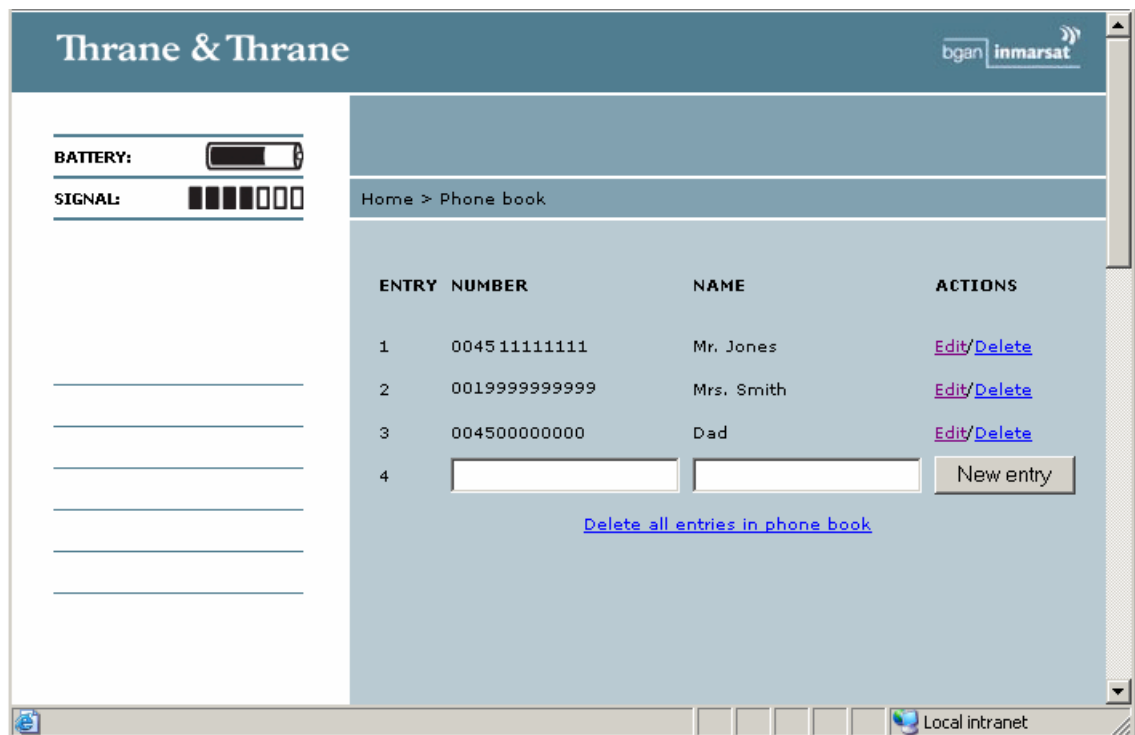

Short Dial

The entry number in the phone book is the Short dial number. When making a call from the EXPLORER™ 500 you can use this number instead of dialling the entire phone number.

Simply dial: <**short dial**> followed by * and # or off-hook key.

Example: To call the 3rd entry in the phone book from an analogue phone, take the phone off hook and dial **3 * #**.

Adding a New Entry

To add a new entry, do as follows:

1. In the phone book, locate the empty entry number where you want to add the new phone number.
2. Click **New entry**.
3. Type in the name and number of the new entry and click **OK**.

The new name and number is now listed at the specified entry number in the phone book.

Modifying an Entry in the Phone Book

To modify an entry, do as follows:

1. In the phone book, click **Edit** next to the entry you want to modify.
2. Modify the name or number as wanted and click **Save Entry**.

The name and/or number in the selected entry is now replaced with the new information.

Deleting an Entry in the Phone Book

To delete an entry, do as follows:

1. In the phone book, click **Delete** next to the entry you want to delete.
2. Click **OK** to confirm.

The selected entry is now empty.

Deleting all Entries in the Phone Book

To delete all the entries in the phone book, do as follows:

1. Click **Delete all entries in phone book** at the bottom of the Phone book window.
2. Click **OK** to confirm.

Handling Messages

Sending an SMS Message From the EXPLORER™ 500

To send an SMS message **from** the EXPLORER™ 500, do as follows:

1. Click **Messages** from the left navigation pane.
The **Inbox** opens.
2. In the left navigation pane, click **Write message**.
3. Type in the message in the **Message** field.
4. Type in the phone number in the **Recipient** field, or click a number from the Phone book below the Recipient field.
When typing the number, remember **00** and **country code**
(e.g. **00 45** to call Denmark or **00 1** to call USA).
5. Select whether or not you want **delivery notification** for this SMS message.
If you click Yes, you will get a notification when your message has arrived.

Note | You can set up delivery notification generally for all SMS messages. For further information, see **Setting up the Message Options** on page 5-10.

6. Click **Send**.
The message is now moved to the Outbox. If the EXPLORER™ 500 is online, the message is sent.

Sending an SMS Message to the EXPLORER™ 500

Send the SMS message e.g. from a mobile phone, using one of the mobile numbers for voice.
Dial:

+870 <Mobile number>

To see the voice numbers, select **Properties** from the Web interface or from the display menu system and view **Mobile numbers**.

Receiving a Message

If a message has arrived, the status bar at the top of the Web interface shows an unopened envelope. Click the envelope to see the new message(s).

Otherwise, to see received messages, click **Messages** from the left navigation pane.

The window shows all received messages.

Note

The EXPLORER™ 500 does not accept incoming messages if the Inbox is full. The Inbox can hold up to 100 messages. When the Inbox is full, you have to delete messages or move them to the SIM card, in order to free space for new messages.

If the message is not an SMS message but information of Voice mail, you have to call your Voice mail service number to hear the Voice mail.

To find your Voice mail service number, select **Messages > Settings** and locate the Voice mail service number.

Options for SMS Messages in the Inbox

To enter the Inbox, click **Messages** from the left navigation pane.

Besides viewing the messages in the Inbox, you have a number of options for what to do with each message:

- Click **Reply** to reply to a message.
Type in your reply and click **Send**.
For information on how to include the original message in your reply, see **Setting up the Message Options** on page 5-10.
- Click **Forward** to forward a message to someone.
Then type in the phone number in the **Recipient** field or pick from the phone book, and click **Send**.
- Click **Delete** to delete the message. Then click **OK** to confirm.
- Click **Delete all entries in inbox** to delete the entire contents of the inbox. Then click **OK** to confirm.

Configuring Message Settings

Setting up the Message Options

You can set up general options for your outgoing messages. These settings normally apply to all your outgoing messages. Note, however, that you can also change these settings for an individual message. For further information, see **Sending an SMS Message From the EXPLORER™ 500** on page 5-8.

Do as follows:

1. Select **Messages > Settings** from the left navigation pane.
2. Select the following message options:
 - **Include message in reply.**
To include the original message when you reply, click **Yes**.
 - **Delivery notification.**
To receive notification when your message is delivered, click **Yes**.

Viewing or Changing SMS Service Number

The SMS service number identifies the SMS service centre used when sending and receiving SMS messages. Normally you do not need to know this number, but the EXPLORER™ 500 uses it when sending or receiving SMS messages.

The SMS service number is stored on the SIM card.

- To see the SMS service number, select **Messages > Settings** from the left navigation pane.
- To change the number, click **Edit** next to **SMS service number**, change the number and click **OK**.

The SMS service number is provided from your Airtime provider.

Viewing or Changing Voice Mail Service number

The Voice mail service number is the number you call to hear your incoming voice mails.

The Voice mail service number is stored on the SIM card.

- To see the Voice mail service number, select **Messages > Settings** from the left navigation pane.
- To change the number, click **Edit** next to **Voice mail service number**, change the number and click **OK**.

Power up Behaviour

Automatic Power up

In the **Power up** section of the **Settings** window, select whether or not the EXPLORER™ 500 should power up automatically when external power is applied.

- To have the EXPLORER™ 500 power up automatically when external power is applied, select **Yes**.
- To have the EXPLORER™ 500 power up only when the power button is pressed, click **No**.

Pointing at Power up

If the EXPLORER™ 500 is placed in a fixed position it may not be necessary to go through the pointing process every time the terminal is powered. You can set up the EXPLORER™ 500 to automatically establish a connection to the BGAN network, if you know that the signal strength is sufficient.

In the **Power up** section of the **Settings** window, select whether or not pointing is required at power up.

- To go through the pointing process next time the EXPLORER™ 500 is powered, select **Yes**.
- To have the EXPLORER™ 500 automatically acknowledge the signal strength next time the EXPLORER™ 500 is powered, select **No**.

If you have selected that pointing is not required at power up, the start up procedure will be as follows:

1. Power up.

2. Enter PIN code.

After the PIN code is entered, the EXPLORER™ 500 immediately tries to connect to the BGAN network.

The terminal display shows the progress as follows:

- SEARCHING (this phase can be very short and may not be seen)
- ATTACHING
- READY

Setting the Display Contrast and Brightness

To set the display contrast and brightness, do as follows:

1. Select **Settings** > **Terminal Display** from the left navigation pane.

2. In the **Brightness** section of the **Terminal display** window, set the timing.

The **Timed** period is the period of time the light will stay on after the last key is pressed.

3. Set the brightness level with the scroll bar.
4. In the **Contrast** section, click **Automatic on** if you want the contrast to be adjusted automatically according to the temperature.
5. Set the contrast level with the scroll bar.

Turning Audio Indicators on or off

In the **Audio indicators** section of the **Terminal display** window, turn the audio indicators on or off using the radio buttons.

The EXPLORER™ 500 has audio indicators for the following events:

- **Pointing**
The Pointing indicator is a beeping sound during the pointing process. The beeping frequency increases with the signal strength.
- **Messages**
The Message indicator is a sound indicating that a message has arrived.
- **Warnings**
The Warning indicator is a sound indicating that a warning is issued. A warning can be issued if, for example, the battery charge level is too low.
- **Alarms**
The Alarm indicator is a sound indicating that an alarm is issued. An alarm can be issued if, for instance, the temperature is too high.

Enabling Activation of Stealth Mode

In Stealth mode, the EXPLORER™ 500 operates with no sounds nor lights. However, it is still possible to operate the terminal and the display text is readable.

Important Only enable activation of Stealth mode if you are going to use it. If Stealth mode is activated by mistake, it may be difficult to operate the EXPLORER™ 500.

To enable the use of Stealth mode for the EXPLORER™ 500, do as follows:

1. Select **Settings > Terminal display** from the left navigation pane.
2. In the **Stealth Mode** section, click **Enable**.

Note This setting does not activate Stealth mode, it only enables the use of Stealth mode. To activate Stealth mode, press **C+OK**.
To deactivate Stealth mode and return to normal function, press **C+OK** again.

Overview of Network Settings

There are several network parameters that can be set up in the Web interface. This section gives an overview of these parameters, but does not provide detailed information.

APN (Access Point Name)

The APN is used by the mobile user to establish the connection to the required destination network. This means that the EXPLORER™ 500 must know the APN in order to be able to connect to the destination network.

APNs are provided from the Airtime Provider. They may also be defined on the SIM card.

DNS (Domain Name Server)

The DNS translates domain names into IP addresses. A DNS needs to be assigned, to enable your browser to recognize domain names and translate them into the correct IP addresses.

Two DNSes are defined; the second DNS is used as backup.

The DNSes are provided from the Airtime Provider.

Header Compression

The Header of a data packet contains control information belonging to that packet. The information in the Header can take up a considerable amount of bandwidth. In order to save bandwidth, you can use Header Compression, meaning you compress the header information, leaving some of the information out.

You can select whether or not to use Header Compression for your data transmission.

- **Header Compression on:** Recommended for low-noise applications.
If you select Header Compression on, you will be using less bandwidth on header information, leaving more bandwidth for the actual payload.
However, if the environment is noisy, the system will have to retransmit information, and you may end up using more bandwidth than without Header Compression.
- **Header Compression off:** Recommended in noisy environments.
If Header Compression is off, the system will be less sensitive to noise.

TCP/IP Spoofing

Some packet data applications will not work efficiently with the extra delay introduced by a satellite link. In many cases, but not all, this problem can be solved using a technique called TCP speed-up or TCP acknowledge spoofing.

Primary and Secondary Connection Class

The Connection Class defines the Quality of Service used for your data transmission. You can select between a number of predefined profiles.

A profile is basically a collection of settings to define the priority of data transmitted on an interface.

NAT (Network Address Translation)

NAT enables a local-area network to use one set of private IP addresses for internal traffic and an assigned or static IP address for external traffic. The built-in NAT module in the EXPLORER™ 500 makes all necessary address translations between the local-area traffic and the external traffic.

If more than one user is connected to the LAN interface of the EXPLORER™ 500, it is necessary to use a switch, as the EXPLORER™ 500 only has one LAN connector. If you are using a switch, you must select **NAT on** to use the NAT of the EXPLORER™ 500.

Configuring the LAN Interface

For an explanation of each of the network settings, see **Overview of Network Settings** on page 5-13.



CAUTION! If you are connected using LAN while changing the below settings, your changes may affect your current connection.

To configure the LAN interface, do as follows:

1. Select **Settings > Interfaces > LAN**.
2. At the top of the page, select whether the LAN interface should be on or off.
3. If your data unit uses a static IP address, click **yes** next to **Use static IP address**.
To check whether you data unit uses a static IP address, see the properties of the LAN connection on your data unit. (In Windows XP, select Settings > Network Connections > Local Area Connection).
4. To use **TCP/IP spoofing**, click **On**.
5. Select **APN**.
There are two possibilities for setting the APN:
 - **From SIM**. If APNs are available on the SIM card, you must select one of these APNs from the scroll list.
 - **User defined**. Type in the APN. APNs are provided from the Airtime provider.
6. Type in the User name and password for the APN. The user name and password are provided from the Airtime provider.
7. Select **DNS**.
You have two possibilities for setting the DNS:
 - **Network assigned**. The DNS1 and DNS2 are assigned from the network if possible.
 - **User defined**. Type in the DNS1 and DNS2 provided from the Airtime provider.
8. Select the **Primary Connection Class**.
Select a profile from the scroll list.

9. Select the Secondary Connection Class.

To select more than one secondary profiles, press and hold Ctrl while selecting.

10. To use the built-in NAT of the EXPLORER™ 500, select NAT: On.

Configuring the USB Interface

For an explanation of each of the network settings, see **Overview of Network Settings** on page 5-13.

To configure the USB interface, do as follows:

1. Select Settings > Interfaces > USB.

2. If your data unit uses a static IP address, click **yes** next to **Use static IP address**.

3. To use **TCP/IP spoofing**, click **On**.

4. Select APN.

You have two possibilities for setting the APN:

- **From SIM.** The APN is taken from the SIM card.
- **User defined.** Type in an APN provided from your Airtime provider.

5. Type in the **APN user name and password** provided from your Airtime Provider.

6. Select DNS.

You have two possibilities for setting the DNS:

- **Network assigned.** The DNS1 and DNS2 are assigned from the network, if possible.
- **User defined.** Type in DNS1 and DNS2 provided from your Airtime provider.

7. Select the Primary Connection Class.

Select a profile from the scroll list.

8. Select the Secondary Connection Class.

To select more than one secondary connection class, press and hold Ctrl while selecting.

Configuring the Bluetooth Data Interface

For an explanation of each of the network settings, see **Overview of Network Settings** on page 5-13.

Up to 7 devices, including phones and data units, can be connected to the Bluetooth interface.



CAUTION! If you are connected using Bluetooth while changing the below settings, your changes may affect your current connection.

To configure a Bluetooth data connection, do as follows:

1. In the Bluetooth window, locate your data unit in the **DATA UNITS** list below the **Devices with access** list.
2. If your data unit uses a static IP address, click **yes** next to **Use static IP address**.
3. To use **TCP/IP spoofing**, click **On**.
4. Select **APN**.
You have two possibilities for setting the APN:
 - **From SIM** The APN is taken from the SIM card (if available)
 - **User defined**. Type in an APN provided from your Airtime provider.
5. Type in the User name and password for the APN. The user name and password are provided from the Airtime provider.
6. Select **DNS**.
You have two possibilities for setting the DNS:
 - **Network assigned**. The DNS1 and DNS2 are assigned from the network.
 - **User defined**. Type in the DNS1 and DNS2 provided from your Airtime provider.
7. Select the **Primary Connection Class**.
Select a profile from the scroll list.
8. Select the **Secondary Connection Class**.
To select more than one secondary connection class, press and hold Ctrl while selecting.
9. To use the built-in **NAT** of the EXPLORER™ 500, select NAT: **On**.

Changing or Disabling the PIN Code

To access the PIN code options, select **Settings** > **Security** from the left navigation pane.

Changing the PIN Code

1. In the **Change PIN Code** section of the **Security** window, type in the current PIN code in the **Current PIN code** field.
2. Type in the new PIN code in the first **New PIN code** field.
The PIN code must be from 4 to 8 digits long.
3. Repeat the new PIN code in the next **New PIN code** field.
4. Click **Apply**.

Disabling the PIN Code

1. In the **Disable PIN Code** section of the **Security** window, type in the current PIN code in the **Current PIN code** field.
2. Click **Disable**.
The PIN code is disabled. Access to the EXPLORER™ 500 will no longer require a PIN code.

Note

If you need to reenabte the use of PIN code, select **Settings** > **Security** again, enter the PIN code and click **Enable**.

Viewing Properties of the EXPLORER™ 500

Properties

To view the properties of the EXPLORER™ 500, select **Properties** from the left navigation pane.

The Properties window shows:

- **Current IP address.** The IP address of the built-in Web interface in the EXPLORER™ 500.
- **IMEI number.** The IMEI number (International Mobile Equipment Identity) of the EXPLORER™ 500. This is a unique number that identifies your EXPLORER™ 500. IMEI numbers are stored in a database containing all valid mobile phone equipment.
- **SMS service number.** A number used to identify the SMS service centre used by your EXPLORER™ 500 to send and receive SMS messages.
- **Voice mail service number.** The phone number to call to hear your Voice mail.
- **Mobile numbers.** The numbers to use for Standard voice, Premium voice and IP connection when calling the EXPLORER™ 500.
- **Hardware information.** The unit serial number and PCB numbers of the EXPLORER™ 500.
- **Software information.** The software version.

Viewing the Alarm List

To view the Alarm list, select **Properties > Alarm list** from the left navigation pane.

The Alarm list window shows a detailed list of active alarms.

Updating Software

Updating Software Using the Web Interface

To update the software of the EXPLORER™ 500, do as follows:

1. Acquire the new software version from Thrane & Thrane and save it on your PC.
2. In the Web interface, select **Properties** from the left navigation pane.
3. Locate the **Software information** field and check the current version of the EXPLORER™ 500 software.
4. To upload new software, click **Upload**.
5. Click **Browse**.
6. Browse to the new software version and select it.
7. Click **OK**.

The software is now updated. Note that you have to restart the EXPLORER™ 500 to activate the new software.

Updating the Software Using the Keypad

To update the software of the EXPLORER™ 500, do as follows:

1. Acquire the new software version from Thrane & Thrane and save it on your PC.
2. Connect a USB cable between your PC and the EXPLORER™ 500.
Refer to **Using the USB Interface** on page 4-14.
3. TBD
4. Press and hold the C button while you power up the EXPLORER™ 500.

TBD

Accessing the Help Desk

If you need help regarding airtime, you may call the Help desk. The Help desk is the phone number for your airtime provider.

Select **Help desk** from the left navigation pane.

The helpdesk number can be taken from the SIM card or entered manually. To change the number, click **Edit**, change the number and click **OK**.

Generating a Diagnostic Report

If you want to generate a diagnostic report, select **Help desk** from the left navigation pane and click **Generate report**. The report is saved to a file, which you can enclose when reporting an error.

The diagnostic report contains relevant information for troubleshooting, such as the error log, the alarm log, the list of currently active alarms and the call log (phone numbers not included).

What's Next?

This chapter has explained how to use the Web interface for setup and use of the EXPLORER™ 500. You should now be able to set up the EXPLORER™ 500, pair Bluetooth devices, check status, read and send SMS messages, use the phone book and much more.

The following chapter, **Maintenance and Troubleshooting**, provides guidelines for troubleshooting and for general maintenance.

Maintenance and Troubleshooting

In This Chapter

This chapter gives guidelines for troubleshooting and for general maintenance. It also provides an overview of the different means of status signalling,

Getting Support

If this manual does not provide the information required to solve your problem, you may want to contact your Airtime Provider or your local distributor.

Airtime: If you need assistance from your Airtime provider, please call the help desk. To see the help desk number, enter the display menu system of your EXPLORER™ 500 and select HELP DESK.

EXPLORER™ 500: If you need assistance regarding problems caused by the EXPLORER™ 500 terminal, please call a distributor in your area. Click the following link to see a list of Thrane & Thrane distributors.

[List of Distributors](#)

Note

This list of distributors is static, so it may not always be up to date.

An updated list is available on Thrane & Thrane's web site: www.thrane.com. Click Land Mobile and select Distributors from the top menu bar.

Recharging the Battery

It is recommended to fully charge the battery before using the EXPLORER™ 500 for the first time.

To charge the battery, insert it into the EXPLORER™ 500 and connect the EXPLORER™ 500 to power.

The indicator left to the display is constantly green as long as the battery is charging. When the battery is fully charged, the green indicator is turned off. If the EXPLORER™ 500 is switched on, the green indicator will be flashing shortly every 2 seconds.



If a charging error occurs, the green indicator on the EXPLORER™ 500 flashes rapidly. If this is the case, check that

- the battery is properly inserted
- the power cable and adapter are properly connected

If the battery is not functional, please acquire a new battery. For information on how to replace the battery, see **Removing the Battery** on page 2-3 and **Inserting the Battery** on page 2-2.

Options and Accessories

The following options and accessories are available from Thrane & Thrane:

Item	Number
EXPLORER™ 500 Bluetooth Handset + charger 	TT-3625A
Desktop charger cradle for Bluetooth handset 	Opt. 003
External antenna + 10 m antenna cable and pole mount kit	TT-3008I
Pole mount kit	Opt. 922
Softbag for the EXPLORER™ 500	Opt. 202
Battery for the EXPLORER™ 500 	TT-3686L
AC/DC power supply 	TT-3682L
Car charger cable (37-108299-A) 	Opt. 009

Upgrading Software

Viewing Software Version Status

To view the version of the embedded software in the EXPLORER™ 500, select **Properties** in the Web interface or in the display menus and see **Software information**.

Updating Software Using the Web Interface

To update the software of the EXPLORER™ 500, do as follows:

1. Acquire the new software version from Thrane & Thrane and save it on your PC.
2. In the Web interface, select **Properties** from the left navigation pane.
3. Locate the **Software information** field and check the current version of the EXPLORER™ 500 software.
4. To upload new software, click **Upload**.
5. Click **Browse**.
6. Browse to the new software version and select it.
7. Click **OK**.

The software is now updated. Note that you have to restart the EXPLORER™ 500 to activate the new software.

Troubleshooting Guide

The below table provides information on some of the problems that might occur, including possible causes and solutions to the problems.

Problem	Possible Cause	Solution
The EXPLORER™ 500 cannot be turned on, or does not stay on when powered by the battery.	The battery needs recharging.	Charge the battery. Check the battery indicator in the display.
	The battery is not inserted properly.	Remove the battery and re-insert it. Make sure the battery is inserted properly and that the latch is locked.
	The battery contacts are dirty or damaged.	Clean the battery contacts if necessary. If the contacts are damaged, replace the battery.
Charging error - The green Power indicator flashes rapidly while the battery is being charged.	The temperature is below 0°C or above 45°C.	Only charge the battery when the temperature is within the range 0°C to 45°C.
	The charging voltage is less than 9 V.	Check that the voltage applied to the DC input of the EXPLORER™ 500 is within the specified range (+10 to +16 V DC). If the DC input is within limits, and the error persists, contact your local distributor.
The display shows INSERT SIM.	The SIM card is not present.	Remove the battery and insert the SIM card in the SIM card slot according to the instructions in the section Inserting the SIM Card on page 2-2.
	The SIM card is not inserted properly.	Remove the SIM card and re-insert it according to the instructions in the section Inserting the SIM Card on page 2-2.

Problem	Possible Cause	Solution
<p>The EXPLORER™ 500 cannot obtain its position using GPS</p>	<p>There is no GPS signal, or the signal is weak.</p>	<p>Check the GPS status in the display or the Web interface.</p> <p>Make sure the GPS antenna has a clear view of the sky.</p> <p>Place the EXPLORER™ 500 flat on a surface to obtain the best possible view.</p>
	<p>It can take up to 10 minutes to obtain the GPS position.</p>	<p>Wait 10 minutes.</p> <p>If you know the approximate direction to the BGAN satellite, you can start the pointing process before the GPS position is found.</p>
<p>No signal or weak signal from the satellite</p>	<p>The view to the satellite is blocked</p>	<p>Make sure the EXPLORER™ 500 has a clear view to the satellite. Be aware that window glass may reduce the signal level.</p>
	<p>The antenna is pointed in the wrong direction</p>	<p>Check that the antenna is pointed according to the position data.</p> <p>Adjust the position to the highest possible signal strength.</p>

Problem	Possible Cause	Solution
Connection to the Internet cannot be established	The signal strength is too low.	Check that the antenna is pointed according to the position data. Adjust the position to the highest possible signal strength. For information on minimum required signal strength for a particular service, see Minimum Signal Strength on page 2-11.
	Your connection is defined as a dial-up connection, but you have not opened the dial-up connection.	You need to open the dial-up connection before you can connect to the Internet.
	Your connection is a dial-up connection, but you have not entered the phone number *98# to indicate a connection to the Internet.	Change the phone number in the dial-up connection to *98# and open the dial-up connection before accessing the Internet.
The Web interface cannot be accessed	The browser is configured to use a proxy server	For Microsoft Internet Explorer, select Tools > Internet Options > Connections > LAN Settings and uncheck Use a proxy server for your LAN .
	You have entered a wrong IP address	Check the IP address and re-enter it.
	Your connection is defined as a dial-up connection, but you have not opened the dial-up connection.	You need to open the dial-up connection before you can connect to the Web server.
	Your connection is a dial-up connection, but you have not entered *99# as the phone number to indicate that this is a connection to the Web interface.	Change the phone number in the dial-up connection to *99# and open the dial-up connection before accessing the Web interface.

Problem	Possible Cause	Solution
A Phone/Fax connection cannot be established	The interface is off in the EXPLORER™ 500	Turn on the interface by entering the display menu system and selecting SETTINGS > INTERFACES > PHONE/FAX > ON
	The cable is not properly connected	Connect the cable.
	The cable type or connector type is not correct	For information on the correct type of connector and cable, refer to Phone/Fax Interface on page A-4.
	Incoming calls: The voice quality used for the call is not selected in the Web interface.	Make sure the voice quality used for calls to the terminal is selected in the Web interface. Access the Web interface and select SETTINGS > INTERFACES > PHONE/FAX . Then select the voice quality for incoming calls.
A Bluetooth handset connection cannot be established	The interface is off in the EXPLORER™ 500	Turn on the interface by entering the display menu system and selecting SETTINGS > INTERFACES > BLUETOOTH > ON
	The Bluetooth handset is placed too far away from the EXPLORER™ 500	Bring the handset closer to the EXPLORER™ 500. Note that the specified maximum distance is only valid under ideal conditions.
	The handset is not yet paired with the EXPLORER™ 500	Pair the devices. Refer to Making a Call To the EXPLORER™ 500 on page 4-9.
	Incoming calls: The voice quality used for the call is not selected in the Web interface.	Make sure the voice quality used for calls to the terminal is selected in the Web interface. Access the Web interface and select SETTINGS > INTERFACES > BLUETOOTH . Then select the voice quality for incoming calls.

Problem	Possible Cause	Solution
A LAN connection cannot be established	The interface is off in the EXPLORER™ 500	Turn on the interface by entering the display menu system and selecting SETTINGS > INTERFACES > LAN > ON
	The cable is not properly connected	Connect the cable.
	The cable type or connector type is not correct	For information on the correct type of connector and cable, refer to LAN Interface on page A-5.
	The interface is not configured correctly.	For configuration of the interface, see Configuring the LAN Interface on page 5-14.
A USB connection cannot be established	The interface is off in the EXPLORER™ 500	Turn on the interface by entering the display menu system and selecting SETTINGS > INTERFACES > USB > ON
	The cable is not properly connected	Connect the cable.
	The cable type or connector type is not correct	For information on the correct type of connector and cable, refer to USB Interface on page A-6.
	The dial-up connection is not created correctly.	Refer to First Time Setup of USB on page 4-14.
	The interface is not configured correctly.	For configuration of the interface, see Configuring the USB Interface on page 5-15.

Problem	Possible Cause	Solution
A Bluetooth data connection cannot be established	The interface is off in the EXPLORER™ 500	Turn on the interface by entering the display menu system and selecting SETTINGS > INTERFACES > BLUETOOTH > ON
	The data unit is placed too far away from the EXPLORER™ 500	Bring the data unit closer to the EXPLORER™ 500. Note that the specified maximum distance is only valid under ideal conditions.
	The data unit is not yet paired with the EXPLORER™ 500	Pair the devices. Refer to Making a Call To the EXPLORER™ 500 on page 4-9.
	The interface is not configured correctly.	For configuration of the interface, see Configuring the Bluetooth Data Interface on page 5-16.

Status Signalling

There are many ways of troubleshooting if an error occurs. The EXPLORER™ 500 has different means of status signalling, to help you find the cause of a problem:

- **Indicators.**

The function of the light indicators next to the display is described in **Light Indicators** on page 1-7.



- **Error messages.**

- **Log files.**

Error messages and log files are described in the following sections.

Error Messages

Types of Error messages

Different types of error messages can appear in the EXPLORER™ 500.

- Messages received from the network describe the network related conditions, such as “network busy”.
- Messages generated by the EXPLORER™ 500 describe errors related to the terminal itself. For example, this could be information that the temperature is too high.

TBD

Display of error messages

When an alarm is issued, the display shows that there is an active alarm and the red indicator next to the display is flashing. If you press OK, the display returns to the Main screen, with the text `VIEW ALARM LIST?` If you press OK again, the list of currently active alarms appears.

As long as the cause of an alarm is still present, the red indicator keeps flashing.

Messages are logged in the Alarm log, which can be viewed with the Web interface. For information on the Alarm log, see **Alarm Log** on page 6-11.

TBD

Log Files

Note

When contacting Thrane & Thrane for support, please include a diagnostic report. The diagnostic report contains the log files and other information relevant when troubleshooting.

To generate the diagnostic report, access the Web interface and select **Help Desk**. Then click **Generate report**.

Alarm Log

The alarm log holds information of errors found by the EXPLORER™ 500 during continuous monitoring.

The log includes the time of the error, a short description, location of the error etc. This information can help you troubleshoot errors in the EXPLORER™ 500.

Call Log

The call log holds information of up to 100 calls and data sessions to/from the EXPLORER™ 500.

The call log contains detailed information, such as date, time, phone numbers, duration, Mb transferred etc., for each call or data session.

Date and time is UTC time, received from the satellite.

Technical Specifications

In This Appendix

This appendix contains technical specifications for the EXPLORER™ 500.

General Specifications

The EXPLORER™ 500 meets or exceeds current and proposed Inmarsat specifications for operation on the Inmarsat Broadband Global Area Network.

Item	Specification
Type	BGAN Class 2 User Terminal
Max. data rate ^a	
Downlink	464 kbps (shared)
Uplink	448 kbps (shared)
Physical dimensions	218 mm x 216 mm x 52 mm/ 8.6" x 8.5" x 2.0"
Weight (incl. Battery)	1.3 kg/2.9 lbs
Environmental conditions	
Operating temperature	
Powered by external DC	-25°C to +55°C/-13°F to +131°F
Powered from battery	0°C to +55°C/+32°F to +131°F
Storage temperature	
Without battery	-40°C to +80°C/-40°F to +176°F
With battery	-20°C to +60°C/-4°F to +140°F
Relative humidity	95% non-condensing at +40°C/+104°F
Water & Dust	IP-54 (dust and spray proof in all directions)
Max. wind-load	18 m/s or 59 ft/s (Operational)
Robustness	0.5 m/1.64 ft drop on concrete (Operational, 95% survival)

a. Performance depends on a wide range of factors and actual usage.

Battery

Specifications

Item	Specification
Battery type	Lithium ion (Rechargeable)
Voltage	11.1 V
Capacity	2.2 Ah
Time between recharging	
Standby time	36 h
Data transmission	1 h 30 m @144 kbps
Charge time ^a	Less than 3 hours (when the terminal is switched OFF)
Charge temperature	0°C to +45°C/+32°F to +113°F Ambient
Min. charge cycles	300
Storage temperature	
1 Month	-20°C to +60°C/-4°F to +140°F Ambient
3 Months	-20°C to +45°C/-4°F to +113°F Ambient
1 Year	-20°C to +20°C/-4°F to +68°F Ambient

a. Performance depends on a wide range of factors and actual usage.

Power Input

Connector Pin-Out

This drawing shows the pin-out for the DC power connector.

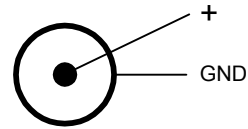

Specifications

Item	Specification
DC input range	+10 to +16 V DC
Power consumption ^a	
Standby mode	0.5 to 1 W (Typical)
Transmit mode	14 W (Typical)
During charging	38 W max.
Connector type	2.5 mm EIAJ RC-5320-IV

a. Performance depends on a wide range of factors and actual usage.

AC/DC Power supply

Item	Specification
AC input range	100 to 240 V AC, 47 to 63 Hz
DC output	15 V DC, 50 W

SIM Interface

Item	Specification
Slot type	Standard USIM card holder

Phone/Fax Interface

Connector Pin-Out

The pin-out for the Phone/fax connector is as follows:

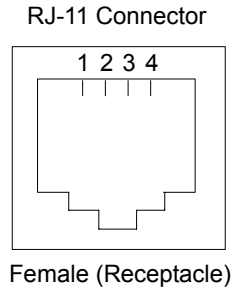

Pin	Function
1	NC
2	Tip
3	Ring
4	NC

Specifications

Item	Specification
Connector type	RJ-11
Impedance	600Ω
Max. cable length	400 m/1312 ft
Max. units connected	One unit

LAN Interface

Connector Pin-Out

The pin-out for the LAN connector is as follows:

RJ-45 Connector

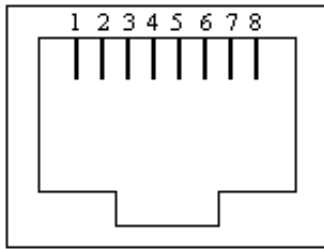

Female (Receptacle)

Pin	Function
1	Rx +
2	Rx -
3	Tx +
4	NC
5	NC
6	Tx -
7	NC
8	NC

Specifications

Item	Specification
Connector type	RJ-45, MDI-X (IEEE 802.3 10/100BaseT)
Standard	ISO/IEC 8877:1992 and IEEE 802.3 1998 Edition
Max. data rate	100 Mbps
Max. cable length	100 m/328 ft with Cat5 UTP
Supported web browser	Microsoft Internet Explorer 6.0 or later
Default IP Address	192.58.0.1
Operating Systems	Microsoft Windows 2000, Microsoft Windows XP, Mac OS 9.2, Mac OS 10.1, Linux Redhat 9

USB Interface

Connector Pin-Out

The pin-out for the USB connector is as follows:

Pin	Function
1	NC
2	D -
3	D +
4	NC
5	GND

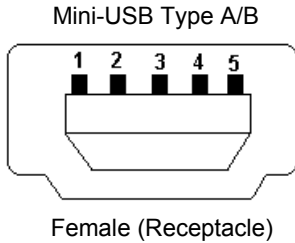

Specifications

Item	Specification
Version	1.1 (Slave)
Connector type	Mini-B
Max. data rate	12 Mbps
Max. cable length	5 m/16.4 ft
Max. units connected	7 physical devices
Operating Systems	Microsoft Windows 98SE, Microsoft Windows ME, Microsoft Windows NT 4.0, Microsoft Windows 2000, Microsoft Windows XP, Palm OS, IBM OS/2, DOS, MAC OS 8.5 & above, Linux.
Driver	Proprietary, enclosed on CD with the product

Bluetooth Interface

Specifications

Item	Specification
Version	1.2
Standard	Power Class 1 The Class 1 interface also supports Class 2 and Class 3 peripherals if they support RSSI (Received Signal Strength Indicator)
Physical media	Frequency-Hopping Spread Spectrum RF
Max. data rate	721 kbps + 57.6 kbps
Frequency	2400 to 2483.5 MHz
Max. coverage outdoor ^a	100 m/328 ft
Max. number of devices connected	7
Profiles supported	Cordless Telephony, Serial Port, Service Discovery Application, Dial-up networking, LAN access

a. Performance depends on a wide range of factors and actual usage.

Built-in Antenna

Built-in Antenna Specifications

Item	Specification
Type	Directional patch array, manually adjustable
Polarization	RHCP
Frequencies	
Inmarsat	
Transmit	1626.5 to 1660.5 MHz
Receive	1525.0 to 1559.0 MHz
Bearer bandwidth	200 kHz
GPS	1575.42 MHz
Bluetooth	2400.0 to 2483.5 MHz
EIRP	15.1 dBW \pm 1 dB
Power steps	0 to 10 dB in 1 dB steps

External Antenna

Connector Pin-Out

This drawing shows the pin-out for the external antenna connector on the EXPLORER™ 500.

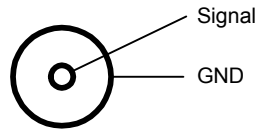

Electrical Specifications

Important Only use the specified antenna from Thrane & Thrane. The antenna is listed in **Options and Accessories** on page 6-2.

Item	Specification
Type	Directional patch array, manually adjustable
Polarization	RHCP
Connector type	50 Ω QLA (female)
Frequencies	
Inmarsat	
Transmit	1626.5 to 1660.5 MHz
Receive	1525.0 to 1559.0 MHz
Bearer bandwidth	200 kHz
GPS	1575.42 MHz
EIRP	15.1 dBW \pm 1 dB

EXPLORER™ 500 Bluetooth Handset Charger Interface

Connector Pin-Out

This drawing shows the pin-out for the EXPLORER™ 500 Bluetooth Handset charging interface.

The connector is placed at the back of the EXPLORER™ 500.

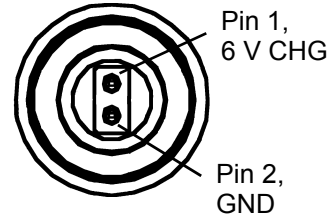

Front view, when the terminal is placed in a normal upright position (the battery facing down)

Electrical Specifications

Item	Specification
Connector type	Proprietary
Output	6.2 V/350 mA

AT Commands

In This Appendix

This appendix contains a list of AT Commands for the EXPLORER™ 500.

Starting up an AT Command Session

Set up your data unit to use either the USB or Bluetooth interface. For further information, see **Using the USB Interface** on page 4-14 or **Using a Data Unit with Bluetooth** on page 4-18.

Connect your data unit to the USB or Bluetooth interface of the EXPLORER™ 500 and launch your terminal program.

The following section contains a list of commands that can be used with the EXPLORER™ 500. For further information on the AT commands, refer to the following standards:

- **ITU V.25,0** Serial asynchronous automatic dialling and control
- **3GPP TS 27.005 ver. 4.2**, Use of Data Terminal Equipment - Data Circuit terminating Equipment (DTE-DCE) interface for Short Message Service (SMS) and Cell Broadcast Service (CBS)
- **3GPP TS 27.007 ver. 4.6**, AT command set for User Equipment (UE)

3GPP standards are found on www.3gpp.org

ITU standards are found on www.itu.int

List of Supported AT Commands

Command	Function
ATA	Answer
ATD	Dial
ATE	Command echo
ATH	Hang up
ATI	Request identification information
ATL	Monitor speaker loudness
ATM	Monitor speaker mode
ATN	Automode control
ATP	Select pulse dialling (command)
ATQ	Result code suppression
ATS	Set register
ATT	Select tone dialling (command)
ATV	DCE response format
ATX	Result code selection and call progress monitoring control
ATZ	Reset to default configuration
AT&C	Circuit 109 (Received line signal detector) behaviour
AT&D	Circuit 108 (Data terminal ready) behaviour
AT&F	Set to factory defined configuration
AT&V	Display active and stored profile
AT&W	Store profile
AT+CACM	Accumulated call meter
AT+CAEMLPP	eMLPP priority registration and interrogation
AT+CALM	Alert sound mode
AT+CAMM	Accumulated call meter
AT+CAOC	Advice of charge

Command	Function
AT+CBC	Battery charge
AT+CBST	Select bearer service type
AT+CCFC	Call forwarding number and conditions
AT+CCLK	Clock
AT+CCUG	Closed user group
AT+CCWA	Call waiting
AT+CCWE	Call meter maximum event
AT+CDIP	Called line identification presentation
AT+CEER	Extended error report
AT+CFCS	Fast call setup conditions
AT+CFUN	Set phone functionality
AT+CGACT	PDP context activate or deactivate
AT+CGATT	PS attach or detach
AT+CGCLASS	GPRS mobile station class +CGCLASS
AT+CGCMOD	PDP context modify
AT+CGDATA	Enter data state
AT+CGDCONT	Define PDP context
AT+CGDSCONT	Define secondary PDP context
AT+CGEQMIN	3G quality of service profile (minimum acceptable)
AT+CGEQNEG	3G quality of service profile (negotiated)
AT+CGEQREQ	3G quality of service profile (requested)
AT+CGEREP	Packet domain event reporting
AT+CGMI	Request manufacturer identification
AT+CGMM	Request model identification
AT+CGMR	Request revision identification
AT+CGPADDR	Show PDP address

Command	Function
AT+CGQMIN	Quality of service profile (minimum acceptable)
AT+CGQREQ	Quality of service profile (requested)
AT+CGREG	GPRS network registration status
AT+CGSMS	Select service for MO SMS messages
AT+CGSN	Request product serial number identification
AT+CGTFT	Traffic flow template
AT+CHLD	Call related supplementary services
AT+CHUP	Hang-up call
AT+CIMI	Request International Mobile Subscriber Identity
AT+CIND	Indicator control
AT+CLAC	List all available AT commands
AT+CLCC	List current calls
AT+CLCK	Facility lock +CLCK
AT+CLIP	Calling line identification presentation
AT+CLIR	Calling line identification restriction
AT+CMAR	Master reset
AT+CMEC	Mobile equipment control mode
AT+CMEE	Report mobile equipment error
AT+CMER	Mobile equipment event reporting
AT+CMGC	Send command
AT+CMGD	Delete message
AT+CMGF	Message format
AT+CMGL	List messages
AT+CMGR	Read messages
AT+CMGS	Send message
AT+CMGW	Write message to memory

Command	Function
AT+CMOD	Call mode
AT+CMSS	Send message from storage
AT+CMUX	Multiplexing mode
AT+CNMI	New message indication to TE
AT+CNUM	Subscriber number
AT+COLP	Connected line identification presentation
AT+COPN	Read operator names
AT+COPS	PLMN selection
AT+CPAS	Phone activity status
AT+CPBF	Find phone book entries
AT+CPBR	Read phone book entries
AT+CPBS	Select phone book memory storage
AT+CPBW	Write phone book entry
AT+CPIN	Enter PIN
AT+CPLS	Selection of preferred PLMN list
AT+CPMS	Preferred message storage
AT+CPOL	Preferred PLMN list
AT+CPPS	eMLPP subscriptions
AT+CPUC	Price per unit and currency table
AT+CPWD	Change password
AT+CR	Service reporting control
AT+CRC	Cellular result codes
AT+CREG	Network registration
AT+CRSM	Restricted SIM Access
AT+CSCA	Service centre address
AT+CSCS	Select TE character set

Command	Function
AT+CSDF	Settings date format
AT+CSIL	Silence command
AT+CSMS	Select message service
AT+CSQ	Signal quality
AT+CSSN	Supplementary service notifications
AT+CSTA	Select type of address
AT+CSTF	Settings time format
AT+CSVM	Set voice mail number
AT+CUSD	Unstructured supplementary service data
AT+CAAP	Automatic answer for eMLPP Service
AT+FCLASS	Select mode
AT+GCAP	Request complete capabilities list
AT+GCI	Country of Installation
AT+GMI	Request manufacturer identification
AT+GMM	Request model identification
AT+GMR	Request revision identification
AT+GSN	Request product serial number identification
AT+ICF	DTE DCE character framing
AT+IFC	DTE-DCE local flow control
AT+ILRR	DTE-DCE local rate reporting
AT+IPR	Fixed DTE rate
AT+WS46	PCCA STD-101 [17] select wireless network
AT_IBLTH	Bluetooth management
AT_IBNOTIFY	Control the sending of unsolicited result codes
AT_IBTIF	Bluetooth configuration
AT_IBTINQ	Bluetooth inquiry management

Command	Function
AT_IGPS	GPS location information
AT_ILOG	Retrieve UT log file
AT_IMETER	Call metering
AT_INIS	Network interface status
AT_IPOINT	Antenna pointing
AT_ISIG	Signal quality indication
AT_ISLEEP	UT sleep mode timeout
AT_ITCSI	Configure incoming voice quality
AT_ITCSO	Configure outgoing voice quality
AT_ITEMP	UT temperature
AT_ITNAT	Configure NAT for an interface

Glossary

B

BGAN Broadband Global Area Network. A satellite network based on geostationary satellites, delivering data rates of up to 492 kbps to virtually any part of the earth, with full UMTS (3G) compatibility.

D

Data unit In this manual, the term Data unit is used for equipment such as a PC, a laptop, a PDA or similar equipment that can establish data communication with the EXPLORER™ 500.

G

Geostationary Placed in a fixed position relative to a point on the surface of the earth.

GMDSS Global Maritime Distress and Safety System. A system based on a combination of satellite and terrestrial radio services, providing a range of safety services, such as broadcast of safety information and automatic distress alerting and locating.

GPS Global Positioning System. A system of satellites, computers, and receivers that is able to determine the latitude and longitude of a receiver on Earth by calculating the time difference for signals from different satellites to reach the receiver.

I

IMEI International Mobile Equipment Identity. A unique number given to every single piece of mobile phone equipment. IMEI numbers are stored in a database containing all valid mobile phone equipment.

IMSO International Maritime Satellite Organisation. An intergovernmental body established to ensure that Inmarsat continues to meet its public service obligations, including obligations relating to the GMDSS.

L

LAN Local Area Network. A system that links together electronic office equipment, such as computers and word processors, and forms a network within an office or

building.

M

MDI-X Medium Dependent Interface. An MDI-X (for MDI crossover) is a version of MDI that enables connection between like devices. MDI ports connect to MDI-X ports via straight-through cabling. MDI-to-MDI and MDIX-to-MDIX connections use crossover cabling.

N

NAT Network Address Translation. An Internet standard that enables a local-area network to use one set of IP addresses for internal traffic and a second set of addresses for external traffic. A NAT module makes all necessary address translations.

P

PCB Printed Circuit Board

PDA Personal Digital Assistant. A lightweight, hand-held, usually pen-based computer used as a personal organiser.

PIN Personal Identification Number. A code number used to provide access to a system, that has restricted access.

PUK PIN Unblocking Key. An eight-digit code used to unblock a SIM card after three incorrect PINs have been entered. The PUK code is supplied with the SIM card.

R

RSSI Received Signal Strength Indicator

S

SAS Satellite Access Station

Streaming A technique for transferring data—such as audio or video clips—so that it is processed as a continuous stream.

U

USB Universal Serial Bus. An interface standard for communication between a computer and external peripherals over an inexpensive cable using biserial transmission. Mostly used with keyboards, mice, monitors and printers.

Index

Numerics

- 2-wire interface
 - Connecting, 4-6
 - Specifications, A-4

A

- Accessories available, 6-2
- Advanced configuration
 - Bluetooth, 5-16
 - LAN, 5-14
 - USB, 5-15
- Alarms
 - In display, 3-14
 - List of active, 3-12
 - Viewing active, 5-18
- Antenna
 - Specifications, A-8
- APN
 - Setting for Bluetooth, 5-16
 - Setting for LAN, 5-14
 - Setting for USB, 5-15
- Applications overview, 1-5
- AT Commands, B-1
- Audio indicators, 3-9, 5-12
- Audio quality, 4-4
- Automatic power up, 3-10, 5-11
- Azimuth, 2-10

B

- Battery
 - Charging, 6-1
 - Inserting, 2-2
 - Removing, 2-3
 - Specifications, A-2
- BGAN
 - Coverage, 1-2
 - Services, 1-4
 - System overview, 1-3
- Bluetooth data interface
 - Connecting, 4-18
 - Setting up, 5-16

- Bluetooth devices
 - Pairing, 4-17
 - Unpairing, 4-18
 - Viewing list of paired, 4-17
- Bluetooth handset
 - Charging interface, 4-19, A-10
 - Making a call, 4-8
- Bluetooth interface
 - Specifications, A-7
- Brightness of display, 3-8, 5-11
- Browser settings
 - For Web interface, 5-2

C

- Call log, 3-7, 3-8
- Calls
 - Conference, 4-11
 - Holding, 4-11
 - Local, 4-10
 - Making or receiving, 4-8
 - Missed, received, outgoing, 3-7, 3-8
 - Multiparty, 4-11
 - Redial, 4-9
 - To the EXPLORER™ 500, 4-9
 - Waiting indication, 4-10
- Configuration
 - Bluetooth data interface, 5-16
 - LAN interface, 5-14
 - USB interface, 5-15
- Connection class
 - Setting for Bluetooth, 5-16
 - Setting for LAN, 5-14
 - Setting for USB, 5-15
- Connectors
 - Bluetooth handset charging, A-10
 - External antenna, A-9
 - LAN, A-5
 - Overview, 2-5
 - PhoneFax, A-4
 - Power, A-3
 - USB, A-6
- Contrast in display, 3-8, 5-11
- Coverage
 - Inmarsat BGAN System, 1-2

D

- Delivery
 - Items included, 2-1
- Diagnostic report
 - Generate, 5-19
- Display
 - Brightness, 3-8, 5-11
 - Contrast, 3-8, 5-11
 - Menu drawing, 3-2
 - Navigating, 3-5
 - Overview of menus, 3-1
 - Short-cuts, 3-6
 - Symbols, 3-5
- DNS
 - Setting for Bluetooth, 5-16
 - Setting for LAN, 5-14
 - Setting for USB, 5-15

E

- Elevation, 2-10
- Error report, 5-19
- Ethernet interface
 - Connecting, 4-13
 - Setting up, 5-14
 - Specifications, A-5
- EXPLORER™ 500
 - Getting to know, 1-6

F

- Fax
 - Sending, 4-12
- Features, 1-5

G

- General specifications, A-1
- GPS
 - Antenna, 1-8
 - Frequency, A-8
 - Position, 3-11
 - Troubleshooting, 6-5
 - View status, 3-11

H

- Help desk number, 3-13, 5-19
 - Changing with Web interface, 5-19

I

- IMEI number, 3-12, 5-18
- Indicators
 - Function, 1-7
- Interfaces
 - Turning on or off, 3-9, 4-3
- Interfaces and services
 - Combinations, 1-9
- Internal calls, 4-10
- IP address, 3-12, 5-18
- Items included in delivery, 2-1

L

- LAN interface
 - Connecting, 4-13
 - Setting up, 5-14
 - Specifications, A-5
- LEDs
 - Function, 1-7
- Light and sound
 - Disabling, 3-9, 5-12
- Light indicators
 - Function, 1-7
- Local phone call, 4-10

M

- Matrix of services and interfaces, 1-9
- Messages
 - Configuring outgoing, 5-10
 - Deleting in display, 3-7
 - Deleting in Web interface, 5-9
 - Delivery notification, 5-10
 - Forwarding, 5-9
 - Opening in display, 3-7
 - Opening in Web interface, 5-9
 - Receiving in display, 3-13
 - Receiving in Web interface, 5-9
 - Replying, 5-9
 - Sending, 5-8
 - View list in display, 3-7

Mobile numbers, 5-18
Viewing, 3-12

N

NAT
Setting on or off for Bluetooth, 5-16
Setting on or off for LAN, 5-14

Navigation
Display and keypad, 3-5
Web interface, 5-3

O

Off-line
Working with EXPLORER™ 500, 2-8

Options available, 6-2

P

Paired Bluetooth devices
View list, 4-17

Pairing Bluetooth devices, 4-17

Phone
Local call, 4-10
Making calls, 4-8

Phone book, 5-6
Add number, 5-7
Modify entry, 5-7

Phone/fax interface
Connecting, 4-6
Specifications, A-4

PIN code
Changing, 5-17
Disabling, 5-17
Entering in display, 2-9
Entering in Web interface, 5-4
Entering with a phone, 4-7

Pointing
Data, 2-10
Display menu, 3-3
Help, 2-10
Repoint the antenna, 3-8
Sound on/off, 3-9, 5-12

POTS interface
Connecting, 4-6
Specifications, A-4

Power, 2-6
Automatic, 3-10, 5-11
Connecting, 2-5
Sources, 2-6
Specifications, A-3
Switching on, 2-6

Power up mode, 3-10, 5-11

Properties
View, 3-12, 5-18

Proxy server
Disabling, 5-2

PUK code, 2-9, 4-7, 5-4

Q

Quality of Voice, 4-4

Quick Dial, 4-8

R

Redial, 4-9

Restoring settings, 3-10

S

Safety summary, iv

Serial number, 3-12, 5-18

Services
Supported by BGAN, 1-4

Services and interfaces
Combinations, 1-9

Settings
Restore, 3-10

Short dial, 4-8

SIM card
Inserting, 2-2
Removing, 2-4
Specifications, A-3

SMS in display
Opening or Deleting, 3-7
Receiving, 3-13
View list, 3-7

SMS in Web interface
Deleting from Inbox, 5-9
Forwarding, 5-9
Opening, 5-9
Receiving, 5-9
Replying to, 5-9
Sending, 5-8

SMS service number, 5-10, 5-18

Sound

- Alarm, 3-9, 5-12
- Message, 3-9, 5-12
- Warning, 3-9, 5-12
- When pointing, 3-9, 5-12

Sound and light

- Disabling, 3-9, 5-12

Specifications

- Antenna, A-8
- Bluetooth handset charging interface, A-10
- Bluetooth interface, A-7
- Ethernet interface, A-5
- General, A-1
- LAN interface, A-5
- Phone/fax interface, A-4
- Power, A-3
- SIM card, A-3
- USB interface, A-6

Start-up

- Options, 2-7

Status

- Viewing, 5-5

Stealth mode, 5-12

- Activating, 3-6
- Enabling, 3-9

T

TCP/IP spoofing

- Setting on or off for Bluetooth, 5-16
- Setting on or off for LAN, 5-14
- Setting on or off for USB, 5-15

Telephone interface

- Connecting, 4-6
- Specifications, A-4

U

Unpairing Bluetooth devices, 4-18

USB interface

- Connecting, 4-14
- Setting up, 5-15
- Specifications, A-6

V

Version

- Hardware, 3-12, 5-18
- Software, 3-12, 5-18

Voice Mail service number, 5-10

Voice quality, 4-4

W

Web interface

- Accessing, 5-1
- Browser settings, 5-2
- Definition, 5-1
- Navigating, 5-3