

Thrane & Thrane A/S

IP Handset

User Manual

Document number: 98-126059-DraftC6

Release date: May 23, 2008

Information in this document is subject to change without notice and does not represent a commitment on the part of Thrane & Thrane A/S. We recommend downloading the latest version of the manual from the Thrane & Thrane Extranet.

Copyright © 2008 Thrane & Thrane A/S. All rights reserved.

Trademark Acknowledgements:

- **Thrane & Thrane** is a registered trademark of Thrane & Thrane A/S in the European Union and the United States.
- **Windows** and **Outlook** are registered trademarks of Microsoft Corporation in the United States and other countries.
- **Inmarsat** is a registered trademark of International Maritime Satellite Organisation (IMSO) and is licensed by IMSO to Inmarsat Limited and Inmarsat Ventures plc.
- Inmarsat's product names are trademarks or registered trademarks of Inmarsat.
- Other product and company names mentioned in this manual may be trademarks or trade names of their respective owners.

Company Addresses

www.thrane.com

Denmark

Company headquarters

Thrane & Thrane A/S
Lundtoftøgårdsvej 93 D
DK-2800 Kgs. Lyngby
Denmark

Denmark

Thrane & Thrane Aalborg A/S
Porsvej 2
DK-9200 Aalborg SV
Denmark

USA

Thrane & Thrane, Inc.
509 Viking Drive, Suites K, L and M
Virginia Beach, VA 23452
USA

China

Thrane & Thrane Shanghai
Unit 602 - Building 4,
289 Bisheng Rd.
Zhangjiang High-tech Park,
Pudong
201204 Shanghai
P. R. China

Safety Summary

The following general safety precautions must be observed during all phases of operation, service and repair of this equipment. Failure to comply with these precautions or with specific warnings elsewhere in this manual violates safety standards of design, manufacture and intended use of the equipment. Thrane & Thrane A/S assumes no liability for the customer's failure to comply with these requirements.

DO NOT OPERATE IN AN EXPLOSIVE ATMOSPHERE

Do not operate the IP Handset in the presence of flammable gases or fumes. Operation of any electrical equipment in such an environment constitutes a definite safety hazard.

KEEP AWAY FROM LIVE CIRCUITS

Operating personnel must not remove equipment covers. Component replacement and internal adjustment must be made by qualified maintenance personnel. Do not replace components with the cable connected. Always disconnect power and discharge circuits before touching them.

About the Manual

Intended Readers

This manual is a user manual for the Thrane IP Handset. The readers of the manual include anyone who is using or intends to use the IP Handset. No specific skills are required to operate the IP Handset. However, it is important that you observe all safety requirements listed in the beginning of this manual, and operate the handset according to the guidelines in this manual.

Manual Overview

This manual has the following chapters:

- **Introduction** contains an overview and a brief description of the IP Handset.
- **Getting started** explains how to connect and start up the handset and gives an overview of the display and keypad. It also contains a short guide to initial configuration and to making the first call.
- **Operating the IP Handset** describes how to use and configure the handset and explains the display menus.
- **Using the web server** explains how to use the built-in web server of the IP Handset.
- **Troubleshooting** contains a short troubleshooting guide and gives information on where to get further help if needed.

This manual may not always reflect the latest software functionality of your IP Handset. To obtain the latest version of the manual, please enter the Thrane & Thrane Extranet and download the latest version, or acquire it from your distributor.

Typography

In this manual, typography is used as indicated below:

Bold is used for the following purposes:

- To emphasize words.
Example: “Do **not** touch the antenna”.
- To indicate what the user should select in the user interface.
Example: “Select **Settings > Display**”.

Italic is used to emphasize the paragraph title in cross-references.

Example: “For further information, see *Connecting Cables* on page...”.

COURIER is used to indicate display text.

Example: “The display shows **39558880**”.

Table of Contents

	Safety Summary	iii
	About the Manual	iv
Chapter 1	Introduction	
	Welcome	1
	In this chapter	1
	Your IP Handset	2
	Description	2
	The wireless IP handset	3
	The wired IP handset	4
	Features	5
	What's next?	5
Chapter 2	Getting started	
	In this chapter	7
	Getting started with the wireless IP Handset	7
	Introduction	7
	Preparing the hardware	8
	Charging the handset	11
	Connecting the handset to your Wi-Fi access point	14
	Getting started with the wired IP Handset	15
	Introduction	15
	Connectors	15
	Connecting the cables to the IP cradle	16
	Installing the cradle	18
	Connecting the wired handset to a BGAN terminal	19
	Starting up the wired IP Handset	20

Establishing a connection using BGAN terminal 21
Using a BGAN terminal 21
Establishing a connection 22
Connecting subsequent handsets to the BGAN terminal 24

Making the first call 26

The handset keypad and display 27
The keypad 27
The display 33

What's next? 38

Chapter 3 Operating the IP Handset

In this chapter 39

User interfaces 39

Handset functions 40
Making calls 40
Making a call using a BGAN terminal 43
Quick settings 45
Writing text in the handset 47
Using a headset 48

The menu system 49
Accessing the menu system 49
Menu overview 49
Call log 50
Contacts 52
Status 54
Network 55
Settings 61
SIP 68
BGAN 72

What's next? 73

Chapter 4 Using the web server

In this chapter 75

	Introduction	75
	The web server	75
	Browser settings	75
	Accessing and navigating the web server	77
	Pages in the web server	79
	The Home page	79
	Contacts	80
	Call log	81
	SIP settings	82
	Uploading firmware	84
	Import/Export settings	85
	Help	87
	What's next?	88
Chapter 5	Troubleshooting	
	In this chapter	89
	Getting support	89
	Overview	89
	Handset support	89
	Troubleshooting guide	90
App. A	Technical specifications	
	In this appendix	91
	IP Handset, wireless	92
	IP Handset, wired	94
	IP Handset, wireless, outline dimensions	96
	IP Handset, wired, outline dimensions	98
	IP cradle outline dimensions	100
App. B	Conformity	

Thrane IP Handset, wireless	103
CE (R&TTE)	103
FCC	103
FCC/IC Notice	104
Thrane IP Handset, wired	106
CE (R&TTE)	106
FCC	106
Glossary	109
Index	113

Introduction

Welcome

Congratulations on the purchase of your IP Handset!

The IP Handset communicates using Voice over Internet Protocol (VoIP), which means that voice conversations are routed over the Internet or through an IP-based network.

There are two variants of the IP handset: A wireless and a wired variant.

In this chapter

This chapter introduces the IP Handset and gives an overview of its features and functions.

Your IP Handset

Description

The IP Handset is used for making phone calls over an IP based network. When used with a BGAN terminal, the communication is only IP based between the handset and the BGAN terminal. From the BGAN terminal, the call is transmitted as a normal circuit-switched call.

The handset is designed specifically for use in harsh environments and it is dust proof and splash proof.

Excellent sound quality is achieved by including a state-of-the-art echo canceller and noise suppression software.

On the large 2.2" color TFT screen, a graphical user interface provides easy access to all functions including contacts and settings. The user interface also provides direct access to certain features of a connected BGAN terminal.

The handset is based on a 260 MHz processor running Windows CE 6.0.

There are two variants of the handset: A wireless (Wi-Fi) model and a wired model.



The wireless IP handset

The wireless IP handset connects to a Wi-Fi access point. The internal battery is charged from the dedicated cradle, which connects to an external power supply (12-24 V DC).

The TT-3670B Thrane IP Handset & Cradle, wireless, includes the following main units:

- TT-3672B Thrane IP Handset, wireless
- TT-3674B Thrane IP cradle, wireless



The wired IP handset

The wired handset is powered directly from the LAN interface using Power over Ethernet (PoE), which eliminates the need for an external power supply.

The TT-3670A Thrane IP Handset, wired, includes the following main units:

- TT-3672A Thrane IP Handset, wired
- TT-3674A Thrane IP cradle, wired

The IP Handset connects to the cradle with a coil cord. The cradle connects with a fixed LAN cable to a LAN port with PoE, for example in a BGAN terminal (Broadband Global Area Network) for satellite communication.



Features

The IP Handset offers the following features:

- Voice communication over Internet or IP based network
- Contacts list with up to 100 entries
- Intuitive user interface and menu system
- Built-in web interface
- High quality color display QVGA
- Rugged but elegant design
- Splash proof and dust proof
- Connectivity to Broadband Global Area Network (BGAN) terminal
- Dedicated menu for BGAN terminals

What's next?

This chapter has provided an overview of the IP Handset.

The next chapters will go into more detail about how to set up and use your handset. The following chapter, *Getting started*, explains how to start up the handset and make the first call.

Getting started

In this chapter

This chapter describes how to install and start up the handset and make the first call. It also gives an overview of the display and keypad and explains how to navigate with the keypad.

Getting started with the wireless IP Handset

Introduction

Overview

The wireless IP handset connects to a Wi-Fi access point. The internal battery is charged from the dedicated cradle, which connects to an external power supply.

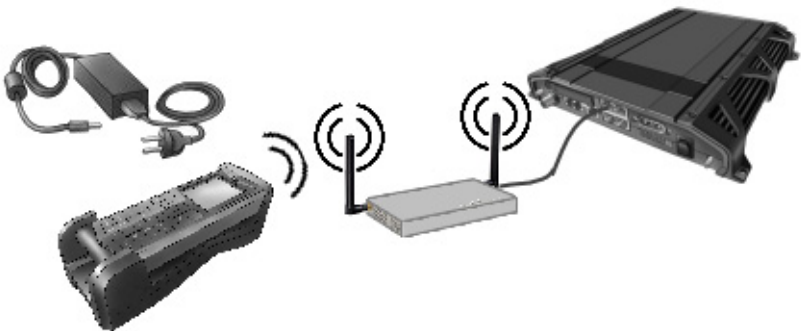

IP Handset connectors

The handset has two connectors on the side of the handset:

- one connector for connecting a headset.
- one Mini-USB connector, for charging the handset from a computer.

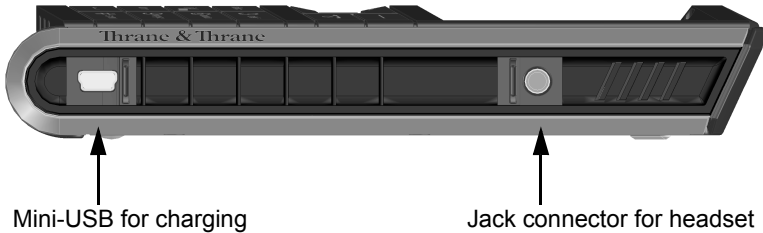

Preparing the hardware

Overview

For the wireless IP Handset you need the following hardware:

- a Wi-Fi access point complying to the Wi-Fi networking standard 802.11b/g
- for charging the handset:
 - an external power supply with 12 V DC to 24 V DC nominal power, min. 7 W, **or**
 - a PC and a USB cable with a mini-USB connector at one end and a USB-A connector at the other end.

To connect the Wi-Fi access point

You may connect the Wi-Fi access point to a BGAN terminal or to your standard network connection.

For information on how to install the Wi-Fi access point, refer to the documentation that comes with your Wi-Fi access point.

To connect the external power supply to the cradle

The cradle for the IP Handset serves as a charger when it is connected to an external power supply (12-24 V DC, 6W).

A compatible power supply, TT-3682L, is available from Thrane & Thrane. This power supply is also used for the EXPLORER 500 BGAN terminal.

To connect the power supply, do as follows:

1. On the back of the cradle, unscrew the two screws holding the cover.
2. Remove the cover.

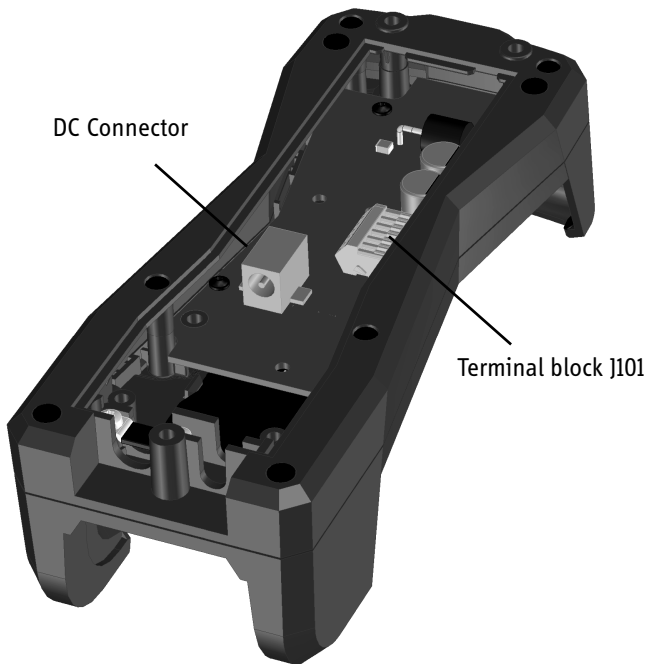

3. Connect your power supply to the cradle.

There are two options for connecting to the cradle:

- Using the internal DC connector in the cradle.
The connector is a proprietary DC Jack, 2.5 mm, positive center.

The connector on the EXPLORER 500 power supply is compatible with this connector.

- Using the internal terminal block (J101).
Connect the wires from your DC supply to DC+ and DC- in the terminal block J101.

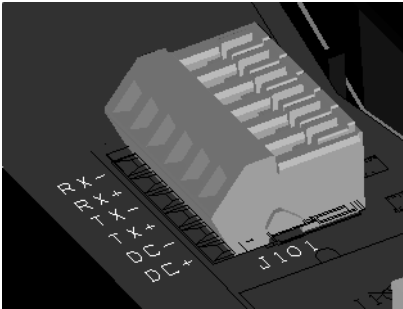

4. Secure the cable with a cable relief at the cable exit on the cradle.

Note

Make sure the cable relief matches the size of the cable.

5. Mount the cover and fasten the two screws.

For information on how to mount the cradle on a wall or desktop, see *Installing the cradle* on page 18.

Charging the handset

Introduction

The battery icon next to the handset icon in the top right corner of the display shows the battery status of the handset.



When only one bar is left in the icon, it starts flashing to indicate that the battery needs recharging. When the level is critically low, the handset makes a sound and briefly shows a message.

There are two options for charging the handset:

- using a USB cable and a computer
- using the cradle with a power supply

To charge the handset from a computer

You need a PC and a USB cable with a mini-USB connector at one end and a USB-A connector at the other end.

Do as follows:

1. Connect the mini-USB connector to the connector at the side of your handset.
2. Connect the other connector on the cable to a USB port on your computer.

The handset automatically starts the charging process.

To charge the handset using the cradle

Do as follows:

1. Connect the power supply of the cradle to your 100-240 V AC electrical outlet. For information on how to connect the power supply to the cradle, see *To connect the external power supply to the cradle* on page 9.

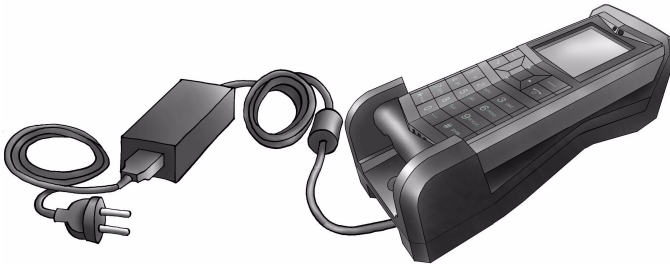

2. Place the IP Handset in the cradle with the display facing up.

Display during charging process

A message appears briefly in the display, and the battery icon is animated to show that the battery is charging.

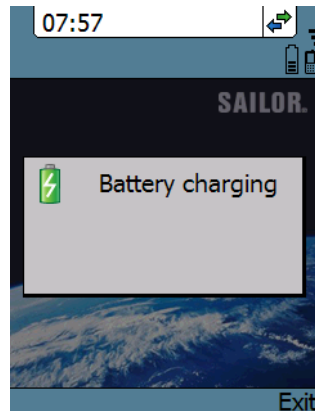

Below are examples of the display when the handset is off and when the handset is in screensaver mode while charging the battery.

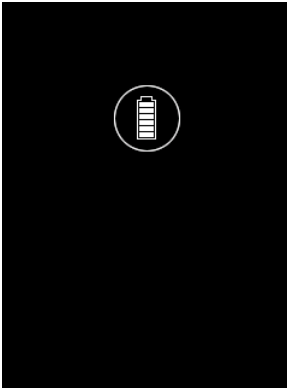

Handset off (animated).
The icon is turned off after a while, but reappears when a key is pressed.

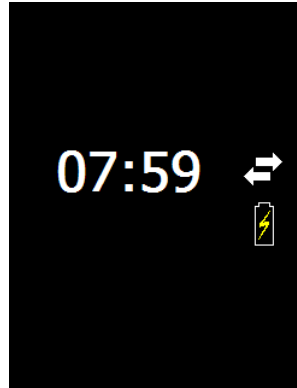

Screensaver mode

Note

If the handset is out of use for a longer period of time, recharge the battery every two years.

Connecting the handset to your Wi-Fi access point

Note

This procedure is only needed at the first connection. Once connected, the handset will automatically attempt to connect to this access point whenever it is switched on.

Do as follows:

1. Start up the Wi-Fi access point.
2. Switch on your wireless IP Handset by pressing and holding the on hook key  until the display lights up.
3. Press the center select key to enter the menu system.
4. Select **Network > WLAN**.
5. When the list of available access points appears in the display, select the access point you want to connect to.

Note

Access points with a profile matching your IP Handset are marked with . If this symbol is not present, you cannot connect to the access point until you have set up your WLAN profile to match the access point. If you select an access point without a defined profile you are prompted for security settings.

6. If you are prompted for security settings, select **OK** to enter the **Profiles** menu.
7. In the Profiles menu, select the encryption used in your access point. The handset supports WEP and WPA2-PSK.
8. Select whether your encryption code is hexadecimal or text.
9. Enter your encryption code.
10. Select **Connect**.

The handset will now attempt to connect to your Wi-Fi access point. If the access point is connected to a BGAN terminal, see *Establishing a connection using BGAN terminal* on page 21.

When the handset is ready for use, you will see the handset ready symbol  in the top right corner of the display.

Getting started with the wired IP Handset

Introduction

The wired IP Handset connects to the cradle with a coil cord. The cradle connects with a fixed LAN cable to a LAN port with PoE, for example in a BGAN terminal. The IP Handset is powered directly from the LAN (PoE) interface.

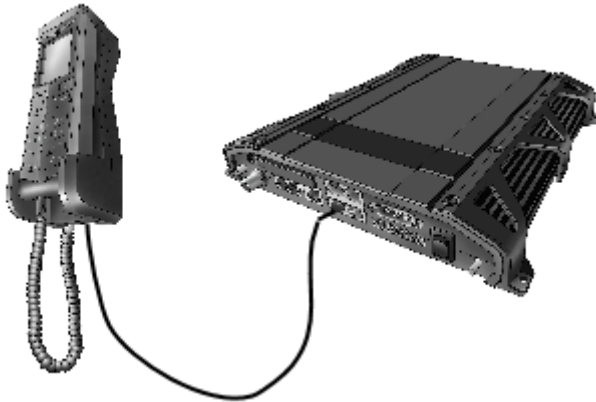

Connectors

IP Handset connectors

The IP Handset has a coil cord with a LAN connector for connecting to the cradle or directly to a LAN (PoE) interface.

The handset also has two connectors on the side of the handset, **for future use**:

- one connector for connecting a headset.
- one Mini-USB connector.

Note

These two connectors are currently not functional.

IP cradle connectors

The cradle for the IP handset has two internal LAN connectors and an alternative terminal block for the LAN connection:

- One LAN connector connects to the coil cord from the IP Handset.
- The other LAN connector, or alternatively the terminal block, connects to your LAN cable between the cradle and the BGAN terminal.

Connecting the cables to the IP cradle

Do as follows:

1. Remove the two screws holding the center cover in the bottom of the cradle and take off the cover.

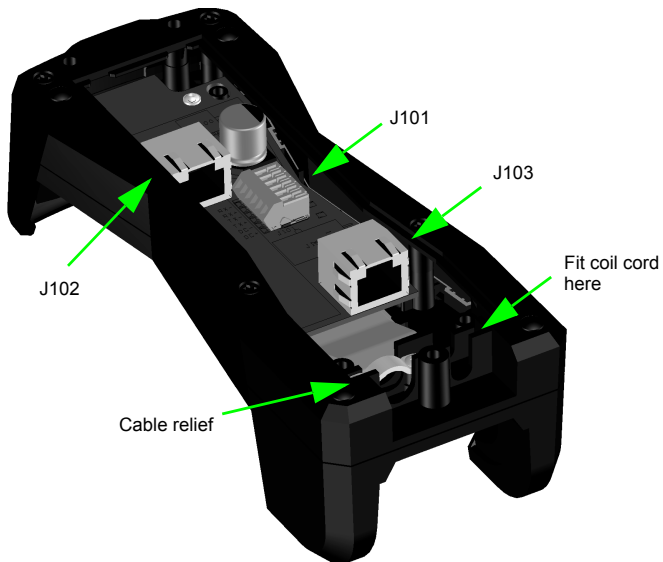

2. Connect the coil cord from the IP Handset to the cradle connector marked J103. Then fit the cable relief mounted on the coil cord into the groove at the cradle exit.
3. To mount the external LAN cable, do one of the following:

- Connect a standard LAN cable to the connector marked J102 in the cradle. This is the cable for connecting to the BGAN terminal or other LAN (PoE) interface.

Important

The space between the cable LAN connector and the PCB is very scarce - make sure the housing of the cable connector is not too thick to allow for the connectors to fit properly.

- Connect the wires of a LAN cable to the terminal block marked J101. The text next to the terminal block indicates which signal goes where.
4. Mount cable relief at the cable exit from the cradle.

Note

Make sure the cable relief matches the size of the cable.

5. Mount the cover and fasten the two screws.

Installing the cradle

Mount the cradle on a wall or a desktop with 3 screws fitting in the holes indicated in the drawing below (front view).

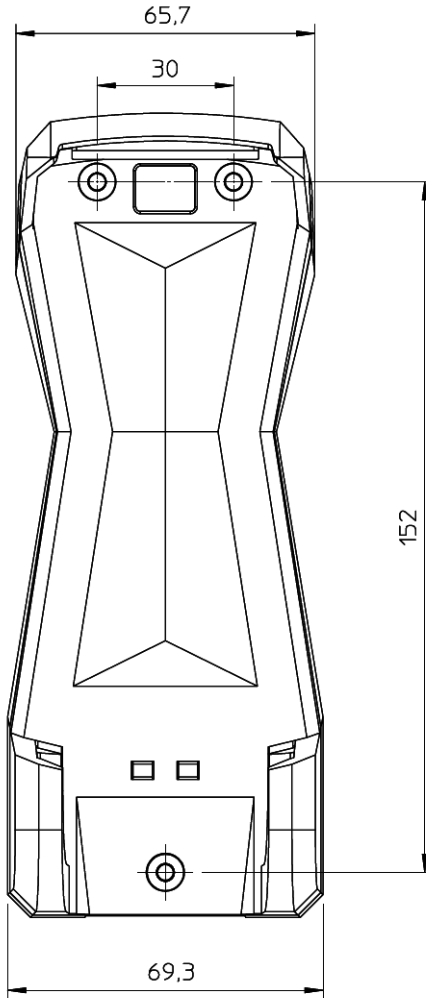

Connecting the wired handset to a BGAN terminal

Note | The LAN interface on the BGAN terminal must supply Power over Ethernet.

Do as follows:

1. Start up the BGAN terminal as described in the user manual for the terminal.
2. Connect the LAN cable from the IP cradle to one of the LAN (PoE) connectors on the BGAN terminal.

The cable between cradle and terminal must be maximum 80 m.

Note | If you insert a switch or similar between the cradle and the terminal, make sure that it conforms to the industry standard **IEEE 802.3 af (using data pairs)**.

The handset starts up automatically when connected to the BGAN terminal. However, you may have to configure user name and password if the handset has not been connected before. For further information, see *Establishing a connection using BGAN terminal* on page 21.

Starting up the wired IP Handset

Powering the IP Handset

The wired IP Handset is automatically powered when it is connected to a LAN interface with PoE.

If the handset has been switched off, you can switch it back on by pressing and holding the on hook key until the display lights up.



If the handset does not start up, the reason may be that there is no PoE in the LAN interface. If you are connecting to a BGAN terminal, check that the PoE indicator on the terminal lights green for the connected port. For further information, refer to the installation manual for the BGAN terminal.

To switch off the IP Handset, press and hold the on hook key again until the display is turned off.

Establishing a connection using BGAN terminal

Using a BGAN terminal

Introduction

By connecting the handset to a BGAN terminal you gain access to the BGAN satellite network with your IP Handset.

When the IP Handset is used with the BGAN terminal, it communicates using Internet protocol between the handset and the terminal. However, on the BGAN network side of the terminal the call is transmitted as a circuit switched 3.1 kHz or Standard call.

When connected with the BGAN terminal the IP Handset provides a dedicated menu for the terminal.

Hardware connection

The wireless handset is connected to the BGAN terminal by connecting the Wi-Fi access point to one of the LAN ports of the terminal. For information on how to connect the handset to the access point, see *Connecting the handset to your Wi-Fi access point* on page 14.

The wired handset is connected to the BGAN terminal by connecting the Ethernet cable from the cradle to one of the LAN ports of the terminal. For further information, see *Connecting the wired handset to a BGAN terminal* on page 19.

Establishing a connection

If no SIM PIN is required

If the handset is connected to a BGAN terminal where the SIM PIN is disabled or has already been entered, the BGAN terminal automatically sets up a SIP profile and assigns the local number 0501 to the first handset that is connected.

If one or more handsets have already been connected to the terminal, and the new handset has not been connected to the terminal before, you need to set up the user name, password and local number in the handset and in the web interface of the BGAN terminal. For further information, see *Connecting subsequent handsets to the BGAN terminal* on page 24.

When the display shows the handset ready symbol  in the upper right corner, the handset is ready for making a call.

If the handset ready symbol is crossed out  you cannot make a call. The display will normally show a message explaining why the handset is not ready.

If a SIM PIN is required

If the handset is connected to a BGAN terminal where the SIM PIN is required and has not yet been entered, you need to enter the SIM PIN for the terminal. To do so, you need to know the Administrator user name and password as well as the SIM PIN for the BGAN terminal. Do as follows:

1. From the main screen of the handset, press the center select key to enter the menu system.
2. Select **BGAN**.
3. Select **Enter PIN code**.

Note

This menu item is not available if the PIN has already been accepted. Select **Status > PIN status** to see if the PIN has been accepted.

4. Enter the Administrator user name and select **OK**.

For information on how to type text in the handset, see *Writing text in the handset* on page 47.

5. Enter the Administrator password and select **OK**.
6. Enter the SIM PIN and select **OK**.

If the SIM PIN is rejected, see the next section *Wrong PIN*.

When the PIN is accepted, the BGAN terminal automatically sets up a SIP profile and assigns the local number 0501 to the first handset that is connected.

If one or more handsets have already been connected to the terminal, and the new handset has not been connected to the terminal before, you need to set up the user name, password and local number in the handset and in the web interface of the BGAN terminal. For further information, see *Connecting subsequent handsets to the BGAN terminal* on page 24.

When the display shows the handset ready symbol  in the upper right corner, the handset is ready for making a call.

If the handset ready symbol is crossed out  you cannot make a call. The display will normally show a message explaining why the handset is not ready.

Wrong PIN

After entering the user name and password, you have 3 attempts to enter the PIN, before you are asked to enter the PUK (Pin Unblocking Key). The PUK is supplied with your BGAN SIM card.

Enter the PUK followed by a new PIN of your own choice. The PIN must be from 4 to 8 digits long.

**Caution!**

If you enter a wrong PUK 10 times, the SIM card will no longer be functional, and you have to contact your Airtime Provider for a new SIM card.

Connecting subsequent handsets to the BGAN terminal

Introduction

If one or more handsets have already been connected to the terminal, you need to set up the user name, password and local number in the handset and in the web interface of the BGAN terminal.

Setting up the handset

To enter the user name and password in the handset, do as follows:

1. Start up your handset as described in the previous sections.
2. Enter the menu system and select **SIP**.
3. Move to the BGAN profile and select **Options** (left select key).
4. Select **Edit/View**.
5. Select **User name** and enter the user name for your handset. Note that the user name must be the same as the local number for your handset when using the BGAN terminal. Available numbers are 0501 to 0516.
6. Select **Password** and enter the password for your handset.
7. Exit the handset menu system.

Setting up the BGAN terminal

To enter the local number and password in the web interface of the BGAN terminal, do as follows:

1. Connect a computer to the LAN interface of the BGAN terminal and start up your browser.
2. Enter the IP address for the terminal. The default IP address is 192.168.0.1. The web interface opens.
3. Select **SETTINGS > IP handsets**.

4. Locate the local number that matches the user name of your handset and click **New**.
5. Enter the password you entered in the handset.
When the terminal and the handset have recognized each other, a “Configure” link appears next to the new handset. When you click the Configure link the internal web interface of the handset opens. For information on the handset web interface, see *Using the web server* on page 75.

Handset ready

When the display shows the handset ready symbol  in the upper right corner, the handset is ready for making a call.

If the handset ready symbol is crossed out  you cannot make a call. The display will normally show a message explaining why the handset is not ready.

Making the first call

To make a call, type the phone number on the keypad and press the off hook key in the left side of the keypad  or press #.

The display shows that the number is being dialled.

If the number is in the Contacts list of the handset, you can also select the number from there and dial up with the off hook key.

For further information on how to make calls, see *Making calls* on page 40.

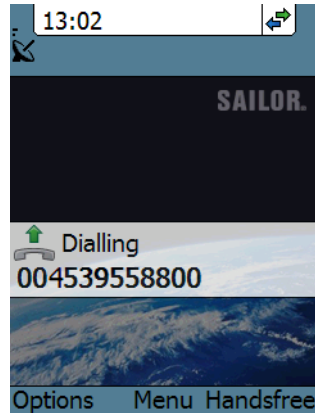

Unanswered calls

You can see unanswered calls under **CALLS** in the BGAN menu of the IP handset or under **Calls** in the web interface.

The handset keypad and display

The keypad

Overview



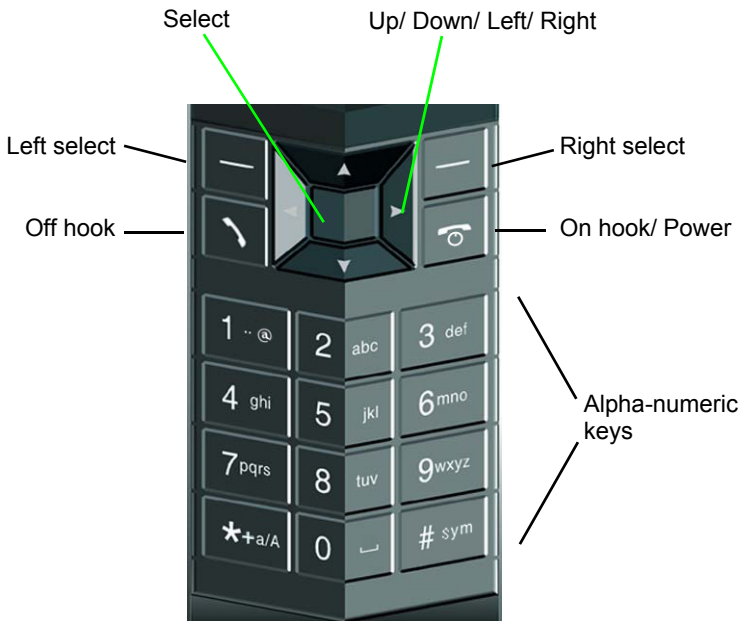

The following drawing shows the keypad of the handset.



The next sections explain the functions of each key in the keypad.

Control keys

The below table shows the functions of the control keys in the upper section of the keypad.

Key	Functions
	<p>Left select.</p> <p>Selects the function shown just above the key (left soft key).</p>
	<p>Right select.</p> <p>Selects the function shown just above the key (right soft key).</p> <p>From main screen: Opens the Contacts list.</p>
	<p>Off hook.</p> <p>After entering a phone number: Initiates a call to the number.</p> <p>From main screen: Opens a list of the latest calls, including incoming, outgoing and missed calls.</p>
	<p>On hook/ Power.</p> <p>When the handset is ringing: Rejects the call.</p> <p>During a call: Ends the call.</p> <p>When in the menu system: Abandons the menu system and displays the main screen.</p> <p>Otherwise: Powers the handset on/off, when pressed and held for 3 seconds.</p> <p>If there is an error and the handset does not power off after approximately 3 seconds, hold the key for 10 seconds, and the handset will perform a hardware reset.</p>

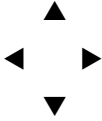
Key	Functions
	<p>Select (center).</p> <p>Selects/confirms the function highlighted in the display.</p>
	<p>Navigation.</p> <p>Navigates through the menu system in the display.</p> <p>Right/Left are also used to change settings in the menus.</p> <p>See also <i>Keypad shortcuts</i> on page 32.</p>

Alpha-numeric keys

This section shows the functions of the alpha-numeric keys in the lower section of the keypad.



The functions available depend on whether you are typing a phone number (number mode) or text (text mode).

In number mode, you get the number of the key pressed. Only * has two functions.

Press * once: The display shows * .

Press * twice, or press and hold: The display shows +.

Press #: The display shows #.

See the available functions in text mode on the next page.

In text mode, you have the functions listed below.

The * key switches between numeric, lowercase and uppercase characters.

To get numbers from lowercase or uppercase mode, press and hold the key.

At numerous presses on the same key, the character changes in the same sequence that the characters are listed in the table below.

Key	Numeric output	Lowercase output	Uppercase output
1	1	. , @ : - ?	. , @ : - ?
2	2	a b c	A B C
3	3	d e f	D E F
4	4	g h i	G H I
5	5	j k l	J K L
6	6	m n o	M N O
7	7	p q r s	P Q R S
8	8	t u v	T U V
9	9	w x y z	W X Y Z
0	0	[space]	[space]
*	Switches between lowercase, uppercase and numbers		
#	Symbols. Displays a list with the following additional symbols: . / : @ \$ % ^ & * () ~ \ - _ = + [] { } \ ; ' " ! < > , ? # € <CR>		

Navigating with the keypad

To enter the menu system from the main screen, press the center select key.

To move through the menus, press the navigation keys (arrows).





To select a highlighted menu item, press the center select key.

To select one of the items in the action texts area, press the key just below the text you want to select.

To go back one level in the current menu, press the right select key (only when **Back** is displayed above the key).

Keypad shortcuts

The following shortcuts are available:

	When the display is in the main screen, this key gives direct access to the list of contacts.
	When the display is in the main screen, this key opens a list of the latest incoming, outgoing and missed calls.
	When the display is in the menu system, the on hook key will exit the menu system and show the main screen.
	When the display is in the main screen, the right select key will open the list of contacts. From inside the Contacts list, press the first letter of an entry to access the entry in the Contacts list.
Alpha-numeric keys	When the display is in the menu system, an alpha-numeric key will jump to the menu item with the pressed number or, in the Contacts list, to the first entry beginning with the pressed letter.

The display

Overview

The color display of the IP Handset is divided into sections with different information. The sections are outlined below.

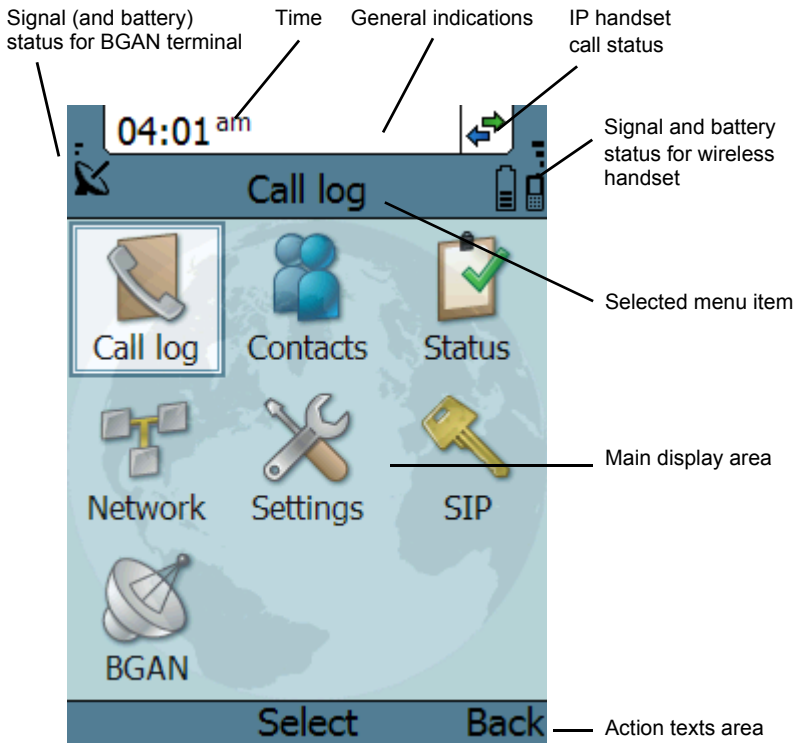

BGAN signal and battery status

When the IP Handset is connected to a BGAN terminal, the display shows the signal strength of the BGAN signal. If the BGAN terminal is battery powered, the battery status is also displayed.

Time

The display shows the time of day.

The format is selectable in the **Settings > Date and time** menu.

General indications

General indications are icons that show dynamic information such as missed calls, sounds off, keypad locked and microphone muted.

For explanations of the icons, see *Icons in the display* on page 35.

IP Handset call status

This field shows handset status such as whether or not the handset is ready for making calls, or whether there is an ongoing call.

For explanations of the icons, see *Icons in the display* on page 35.

Signal and battery status for wireless IP Handset

This field shows the signal strength for the wireless connection and battery status for the wireless handset.

Main display area









The main display area primarily displays the menus and messages to the user.









Action texts area





The action texts are used to indicate an action that takes place when the corresponding key is pressed. The corresponding key is the key directly below the text (left select, center select or right select).

Icons in the display

The below table explains the icons in your display.

Icon	Meaning
	Signal strength for wireless handset and/or for BGAN terminal.
	Battery status for wireless handset and/or for BGAN terminal.
	BGAN terminal connected (used together with signal strength and battery status if relevant).
	Wireless handset (used together with signal strength and battery status).
	The handset is ready for making calls.
	The handset is not ready for making calls.
	Incoming call - not yet answered (the handset is ringing).
	Incoming call in progress.
	Outgoing call in progress.

Icon	Meaning
	<p>Outgoing call - not yet answered.</p>
	<p>Call ended.</p>
	<p>The microphone is muted. To reactivate the microphone, select Options (left select key) > Microphone.</p>
	<p>The keypad is locked. To unlock the keypad, press the center select key followed by the left select key.</p>
	<p>Missed call. See the Call log for information on the call.</p>
	<p>Shown in the list of WLAN access points: The Wi-Fi connection is encrypted.</p>
	<p>Shown in the list of WLAN access points: The Wi-Fi connection is not encrypted.</p>
	<p>Shown in the list of WLAN access points: The profile for the Wi-Fi access point matches the handset.</p>
	<p>This symbol is used in the Contacts list to indicate that the number is from the phone book of the BGAN terminal and is read-only.</p>

Icon	Meaning
	When an alpha-numeric key is pressed from inside the Contacts list, this symbol is shown while the handset is searching for entries with the letter pressed.
	The handset is in silent mode. All external sounds from the handset - including ring tones - are muted. Voice is not muted.
	This symbol is shown when you are adjusting the volume.
	Wait - a task is in progress.

Screensaver

You can choose to have a screensaver activated when the handset is not used for 1 minute. This screen shows only the time, handset status and general indications such as missed calls.

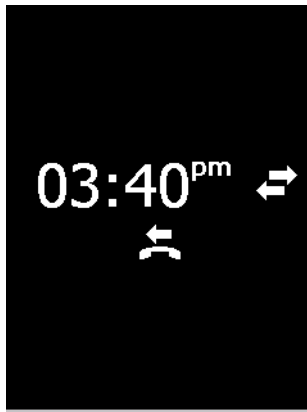

When you press a key the display returns to the normal display function.

To enable or disable the screensaver, enter the menu system, select **Settings > Display** and select **Screensaver**. When the box is checked, the screensaver is enabled.

What's next?

After reading this chapter you should be able to connect the IP Handset, start up and make a call.

The next chapters provide more information on the user interfaces and the setup of the IP Handset. The following chapter, *Operating the IP Handset*, explains how to setup and use the IP Handset.

Operating the IP Handset

In this chapter

This chapter describes how to use the IP Handset. It also describes how to configure the handset and use the display menu system, including a short description of how to use the IP Handset with a BGAN terminal.

For information on how to connect and start up the handset, and how to navigate with the keypad, refer to the previous chapter, *Getting started*.

User interfaces

The main user interface for the handset is the display menu system. However, with a computer and a browser you can also use the built-in **web server** to access the handset. This way you can take advantage of a larger screen and still access a subset of the handset settings.

- **The display menu system** is described in *The menu system* on page 49. For an overview of the keys and display, and explanation of keys and display symbols, see *The handset keypad and display* on page 27.
- **The web server** is described in *Using the web server* on page 75.

Handset functions

Making calls

Handset ready

When the status field for the IP Handset shows ready  , you can make or receive calls.

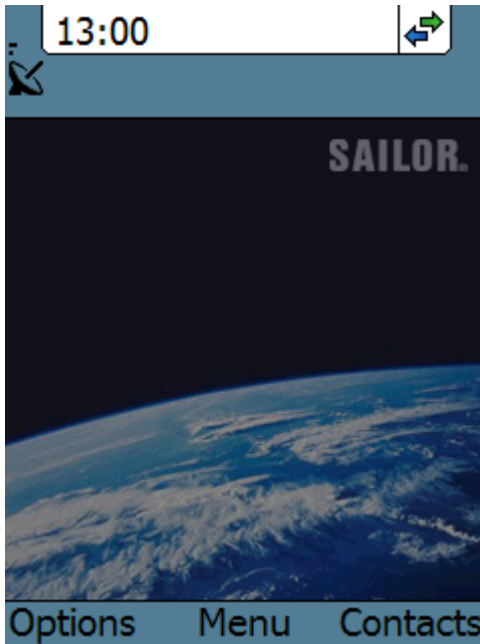

To make a call

To make a call, simply type the phone number and press **[Call]** or **#**.



Note

If the handset is in the cradle while you make the call, the mode will automatically be hands-free (default function). For further information, see *Cradle* on page 64.

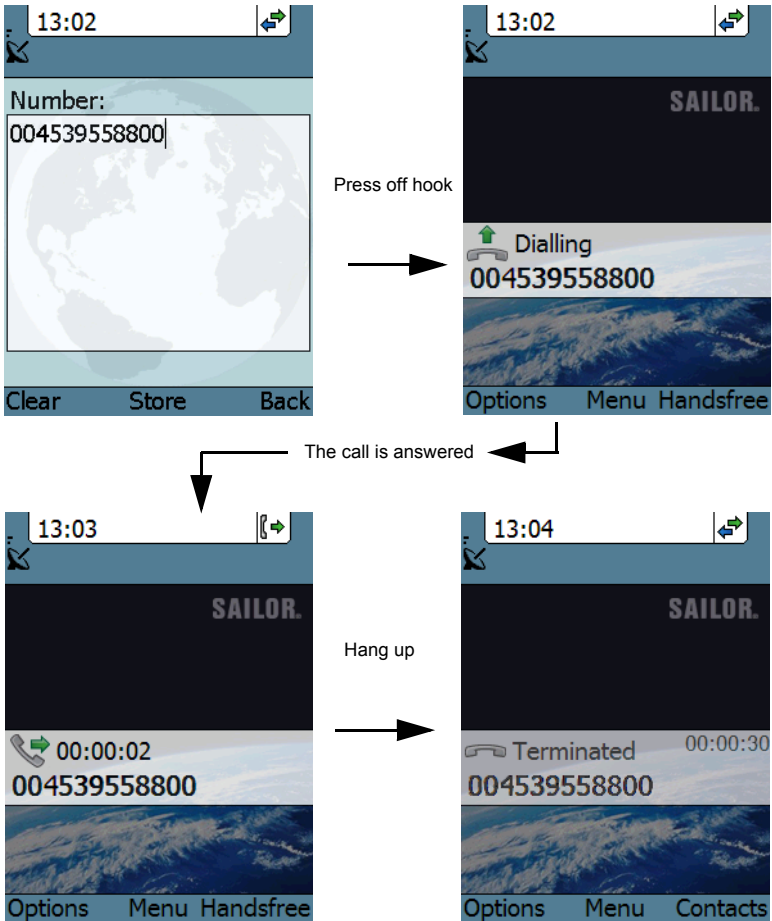
The display shows the progress as follows:



You can also call a number from your contacts or from a list of recent calls:

- **Contacts:** Press the right select key from the main screen and move to the contact you want to call. Then press the off hook key.
- **Recent calls:** To see the latest calls (incoming, outgoing and missed calls), press  from the main screen. Press  again to call the selected number.

For information on how to make calls using a BGAN terminal, see *Making a call using a BGAN terminal* on page 43.

To receive a call

When the handset is ringing, the display shows the calling name or number, if known.

Answer the call by pressing the off hook key in the left side of the keypad , or by removing the handset from the cradle. For information on cradle detection, see *Cradle* on page 64.

Note

If the handset is in the cradle while you answer the call, the mode will automatically be hands-free (by default).

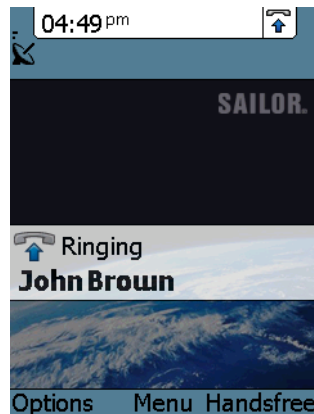

Any open menus are closed down when the handset is ringing.

To end or reject a call

Press the on hook key  to end an ongoing call or to reject an incoming call.

When the handset is in hand-held mode, you can also end the call by placing the handset in the cradle.

Making a call using a BGAN terminal

Making a call from a handset connected to a BGAN terminal

To make a call from a phone or handset connected to a BGAN terminal, dial

00 <country code> <phone number> followed by  or #.

Example: To call Thrane & Thrane in Denmark (+45 39558800), dial **00 45 39558800** followed by  or #.

Note

You can select the call type for your call, using a prefix. The default call type is Standard Voice.

Dial **2 *** before the number to make a 3.1 kHz Audio call.

Example: Dial **2 * 004539558800** to make a 3.1 kHz Audio call to Thrane & Thrane in Denmark.

For further information on call types and the BGAN terminal, refer to the user manual for your BGAN terminal.

Making a call to a handset connected to a BGAN terminal

Note

By default all handsets connected to the terminal will ring on incoming calls.

To make a call to a handset connected to the terminal, dial

+870 <Mobile number>

- **+** is the prefix used in front of the country code for international calls. This is **00** when calling from most countries in Europe and from many other countries.
- **Mobile number:** The mobile number of the terminal you are calling.

Example: If you are calling from Denmark and the mobile number for 3.1 kHz Audio is 772112345 on your terminal, and you want to make a call to the terminal using 3.1 kHz Audio, dial **00 870 772112345**.

To see the mobile numbers of your terminal, refer to the information included with your airtime subscription.

Note

There are two Voice numbers, one for 3.1 kHz Audio and one for Standard Voice.

For more information on call types and the BGAN terminal, refer to the user manual for your BGAN terminal.

Quick settings

Controlling the volume

To adjust the voice volume during a call (with the display in the main screen), press ▲ or ▼ on the keypad.

Hands-free operation

To enable hands-free operation during a call, use the right select key to select **Handsfree**. To go back to hand-held mode, press the right select key again.

In hands-free mode the sound is routed to a speaker, so that you can use the phone without holding it close to the ear. You can adjust the volume with ▲ or ▼ as described in the previous section.

Handset in cradle:

You can also make a hands-free call by leaving the handset in the cradle while making the call. Similarly you can answer a call using hands-free mode by leaving the handset in the cradle while answering the call.

In both cases, the default function is as follows:

- If you remove the handset from the cradle during the call, the mode will automatically change to hand-held.
- When the handset is out of the cradle in **hand-held** mode, the call will be terminated when you put the handset back in the cradle.
- When the handset is out of the cradle in **hands-free** mode, you can put it back in the cradle without terminating the call.

Note

You can change this default function under **Settings > Cradle**, if you want the handset to be independent of the cradle. For further information, see *Cradle* on page 64.

Muting the microphone

To mute the microphone during a call, select the left **Options** menu and select **Microphone mute**.

Locking the keypad

To lock the keypad, select the left **Options** menu and select **Lock keypad**.

When the keypad is locked you can still answer incoming calls.

To unlock the keypad, press the center select key and then the left select key.

Using night mode

The display has a night mode for operation in low light areas. In night mode, the colors are changed to make the display more suitable for night operation.

To activate night mode, select the left **Options** menu and select **Night mode**.



Using stealth mode

The display has a stealth mode which turns off all lights and/or sounds for external events. Note, however, that the keypad will still light up when you press a key.

To activate stealth mode, select the left **Options** menu and select **Stealth mode**.

Note

Stealth mode is only activated for the items you have selected in the Stealth mode menu. See *Stealth* on page 62.

Writing text in the handset

How to use the keys

Press * before the alpha-numeric key to switch between lower case, upper case and numbers.

There are 3 or 4 letters on each key. To obtain the other letters on the key, press the key again.

To move the cursor in the text, use the arrow keys.

To delete the letter just before the cursor, press the left select key **Clear**. Hold the key to delete all the text.

For a list of the key-functions in text-mode, see the table on page 31.

Example

To type “He”, do as follows:

1. Press * one or two times until the lower left corner of the display shows upper case letters.
2. Press the key **4 ghi** two times to display the letter **H**.
3. Press * again until the lower left corner of the display shows lower case letters.
4. Press the key **3 def** two times to display the letter **e**.

Using a headset

You can connect a headset to the handset as follows:

Plug the headset jack into the jack connector on the side of the handset.

The microphone and speaker of the handset are automatically disabled and the headset is used instead.

The menu system

Accessing the menu system

To access the menu system from the main screen, press the center select key.

Move around in the menus with the arrow keys and select with the select keys.

Leave the menu system by pressing the on hook key.

Menu overview

The following drawing shows an overview of the menu system.

Note | The WLAN menu under Network is not present in the wired handset!

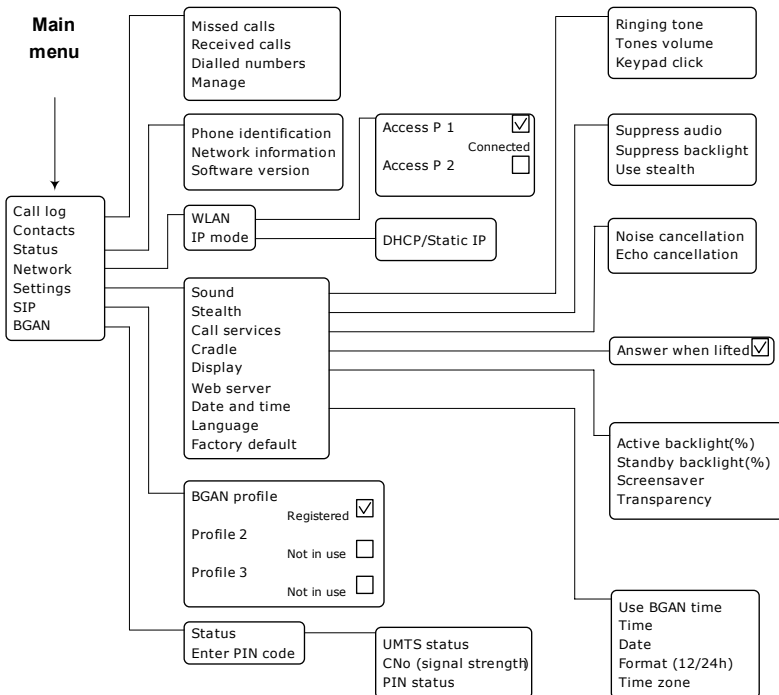

Call log

To see the call log

Note that the call log can hold maximum 100 calls. You can delete calls from the call log. For further information, see the next pages in this section.

Do as follows:

1. From the main menu, select **Call log**.
2. Select the list you want to see.
3. If you want to see details for a call, move to the call and select **View**.
The display shows the name (if known), the number, time of the call and duration.

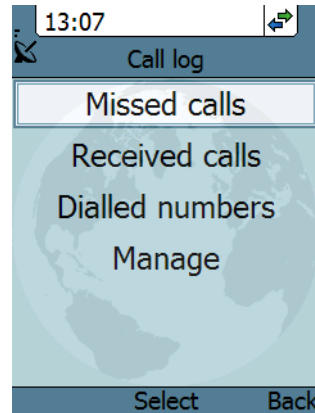

To add a number from the call log to the Contacts

Do as follows:

1. In the call log, go to the call and select **Options**.
2. Select **Add to contacts**.
Note that the Contacts list can hold maximum 100 entries.
3. Type in the name of your new contact and select **OK**.

To delete a number from the call log

Do as follows:

1. In the call log, go to the call and select **Options**.
2. Select **Delete**.
3. Select **Yes**.

To delete all numbers in a call log folder

Do as follows to delete all numbers in the call log, or all numbers in a subfolder of the call log.

1. In the call log menu (not in one of the subfolders) select **Manage**.
2. Select the folder you want to empty.
3. Select **Yes**.

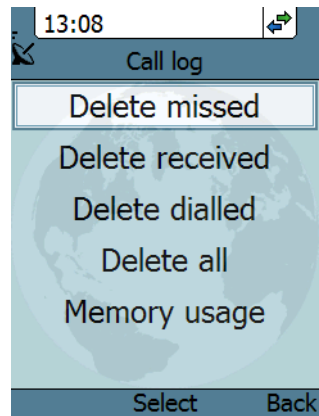

To see memory usage in the call log

To see the number of stored entries and the maximum allowed number of entries, do as follows:

1. In the call log menu (not in one of the subfolders) select **Manage**.
2. Select **Memory usage**.

Contacts

To see your contacts

Do one of the following:

- From the main screen, press the right select key,
- from the main screen, press ▼, or
- from the main menu, select **Contacts**.

If a contact is from the BGAN phone book it is marked with . This means you cannot edit or delete the entry.

To call a contact

Do as follows:

1. In your Contacts list, scroll to the contact you want to call.
2. Press the off hook key.

To add a contact

Do as follows:

1. In your Contacts list, press the left select key, **Options**.
2. Select **Add**.
Note that the Contacts list can hold maximum 100 entries.

3. Type in the name of your contact and select **OK**.
The name can be maximum 32 characters.
For information on how to enter text, see *Writing text in the handset* on page 47.

4. Scroll to **Number** and select **Edit**.
5. Type in the number of your contact and select **OK**.
The number can be maximum 32 characters.

To edit a contact

Do as follows:

1. In your Contacts list, scroll to the contact you want to edit.
2. Press the left select key, **Options**.
3. Select **View/Edit**.
4. Select **Edit**.
5. Change the name of your contact and select **OK**.
For information on how to enter text, see *Writing text in the handset* on page 47.
6. Scroll to **Number** and select **Edit**.
7. Change the number of your contact and select **OK**.

To delete a contact

Do as follows:

1. In your Contacts list, scroll to the contact you want to delete.
2. Press the left select key, **Options**.
3. Select **Delete**.
4. Press the left select key, **Yes**.

The contact is now deleted from your Contacts list.

Status

To view status for the handset, do as follows:

1. From the main menu, select **Status**.
2. Select **Phone identification** to see the serial number of the IP Handset.
3. Select **Network information** to see:
 - DHCP Enabled/Disabled
 - IP address
 - Subnet mask address
 - Default gateway
 - Physical address (MAC)
4. Select **Software version** to see the version of the IP Handset software.

