

SAILOR SP3560 ATEX UHF



IMPORTANT INFORMATION

Safe use of ATEX equipment:

- Do not change the battery in wet or humid environments.
- Always keep battery connectors dry and clean.
- Use only with Sailor ATEX approved accessories.
Alternatively ATEX approved accessories in compliance with the accessory connector ATEX specification may be used.
- Do not change accessories in wet or humid environments.
- Do not charge the battery in hazardous area.
- For charge of battery use
Part no: 403505A - ATEX CH3505 Compact Charger,
Part no: 403507B - ATEX CH3507 Single Position Charger or
Part no: 403508B - ATEX CH3508 Dual Position Charger
- Use only battery type Sailor B3503 or B3504.
- Do not use a mechanically damaged radio.
- Unpacking of the radio and accessories and the removal of the protective film in front of the display window must not take place in the ATEX protected area.

SP3560 ATEX UHF

Document number: TT 98-124309-B

Release date: January, 2009

Copyright: © 2009 Thrane & Thrane A/S. All rights reserved.

Trademark Acknowledgements

- **SAILOR** is a registered trademark of Thrane & Thrane A/S.
- **Other product and company names** mentioned in this manual may be trademarks or trade names of their respective owners.

Warranty limitation

IMPORTANT - The radio and batteries are sealed waterproof units. To create and maintain the waterproof integrity they were assembled in a controlled environment using special equipment. The radio and batteries are not user maintainable units, and under no circumstances should the units be opened except by authorized personnel. Unauthorized opening of the units will invalidate the warranty.

Disclaimer

Any responsibility or liability for loss or damage in connection with the use of this product and the accompanying documentation is disclaimed by Thrane & Thrane. The information in this manual is provided for information purposes only, is subject to change without notice and may contain errors or inaccuracies.

Manuals issued by Thrane & Thrane are periodically revised and updated. Anyone relying on this information should acquire the most current version e.g. from the Thrane & Thrane Extranet at: <http://extranet.thrane.com>.

Thrane & Thrane is not responsible for the content or accuracy of any translations or reproductions, in whole or in part, of this manual from any other source.

Precautions

Avoid water and salt in the I/O connector and keep it clean frequently.

Only use original Thrane & Thrane battery packs. Make sure they are clean and dry before attaching the transceiver. Be careful not to damage any gaskets.

Only use the original Thrane & Thrane charger for the rechargeable battery.

Be very careful when handling the Lithium batteries. With correct use they are safe but any misuse might cause dangerous situations.

Never short circuit the battery terminals, never expose the transceiver and the batteries to extreme temperature or fire and never use any kind of violence.

Avoid close contact between the antenna and parts of the human body. The top of the antenna must never be closer than 2.5 cm to the body when transmitting.

Do not submerge the transceiver more than 1 m for 30 minutes.

Keep the transceiver at least 0.3 m away from the magnetic compass.

Training information

SAILOR SP3560 ATEX UHF is designed for to be operated safely. It must be operated by licensed personnel only.

The SP3560 complies with the uncontrolled RF exposure limits.

- FCC OET Bulletin 65 Supplement C, evaluating compliance with FCC guidelines for human exposure to radio frequency electromagnetic fields.
- American National Standards Institute (C95.1) IEEE standard for safety levels with respect to human exposure to radio frequency electromagnetic fields, 3 kHz to 300 GHz.
- American National Standards Institute (C95.3) IEEE recommended practice for the measurement of potentially hazardous electromagnetic fields - RF and microwaves.



Warning! Your Thrane & Thrane UHF radio generates electromagnetic RF (radio frequency) energy when transmitting. To ensure that you are not exposed to excessive amounts of energy and thus to avoid health hazards from excessive exposure to RF energy, all persons must be at least 2.5 cm away from the antenna when the radio is transmitting.

Correct use

For best performance, hold the radio vertically and 5 cm away from the head when talking into the microphone.

Channel programming

Sailor SP3560 ATEX UHF always requires a license to operate.

For the U.S and Canadian market there are no channels pre-programmed into the radio when leaving the factory. The users have to apply the authority for a license and a channel allocation. The licensed channels can then only be programmed into the radio by a general agent or the manufacture by special Service tools. Users are not able to access or change any of the programmed channels.

Power settings

Power settings are adjusted at the factory. The settings for the normal "High" power and the reduced "Low" power are saved and locked in the radio and is not accessible for the user. The user is not able to change any of the preset power settings. The user can only select the preset Low power or High power by pushing a button on the keyboard.

Contents

Chapter 1 Introduction

Your ATEX UHF	1
Performance	2
Channels	2

Chapter 2 Operation

Controls	5
Keys and buttons	5
The display	7
Using the ATEX UHF	8
Basic functions	8
Other functions	11

Chapter 3 Batteries

Battery level indication	13
Removing and inserting the battery pack	13
The battery chargers	14
Installing the charger	14
Recharging the battery	15

Chapter 4 Configuring the radio

Configuration mode	17
Entering and using configuration mode	17
List of configuration settings	18

Chapter 5 Equipment and accessories

External equipment	23
List of equipment	23
Connecting external equipment	23
Impact on radio operation	24
Accessory connector	24
Accessories	25
List of accessories	25
Attaching and removing the belt clip	27
Attaching the lanyard	27

Chapter 6 Troubleshooting

Displaying errors	29
-------------------------	----

App. A Technical specifications

Technical data SP3560	31
General	31
Transmitter	32
Receiver	32
Battery life guidelines	34
Battery (rechargeable)	34
Dimensional drawing, transceiver	35
Dimensional drawing, charger	36
Declaration of Conformity	38

App. B Attention

Goretex Membran	39
------------------------------	-----------

Introduction

Your ATEX UHF

The ATEX UHF is designed for flexibility in daily use. It connects easily to external equipment like headsets and fist mikes, making the SP3560 suitable for any noisy environment.

Main features:

- Unique man machine interface, an excellent grip even with gloves, and large tactile buttons.
- Display with red adjustable backlight which makes the display visible even at night.
- Built-in “sleep” function, minimizing power consumption and improving battery lifetime.
- Selectable 12.5 kHz narrow band or 25 kHz wide band operation.
- Scrambling function for privacy calls.
- CTCSS function for selective opening of Squelch.
- A lanyard and belt clip included.

A huge accessory program comes with the SAILOR SP3500 series.

Please find the nearest SAILOR distributor on www.thrane.com.



Performance

For best performance of the transceiver keep the following in mind:

- Keep clear of metal environment.
- Hold the transceiver vertically and 5 cm from lips and push the PTT when transmitting.
- In receive mode carry the transceiver vertically with belt clips.
- To preserve battery power, adjust squelch to close the loudspeaker when there is no signal.
- If you are in a lifeboat keep the antenna as high as possible.

Channels

This radio is not programmed with any channels for USA and Canada.

The user have to apply at the authorities for a licens.

For Europe this radio can be programmed according to the following tables:

Table 1: Single frequency simplex channels (25 kHz or 12.5 kHz use)

Channel designator	Frequency
Channel A	467.525 MHz
Channel B	467.550 MHz
Channel C	467.575 MHz
Channel D	457.525 MHz
Channel E	457.550 MHz
Channel F	457.575 MHz

Table 2: Additional channels for 12.5 kHz equipment

Channel designator	Frequency
Channel M	467.5375 MHz
Channel N	467.5625 MHz
Channel O	457.5375 MHz
Channel P	457.5625 MHz

Table 3: Two-frequency simplex channels for use with repeater only

Channel designator	Repeater RX Frequency	Repeater TX Frequency
Channel G	467.525 MHz	457.525 MHz
Channel H	467.550 MHz	457.550 MHz
Channel J	467.575 MHz	457.575 MHz
Channel K	467.5375 MHz	457.5375 MHz
Channel L	467.5625 MHz	457.5625 MHz

Operation

Controls





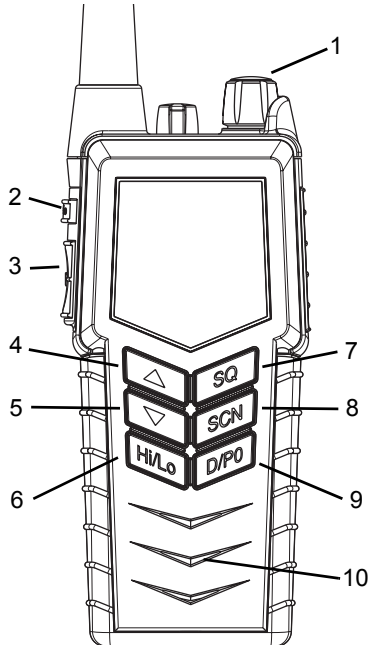

Keys and buttons

1. On/off/volume
2. Light/Lock
3. Push To Talk (PTT)
4. Up key
5. Down key
6. Hi/Lo output power
7. Squelch
8. Scan
9. D/P0 quick channel select
10. Loudspeaker/microphone



Key presses

Pressing and holding certain keys gives access to additional functions, shown in the table below.

Key	Short press (1 beep)	Long press (2 beeps)	Extra long press (3 beeps)
 	Show next available item in the list (up or down). Default: Channel selection	Run through available items, or select tagged channels P1 (▼) or P2 (▲).	Run through available items if an P1 or P2 channel is tagged
	Activate Squelch control (Adjust with up/down arrows).	Monitor function. Open Squelch completely. Set period of time in configuration mode.	
	1 press: Activate/terminate Dual watch. 2 presses: Activate memory scan.	Add/Delete channel from memory scan.	
	Toggle between high and low transmitter power.		
	Select channel D.	Select preprogrammed channel P0.	

The display

The display holds various fields of information, explained below.

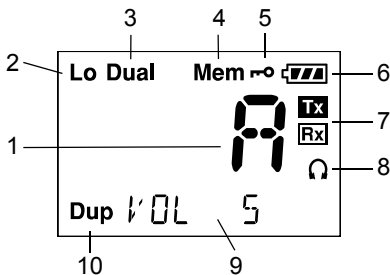

1. Current working channel.
2. “Lo”: Reduced transmitter power.
Full transmitter power is not shown in display.
3. Dual watch activated.
4. Current working channel is marked for scanning.
5. Keypad is locked.
6. Battery level indicator.
7. Transmitting (TX) /Receiving (RX).
8. Accessory is connected.
9. Service line for various purposes. In this example the volume level.
10. Semi-duplex channel.

Using the ATEX UHF

Basic functions

Note Before using the radio, mount the antenna at the top of the radio. The antenna is delivered with the radio.

Switching the radio on and off

- **To switch the radio on**, turn the knob at the top of the radio **clockwise**.
The display lights up showing the last used channel and the battery level.
- **To switch the radio off**, Turn the knob back **counter-clockwise** until it clicks.



Selecting the working channel

- To select **channel D**, press the **D/P0** key.
- To select among **all available channels**, press **▲** or **▼** on the keypad.
For fast selection, press and hold **▲** or **▼**.

The display shows the currently selected channel. The bottom left corner of the display shows “Dup” if the channel is a semi-duplex channel.

Note Long press on **▲** or **▼** can also be used to select preferred channels. For information on how to program preferred channels, see *Configuring the radio* on page 17.

Activating a call

To **activate a call** to the selected channel, press and hold the **PTT** button on the side of the radio.

The radio transmits as long as the PTT button is pressed. A small **TX** sign next to the channel number indicates when the radio is in transmit mode.



Adjusting the volume

- To **increase** the volume, turn the on/off knob at the top of the radio **clockwise**.
- To **decrease** the volume, turn the knob **counter-clockwise**.

The display shows the level of the volume, e.g. “VOL 5”, while it is adjusted.

Using Squelch control

- To **activate** Squelch control, press the **SQ** key.
- To **set** the Squelch level, press ▲ (closing) or ▼ (opening). The display shows the Squelch level while it is adjusted, e.g. “SQ 5”.

Adjusting the display backlight

- To **turn on** the backlight, press the **Light/Lock** button on the side of the radio.
- To **adjust** the backlight level, press ▲ or ▼ within 3 seconds after turning on the light. The display shows the level while it is adjusted, e.g. “DIM MED”.

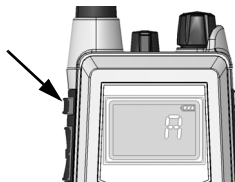

Using Dual watch (requires priority channel is programmed)

- **To activate** Dual watch, press the **SCN** key.
The display shows “Dual” at the top and “D” at the bottom right. The radio toggles between the selected channel and channel D (if channel D is programmed as the priority channel).
- **To terminate** Dual watch, press **SCN** again.

Scanning channels

- **To activate** scanning memory, press 2 times **SCN** within 1/2 a second. During scanning, the display shows “SC” in the channel field. The radio toggles between channel D and each of the channels are marked for scanning (only if a priority channel, e.g. D was programmed).
- **To terminate** scanning, press **SCN** once.

Changing the transmitter power

To change the transmitter power, press the **Hi/Lo** key. The display shows “LO” when power is set to low. Otherwise maximum power is used.

Locking the keypad

- **To lock** the keypad, press and hold the **Light/Lock** button. The display shows a key symbol when the keypad is locked.
- **To unlock** the keypad, press and hold the **Light/Lock** button again.

Other functions

Programming the scanning memory

To add a channel to the scanning memory, select the channel and then press and hold the **SCN** key until the display shows **MEM** at the top.

To remove a channel from the scanning memory, select the channel and then press and hold the **SCN** key until the **MEM** sign disappears from the display.

Low power operation

The radio can be operated in low power mode. In this mode battery life time is dramatically increased. Up to the first second of a received call might be lost if this mode is selected. Refer to *SLEEP* on page 18.

Continuous Tone Coded Squelch System

Selective squelch opening by sub-tone detection (CTCSS) can be enabled, using the configuration mode (see *CTCSS* on page 21). Please note that if the radio is operating with CTCSS on a channel, and a carrier is received, it may not be recognized in the loud speaker if the matching sub-tone is not detected. For this reason, be very careful not to use CTCSS programmed channels in emergency situations. For the same reason transmitting is prohibited (reporting "BUSY") if a (silent) carrier containing any sub-tone is active on the channel while pressing PTT.

Channels programmed with CTCSS will have a clear identification in the service field, e.g. "CTCSS 22", while selected. Not all channels are allowed for CTCSS use.

For maritime channels CTCSS is automatically disabled when

- Product is turned off

- A new channel is selected

For private channels, the feature will remain until manually removed.

Scrambler

On channels where it is allowed, you can set up voice scrambling, using configuration mode (see *SCRM* on page 22).

Please note that if the radio is operating with scrambling on a channel, it is impossible to communicate with other radios that are not programmed with the same scrambler code. For this reason, be very careful **not** to use scrambled channels in emergency situations. Scrambled channels will have a clear identification in the service field, e.g. "SCRM 3", while selected. Not all regions allow the use of voice scrambling.

For maritime channels scrambling is automatically disabled when

- Product is turned off
- A new channel is selected

For private channels, scrambling will remain until manually removed.

Note

Prior to any initiation of scrambling, the operator must always identify the calling station in clear voice (unscrambled) on that channel. Use of scrambling may also be restricted by national laws.

Narrow band operation

The radio is prepared for narrow band operation. (see *BAND* on page 22). Narrow band configuration is indicated with an "n" next to the channel designator.

Batteries

Battery level indication

When the battery level is low, you should recharge the battery.

The radio display shows the battery status. When the battery symbol is empty and flashing, the battery should be recharged as soon as possible.

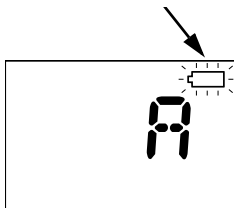

Removing and inserting the battery pack

To remove the battery pack, do as follows:

1. Open the safety lock as shown.
2. Remove the battery.

To insert the battery pack, attach the battery and then close the safety lock.

If the radio is not used for several weeks it is recommended to store the radio and battery separated to reduce self discharge of the battery.

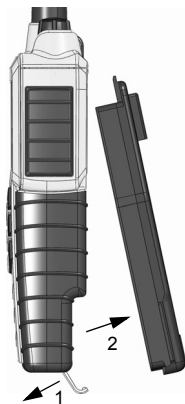

The battery chargers

The chargers has two compartments.

CH3505

- A compartment for recharging the battery alone or while attached to the radio.

CH3507

- A rear compartment only for storing a spare battery. It does not have a charger function.
- A front compartment for recharging the battery alone or while attached to the radio.

CH3508

- It is possible to charge a battery in rear compartment simultaneously with the radio/battery in front.

Installing the charger

Mounting the charger

There are several options for mounting one or more chargers on a table or a wall.

For information on dimensions and screw positions, refer to *Dimensional drawing, charger* on page 36.

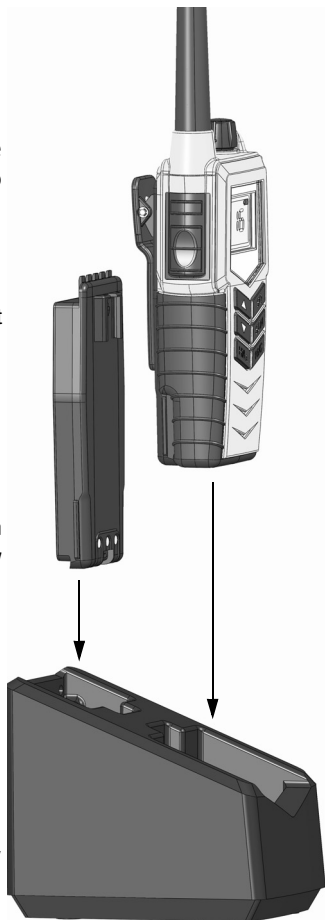

When mounting the charger, make sure it is placed in a dry place and away from direct sunlight. The charger is not waterproof.

Connecting to power

The charger can be supplied from DC or from AC using an AC/DC converter.

DC: Connect the 12-24VDC Connection Cable between the DC supply and the connector on the underside of the charger.

AC: Connect the AC/DC converter to the connector on the underside of the charger. Then connect the AC/DC converter to the AC outlet.

Recharging the battery

To recharge the battery, place the radio with battery or the battery alone in the front position of the charger cradle.

If the radio cannot turn on due to complete discharged battery, then **turn of** the radio and place it in the charger or charge the battery alone.

The light indicators on the charger cradle show the status as follows:

- Green light: Power is connected to the charger.
- Slow red flash: Charging in progress.
- Quick red flash (twice per second): Charging error, e.g. battery defect or temperature out of range.
- Steady red light: Charging completed. Trickle charge mode.

Charging time with empty battery: UHF off approx. 4 hours, UHF on: approx. 5 hours.

The battery indicator on the radio display indicates if the radio is placed in the charger while radio and charger are both powered.

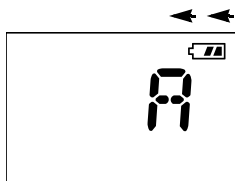

Configuring the radio

Configuration mode

Entering and using configuration mode

Note | The radio is not operational in configuration mode.

- **To enter** configuration mode, press and hold the **Light/Lock** button while turning on the radio.
The bottom line of the display shows the current menu item/setting.
- **To exit** configuration mode, turn off the radio or press any key except ▲, ▼ and the Light/Lock button.
Using the PTT button or leaving the radio inactive for 10 seconds also causes the radio to exit configuration mode.
- **To change** a setting, press ▲ or ▼.
- **To confirm the current setting** and go to the next menu item, press the **Light/Lock** button.

List of configuration settings

The following settings are available in configuration mode.

Name	Values	Description
LIGHT	MAN	Only Light/Lock button activates the backlight.
	KEY	All keys and buttons, except PTT and volume control, activate the backlight.
BEEP	MAX	Status click/beep sound on key press, long press (settings/programming saved) and battery alarm. Maximum level.
	MIN	Status click/beep sound on key press, long press (settings/programming saved) and battery alarm. Minimum level.
	OFF	All beeps off.
VER	X.XX.XX	Software version. Read-only.
BAT	X.XX	Battery voltage (V). Read-only.
TEMP	XX.X	Temperature (°C). Read-only.
SLEEP	ON	Enable sleep mode (to minimize power consumption). Sleeps for periods of 1 second after 15 seconds of idle mode. Idle mode is: no signal detected and no operation of the radio.
	OFF	Disable sleep mode.

Name	Values	Description
CONTRST	1, 2, 3, 4, 5	Contrast. 1 = lowest and 5 = highest.
SHANG	OFF	Off. Resumes scanning when signal disappears.
	4, 6, 8, 10	Scan hang time (in seconds) on an active receiving working channel. The time is measured from signal detected - remains on channel even if signal disappears.
RESCN	OFF	Automatic resume deactivated.
	3, 6, 10, 15, 20, 25, 30	Scanning/watch can be automatically resumed after this time (seconds) if previously terminated with PTT.
SQ	TIME	A long press on SQ opens squelch. The squelch level resumes to setting 3 seconds after SQ is released.
	MAN	A long press on SQ opens squelch. The squelch level resumes to setting as soon SQ is released.
WORK	ON	If the default channel D is selected using the D/P0 key, any push on ▲ or ▼ will select the working channel active before D/P0 was pushed.
	OFF	If on a distress or call channel, any push on ▲ or ▼ will select the channel next to the displayed channel.

Name	Values	Description
P0	OFF	Remove tag "P0" for current working channel.
	ON	Tag current working channel with "P0". If another channel was previously tagged "P0", this is overruled. <ul style="list-style-type: none"> • The working channel can now be selected with a long press on "D/P0".
P1	OFF	Remove tag "P1" for current working channel.
	ON	Tag current working channel with "P1". If another channel was previously tagged "P1", this is overruled. <ul style="list-style-type: none"> • The working channel can now be selected with a long press on ▼.
P2	OFF	Remove tag "B" for current working channel.
	ON	Tag current working channel with "P2". If another channel was previously tagged "P2", this is overruled. <ul style="list-style-type: none"> • The working channel can now be selected with a long press on ▲.

Name	Values	Description
SUBC	OFF	SUBC disabled. Squelch opens on all received signals.
	1, 2, ..., 38	<p>Sub-tone carrier ID.</p> <p>Squelch opens if the received signal contains the desired subtone. During transmission the sub-tone with the corresponding ID is generated.</p> <p>Two radios on the same channel and with the same sub-tone ID, can reduce unwanted incoming traffic from other users on the same channel.</p>
CTCSS	OFF	CTCSS disabled.
	ON	<p>Activate CTCSS on working channel. Two radios on the same channel and with SUBC enabled, can have a certain level of privacy.</p> <p>Note that if you choose this option, the radio immediately exits configuration mode and starts CTCSS on the working channel.</p>
GROUP	SEL	Selective Mode. Squelch opens only if the programmed sub-tone is received in the signal.
	ANY	Squelch opens on reception of any of the 38 sub-tones.

Name	Values	Description
SCODE	OFF	No scrambler code is assigned to the channel (selecting “ON” in the SCRM setting will have no effect).
	1, 2, 3, 4, 5, CC	A selection between 5 fixed sets of scrambler characteristics, and a custom code (CC), can be assigned to the channel. Note that the custom code can be defined in the service interface.
SCRM	OFF	Scrambler disabled.
	ON	Activate scrambling on working channel. Two radios on the same channel and with scrambling enabled, can have a certain level of privacy. Note that if you choose this option, the radio immediately exits configuration mode and starts scrambling on the working channel.
BAND	25.0	Wide band operation selected.
	12.5	Narrow band operation selected.

Equipment and accessories

External equipment

List of equipment

The following equipment can be connected to the radio:

- SAVOX 400E Push-To-Talk unit
- SAVOX C500 Fist Mike
- SAVOX NC/400 Noise-com
- SAVOX HC-E Helmet-com
- SAVOX K53004 Helmet unit
- Peltor MT7H79 Headset

We recommend to remove all accessories during emergency use.

All accessories listed might be used when body worn.

Connecting external equipment

Connect the dedicated interface cable between the external equipment and the top connector on the radio.

Interface cable	Order number
For SAVOX 400E	403500-940
For SAVOX C500	403500-950
For Peltor FL5261	403500-952



When external equipment is connected to the radio, the right side of the display will show a headset.

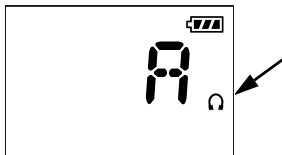

Impact on radio operation

The external equipment can have a built-in PTT, speaker and microphone. Thus connecting it to the radio will have the following impact on the radio operation:

- If a microphone is built into the detected external equipment, the external equipment microphone is used, and the internal radio microphone is disabled.
- If a speaker or earpiece is built into the detected external equipment, the external equipment sound device is used, and the internal radio speaker is disabled.
- If a PTT or VOX is built into the detected external equipment, the external equipment PTT control is used, and the radio PTT button is disabled.

Accessorie connector

- Pin 1. Loudspeaker,
minimum 8 ohm impedance.
- Pin 2. Accessory power,
3.5V maximum 13mA.
- Pin 3. Microphone input,
 $R_i = 2.2\text{kohm}$, 3V phantom power.
- Pin 4. GND.

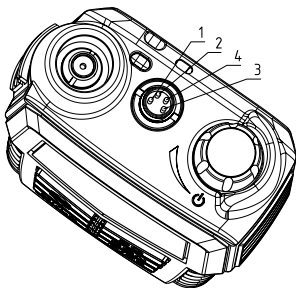

Accessories

List of accessories

The following accessories are delivered with your radio:

Accessory	Part number
ATEX Rechargeable battery, B3504	403504A
ATEX Compact Charger, CH3505	403505A
AC/DC converter, length 150cm (100-240V~ /12VDC out)	88-125538
12-24VDC Connection cable, length 150cm	37-124381
Belt clip	62-124320
Antenna	88-125662
Lanyard	41-124375
SP3560 User Manual (this manual)	TT 98-124309

Batteries, charger, AC/DC Converter and **12VDC Connection** are described in *Batteries* on page 13.

To mount the **antenna**, simply screw it into the threaded bush at the top of the radio.

Use of **lanyard** is only for hand held operation. Put it around the wrist to prevent dropping the radio.

Accessories you may buy

Accessory	Part number
ATEX Charger CH3507	403507B
ATEX Dual Position Charger CH3508	403508B
ATEX Leather Case	403500-207

Leather Case



Warning!

The display must always be kept away from the body to reduce the RF exposure when body worn.

Attaching and removing the belt clip

To attach the belt clip, slide the belt clip upwards into the rails at the back of the radio until it locks.

To remove the belt clip, press the projection at the top of the belt clip to release the lock and slide the belt clip downwards out of the rails.

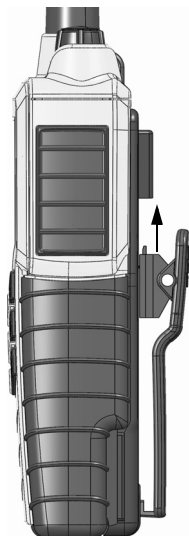
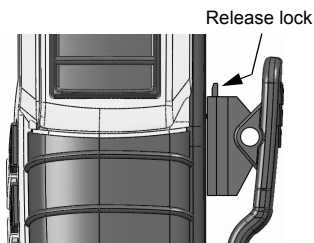

Attaching the lanyard

Do as follows:

1. Take the lanyard through the eye at the top of the radio.
2. Put one end of the lanyard through the loop at the other end of the lanyard and pull to tighten.

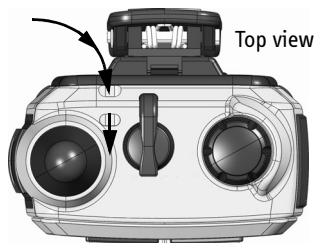

Troubleshooting

Displaying errors

Some errors result in an error message in the display. These error messages are listed below.

Display text	Problem	Type	Actions
Err EMPTY BAT	The battery voltage is below a critical level, where further operation would damage the battery.	Severe. Radio is non-functional.	Change/recharge the battery.
Err HW ERR	Hardware error.	Severe. Radio is non-functional.	Service required.
ILLEGAL	Context fails operation. This text will appear on the following occasions: <ul style="list-style-type: none"> • Multiple watch is selected on channel 16, or in channel regions where it is not allowed. • High power is selected on a channel where it is prohibited. • Transmission on blocked channels 	Fail operation	Consider operation in a different context.

Technical specifications

Technical data SP3560

General

Item	Specification
RX frequency range	440.000 - 470.000 MHz
TX frequency range	440.000 - 470.000 MHz
Modulation 25 kHz/12.5 kHz for FCC and IC: 12.5 kHz	16K0G3E/8K50G3E 11K0G3E
Power supply	7.2 VDC Li battery
Current drain at 2 W TX	1.0 A
Current drain at 0.4 W TX	0.7 A
Current drain RX max audio	0.25 A
Antenna port	50 ohm
Battery	Lithium-Ion, 1800 mAh rechargeable
Operating temperature	-20°C to +55°C
Water ingress protection	IP67
Frequency stability	Better than ± 1.0 kHz
Weight with battery	350g

Transmitter

Item	Specification
RF output power, landmobile (50 ohm)	1.3 W \pm 1.5 dB / 0.3 W \pm 1.5 dB FCC: 1.3 W \pm 0.79 dB / 0.3 W \pm 0.79 dB IC: 1.3 W \pm 1 dB / 0.3 W \pm 1 dB
RF output power, maritime	2 W radiated / 0.4 W radiated
Max deviation 25 kHz 12.5 kHz	\pm 5 kHz \pm 2.5 kHz
Spurious emission	< 0.25 μ W
Adjacent channel power 25 kHz 12.5 kHz	> 70 dB > 60 dB

Receiver

Item	Specification
Sensitivity (20 dB SINAD)	-117 dBm typical
Intermodulation EN 300 720 EN 300 086	Better than 68 dB 65 dB
Spurious response	> 70 dB

Item	Specification
Adjacent channel selectivity 25 kHz 12.5 kHz	> 70 dB > 60 dB
Audio output, internal	0.25 W at 10% dist.
Audio output, external	0.25 W/8 ohm

Battery life guidelines

Battery (rechargeable)

Note | New batteries should be placed in the charger CH3507B or CH3508B for minimum 12 hours first time.

During daily use, always keep the battery fully charged and away from hot areas.

Keep the battery terminals dry and clean.

Never discharge beyond the specifications of the battery.

Operation/Standby time depends on usage. Generally, the more the radio is transmitting, the faster it will drain the battery. Also, the “Hi” power setting will drain the battery faster than the “Lo” setting.

Approximate figures are:

- A battery can be stored for 4 to 6 month at 25°C if charged to 25%.
- The battery will normally last for 5 to 9 hours of use on a fully charged battery.

Dimensional drawing, transceiver

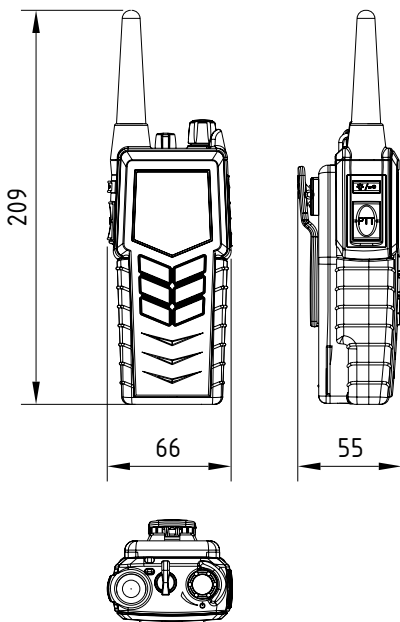

Dimensional drawing, charger

CH3505

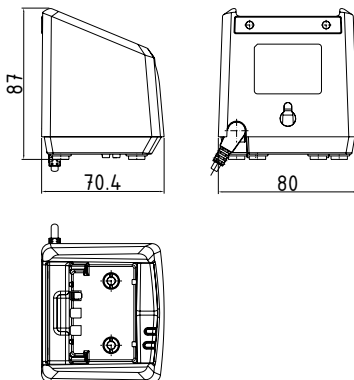

Mounting Possibilities

Desktop mounting, top view

Wall mounting, rear view

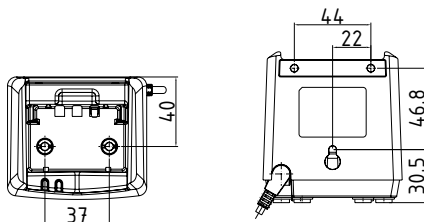

CH3507 and CH3508

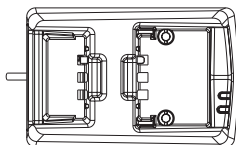
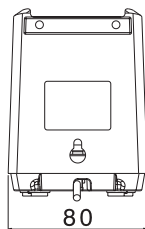
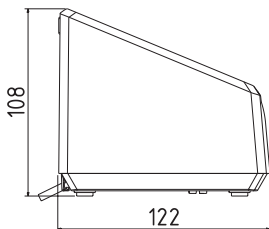

Mounting Possibilities

Desktop mounting, top view

Wall mounting, rear view

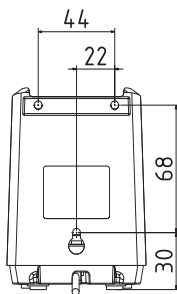
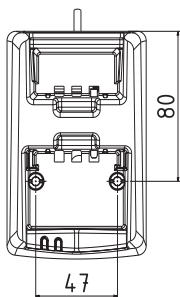

Thrane & Thrane A/S

Declaration of Conformity with R&TTE Directive

The undersigned of this letter declares that the following equipment complies with the specifications of EC directive 1999/5/EC concerning Radio & Telecommunications Terminal Equipment.

Equipment included in this declaration

SAILOR SP3560	ATEX Portable UHF radiotelephone	PN = 623560A
SAILOR B3504	ATEX Rechargeable Li-Ion Battery	PN = 403504A
SAILOR CH3505	Battery Compact Charger for ATEX	PN = 403505A
SAILOR CH3507	Battery Charger for ATEX	PN = 403507B
SAILOR CH3508	Dual Battery Charger for ATEX	PN = 403508B
	AC/DC Adapter	PN = 88-125538

Equipment Applicability

SAILOR SP3560 is a simplex/semi-duplex handheld UHF radiotelephone designed for maritime & landmobile communication within the frequency range 440 MHz to 470 MHz.

Declaration

The requirement with respect to the LVD directive 73/23/EC is met by conforming to the harmonized EU standard EN 60950. The protection requirement with respect to the EMC directive 89/336/EC is met by conforming to the harmonized EU standard EN 60945. Effective use of frequency spectrum is met by conforming to the harmonized EU standard ETSI EN 300 720 and EN 300 086.

Manufacturer

Thrane & Thrane A/S
Lundtoftgårdsvej 93D, DK-2800 Kgs. Lyngby, Denmark
Porsvej 2, DK-9200 Aalborg SV, Denmark

Place and Date

Aalborg, 23. January 2009

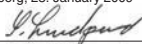

Chief Financial Officer
Svend Åge Lundgaard Jensen

CE 0470

Doc. no TT99-128498-B

Thrane & Thrane A/S · Lundtoftgårdsvej 93D · DK-2800 Kgs. Lyngby · Danmark
T +45 39 55 88 00 · F +45 39 55 88 88 · info@thrane.com · www.thrane.com
Bank: Danske Bank · Comp. no: 65 72 46 18 · VAT: DK-20 64 64 46



Attention

Goretex Membran

To keep the UHF watertight, it is very important that the goretex membran behind the label under no circumstances must be damaged or removed.



TT-98-124309-B Issue: B/0905