

COBHAM

SAILOR 3965 Portable UHF ATEX, Fire Fighter

User manual



Disposal

The Waste Electrical and Electronic Equipment (WEEE) Directive aims to minimise any adverse impact of electronic equipment on the environment, both during the product lifetime and when it becomes waste. Within the European Union this legislation is mandated by Directive 2012/19/EU, and there is similar legislation in most other continents. The directive applies to all electronic products such as IT, household appliances, portable electronics etc., and imposes requirements to collect, treat, recover and recycle each product at its end of life. Electronic end-user products must also carry a WEEE label (as below) and recovery and recycling information has to be provided to the recycler.



This product contains traces of lithium in the battery pack. In addition it may contain lead and brominated flame retardants (BFRs), both in the housing material and circuit boards. In keeping with the directive, Thrane & Thrane A/S strongly recommends that this product and its battery pack be disposed of in a sensible and considerate manner. For example, do not simply discard the product in the domestic waste. Instead take it to a civil recycling facility, or contact Thrane & Thrane A/S for advice.

Attention

Read important ATEX information in the following 9 pages.
Additional important user information follows after page 9.

ATEX marking for Radio type TT-3965A



Compliance with the Essential Health and Safety Requirements has been assured by compliance with:
EN 60079-0:2012 + A11:2013 and EN 60079-11:2012

See the ATEX EU-type Examination Certificate for additional information (a copy of the certificate is included in this user manual).

Operating ambient temperature -20°C to +55°C

Putting TT-3965A into service

Unpacking of the radio and accessories and the removal of the protective film in front of the display must not take place in the ATEX protected area.

Do not use a mechanically damaged radio or battery inside hazardous area.

Always keep contacts on radio, battery and accessories dry and clean.

Do not change the battery in wet or humid environments.

Do not charge the battery in hazardous area.

For charge of battery use only:

Part no: 403505A – ATEX CH3505 Compact Charger,

Part no: 403507B – ATEX CH3507 Single Position Charger or

Part no: 403508B – ATEX CH3508 Dual Position Charger

Use only battery type SAILOR B3503, B3504, or B3906.

Charge the battery for approximately 24 hours the 1st time after prolonged storage to achieve maximum performance

Use only with TT-3965A ATEX approved accessories.

Alternatively ATEX approved accessories in compliance with the accessory connectors ATEX specification may be used.

Use of TT-3965A

TT-3965A is a UHF radio designed for communication in ATEX areas in accordance with the ATEX approval.

TT-3965A is watertight according to the specification IP67.

TT-3965A is designed for use among others on board ships, oilrigs etc.

These radios are typically used for communication between firefighters and the incident commander or between smoke divers.

Do not use a mechanically damaged radio or battery inside hazardous area.

Do not open the radio or battery. There isn't any serviceable parts inside.

Do not charge the battery in hazardous area.

Change of battery is allowed in hazardous area provided that radio and battery contacts are kept dry.

TT-3965A normally uses the rechargeable battery B3906. TT-3965A may alternatively be used with the non-rechargeable battery B3503. B3503 has a shelf life for up to 6 years.

Assembling and dismantling of battery on TT-3965A

Removing and inserting the battery pack

To **remove** the battery pack, do as follows:

1. Open the safety lock as shown.
2. Remove the battery.

To **insert** the battery pack, attach the battery and then close the safety lock

If the radio is not used for several weeks it is recommended to store the radio and battery separated to reduce self discharge of the battery.

Always keep the battery connector dry and clean.



Assembling and dismantling of Accessories on TT-3965A top connector

Accessories are connected to the radio at the accessory connector on top of the radio.

Mounting of accessories

Remove the connector cap.

Insert connector in radio and tighten the nut on the accessory connector by hand to exclude water.

Disassembly of accessories

Unscrew the nut and remove the accessory connector.

Attach the connector cap to exclude water.

Always keep connectors dry and clean.

Use only with TT-3965A ATEX approved accessories.

Alternatively ATEX approved accessories in compliance with the accessory connector ATEX specification may be used.

Accessory connector ATEX specification

Technical data:

Accessory interface connector in type of protection Intrinsic Safety

Ex ib IIB only for the connection to certified intrinsically safe circuits

Maximum values: $U_o = 8.4 \text{ V}$
 $I_o = 450 \text{ mA}$

Long-term output power $P_o = 1.8 \text{ W}$ Rectangular characteristics
 $C_o = 150 \text{ nF}$
 $L_o = 10 \text{ }\mu\text{H}$

ATEX approved accessories

Item	Item number	Description
Battery B3503	403503A	ATEX Primary battery
Battery B3504	403504A	ATEX Secondary battery
Battery B3906	403906A	ATEX Secondary battery for TT-3965A
UHF Antenna	88-125662	UHF Antenna
Lanyard	41-124375	Lanyard
Belt clip	62-124320	Belt clip
Leather case	403500-207	Leather case

Accessories approved for use outside ATEX protection zone

Item	Item number	Description
Charger CH3505	403505A	Single position compact charger
Charger CH3507	403507B	Single position charger with holder
Charger CH3508	403508B	Dual position charger
Service cable	403500-958	Only for service use

Maintenance, overhaul and repair

Always keep connectors dry and clean.

Recharge the battery regularly.

Change of battery is allowed in hazardous area provided that radio and battery contacts are kept dry.

No tools are needed for maintenance, overhaul and repair.

Do not open the radio or battery. The radio and battery are each sealed to exclude water.

There is no accessible user or service adjustments inside the radio or battery.

A defect radio or battery must be switched OFF and taken out of service immediately.

Accessories and spare parts are available see Approved accessories above.

Installation

Always install chargers outside the ATEX protected area.

Do not charge the battery in hazardous area.

Adjustment

Do not open the radio or battery. The radio and battery is sealed to exclude water.

There is no accessible user or service adjustments inside the radio and battery.

Training Instructions

No special radio training is needed.

ATEX safety is preserved independent of user settings on the radio.

Manufacturer

Thrane & Thrane A/S

Lundtoftegårdsvej 93D, DK-2800 Kgs. Lyngby, Denmark
Industrivej 30, DK-9490 Pandrup, Denmark

Special Conditions for Safe Use

Safe use of ATEX equipment:

- Do not change the battery in wet or humid environments.
- Always keep battery connectors dry and clean.
- Use only with SAILOR ATEX approved accessories.
Alternatively ATEX approved accessories in compliance with the accessory connector ATEX specification may be used.
- Do not change accessories in wet or humid environments.
- Do not charge the battery in hazardous area.
- For charge of battery use
Part no: 403505A – ATEX CH3505 Compact Charger,
Part no: 403507B – ATEX CH3507 Single Position Charger or
Part no: 403508B – ATEX CH3508 Dual Charger.
- Use only battery type SAILOR B3503, B3504 or B3906.
- Do not use a mechanically damaged radio.
- Unpacking of the radio and accessories and the removal of the protective film in front of the display window must not take place in the ATEX protected area.

SAILOR 3965 ATEX UHF Fire

Document number: 98-150078-G_Draft 03

Release date: June 15, 2018

Copyright: © 2018 Thrane & Thrane A/S. All rights reserved.

Trademark Acknowledgements

- **SAILOR** is a registered trademark of Thrane & Thrane A/S.
- **Other product and company names** mentioned in this manual may be trademarks or trade names of their respective owners.

Warranty limitation

IMPORTANT - The radio and batteries are sealed waterproof units. To create and maintain the waterproof integrity they are assembled in a controlled environment using special equipment. The radio and batteries are not user maintainable units, and the units must under no circumstances be opened except by authorized personnel. Unauthorized opening of the units will invalidate the warranty.

Disclaimer

Any responsibility or liability for loss or damage in connection with the use of this product and the accompanying documentation is disclaimed by Thrane & Thrane A/S. The information in this manual is provided for information purposes only, is subject to change without notice and may contain errors or inaccuracies. Manuals issued by Thrane & Thrane A/S are periodically revised and updated. Anyone relying on this information should acquire the most current version e.g. from www.cobham.com/satcom, **Cobham SYNC Partner Portal**, or from the distributor. Thrane & Thrane A/S is not responsible for the content or accuracy of any translations or reproductions, in whole or in part, of this manual from any other source. In the event of any discrepancies, the English version shall be the governing text.

Thrane & Thrane A/S is trading as Cobham SATCOM.

Precautions

Avoid water and salt in the I/O connector and keep it dry and clean.

Only use original Thrane & Thrane battery packs. Make sure they are clean and dry before attaching the transceiver.

Be careful not to damage any gaskets.

Only use the original Thrane & Thrane charger for the rechargeable battery.

Be very careful when handling the Lithium batteries.

With correct use they are safe but any misuse might cause dangerous situations.

Do not short circuit the battery terminals, or expose the transceiver and the batteries to extreme temperature or fire.

Beware of RF exposure. Read section *RF exposure and safety* on page iii, *Training Requirement* on page iii and *Operating instruction* on page iv before using this radio.

Do not submerge the transceiver more than 1 m for 30 minutes. Keep the transceiver at least 0.3 m away from the magnetic compass.

RF exposure and safety

The SAILOR 3965 ATEX UHF Fire is designed for *occupational use only* and is also classified as such. It must be operated by licensed personnel only and thus NOT intended for use in an uncontrolled environment by general public.

The SAILOR 3965 ATEX UHF Firefighter must only be used in the course of employment by individuals aware of the radiation hazards as well as the way to minimize those.

This radio complies with the limits for occupational/controlled RF exposure environment at operating duty factors of up to 50% transmitting and is authorized for occupational use only.

To control your exposure and ensure compliance with the occupational/controlled environment exposure limits always adhere to the following procedures.

- User awareness instructions should accompany device when transferred to other users.
- Do not use this device if the operational requirements described herein are not met.

The SAILOR 3965 ATEX UHF Firefighter complies with the limits for occupational/controlled exposure in the following SAR specifications:

- IEEE 1528-2013
- FCC CFR 47 § 2.1093
- RSS-102 Issue 5

Training Requirement

Operating personnel shall have completed an RF safety program including specific training and education regarding RF radiation hazards in the use of the equipment.

Please refer to the following websites for more information on what RF energy exposure is and how to control your exposure to assure compliance with established RF exposure limits.

<https://www.fcc.gov/engineering-technology/electromagnetic-compatibility-division/radio-frequency-safety/faq/rf-safety>

http://www.ic.gc.ca/eic/site/ceb-bhst.nsf/eng/h_tt00084.html

Operating instruction

Follow these general rules of operation for safe operation and to reduce the RF exposed energy:

- Transmit no more than the rated duty factor of 50% of the time.
- Hold the radio in a vertical position in front of face with the microphone (and the other parts of the radio, including the antenna) at least one inch (2.5 cm) away from the head. Keeping the radio at the proper distance is important because RF exposures decrease with distance from the antenna.
- When worn on the body, always place the radio with an approved belt clip or case. Using approved body-worn accessories is important because the use of other manufacturer's non-approved accessories may result in exposure levels, which exceed the occupational/controlled environment RF exposure limits.
- Use only manufacturer's name approved supplied or replacement antennas, batteries, and accessories. Use of non-manufacturer-name approved antennas, batteries, and accessories may exceed the exposure guidelines.
- For best radio performance, hold the radio vertically and 5 cm away from the head when talking into the microphone.

Channel programming

SAILOR 3965 ATEX UHF Fire is from manufacturer programmed with an approved set of 25 kHz and 12.5 kHz channels according to ITU-R M.1174-3 specifying the international channels for on-board vessel communication. For alternative configuration of the radio contact a general agent.

“Placeholder” for French version of *Precautions, RF exposure and safety, Training Requirement, Operating instruction and Channel programming.*

Contents

Chapter 1 Introduction

Your ATEX UHF Fire	1
Performance	2
Channels	2

Chapter 2 Operation

Controls	5
Keys and buttons	5
The display	7
Using the ATEX UHF	8
Basic functions	8
Other functions	11

Chapter 3 Batteries

Battery level indication	15
The battery chargers	16
Installing the charger	16
Recharging the battery	17

Chapter 4 Configuring the radio

Configuration mode	19
Entering and using configuration mode	19
List of configuration settings	20

Chapter 5 Equipment and accessories

External equipment	27
List of equipment	27
Connecting external equipment	28
Impact on radio operation	29
Accessory connector	29
Accessories	30
List of accessories	30
Attaching and removing the belt clip	32
Attaching the lanyard	32

Chapter 6 Troubleshooting

Displaying errors	33
-------------------------	----

App. A Technical specifications

Technical data SAILOR 3965	35
General	35
Transmitter	36
Receiver	36
Battery life guidelines	37
Battery (rechargeable)	37
Dimensional drawing, transceiver	38
Dimensional drawing, charger	39
Declaration of Conformity	41

App. B Attention

Gore-tex Membrane	47
--------------------------------	-----------

Introduction

Your ATEX UHF Fire

The ATEX UHF Fire is designed for flexibility in daily use. It connects easily to external equipment like headsets and fist mikes, making the SAILOR 3965 suitable for any noisy environment.

Main features:

- Unique man machine interface, an excellent grip even with gloves, and large tactile buttons.
- Display with red adjustable backlight which makes the display visible even at night.
- Built-in “sleep” function, minimizing power consumption and improving battery lifetime.
- Selectable 12.5 kHz narrow band or 25 kHz wide band operation.
- Scrambling function for privacy calls.
- CTCSS function for selective opening of Squelch.
- Channel read-out function for audible feedback of channel name in headset upon channel change
- A lanyard and belt clip included.



Performance

For best performance of the transceiver keep the following in mind:

- Keep clear of metal environment.
- Hold the transceiver vertically and 5 cm from lips and push the PTT when transmitting.
- In receive mode carry the transceiver vertically with belt clips.
- To preserve battery power, adjust squelch to close the loudspeaker when there is no signal.
- If you are in a lifeboat keep the antenna as high as possible.

Channels

SAILOR 3965 ATEX UHF Fire is from manufacturer programmed with an approved set of 25 kHz and 12.5 kHz channels according to ITU-R M.1174-3 specifying the international channels for on-board vessel communication. For alternative configuration of the radio contact a general agent.

Table 1: Simplex frequencies (25 kHz or 12.5 kHz_(n) use)

Channel designator (preprogrammed)	Recommendation ITU-R M.1174-3	Frequency
A	4	467.525 MHz
A _n	21	
B	5	467.550 MHz
B _n	23	
C	6	467.575 MHz
C _n	25	

Channel designator (preprogrammed)	Recommendation ITU-R M.1174-3	Frequency
D	1	457.525 MHz
D _n	11	
E	2	457.550 MHz
E _n	13	
F	3	457.575 MHz
F _n	15	

Table 2: Additional frequencies for 12.5 kHz use

Channel designator (preprogrammed)	Recommendation ITU-R M.1174-3	Frequency
M _n	22	467.5375 MHz
N _n	24	467.5625 MHz
O _n	12	457.5375 MHz
P _n	14	457.5625 MHz

Table 3: Duplex frequencies for use with repeaters only (25 kHz or 12.5 kHz_(n) use)

Channel designator (preprogrammed)	Repeater RX Frequency	Repeater TX Frequency
G	467.525 MHz	457.525 MHz
G _n		
H	467.550 MHz	457.550 MHz
H _n		

Channel designator (preprogrammed)	Repeater RX Frequency	Repeater TX Frequency
J	467.575 MHz	457.575 MHz
J _n		
K	467.5375 MHz	457.5375 MHz
K _n		
L	467.5625 MHz	457.5625 MHz
L _n		

The channel designators are defaulted to the letter formats “A” (25 kHz frequency separation) or “A_n” (12.5 kHz frequency separation). Any additional explanatory naming can be added (see *ADD NAME* in *Chapter 4 Configuring the radio* on page 19).

If no dedicated naming is applicable users are encouraged to add complimentary channel names as defined in table 2 and 3 (Recommendation ITU-R M.1174-3). Examples:

- 12 kHz operation: “A” - “CH 4”
- 12.5 kHz operation: “A_n” - “CH 21”
- Both 25 and 12.5 kHz operation: “A_n” - “CH 4 21”

Your dealer can perform any custom programming.

Operation

Controls





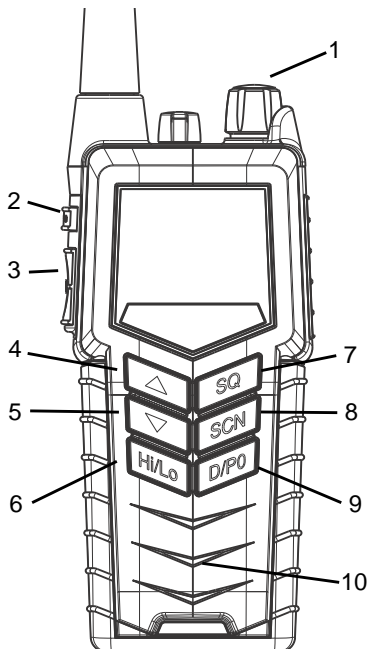

Keys and buttons

1. On/off/volume
2. Light/Lock
3. Push To Talk (PTT)
4. Up key
5. Down key
6. Hi/Lo output power
7. Squelch
8. Scan
9. D/P0 quick channel select
10. Loudspeaker/microphone



Key presses

Pressing and holding certain keys gives access to additional functions, shown in the table below.

Key	Short press (1 beep)	Long press (2 beeps)	Extra long press (3 beeps)
 	<p>Show next available item in the list (up or down).</p> <p>Default: Channel selection</p>	<p>Run through available items, or select tagged channels P1 (▼) or P2 (▲).</p>	<p>Run through available items if an P1 or P2 channel is tagged</p>
	<p>Activate Squelch control (Adjust with up/down arrows).</p>	<p>Monitor function. Open Squelch completely. Set period of time in configuration mode.</p>	
	<p>1 press: Activate/terminate Dual watch.</p> <p>2 presses: Activate memory scan.</p>	<p>Add/Delete channel from memory scan.</p>	
	<p>Toggle between high and low transmitter power.</p>		
	<p>Select channel D.</p>	<p>Select preprogrammed channel P0.</p>	

The display

The display holds various fields of information, explained below.

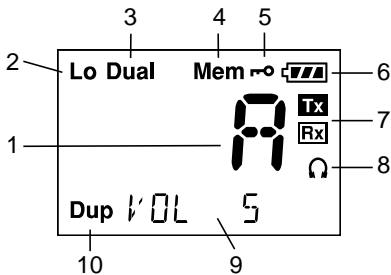

1. Current working channel.
2. “LO”: Reduced transmitter power.
Full transmitter power is not shown in display.
3. Dual watch activated.
4. Current working channel is marked for scanning.
5. Keypad is locked.
6. Battery level indicator.
7. Transmitting (TX) /Receiving (RX).
8. Accessory is connected.
9. Service line for various purposes. In this example the volume level.
10. Semi-duplex channel.

Using the ATEX UHF

Basic functions

Note Before using the radio, mount the antenna at the top of the radio. The antenna is delivered with the radio.

Switching the radio on and off

- **To switch the radio on**, turn the knob at the top of the radio **clockwise**.
The display lights up showing the last used channel and the battery level.
- **To switch the radio off**, Turn the knob back **counter-clockwise** until it clicks.



Selecting the working channel

- To select **channel D**, press the **D/P0** key.
- To select among **all available channels**, press **▲** or **▼** on the keypad.
For fast selection, press and hold **▲** or **▼**.

The display shows the currently selected channel. The bottom left corner of the display shows “Dup” if the channel is a semi-duplex channel.

Note Long press on **▲** or **▼** can also be used to select preferred channels. For information on how to program preferred channels, see *Configuring the radio* on page 19.

Activating a call

To **activate a call** to the selected channel, press and hold the **PTT** button on the side of the radio.

The radio transmits as long as the PTT button is pressed. A small **TX** sign next to the channel number indicates when the radio is in transmit mode.



Adjusting the volume

- To **increase** the volume, turn the on/off knob at the top of the radio **clockwise**.
- To **decrease** the volume, turn the knob **counter-clockwise**.

The display shows the level of the volume, e.g. “VOL 5”, while it is adjusted.

Using Squelch control

- To **activate** Squelch control, press the **SQ** key.
- To **set** the Squelch level, press ▲ (closing) or ▼ (opening). The display shows the Squelch level while it is adjusted, e.g. “SQ 5”.

Adjusting the display backlight

- To **turn on** the backlight, press the **Light/Lock** button on the side of the radio.
- To **adjust** the backlight level, press ▲ or ▼ within 3 seconds after turning on the light. The display shows the level while it is adjusted, e.g. “DIM MED”.



Using Dual watch (requires priority channel is programmed)

- **To activate** Dual watch, press the **SCN** key.
The display shows “Dual” at the top and “D” at the bottom right. The radio toggles between the selected channel and channel D (if channel D is programmed as the priority channel).
- **To terminate** Dual watch, press **SCN** again.

Scanning channels

- **To activate** scanning memory, press 2 times **SCN** within 1/2 a second. During scanning, the display shows “SC” in the channel field. The radio toggles between channel D and each of the channels are marked for scanning (only if a priority channel, e.g. D was programmed).
- **To terminate** scanning, press **SCN** once.

Changing the transmitter power

To change the transmitter power, press the **Hi/Lo** key. The display shows “LO” when power is set to low. Otherwise maximum power is used.

Locking the keypad

- **To lock** the keypad, press and hold the **Light/Lock** button. The display shows a key symbol when the keypad is locked.
- **To unlock** the keypad, press and hold the **Light/Lock** button again.

Other functions

Programming the scanning memory

To add a channel to the scanning memory, select the channel and then press and hold the **SCN** key until the display shows **MEM** at the top.

To remove a channel from the scanning memory, select the channel and then press and hold the **SCN** key until the **MEM** sign disappears from the display.

Low power operation

The radio can be operated in low power mode. In this mode battery life time is dramatically increased. Up to the first second of a received call might be lost if this mode is selected. Refer to *SLEEP* on page 20.

Continuous Tone Coded Squelch System

Selective squelch opening by sub-tone detection (CTCSS) can be enabled, using the configuration mode (see *CTCSS* on page 23). Please note that if the radio is operating with CTCSS on a channel, and a carrier is received, it may not be recognized in the loud speaker if the matching sub-tone is not detected. For this reason, be very careful not to use CTCSS programmed channels in emergency situations. For the same reason transmitting is prohibited (reporting "BUSY") if a (silent) carrier containing any sub-tone is active on the channel while pressing PTT.

Channels programmed with CTCSS will have a clear identification in the service field, e.g. "CTCSS 22", while selected. Not all channels are allowed for CTCSS use.

For maritime channels CTCSS is automatically disabled when

- Product is turned off
- A new channel is selected

For private channels, the feature will remain until manually removed.

Scrambler

On channels where it is allowed, you can set up voice scrambling, using configuration mode (see *SCRM* on page 24).

Please note that if the radio is operating with scrambling on a channel, it is impossible to communicate with other radios that are not programmed with the same scrambler code. For this reason, be very careful **not** to use scrambled channels in emergency situations. Scrambled channels will have a clear identification in the service field, e.g. "SCRM 3", while selected. Not all regions allow the use of voice scrambling.

For maritime channels scrambling is automatically disabled when

- Product is turned off
- A new channel is selected

For private channels, scrambling will remain until manually removed.

Note

Prior to any initiation of scrambling, the operator must always identify the calling station in clear voice (unscrambled) on that channel. Use of scrambling may also be restricted by national laws.

Narrow band operation

The radio is prepared for narrow band operation. (see *BAND* on page 24).

Narrow band configuration is indicated with an "n" next to the channel designator.

Alive beep

To enable “ALIVE” function do as follows:

1. Select the channel where ALIVE function is desired to be transmitted.
2. Press and hold the **Hi/Lo** until you see “ALIVE ON” on the radio display. It takes approx. a second.
3. Now “ALIVE” is transmitted by a “beep” on the working channel, with approx. 4-second intervals.

To deactivate “ALIVE” function do as follows:

- Press and hold the **Hi/Lo** pressed until “ALIVE ON” no longer appears on the radio display. It takes approx. a second.

“ALIVE” function is also deactivated when

- The channel is changed.
- The radio is turned OFF and ON again.
- Watch or scanning is enabled.
- Squelch is open.

Refer to *ALIVE* on page 24

Channel read-out

In some use cases the display is not directly visible to the user (e.g. if the radio is used in a belt or pocket). Consequently, when changing to a new channel (using the Up and Down buttons) the user cannot positively know which channel is now the current one.

The channel read-out feature, however, enables users to get audible feedback on channel name in a connected headset (or speaker-mike)

upon channel change (the name of the new channel will be announced in the headset).

Please note that this feature is disabled as default and can be enabled either through the Portable Radio Service Tool or the menu settings in the radio (see chapter 4 for more information).

Please also note that this feature requires external equipment with a speaker, hence, although the feature is enabled the new channel will not be announced in the speaker of the radio.

Please also note that if the Monitor function is enabled, the new channel will not be announced in the speaker of the radio or the head-set although the channel read-out feature is enabled and a head-set is connected.

Batteries

Battery level indication

When the battery level is low, you should recharge the battery.

The radio display shows the battery status. When the battery symbol is empty and flashing, the battery should be recharged as soon as possible.

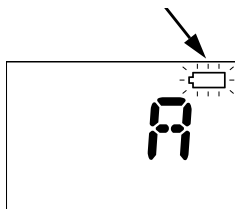

Removing and inserting the battery pack

To remove the battery pack, do as follows:

1. Open the safety lock as shown.
2. Remove the battery.

To insert the battery pack, attach the battery and then close the safety lock.

If the radio is not used for several weeks it is recommended to store the radio and battery separated to reduce self discharge of the battery.



The battery chargers

The chargers has two compartments.

CH3505

- A compartment for recharging the battery alone or while attached to the radio.

CH3507

- A rear compartment only for storing a spare battery. It does not have a charger function.
- A front compartment for recharging the battery alone or while attached to the radio.

CH3508

- It is possible to charge a battery in rear compartment simultaneously with the radio/battery in front.



Installing the charger

Mounting the charger

There are several options for mounting one or more chargers on a table or a wall.

For information on dimensions and screw positions, refer *Dimensional drawing, charger* on page 39.

When mounting the charger, make sure it is placed in a dry place and away from direct sunlight. The charger is not waterproof.

Connecting to power

The charger can be supplied from DC or from AC using an AC/DC converter.

DC: Connect the 12-24VDC Connection Cable between the DC supply and the connector on the underside of the charger.

AC: Connect the AC/DC converter to the connector on the underside of the charger. Then connect the AC/DC converter to the AC outlet.

Recharging the battery

To recharge the battery, place the radio with battery or the battery alone in the front position of the charger cradle.

If the radio cannot turn on due to complete discharged battery, then **turn off** the radio and place it in the charger or charge the battery alone.

The light indicators on the charger cradle show the status as follows:

- Green light: Power is connected to the charger.
- Steady red light: Charging completed. Trickle charge mode.

Charging time with empty battery: UHF off approx. 4 hours, UHF on: approx. 5 hours.

The battery indicator on the radio display indicates if the radio is placed in the charger while radio and charger are both powered.

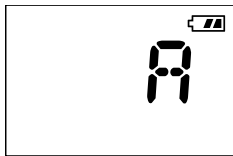

Configuring the radio

Configuration mode

Entering and using configuration mode

Note | The radio is not operational in configuration mode.

- **To enter** configuration mode, press and hold the **Light/Lock** button while turning on the radio.
The bottom line of the display shows the current menu item/setting.
- **To exit** configuration mode, turn off the radio or press any key except ▲, ▼ and the Light/Lock button.
Using the PTT button or leaving the radio inactive for 10 seconds also causes the radio to exit configuration mode.
- **To change** a setting, press ▲ or ▼.
- **To confirm the current setting** and go to the next menu item, press the **Light/Lock** button.

List of configuration settings

The following settings are available in configuration mode.

Name	Values	Description
LIGHT	MAN	Only Light/Lock button activates the backlight.
	KEY	All keys and buttons, except PTT and volume control, activate the backlight.
BEEP	MAX	Status click/beep sound on key press, long press (settings/programming saved) and battery alarm. Maximum level.
	MIN	Status click/beep sound on key press, long press (settings/programming saved) and battery alarm. Minimum level.
	OFF	All beeps off.
VER	X.XX.XX	Software version. Read-only.
BAT	X.XX	Battery voltage (V). Read-only.
TEMP	XX.X	Temperature (°C). Read-only.
SLEEP	ON	Enable sleep mode (to minimize power consumption). Sleeps for periods of 1 second after 15 seconds of idle mode. Idle mode is: no signal detected and no operation of the radio.
	OFF	Disable sleep mode.

Name	Values	Description
CONTRST	1, 2, 3, 4, 5	Contrast. 1 = lowest and 5 = highest.
SHANG	OFF	Off. Resumes scanning when signal disappears.
	4, 6, 8, 10	Scan hang time (in seconds) on an active receiving working channel. The time is measured from signal detected - remains on channel even if signal disappears.
RESCN	OFF	Automatic resume deactivated.
	3, 6, 10, 15, 20, 25, 30	Scanning/watch can be automatically resumed after this time (seconds) if previously terminated with PTT.
SQ	TIME	A long press on SQ opens squelch. The squelch level resumes to setting 3 seconds after SQ is released.
	MAN	A long press on SQ opens squelch. The squelch level resumes to setting as soon SQ is released.
WORK	ON	If the default channel D is selected using the D/P0 key, any push on ▲ or ▼ will select the working channel active before D/P0 was pushed.
	OFF	If on a distress or call channel, any push on ▲ or ▼ will select the channel next to the displayed channel.

Name	Values	Description
P0	OFF	Remove tag “P0” for current working channel.
	ON	Tag current working channel with “P0”. If another channel was previously tagged “P0”, this is overruled. <ul style="list-style-type: none"> • The working channel can now be selected with a long press on “D/P0”.
P1	OFF	Remove tag “P1” for current working channel.
	ON	Tag current working channel with “P1”. If another channel was previously tagged “P1”, this is overruled. <ul style="list-style-type: none"> • The working channel can now be selected with a long press on ▼.
P2	OFF	Remove tag “B” for current working channel.
	ON	Tag current working channel with “P2”. If another channel was previously tagged “P2”, this is overruled. <ul style="list-style-type: none"> • The working channel can now be selected with a long press on ▲.

Name	Values	Description
SUBC	OFF	SUBC disabled. Squelch opens on all received signals.
	1, 2, ..., 38	<p>Sub-tone carrier ID.</p> <p>Squelch opens if the received signal contains the desired subtone. During transmission the sub-tone with the corresponding ID is generated.</p> <p>Two radios on the same channel and with the same sub-tone ID, can reduce unwanted incoming traffic from other users on the same channel.</p>
CTCSS	OFF	CTCSS disabled.
	ON	<p>Activate CTCSS on working channel. Two radios on the same channel and with SUBC enabled, can have a certain level of privacy.</p> <p>Note that if you choose this option, the radio immediately exits configuration mode and starts CTCSS on the working channel.</p>
GROUP	SEL	Selective Mode. Squelch opens only if the programmed sub-tone is received in the signal.
	ANY	Squelch opens on reception of any of the 38 sub-tones.

Name	Values	Description
SCODE	OFF	No scrambler code is assigned to the channel (selecting “ON” in the SCRM setting will have no effect).
	1, 2, 3, 4, 5, CC	A selection between 5 fixed sets of scrambler characteristics, and a custom code (CC), can be assigned to the channel. Note that the custom code can be defined in the service interface.
SCRM	OFF	Scrambler disabled.
	ON	Activate scrambling on working channel. Two radios on the same channel and with scrambling enabled, can have a certain level of privacy. Note that if you choose this option, the radio immediately exits configuration mode and starts scrambling on the working channel.
BAND	25.0	Wide band operation selected.
	12.5	Narrow band operation selected.
ALIVE	OFF	Factory default state.
	ON	Press ▲ to set “ALIVE” on.

Name	Values	Description
ADD NAME	A-Z, 0-9	<p>Makes it possible to name the channels.</p> <p>The name must contain a maximum of 9 characters, use only capital letters, digits and spaces.</p> <p>Press Light/Lock to confirm programming.</p> <p>Note: The name appears in the service line on the display.</p>
CHRD	OFF	Channel read-out disabled - Factory default
	ON	<p>Channel read-out enabled</p> <p>Upon channel change the channel name of the new channel will be spoken in a connected headset or speaker-mike.</p> <p>Please note that the channel will not be announced in the speaker of the radio or head-set if the Monitor function is enabled.</p>

Equipment and accessories

External equipment

List of equipment

The following equipment can be connected to the radio:

Equipment	Order number
SAVOX C-C440AV Push-To Talk unit	403900-942
SAVOX C-C500 Remote Speaker Microphone	403500-944
SAVOX NC/400 Noise-com	403500-003
SAVOX HC-E Helmet-com	403500-004
SAVOX HC-1 Helmet	403500-005
Peltor MT7H79F-50 Headset	403500-006
Peltor MT7H79P3E-50 Headset - Helmet Mount	403500-007
Peltor MT1H7F2-07-51 Tactical ATEX - Headband	403500-008
Peltor MT1H7P3E2-07-51 Tactical ATEX - Helmet	403500-009

We recommend to remove all accessories during emergency use.

All accessories listed might be used when body worn.

Connecting external equipment

Connect the dedicated interface cable between the external equipment and the top connector on the radio.

Interface cable	Order number
SAVOX C-C440AV - for SAVOX PTT unit	403900-942
SAVOX C-C500 - for SAVOX Headset	403500-944
SAVOX C-C500/C-C440AV - for PELTOR headset when using SAVOX PTT	403900-953
Peltor FL5261B - for Peltor Headset	403900-952



When external equipment is connected to the radio, the right side of the display will show a headset.

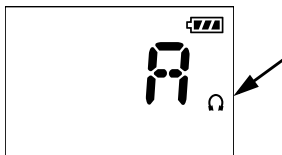

Impact on radio operation

The external equipment can have a built-in PTT button, speaker and microphone. Thus a connection has per default the following impact on the radio operation:

- If a speaker or earpiece is built into the detected external equipment, the sound device of the external equipment is used, and the internal radio speaker is disabled.
- The external accessory microphone is selected as audio input device, when the external PTT button is pressed. The transceiver microphone is used as audio input device when the transceiver PTT button is pressed.
- This behaviour can be changed in the service tool.

Accessorie connector

- Pin 1. Loudspeaker,
minimum 8 ohm impedance.
- Pin 2. Accessory power,
3.5V maximum 13mA.
- Pin 3. Microphone input,
 $R_i = 2.2\text{kohm}$, 3V phantom power.
- Pin 4. GND.

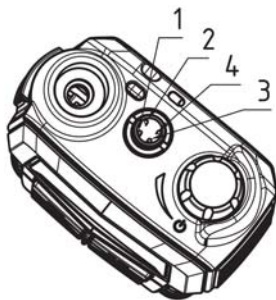

Accessories

List of accessories

The following accessories are delivered with your radio:

Accessory	Order number
ATEX Rechargeable battery, B3906	403906A
ATEX Compact Charger, CH3505	403505A
AC/DC converter, length 150cm (100-240V~ /12VDC out)	88-125538
12-24VDC Connection cable, length 150cm	37-124381
Belt clip	62-124320
Antenna	62-125662
Lanyard	41-124375
User Manual (this manual)	98-150078

Batteries, charger, AC/DC Converter and **12VDC Connection** are described in *Batteries* on page 15.

To mount the **antenna**, simply screw it into the threaded bush at the top of the radio.

Use of **lanyard** is only for hand held operation. Put it around the wrist to prevent dropping the radio.

Accessories you may buy

Accessory	Part number
ATEX Charger CH3507	403507B
ATEX Dual Position Charger CH3508	403508B
ATEX Leather Case	403500-207

Leather Case**Warning!**

The display must always be kept away from the body to reduce the RF exposure when body worn.

Attaching and removing the belt clip

To attach the belt clip, slide the belt clip upwards into the rails at the back of the radio until it locks.

To remove the belt clip, press the projection at the top of the belt clip to release the lock and slide the belt clip downwards out of the rails.

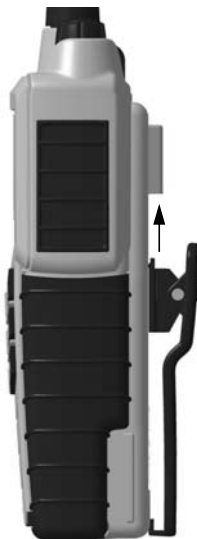
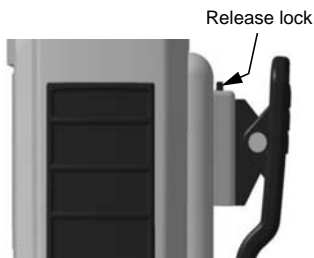

Attaching the lanyard

Do as follows:

1. Take the lanyard through the eye at the top of the radio.
2. Put one end of the lanyard through the loop at the other end of the lanyard and pull to tighten.

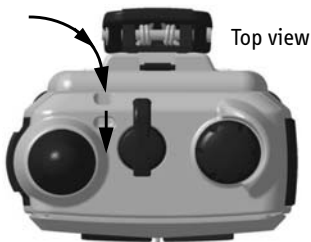

Troubleshooting

Displaying errors

Some errors result in an error message in the display. These error messages are listed below.

Display text	Problem	Type	Actions
Err EMPTY BAT	The battery voltage is below a critical level, where further operation would damage the battery.	Severe. Radio is non-functional.	Change/recharge the battery.
Err HW ERR	Hardware error.	Severe. Radio is non-functional.	Service required.
ILLEGAL	Context fails operation. This text will appear on the following occasions: <ul style="list-style-type: none"> • Multiple watch is selected in channel regions where it is not allowed. • High power is selected on a channel where it is prohibited. • Transmission on blocked channels 	Fail operation	Consider operation in a different context.

Technical specifications

Technical data SAILOR 3965

General

Item	Specification
RX frequency range	457.525 - 457.575 MHz, 467.525 - 467.575 MHz
TX frequency range	457.525 - 457.575 MHz, 467.525 - 467.575 MHz
Modulation 25 kHz/12.5 kHz	16K0G3E/8K50G3E
Power supply	VDC Li battery
Current drain at 2 W TX	1.0 A
Current drain at 0.4 W TX	0.7 A
Current drain RX max audio	0.25 A
Antenna port	50 ohm
Battery	Lithium-Ion, mAh rechargeable
Operating temperature	-20°C to +55°C
Water ingress protection	IP67
Frequency stability	Better than ± 1.0 kHz
Weight with battery	350g

Transmitter

Item	Specification
RF output power, maritime	2 W radiated / 0.4 W radiated
Max deviation	
25 kHz	±5 kHz
12.5 kHz	±2.5 kHz
Spurious emission	< 0.25 μ W
Adjacent channel power	
25 kHz	> 70 dB
12.5 kHz	> 60 dB

Receiver

Item	Specification
Sensitivity (20 dB SINAD)	-117 dBm typical
Intermodulation	Better than
EN 300 720	68 dB
EN 300 086	65 dB
Spurious response	> 70 dB
Adjacent channel selectivity	
25 kHz	> 70 dB
12.5 kHz	> 60 dB
Audio output, internal	0.25 W at 10% dist.
Audio output, external	0.25 W/8 ohm

Battery life guidelines

Battery (rechargeable)

Note | New batteries should be placed in the charger CH3505, CH3507 or CH3508 for minimum 12 hours first time.

During daily use, always keep the battery fully charged and away from hot areas.

Keep the battery terminals dry and clean.

Never discharge beyond the specifications of the battery.

Operation/Standby time depends on usage. Generally, the more the radio is transmitting, the faster it will drain the battery. Also, the “Hi” power setting will drain the battery faster than the “Lo” setting.

Approximate figures are:

- A battery can be stored for 4 to 6 month at 25°C if charged to 40%.
- The battery will normally last for 5 to 9 hours of use on a fully charged battery.

Dimensional drawing, transceiver

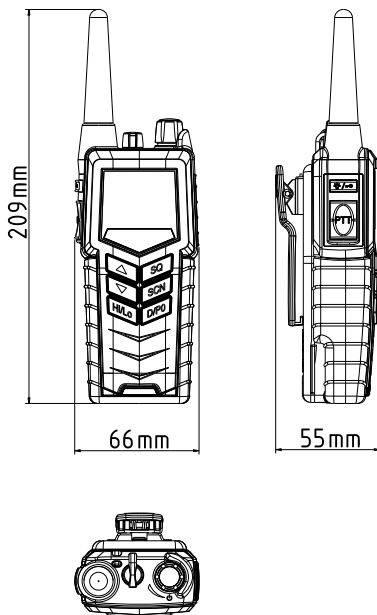

Dimensional drawing, charger

CH3505

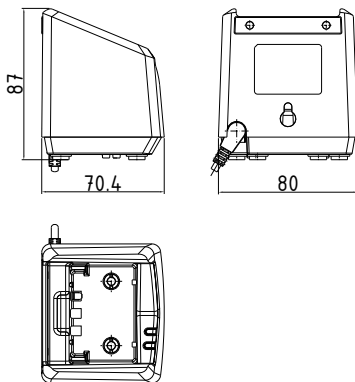

Mounting Possibilities

Desktop mounting, top view

Wall mounting, rear view

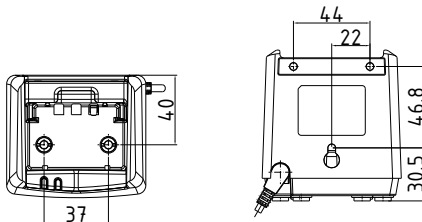

CH3507 and CH3508

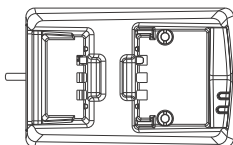
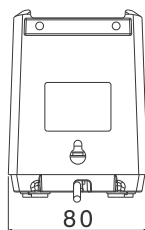
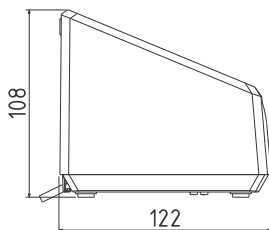



Mounting Possibilities

Desktop mounting, top view

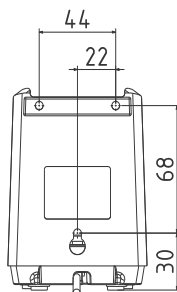
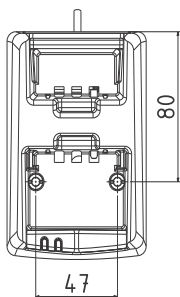
Wall mounting, rear view



Declaration of Conformity

COBHAM		
Thrane & Thrane A/S		
Declaration of Conformity with ATEX Directive 2014/34/EU		
The object of the declaration described below is in conformity with the relevant Union harmonization legislation: Directive 2014/34/EU.		
Equipment		
TT-3965A	ATEX Transceiver SAILOR 3965 UHF Fire	PN = 403965A
SAILOR B3906	ATEX Rechargeable Li-ion Battery	PN = 403906A
SAILOR B3503	ATEX Primary Lithium battery	PN = 403503A
SAILOR B3504	ATEX Rechargeable Li-ion Battery	PN = 403504A
Associated equipment for use in non-ATEX area		
SAILOR CH3505	Battery Compact Charger for ATEX	PN = 403505A
SAILOR CH3507	Battery Charger for ATEX	PN = 403507B
SAILOR CH3508	Dual Battery Charger for ATEX	PN = 403508B
	AC/DC Adapter	PN = 88-125538
Equipment Applicability		
SAILOR 3965 is a simplex/semi-duplex handheld ATEX / UHF radiotelephone designed for maritime & land-mobile communication within the frequency range 440 MHz to 470 MHz.		
Declaration		
The requirement with respect to the ATEX Directive 2014/34/EU is met by conforming to the harmonized EU standards EN 60079-0:2012 + A11:2013 and EN 60079-11:2012.		
SAILOR 3965 meets the ATEX requirement for gas environments of class II 2 G Ex ib IIB T4.		
SAILOR 3965 also meets the requirement for Ingress Protection to the level of IP67.		
Certified by:		
TÜV NORD	Notified Body Id. No. 0044	Certificate No. TÜV 16 ATEX 179791 X
TÜV Cyprus	Notified Body Id. No. 2261	Certificate No. TÜV CY 16 ATEX 0205765 Q
Issue: 01		
Manufacturer		
Thrane & Thrane A/S	Lundtoftøgårdsvej 93D, DK-2800 Kgs. Lyngby, Denmark	
	Industrivej 30, DK-9490 Pandrup, Denmark	
Place and Date		
Pandrup, 19 December, 2016		
 _____ Director Radio and Navigation R&D Henrik Kalstrup		
<div style="display: flex; justify-content: space-between; align-items: flex-end;"> <div> <p>Document number: 99-150089-B</p> <p>Thrane & Thrane A/S trading as Cobham SATCOM Lundtoftøgårdsvej 93D, DK-2800 Kgs. Lyngby, Denmark T +45 39 55 88 00 · F +45 39 55 88 88 · Comp. reg. 65 72 48 18 · SATCOM.info@cobham.com · cobham.com</p> </div> <div style="text-align: center;">  0044 2261 </div> <div style="text-align: center;">  <small>ISO 9001 · ISO 14001 MADE IN DENMARK · COBHAM A/S · 150089-B</small> </div> </div>		
Page 1 of 1		



EU Declaration of Conformity

Thrane & Thrane A/S declares that the following equipment complies with the specifications of:

RED directive 2014/53/EU concerning Radio Equipment as described in EU standards

- EN 60950-1:2006-A11:2009 + A1:2010 + A12:2011 + A2:2013
- EN 60945, Ed. 4.0 (2002)
- EN 301 843-1, V2.1.1
- EN 301 843-2, V2.1.1
- ETSI EN 300 720, V2.2.0

Equipment included in this declaration

Model	Description	Part no.
TT-3965A	SAILOR 3965 UHF ATEX Radio transceiver	403965A
TT-3906A	SAILOR B3906 Battery ATEX - Rechargeable	403906A
SAILOR CH3505	Compact Charger	403505A
SAILOR CH3507	Single Position Charger	403507A
SAILOR CH3508	Dual Position Charger	403508A
	AC/DC Adapter	88-125538

Equipment Applicability

SAILOR 3965 is a simplex/semi-duplex UHF ATEX radiotelephone designed for maritime communication within the frequency range 440 MHz to 470 MHz.

Manufacturer

Thrane & Thrane A/S Lundtoftegårdsvej 93D, DK-2800 Kgs. Lyngby, Denmark
 Industrivej 30, DK- 9490 Pandrup, Denmark

Place and date

Pandrup, 15 March, 2017

 Director Radio and Navigation R&D
 Henrik Kalstrup

CE 0470



Document no.: 99-155708-A

Thrane & Thrane A/S trading as Cobham GATECOM Registered no. DK - 65 72 46 18. Registered address: Lundtoftegårdsvej 93 D, 2800 Kgs. Lyngby, Denmark
 This memo, which may contain confidential information, is intended solely for the use of the individual(s) or organization to whom it is addressed. If you are not the addressee, or the employee or agent responsible for delivering this memo to the addressee, please telephone us as soon as possible and return the memo to us by post. Improper or unauthorized use, disclosure, distribution or copying of this memo is prohibited.

www.cobham.com

Type Examination Certificate

Translation
EU-Type Examination Certificate



- (2) Equipment and protective systems intended for use in potentially explosive atmospheres, **Directive 2014/34/EU**
- (3) **Certificate Number** TÜV 16 ATEX 179791 X **issue:** 01
- (4) for the product: Radio transceiver model TT-3965A
- (5) of the manufacturer: **Thrane & Thrane A/S**
- (6) Address: Industrivej 30
9490 Pandrup
Denmark
- Order number: 8000465358
- Date of issue: 2016-12-13
- (7) The design of this product and any acceptable variation thereto are specified in the schedule to this EU-Type Examination Certificate and the documents therein referred to.
- (8) The TÜV NORD CERT GmbH, Notified Body No. 0044, in accordance with Article 17 of the Directive 2014/34/EU of the European Parliament and the Council of 28 February 2014, certifies that this product has been found to comply with the Essential Health and Safety Requirements relating to the design and construction of products intended for use in potentially explosive atmospheres given in Annex II to the Directive. The examination and test results are recorded in the confidential ATEX Assessment Report No. 16 203 189382.
- (9) Compliance with the Essential Health and Safety Requirements has been assured by compliance with:
EN 60079-0:2012 + A11:2013 EN 60079-11:2012
 except in respect of those requirements listed at item 18 of the schedule.
- (10) If the sign "X" is placed after the certificate number, it indicates that the product is subject to the Specific Conditions for Use specified in the schedule to this certificate.
- (11) This EU-Type Examination Certificate relates only to the design, and construction of the specified product. Further requirements of the Directive apply to the manufacturing process and supply of this equipment. These are not covered by this certificate.
- (12) The marking of the product shall include the following:

II 2 G Ex ib IIB T4

TÜV NORD CERT GmbH, Langemarkstraße 20, 45141 Essen, notified by the central office of the countries for safety engineering (ZfS), Ident. Nr. 0044, legal successor of the TÜV NORD CERT GmbH & Co. KG Ident. Nr. 0032

The deputy head of the notified body

Christian Roder

Hannover office, Am TÜV 1, 30519 Hannover, Tel. +49 511 996-61455, Fax +49 511 996-61590

This certificate may only be reproduced without any change, schedule included.
 Excerpt or changes shall be allowed by the TÜV NORD CERT GmbH

P17-F-011 Rev. 0104.16

page 1/3



(13) **SCHEDULE**

(14) **EU-Type Examination Certificate No. TÜV 16 ATEX 179791 X issue 01**

(15) **Description of product**

The radio transceiver model TT-3965A is designed in the type of protection "Intrinsic Safety" and is intended for the use onboard ships and on land in classified areas Zone 1 and Zone 2. The radio transceiver is a modified version of the radio transceiver SAILOR SP3560 UHF, which is already separately certified with the EC-Type-Examination Certificate TÜV 08 ATEX 353821 X with associated test report No. 08 203 353821.

The supply can be established either from the secondary battery type B3906, secondary battery B3504 or from the primary battery B3503.

The secondary battery B3906 is a modified version of the secondary battery B3504 with a red instead of the blue housing. The charging is only permitted outside the hazardous area with the associated non-ATEX chargers.

Both the primary and the secondary batteries are designed intrinsically safe and may be charged inside the hazardous area.

The primary battery B3503 and the original secondary battery B3504 are already examined within the afore-mentioned EC-Type-Examination Certificate.

Type key:

No further type key

Technical data:

Accessory interface connector.....in type of protection Intrinsic Safety Ex ib IIB
only for the connection to certified intrinsically safe circuits

Maximum values: $U_s = 8.4 \text{ V}$
 $I_s = 450 \text{ mA}$

Long-term output power $P_s = 1.8 \text{ W}$
Rectangular characteristics

$C_s = 150 \text{ nF}$
 $L_s = 10 \text{ }\mu\text{H}$

Permissible range of ambient temperature range:
 $-20 \text{ }^\circ\text{C} \leq T_a \leq +55 \text{ }^\circ\text{C}$

Approved accessories:

Charger CH3505	403505A
Charger CH3507	403507B
Charger CH3508	403508B
UHF Antenna	88-125662
UHF Antenna	62-125662
Lanyard	41-124375
Belt clip	62-124320
Leather case	403500-207
Service cable	403500-958



Schedule to EU-Type Examination Certificate No. TÜV 16 ATEX 179791 X Issue 01

(16) Drawings and documents are listed in the ATEX Assessment Report No. 16 203 189382

(17) Specific Conditions for Use

1. Do not charge the battery in wet or humid environments.
2. Always keep battery connectors dry and clean.
3. Use only with ATEX approved accessories.
Alternatively ATEX approved accessories in compliance with the accessory connector ATEX specification may be used.
4. Do not charge accessories in wet or humid environments.
5. Do not charge the battery in hazardous area.
6. For charge of battery use
Part no: 403505A - ATEX CH3505 Compact Charger,
Part no: 403507B - ATEX CH3507 Single Position Charger or
Part no: 403508B - ATEX CH3508 Dual Position Charger
7. Use only battery type SAILOR B3503, B3504 or B3906.
8. Do not use a mechanically damaged radio.
9. Unpacking of the radio and accessories and the removal of the protective film in front of the display window must not take place in the ATEX protected area.

(18) Essential Health and Safety Requirements

no additional ones

- End of Certificate -

Attention

Gore-tex Membrane

To keep the UHF watertight, it is very important that the Gore-Tex membrane under no circumstances must be damaged/covered or removed.

That is, do not remove the Gore-Tex membrane or place any labels in the area.



