



TI-84 Plus
TI-84 Plus Silver Edition
Guidebook

Important Information

Texas Instruments makes no warranty, either express or implied, including but not limited to any implied warranties of merchantability and fitness for a particular purpose, regarding any programs or book materials and makes such materials available solely on an "as-is" basis. In no event shall Texas Instruments be liable to anyone for special, collateral, incidental, or consequential damages in connection with or arising out of the purchase or use of these materials, and the sole and exclusive liability of Texas Instruments, regardless of the form of action, shall not exceed the purchase price of this product. Moreover, Texas Instruments shall not be liable for any claim of any kind whatsoever against the use of these materials by any other party.

© 2005 Texas Instruments Incorporated

Windows and Macintosh are trademarks of their respective owners.

USA FCC Information Concerning Radio Frequency Interference

This equipment has been tested and found to comply with the limits for a Class B digital device, pursuant to Part 15 of the FCC rules. These limits are designed to provide reasonable protection against harmful interference in a residential installation. This equipment generates, uses, and can radiate radio frequency energy and, if not installed and used in accordance with the instructions, may cause harmful interference to radio communications. However, there is no guarantee that interference will not occur in a particular installation.

If this equipment does cause harmful interference to radio or television reception, which can be determined by turning the equipment off and on, you can try to correct the interference by one or more of the following measures:

- Reorient or relocate the receiving antenna.
- Increase the separation between the equipment and receiver.
- Connect the equipment into an outlet on a circuit different from that to which the receiver is connected.
- Consult the dealer or an experienced radio/television technician for help.

Caution: Any changes or modifications to this equipment not expressly approved by Texas Instruments may void your authority to operate the equipment.

Chapter 1: Operating the TI-84 Plus Silver Edition

Documentation Conventions

In the body of this guidebook, TI-84 Plus refers to the TI-84 Plus Silver Edition. Sometimes, as in Chapter 19, the full name TI-84 Plus Silver Edition is used to distinguish it from the TI-84 Plus.

All the instructions and examples in this guidebook also work for the TI-84 Plus. All the functions of the TI-84 Plus Silver Edition and the TI-84 Plus are the same. The two graphing calculators differ only in available RAM memory, interchangeable faceplates, and Flash application ROM memory.

TI-84 Plus Keyboard

Generally, the keyboard is divided into these zones: graphing keys, editing keys, advanced function keys, and scientific calculator keys.

Keyboard Zones

Graphing — Graphing keys access the interactive graphing features.

Editing — Editing keys allow you to edit expressions and values.

Advanced — Advanced function keys display menus that access the advanced functions.

Scientific — Scientific calculator keys access the capabilities of a standard scientific calculator.

TI-84 Plus

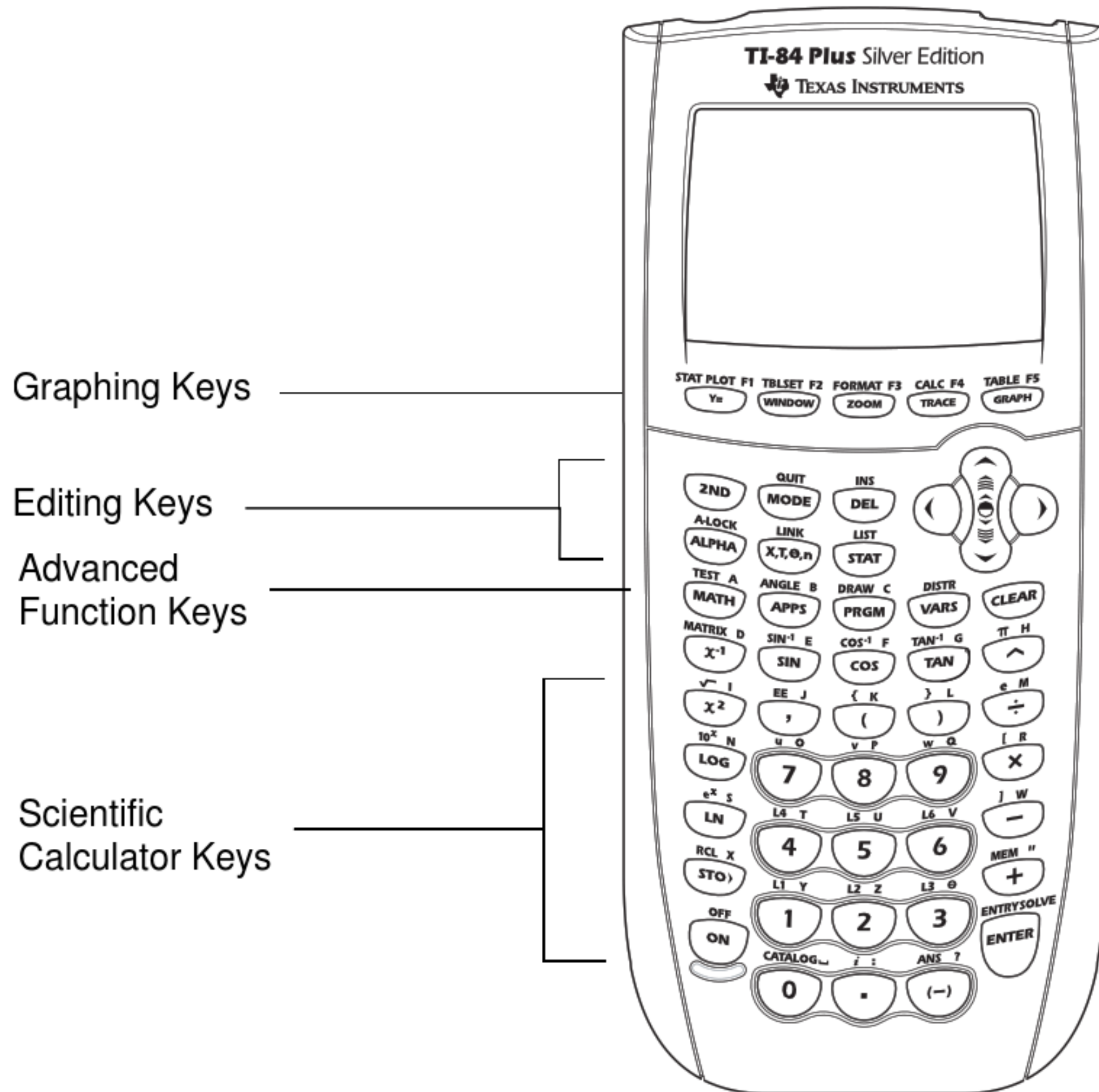

Using the Color-Coded Keyboard

The keys on the TI-84 Plus are color-coded to help you easily locate the key you need.

The light colored keys are the number keys. The light gray keys along the right side of the keyboard are the common math functions. The light gray keys across the top set up and display graphs. The **APPS** key with the purple lettering provides access to applications such as the Inequality Graphing application.

The primary function of each key is printed on the keys. For example, when you press **MATH**, the **MATH** menu is displayed.

Using the **2nd** and **ALPHA** Keys

The secondary function of each key is printed in blue above the key. When you press the blue **2nd** key, the character, abbreviation, or word printed in blue above the other keys becomes active for the next keystroke. For example, when you press **2nd** and then **MATH**, the **TEST** menu is displayed. This guidebook describes this keystroke combination as **2nd** [TEST].

The alpha function of each key is printed in green above the key. When you press the green **ALPHA** key, the alpha character printed in green above the other keys becomes active for the next keystroke. For example, when you press **ALPHA** and then **MATH**, the letter **A** is entered. This guidebook describes this keystroke combination as **ALPHA** [**A**].

The **2nd** key accesses the second function printed in blue above each key.

The **ALPHA** key accesses the alpha function printed in green above each key.

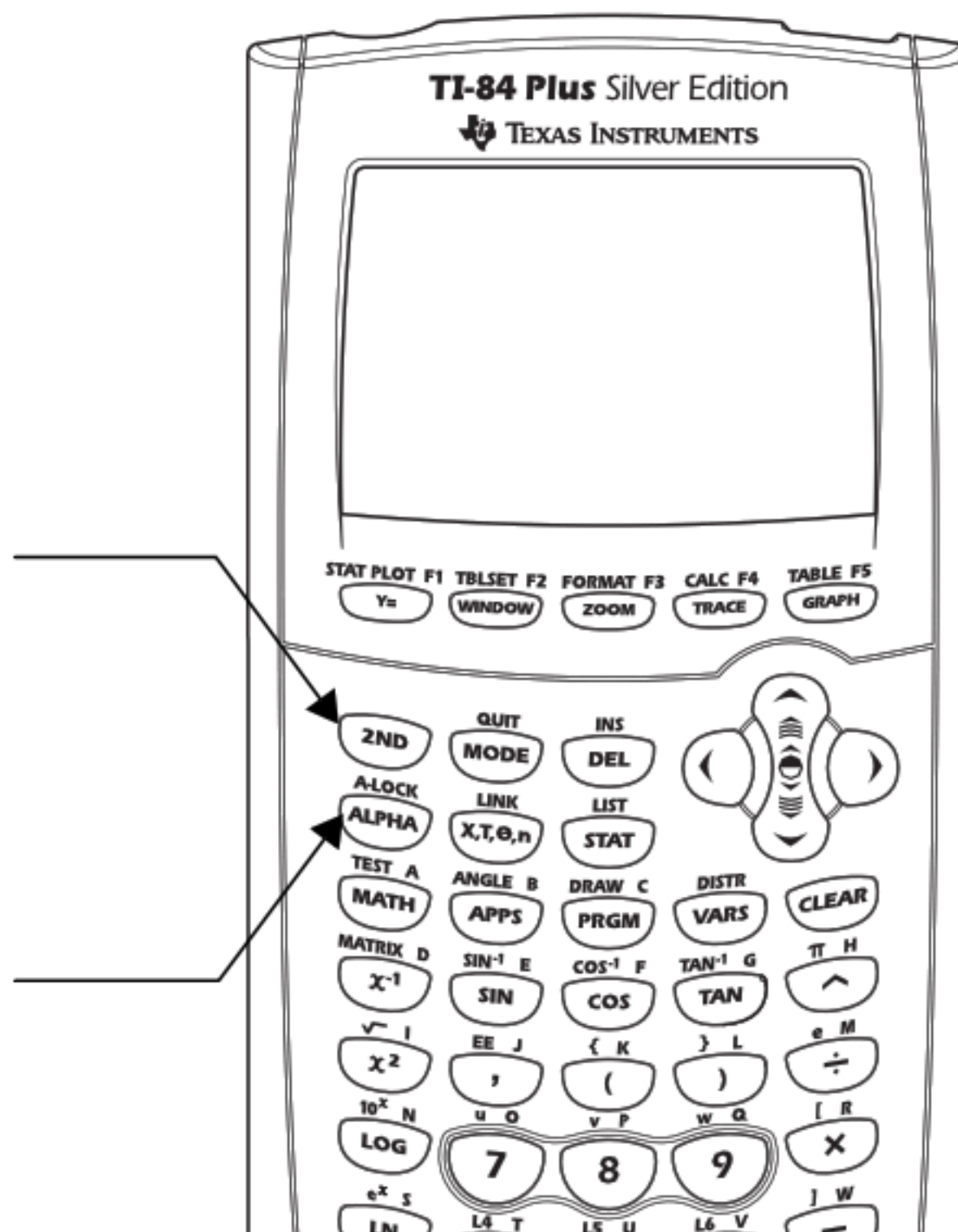

Turning On and Turning Off the TI-84 Plus

Turning On the Graphing Calculator

To turn on the TI-84 Plus, press **ON**.

- If you previously had turned off the graphing calculator by pressing **2nd** [OFF], the TI-84 Plus displays the home screen as it was when you last used it and clears any error.

- If Automatic Power Down™ (APD™) had previously turned off the graphing calculator, the TI-84 Plus will return exactly as you left it, including the display, cursor, and any error.
- If the TI-84 Plus is turned off and connected to another graphing calculator or personal computer, any communication activity will “wake up” the TI-84 Plus.

To prolong the life of the batteries, APD turns off the TI-84 Plus automatically after about five minutes without any activity.

Turning Off the Graphing Calculator

To turn off the TI-84 Plus manually, press **[2nd]** **[OFF]**.

- All settings and memory contents are retained by Constant Memory™.
- Any error condition is cleared.

Batteries

The TI-84 Plus uses five batteries: four AAA alkaline batteries and one SR44SW or 303 silver oxide backup battery. The silver oxide battery provides auxiliary power to retain memory while you replace the AAA batteries. To replace batteries without losing any information stored in memory, follow the steps in Appendix C.

Setting the Display Contrast





Adjusting the Display Contrast

You can adjust the display contrast to suit your viewing angle and lighting conditions. As you change the contrast setting, a number from 0 (lightest) to 9 (darkest) in the top-right corner indicates the current level. You may not be able to see the number if contrast is too light or too dark.

Note: The TI-84 Plus has 40 contrast settings, so each number 0 through 9 represents four settings.

The TI-84 Plus retains the contrast setting in memory when it is turned off.

To adjust the contrast, follow these steps.

1. Press and release the **2nd** key.
2. Press and hold  or , which are below and above the contrast symbol (blue, half-shaded circle).
 -  lightens the screen.
 -  darkens the screen.

Note: If you adjust the contrast setting to 0, the display may become completely blank. To restore the screen, press and release **2nd**, and then press and hold  until the display reappears.

When to Replace Batteries

When the batteries are low, a low-battery message is displayed when you turn on the graphing calculator.

To replace the batteries without losing any information in memory, follow the steps in Appendix C.

Generally, the graphing calculator will continue to operate for one or two weeks after the low-battery message is first displayed. After this period, the TI-84 Plus will turn off automatically and the unit will not operate. Batteries must be replaced. All memory should be retained.

Note: The operating period following the first low-battery message could be longer than two weeks if you use the graphing calculator infrequently.

The Display

Types of Displays

The TI-84 Plus displays both text and graphs. Chapter 3 describes graphs. Chapter 9 describes how the TI-84 Plus can display a horizontally or vertically split screen to show graphs and text simultaneously.

Home Screen

The home screen is the primary screen of the TI-84 Plus. On this screen, enter instructions to execute and expressions to evaluate. The answers are displayed on the same screen.

Displaying Entries and Answers

When text is displayed, the TI-84 Plus screen can display a maximum of 8 lines with a maximum of 16 characters per line. If all lines of the display are full, text scrolls off the top of the display. If an expression on the home screen, the Y= editor (Chapter 3), or the program editor (Chapter 16) is longer than one line, it wraps to the beginning of the next line. In numeric editors such as the window screen (Chapter 3), a long expression scrolls to the right and left.

When an entry is executed on the home screen, the answer is displayed on the right side of the next line.

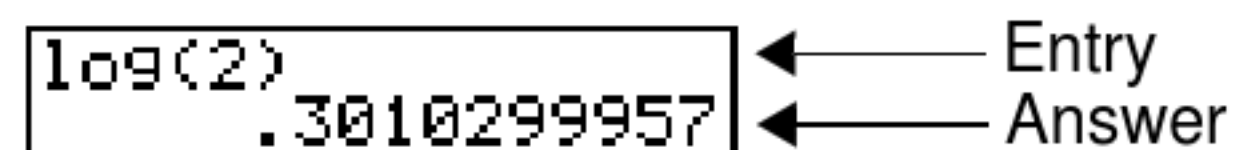

A TI-84 Plus screen showing the entry `log(2)` on the first line and the answer `.3010299957` on the second line. Two arrows point from the text 'Entry' and 'Answer' to the respective lines.

The mode settings control the way the TI-84 Plus interprets expressions and displays answers.

If an answer, such as a list or matrix, is too long to display entirely on one line, an ellipsis (...) is displayed to the right or left. Press `▸` and `◀` to display the answer.

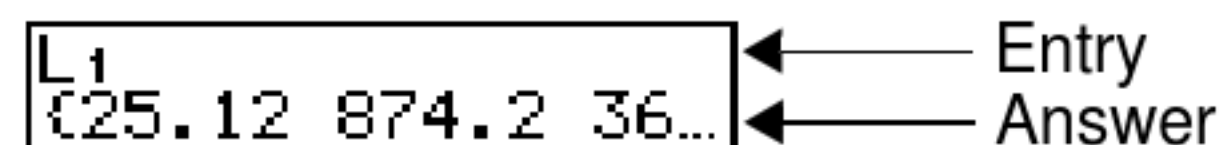

A TI-84 Plus screen showing the entry `L1` on the first line and the answer `{25.12 874.2 36...` on the second line. Two arrows point from the text 'Entry' and 'Answer' to the respective lines.

Returning to the Home Screen

To return to the home screen from any other screen, press `2nd` [QUIT].

Busy Indicator

When the TI-84 Plus is calculating or graphing, a vertical moving line is displayed as a busy indicator in the top-right corner of the screen. When you pause a graph or a program, the busy indicator becomes a vertical moving dotted line.

Display Cursors

In most cases, the appearance of the cursor indicates what will happen when you press the next key or select the next menu item to be pasted as a character.

Cursor	Appearance	Effect of Next Keystroke
Entry	Solid rectangle ■	A character is entered at the cursor; any existing character is overwritten
Insert	Underline —	A character is inserted in front of the cursor location
Second	Reverse arrow ↑	A 2nd character (blue on the keyboard) is entered or a 2nd operation is executed
Alpha	Reverse A Ⓐ	An alpha character (green on the keyboard) is entered or SOLVE is executed
Full	Checkerboard rectangle ■	No entry; the maximum characters are entered at a prompt or memory is full

If you press **ALPHA** during an insertion, the cursor becomes an underlined **A** (**A**). If you press **2nd** during an insertion, the underlined cursor becomes an underlined **↑** (**↑**).

Graphs and editors sometimes display additional cursors, which are described in other chapters.

Interchangeable Faceplates

The TI-84 Plus Silver Edition has interchangeable faceplates that let you customize the appearance of your unit. To purchase additional faceplates, refer to the TI Online Store at education.ti.com.

Removing a Faceplate

1. Lift the tab at the bottom edge of the faceplate away from the TI-84 Plus Silver Edition case.
2. Carefully lift the faceplate away from the unit until it releases. Be careful not to damage the faceplate or the keyboard.

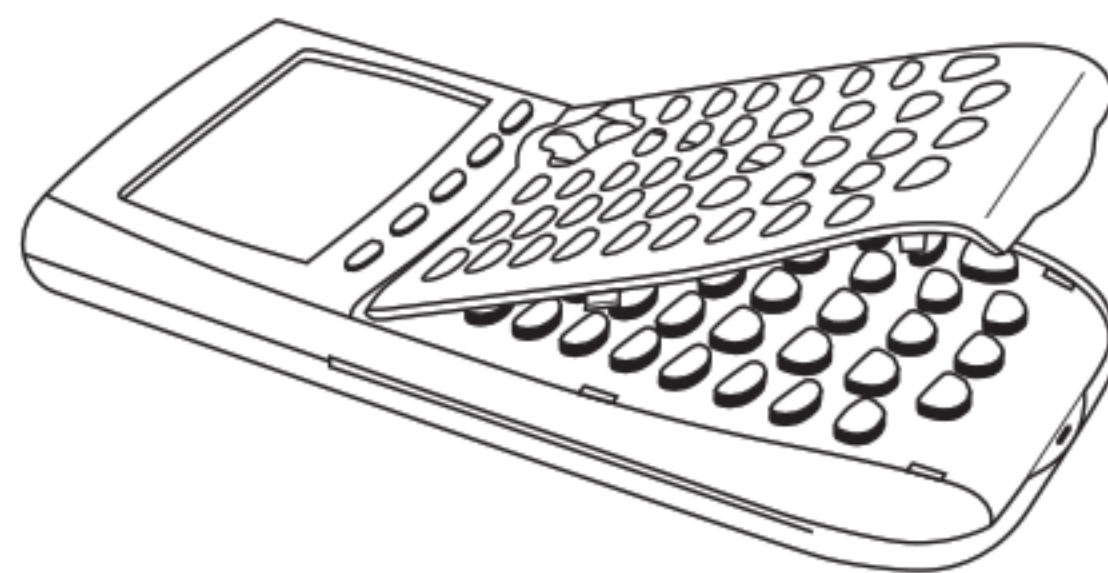

Installing New Faceplates

1. Align the top of the faceplate in the corresponding grooves of the TI-84 Plus Silver Edition case.
2. Gently click the faceplate into place. Do not force.
3. Make sure you gently press each of the grooves to ensure the faceplate is installed properly. See the diagram for proper groove placement.

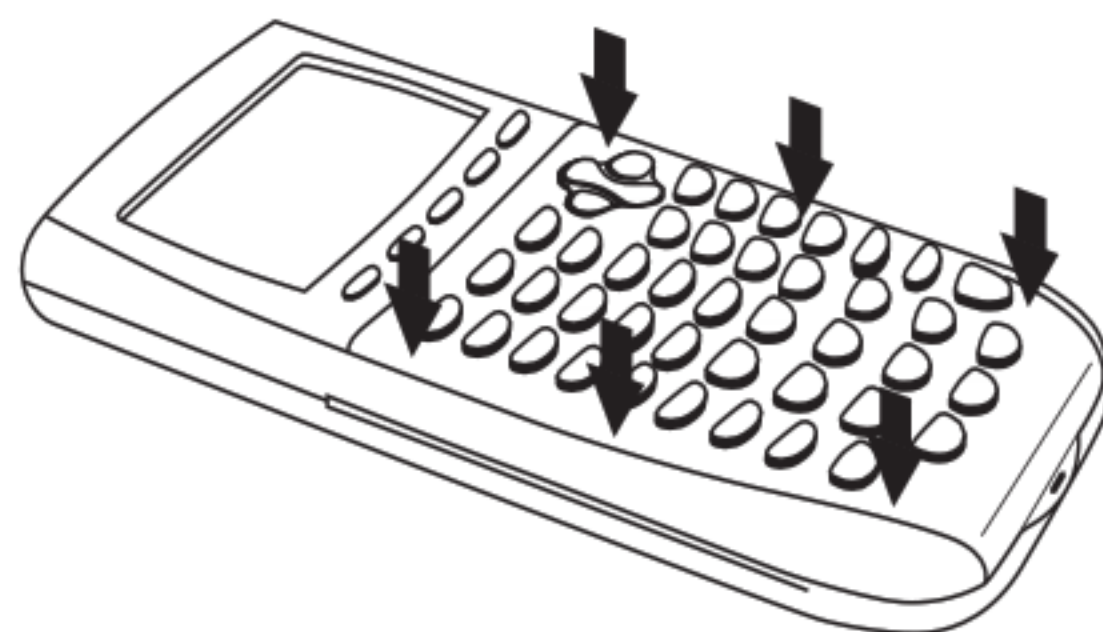
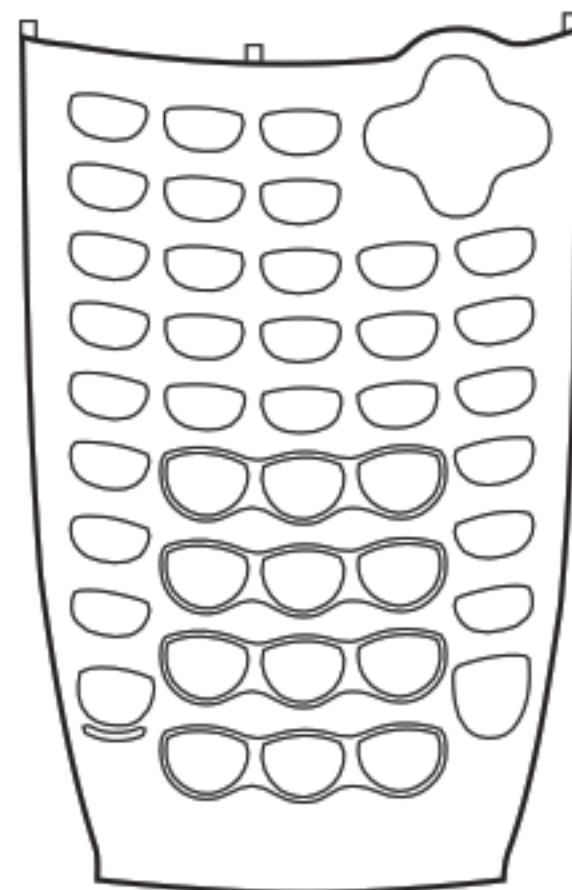

Using the Clock

Use the Clock to set the time and date, select the clock display format, and turn the clock on and off. The clock is turned on by default and is accessed from the mode screen.

Displaying the Clock Settings









1. Press **MODE**.
2. Press the **▼** to move the cursor to **SET CLOCK**.
3. Press **ENTER**.

```
NORMAL SCI ENG
FLOAT 0 1 2 3 4 5 6 7 8 9
RADIAN DEGREE
FUNC PAR POL SEQ
CONNECTED DOT
SEQUENTIAL SIMUL
REAL a+bi re^θi
FULL HORIZ G-T
SETCLOCK03/18/04 2:04PM
```

Changing the Clock settings



1. Press the **▶** or **◀** to highlight the date format you want, example: M/D/Y. Press **ENTER**.
2. Press **▼** to highlight **YEAR**. Press **CLEAR** and type the year, example: 2004.
3. Press **▼** to highlight **MONTH**. Press **CLEAR** and type the number of the month (a number from 1–12).
4. Press **▼** to highlight **DAY**. Press **CLEAR** and type the date.
5. Press **▼** to highlight **TIME**. Press **▶** or **◀** to highlight the time format you want. Press **ENTER**.
6. Press **▼** to highlight **HOUR**. Press **CLEAR** and type the hour. A number from 1–12 or 0–23.

```
FORMAT: M/D/Y D/M/Y Y/M/D
YEAR: 2004
MONTH: 3
DAY: 18
TIME: 12HOUR 24HOUR
HOUR: 2
MINUTE: 37
AM/PM: AM PM
SAVE
```

7. Press  to highlight **MINUTE**. Press  and type the minutes. A number from 0–59.
8. Press  to highlight **AM/PM**. Press  or  to highlight the format. Press .
9. To Save changes, press  to select **SAVE**. Press .

Error Messages

If you type the wrong date for the month, for example: June 31, June does not have 31 days, you will receive an error message with two choices:

- To Quit the Clock application and return to the Home screen, select **1: Quit**. Press .
- or —
- To return to the clock application and correct the error, select **2: Goto**. Press .

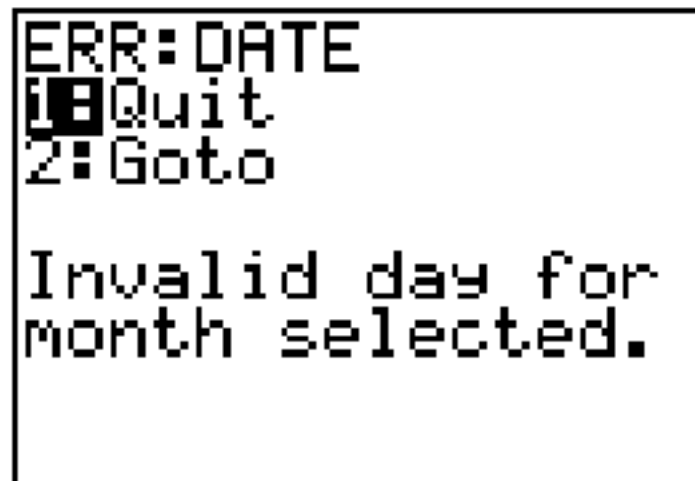

```
ERR:DATE
1:Quit
2:Goto

Invalid day for
month selected.
```

Turning the Clock On

There are two options to turn the clock on. One option is through the **MODE** screen, the other is through the Catalog.

Using the Mode Screen to turn the clock on

1. If the Clock is turned off, Press \downarrow to highlight **TURN CLOCK ON**.
2. Press $\boxed{\text{ENTER}}$ $\boxed{\text{ENTER}}$.

```
NORMAL SCI ENG
FLOAT 0123456789
RADIAN DEGREE
FUNC PAR POL SEQ
CONNECTED DOT
SEQUENTIAL SIMUL
REAL a+bi re^θi
FULL HORIZ G-T
SETCLOCK TURN CLOCK ON
```

Using the Catalog to turn the clock on

1. If the Clock is turned off, Press $\boxed{2\text{nd}}$ [CATALOG]
2. Press \downarrow or \uparrow to scroll the **CATALOG** until the selection cursor points to **ClockOn**.
3. Press $\boxed{\text{ENTER}}$ $\boxed{\text{ENTER}}$.

```
CATALOG M
X²pdf(
X²-Test(
X²GOF-Test(
Circle(
Clear Entries
ClockOff
▶ClockOn
```

Turning the Clock Off

1. Press $\boxed{2\text{nd}}$ [CATALOG].
2. Press \downarrow or \uparrow to scroll the **CATALOG** until the selection cursor points to **ClockOff**.
3. Press $\boxed{\text{ENTER}}$.

```
CATALOG M
X²pdf(
X²-Test(
X²GOF-Test(
Circle(
Clear Entries
▶ClockOff
ClockOn
```

ClockOff will turn off the Clock display.

Entering Expressions and Instructions

What Is an Expression?

An expression is a group of numbers, variables, functions and their arguments, or a combination of these elements. An expression evaluates to a single answer. On the TI-84 Plus, you enter an expression in the same order as you would write it on paper. For example, πR^2 is an expression.

You can use an expression on the home screen to calculate an answer. In most places where a value is required, you can use an expression to enter a value.

```
(1/3)^2
.1111111111
```

```
WINDOW
Xmin=-10
Xmax=2π
```

Entering an Expression

To create an expression, you enter numbers, variables, and functions from the keyboard and menus. An expression is completed when you press **ENTER**, regardless of the cursor location. The entire expression is evaluated according to Equation Operating System (EOS™) rules, and the answer is displayed.

Most TI-84 Plus functions and operations are symbols comprising several characters. You must enter the symbol from the keyboard or a menu; do not spell it out. For example, to calculate the log of 45, you must press **LOG** 45. Do not enter the letters **L**, **O**, and **G**. If you enter **LOG**, the TI-84 Plus interprets the entry as implied multiplication of the variables **L**, **O**, and **G**.

Calculate $3.76 \div (-7.9 + \sqrt{5}) + 2 \log 45$.

3 \square . \square 76 \square \div \square (\square (-) 7 \square . \square 9 \square +
 \square 2nd \square $\sqrt{\square}$ 5 \square) \square) \square + 2 \square LOG 45 \square)
 \square ENTER

3.76/(-7.9+√(5))
+2log(45)
2.642575252

Multiple Entries on a Line

To enter two or more expressions or instructions on a line, separate them with colons ([ALPHA] [:]). All instructions are stored together in last entry (ENTRY).

5 \rightarrow A:2 \rightarrow B:A/B 2.5

Entering a Number in Scientific Notation

To enter a number in scientific notation, follow these steps.

1. Enter the part of the number that precedes the exponent. This value can be an expression.
2. Press \square 2nd \square [EE]. E is pasted to the cursor location.
3. If the exponent is negative, press \square (-), and then enter the exponent, which can be one or two digits.

(19/2)E-2 .095

When you enter a number in scientific notation, the TI-84 Plus does not automatically display answers in scientific or engineering notation. The mode settings and the size of the number determine the display format.

Functions

A function returns a value. For example, \div , $-$, $+$, $\sqrt{\quad}$, and **log**(are the functions in the example on the previous page. In general, the first letter of each function is lowercase on the TI-84 Plus. Most functions take at least one argument, as indicated by an open parenthesis (() following the name. For example, **sin**(requires one argument, **sin**(*value*).

Instructions

An instruction initiates an action. For example, **ClrDraw** is an instruction that clears any drawn elements from a graph. Instructions cannot be used in expressions. In general, the first letter of each instruction name is uppercase. Some instructions take more than one argument, as indicated by an open parenthesis (() at the end of the name. For example, **Circle**(requires three arguments, **Circle**(*X,Y,radius*).

Interrupting a Calculation

To interrupt a calculation or graph in progress, which is indicated by the busy indicator, press **ON**.

When you interrupt a calculation, a menu is displayed.

- To return to the home screen, select **1:Quit**.
- To go to the location of the interruption, select **2:Goto**.

When you interrupt a graph, a partial graph is displayed.

- To return to the home screen, press **CLEAR** or any nongraphing key.
- To restart graphing, press a graphing key or select a graphing instruction.

TI-84 Plus Edit Keys

Keystrokes	Result
▶ or ◀	Moves the cursor within an expression; these keys repeat.
▲ or ▼	Moves the cursor from line to line within an expression that occupies more than one line; these keys repeat. On the top line of an expression on the home screen, ▲ moves the cursor to the beginning of the expression. On the bottom line of an expression on the home screen, ▼ moves the cursor to the end of the expression.
2nd ◀	Moves the cursor to the beginning of an expression.
2nd ▶	Moves the cursor to the end of an expression.
ENTER	Evaluates an expression or executes an instruction.
CLEAR	On a line with text on the home screen, clears the current line. On a blank line on the home screen, clears everything on the home screen. In an editor, clears the expression or value where the cursor is located; it does not store a zero.
DEL	Deletes a character at the cursor; this key repeats.
2nd [INS]	Changes the cursor to an underline (<u> </u>); inserts characters in front of the underline cursor; to end insertion, press 2nd [INS] or press ◀ , ▲ , ▶ , or ▼ .

Keystrokes	Result
$\boxed{2\text{nd}}$	Changes the cursor to \uparrow ; the next keystroke performs a 2nd operation (an operation in blue above a key and to the left); to cancel 2nd , press $\boxed{2\text{nd}}$ again.
$\boxed{\text{ALPHA}}$	Changes the cursor to \rightarrow ; the next keystroke pastes an alpha character (a character in green above a key and to the right) or executes SOLVE (Chapters 10 and 11); to cancel $\boxed{\text{ALPHA}}$, press $\boxed{\text{ALPHA}}$ or press \leftarrow , \uparrow , \rightarrow , or \downarrow .
$\boxed{2\text{nd}}$ $\boxed{\text{A-LOCK}}$	Changes the cursor to \rightarrow ; sets alpha-lock; subsequent keystrokes (on an alpha key) paste alpha characters; to cancel alpha-lock, press $\boxed{\text{ALPHA}}$. If you are prompted to enter a name such as for a group or a program, alpha-lock is set automatically.
$\boxed{X,T,\theta,n}$	Pastes an X in Func mode, a T in Par mode, a θ in Pol mode, or an n in Seq mode with one keystroke.

Setting Modes

Checking Mode Settings

Mode settings control how the TI-84 Plus displays and interprets numbers and graphs. Mode settings are retained by the Constant Memory feature when the TI-84 Plus is turned off. All numbers, including elements of matrices and lists, are displayed according to the current mode settings.

To display the mode settings, press **[MODE]**. The current settings are highlighted. Defaults are highlighted below. The following pages describe the mode settings in detail.

Normal Sci Eng	Numeric notation
Float 0123456789	Number of decimal places
Radian Degree	Unit of angle measure
Func Par Pol Seq	Type of graphing
Connected Dot	Whether to connect graph points
Sequential Simul	Whether to plot simultaneously
Real $a+bi$ re $^{\theta}i$	Real, rectangular complex, or polar complex
Full Horiz G-T	Full screen, two split-screen modes
Set Clock	01/01/01 12:00 AM

Changing Mode Settings

To change mode settings, follow these steps.

1. Press **[↓]** or **[↑]** to move the cursor to the line of the setting that you want to change.
2. Press **[▶]** or **[◀]** to move the cursor to the setting you want.
3. Press **[ENTER]**.

Setting a Mode from a Program

You can set a mode from a program by entering the name of the mode as an instruction; for example, **Func** or **Float**. From a blank program command line, select the mode setting from the mode screen; the instruction is pasted to the cursor location.

```
PROGRAM: TEST
: Func
```

Normal, Sci, Eng

Notation modes only affect the way an answer is displayed on the home screen. Numeric answers can be displayed with up to 10 digits and a two-digit exponent. You can enter a number in any format.

Normal notation mode is the usual way we express numbers, with digits to the left and right of the decimal, as in **12345.67**.

Sci (scientific) notation mode expresses numbers in two parts. The significant digits display with one digit to the left of the decimal. The appropriate power of 10 displays to the right of **E**, as in **1.234567E4**.

Eng (engineering) notation mode is similar to scientific notation. However, the number can have one, two, or three digits before the decimal; and the power-of-10 exponent is a multiple of three, as in **12.34567E3**.

Note: If you select **Normal** notation, but the answer cannot display in 10 digits (or the absolute value is less than .001), the TI-84 Plus expresses the answer in scientific notation.

Float, 0123456789

Float (floating) decimal mode displays up to 10 digits, plus the sign and decimal.

0123456789 (fixed) decimal mode specifies the number of digits (0 through 9) to display to the right of the decimal. Place the cursor on the desired number of decimal digits, and then press **ENTER**.

The decimal setting applies to **Normal**, **Sci**, and **Eng** notation modes.

The decimal setting applies to these numbers:

- An answer displayed on the home screen
- Coordinates on a graph (Chapters 3, 4, 5, and 6)
- The **Tangent**(DRAW instruction equation of the line, x , and dy/dx values (Chapter 8)
- Results of CALCULATE operations (Chapters 3, 4, 5, and 6)
- The regression equation stored after the execution of a regression model (Chapter 12)

Radian, Degree

Angle modes control how the TI-84 Plus interprets angle values in trigonometric functions and polar/rectangular conversions.

Radian mode interprets angle values as radians. Answers display in radians.

Degree mode interprets angle values as degrees. Answers display in degrees.

Func, Par, Pol, Seq

Graphing modes define the graphing parameters. Chapters 3, 4, 5, and 6 describe these modes in detail.

Func (function) graphing mode plots functions, where Y is a function of X (Chapter 3).

Par (parametric) graphing mode plots relations, where X and Y are functions of T (Chapter 4).

Pol (polar) graphing mode plots functions, where r is a function of θ (Chapter 5).

Seq (sequence) graphing mode plots sequences (Chapter 6).

Connected, Dot

Connected plotting mode draws a line connecting each point calculated for the selected functions.

Dot plotting mode plots only the calculated points of the selected functions.

Sequential, Simul

Sequential graphing-order mode evaluates and plots one function completely before the next function is evaluated and plotted.

Simul (simultaneous) graphing-order mode evaluates and plots all selected functions for a single value of X and then evaluates and plots them for the next value of X .

Note: Regardless of which graphing mode is selected, the TI-84 Plus will sequentially graph all stat plots before it graphs any functions.

Real, $a+bi$, $re^{\theta i}$

Real mode does not display complex results unless complex numbers are entered as input.

Two complex modes display complex results.

- **$a+bi$** (rectangular complex mode) displays complex numbers in the form $a+bi$.
- **$re^{\theta i}$** (polar complex mode) displays complex numbers in the form $re^{\theta i}$.

Full, Horiz, G-T

Full screen mode uses the entire screen to display a graph or edit screen.

Each split-screen mode displays two screens simultaneously.

- **Horiz** (horizontal) mode displays the current graph on the top half of the screen; it displays the home screen or an editor on the bottom half (Chapter 9).
- **G-T** (graph-table) mode displays the current graph on the left half of the screen; it displays the table screen on the right half (Chapter 9).

Set Clock

Use the clock to set the time, date, and clock display formats.

Using TI-84 Plus Variable Names

Variables and Defined Items

On the TI-84 Plus you can enter and use several types of data, including real and complex numbers, matrices, lists, functions, stat plots, graph databases, graph pictures, and strings.

The TI-84 Plus uses assigned names for variables and other items saved in memory. For lists, you also can create your own five-character names.

Variable Type	Names
Real numbers	A, B, ... , Z
Complex numbers	A, B, ... , Z
Matrices	[A], [B], [C], ... , [J]
Lists	L1, L2, L3, L4, L5, L6 , and user-defined names
Functions	Y1, Y2, ... , Y9, Y0
Parametric equations	X1T and Y1T, ... , X6T and Y6T
Polar functions	r1, r2, r3, r4, r5, r6
Sequence functions	u, v, w
Stat plots	Plot1, Plot2, Plot3
Graph databases	GDB1, GDB2, ... , GDB9, GDB0
Graph pictures	Pic1, Pic2, ... , Pic9, Pic0
Strings	Str1, Str2, ... , Str9, Str0

Variable Type	Names
Apps	Applications
AppVars	Application variables
Groups	Grouped variables
System variables	Xmin , Xmax , and others

Notes about Variables

- You can create as many list names as memory will allow (Chapter 11).
- Programs have user-defined names and share memory with variables (Chapter 16).
- From the home screen or from a program, you can store to matrices (Chapter 10), lists (Chapter 11), strings (Chapter 15), system variables such as **Xmax** (Chapter 1), **TblStart** (Chapter 7), and all **Y=** functions (Chapters 3, 4, 5, and 6).
- From an editor, you can store to matrices, lists, and **Y=** functions (Chapter 3).
- From the home screen, a program, or an editor, you can store a value to a matrix element or a list element.
- You can use **DRAW STO** menu items to store and recall graph databases and pictures (Chapter 8).
- Although most variables can be archived, system variables including r , t , x , y , and θ cannot be archived (Chapter 18)
- **Apps** are independent applications which are stored in Flash ROM. **AppVars** is a variable holder used to store variables created by independent applications. You cannot edit or change variables in **AppVars** unless you do so through the application which created them.

Storing Variable Values

Storing Values in a Variable

Values are stored to and recalled from memory using variable names. When an expression containing the name of a variable is evaluated, the value of the variable at that time is used.

To store a value to a variable from the home screen or a program using the $\boxed{\text{STO}\blacktriangleright}$ key, begin on a blank line and follow these steps.

1. Enter the value you want to store. The value can be an expression.
2. Press $\boxed{\text{STO}\blacktriangleright}$. \rightarrow is copied to the cursor location.
3. Press $\boxed{\text{ALPHA}}$ and then the letter of the variable to which you want to store the value.
4. Press $\boxed{\text{ENTER}}$. If you entered an expression, it is evaluated. The value is stored to the variable.

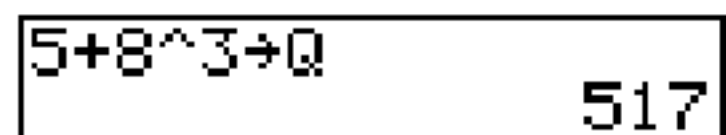

5+8^3→Q 517

Displaying a Variable Value

To display the value of a variable, enter the name on a blank line on the home screen, and then press $\boxed{\text{ENTER}}$.

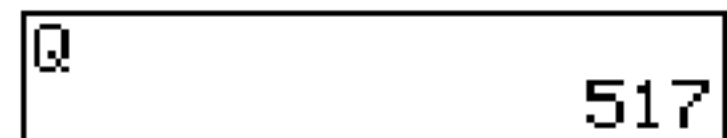

Q 517

Archiving Variables (Archive, Unarchive)

You can archive data, programs, or other variables in a section of memory called user data archive where they cannot be edited or deleted inadvertently. Archived variables are indicated by asterisks (*) to the left of the variable names. Archived variables cannot be edited or executed. They can only be seen and unarchived. For example, if you archive list L1, you will see that L1 exists in memory but if you select it and paste the name L1 to the home screen, you won't be able to see its contents or edit it until they are unarchived.

Recalling Variable Values

Using Recall (RCL)

To recall and copy variable contents to the current cursor location, follow these steps. To leave **RCL**, press **CLEAR**.

1. Press **2nd** **[RCL]**. **RCL** and the edit cursor are displayed on the bottom line of the screen.
2. Enter the name of the variable in any of five ways.
 - Press **[ALPHA]** and then the letter of the variable.
 - Press **2nd** **[LIST]**, and then select the name of the list, or press **2nd** **[L_n]**.
 - Press **2nd** **[MATRIX]**, and then select the name of the matrix.
 - Press **[VARS]** to display the **VAR**S menu or **[VARS]** **[▶]** to display the **VAR**S **Y-VAR**S menu; then select the type and then the name of the variable or function.

- Press **PRGM** **◀**, and then select the name of the program (in the program editor only).

The variable name you selected is displayed on the bottom line and the cursor disappears.

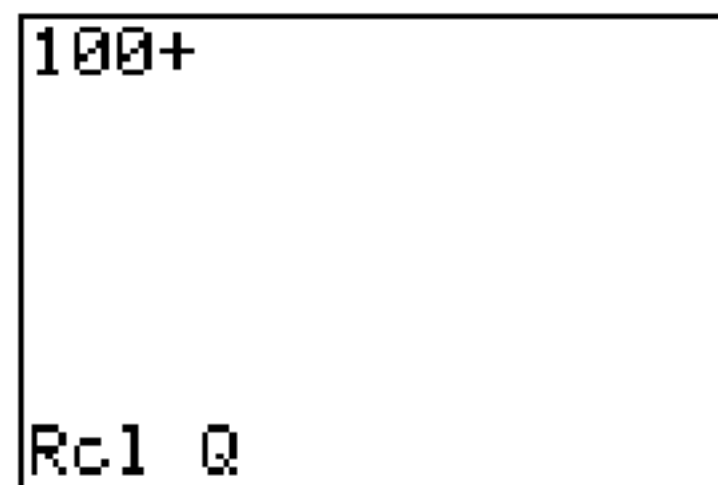

100+
Rc1 0

3. Press **ENTER**. The variable contents are inserted where the cursor was located before you began these steps.



100+517■

Note: You can edit the characters pasted to the expression without affecting the value in memory.

ENTRY (Last Entry) Storage Area

Using ENTRY (Last Entry)

When you press **ENTER** on the home screen to evaluate an expression or execute an instruction, the expression or instruction is placed in a storage area called ENTRY (last entry). When you turn off the TI-84 Plus, ENTRY is retained in memory.

To recall ENTRY, press $\boxed{2\text{nd}} \boxed{\text{ENTRY}}$. The last entry is pasted to the current cursor location, where you can edit and execute it. On the home screen or in an editor, the current line is cleared and the last entry is pasted to the line.

Because the TI-84 Plus updates ENTRY only when you press $\boxed{\text{ENTER}}$, you can recall the previous entry even if you have begun to enter the next expression.

5 $\boxed{+}$ 7
 $\boxed{\text{ENTER}}$
 $\boxed{2\text{nd}} \boxed{\text{ENTRY}}$

5+7	12
5+7■	

Accessing a Previous Entry

The TI-84 Plus retains as many previous entries as possible in ENTRY, up to a capacity of 128 bytes. To scroll those entries, press $\boxed{2\text{nd}} \boxed{\text{ENTRY}}$ repeatedly. If a single entry is more than 128 bytes, it is retained for ENTRY, but it cannot be placed in the ENTRY storage area.

1 $\boxed{\text{STO}}$ $\boxed{\text{ALPHA}}$ **A**
 $\boxed{\text{ENTER}}$
2 $\boxed{\text{STO}}$ $\boxed{\text{ALPHA}}$ **B**
 $\boxed{\text{ENTER}}$
 $\boxed{2\text{nd}} \boxed{\text{ENTRY}}$

1→A	1
2→B	2
2→B■	

If you press $\boxed{2\text{nd}} \boxed{\text{ENTRY}}$ after displaying the oldest stored entry, the newest stored entry is displayed again, then the next-newest entry, and so on.

$\boxed{2\text{nd}} \boxed{\text{ENTRY}}$

1→A	1
2→B	2
1→A■	

Reexecuting the Previous Entry

After you have pasted the last entry to the home screen and edited it (if you chose to edit it), you can execute the entry. To execute the last entry, press $\boxed{\text{ENTER}}$.

To reexecute the displayed entry, press $\boxed{\text{ENTER}}$ again. Each reexecution displays an answer on the right side of the next line; the entry itself is not redisplayed.

$0 \boxed{\text{STO}} \boxed{\text{ALPHA}} \boxed{N}$

$\boxed{\text{ENTER}}$

$\boxed{\text{ALPHA}} \boxed{N} \boxed{+} \boxed{1} \boxed{\text{STO}} \boxed{\text{ALPHA}} \boxed{N}$

$\boxed{\text{ALPHA}} \boxed{:} \boxed{\text{ALPHA}} \boxed{N} \boxed{x^2} \boxed{\text{ENTER}}$

$\boxed{\text{ENTER}}$

$\boxed{\text{ENTER}}$

0→N	0
N+1→N:N ²	1
	4
	9

Multiple Entry Values on a Line

To store to ENTRY two or more expressions or instructions, separate each expression or instruction with a colon, then press $\boxed{\text{ENTER}}$. All expressions and instructions separated by colons are stored in ENTRY.

When you press $\boxed{2\text{nd}} \boxed{[\text{ENTRY}]}$, all the expressions and instructions separated by colons are pasted to the current cursor location. You can edit any of the entries, and then execute all of them when you press $\boxed{[\text{ENTER}]}$.

For the equation $A=\pi r^2$, use trial and error to find the radius of a circle that covers 200 square centimeters. Use 8 as your first guess.

$\boxed{8} \boxed{[\text{STO}\blacktriangleright]} \boxed{[\text{ALPHA}]} \boxed{R} \boxed{[\text{ALPHA}]} \boxed{[:]}$
 $\boxed{2\text{nd}} \boxed{[\pi]} \boxed{[\text{ALPHA}]} \boxed{R} \boxed{[x^2]} \boxed{[\text{ENTER}]}$
 $\boxed{2\text{nd}} \boxed{[\text{ENTRY}]}$

```
8→R:πR²
      201.0619298
8→R:πR²■
```

$\boxed{2\text{nd}} \boxed{[\leftarrow]} \boxed{7} \boxed{2\text{nd}} \boxed{[\text{INS}]} \boxed{.} \boxed{95}$
 $\boxed{[\text{ENTER}]}$

```
8→R:πR²
      201.0619298
7.95→R:πR²
      198.5565097
```

Continue until the answer is as accurate as you want.

Clearing ENTRY

Clear Entries (Chapter 18) clears all data that the TI-84 Plus is holding in the **ENTRY** storage area.

Using Ans in an Expression

When an expression is evaluated successfully from the home screen or from a program, the TI-84 Plus stores the answer to a storage area called **Ans** (last answer). **Ans** may be a real or complex number, a list, a matrix, or a string. When you turn off the TI-84 Plus, the value in **Ans** is retained in memory.

You can use the variable **Ans** to represent the last answer in most places. Press $\boxed{2\text{nd}} \boxed{[\text{ANS}]}$ to copy the variable name **Ans** to the cursor location. When the expression is evaluated, the TI-84 Plus uses the value of **Ans** in the calculation.

Calculate the area of a garden plot 1.7 meters by 4.2 meters. Then calculate the yield per square meter if the plot produces a total of 147 tomatoes.

1 $\boxed{.}$ 7 $\boxed{\times}$ 4 $\boxed{.}$ 2

$\boxed{\text{ENTER}}$

147 $\boxed{\div}$ $\boxed{2\text{nd}} \boxed{[\text{ANS}]}$

$\boxed{\text{ENTER}}$

1.7*4.2	7.14
147/Ans	20.58823529

Continuing an Expression

You can use **Ans** as the first entry in the next expression without entering the value again or pressing $\boxed{2\text{nd}} \boxed{[\text{ANS}]}$. On a blank line on the home screen, enter the function. The TI-84 Plus pastes the variable name **Ans** to the screen, then the function.

5 $\boxed{\div}$ 2

$\boxed{\text{ENTER}}$

$\boxed{\times}$ 9 $\boxed{.}$ 9

$\boxed{\text{ENTER}}$

5/2	2.5
Ans*9.9	24.75

Storing Answers

To store an answer, store **Ans** to a variable before you evaluate another expression.

Calculate the area of a circle of radius 5 meters. Next, calculate the volume of a cylinder of radius 5 meters and height 3.3 meters, and then store the result in the variable V.

```
[2nd] [π] 5 [x2]  
[ENTER]  
[×] 3 [.] 3  
[ENTER]  
[STO▶] [ALPHA] V  
[ENTER]
```

```
π52  
78.53981634  
Ans*3.  
259.1813939  
Ans→V  
259.1813939
```

TI-84 Plus Menus

Using a TI-84 Plus Menu

You can access most TI-84 Plus operations using menus. When you press a key or key combination to display a menu, one or more menu names appear on the top line of the screen.

- The menu name on the left side of the top line is highlighted. Up to seven items in that menu are displayed, beginning with item 1, which also is highlighted.
- A number or letter identifies each menu item's place in the menu. The order is 1 through 9, then 0, then A, B, C, and so on. The **LIST NAMES**, **PRGM EXEC**, and **PRGM EDIT** menus only label items 1 through 9 and 0.
- When the menu continues beyond the displayed items, a down arrow (↓) replaces the colon next to the last displayed item.
- When a menu item ends in an ellipsis (...), the item displays a secondary menu or editor when you select it.

- When an asterisk (*) appears to the left of a menu item, that item is stored in user data archive (Chapter 18).

```
RAM FREE    22494
ARC FREE    851076
  Pic1      767
 *Pic2      767
  L1        12
 *L2        12
 ▶*L3       12
```

To display any other menu listed on the top line, press \rightarrow or \leftarrow until that menu name is highlighted. The cursor location within the initial menu is irrelevant. The menu is displayed with the cursor on the first item.

Displaying a Menu

While using your TI-84 Plus, you often will need to access items from its menus.

```
5+9
```



When you press a key that displays a menu, that menu temporarily replaces the screen where you are working. For example, when you press $\boxed{\text{MATH}}$, the **MATH** menu is displayed as a full screen.

```
MATH NUM CPX PRB
1: ▸Frac
2: ▸Dec
3: 3
4: 3√(
5: *√
6: fMin(
7: ↓fMax(
```

After you select an item from a menu, the screen where you are working usually is displayed again.

```
5+9³
```







Moving from One Menu to Another



Some keys access more than one menu. When you press such a key, the names of all accessible menus are displayed on the top line. When you highlight a menu name, the items in that menu are displayed. Press  and  to highlight each menu name.

```
MATH  CPX PRB  
1: abs(  
2: round(  
3: iPart(  
4: fPart(  
5: int(  
6: min(  
7: max(  
↓
```

Scrolling a Menu

To scroll down the menu items, press . To scroll up the menu items, press .

To page down six menu items at a time, press  . To page up six menu items at a time, press  . The green arrows on the graphing calculator, between  and , are the page-down and page-up symbols.

To wrap to the last menu item directly from the first menu item, press . To wrap to the first menu item directly from the last menu item, press .

Selecting an Item from a Menu

You can select an item from a menu in either of two ways.

- Press the number or letter of the item you want to select. The cursor can be anywhere on the menu, and the item you select need not be displayed on the screen.

```
MATH [MATH] CPX PRB
1: abs(
2: round(
3: iPart(
4: fPart(
5: int(
6: min(
7: max(
```

- Press \downarrow or \uparrow to move the cursor to the item you want, and then press ENTER .

```
MATH [MATH] CPX PRB
3: iPart(
4: fPart(
5: int(
6: min(
7: max(
8: lcm(
9: gcd(
```

After you select an item from a menu, the TI-84 Plus typically displays the previous screen.

Note: On the **LIST NAMES**, **PRGM EXEC**, and **PRGM EDIT** menus, only items 1 through 9 and 0 are labeled in such a way that you can select them by pressing the appropriate number key. To move the cursor to the first item beginning with any alpha character or θ , press the key combination for that alpha character or θ . If no items begin with that character, the cursor moves beyond it to the next item.

Calculate $\sqrt[3]{27}$.

MATH \downarrow \downarrow \downarrow ENTER
27 $\text{)} \text{ENTER}$

```
 $\sqrt[3]{(27)}$  3
```

Leaving a Menu without Making a Selection

You can leave a menu without making a selection in any of four ways.

- Press $\boxed{2\text{nd}}$ $\boxed{[\text{QUIT}]}$ to return to the home screen.
- Press $\boxed{[\text{CLEAR}]}$ to return to the previous screen.
- Press a key or key combination for a different menu, such as $\boxed{[\text{MATH}]}$ or $\boxed{2\text{nd}}$ $\boxed{[\text{LIST}]}$.
- Press a key or key combination for a different screen, such as $\boxed{[\text{Y=}]}$ or $\boxed{2\text{nd}}$ $\boxed{[\text{TABLE}]}$.

VARS and VARS Y-VARS Menus

VARS Menu

You can enter the names of functions and system variables in an expression or store to them directly.

To display the **VARS** menu, press $\boxed{[\text{VARS}]}$. All **VARS** menu items display secondary menus, which show the names of the system variables. **1:Window**, **2:Zoom**, and **5:Statistics** each access more than one secondary menu.

VARS Y-VARS

1: Window...	X/Y , T/θ , and U/V/W variables
2: Zoom...	ZX/ZY , ZT/Zθ , and ZU variables

VARs Y-VARS

3: GDB...	Graph database variables
4: Picture...	Picture variables
5: Statistics...	XY , Σ , EQ , TEST , and PTS variables
6: Table...	TABLE variables
7: String...	String variables

Selecting a Variable from the VARs Menu or VARs Y-VARS Menu

To display the **VARs Y-VARS** menu, press $\boxed{\text{VARs}}$ \blacktriangleright . **1:Function**, **2:Parametric**, and **3:Polar** display secondary menus of the Y= function variables.

VARs Y-VARS

1: Function...	Y_n functions
2: Parametric...	X_nT , Y_nT functions
3: Polar...	r_n functions
4: On/Off...	Lets you select/deselect functions

Note: The sequence variables (**u**, **v**, **w**) are located on the keyboard as the second functions of $\boxed{7}$, $\boxed{8}$, and $\boxed{9}$.

To select a variable from the **VARs** or **VARs Y-VARS** menu, follow these steps.

1. Display the **VARs** or **VARs Y-VARS** menu.
 - Press $\boxed{\text{VARs}}$ to display the **VARs** menu.

- Press **VAR** \blacktriangleright to display the **VAR** **Y-VAR** menu.
2. Select the type of variable, such as **2:Zoom** from the **VAR** menu or **3:Polar** from the **VAR** **Y-VAR** menu. A secondary menu is displayed.
 3. If you selected **1:Window**, **2:Zoom**, or **5:Statistics** from the **VAR** menu, you can press \blacktriangleright or \blacktriangleleft to display other secondary menus.
 4. Select a variable name from the menu. It is pasted to the cursor location.

Equation Operating System (EOS™)

Order of Evaluation

The Equation Operating System (EOS) defines the order in which functions in expressions are entered and evaluated on the TI-84 Plus. EOS lets you enter numbers and functions in a simple, straightforward sequence.

EOS evaluates the functions in an expression in this order.

Order Number	Function
1	Functions that precede the argument, such as $\sqrt{}$, sin (, or log (
2	Functions that are entered after the argument, such as 2 , $^{-1}$, $!$, $^\circ$, r , and conversions
3	Powers and roots, such as 2^5 or 5^x√32
4	Permutations (nPr) and combinations (nCr)
5	Multiplication, implied multiplication, and division
6	Addition and subtraction

Order Number	Function
7	Relational functions, such as $>$ or \leq
8	Logic operator and
9	Logic operators or and xor

Note: Within a priority level, EOS evaluates functions from left to right. Calculations within parentheses are evaluated first.

Implied Multiplication

The TI-84 Plus recognizes implied multiplication, so you need not press \times to express multiplication in all cases. For example, the TI-84 Plus interprets 2π , $4\sin(46)$, $5(1+2)$, and $(2*5)7$ as implied multiplication.

Note: TI-84 Plus implied multiplication rules, although like the TI-83, differ from those of the TI-82. For example, the TI-84 Plus evaluates $1/2X$ as $(1/2)*X$, while the TI-82 evaluates $1/2X$ as $1/(2*X)$ (Chapter 2).

Parentheses

All calculations inside a pair of parentheses are completed first. For example, in the expression $4(1+2)$, EOS first evaluates the portion inside the parentheses, $1+2$, and then multiplies the answer, 3, by 4.

$4*1+2$	6
$4(1+2)$	12

You can omit the close parenthesis () at the end of an expression. All open parenthetical elements are closed automatically at the end of an expression. This is also true for open parenthetical elements that precede the store or display-conversion instructions.

Note: An open parenthesis following a list name, matrix name, or Y= function name does not indicate implied multiplication. It specifies elements in the list (Chapter 11) or matrix (Chapter 10) and specifies a value for which to solve the Y= function.

Negation

To enter a negative number, use the negation key. Press $\boxed{-}$ and then enter the number. On the TI-84 Plus, negation is in the third level in the EOS hierarchy. Functions in the first level, such as squaring, are evaluated before negation.

For example, $-X^2$, evaluates to a negative number (or 0). Use parentheses to square a negative number.

-2^2	-4	$2 \rightarrow A$	2
$(-2)^2$	4	$-A^2$	-4
		$(-A)^2$	4

Note: Use the $\boxed{-}$ key for subtraction and the $\boxed{(-)}$ key for negation. If you press $\boxed{-}$ to enter a negative number, as in $9 \times \boxed{-} 7$, or if you press $\boxed{(-)}$ to indicate subtraction, as in $9 \boxed{(-)} 7$, an error occurs. If you press $\boxed{\text{ALPHA}} \mathbf{A} \boxed{(-)} \boxed{\text{ALPHA}} \mathbf{B}$, it is interpreted as implied multiplication ($\mathbf{A} * \mathbf{-B}$).

Special Features of the TI-84 Plus

Flash – Electronic Upgradability

The TI-84 Plus uses Flash technology, which lets you upgrade to future software versions without buying a new graphing calculator.

As new functionality becomes available, you can electronically upgrade your TI-84 Plus from the Internet. Future software versions include maintenance upgrades that will be released free of charge, as well as new applications and major software upgrades that will be available for purchase from the TI Web site: education.ti.com

For details, refer to: Chapter 19

1.5 Megabytes (M) of Available Memory

1.5 M of available memory are built into the TI-84 Plus Silver Edition, and .5 M for the TI-84 Plus. About 24 kilobytes (K) of RAM (random access memory) are available for you to compute and store functions, programs, and data.

About 1.5 M of user data archive allow you to store data, programs, applications, or any other variables to a safe location where they cannot be edited or deleted inadvertently. You can also free up RAM by archiving variables to user data.

For details, refer to: Chapter 18

Applications

Applications can be installed to customize the TI-84 Plus to your classroom needs. The big 1.5 M archive space lets you store up to 94 applications at one time. Applications can also be stored on a computer for later use or linked unit-to-unit. There are 30 App slots for the TI-84 Plus.

For details, refer to: Chapter 18

Archiving

You can store variables in the TI-84 Plus user data archive, a protected area of memory separate from RAM. The user data archive lets you:

- Store data, programs, applications or any other variables to a safe location where they cannot be edited or deleted inadvertently.
- Create additional free RAM by archiving variables.

By archiving variables that do not need to be edited frequently, you can free up RAM for applications that may require additional memory.

For details, refer to: Chapter 18

Other TI-84 Plus Features

The TI-84 Plus guidebook that is included with your graphing calculator has introduced you to basic TI-84 Plus operations. This guidebook covers the other features and capabilities of the TI-84 Plus in greater detail.

Graphing

You can store, graph, and analyze up to 10 functions, up to six parametric functions, up to six polar functions, and up to three sequences. You can use DRAW instructions to annotate graphs.

The graphing chapters appear in this order: Function, Parametric, Polar, Sequence, and DRAW.

For graphing details, refer to: Chapters 3, 4, 5, 6, 8

Sequences

You can generate sequences and graph them over time. Or, you can graph them as web plots or as phase plots.

For details, refer to: Chapter 6

Tables

You can create function evaluation tables to analyze many functions simultaneously.

For details, refer to: Chapter 7

Split Screen

You can split the screen horizontally to display both a graph and a related editor (such as the Y= editor), the table, the stat list editor, or the home screen. Also, you can split the screen vertically to display a graph and its table simultaneously.

For details, refer to: Chapter 9

Matrices

You can enter and save up to 10 matrices and perform standard matrix operations on them.

For details, refer to: Chapter 10

Lists

You can enter and save as many lists as memory allows for use in statistical analyses. You can attach formulas to lists for automatic computation. You can use lists to evaluate expressions at multiple values simultaneously and to graph a family of curves.

For details, refer to: Chapter 11

Statistics

You can perform one- and two-variable, list-based statistical analyses, including logistic and sine regression analysis. You can plot the data as a histogram, xyLine, scatter plot, modified or regular box-and-whisker plot, or normal probability plot. You can define and store up to three stat plot definitions.

For details, refer to: Chapter 12

Inferential Statistics

You can perform 16 hypothesis tests and confidence intervals and 15 distribution functions. You can display hypothesis test results graphically or numerically.

For details, refer to: Chapter 13

Applications

Press **APPS** to see the complete list of applications that came with your graphing calculator.

Documentation for TI Flash applications are on the product CD. Visit education.ti.com/calc/guides for additional Flash application guidebooks.

For details, refer to: Chapter 14

CATALOG

The CATALOG is a convenient, alphabetical list of all functions and instructions on the TI-84 Plus. You can paste any function or instruction from the CATALOG to the current cursor location.

For details, refer to: Chapter 15

Programming

You can enter and store programs that include extensive control and input/output instructions.

For details, refer to: Chapter 16

Archiving

Archiving allows you to store data, programs, or other variables to user data archive where they cannot be edited or deleted inadvertently. Archiving also allows you to free up RAM for variables that may require additional memory.

Archived variables are indicated by asterisks (*) to the left of the variable names.

NAME	MATH	EDIT
1: [A]	3x3	
2: [B]	3x5	
3: *[C]	9x9	
4: [D]	2x3	
5: [E]		
6: [F]		
7: [G]		

For details, refer to: Chapter 16

Communication Link

The TI-84 Plus has a USB port using a USB unit-to-unit cable to connect and communicate with another TI-84 Plus or TI-84 Plus Silver Edition. The TI-84 Plus also has an I/O port using an I/O unit-to-unit cable to communicate with a TI-84 Plus Silver Edition, a TI-84 Plus, a TI-83 Plus Silver Edition, a TI-83 Plus, a TI-83, a TI-82, a TI-73, CBL 2™, or a CBR™ System.

With TI Connect™ software and a USB computer cable, you can also link the TI-84 Plus to a personal computer.

As future software upgrades become available on the TI Web site, you can download the software to your PC and then use the TI Connect™ software and a USB computer cable to upgrade your TI-84 Plus.

For details, refer to: Chapter 19

Error Conditions

Diagnosing an Error

The TI-84 Plus detects errors while performing these tasks.

- Evaluating an expression
- Executing an instruction
- Plotting a graph
- Storing a value

When the TI-84 Plus detects an error, it returns an error message as a menu title, such as `ERR:SYNTAX` or `ERR:DOMAIN`. Appendix B describes each error type and possible reasons for the error.

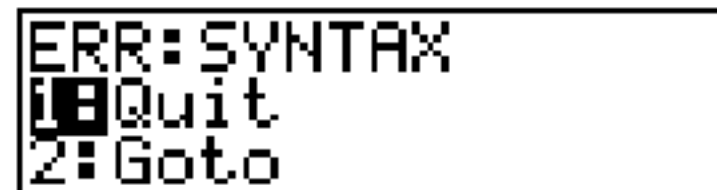
A screenshot of a TI-84 Plus error message menu. The text is displayed in a monospaced font within a rectangular border. The first line reads "ERR:SYNTAX". The second line shows "1:Quit" with a cursor (a small vertical bar) positioned to the left of the number "1". The third line shows "2:Goto".

```
ERR:SYNTAX
1:Quit
2:Goto
```

- If you select **1:Quit** (or press `2nd` [QUIT] or [CLEAR]), then the home screen is displayed.
- If you select **2:Goto**, then the previous screen is displayed with the cursor at or near the error location.

Note: If a syntax error occurs in the contents of a Y= function during program execution, then the **Goto** option returns to the Y= editor, not to the program.

Correcting an Error

To correct an error, follow these steps.

1. Note the error type (`ERR:error type`).
2. Select **2:Goto**, if it is available. The previous screen is displayed with the cursor at or near the error location.
3. Determine the error. If you cannot recognize the error, refer to Appendix B.
4. Correct the expression.

Chapter 2: Math, Angle, and Test Operations

Getting Started: Coin Flip

Getting Started is a fast-paced introduction. Read the chapter for details.

Suppose you want to model flipping a fair coin 10 times. You want to track how many of those 10 coin flips result in heads. You want to perform this simulation 40 times. With a fair coin, the probability of a coin flip resulting in heads is 0.5 and the probability of a coin flip resulting in tails is 0.5.

1. Begin on the home screen. Press **MATH** \leftarrow to display the **MATH PRB** menu. Press **7** to select **7:randBin(** (random Binomial). **randBin(** is pasted to the home screen. Press **10** to enter the number of coin flips. Press **,**. Press **.** **5** to enter the probability of heads. Press **,**. Press **40** to enter the number of simulations. Press **)**.
2. Press **ENTER** to evaluate the expression. A list of 40 elements is generated with the first 7 displayed. The list contains the count of heads resulting from each set of 10 coin flips. The list has 40 elements because this simulation was performed 40 times. In this example, the coin came up heads five times in the first set of 10 coin flips, five times in the second set of 10 coin flips, and so on.

```
randBin(10,.5,40  
)
```

```
randBin(10,.5,40  
)  
{5 5 7 4 6 6 3 ...
```

3. Press \rightarrow or \leftarrow to view the additional counts in the list. Ellipses (...) indicate that the list continues beyond the screen.

4. Press $\text{STO} \rightarrow$ 2^{nd} $[L1]$ ENTER to store the data to the list name **L1**. You then can use the data for another activity, such as plotting a histogram (Chapter 12).

Note: Since **randBin()** generates random numbers, your list elements may differ from those in the example.

```
randBin(10,.5,40
)
{5 5 7 4 6 6 3 ...
Ans→L1
{5 5 7 4 6 6 3 ...
```

```
randBin(10,.5,40
)
{5 5 7 4 6 6 3 ...
Ans→L1
...2 5 3 6 5 7 5 ...
```

Keyboard Math Operations

Using Lists with Math Operations

Math operations that are valid for lists return a list calculated element by element. If you use two lists in the same expression, they must be the same length.

```
{1,2}+{3,4}+5
{9 11}
```

Addition, Subtraction, Multiplication, Division

You can use + (addition, $\boxed{+}$), - (subtraction, $\boxed{-}$), * (multiplication, $\boxed{\times}$), and / (division, $\boxed{\div}$) with real and complex numbers, expressions, lists, and matrices. You cannot use / with matrices.

$valueA + valueB$

$valueA - valueB$

$valueA * valueB$

$valueA / valueB$

Trigonometric Functions

You can use the trigonometric (trig) functions (sine, \boxed{SIN} ; cosine, \boxed{COS} ; and tangent, \boxed{TAN}) with real numbers, expressions, and lists. The current angle mode setting affects interpretation. For example, **sin(30)** in Radian mode returns -.9880316241; in Degree mode it returns .5.

sin(*value*)

cos(*value*)

tan(*value*)

You can use the inverse trig functions (arcsine, $\boxed{2nd} \boxed{[SIN^{-1}]}$; arccosine, $\boxed{2nd} \boxed{[COS^{-1}]}$; and arctangent, $\boxed{2nd} \boxed{[TAN^{-1}]}$) with real numbers, expressions, and lists. The current angle mode setting affects interpretation.

sin⁻¹(*value*)

cos⁻¹(*value*)

tan⁻¹(*value*)

Note: The trig functions do not operate on complex numbers.

Power, Square, Square Root

You can use \wedge (power, $\boxed{\wedge}$), 2 (square, $\boxed{x^2}$), and $\sqrt{}$ (square root, $\boxed{2nd}$ $\boxed{\sqrt{}}$) with real and complex numbers, expressions, lists, and matrices. You cannot use $\sqrt{}$ with matrices.

$value^{\wedge}power$

$value^2$

\sqrt{value}

Inverse

You can use $^{-1}$ (inverse, $\boxed{x^{-1}}$) with real and complex numbers, expressions, lists, and matrices. The multiplicative inverse is equivalent to the reciprocal, $1/x$.

$value^{-1}$

$\boxed{5^{-1}} \quad .2$

log(, 10^(, ln(

You can use **log**((logarithm, \boxed{LOG}), **10^**((power of 10, $\boxed{2nd}$ $\boxed{[10^x]}$), and **ln**((natural log, \boxed{LN}) with real or complex numbers, expressions, and lists.

log($value$)

10^($power$)

ln($value$)

Exponential

e^{\wedge} (exponential, $\boxed{2\text{nd}}$ $\boxed{[e^x]}$) returns the constant e raised to a power. You can use e^{\wedge} with real or complex numbers, expressions, and lists.

$e^{\wedge}(\text{power})$

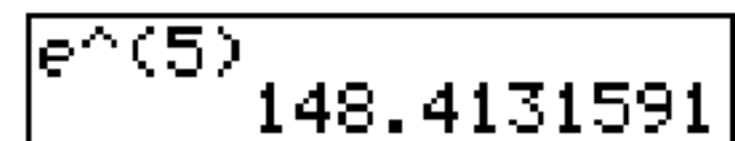

A TI-84 Plus calculator screen showing the calculation of e to the power of 5. The input is e^5 and the result is 148.4131591.

Constant

e (constant, $\boxed{2\text{nd}}$ $\boxed{[e]}$) is stored as a constant on the TI-84 Plus. Press $\boxed{2\text{nd}}$ $\boxed{[e]}$ to copy e to the cursor location. In calculations, the TI-84 Plus uses 2.718281828459 for e .

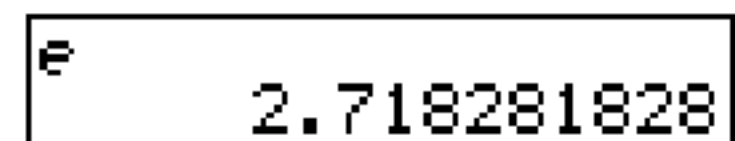

A TI-84 Plus calculator screen showing the constant e. The input is e and the result is 2.718281828.

Negation

$-$ (negation, $\boxed{(-)}$) returns the negative of *value*. You can use $-$ with real or complex numbers, expressions, lists, and matrices.

$-value$

EOS™ rules (Chapter 1) determine when negation is evaluated. For example, $-A^2$ returns a negative number, because squaring is evaluated before negation. Use parentheses to square a negated number, as in $(-A)^2$.

$$\left[\begin{array}{l} 2 \rightarrow A: (-A^2, (-A)^2, - \\ 2^2, (-2)^2) \\ \{-4 \ 4 \ -4 \ 4\} \end{array} \right]$$

Note: On the TI-84 Plus, the negation symbol (-) is shorter and higher than the subtraction sign (-), which is displayed when you press \square .

Pi

π (Pi, \square [π]) is stored as a constant in the TI-84 Plus. In calculations, the TI-84 Plus uses 3.1415926535898 for π .

$$\left[\begin{array}{l} \pi \\ 3.141592654 \end{array} \right]$$

MATH Operations

MATH Menu

To display the **MATH** menu, press **MATH**.

MATH NUM CPX PRB

1:	►Frac	Displays the answer as a fraction.
2:	►Dec	Displays the answer as a decimal.
3:	\square^3	Calculates the cube.
4:	$\sqrt[3]{\square}$	Calculates the cube root.
5:	$\sqrt[x]{\square}$	Calculates the x^{th} root.
6:	fMin (Finds the minimum of a function.
7:	fMax (Finds the maximum of a function.
8:	nDeriv (Computes the numerical derivative.
9:	fnInt (Computes the function integral.
0:	Solver...	Displays the equation solver.

►Frac, ►Dec

►Frac (display as a fraction) displays an answer as its rational equivalent. You can use ►Frac with real or complex numbers, expressions, lists, and matrices. If the answer

cannot be simplified or the resulting denominator is more than three digits, the decimal equivalent is returned. You can only use **▶Frac** following *value*.

value **▶Frac**

▶Dec (display as a decimal) displays an answer in decimal form. You can use **▶Dec** with real or complex numbers, expressions, lists, and matrices. You can only use **▶Dec** following *value*.

value **▶Dec**

```
1/2+1/3▶Frac 5/6
Ans▶Dec
.8333333333
```

Cube, Cube Root

3 (cube) returns the cube of *value*. You can use 3 with real or complex numbers, expressions, lists, and square matrices.

*value*³

$^3\sqrt{}$ (cube root) returns the cube root of *value*. You can use $^3\sqrt{}$ with real or complex numbers, expressions, and lists.

$^3\sqrt{(value)}$

```
(2,3,4,5)^3
(8 27 64 125)
^√(Ans)
(2 3 4 5)
```

x^{th} $\sqrt{\quad}$ (Root)

x^{th} $\sqrt{\quad}$ (x^{th} root) returns the x^{th} root of *value*. You can use x^{th} $\sqrt{\quad}$ with real or complex numbers, expressions, and lists.

x^{th} root x^{th} $\sqrt{\quad}$ value

```
5^√32
2
```

fMin(), fMax()

fMin() (function minimum) and **fMax()** (function maximum) return the value at which the local minimum or local maximum value of *expression* with respect to *variable* occurs, between *lower* and *upper* values for *variable*. **fMin()** and **fMax()** are not valid in *expression*. The accuracy is controlled by *tolerance* (if not specified, the default is 1E-5).

fMin(*expression,variable,lower,upper[,tolerance]*)

fMax(*expression,variable,lower,upper[,tolerance]*)

Note: In this guidebook, optional arguments and the commas that accompany them are enclosed in brackets ([]).

```
fMin(sin(A),A,-π
,π)
-1.570797171
fMax(sin(A),A,-π
,π)
1.570797171
```

nDeriv(

nDeriv((numerical derivative) returns an approximate derivative of *expression* with respect to *variable*, given the *value* at which to calculate the derivative and ϵ (if not specified, the default is 1E-3). **nDeriv(** is valid only for real numbers.

nDeriv(expression,variable,value[, ϵ])

nDeriv(uses the symmetric difference quotient method, which approximates the numerical derivative value as the slope of the secant line through these points.

$$f'(x) = \frac{f(x + \epsilon) - f(x - \epsilon)}{2\epsilon}$$

As ϵ becomes smaller, the approximation usually becomes more accurate.

```
nDeriv(A^3,A,5,.
01)
75.0001
nDeriv(A^3,A,5,.
0001)
75
```

You can use **nDeriv(** once in *expression*. Because of the method used to calculate **nDeriv(**, the TI-84 Plus can return a false derivative value at a nondifferentiable point.

fnInt(

fnInt((function integral) returns the numerical integral (Gauss-Kronrod method) of *expression* with respect to *variable*, given *lower* limit, *upper* limit, and a *tolerance* (if not specified, the default is 1E-5). **fnInt(** is valid only for real numbers.

fnInt(*expression,variable,lower,upper[,tolerance]*)

```
fnInt(A^2,A,0,1)
.3333333333
```

Note: To speed the drawing of integration graphs (when **fnInt(** is used in a Y= equation), increase the value of the **Xres** window variable before you press **GRAPH**.

Using the Equation Solver

Solver

Solver displays the equation solver, in which you can solve for any variable in an equation. The equation is assumed to be equal to zero. **Solver** is valid only for real numbers.

When you select **Solver**, one of two screens is displayed.

- The equation editor (see step 1 picture below) is displayed when the equation variable **eqn** is empty.
- The interactive solver editor is displayed when an equation is stored in **eqn**.

Entering an Expression in the Equation Solver

To enter an expression in the equation solver, assuming that the variable **eqn** is empty, follow these steps.

1. Select **0:Solver** from the **MATH** menu to display the equation editor.

```
EQUATION SOLVER
eqn: 0=
```

2. Enter the expression in any of three ways.
 - Enter the expression directly into the equation solver.
 - Paste a Y= variable name from the **VARs Y-VARS** menu to the equation solver.
 - Press **[2nd] [RCL]**, paste a Y= variable name from the **VARs Y-VARS** menu, and press **[ENTER]**. The expression is pasted to the equation solver.

The expression is stored to the variable **eqn** as you enter it.

```
EQUATION SOLVER
eqn: 0=Q^3+P^2-125
```

3. Press **[ENTER]** or **[v]**. The interactive solver editor is displayed.

```
Q^3+P^2-125=0
Q=0
P=0
bound={-1E99, 1...
```

- The equation stored in **eqn** is set equal to zero and displayed on the top line.

- Variables in the equation are listed in the order in which they appear in the equation. Any values stored to the listed variables also are displayed.
- The default lower and upper bounds appear in the last line of the editor (**bound={-1E99,1E99}**).
- A ↓ is displayed in the first column of the bottom line if the editor continues beyond the screen.

Note: To use the solver to solve an equation such as $K=.5MV^2$, enter **eqn:0=K-.5MV²** in the equation editor.

Entering and Editing Variable Values

When you enter or edit a value for a variable in the interactive solver editor, the new value is stored in memory to that variable.

You can enter an expression for a variable value. It is evaluated when you move to the next variable. Expressions must resolve to real numbers at each step during the iteration.

You can store equations to any **VAR** **Y-VAR** variables, such as Y1 or r6, and then reference the variables in the equation. The interactive solver editor displays all variables of all Y= functions referenced in the equation.

```
\Y9 BX^2-4AC
\Y0=
```

```
EQUATION SOLVER
eqn:0=Y9+7
```

```
Y9+7=0
X=0
R=0
C=0
bound={-1E99, 1...
```

Solving for a Variable in the Equation Solver

To solve for a variable using the equation solver after an equation has been stored to **eqn**, follow these steps.

1. Select **0:Solver** from the **MATH** menu to display the interactive solver editor, if not already displayed.

```
Q^3+P^2-125=0
Q=0
P=0
bound={-1E99, 1...
```

2. Enter or edit the value of each known variable. All variables, except the unknown variable, must contain a value. To move the cursor to the next variable, press **ENTER** or **▾**.

```
Q^3+P^2-125=0
Q=0
P=5
bound={-1E99, 1...
```

3. Enter an initial guess for the variable for which you are solving. This is optional, but it may help find the solution more quickly. Also, for equations with multiple roots, the TI-84 Plus will attempt to display the solution that is closest to your guess.

```

Q^3+P^2-125=0
Q=4■
P=5
bound={-1E99,1E99}

```

The default guess is calculated as $\frac{(upper + lower)}{2}$.

4. Edit **bound**={*lower,upper*}. *lower* and *upper* are the bounds between which the TI-84 Plus searches for a solution. This is optional, but it may help find the solution more quickly. The default is **bound**={-1E99,1E99}.
5. Move the cursor to the variable for which you want to solve and press **[ALPHA]** **[SOLVE]**.

```

Q^3+P^2-125=0
■ Q=4.6415888336...
P=5
bound={-50,50}
■ left-rt=0

```

- The solution is displayed next to the variable for which you solved. A solid square in the first column marks the variable for which you solved and indicates that the equation is balanced. An ellipsis shows that the value continues beyond the screen.

Note: When a number continues beyond the screen, be sure to press **[▶]** to scroll to the end of the number to see whether it ends with a negative or positive exponent. A very small number may appear to be a large number until you scroll right to see the exponent.
- The values of the variables are updated in memory.
- **left-rt=diff** is displayed in the last line of the editor. *diff* is the difference between the left and right sides of the equation. A solid square in the first column next to

left-rt indicates that the equation has been evaluated at the new value of the variable for which you solved.

Editing an Equation Stored to eqn

To edit or replace an equation stored to **eqn** when the interactive equation solver is displayed, press \square until the equation editor is displayed. Then edit the equation.

Equations with Multiple Roots

Some equations have more than one solution. You can enter a new initial guess or new bounds to look for additional solutions.

Further Solutions

After you solve for a variable, you can continue to explore solutions from the interactive solver editor. Edit the values of one or more variables. When you edit any variable value, the solid squares next to the previous solution and **left-rt=diff** disappear. Move the cursor to the variable for which you now want to solve and press \square [ALPHA] [SOLVE].

Controlling the Solution for Solver or solve(

The TI-84 Plus solves equations through an iterative process. To control that process, enter bounds that are relatively close to the solution and enter an initial guess within those bounds. This will help to find a solution more quickly. Also, it will define which solution you want for equations with multiple solutions.

Using solve(on the Home Screen or from a Program

The function **solve(** is available only from **CATALOG** or from within a program. It returns a solution (root) of *expression* for *variable*, given an initial *guess*, and *lower* and *upper* bounds within which the solution is sought. The default for *lower* is $-1E99$. The default for *upper* is $-1E99$. **solve(** is valid only for real numbers.

solve(expression,variable,guess[, {lower,upper}])

expression is assumed equal to zero. The value of *variable* will not be updated in memory. *guess* may be a value or a list of two values. Values must be stored for every variable in *expression*, except *variable*, before *expression* is evaluated. *lower* and *upper* must be entered in list format.

```
5→P
solve(Q^3+P^2-125
,Q,4,{-50,50})
4.641588834
```

MATH NUM (Number) Operations

MATH NUM Menu

To display the **MATH NUM** menu, press **MATH** .

MATH NUM CPX PRB

1:	abs (Absolute value
2:	round (Round
3:	iPart (Integer part
4:	fPart (Fractional part
5:	int (Greatest integer
6:	min (Minimum value
7:	max (Maximum value
8:	lcm (Least common multiple
9:	gcd (Greatest common divisor

abs(

abs((absolute value) returns the absolute value of real or complex (modulus) numbers, expressions, lists, and matrices.

abs(value)

```
abs(-256)
abs({1.25, -5.67})
      {1.25 5.67}
```

Note: `abs()` is also available on the **MATH CPX** menu.

round()

`round()` returns a number, expression, list, or matrix rounded to *#decimals* (≤ 9). If *#decimals* is omitted, *value* is rounded to the digits that are displayed, up to 10 digits.

`round(value[,#decimals])`

```
round( $\pi$ , 4)
      3.1416
```

```
123456789012 $\rightarrow$ C
      1.23456789E11
C-round(C)
      12
123456789012-123
456789000
      12
```

iPart(), fPart()

`iPart()` (integer part) returns the integer part or parts of real or complex numbers, expressions, lists, and matrices.

`iPart(value)`

`fPart()` (fractional part) returns the fractional part or parts of real or complex numbers, expressions, lists, and matrices.

fPart(*value*)

```
iPart(-23.45)  -23
fPart(-23.45)  -.45
```

int()

int() (greatest integer) returns the largest integer \leq real or complex numbers, expressions, lists, and matrices.

int(*value*)

```
int(-23.45)  -24
```

Note: For a given *value*, the result of **int()** is the same as the result of **iPart()** for nonnegative numbers and negative integers, but one integer less than the result of **iPart()** for negative noninteger numbers.

min(), max()

min() (minimum value) returns the smaller of *valueA* and *valueB* or the smallest element in *list*. If *listA* and *listB* are compared, **min()** returns a list of the smaller of each pair of elements. If *list* and *value* are compared, **min()** compares each element in *list* with *value*.

max((maximum value) returns the larger of *valueA* and *valueB* or the largest element in *list*. If *listA* and *listB* are compared, **max(** returns a list of the larger of each pair of elements. If *list* and *value* are compared, **max(** compares each element in *list* with *value*.

min(*valueA,valueB*)

min(*list*)

min(*listA,listB*)

min(*list,value*)

max(*valueA,valueB*)

max(*list*)

max(*listA,listB*)

max(*list,value*)

<code>min(3,2+2)</code>	3
<code>min({3,4,5},4)</code>	{3 4 4}
<code>max({4,5,6})</code>	6

Note: **min(** and **max(** also are available on the **LIST MATH** menu.

lcm(, gcd(

lcm(returns the least common multiple of *valueA* and *valueB*, both of which must be nonnegative integers. When *listA* and *listB* are specified, **lcm(** returns a list of the lcm of each pair of elements. If *list* and *value* are specified, **lcm(** finds the lcm of each element in *list* and *value*.

gcd(returns the greatest common divisor of *valueA* and *valueB*, both of which must be nonnegative integers. When *listA* and *listB* are specified, **gcd(** returns a list of the gcd of

each pair of elements. If *list* and *value* are specified, **gcd**(finds the gcd of each element in *list* and *value*.

lcm(*valueA,valueB*)

lcm(*listA,listB*)

lcm(*list,value*)

gcd(*valueA,valueB*)

gcd(*listA,listB*)

gcd(*list,value*)

```
lcm(2,5)
gcd({48,66},{64,
122})
      {16 23}
```

Entering and Using Complex Numbers

Complex-Number Modes

The TI-84 Plus displays complex numbers in rectangular form and polar form. To select a complex-number mode, press **MODE**, and then select either of the two modes.

- **a+bi** (rectangular-complex mode)
- **re^{θi}** (polar-complex mode)

```
NORMAL SCI ENG
FLOAT 0 1 2 3 4 5 6 7 8 9
RADIAN DEGREE
FUNC PAR POL SEQ
CONNECTED DOT
SEQUENTIAL SIMUL
REAL a+bi r<sup>θi</sup>
FULL HORIZ G-T
SETCLOCK 03/18/04 2:04PM
```

On the TI-84 Plus, complex numbers can be stored to variables. Also, complex numbers are valid list elements.

In Real mode, complex-number results return an error, unless you entered a complex number as input. For example, in Real mode $\ln(-1)$ returns an error; in $a+bi$ mode $\ln(-1)$ returns an answer.

Real mode

```
|ln(-1)■|
```

↓

```
|ERR:NONREAL ANS|  
|1:Quit|  
|2:Goto|
```

$a+bi$ mode

```
|ln(-1)■|
```

↓

```
|ln(-1)|  
| 3.141592654i|
```

Entering Complex Numbers

Complex numbers are stored in rectangular form, but you can enter a complex number in rectangular form or polar form, regardless of the mode setting. The components of complex numbers can be real numbers or expressions that evaluate to real numbers; expressions are evaluated when the command is executed.

Note about Radian Versus Degree Mode

Radian mode is recommended for complex number calculations. Internally, the TI-84 Plus converts all entered trigonometric values to radians, but it does not convert values for exponential, logarithmic, or hyperbolic functions.

In degree mode, complex identities such as $e^{i\theta} = \cos(\theta) + i \sin(\theta)$ are not generally true because the values for \cos and \sin are converted to radians, while those for $e^{i\theta}$ are not. For example, $e^{i45} = \cos(45) + i \sin(45)$ is treated internally as $e^{i45} = \cos(\pi/4) + i \sin(\pi/4)$. Complex identities are always true in radian mode.

Interpreting Complex Results

Complex numbers in results, including list elements, are displayed in either rectangular or polar form, as specified by the mode setting or by a display conversion instruction. In the example below, polar-complex ($re^{i\theta}$) and Radian modes are set.

$$\left\{ \begin{array}{l} (2+i) - (1e^{i\pi/4}) \\ 1.325654296e^{i\dots} \end{array} \right.$$

Rectangular-Complex Mode

Rectangular-complex mode recognizes and displays a complex number in the form $\mathbf{a} + \mathbf{b}i$, where \mathbf{a} is the real component, \mathbf{b} is the imaginary component, and i is a constant equal to $\sqrt{-1}$.

$$\left| \begin{array}{l} \ln(-1) \\ 3.141592654i \end{array} \right.$$

To enter a complex number in rectangular form, enter the value of a (*real component*), press $\boxed{+}$ or $\boxed{-}$, enter the value of b (*imaginary component*), and press $\boxed{2nd} \boxed{[i]}$ (constant).

real component(+ or -)imaginary component i

$$4+2i \quad 4+2i$$

Polar-Complex Mode

Polar-complex mode recognizes and displays a complex number in the form $re^{\theta i}$, where r is the magnitude, e is the base of the natural log, θ is the angle, and i is a constant equal to $\sqrt{-1}$.

$$\ln(-1) \\ 3.141592654e^{(1...}$$

To enter a complex number in polar form, enter the value of r (*magnitude*), press $\boxed{2nd}$ [e^x] (exponential function), enter the value of θ (*angle*), press $\boxed{2nd}$ [i] (constant), and then press $\boxed{=}$.

$$\text{magnitude}e^{(\text{angle}i)}$$

$$10e^{(\pi/3i)} \\ 10e^{(1.04719755...}$$

MATH CPX (Complex) Operations

MATH CPX Menu

To display the **MATH CPX** menu, press **MATH** **▸** **▸**.

MATH NUM CPX PRB

- | | | |
|----|--------|--|
| 1: | conj(| Returns the complex conjugate. |
| 2: | real(| Returns the real part. |
| 3: | imag(| Returns the imaginary part. |
| 4: | angle(| Returns the polar angle. |
| 5: | abs(| Returns the magnitude (modulus). |
| 6: | ►Rect | Displays the result in rectangular form. |
| 7: | ►Polar | Displays the result in polar form. |
-

conj(

conj((conjugate) returns the complex conjugate of a complex number or list of complex numbers.

conj(a+bi) returns $a-bi$ in **a+bi** mode.

conj(re^{θi}) returns $re^{-θi}$ in **re^{θi}** mode.

```
conj(3+4i)  3-4i
```

```
conj(3e^(4i))  3e^(2.283185307...)
```

real()

real() (real part) returns the real part of a complex number or list of complex numbers.

real($a+bi$) returns a .

real($re^{\theta i}$) returns $r*\cos(\theta)$.

```
real(3+4i)
3
```

```
real(3e^(4i))
-1.960930863
```

imag()

imag() (imaginary part) returns the imaginary (nonreal) part of a complex number or list of complex numbers.

imag($a+bi$) returns b .

imag($re^{\theta i}$) returns $r*\sin(\theta)$.

```
imag(3+4i)
4
```

```
imag(3e^(4i))
-2.270407486
```

angle()

angle() returns the polar angle of a complex number or list of complex numbers, calculated as $\tan^{-1}(b/a)$, where b is the imaginary part and a is the real part. The calculation is adjusted by $+\pi$ in the second quadrant or $-\pi$ in the third quadrant.

angle($a+bi$) returns $\tan^{-1}(b/a)$.

angle($re^{\theta i}$) returns θ , where $-\pi < \theta < \pi$.

```
angle(3+4i)
.927295218
```

```
angle(3e^(4i))
-2.283185307
```

abs(

abs((absolute value) returns the magnitude (modulus), $\sqrt{(\text{real}^2 + \text{imag}^2)}$, of a complex number or list of complex numbers.

abs($a+bi$) returns $\sqrt{a^2 + b^2}$.

abs($re^{\theta i}$) returns r (magnitude).

```
abs(3+4i)
5
```

```
abs(3e^(4i))
3
```

►Rect

►**Rect** (display as rectangular) displays a complex result in rectangular form. It is valid only at the end of an expression. It is not valid if the result is real.

complex result ► **Rect** returns $a+bi$.

```
sqrt(-2)►Rect
1.414213562i
```

►Polar

►**Polar** (display as polar) displays a complex result in polar form. It is valid only at the end of an expression. It is not valid if the result is real.

complex result►**Polar** returns $re^{(\theta i)}$.

```
√(-2)►Polar  
1.414213562e^(1...
```

MATH PRB (Probability) Operations

MATH PRB Menu

To display the **MATH PRB** menu, press **MATH** **◀**.

MATH NUM CPX PRB

- | | | |
|----|------------|-------------------------------------|
| 1: | rand | Random-number generator |
| 2: | nPr | Number of permutations |
| 3: | nCr | Number of combinations |
| 4: | ! | Factorial |
| 5: | randInt (| Random-integer generator |
| 6: | randNorm (| Random # from Normal distribution |
| 7: | randBin (| Random # from Binomial distribution |
-

rand

rand (random number) generates and returns one or more random numbers > 0 and < 1 . To generate a list of random-numbers, specify an integer > 1 for *numtrials* (number of trials). The default for *numtrials* is 1.

rand[(*numtrials*)]

Note: To generate random numbers beyond the range of 0 to 1, you can include **rand** in an expression. For example, **rand5** generates a random number > 0 and < 5 .

With each **rand** execution, the TI-84 Plus generates the same random-number sequence for a given seed value. The TI-84 Plus factory-set seed value for **rand** is 0. To generate a different random-number sequence, store any nonzero seed value to **rand**. To restore the factory-set seed value, store 0 to **rand** or reset the defaults (Chapter 18).

Note: The seed value also affects **randInt**(, **randNorm**(, and **randBin**(instructions.

```
rand
  .1272157551
  .2646513087
1→rand
  1
rand(3)
(.7455607728 .8...
```

nPr, nCr

nPr (number of permutations) returns the number of permutations of *items* taken *number* at a time. *items* and *number* must be nonnegative integers. Both *items* and *number* can be lists.

items **nPr** *number*

nCr (number of combinations) returns the number of combinations of *items* taken *number* at a time. *items* and *number* must be nonnegative integers. Both *items* and *number* can be lists.

items **nCr** *number*

```
5 nPr 2      20
5 nCr 2      10
{2,3} nPr {2,2}
           {2 6}
```

Factorial

! (factorial) returns the factorial of either an integer or a multiple of .5. For a list, it returns factorials for each integer or multiple of .5. *value* must be $\geq -.5$ and ≤ 69 .

value!

```
6!      720
{5,4,6}!
{120 24 720}
```

Note: The factorial is computed recursively using the relationship $(n+1)! = n*n!$, until n is reduced to either 0 or $-1/2$. At that point, the definition $0!=1$ or the definition $(-1/2)! = \sqrt{\pi}$ is used to complete the calculation. Hence:

$n! = n*(n-1)*(n-2)* \dots *2*1$, if n is an integer ≥ 0
 $n! = n*(n-1)*(n-2)* \dots *1/2*\sqrt{\pi}$, if $n+1/2$ is an integer ≥ 0
 $n!$ is an error, if neither n nor $n+1/2$ is an integer ≥ 0 .

(The variable *n* equals *value* in the syntax description above.)

randInt()

randInt() (random integer) generates and displays a random integer within a range specified by *lower* and *upper* integer bounds. To generate a list of random numbers, specify an integer > 1 for *numtrials* (number of trials); if not specified, the default is 1.

randInt(*lower,upper[,numtrials]*)

```
randInt(1,6)+ran  
dInt(1,6)      6  
randInt(1,6,3)  
{2 1 5}
```

randNorm()

randNorm() (random Normal) generates and displays a random real number from a specified Normal distribution. Each generated value could be any real number, but most will be within the interval $[\mu-3(\sigma), \mu+3(\sigma)]$. To generate a list of random numbers, specify an integer > 1 for *numtrials* (number of trials); if not specified, the default is 1.

randNorm($\mu,\sigma[,numtrials]$)

```
randNorm(0,1)  
.0772076175  
randNorm(35,2,10  
0)  
{34.02701938 37...
```

randBin()

randBin() (random Binomial) generates and displays a random integer from a specified Binomial distribution. *numtrials* (number of trials) must be ≥ 1 . *prob* (probability of success) must be ≥ 0 and ≤ 1 . To generate a list of random numbers, specify an integer > 1 for *numsimulations* (number of simulations); if not specified, the default is 1.

randBin(*numtrials*,*prob*[,*numsimulations*])

```
randBin(5,.2)
randBin(7,.4,10)
(3 3 2 5 1 2 2 ...)
```

Note: The seed value stored to **rand** also affects **randInt()**, **randNorm()**, and **randBin()** instructions.

ANGLE Operations

ANGLE Menu

To display the **ANGLE** menu, press $\boxed{2\text{nd}}$ [ANGLE]. The **ANGLE** menu displays angle indicators and instructions. The Radian/Degree mode setting affects the TI-84 Plus's interpretation of **ANGLE** menu entries.

ANGLE

- 1: $^{\circ}$ Degree notation
 - 2: $'$ DMS minute notation
 - 3: r Radian notation
 - 4: \blacktriangleright DMS Displays as degree/minute/second
 - 5: $R\blacktriangleright Pr ($ Returns r , given X and Y
 - 6: $R\blacktriangleright P\theta ($ Returns θ , given X and Y
 - 7: $P\blacktriangleright Rx ($ Returns x , given R and θ
 - 8: $P\blacktriangleright Ry ($ Returns y , given R and θ
-

Entry Notation

DMS (degrees/minutes/seconds) entry notation comprises the degree symbol ($^{\circ}$), the minute symbol ($'$), and the second symbol ($''$). *degrees* must be a real number; *minutes* and *seconds* must be real numbers ≥ 0 .

degrees $^{\circ}$ *minutes* $'$ *seconds* $''$

For example, enter for 30 degrees, 1 minute, 23 seconds. If the angle mode is not set to Degree, you must use $^\circ$ so that the TI-84 Plus can interpret the argument as degrees, minutes, and seconds.

Degree mode

```
sin(30°1'23")
.5003484441
```

Radian mode

```
sin(30°1'23")
-.9842129995
sin(30°1'23"°)
.5003484441
```

Degree

$^\circ$ (degree) designates an angle or list of angles as degrees, regardless of the current angle mode setting. In Radian mode, you can use $^\circ$ to convert degrees to radians.

value $^\circ$

{*value1,value2,value3,value4,...,value n*} $^\circ$

$^\circ$ also designates *degrees* (D) in DMS format.

' (minutes) designates *minutes* (M) in DMS format.

" (seconds) designates *seconds* (S) in DMS format.

Note: " is not on the **ANGLE** menu. To enter ", press $\boxed{\text{ALPHA}}$ ["].

Radians

r (radians) designates an angle or list of angles as radians, regardless of the current angle mode setting. In Degree mode, you can use r to convert radians to degrees.

value^r

Degree mode

```
sin((π/4)r)
.7071067812
sin((0,π/2)r)
(0 1)
(π/4)r
45
```

►DMS

►DMS (degree/minute/second) displays *answer* in DMS format. The mode setting must be Degree for *answer* to be interpreted as degrees, minutes, and seconds. ►DMS is valid only at the end of a line.

answer►DMS

```
54°32'30"*2
109.0833333
Ans►DMS
109°5'0"
```

R►Pr(, R►Pθ(, P►Rx(, P►Ry(

R►Pr(converts rectangular coordinates to polar coordinates and returns *r*. R►Pθ(converts rectangular coordinates to polar coordinates and returns *θ*. *x* and *y* can be lists.

R►Pr(x,y), R►Pθ(x,y)

```
R►Pr(-1,0)      1
R►Pθ(-1,0)     3.141592654
```

Note: Radian mode is set.

P►Rx(converts polar coordinates to rectangular coordinates and returns **x**. **P►Ry**(converts polar coordinates to rectangular coordinates and returns **y**. *r* and *θ* can be lists.

P►Rx(r,θ), P►Ry(r,θ)

```
P►Rx(1,π)      -1
P►Ry(1,π)      0
```

Note: Radian mode is set.

TEST (Relational) Operations

TEST Menu

To display the **TEST** menu, press $\boxed{2\text{nd}}$ [TEST].

This operator...	Returns 1 (true) if...
TEST LOGIC	
1: =	Equal
2: \neq	Not equal to
3: >	Greater than
4: \geq	Greater than or equal to
5: <	Less than
6: \leq	Less than or equal to

$=, \neq, >, \geq, <, \leq$

Relational operators compare *valueA* and *valueB* and return 1 if the test is true or 0 if the test is false. *valueA* and *valueB* can be real numbers, expressions, or lists. For = and \neq only, *valueA* and *valueB* also can be matrices or complex numbers. If *valueA* and *valueB* are matrices, both must have the same dimensions.

Relational operators are often used in programs to control program flow and in graphing to control the graph of a function over specific values.

$valueA=valueB$

$valueA>valueB$

$valueA<valueB$

$valueA\neq valueB$

$valueA\geq valueB$

$valueA\leq valueB$

$25=26$	0
$\{1,2,3\}<3$	0
$\{1,2,3\}\neq\{3,2,1\}$	$\{1,1,0\}$
	$\{1,0,1\}$

Using Tests

Relational operators are evaluated after mathematical functions according to EOS rules (Chapter 1).

- The expression $2+2=2+3$ returns **0**. The TI-84 Plus performs the addition first because of EOS rules, and then it compares 4 to 5.
- The expression $2+(2=2)+3$ returns **6**. The TI-84 Plus performs the relational test first because it is in parentheses, and then it adds 2, 1, and 3.

TEST LOGIC (Boolean) Operations

TEST LOGIC Menu

To display the **TEST LOGIC** menu, press $\boxed{2nd}$ [TEST] $\boxed{\blacktriangleright}$.

This operator...	Returns a 1 (true) if...
TEST LOGIC	
1: and	Both values are nonzero (true).
2: or	At least one value is nonzero (true).
3: xor	Only one value is zero (false).
4: not (The value is zero (false).

Boolean Operators

Boolean operators are often used in programs to control program flow and in graphing to control the graph of the function over specific values. Values are interpreted as zero (false) or nonzero (true).

and, or, xor

and, **or**, and **xor** (exclusive or) return a value of 1 if an expression is true or 0 if an expression is false, according to the table below. *valueA* and *valueB* can be real numbers, expressions, or lists.

valueA **and** *valueB*

valueA **or** *valueB*

valueA **xor** *valueB*

valueA	valueB		and	or	xor
≠0	≠0	returns	1	1	0
≠0	0	returns	0	1	1
0	≠0	returns	0	1	1
0	0	returns	0	0	0

not(

not(returns 1 if *value* (which can be an expression) is 0.

not(*value*)

Using Boolean Operations

Boolean logic is often used with relational tests. In the following program, the instructions store 4 into C.

```
PROGRAM:BOOLEAN
:2→A:3→B
:If A=2 and B=3
:Then:4→C
:Else:5→C
:End
```

Chapter 3: Function Graphing

Getting Started: Graphing a Circle

Getting Started is a fast-paced introduction. Read the chapter for details.

Graph a circle of radius 10, centered on the origin in the standard viewing window. To graph this circle, you must enter separate formulas for the upper and lower portions of the circle. Then use ZSquare (zoom square) to adjust the display and make the functions appear as a circle.

1. In **Func** mode, press $\boxed{Y=}$ to display the Y= editor. Press $\boxed{2nd} \boxed{\sqrt{}} \boxed{100} \boxed{-} \boxed{X,T,\theta,n} \boxed{x^2} \boxed{)} \boxed{ENTER}$ to enter the expression $Y=\sqrt{100-X^2}$, which defines the top half of the circle.

```
Plot1 Plot2 Plot3
Y1=√(100-X²)
Y2=-Y1
Y3=
Y4=
Y5=
Y6=
Y7=
```

The expression $Y=-\sqrt{100-X^2}$ defines the bottom half of the circle. On the TI-84 Plus, you can define one function in terms of another. To define $Y2=-Y1$, press $\boxed{-}$ to enter the negation sign. Press $\boxed{VARS} \boxed{\blacktriangleright}$ to display the **VARS Y-VARS** menu. Then press \boxed{ENTER} to select **1:Function**. The **FUNCTION** secondary menu is displayed. Press 1 to select **1:Y1**.

```
Plot1 Plot2 Plot3
Y1=√(100-X²)
Y2=-Y1
Y3=
Y4=
Y5=
Y6=
Y7=
```

2. Press **ZOOM** 6 to select **6:ZStandard**. This is a quick way to reset the window variables to the standard values. It also graphs the functions; you do not need to press **GRAPH**.

Notice that the functions appear as an ellipse in the standard viewing window.

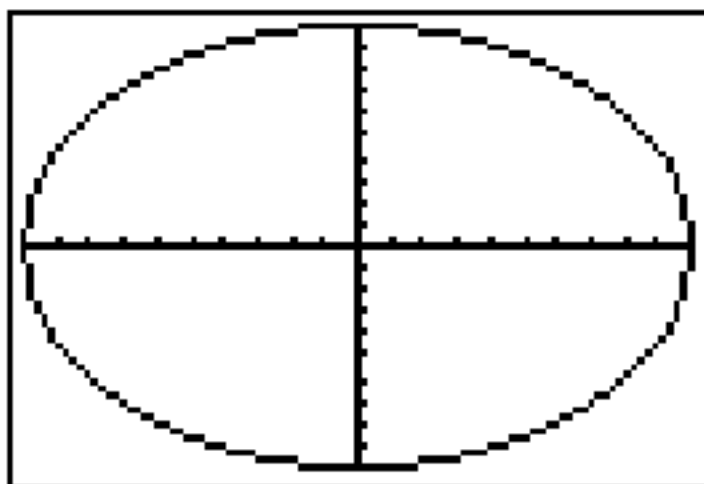

3. To adjust the display so that each pixel represents an equal width and height, press **ZOOM** 5 to select **5:ZSquare**. The functions are replotted and now appear as a circle on the display.

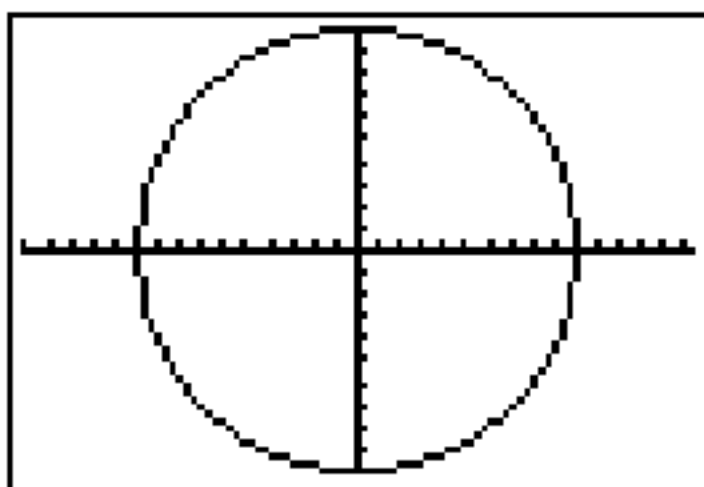

4. To see the **ZSquare** window variables, press **WINDOW** and notice the new values for **Xmin**, **Xmax**, **Ymin**, and **Ymax**.

```
WINDOW
Xmin=-15.16129...
Xmax=15.161290...
Xscl=1
Ymin=-10
Ymax=10
Yscl=1
Xres=1
```

Defining Graphs

TI-84 Plus—Graphing Mode Similarities

Chapter 3 specifically describes function graphing, but the steps shown here are similar for each TI-84 Plus graphing mode. Chapters 4, 5, and 6 describe aspects that are unique to parametric graphing, polar graphing, and sequence graphing.

Defining a Graph

To define a graph in any graphing mode, follow these steps. Some steps are not always necessary.

1. Press **[MODE]** and set the appropriate graph mode.
2. Press **[Y=]** and enter, edit, or select one or more functions in the Y= editor.
3. Deselect stat plots, if necessary.
4. Set the graph style for each function.
5. Press **[WINDOW]** and define the viewing window variables.
6. Press **[2nd] [FORMAT]** and select the graph format settings.

Displaying and Exploring a Graph

After you have defined a graph, press **[GRAPH]** to display it. Explore the behavior of the function or functions using the TI-84 Plus tools described in this chapter.

Saving a Graph for Later Use

You can store the elements that define the current graph to any of 10 graph database variables (**GDB1** through **GDB9**, and **GDB0**; Chapter 8). To recreate the current graph later, simply recall the graph database to which you stored the original graph.

These types of information are stored in a **GDB**.

- Y= functions
- Graph style settings

- Window settings
- Format settings

You can store a picture of the current graph display to any of 10 graph picture variables (**Pic1** through **Pic9**, and **Pic0**; Chapter 8). Then you can superimpose one or more stored pictures onto the current graph.

Setting the Graph Modes

Checking and Changing the Graphing Mode

To display the mode screen, press **MODE**. The default settings are highlighted below. To graph functions, you must select **Func** mode before you enter values for the window variables and before you enter the functions.

```

NORMAL SCI ENG
FLOAT 0 1 2 3 4 5 6 7 8 9
RADIAN DEGREE
FUNC PAR POL SEQ
CONNECTED DOT
SEQUENTIAL SIMUL
REAL a+bi r<sup>θ</sup>i
FULL HORIZ G-T
SETCLOCK 03/18/04 2:04PM
  
```

The TI-84 Plus has four graphing modes.

- **Func** (function graphing)
- **Par** (parametric graphing; Chapter 4)
- **Pol** (polar graphing; Chapter 5)
- **Seq** (sequence graphing; Chapter 6)

Other mode settings affect graphing results. Chapter 1 describes each mode setting.

- **Float** or **0123456789** (fixed) decimal mode affects displayed graph coordinates.
- **Radian** or **Degree** angle mode affects interpretation of some functions.
- **Connected** or **Dot** plotting mode affects plotting of selected functions.
- **Sequential** or **Simul** graphing-order mode affects function plotting when more than one function is selected.

Setting Modes from a Program

To set the graphing mode and other modes from a program, begin on a blank line in the program editor and follow these steps.

1. Press **MODE** to display the mode settings.
2. Press **▼**, **▶**, **◀**, and **▲** to place the cursor on the mode that you want to select.
3. Press **ENTER** to paste the mode name to the cursor location.

The mode is changed when the program is executed.

Defining Functions

Displaying Functions in the Y= Editor

To display the Y= editor, press **Y=**. You can store up to 10 functions to the function variables Y1 through Y9, and Y0. You can graph one or more defined functions at once. In this example, functions Y1 and Y2 are defined and selected.

Plot1	Plot2	Plot3
Y1 = $\sqrt{100-X^2}$		
Y2 = $-Y1$		
Y3 =		
Y4 =		
Y5 =		
Y6 =		
Y7 =		

Defining or Editing a Function

To define or edit a function, follow these steps.

1. Press $\boxed{Y=}$ to display the Y= editor.
2. Press $\boxed{\downarrow}$ to move the cursor to the function you want to define or edit. To erase a function, press $\boxed{\text{CLEAR}}$.
3. Enter or edit the expression to define the function.
 - You may use functions and variables (including matrices and lists) in the expression. When the expression evaluates to a nonreal number, the value is not plotted; no error is returned.
 - The independent variable in the function is X. **Func** mode defines $\boxed{X,T,\theta,n}$ as X. To enter X, press $\boxed{X,T,\theta,n}$ or press $\boxed{\text{ALPHA}} \boxed{X}$.
 - When you enter the first character, the = is highlighted, indicating that the function is selected.

As you enter the expression, it is stored to the variable Y_n as a user-defined function in the Y= editor.

4. Press $\boxed{\text{ENTER}}$ or $\boxed{\downarrow}$ to move the cursor to the next function.

Defining a Function from the Home Screen or a Program

To define a function from the home screen or a program, begin on a blank line and follow these steps.

1. Press **[ALPHA]** **[*Y*]**, enter the expression, and then press **[ALPHA]** **[*Y*]** again.
2. Press **[STO▶]**.
3. Press **[VARS]** **[▶]** **1** to select **1:Function** from the **VARS Y-VARS** menu.
4. Select the function name, which pastes the name to the cursor location on the home screen or program editor.
5. Press **[ENTER]** to complete the instruction.

"expression"→ Y_n

```
"X²"→Y₁ Done
```

```
Plot1 Plot2 Plot3  
√Y₁ X²
```

When the instruction is executed, the TI-84 Plus stores the expression to the designated variable Y_n , selects the function, and displays the message *Done*.

Evaluating $Y=$ Functions in Expressions

You can calculate the value of a $Y=$ function Y_n at a specified *value* of X . A list of *values* returns a list.

$Y_n(\text{value})$

$Y_n(\{\text{value1}, \text{value2}, \text{value3}, \dots, \text{value n}\})$

```
Plot1 Plot2 Plot3
\Y1= .2X^3-2X+6
\Y2=
\Y3=
```

```
Y1(0)
Y1({0,1,2,3,4}) 6
(6 4.2 3.6 5.4 ...)
```

Selecting and Deselecting Functions

Selecting and Deselecting a Function

You can select and deselect (turn on and turn off) a function in the Y= editor. A function is selected when the = sign is highlighted. The TI-84 Plus graphs only the selected functions. You can select any or all functions Y1 through Y9, and Y0.

To select or deselect a function in the Y= editor, follow these steps.

1. Press $\boxed{Y=}$ to display the Y= editor.
2. Move the cursor to the function you want to select or deselect.
3. Press $\boxed{\leftarrow}$ to place the cursor on the function's = sign.
4. Press $\boxed{\text{ENTER}}$ to change the selection status.

When you enter or edit a function, it is selected automatically. When you clear a function, it is deselected.

Turning On or Turning Off a Stat Plot in the Y= Editor

To view and change the on/off status of a stat plot in the Y= editor, use **Plot1 Plot2 Plot3** (the top line of the Y= editor). When a plot is on, its name is highlighted on this line.

To change the on/off status of a stat plot from the Y= editor, press \leftarrow and \rightarrow to place the cursor on **Plot1**, **Plot2**, or **Plot3**, and then press $\boxed{\text{ENTER}}$.

```
Plot1 Plot2 Plot3
\Y1=.2X^3-2X+6
\Y2=-Y1
\Y3=2X+X^2
\Y4=
\Y5=
\Y6=
\Y7=
```

Plot1 is turned on.
Plot2 and Plot3 are turned off.

Selecting and Deselecting Functions from the Home Screen or a Program

To select or deselect a function from the home screen or a program, begin on a blank line and follow these steps.

1. Press $\boxed{\text{VARS}}$ \rightarrow to display the **VARS Y-VARS** menu.
2. Select **4:On/Off** to display the **ON/OFF** secondary menu.
3. Select **1:FnOn** to turn on one or more functions or **2:FnOff** to turn off one or more functions. The instruction you select is copied to the cursor location.
4. Enter the number (1 through 9, or 0; not the variable Y_n) of each function you want to turn on or turn off.
 - If you enter two or more numbers, separate them with commas.

- To turn on or turn off all functions, do not enter a number after **FnOn** or **FnOff**.

FnOn[function#,function#, . . .,function n]

FnOff[function#,function#, . . .,function n]

- Press **ENTER**. When the instruction is executed, the status of each function in the current mode is set and **Done** is displayed.

For example, in **Func** mode, **FnOff :FnOn 1,3** turns off all functions in the Y= editor, and then turns on Y1 and Y3.

```
FnOff :FnOn 1,3
      Done
```







```
Plot1 Plot2 Plot3
\Y1  $2X^3 - 2X + 6$ 
\Y2 = -Y1
\Y3  $X^2$ 
\Y4 =
\Y5 =
\Y6 =
\Y7 =
```

Setting Graph Styles for Functions

MATH Graph Style Icons in the Y= Editor

This table describes the graph styles available for function graphing. Use the styles to visually differentiate functions to be graphed together. For example, you can set Y1 as a solid line, Y2 as a dotted line, and Y3 as a thick line.

Icon	Style	Description
\	Line	A solid line connects plotted points; this is the default in Connected mode

Icon	Style	Description
	Thick	A thick solid line connects plotted points
	Above	Shading covers the area above the graph
	Below	Shading covers the area below the graph
	Path	A circular cursor traces the leading edge of the graph and draws a path
	Animate	A circular cursor traces the leading edge of the graph without drawing a path
	Dot	A small dot represents each plotted point; this is the default in Dot mode

Note: Some graph styles are not available in all graphing modes. Chapters 4, 5, and 6 list the styles for Par, Pol, and Seq modes.

Setting the Graph Style

To set the graph style for a function, follow these steps.

1. Press $\boxed{Y=}$ to display the Y= editor.
2. Press $\boxed{\downarrow}$ and $\boxed{\uparrow}$ to move the cursor to the function.
3. Press $\boxed{\leftarrow}$ $\boxed{\leftarrow}$ to move the cursor left, past the = sign, to the graph style icon in the first column. The insert cursor is displayed. (Steps 2 and 3 are interchangeable.)
4. Press $\boxed{\text{ENTER}}$ repeatedly to rotate through the graph styles. The seven styles rotate in the same order in which they are listed in the table above.

5. Press \blacktriangleright , \blacktriangleup , or \blacktriangledown when you have selected a style.

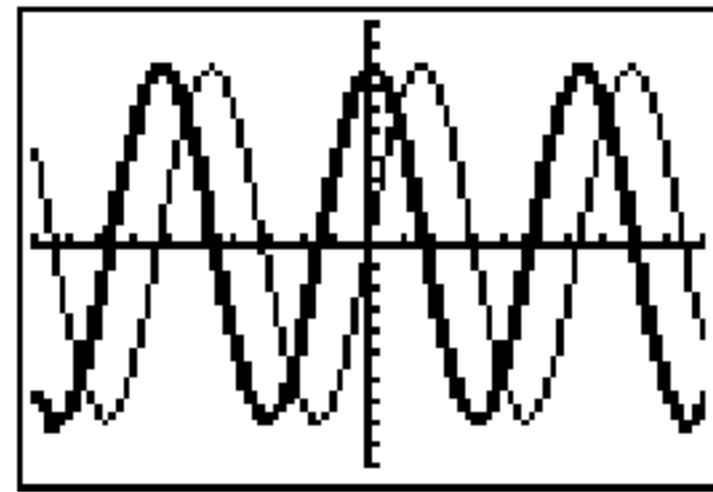
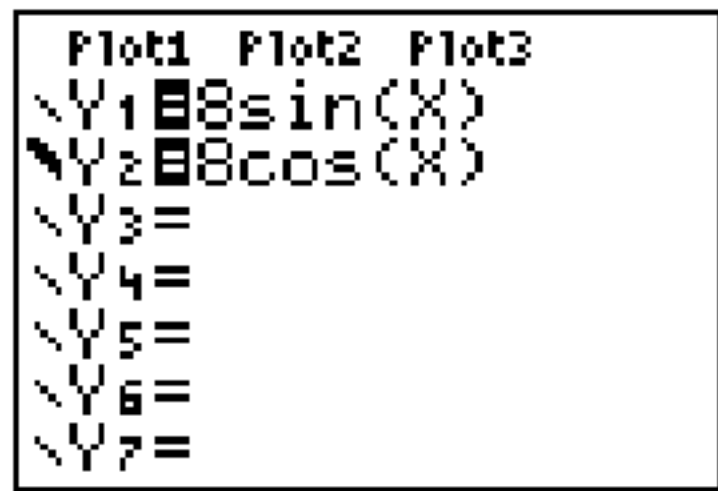



Shading Above and Below

When you select ▬ or ▨ for two or more functions, the TI-84 Plus rotates through four shading patterns.

- Vertical lines shade the first function with a ▬ or ▨ graph style.
- Horizontal lines shade the second.
- Negatively sloping diagonal lines shade the third.
- Positively sloping diagonal lines shade the fourth.
- The rotation returns to vertical lines for the fifth ▬ or ▨ function, repeating the order described above.

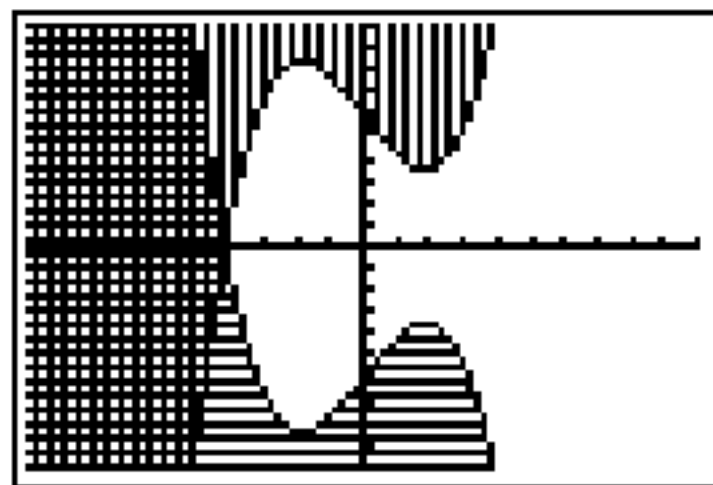
When shaded areas intersect, the patterns overlap.



Note: When  or  is selected for a Y= function that graphs a family of curves, such as $Y1=\{1,2,3\}X$, the four shading patterns rotate for each member of the family of curves.

Setting a Graph Style from a Program

To set the graph style from a program, select **H:GraphStyle(** from the **PRGM CTL** menu. To display this menu, press **PRGM** while in the program editor. *function#* is the number of the Y= function name in the current graphing mode. *graphstyle#* is an integer from 1 to 7 that corresponds to the graph style, as shown below.

- | | |
|---|---|
| 1 =  (line) | 5 =  (path) |
| 2 =  (thick) | 6 =  (animate) |
| 3 =  (above) | 7 =  (dot) |
| 4 =  (below) | |

GraphStyle(*function#*,*graphstyle#*)

For example, when this program is executed in Func mode, **GraphStyle(1,3)** sets Y1 to  (above).

```
PROGRAM: SHADE
: ".2X^3-2X+6"→Y1
: GraphStyle(1,3)
: DispGraph
```

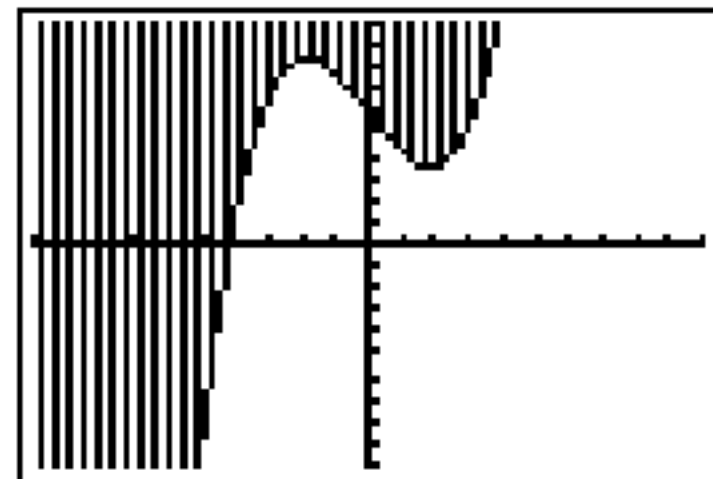

Setting the Viewing Window Variables

The TI-84 Plus Viewing Window

The viewing window is the portion of the coordinate plane defined by **Xmin**, **Xmax**, **Ymin**, and **Ymax**. **Xscl** (X scale) defines the distance between tick marks on the x-axis. **Yscl** (Y scale) defines the distance between tick marks on the y-axis. To turn off tick marks, set **Xscl=0** and **Yscl=0**.

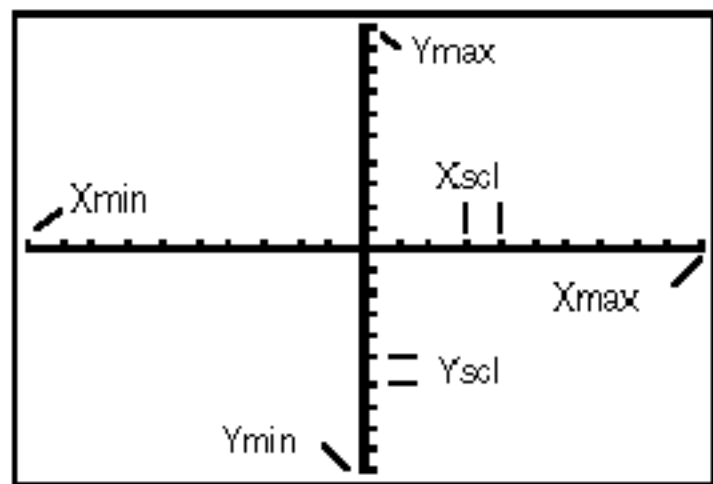

```
WINDOW
Xmin=-10
Xmax=10
Xscl=1
Ymin=-10
Ymax=10
Yscl=1
Xres=1
```

Displaying the Window Variables

To display the current window variable values, press **WINDOW**. The window editor above and to the right shows the default values in Func graphing mode and Radian angle mode. The window variables differ from one graphing mode to another.

Xres sets pixel resolution (1 through 8) for function graphs only. The default is 1.

- At **Xres=1**, functions are evaluated and graphed at each pixel on the x-axis.
- At **Xres=8**, functions are evaluated and graphed at every eighth pixel along the x-axis.

Note: Small **Xres** values improve graph resolution but may cause the TI-84 Plus to draw graphs more slowly.

Changing a Window Variable Value

To change a window variable value from the window editor, follow these steps.

1. Press \downarrow or \uparrow to move the cursor to the window variable you want to change.
2. Edit the value, which can be an expression.
 - Enter a new value, which clears the original value.
 - Move the cursor to a specific digit, and then edit it.
3. Press $\boxed{\text{ENTER}}$, \downarrow , or \uparrow . If you entered an expression, the TI-84 Plus evaluates it. The new value is stored.

Note: $X_{\min} < X_{\max}$ and $Y_{\min} < Y_{\max}$ must be true in order to graph.

Storing to a Window Variable from the Home Screen or a Program

To store a value, which can be an expression, to a window variable, begin on a blank line and follow these steps.

1. Enter the value you want to store.
2. Press $\boxed{\text{STO}} \blacktriangleright$.
3. Press $\boxed{\text{VARS}}$ to display the **VAR**s menu.
4. Select **1:Window** to display the **Func** window variables (**X/Y** secondary menu).
 - Press \blacktriangleright to display the **Par** and **PoI** window variables (**T/θ** secondary menu).

- Press $\boxed{\blacktriangleright} \boxed{\blacktriangleright}$ to display the **Seq** window variables (**U/V/W** secondary menu).
5. Select the window variable to which you want to store a value. The name of the variable is pasted to the current cursor location.
 6. Press $\boxed{\text{ENTER}}$ to complete the instruction.

When the instruction is executed, the TI-84 Plus stores the value to the window variable and displays the value.

```
14→Xmax      14
```

ΔX and ΔY

The variables ΔX and ΔY (items 8 and 9 on the VARS (**1:Window**) X/Y secondary menu) define the distance from the center of one pixel to the center of any adjacent pixel on a graph (graphing accuracy). ΔX and ΔY are calculated from **Xmin**, **Xmax**, **Ymin**, and **Ymax** when you display a graph.

$$\Delta X = \frac{(X_{\max} - X_{\min})}{94} \quad \Delta Y = \frac{(Y_{\max} - Y_{\min})}{62}$$

You can store values to ΔX and ΔY . If you do, **Xmax** and **Ymax** are calculated from ΔX , **Xmin**, ΔY , and **Ymin**.

Setting the Graph Format

Displaying the Format Settings

To display the format settings, press $\boxed{2nd}$ [FORMAT]. The default settings are highlighted below.

RectGC	PolarGC	Sets cursor coordinates.
CoordOn	CoordOff	Sets coordinates display on or off.
GridOff	GridOn	Sets grid off or on.
AxesOn	AxesOff	Sets axes on or off.
LabelOff	LabelOn	Sets axes label off or on.
ExprOn	ExprOff	Sets expression display on or off.

Format settings define a graph's appearance on the display. Format settings apply to all graphing modes. Seq graphing mode has an additional mode setting (Chapter 6).

Changing a Format Setting

To change a format setting, follow these steps.

1. Press $\boxed{\downarrow}$, $\boxed{\rightarrow}$, $\boxed{\uparrow}$, and $\boxed{\leftarrow}$ as necessary to move the cursor to the setting you want to select.
2. Press \boxed{ENTER} to select the highlighted setting.

RectGC, PolarGC

RectGC (rectangular graphing coordinates) displays the cursor location as rectangular coordinates X and Y .

PolarGC (polar graphing coordinates) displays the cursor location as polar coordinates R and θ .

The **RectGC/PolarGC** setting determines which variables are updated when you plot the graph, move the free-moving cursor, or trace.

- **RectGC** updates X and Y ; if **CoordOn** format is selected, X and Y are displayed.
- **PolarGC** updates X , Y , R , and θ ; if **CoordOn** format is selected, R and θ are displayed.

CoordOn, CoordOff

CoordOn (coordinates on) displays the cursor coordinates at the bottom of the graph. If **ExprOff** format is selected, the function number is displayed in the top-right corner.

CoordOff (coordinates off) does not display the function number or coordinates.

GridOff, GridOn

Grid points cover the viewing window in rows that correspond to the tick marks on each axis.

GridOff does not display grid points.

GridOn displays grid points.

AxesOn, AxesOff

AxesOn displays the axes.

AxesOff does not display the axes.

This overrides the **LabelOff/LabelOn** format setting.

LabelOff, LabelOn

LabelOff and **LabelOn** determine whether to display labels for the axes (X and Y), if **AxesOn** format is also selected.

ExprOn, ExprOff

ExprOn and **ExprOff** determine whether to display the Y= expression when the trace cursor is active. This format setting also applies to stat plots.

When **ExprOn** is selected, the expression is displayed in the top-left corner of the graph screen.

When **ExprOff** and **CoordOn** both are selected, the number in the top-right corner specifies which function is being traced.

Displaying Graphs

Displaying a New Graph

To display the graph of the selected function or functions, press **GRAPH**. TRACE, ZOOM instructions, and CALC operations display the graph automatically. As the TI-84 Plus plots the graph, the busy indicator is on. As the graph is plotted, X and Y are updated.

Pausing or Stopping a Graph

While plotting a graph, you can pause or stop graphing.

- Press **ENTER** to pause; then press **ENTER** to resume.
- Press **ON** to stop; then press **GRAPH** to redraw.

Smart Graph

Smart Graph is a TI-84 Plus feature that redisplay the last graph immediately when you press **GRAPH**, but only if all graphing factors that would cause replotting have remained the same since the graph was last displayed.

If you performed any of these actions since the graph was last displayed, the TI-84 Plus will replot the graph based on new values when you press **GRAPH**.

- Changed a mode setting that affects graphs
- Changed a function in the current picture
- Selected or deselected a function or stat plot

- Changed the value of a variable in a selected function
- Changed a window variable or graph format setting
- Cleared drawings by selecting **ClrDraw**
- Changed a stat plot definition

Overlaying Functions on a Graph

On the TI-84 Plus, you can graph one or more new functions without replotting existing functions. For example, store **sin(X)** to Y1 in the Y= editor and press **GRAPH**. Then store **cos(X)** to Y2 and press **GRAPH** again. The function Y2 is graphed on top of Y1, the original function.

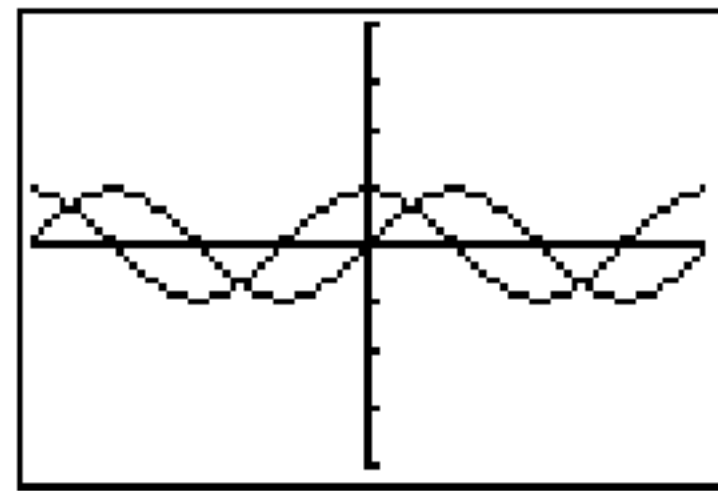
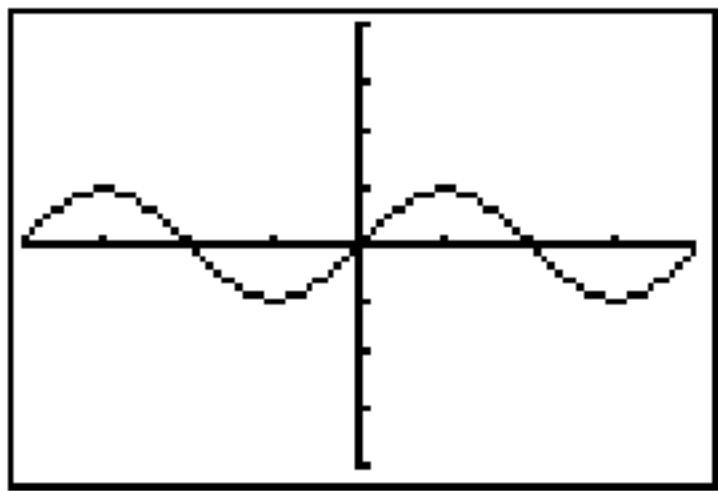

Graphing a Family of Curves

If you enter a list (Chapter 11) as an element in an expression, the TI-84 Plus plots the function for each value in the list, thereby graphing a family of curves. In Simul graphing-order mode, it graphs all functions sequentially for the first element in each list, and then for the second, and so on.

$\{2,4,6\}\sin(X)$ graphs three functions: $2 \sin(X)$, $4 \sin(X)$, and $6 \sin(X)$.

```
Plot1 Plot2 Plot3
\Y1={2,4,6}sin(X)
\Y2=
\Y3=
\Y4=
\Y5=
\Y6=
```

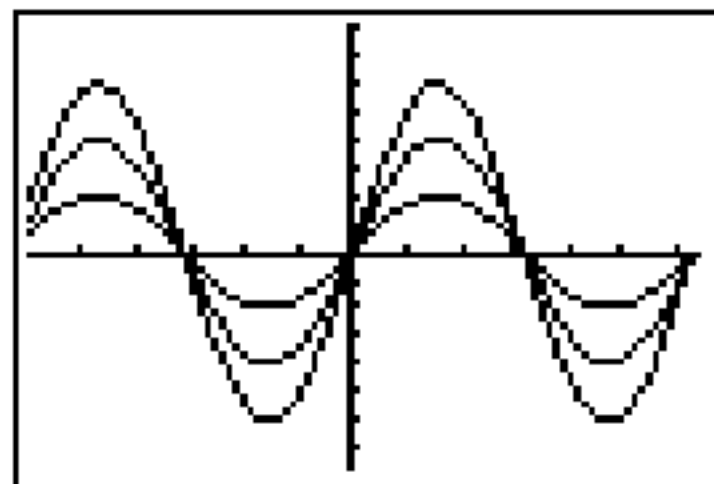

$\{2,4,6\}\sin(\{1,2,3\}X)$ graphs $2 \sin(X)$, $4 \sin(2X)$, and $6 \sin(3X)$.

```
Plot1 Plot2 Plot3
\Y1={2,4,6}sin(
1,2,3)X)
\Y2=
\Y3=
\Y4=
\Y5=
\Y6=
```

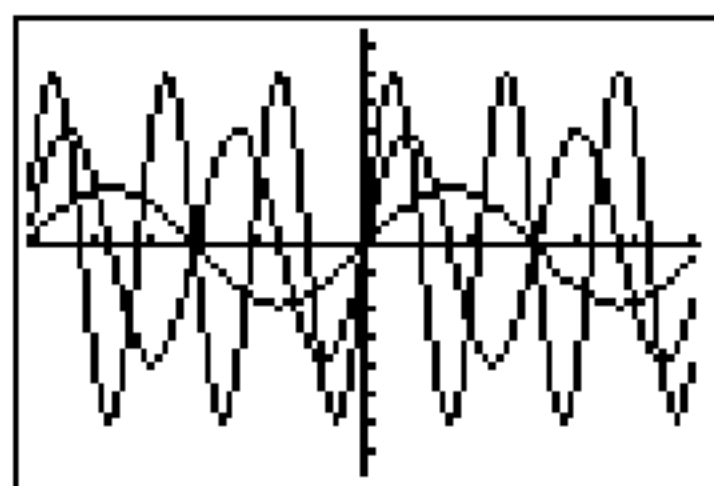

Note: When using more than one list, the lists must have the same dimensions.

Exploring Graphs with the Free-Moving Cursor

Free-Moving Cursor

When a graph is displayed, press \leftarrow , \rightarrow , \uparrow , or \downarrow to move the cursor around the graph. When you first display the graph, no cursor is visible. When you press \leftarrow , \rightarrow , \uparrow , or \downarrow , the cursor moves from the center of the viewing window.

As you move the cursor around the graph, the coordinate values of the cursor location are displayed at the bottom of the screen if **CoordOn** format is selected. The **Float/Fix** decimal mode setting determines the number of decimal digits displayed for the coordinate values.

To display the graph with no cursor and no coordinate values, press **CLEAR** or **ENTER**. When you press **◀**, **▶**, **▲**, or **▼**, the cursor moves from the same position.

Graphing Accuracy

The free-moving cursor moves from pixel to pixel on the screen. When you move the cursor to a pixel that appears to be on the function, the cursor may be near, but not actually on, the function. The coordinate value displayed at the bottom of the screen actually may not be a point on the function. To move the cursor along a function, use **TRACE**.

The coordinate values displayed as you move the cursor approximate actual math coordinates, *accurate to within the width and height of the pixel. As **Xmin**, **Xmax**, **Ymin**, and **Ymax** get closer together (as in a **Zoom In**) graphing accuracy increases, and the coordinate values more closely approximate the math coordinates.

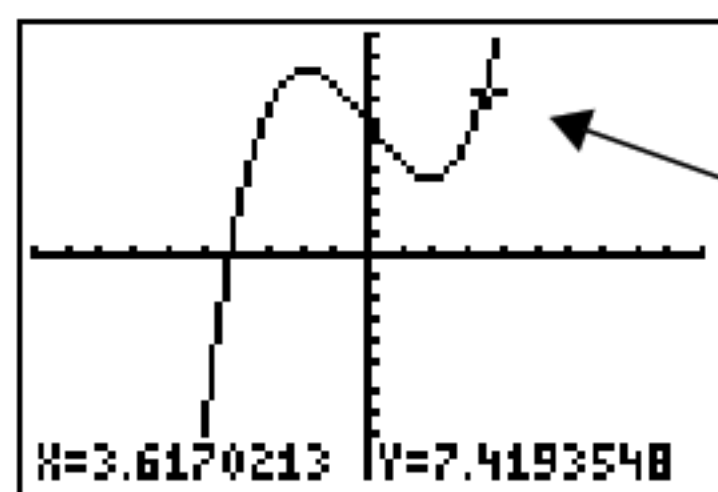

Free-moving cursor "on"
the curve

Exploring Graphs with TRACE

Beginning a Trace

Use TRACE to move the cursor from one plotted point to the next along a function. To begin a trace, press $\boxed{\text{TRACE}}$. If the graph is not displayed already, press $\boxed{\text{TRACE}}$ to display it. The trace cursor is on the first selected function in the Y= editor, at the middle X value on the screen. The cursor coordinates are displayed at the bottom of the screen if **CoordOn** format is selected. The Y= expression is displayed in the top-left corner of the screen, if **ExprOn** format is selected.

Moving the Trace Cursor

To move the TRACE cursor	do this:
To the previous or next plotted point,	press $\boxed{\leftarrow}$ or $\boxed{\rightarrow}$.
Five plotted points on a function (Xres affects this),	press $\boxed{2\text{nd}} \boxed{\leftarrow}$ or $\boxed{2\text{nd}} \boxed{\rightarrow}$.
To any valid X value on a function,	enter a value, and then press $\boxed{\text{ENTER}}$.
From one function to another,	press $\boxed{\uparrow}$ or $\boxed{\downarrow}$.

When the trace cursor moves along a function, the Y value is calculated from the X value; that is, $Y=Y_n(X)$. If the function is undefined at an X value, the Y value is blank.

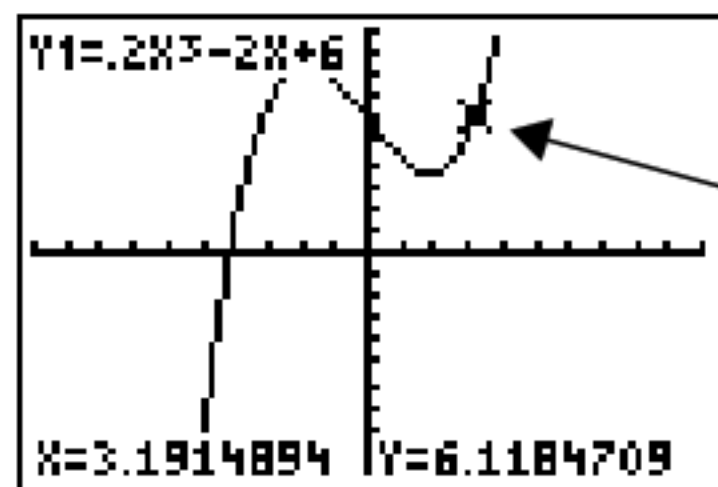

Trace cursor on the curve

If you move the trace cursor beyond the top or bottom of the screen, the coordinate values at the bottom of the screen continue to change appropriately.

Moving the Trace Cursor from Function to Function

To move the trace cursor from function to function, press \square and \square . The cursor follows the order of the selected functions in the Y= editor. The trace cursor moves to each function at the same X value. If **ExprOn** format is selected, the expression is updated.

Moving the Trace Cursor to Any Valid X Value

To move the trace cursor to any valid X value on the current function, enter the value. When you enter the first digit, an **X=** prompt and the number you entered are displayed in the bottom-left corner of the screen. You can enter an expression at the **X=** prompt. The

value must be valid for the current viewing window. When you have completed the entry, press **ENTER** to move the cursor.

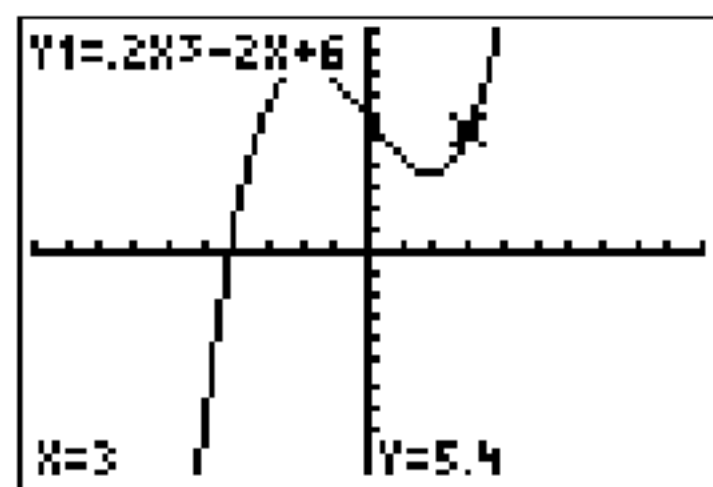
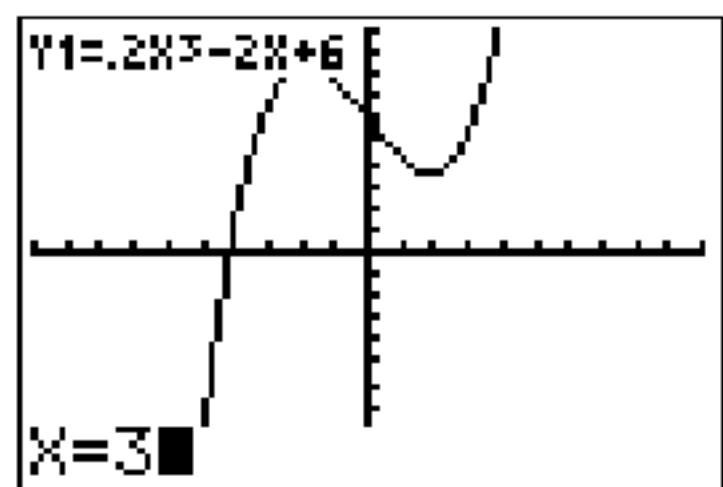

Note: This feature does not apply to stat plots.

Panning to the Left or Right

If you trace a function beyond the left or right side of the screen, the viewing window automatically pans to the left or right. **Xmin** and **Xmax** are updated to correspond to the new viewing window.

Quick Zoom

While tracing, you can press **ENTER** to adjust the viewing window so that the cursor location becomes the center of the new viewing window, even if the cursor is above or below the display. This allows panning up and down. After Quick Zoom, the cursor remains in TRACE.

Leaving and Returning to TRACE

When you leave and return to TRACE, the trace cursor is displayed in the same location it was in when you left TRACE, unless Smart Graph has replotted the graph.

Using TRACE in a Program

On a blank line in the program editor, press `TRACE`. The instruction **Trace** is pasted to the cursor location. When the instruction is encountered during program execution, the graph is displayed with the trace cursor on the first selected function. As you trace, the cursor coordinate values are updated. When you finish tracing the functions, press `ENTER` to resume program execution.

Exploring Graphs with the ZOOM Instructions

ZOOM Menu

To display the **ZOOM** menu, press `ZOOM`. You can adjust the viewing window of the graph quickly in several ways. All ZOOM instructions are accessible from programs.

ZOOM MEMORY

- | | | |
|----|----------|---|
| 1: | ZBox | Draws a box to define the viewing window. |
| 2: | Zoom In | Magnifies the graph around the cursor. |
| 3: | Zoom Out | Views more of a graph around the cursor. |
| 4: | ZDecimal | Sets ΔX and ΔY to 0.1. |
| 5: | ZSquare | Sets equal-size pixels on the X and Y axes. |
-

ZOOM MEMORY

6:	ZStandard	Sets the standard window variables.
7:	ZTrig	Sets the built-in trig window variables.
8:	ZInteger	Sets integer values on the X and Y axes.
9:	ZoomStat	Sets the values for current stat lists.
0:	ZoomFit	Fits YMin and YMax between XMin and XMax .

Zoom Cursor

When you select **1:ZBox**, **2:Zoom In**, or **3:Zoom Out**, the cursor on the graph becomes the zoom cursor (+), a smaller version of the free-moving cursor (+).

ZBox

To define a new viewing window using **ZBox**, follow these steps.

1. Select **1:ZBox** from the **ZOOM** menu. The zoom cursor is displayed at the center of the screen.
2. Move the zoom cursor to any spot you want to define as a corner of the box, and then press **ENTER**. When you move the cursor away from the first defined corner, a small, square dot indicates the spot.
3. Press **←**, **↑**, **→**, or **↓**. As you move the cursor, the sides of the box lengthen or shorten proportionately on the screen.

Note: To cancel **ZBox** before you press **ENTER**, press **CLEAR**.

4. When you have defined the box, press **ENTER** to replot the graph.

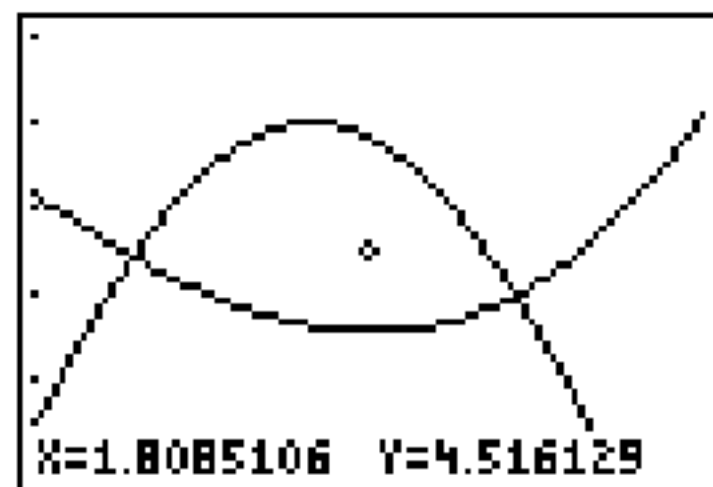
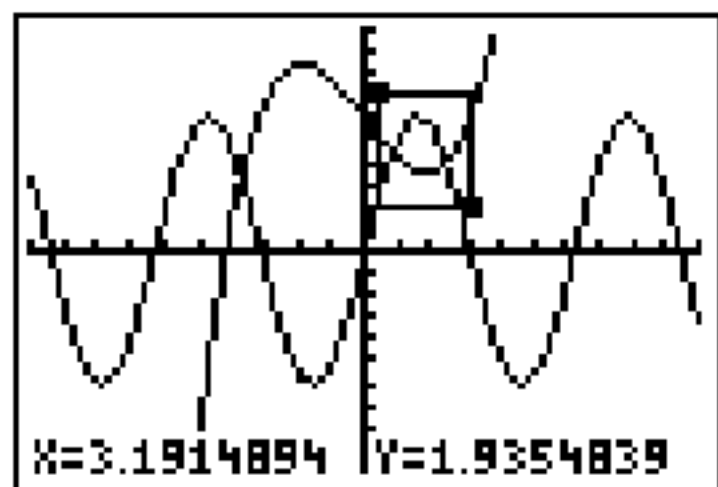

To use **ZBox** to define another box within the new graph, repeat steps 2 through 4. To cancel **ZBox**, press **CLEAR**.

Zoom In, Zoom Out

Zoom In magnifies the part of the graph that surrounds the cursor location. **Zoom Out** displays a greater portion of the graph, centered on the cursor location. The **XFact** and **YFact** settings determine the extent of the zoom.

To zoom in on a graph, follow these steps.

1. Check **XFact** and **YFact**; change as needed.
2. Select **2:Zoom In** from the **ZOOM** menu. The zoom cursor is displayed.
3. Move the zoom cursor to the point that is to be the center of the new viewing window.
4. Press **ENTER**. The TI-83 Plus adjusts the viewing window by **XFact** and **YFact**; updates the window variables; and replots the selected functions, centered on the cursor location.
5. Zoom in on the graph again in either of two ways.

- To zoom in at the same point, press **ENTER**.
- To zoom in at a new point, move the cursor to the point that you want as the center of the new viewing window, and then press **ENTER**.

To zoom out on a graph, select **3:Zoom Out** and repeat steps 3 through 5.

To cancel **Zoom In** or **Zoom Out**, press **CLEAR**.

ZDecimal

ZDecimal replots the functions immediately. It updates the window variables to preset values, as shown below. These values set ΔX and ΔY equal to 0.1 and set the X and Y value of each pixel to one decimal place.

Xmin=-4.7
Xmax=4.7
Xscl=1

Ymin=-3.1
Ymax=3.1
Yscl=1

ZSquare

ZSquare replots the functions immediately. It redefines the viewing window based on the current values of the window variables. It adjusts in only one direction so that $\Delta X = \Delta Y$, which makes the graph of a circle look like a circle. **Xscl** and **Yscl** remain unchanged. The midpoint of the current graph (not the intersection of the axes) becomes the midpoint of the new graph.

ZStandard

ZStandard replots the functions immediately. It updates the window variables to the standard values shown below.

Xmin=-10
Xmax=10
Xscl=1

Ymin=-10
Ymax=10
Yscl=1

Xres=1

ZTrig

ZTrig replots the functions immediately. It updates the window variables to preset values that are appropriate for plotting trig functions. Those preset values in Radian mode are shown below.

Xmin= $-(47/24)\pi$
Xmax= $(47/24)\pi$
Xscl= $\pi/2$

Ymin=-4
Ymax=4
Yscl=1

ZInteger

ZInteger redefines the viewing window to the dimensions shown below. To use **ZInteger**, move the cursor to the point that you want to be the center of the new window, and then press **ENTER**; **ZInteger** replots the functions.

$\Delta X=1$
 $\Delta Y=1$

Xscl=10
Yscl=10

ZoomStat

ZoomStat redefines the viewing window so that all statistical data points are displayed. For regular and modified box plots, only **Xmin** and **Xmax** are adjusted.

ZoomFit

ZoomFit replots the functions immediately. **ZoomFit** recalculates **YMin** and **YMax** to include the minimum and maximum Y values of the selected functions between the current **XMin** and **XMax**. **XMin** and **XMax** are not changed.

Using ZOOM MEMORY

ZOOM MEMORY Menu

To display the **ZOOM MEMORY** menu, press **ZOOM** .

ZOOM MEMORY

- | | | |
|----|---------------|---|
| 1: | ZPrevious | Uses the previous viewing window. |
| 2: | ZoomSto | Stores the user-defined window. |
| 3: | ZoomRcl | Recalls the user-defined window. |
| 4: | SetFactors... | Changes Zoom In and Zoom Out factors. |
-

ZPrevious

ZPrevious replots the graph using the window variables of the graph that was displayed before you executed the last ZOOM instruction.

ZoomSto

ZoomSto immediately stores the current viewing window. The graph is displayed, and the values of the current window variables are stored in the user-defined **ZOOM** variables **ZXmin**, **ZXmax**, **ZXscl**, **ZYmin**, **ZYmax**, **ZYscl**, and **ZXres**.

These variables apply to all graphing modes. For example, changing the value of **ZXmin** in Func mode also changes it in Par mode.

ZoomRcl

ZoomRcl graphs the selected functions in a user-defined viewing window. The user-defined viewing window is determined by the values stored with the **ZoomSto** instruction. The window variables are updated with the user-defined values, and the graph is plotted.

ZOOM FACTORS

The zoom factors, **XFact** and **YFact**, are positive numbers (not necessarily integers) greater than or equal to 1. They define the magnification or reduction factor used to **Zoom In** or **Zoom Out** around a point.

Checking XFact and YFact

To display the ZOOM FACTORS screen, where you can review the current values for **XFact** and **YFact**, select **4:SetFactors** from the **ZOOM MEMORY** menu. The values shown are the defaults.

```
ZOOM FACTORS
XFact=4
YFact=4
```

Changing XFact and YFact

You can change **XFact** and **YFact** in either of two ways.

- Enter a new value. The original value is cleared automatically when you enter the first digit.
- Place the cursor on the digit you want to change, and then enter a value or press **DEL** to delete it.

Using ZOOM MEMORY Menu Items from the Home Screen or a Program

From the home screen or a program, you can store directly to any of the user-defined ZOOM variables.

```
-5→Zxmin:5→Zxmax
5
```

From a program, you can select the **ZoomSto** and **ZoomRcl** instructions from the **ZOOM MEMORY** menu.

Using the CALC (Calculate) Operations

CALCULATE Menu

To display the **CALCULATE** menu, press $\boxed{2\text{nd}}$ [CALC]. Use the items on this menu to analyze the current graph functions.

CALCULATE

1:	value	Calculates a function Y value for a given X.
2:	zero	Finds a zero (x-intercept) of a function.
3:	minimum	Finds a minimum of a function.
4:	maximum	Finds a maximum of a function.
5:	intersect	Finds an intersection of two functions.
6:	dy/dx	Finds a numeric derivative of a function.
7:	$\int f(x) dx$	Finds a numeric integral of a function.

value

value evaluates one or more currently selected functions for a specified value of X.

Note: When a value is displayed for X, press $\boxed{\text{CLEAR}}$ to clear the value. When no value is displayed, press $\boxed{\text{CLEAR}}$ to cancel the **value** operation.

To evaluate a selected function at X, follow these steps.

1. Select **1:value** from the **CALCULATE** menu. The graph is displayed with **X=** in the bottom-left corner.
2. Enter a real value, which can be an expression, for **X** between **Xmin** and **Xmax**.
3. Press **ENTER**.

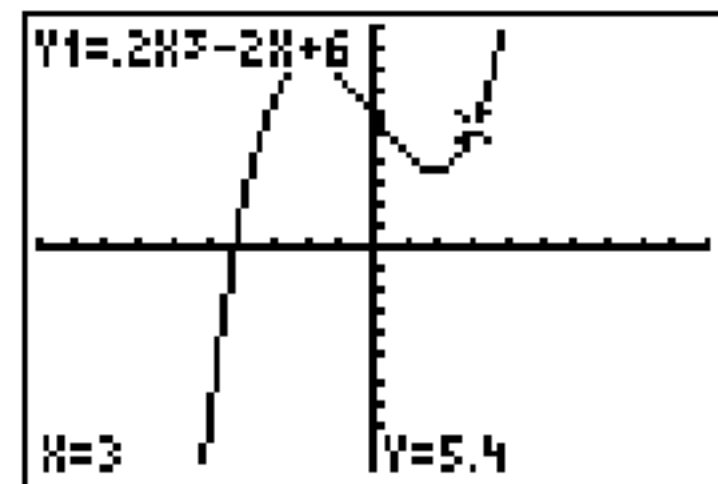
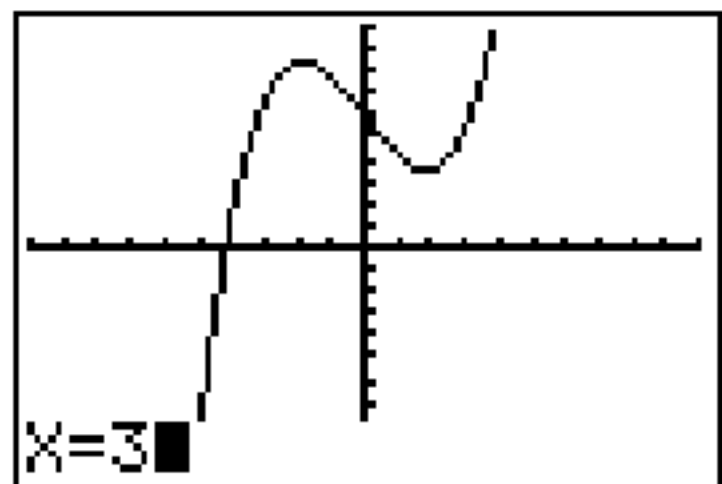

The cursor is on the first selected function in the **Y=** editor at the **X** value you entered, and the coordinates are displayed, even if **CoordOff** format is selected.

To move the cursor from function to function at the entered **X** value, press \uparrow or \downarrow . To restore the free-moving cursor, press \leftarrow or \rightarrow .

zero

zero finds a zero (x-intercept or root) of a function using **solve()**. Functions can have more than one x-intercept value; **zero** finds the zero closest to your guess.

The time **zero** spends to find the correct zero value depends on the accuracy of the values you specify for the left and right bounds and the accuracy of your guess.

To find a zero of a function, follow these steps.

1. Select **2:zero** from the **CALCULATE** menu. The current graph is displayed with `Left Bound?` in the bottom-left corner.
2. Press \uparrow or \downarrow to move the cursor onto the function for which you want to find a zero.
3. Press \leftarrow or \rightarrow (or enter a value) to select the x-value for the left bound of the interval, and then press `ENTER`. A \blacktriangleright indicator on the graph screen shows the left bound. `Right Bound?` is displayed in the bottom-left corner. Press \leftarrow or \rightarrow (or enter a value) to select the x-value for the right bound, and then press `ENTER`. A \blacktriangleleft indicator on the graph screen shows the right bound. `Guess?` is then displayed in the bottom-left corner.

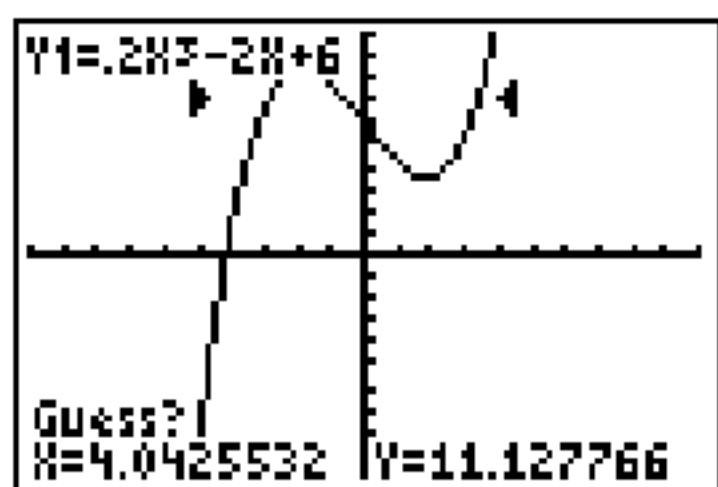

4. Press \leftarrow or \rightarrow (or enter a value) to select a point near the zero of the function, between the bounds, and then press `ENTER`.

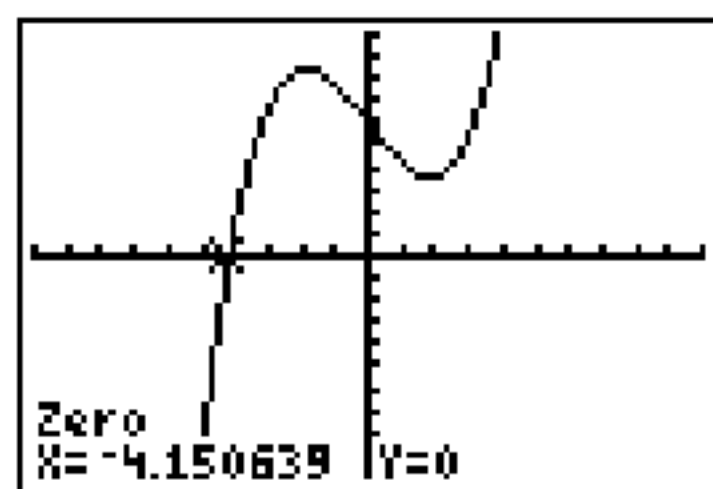
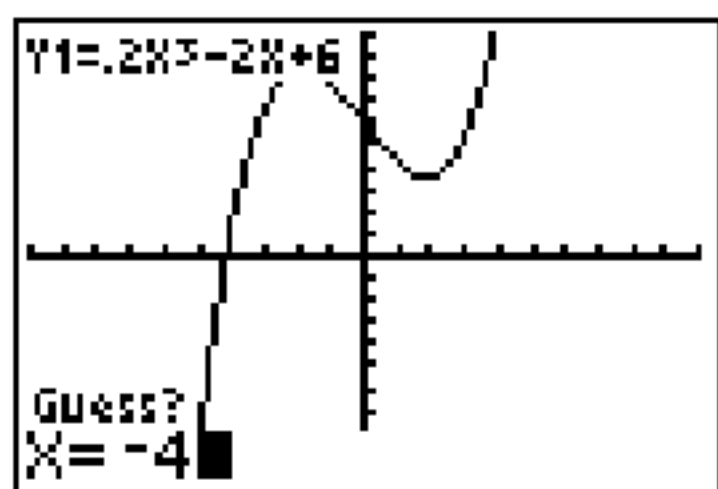

The cursor is on the solution and the coordinates are displayed, even if **CoordOff** format is selected. To move to the same x-value for other selected functions, press \uparrow or \downarrow . To restore the free-moving cursor, press \leftarrow or \rightarrow .

minimum, maximum

minimum and **maximum** find a minimum or maximum of a function within a specified interval to a tolerance of $1E-5$.

To find a minimum or maximum, follow these steps.

1. Select **3:minimum** or **4:maximum** from the **CALCULATE** menu. The current graph is displayed.
2. Select the function and set left bound, right bound, and guess as described for **zero**.

The cursor is on the solution, and the coordinates are displayed, even if you have selected **CoordOff** format; **Minimum** or **Maximum** is displayed in the bottom-left corner.

To move to the same x-value for other selected functions, press \square or \square . To restore the free-moving cursor, press \square or \square .

intersect

intersect finds the coordinates of a point at which two or more functions intersect using **solve(**. The intersection must appear on the display to use **intersect**.

To find an intersection, follow these steps.

1. Select **5:intersect** from the **CALCULATE** menu. The current graph is displayed with `First curve?` in the bottom-left corner.

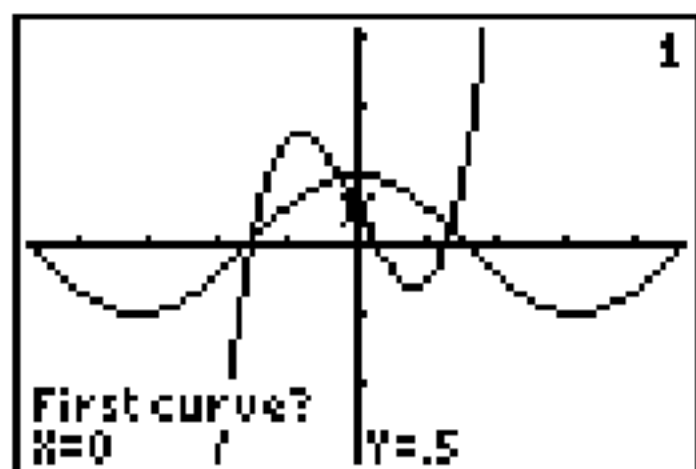

2. Press \downarrow or \uparrow , if necessary, to move the cursor to the first function, and then press ENTER . *Second curve?* is displayed in the bottom-left corner.
3. Press \downarrow or \uparrow , if necessary, to move the cursor to the second function, and then press ENTER .
4. Press \rightarrow or \leftarrow to move the cursor to the point that is your guess as to location of the intersection, and then press ENTER .

The cursor is on the solution and the coordinates are displayed, even if **CoordOff** format is selected. **Intersection** is displayed in the bottom-left corner. To restore the free-moving cursor, press \leftarrow , \uparrow , \rightarrow , or \downarrow .

dy/dx

dy/dx (numerical derivative) finds the numerical derivative (slope) of a function at a point, with $\epsilon=1E-3$.

To find a function's slope at a point, follow these steps.

1. Select **6:dy/dx** from the **CALCULATE** menu. The current graph is displayed.
2. Press \uparrow or \downarrow to select the function for which you want to find the numerical derivative.

3. Press \leftarrow or \rightarrow (or enter a value) to select the X value at which to calculate the derivative, and then press **ENTER**.

The cursor is on the solution and the numerical derivative is displayed.

To move to the same x-value for other selected functions, press \uparrow or \downarrow . To restore the free-moving cursor, press \leftarrow or \rightarrow .

$\int f(x)dx$

$\int f(x)dx$ (numerical integral) finds the numerical integral of a function in a specified interval. It uses the **fnInt**(function, with a tolerance of $\epsilon=1E-3$.

To find the numerical integral of a function, follow these steps.

1. Select **7: $\int f(x)dx$** from the **CALCULATE** menu. The current graph is displayed with `Lower Limit?` in the bottom-left corner.
2. Press \uparrow or \downarrow to move the cursor to the function for which you want to calculate the integral.

3. Set lower and upper limits as you would set left and right bounds for **zero**. The integral value is displayed, and the integrated area is shaded.

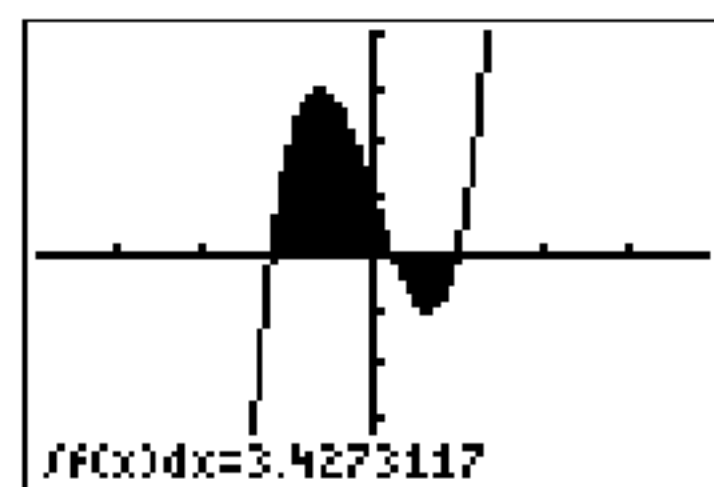
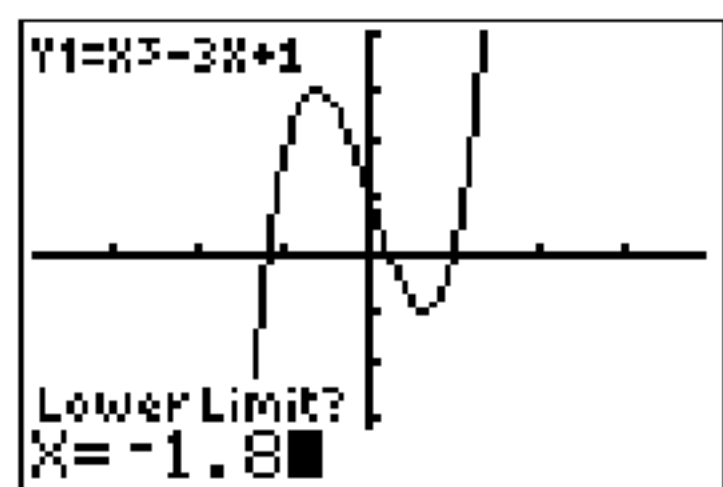

Note: The shaded area is a drawing. Use **ClrDraw** (Chapter 8) or any action that invokes Smart Graph to clear the shaded area.

Chapter 4: Parametric Graphing

Getting Started: Path of a Ball

Getting Started is a fast-paced introduction. Read the chapter for details.

Graph the parametric equation that describes the path of a ball hit at an initial speed of 30 meters per second, at an initial angle of 25 degrees with the horizontal from ground level. How far does the ball travel? When does it hit the ground? How high does it go? Ignore all forces except gravity.

For initial velocity v_0 and angle θ , the position of the ball as a function of time has horizontal and vertical components.

$$\text{Horizontal: } X_1(t) = tv_0 \cos(\theta) \quad \text{Vertical: } Y_1(t) = tv_0 \sin(\theta) - \frac{1}{2} gt^2$$

The vertical and horizontal vectors of the ball's motion also will be graphed.

Vertical vector:	$X_2(t) = 0$	$Y_2(t) = Y_1(t)$
Horizontal vector:	$X_3(t) = X_1(t)$	$Y_3(t) = 0$
Gravity constant:	$g = 9.8 \text{ m/sec}^2$	

1. Press **MODE**. Press $\downarrow \downarrow \downarrow \rightarrow$ **ENTER** to select **Par** mode. Press $\downarrow \downarrow \rightarrow$ **ENTER** to select **Simul** for simultaneous graphing of all three parametric equations in this example.

```

NORMAL SCI ENG
FLOAT 0 1 2 3 4 5 6 7 8 9
RADIAN DEGREE
FUNC PAR POL SEQ
CONNECTED DOT
SEQUENTIAL SIMUL
REAL a+bi P e^0i
FULL HORIZ G-T
SETCLOCK 03/18/04 2:08PM

```

2. Press **Y=**. Press **30** $\langle X,T,\theta,n \rangle$ **COS** **25** **2nd** **[ANGLE]** **1** (to select $^\circ$) **)** **ENTER** to define **X1T** in terms of **T**.

```

Plot1 Plot2 Plot3
\X1T 30Tcos(25°)
Y1T 30Tsin(25°)
-9.8/2T²
\X2T =
Y2T =
\X3T =

```

3. Press **30** $\langle X,T,\theta,n \rangle$ **SIN** **25** **2nd** **[ANGLE]** **1** **)** **-** **9.8** **÷** **2** $\langle X,T,\theta,n \rangle$ **x²** **ENTER** to define **Y1T**.

The vertical component vector is defined by **X2T** and **Y2T**.

4. Press **0** **ENTER** to define **X2T**.

```

Plot1 Plot2 Plot3
\X1T 30Tcos(25°)
Y1T 30Tsin(25°)
-9.8/2T²
\X2T 0
Y2T =
\X3T =

```

5. Press **VARs** \rightarrow to display the **VARs Y-VARS** menu. Press **2** to display the **PARAMETRIC** secondary menu. Press **2** **ENTER** to define **Y2T**.

```

Plot1 Plot2 Plot3
\X1T 30Tcos(25°)
Y1T 30Tsin(25°)
-9.8/2T²
\X2T 0
Y2T Y1T
\X3T =

```

The horizontal component vector is defined by **X3T** and **Y3T**.

6. Press **[VARS]** **[▶]** **2**, and then press **1** **[ENTER]** to define **X3T**. Press **0** **[ENTER]** to define **Y3T**.

```
Plot1 Plot2 Plot3
Y1T  $\equiv$  30Tsin(25°)
-9.8/2T²
X2T  $\equiv$  0
Y2T  $\equiv$  Y1T
X3T  $\equiv$  X1T
Y3T  $\equiv$  0
X4T  $\equiv$ 
```

7. Press **[◀]** **[◀]** **[▶]** **[ENTER]** to change the graph style to \curvearrowright for **X3T** and **Y3T**. Press **[▶]** **[ENTER]** **[ENTER]** to change the graph style to \curvearrowleft for **X2T** and **Y2T**. Press **[▶]** **[ENTER]** **[ENTER]** to change the graph style to \curvearrowright for **X1T** and **Y1T**. (These keystrokes assume that all graph styles were set to \curvearrowleft originally.)

```
Plot1 Plot2 Plot3
X1T  $\equiv$  30Tcos(25°)
Y1T  $\equiv$  30Tsin(25°)
-9.8/2T²
X2T  $\equiv$  0
Y2T  $\equiv$  Y1T
X3T  $\equiv$  X1T
```

8. Press **[WINDOW]**. Enter these values for the window variables.

Tmin=0	Xmin=-10	Ymin=-5
Tmax=5	Xmax=100	Ymax=15
Tstep=.1	Xscl=50	Yscl=10

```
WINDOW
Tstep=.1
Xmin=-10
Xmax=100
Xscl=50
Ymin=-5
Ymax=15
Yscl=10
```

9. Press **[2nd]** **[FORMAT]** **[▶]** **[▶]** **[▶]** **[▶]** **[ENTER]** to set **AxesOff**, which turns off the axes.

```
RectGC PolarGC
CoordOn CoordOff
GridOff GridOn
AxesOn AxesOff
LabelOff LabelOn
ExprOn ExprOff
```

10. Press **GRAPH**. The plotting action simultaneously shows the ball in flight and the vertical and horizontal component vectors of the motion.

Note: To simulate the ball flying through the air, set graph style to \ddagger (animate) for **X1T** and **Y1T**.

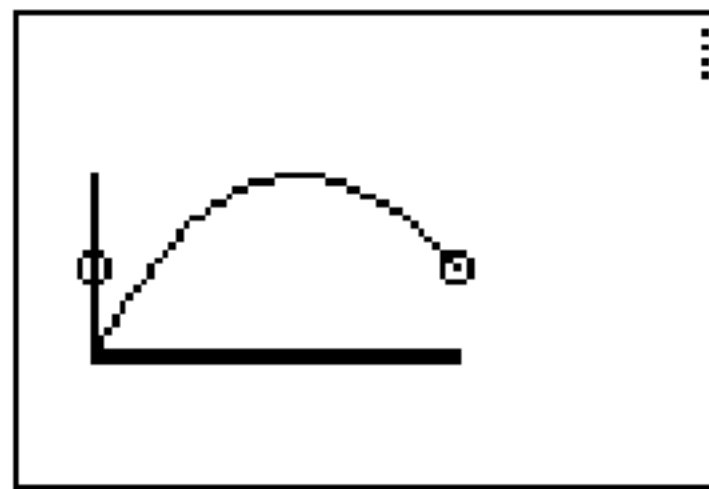

11. Press **TRACE** to obtain numerical results and answer the questions at the beginning of this section.

Tracing begins at **Tmin** on the first parametric equation (**X1T** and **Y1T**). As you press \blacktriangleright to trace the curve, the cursor follows the path of the ball over time. The values for **X** (distance), **Y** (height), and **T** (time) are displayed at the bottom of the screen.

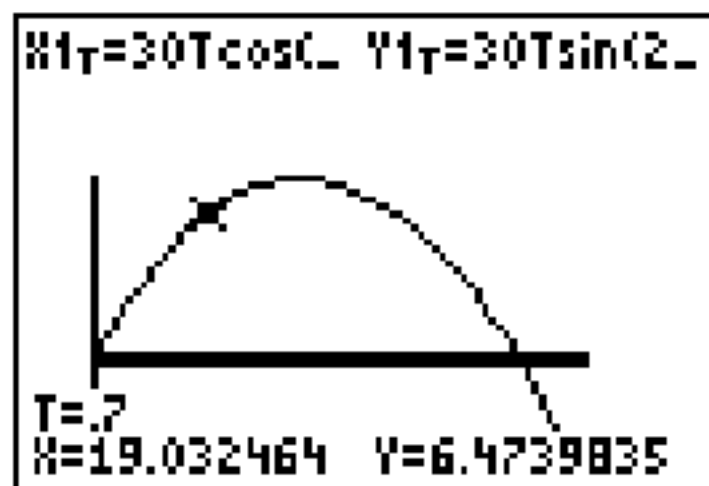

Defining and Displaying Parametric Graphs

TI-84 Plus Graphing Mode Similarities

The steps for defining a parametric graph are similar to the steps for defining a function graph. Chapter 4 assumes that you are familiar with Chapter 3: Function Graphing. Chapter 4 details aspects of parametric graphing that differ from function graphing.

Setting Parametric Graphing Mode

To display the mode screen, press $\boxed{\text{MODE}}$. To graph parametric equations, you must select Par graphing mode before you enter window variables and before you enter the components of parametric equations.

Displaying the Parametric Y= Editor

After selecting Par graphing mode, press $\boxed{\text{Y=}}$ to display the parametric Y= editor.

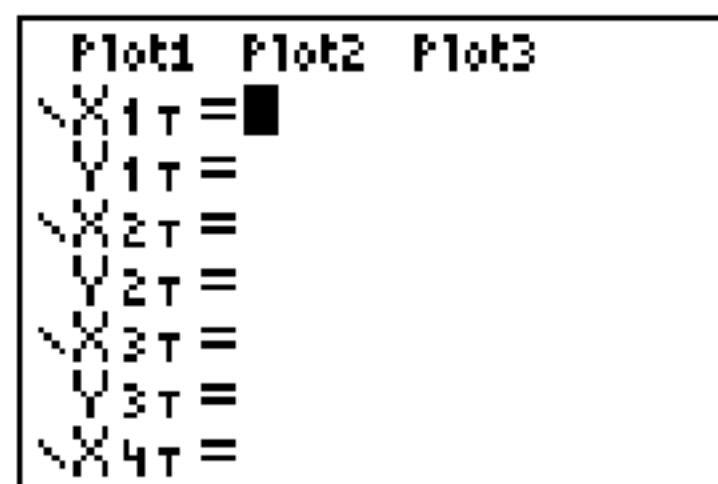

In this editor, you can display and enter both the X and Y components of up to six equations, **X1T** and **Y1T** through **X6T** and **Y6T**. Each is defined in terms of the independent variable **T**. A common application of parametric graphs is graphing equations over time.

Selecting a Graph Style

The icons to the left of **X1T** through **X6T** represent the graph style of each parametric equation. The default in Par mode is --- (line), which connects plotted points. Line, --- (thick), --- (path), --- (animate), and --- (dot) styles are available for parametric graphing.

Defining and Editing Parametric Equations

To define or edit a parametric equation, follow the steps in Chapter 3 for defining a function or editing a function. The independent variable in a parametric equation is T . In Par graphing mode, you can enter the parametric variable T in either of two ways.

- Press $\boxed{X,T,\Theta,n}$.
- Press $\boxed{\text{ALPHA}} \boxed{[T]}$.

Two components, X and Y , define a single parametric equation. You must define both of them.

Selecting and Deselecting Parametric Equations

The TI-84 Plus graphs only the selected parametric equations. In the $Y=$ editor, a parametric equation is selected when the $=$ signs of both the X and Y components are highlighted. You may select any or all of the equations $X1T$ and $Y1T$ through $X6T$ and $Y6T$.

To change the selection status, move the cursor onto the $=$ sign of either the X or Y component and press $\boxed{\text{ENTER}}$. The status of both the X and Y components is changed.

Setting Window Variables

To display the window variable values, press `WINDOW`. These variables define the viewing window. The values below are defaults for Par graphing in Radian angle mode.

<code>Tmin=0</code>	Smallest T value to evaluate
<code>Tmax=6.2831853...</code>	Largest T value to evaluate (2π)
<code>Tstep=.1308996...</code>	T value increment ($\pi/24$)
<code>Xmin=-10</code>	Smallest X value to be displayed
<code>Xmax=10</code>	Largest X value to be displayed
<code>Xscl=1</code>	Spacing between the X tick marks
<code>Ymin=-10</code>	Smallest Y value to be displayed
<code>Ymax=10</code>	Largest Y value to be displayed
<code>Yscl=1</code>	Spacing between the Y tick marks

Note: To ensure that sufficient points are plotted, you may want to change the T window variables.

Setting the Graph Format

To display the current graph format settings, press `2nd` `[FORMAT]`. Chapter 3 describes the format settings in detail. The other graphing modes share these format settings; Seq graphing mode has an additional axes format setting.

Displaying a Graph

When you press **GRAPH**, the TI-84 Plus plots the selected parametric equations. It evaluates the X and Y components for each value of **T** (from **Tmin** to **Tmax** in intervals of **Tstep**), and then plots each point defined by X and Y. The window variables define the viewing window.

As the graph is plotted, X, Y, and T are updated.

Smart Graph applies to parametric graphs.

Window Variables and Y-VARS Menus

You can perform these actions from the home screen or a program.

- Access functions by using the name of the X or Y component of the equation as a variable.

```
X1T*.5
94.70916375
```

- Store parametric equations.

```
"sin(T)"→X1T Done
"cos(T)"→Y1T Done
```

```
Plot1 Plot2 Plot3
X1T sin(T)
Y1T cos(T)
X2T =
Y2T =
```

- Select or deselect parametric equations.

```
FnOff 1
Done
```

```
Plot1 Plot2 Plot3
X1T=cos(T)
Y1T=sin(T)
X2T=
Y2T=
```

- Store values directly to window variables.

```
360→Tmax
360
```

Exploring Parametric Graphs

Free-Moving Cursor

The free-moving cursor in Par graphing works the same as in Func graphing.

In **RectGC** format, moving the cursor updates the values of X and Y; if **CoordOn** format is selected, X and Y are displayed.

In **PolarGC** format, X, Y, R, and θ are updated; if **CoordOn** format is selected, R and θ are displayed.

TRACE

To activate TRACE, press `TRACE`. When TRACE is active, you can move the trace cursor along the graph of the equation one **Tstep** at a time. When you begin a trace, the trace

cursor is on the first selected function at **Tmin**. If **ExprOn** is selected, then the function is displayed.

In **RectGC** format, TRACE updates and displays the values of X, Y, and T if **CoordOn** format is on.

In **PolarGC** format, X, Y, R, θ and T are updated; if **CoordOn** format is selected, R, θ , and T are displayed. The X and Y (or R and θ) values are calculated from T.

To move five plotted points at a time on a function, press $\boxed{2\text{nd}} \boxed{\leftarrow}$ or $\boxed{2\text{nd}} \boxed{\rightarrow}$. If you move the cursor beyond the top or bottom of the screen, the coordinate values at the bottom of the screen continue to change appropriately.

Quick Zoom is available in Par graphing; panning is not.

Moving the Trace Cursor to Any Valid T Value

To move the trace cursor to any valid **T** value on the current function, enter the number. When you enter the first digit, a **T=** prompt and the number you entered are displayed in the bottom-left corner of the screen. You can enter an expression at the **T=** prompt. The value must be valid for the current viewing window. When you have completed the entry, press $\boxed{\text{ENTER}}$ to move the cursor.

```

Plot1 Plot2 Plot3
X1T=sin(T)
Y1T=T

```

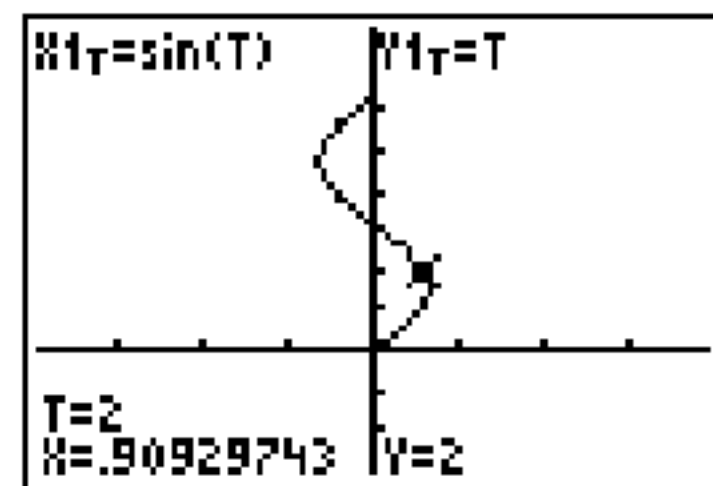
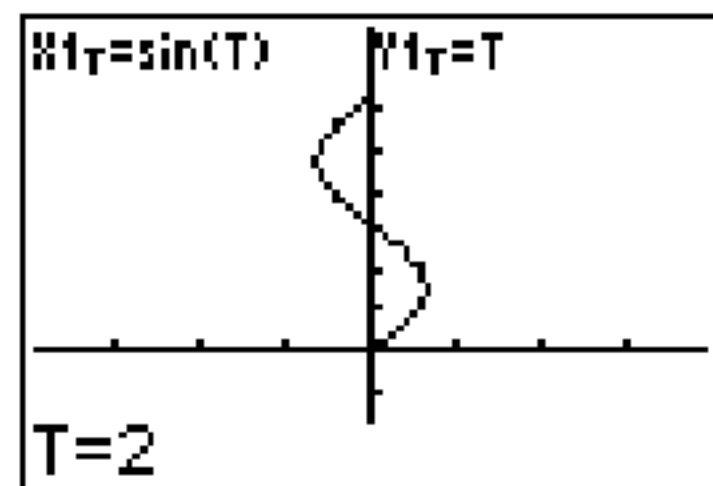

ZOOM

ZOOM operations in Par graphing work the same as in Func graphing. Only the **X** (**Xmin**, **Xmax**, and **Xscl**) and **Y** (**Ymin**, **Ymax**, and **Yscl**) window variables are affected.

The **T** window variables (**Tmin**, **Tmax**, and **Tstep**) are only affected when you select **ZStandard**. The **VARS ZOOM** secondary menu **ZT/Zθ** items **1:ZTmin**, **2:ZTmax**, and **3:ZTstep** are the zoom memory variables for Par graphing.

CALC

CALC operations in Par graphing work the same as in Func graphing. The **CALCULATE** menu items available in Par graphing are **1:value**, **2:dy/dx**, **3:dy/dt**, and **4:dx/dt**.

Chapter 5: Polar Graphing

Getting Started: Polar Rose

Getting Started is a fast-paced introduction. Read the chapter for details.

The polar equation $R=A\sin(B\theta)$ graphs a rose. Graph the rose for $A=8$ and $B=2.5$, and then explore the appearance of the rose for other values of A and B .

1. Press **MODE** to display the **MODE** screen. Press **ENTER** to select **Pol** graphing mode. Select the defaults (the options on the left) for the other mode settings.
2. Press **Y=** to display the polar $Y=$ editor. Press **8** **SIN** **2.5** **(X,T,θ,n)** **)** **ENTER** to define r_1 .
3. Press **ZOOM** **6** to select **6:ZStandard** and graph the equation in the standard viewing window. The graph shows only five petals of the rose, and the rose does not appear to be symmetrical. This is because the standard window sets $\theta_{\max}=2\pi$ and defines the window, rather than the pixels, as square.

```
Plot1 Plot2 Plot3
✓P1=8sin(2.5θ)
✓P2=
✓P3=
✓P4=
✓P5=
✓P6=
```

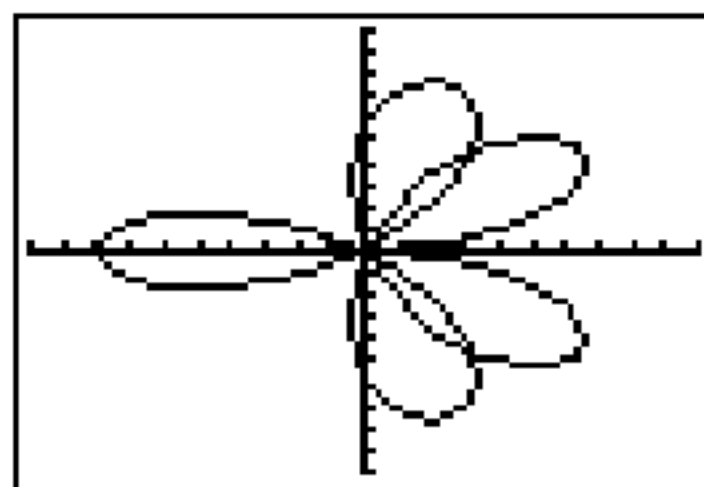

4. Press **WINDOW** to display the window variables.
Press **4** **2nd** **[π]** to increase the value of θ_{\max} to 4π .

```
WINDOW
θmin=0
θmax=4π
θstep=.1308996...
Xmin=-10
Xmax=10
Xscl=1
↓Ymin=-10
```

5. Press **ZOOM** **5** to select **5:ZSquare** and plot the graph.

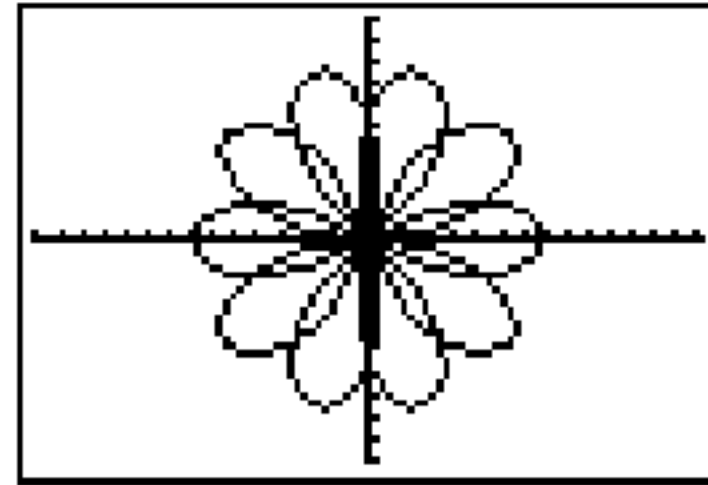

6. Repeat steps 2 through 5 with new values for the variables **A** and **B** in the polar equation $r_1 = A \sin(B\theta)$. Observe how the new values affect the graph.

Defining and Displaying Polar Graphs

TI-84 Plus Graphing Mode Similarities

The steps for defining a polar graph are similar to the steps for defining a function graph. Chapter 5 assumes that you are familiar with Chapter 3: Function Graphing. Chapter 5 details aspects of polar graphing that differ from function graphing.

Setting Polar Graphing Mode

To display the mode screen, press **MODE**. To graph polar equations, you must select Pol graphing mode before you enter values for the window variables and before you enter polar equations.

Displaying the Polar Y= Editor

After selecting Pol graphing mode, press **Y=** to display the polar Y= editor.

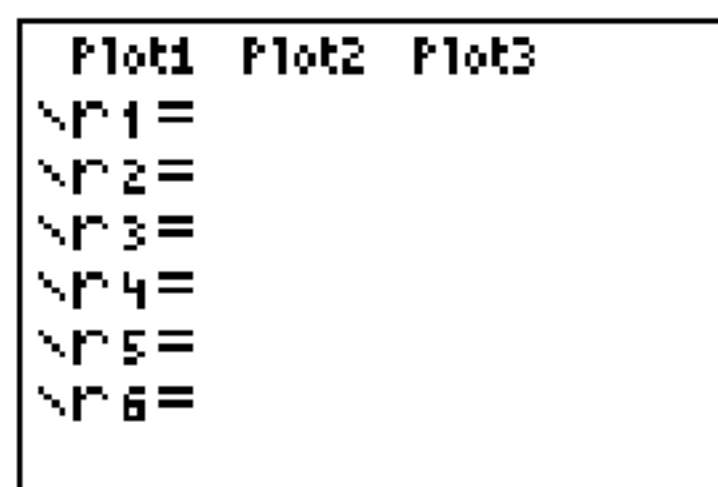

In this editor, you can enter and display up to six polar equations, **r1** through **r6**. Each is defined in terms of the independent variable θ .

Selecting Graph Styles

The icons to the left of **r1** through **r6** represent the graph style of each polar equation. The default in Pol graphing mode is \backslash (line), which connects plotted points. Line, thick (thick), path (path), animate (animate), and dot (dot) styles are available for polar graphing.

Defining and Editing Polar Equations

To define or edit a polar equation, follow the steps in Chapter 3 for defining a function or editing a function. The independent variable in a polar equation is θ . In Pol graphing mode, you can enter the polar variable θ in either of two ways.

- Press $\boxed{X,T,\theta,n}$.
- Press $\boxed{\text{ALPHA}} \boxed{\theta}$.

Selecting and Deselecting Polar Equations

The TI-84 Plus graphs only the selected polar equations. In the Y= editor, a polar equation is selected when the = sign is highlighted. You may select any or all of the equations.

To change the selection status, move the cursor onto the = sign, and then press $\boxed{\text{ENTER}}$.

Setting Window Variables

To display the window variable values, press $\boxed{\text{WINDOW}}$. These variables define the viewing window. The values below are defaults for Pol graphing in Radian angle mode.

$\theta_{\min}=0$	Smallest θ value to evaluate
$\theta_{\max}=6.2831853\dots$	Largest θ value to evaluate (2π)
$\theta_{\text{step}}=.1308996\dots$	Increment between θ values ($\pi/24$)
$X_{\min}=-10$	Smallest X value to be displayed

Xmax=10	Largest X value to be displayed
Xscl=1	Spacing between the X tick marks
Ymin=-10	Smallest Y value to be displayed
Ymax=10	Largest Y value to be displayed
Yscl=1	Spacing between the Y tick marks

Note: To ensure that sufficient points are plotted, you may want to change the θ window variables.

Setting the Graph Format

To display the current graph format settings, press $\boxed{2nd}$ [FORMAT]. Chapter 3 describes the format settings in detail. The other graphing modes share these format settings.

Displaying a Graph

When you press \boxed{GRAPH} , the TI-84 Plus plots the selected polar equations. It evaluates R for each value of θ (from θ_{min} to θ_{max} in intervals of θ_{step}) and then plots each point. The window variables define the viewing window.

As the graph is plotted, X , Y , R , and θ are updated.

Smart Graph applies to polar graphs.

Window Variables and Y-VARS Menus

You can perform these actions from the home screen or a program.

- Access functions by using the name of the equation as a variable.

```
r1+r2      8
```

- Store polar equations.

```
"5θ"→r1    Done
```

```
Plot1 Plot2 Plot3  
√r1 5θ  
√r2 =
```

- Select or deselect polar equations.

```
FnOff 1     Done
```

```
Plot1 Plot2 Plot3  
√r1 5θ  
√r2 =
```

- Store values directly to window variables.

```
θ→θmin     0
```

Exploring Polar Graphs

Free-Moving Cursor

The free-moving cursor in Pol graphing works the same as in Func graphing. In **RectGC** format, moving the cursor updates the values of X and Y; if **CoordOn** format is selected, X and Y are displayed. In **PolarGC** format, X, Y, R, and θ are updated; if **CoordOn** format is selected, R and θ are displayed.

TRACE

To activate TRACE, press **TRACE**. When TRACE is active, you can move the trace cursor along the graph of the equation one θ **step** at a time. When you begin a trace, the trace cursor is on the first selected function at θ **min**. If **ExprOn** format is selected, then the equation is displayed.

In **RectGC** format, TRACE updates the values of X, Y, and θ ; if **CoordOn** format is selected, X, Y, and θ are displayed. In **PolarGC** format, TRACE updates X, Y, R, and θ ; if **CoordOn** format is selected, R and θ are displayed.

To move five plotted points at a time on a function, press **2nd** **◀** or **2nd** **▶**. If you move the trace cursor beyond the top or bottom of the screen, the coordinate values at the bottom of the screen continue to change appropriately.

Quick Zoom is available in Pol graphing mode; panning is not.

Moving the Trace Cursor to Any Valid Theta Value

To move the trace cursor to any valid θ value on the current function, enter the number. When you enter the first digit, a $\theta=$ prompt and the number you entered are displayed in the bottom-left corner of the screen. You can enter an expression at the $\theta=$ prompt. The value must be valid for the current viewing window. When you complete the entry, press **ENTER** to move the cursor.

ZOOM

ZOOM operations in Pol graphing work the same as in Func graphing. Only the **X** (**Xmin**, **Xmax**, and **Xscl**) and **Y** (**Ymin**, **Ymax**, and **Yscl**) window variables are affected.

The θ window variables (**θ min**, **θ max**, and **θ step**) are not affected, except when you select **ZStandard**. The VARS ZOOM secondary menu ZT/Z θ items **4:Z θ min**, **5:Z θ max**, and **6:Z θ step** are zoom memory variables for Pol graphing.

CALC

CALC operations in Pol graphing work the same as in Func graphing. The **CALCULATE** menu items available in Pol graphing are **1:value**, **2:dy/dx**, and **3:dr/d θ** .

Chapter 6: Sequence Graphing

Getting Started: Forest and Trees

Note: Getting Started is a fast-paced introduction. Read the chapter for details.

A small forest of 4,000 trees is under a new forestry plan. Each year 20 percent of the trees will be harvested and 1,000 new trees will be planted. Will the forest eventually disappear? Will the forest size stabilize? If so, in how many years and with how many trees?

1. Press **MODE**. Press **▼▼▼▶▶▶** **ENTER** to select **Seq** graphing mode.

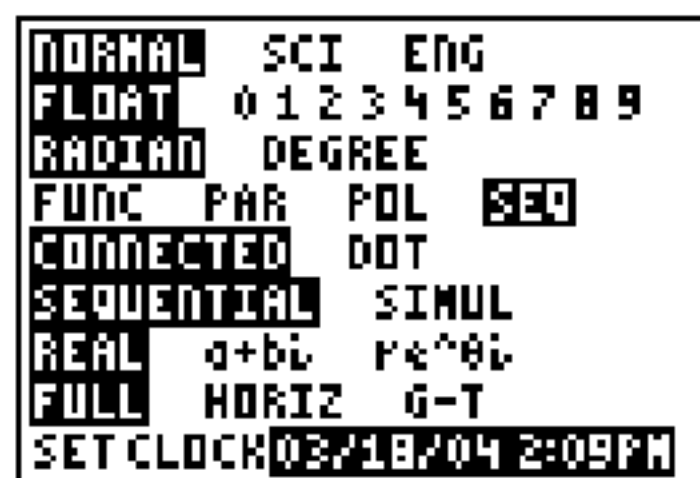

```
NORMAL SCI ENG
FLOAT 0 1 2 3 4 5 6 7 8 9
RADIAN DEGREE
FUNC PAR POL SEQ
CONNECTED DOT
SEQUENTIAL SIMUL
REAL a+bi re^θi
FULL HORIZ G-T
SET CLOCK 03/18/04 2:09PM
```

2. Press **2nd** **[FORMAT]** and select **Time** axes format and **ExprOn** format if necessary.

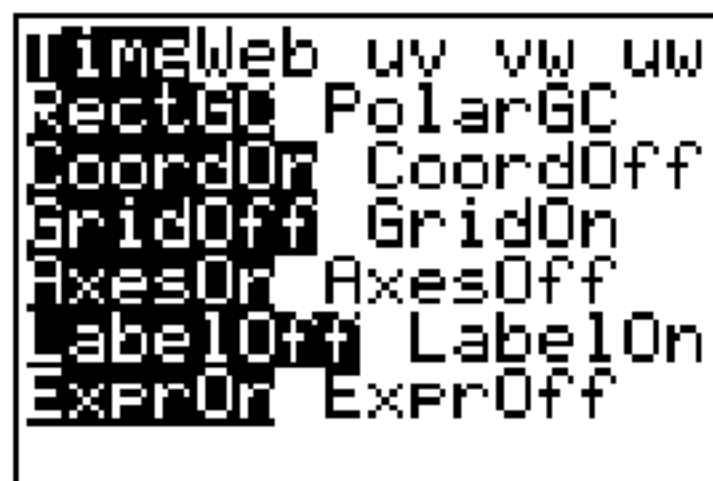

```
TimeWeb uv vw uw
RectGC PolarGC
CoordOn CoordOff
GridOff GridOn
AxesOn AxesOff
LabelOff LabelOn
ExprOn ExprOff
```

- Press $\boxed{Y=}$. If the graph-style icon is not \cdot (dot), press $\boxed{\leftarrow} \boxed{\leftarrow}$, press $\boxed{\text{ENTER}}$ until \cdot is displayed, and then press $\boxed{\rightarrow} \boxed{\rightarrow}$.
- Press $\boxed{\text{MATH}} \boxed{\rightarrow} \boxed{3}$ to select **iPart**((integer part) because only whole trees are harvested. After each annual harvest, 80 percent (.80) of the trees remain.

```

Plot1 Plot2 Plot3
nMin=1
u(n)=iPart(.8u(
n-1)+1000)
u(nMin)=4000
v(n)=
v(nMin)=
w(n)=

```

Press $\boxed{\cdot} \boxed{8} \boxed{2\text{nd}} \boxed{[u]} \boxed{[X,T,\theta,n]} \boxed{-} \boxed{1} \boxed{[]}$ to define the number of trees after each harvest. Press $\boxed{+} \boxed{1000} \boxed{[]}$ to define the new trees. Press $\boxed{\downarrow} \boxed{4000}$ to define the number of trees at the beginning of the program.

- Press $\boxed{\text{WINDOW}} \boxed{0}$ to set $n\text{Min}=0$. Press $\boxed{\downarrow} \boxed{50}$ to set $n\text{Max}=50$. $n\text{Min}$ and $n\text{Max}$ evaluate forest size over 50 years. Set the other window variables.

PlotStart=1 Xmin=0 Ymin=0
PlotStep=1 Xmax=50 Ymax=6000
Xscl=10 Yscl=1000

- Press $\boxed{\text{TRACE}}$. Tracing begins at $n\text{Min}$ (the start of the forestry plan). Press $\boxed{\rightarrow}$ to trace the sequence year by year. The sequence is displayed at the top of the screen. The values for n (number of years), X ($X=n$, because n is plotted on the x-axis), and Y (tree count) are displayed at the bottom. When will the forest stabilize? With how many trees?

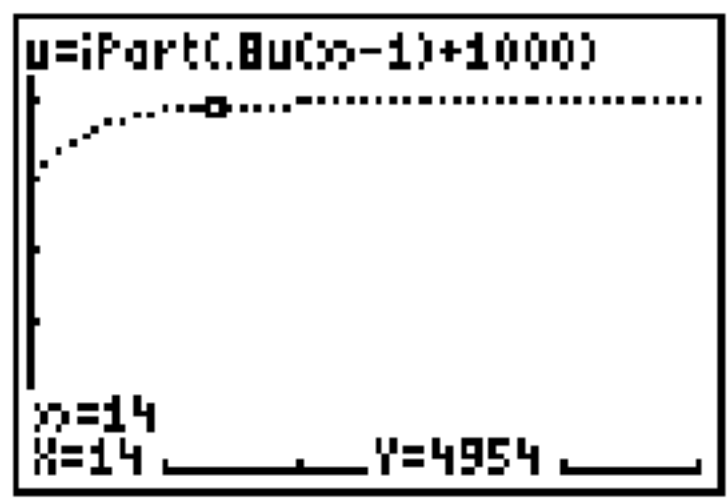

Defining and Displaying Sequence Graphs

TI-84 Plus Graphing Mode Similarities

The steps for defining a sequence graph are similar to the steps for defining a function graph. Chapter 6 assumes that you are familiar with Chapter 3: Function Graphing. Chapter 6 details aspects of sequence graphing that differ from function graphing.

Setting Sequence Graphing Mode

To display the mode screen, press **MODE**. To graph sequence functions, you must select Seq graphing mode before you enter window variables and before you enter sequence functions.

Sequence graphs automatically plot in Simul mode, regardless of the current plotting-order mode setting.

TI-84 Plus Sequence Functions u , v , and w

The TI-84 Plus has three sequence functions that you can enter from the keyboard: u , v , and w . They are above the **7**, **8**, and **9** keys.

You can define sequence functions in terms of:

- The independent variable n
- The previous term in the sequence function, such as $u(n-1)$
- The term that precedes the previous term in the sequence function, such as $u(n-2)$

- The previous term or the term that precedes the previous term in another sequence function, such as $u(n-1)$ or $u(n-2)$ referenced in the sequence $v(n)$.

Note: Statements in this chapter about $u(n)$ are also true for $v(n)$ and $w(n)$; statements about $u(n-1)$ are also true for $v(n-1)$ and $w(n-1)$; statements about $u(n-2)$ are also true for $v(n-2)$ and $w(n-2)$.

Displaying the Sequence Y= Editor

After selecting Seq mode, press $\boxed{Y=}$ to display the sequence Y= editor.

```

Plot1 Plot2 Plot3
nMin=1
u(n)=
u(nMin)=
v(n)=
v(nMin)=
w(n)=
w(nMin)=

```

In this editor, you can display and enter sequences for $u(n)$, $v(n)$, and $w(n)$. Also, you can edit the value for $n\mathbf{Min}$, which is the sequence window variable that defines the minimum n value to evaluate.

The sequence Y= editor displays the $n\mathbf{Min}$ value because of its relevance to $u(n\mathbf{Min})$, $v(n\mathbf{Min})$, and $w(n\mathbf{Min})$, which are the initial values for the sequence equations $u(n)$, $v(n)$, and $w(n)$, respectively.

$n\mathbf{Min}$ in the Y= editor is the same as $n\mathbf{Min}$ in the window editor. If you enter a new value for $n\mathbf{Min}$ in one editor, the new value for $n\mathbf{Min}$ is updated in both editors.

Note: Use $u(n\mathbf{Min})$, $v(n\mathbf{Min})$, or $w(n\mathbf{Min})$ only with a recursive sequence, which requires an initial value.

Selecting Graph Styles

The icons to the left of $u(n)$, $v(n)$, and $w(n)$ represent the graph style of each sequence (Chapter 3). The default in Seq mode is \cdot (dot), which shows discrete values. Dot, \backslash (line), and \blacksquare (thick) styles are available for sequence graphing. Graph styles are ignored in Web format.

Selecting and Deselecting Sequence Functions

The TI-84 Plus graphs only the selected sequence functions. In the Y= editor, a sequence function is selected when the = signs of both $u(n)=$ and $u(n\text{Min})=$ are highlighted.

To change the selection status of a sequence function, move the cursor onto the = sign of the function name, and then press **ENTER**. The status is changed for both the sequence function $u(n)$ and its initial value $u(n\text{Min})$.

Defining and Editing a Sequence Function

To define or edit a sequence function, follow the steps in Chapter 3 for defining a function. The independent variable in a sequence is n .

In Seq graphing mode, you can enter the sequence variable in either of two ways.

- Press **[X,T,Θ,n]**.
- Press **[2nd] [CATALOG] [N]**.

You can enter the function name from the keyboard.

- To enter the function name **u**, press **2nd** [**u**] (above **7**).
- To enter the function name **v**, press **2nd** [**v**] (above **8**).
- To enter the function name **w**, press **2nd** [**w**] (above **9**).

Generally, sequences are either nonrecursive or recursive. Sequences are evaluated only at consecutive integer values. n is always a series of consecutive integers, starting at zero or any positive integer.

Nonrecursive Sequences

In a nonrecursive sequence, the n th term is a function of the independent variable n . Each term is independent of all other terms.

For example, in the nonrecursive sequence below, you can calculate **u(5)** directly, without first calculating **u(1)** or any previous term.

```

Plot1 Plot2 Plot3
nMin=1
·u(n)=2*n
u(nMin)=
·v(n)=
v(nMin)=
·w(n)=
w(nMin)=

```

The sequence equation above returns the sequence 2, 4, 6, 8, 10, ... for $n = 1, 2, 3, 4, 5, \dots$

Note: You may leave blank the initial value **u(nMin)** when calculating nonrecursive sequences.

Recursive Sequences

In a recursive sequence, the n th term in the sequence is defined in relation to the previous term or the term that precedes the previous term, represented by $u(n-1)$ and $u(n-2)$. A recursive sequence may also be defined in relation to n , as in $u(n)=u(n-1)+n$.

For example, in the sequence below you cannot calculate $u(5)$ without first calculating $u(1)$, $u(2)$, $u(3)$, and $u(4)$.

```
Plot1 Plot2 Plot3
nMin=1
u(n)=2*u(n-1)
u(nMin)=1
```

Using an initial value $u(nMin) = 1$, the sequence above returns 1, 2, 4, 8, 16,

Note: On the TI-84 Plus, you must type each character of the terms. For example, to enter $u(n-1)$, press $\boxed{2nd} \boxed{[u]} \boxed{[]} \boxed{X,T,\theta,n} \boxed{-} \boxed{[]} \boxed{[]}$.

Recursive sequences require an initial value or values, since they reference undefined terms.

- If each term in the sequence is defined in relation to the previous term, as in $u(n-1)$, you must specify an initial value for the first term.

```
Plot1 Plot2 Plot3
nMin=1
u(n)=.8u(n-1)+5
u(nMin)=100
```

- If each term in the sequence is defined in relation to the term that precedes the previous term, as in $u(n-2)$, you must specify initial values for the first two terms.

Enter the initial values as a list enclosed in braces (`{ }`) with commas separating the values.

```
Plot1 Plot2 Plot3
nMin=1
u(n)=u(n-1)+u(n-2)
u(nMin)={1,0}
```

The value of the first term is 0 and the value of the second term is 1 for the sequence $u(n)$.

Setting Window Variables

To display the window variables, press `WINDOW`. These variables define the viewing window. The values below are defaults for Seq graphing in both Radian and Degree angle modes.

<code>nMin=1</code>	Smallest n value to evaluate
<code>nMax=10</code>	Largest n value to evaluate
<code>PlotStart=1</code>	First term number to be plotted
<code>PlotStep=1</code>	Incremental n value (for graphing only)
<code>Xmin=-10</code>	Smallest X value to be displayed

Xmax=10	Largest X value to be displayed
Xscl=1	Spacing between the X tick marks
Ymin=-10	Smallest Y value to be displayed
Ymax=10	Largest Y value to be displayed
Yscl=1	Spacing between the Y tick marks

nMin must be an integer ≥ 0 . **nMax**, **PlotStart**, and **PlotStep** must be integers ≥ 1 .

nMin is the smallest n value to evaluate. **nMin** also is displayed in the sequence **Y=** editor. **nMax** is the largest n value to evaluate. Sequences are evaluated at **u(nMin)**, **u(nMin+1)**, **u(nMin+2)**, ... , **u(nMax)**.

PlotStart is the first term to be plotted. **PlotStart=1** begins plotting on the first term in the sequence. If you want plotting to begin with the fifth term in a sequence, for example, set **PlotStart=5**. The first four terms are evaluated but are not plotted on the graph.

PlotStep is the incremental n value for graphing only. **PlotStep** does not affect sequence evaluation; it only designates which points are plotted on the graph. If you specify **PlotStep=2**, the sequence is evaluated at each consecutive integer, but it is plotted on the graph only at every other integer.

Selecting Axes Combinations

Setting the Graph Format

To display the current graph format settings, press $\boxed{2nd}$ [FORMAT]. Chapter 3 describes the format settings in detail. The other graphing modes share these format settings. The axes setting on the top line of the screen is available only in Seq mode.

Time	Web	uv	vw	uw	Type of sequence plot (axes)
RectGC			Polar	GC	Rectangular or polar output
CoordOn			CoordOff		Cursor coordinate display on/off
GridOff			GridOn		Grid display off or on
AxesOn			AxesOff		Axes display on or off
LableOff			LabelOn		Axes label display off or on
ExprOn			ExprOff		Expression display on or off

Setting Axes Format

For sequence graphing, you can select from five axes formats. The table below shows the values that are plotted on the x-axis and y-axis for each axes setting.

Axes Setting	x-axis	y-axis
Time	n	$u(n), v(n), w(n)$
Web	$u(n-1), v(n-1), w(n-1)$	$u(n), v(n), w(n)$

Axes Setting	x-axis	y-axis
uv	$u(n)$	$v(n)$
vw	$v(n)$	$w(n)$
uw	$u(n)$	$w(n)$

Displaying a Sequence Graph

To plot the selected sequence functions, press **GRAPH**. As a graph is plotted, the TI-84 Plus updates X, Y, and n .

Smart Graph applies to sequence graphs (Chapter 3).

Exploring Sequence Graphs

Free-Moving Cursor

The free-moving cursor in Seq graphing works the same as in Func graphing. In **RectGC** format, moving the cursor updates the values of X and Y; if **CoordOn** format is selected, X and Y are displayed. In **PolarGC** format, X, Y, R, and θ are updated; if **CoordOn** format is selected, R and θ are displayed.

TRACE

The axes format setting affects TRACE.

When **Time**, **uv**, **vw**, or **uw** axes format is selected, TRACE moves the cursor along the sequence one **PlotStep** increment at a time. To move five plotted points at once, press $\boxed{2\text{nd}} \boxed{\blacktriangleright}$ or $\boxed{2\text{nd}} \boxed{\blacktriangleleft}$.

- When you begin a trace, the trace cursor is on the first selected sequence at the term number specified by **PlotStart**, even if it is outside the viewing window.
- Quick Zoom applies to all directions. To center the viewing window on the current cursor location after you have moved the trace cursor, press $\boxed{\text{ENTER}}$. The trace cursor returns to **$n\text{Min}$** .

In Web format, the trail of the cursor helps identify points with attracting and repelling behavior in the sequence. When you begin a trace, the cursor is on the x-axis at the initial value of the first selected function.

Note: To move the cursor to a specified n during a trace, enter a value for n , and press $\boxed{\text{ENTER}}$. For example, to quickly return the cursor to the beginning of the sequence, paste **$n\text{Min}$** to the $n=$ prompt and press $\boxed{\text{ENTER}}$.

Moving the Trace Cursor to Any Valid n Value

To move the trace cursor to any valid n value on the current function, enter the number. When you enter the first digit, an $n=$ prompt and the number you entered are displayed in the bottom-left corner of the screen. You can enter an expression at the $n=$ prompt. The

value must be valid for the current viewing window. When you have completed the entry, press **ENTER** to move the cursor.

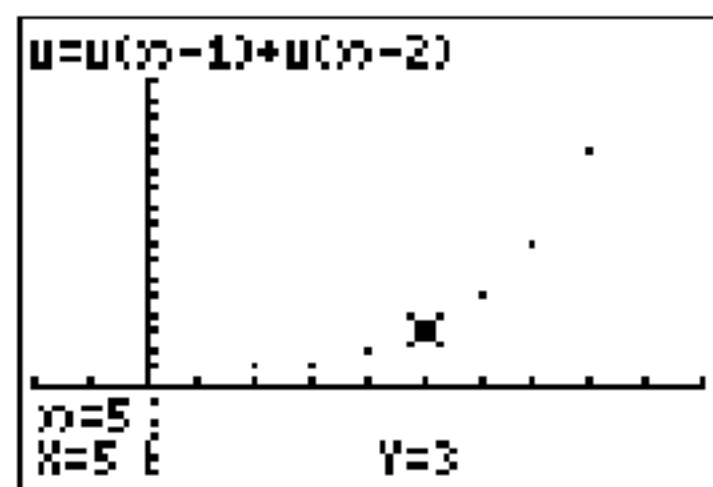
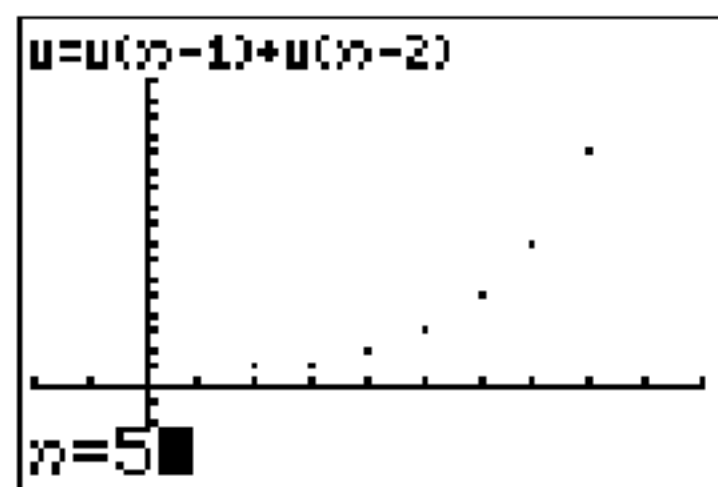

ZOOM

ZOOM operations in Seq graphing work the same as in Func graphing. Only the **X** (**Xmin**, **Xmax**, and **Xscl**) and **Y** (**Ymin**, **Ymax**, and **Yscl**) window variables are affected.

PlotStart, **PlotStep**, **nMin**, and **nMax** are only affected when you select **ZStandard**. The **VARS Zoom** secondary menu **ZU** items 1 through 7 are the **ZOOM MEMORY** variables for Seq graphing.

CALC

The only **CALC** operation available in Seq graphing is **value**.

- When Time axes format is selected, **value** displays **Y** (the $u(n)$ value) for a specified n value.
- When Web axes format is selected, **value** draws the web and displays **Y** (the $u(n)$ value) for a specified n value.

- When **uv**, **vw**, or **uw** axes format is selected, **value** displays X and Y according to the axes format setting. For example, for **uv** axes format, X represents $u(n)$ and Y represents $v(n)$.

Evaluating u, v, and w

To enter the sequence names **u**, **v**, or **w**, press $\boxed{2nd}$ **[u]**, **[v]**, or **[w]**. You can evaluate these names in any of three ways.

- Calculate the n th value in a sequence.
- Calculate a list of values in a sequence.
- Generate a sequence with $u(nstart, nstop[, nstep])$. $nstep$ is optional; default is 1.

```
"n²"→u:u(3)
          9
u((1,3,5,7,9))
  {1 9 25 49 81}
u(1,9,2)
  {1 9 25 49 81}
```

Graphing Web Plots

Graphing a Web Plot

To select Web axes format, press $\boxed{2nd}$ **[FORMAT]** $\boxed{\blacktriangleright}$ **[ENTER]**. A web plot graphs $u(n)$ versus $u(n-1)$, which you can use to study long-term behavior (convergence, divergence, or oscillation) of a recursive sequence. You can see how the sequence may change behavior as its initial value changes.

Valid Functions for Web Plots

When Web axes format is selected, a sequence will not graph properly or will generate an error.

- It must be recursive with only one recursion level ($u(n-1)$ but not $u(n-2)$).
- It cannot reference n directly.
- It cannot reference any defined sequence except itself.

Displaying the Graph Screen

In Web format, press **GRAPH** to display the graph screen. The TI-84 Plus:

- Draws a $y=x$ reference line in **AxesOn** format.
- Plots the selected sequences with $u(n-1)$ as the independent variable.

Note: A potential convergence point occurs whenever a sequence intersects the $y=x$ reference line. However, the sequence may or may not actually converge at that point, depending on the sequence's initial value.

Drawing the Web

To activate the trace cursor, press **TRACE**. The screen displays the sequence and the current n , X , and Y values (X represents $u(n-1)$ and Y represents $u(n)$). Press **▶** repeatedly to draw the web step by step, starting at $n\text{Min}$. In Web format, the trace cursor follows this course.

1. It starts on the x-axis at the initial value $u(n\text{Min})$ (when **PlotStart=1**).

2. It moves vertically (up or down) to the sequence.
3. It moves horizontally to the $y=x$ reference line.
4. It repeats this vertical and horizontal movement as you continue to press \square .

Using Web Plots to Illustrate Convergence

Example: Convergence

1. Press $\boxed{Y=}$ in **Seq** mode to display the sequence Y= editor. Make sure the graph style is set to \cdot (dot), and then define $n\text{Min}$, $u(n)$ and $u(n\text{Min})$ as shown below.

```

Plot1 Plot2 Plot3
nMin=1
u(n) = .8u(n-1)+
3.6
u(nMin) = (-4)
u(n) =
u(nMin) =
u(n) =

```

2. Press $\boxed{2\text{nd}} \boxed{[\text{FORMAT}]} \boxed{[\text{ENTER}]}$ to set **Time** axes format.
3. Press $\boxed{[\text{WINDOW}]}$ and set the variables as shown below.

nMin=1	Xmin=0	Ymin=-10
nMax=25	Xmax=25	Ymax=10
PlotStart=1	Xscl=1	Yscl=1
PlotStep=1		

4. Press $\boxed{[\text{GRAPH}]}$ to graph the sequence.

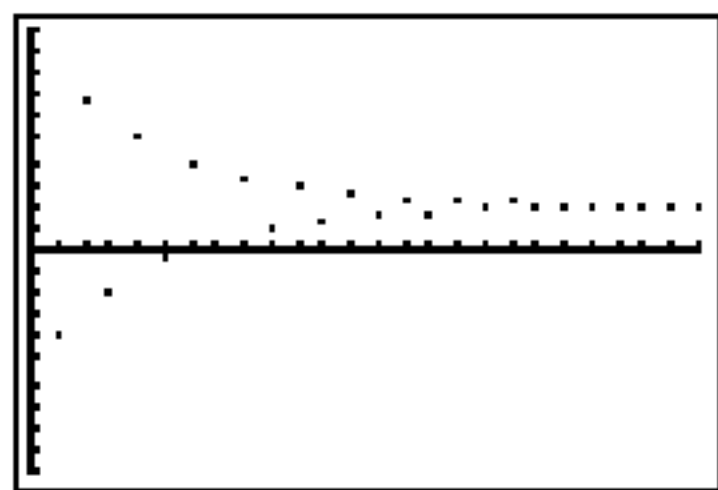

5. Press $\boxed{2\text{nd}}$ $\boxed{[\text{FORMAT}]}$ and select the **Web** axes setting.
6. Press $\boxed{[\text{WINDOW}]}$ and change the variables below.

Xmin=-10

Xmax=10

7. Press $\boxed{[\text{GRAPH}]}$ to graph the sequence.
8. Press $\boxed{[\text{TRACE}]}$, and then press $\boxed{\blacktriangleright}$ to draw the web. The displayed cursor coordinates n , $X(u(n-1))$, and $Y(u(n))$ change accordingly. When you press $\boxed{\blacktriangleright}$, a new n value is displayed, and the trace cursor is on the sequence. When you press $\boxed{\blacktriangleright}$ again, the n value remains the same, and the cursor moves to the $y=x$ reference line. This pattern repeats as you trace the web.

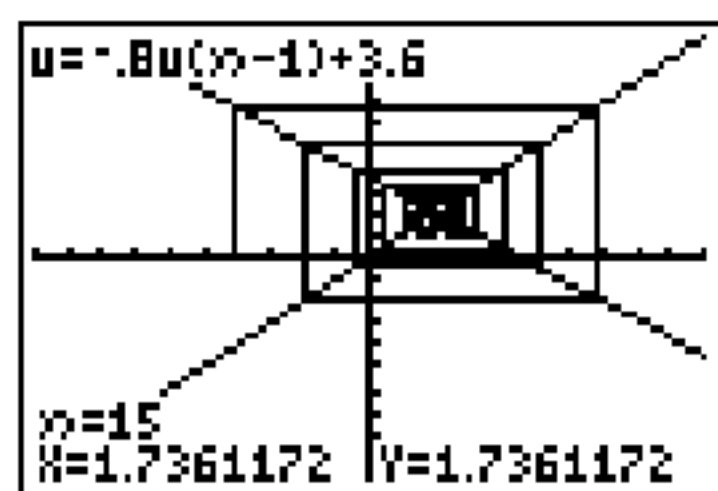

Graphing Phase Plots

Graphing with uv , vw , and uw

The phase-plot axes settings uv , vw , and uw show relationships between two sequences. To select a phase-plot axes setting, press $\boxed{2nd}$ [FORMAT], press $\boxed{\blacktriangleright}$ until the cursor is on uv , vw , or uw , and then press \boxed{ENTER} .

Axes Setting	x-axis	y-axis
uv	$u(n)$	$v(n)$
vw	$v(n)$	$w(n)$
uw	$u(n)$	$w(n)$

Example: Predator-Prey Model

Use the predator-prey model to determine the regional populations of a predator and its prey that would maintain population equilibrium for the two species.

This example uses the model to determine the equilibrium populations of foxes and rabbits, with initial populations of 200 rabbits ($u(nMin)$) and 50 foxes ($v(nMin)$).

These are the variables (given values are in parentheses):

R = number of rabbits

M = rabbit population growth rate without foxes (.05)

K = rabbit population death rate with foxes (.001)

- W = number of foxes
 G = fox population growth rate with rabbits (.0002)
 D = fox population death rate without rabbits (.03)
 n = time (in months)
 $R_n = R_{n-1}(1+M-KW_{n-1})$
 $W_n = W_{n-1}(1+GR_{n-1}-D)$

1. Press $\boxed{Y=}$ in **Seq** mode to display the sequence Y= editor. Define the sequences and initial values for R_n and W_n as shown below. Enter the sequence R_n as $u(n)$ and enter the sequence W_n as $v(n)$.

```

Plot1 Plot2 Plot3
nMin=1
·u(n)▣u(n-1)*(1+
.05-.001*u(n-1))

u(nMin)▣(200)
·v(n)▣v(n-1)*(1+
.0002*u(n-1)-.03

```

```

·v(nMin)▣(50)
·w(n)=
w(nMin)=

```

2. Press $\boxed{2nd}$ $\boxed{[FORMAT]}$ $\boxed{[ENTER]}$ to select **Time** axes format.

3. Press **WINDOW** and set the variables as shown below.

n Min=0
 n Max=400
PlotStart=1
PlotStep=1

Xmin=0
Xmax=400
Xscl=100

Ymin=0
Ymax=300
Yscl=100

4. Press **GRAPH** to graph the sequence.

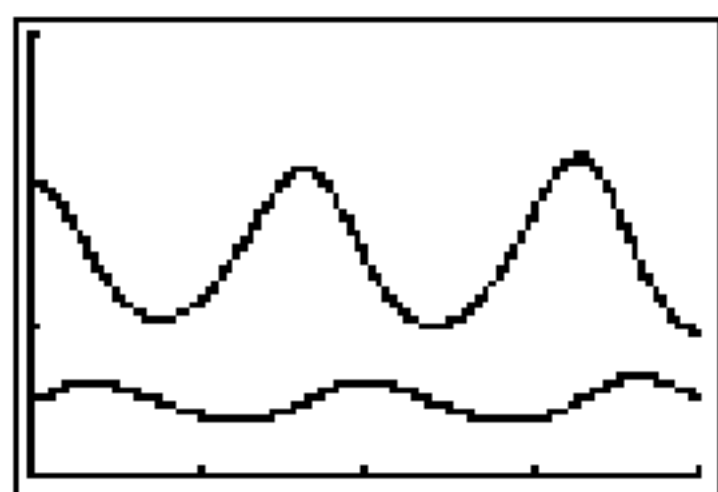

5. Press **TRACE** \blacktriangleright to individually trace the number of rabbits ($u(n)$) and foxes ($v(n)$) over time (n).

Note: Press a number, and then press **ENTER** to jump to a specific n value (month) while in TRACE.

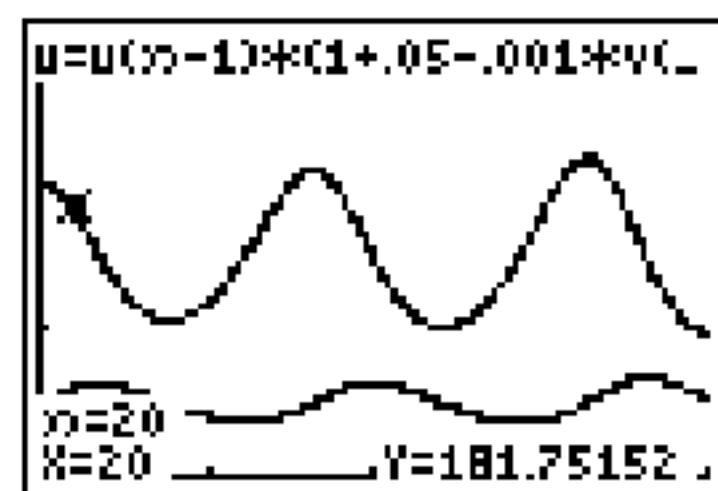

6. Press **2nd** **FORMAT** \blacktriangleright \blacktriangleright **ENTER** to select **uv** axes format.

7. Press **WINDOW** and change these variables as shown below.

Xmin=84
Xmax=237
Xscl=50

Ymin=25
Ymax=75
Yscl=10

8. Press **TRACE**. Trace both the number of rabbits (**X**) and the number of foxes (**Y**) through 400 generations.

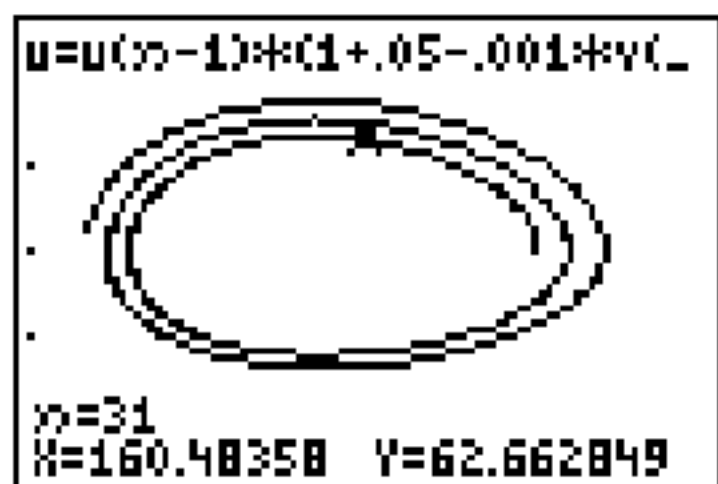

Note: When you press **TRACE**, the equation for **u** is displayed in the top-left corner. Press **▲** or **▼** to see the equation for **v**.

Comparing TI-84 Plus and TI-82 Sequence Variables

Sequences and Window Variables

Refer to the table if you are familiar with the TI-82. It shows TI-84 Plus sequences and sequence window variables, as well as their TI-82 counterparts.

TI-84 Plus	TI-82
In the Y= editor:	
u(n)	U_n
u(nMin)	U_{nStart} (window variable)

TI-84 Plus	TI-82
$v(n)$	V_n
$v(nMin)$	V_nStart (window variable)
$w(n)$	not available
$w(nMin)$	not available
In the window editor:	
$nMin$	$nStart$
$nMax$	$nMax$
PlotStart	$nMin$
PlotStep	not available

Keystroke Differences Between TI-84 Plus and TI-82

Sequence Keystroke Changes

Refer to the table if you are familiar with the TI-82. It compares TI-84 Plus sequence-name syntax and variable syntax with TI-82 sequence-name syntax and variable syntax.

TI-84 Plus / TI-82	On TI-84 Plus, press:	On TI-82, press:
n / n	$\boxed{X,T,\theta,n}$	$\boxed{2nd} [n]$
$u(n) / U_n$	$\boxed{2nd} [u]$ $\boxed{(} \boxed{X,T,\theta,n} \boxed{)}$	$\boxed{2nd} [Y-VARS] \boxed{4} \boxed{1}$

TI-84 Plus / TI-82	On TI-84 Plus, press:	On TI-82, press:
$v(n) / V_n$	$\boxed{2nd} \boxed{[v]}$ $\boxed{(} \boxed{X,T,\theta,n} \boxed{)}$	$\boxed{2nd} \boxed{[Y-VARS]} \boxed{4} \boxed{2}$
$w(n)$	$\boxed{2nd} \boxed{[w]}$ $\boxed{(} \boxed{X,T,\theta,n} \boxed{)}$	not available
$u(n-1) / U_{n-1}$	$\boxed{2nd} \boxed{[u]}$ $\boxed{(} \boxed{X,T,\theta,n} \boxed{-} \boxed{1} \boxed{)}$	$\boxed{2nd} \boxed{[U_{n-1}]}$
$v(n-1) / V_{n-1}$	$\boxed{2nd} \boxed{[v]}$ $\boxed{(} \boxed{X,T,\theta,n} \boxed{-} \boxed{1} \boxed{)}$	$\boxed{2nd} \boxed{[V_{n-1}]}$
$w(n-1)$	$\boxed{2nd} \boxed{[w]}$ $\boxed{(} \boxed{X,T,\theta,n} \boxed{-} \boxed{1} \boxed{)}$	not available

Chapter 7: Tables

Getting Started: Roots of a Function

Getting Started is a fast-paced introduction. Read the chapter for details.

Evaluate the function $Y = X^3 - 2X$ at each integer between -10 and 10. How many sign changes occur, and at what X values?

1. Press **MODE** \downarrow \downarrow \downarrow **ENTER** to set **Func** graphing mode.
2. Press **Y=**. Press **X,T,θ,n** **MATH** **3** to select 3 . Then press **[-]** **2** **X,T,θ,n** to enter the function **Y1=X³-2X**.
3. Press **2nd** **[TBLSET]** to display the **TABLE SETUP** screen. Press **[-]** **10** **ENTER** to set **TblStart=-10**. Press **1** **ENTER** to set **ΔTbl=1**.

```
Plot1 Plot2 Plot3
Y1=X3-2X
Y2=
Y3=
Y4=
Y5=
Y6=
Y7=
```

```
TABLE SETUP
TblStart=-10
ΔTbl=1
IndEnt: Auto Ask
Depend: Auto Ask
```

Press **ENTER** to select **Indpnt: Auto** (automatically generated independent values). Press **▼** **ENTER** to select **Depend: Auto** (automatically generated dependent values).

4. Press **2nd** **[TABLE]** to display the table screen.

X	Y1	
-10	-980	
-9	-711	
-8	-496	
-7	-329	
-6	-204	
-5	-115	
-4	-56	

X = -10

5. Press **▼** until you see the sign changes in the value of **Y1**. How many sign changes occur, and at what X values?

X	Y1	
-3	-21	
-2	-4	
-1	1	
0	0	
1	-1	
2	4	
3	21	

X = 3

Setting Up the Table

TABLE SETUP Screen

To display the TABLE SETUP screen, press **2nd** **[TBLSET]**.

TABLE SETUP		
TblStart=0		
ΔTbl=1		
Indpnt:	Auto	Ask
Depend:	Auto	Ask

TblStart, ΔTbl

TblStart (table start) defines the initial value for the independent variable. **TblStart** applies only when the independent variable is generated automatically (when **Indpnt: Auto** is selected).

ΔTbl (table step) defines the increment for the independent variable.

Note: In Seq mode, both **TblStart** and **ΔTbl** must be integers.

Indpnt: Auto, Indpnt: Ask, Depend: Auto, Depend: Ask

Selections	Table Characteristics
Indpnt: Auto Depend: Auto	Values are displayed automatically in both the independent-variable column and in all dependent-variable columns.
Indpnt: Ask Depend: Auto	The table is empty; when you enter a value for the independent variable, all corresponding dependent-variable values are calculated and displayed automatically.
Indpnt: Auto Depend: Ask	Values are displayed automatically for the independent variable; to generate a value for a dependent variable, move the cursor to that cell and press ENTER .
Indpnt: Ask Depend: Ask	The table is empty; enter values for the independent variable; to generate a value for a dependent variable, move the cursor to that cell and press ENTER .

Setting Up the Table from the Home Screen or a Program

To store a value to **TblStart**, ΔTbl , or **TblZnput** from the home screen or a program, select the variable name from the **VARs TABLE** secondary menu. **TblInput** is a list of independent-variable values in the current table.

When you press $\boxed{2nd}$ [TBLSET] in the program editor, you can select **IndpntAuto**, **IndpntAsk**, **DependAuto**, and **DependAsk**.

Defining the Dependent Variables

Defining Dependent Variables from the Y= Editor

In the Y= editor, enter the functions that define the dependent variables. Only functions that are selected in the Y= editor are displayed in the table. The current graphing mode is used. In Par mode, you must define both components of each parametric equation (Chapter 4).

Editing Dependent Variables from the Table Editor

To edit a selected Y= function from the table editor, follow these steps.

1. Press $\boxed{2nd}$ [TABLE] to display the table, then press $\boxed{\blacktriangleright}$ or $\boxed{\blacktriangleleft}$ to move the cursor to a dependent-variable column.
2. Press $\boxed{\blacktriangleup}$ until the cursor is on the function name at the top of the column. The function is displayed on the bottom line.

X	Y1	
0	0	
1	-1	
2	4	
3	21	
4	56	
5	115	
6	204	

Y1 = X³ - 2X

3. Press **ENTER**. The cursor moves to the bottom line. Edit the function.

X	Y1	
0	0	
1	-1	
2	4	
3	21	
4	56	
5	115	
6	204	

Y1 = X³ - 2X

X	Y1	
0	0	
1	-1	
2	4	
3	21	
4	56	
5	115	
6	204	

Y1 = X³ - 4X

4. Press **ENTER** or **↓**. The new values are calculated. The table and the Y= function are updated automatically.

X	Y1	
0	0	
1	-3	
2	0	
3	15	
4	48	
5	105	
6	192	

Y1 = 0

Note: You also can use this feature to view the function that defines a dependent variable without having to leave the table.

Displaying the Table

The Table

To display the table, press $\boxed{2\text{nd}}$ [TABLE].

Note: The table abbreviates the values, if necessary.

Current cell

X	Y1	Y2
10	-39.17	-49.17
11	-44.86	-54.86
12	-47.88	-57.88
13	-52.86	-62.86
14	-56.98	-66.98
15	-59.2	-69.2
16	-64.59	-74.59

Independent-variable values in the first column

Dependent-variable values in the second and third columns

Current cell's full value

$Y_1 = -39.173120459$

Independent and Dependent Variables

The current graphing mode determines which independent and dependent variables are displayed in the table (Chapter 1). In the table above, for example, the independent

variable X and the dependent variables $Y1$ and $Y2$ are displayed because Func graphing mode is set.

Graphing Mode	Independent Variable	Dependent Variable
Func (function)	X	Y1 through Y9 , and Y0
Par (parametric)	T	X1T/Y1T through X6T/Y6T
Pol (polar)	θ	r1 through r6
Seq (sequence)	n	u(n) , v(n) , and w(n)

Clearing the Table from the Home Screen or a Program

From the home screen, select the **ClrTable** instruction from the CATALOG. To clear the table, press **ENTER**.

From a program, select **9:ClrTable** from the **PRGM I/O** menu or from the CATALOG. The table is cleared upon execution. If **IndpntAsk** is selected, all independent and dependent variable values on the table are cleared. If **DependAsk** is selected, all dependent variable values on the table are cleared.

Scrolling Independent-Variable Values

If **Indpnt: Auto** is selected, you can press **▲** and **▼** in the independent-variable column to display more values. As you scroll the column, the corresponding dependent-variable

values also are displayed. All dependent-variable values may not be displayed if **Depend: Ask** is selected.

X	Y ₁	Y ₂
0	0	0
1	-1	-3
2	4	0
3	21	15
4	56	48
5	115	105
6	204	192

X=0

X	Y ₁	Y ₂
-1	1	3
0	0	0
1	-1	-3
2	4	0
3	21	15
4	56	48
5	115	105

X=-1

Note: You can scroll back from the value entered for **TblStart**. As you scroll, **TblStart** is updated automatically to the value shown on the top line of the table. In the example above, **TblStart=0** and $\Delta\text{Tbl}=1$ generates and displays values of **X=0, ..., 6**; but you can press \uparrow to scroll back and display the table for **X=-1, ..., 5**.

Displaying Other Dependent Variables

If you have defined more than two dependent variables, the first two selected Y= functions are displayed initially. Press \rightarrow or \leftarrow to display dependent variables defined by other selected Y= functions. The independent variable always remains in the left column, except during a trace with Par graphing mode and G-T split-screen mode set.

X	Y ₂	Y ₃
-4	-4	-28
-3	-6	-18
-2	-6	-10
-1	-4	-4
0	0	0
1	6	2
2	14	2

Y₃=-28

Note: To simultaneously display two dependent variables on the table that are not defined as consecutive Y= functions, go to the Y= editor and deselect the Y= functions between the two you want to display. For example, to simultaneously display Y4 and Y7 on the table, go to the Y= editor and deselect Y5 and Y6.

Chapter 8: Draw Instructions

Getting Started: Drawing a Tangent Line

Getting Started is a fast-paced introduction. Read the chapter for details.

Suppose you want to find the equation of the tangent line at $X = \frac{\sqrt{2}}{2}$ for the function $Y = \sin(X)$.

Before you begin, select **Radian** and **Func** mode from the mode screen, if necessary.

1. Press $\boxed{Y=}$ to display the Y= editor. Press $\boxed{\text{SIN}} \boxed{X,T,\theta,n} \boxed{)}$ to store **sin(X)** in **Y1**.
2. Press $\boxed{\text{ZOOM}} \boxed{7}$ to select **7:ZTrig**, which graphs the equation in the **Zoom Trig** window.

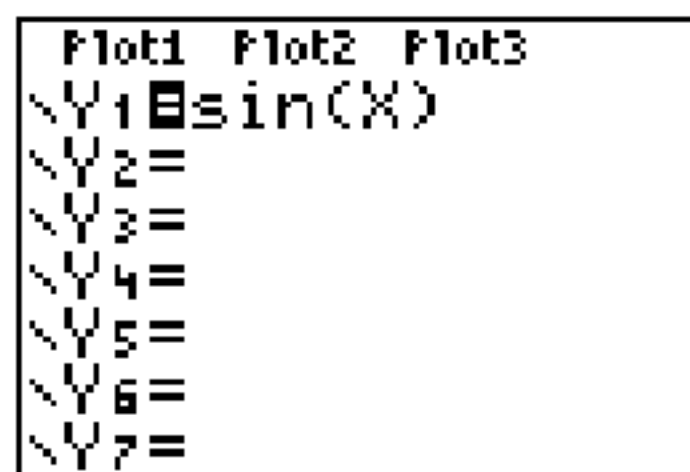

```
Plot1 Plot2 Plot3
Y1 sin(X)
Y2 =
Y3 =
Y4 =
Y5 =
Y6 =
Y7 =
```

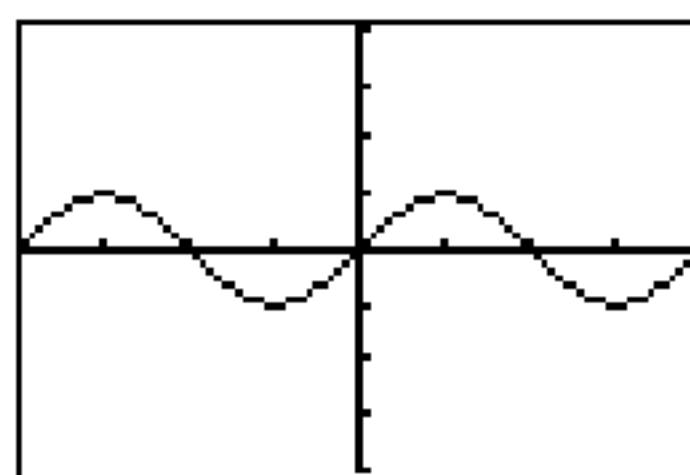

- Press $\boxed{2nd}$ \boxed{DRAW} $\boxed{5}$ to select **5:Tangent(**. The tangent instruction is initiated.



- Press $\boxed{2nd}$ $\boxed{\sqrt{}}$ $\boxed{2}$ $\boxed{)}$ $\boxed{\div}$ $\boxed{2}$.

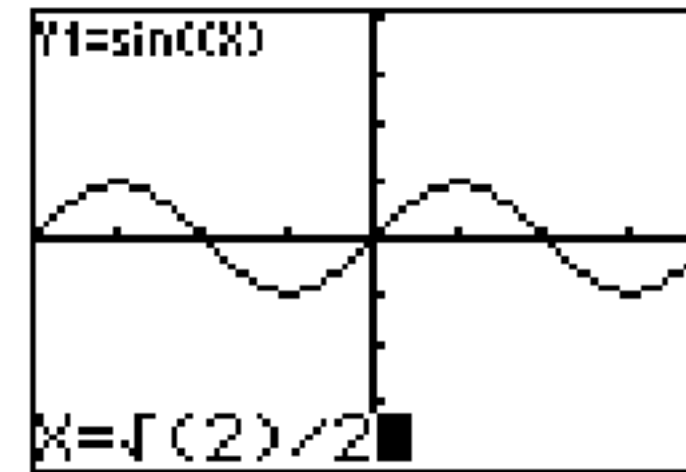

- Press \boxed{ENTER} . The tangent line is drawn; the X value and the tangent-line equation are displayed on the graph.

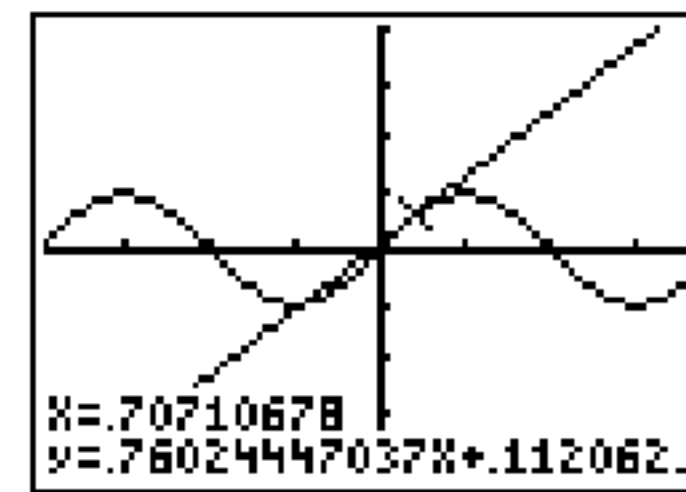

Using the DRAW Menu

DRAW Menu

To display the **DRAW** menu, press $\boxed{2nd}$ [DRAW]. The TI-84 Plus's interpretation of these instructions depends on whether you accessed the menu from the home screen or the program editor or directly from a graph.

DRAW POINTS STO

1:	ClrDraw	Clears all drawn elements.
2:	Line (Draws a line segment between 2 points.
3:	Horizontal	Draws a horizontal line.
4:	Vertical	Draws a vertical line.
5:	Tangent (Draws a line segment tangent to a function.
6:	DrawF	Draws a function.
7:	Shade (Shades an area between two functions.
8:	DrawInv	Draws the inverse of a function.
9:	Circle (Draws a circle.
0:	Text (Draws text on a graph screen.
A:	Pen	Activates the free-form drawing tool.

Before Drawing on a Graph

The DRAW instructions draw on top of graphs. Therefore, before you use the DRAW instructions, consider whether you want to perform one or more of the following actions.

- Change the mode settings on the mode screen.
- Change the format settings on the format screen.
- Enter or edit functions in the Y= editor.
- Select or deselect functions in the Y= editor.
- Change the window variable values.
- Turn stat plots on or off.
- Clear existing drawings with **ClrDraw**.

Note: If you draw on a graph and then perform any of the actions listed above, the graph is replotted without the drawings when you display the graph again.

Drawing on a Graph

You can use any **DRAW** menu instructions except **DrawInv** to draw on Func, Par, Pol, and Seq graphs. **DrawInv** is valid only in Func graphing. The coordinates for all DRAW instructions are the display's x-coordinate and y-coordinate values.

You can use most **DRAW** menu and **DRAW POINTS** menu instructions to draw directly on a graph, using the cursor to identify the coordinates. You also can execute these instructions from the home screen or from within a program. If a graph is not displayed when you select a **DRAW** menu instruction, the home screen is displayed.

Clearing Drawings

Clearing Drawings When a Graph Is Displayed

All points, lines, and shading drawn on a graph with DRAW instructions are temporary.

To clear drawings from the currently displayed graph, select **1:ClrDraw** from the **DRAW** menu. The current graph is replotted and displayed with no drawn elements.

Clearing Drawings from the Home Screen or a Program

To clear drawings on a graph from the home screen or a program, begin on a blank line on the home screen or in the program editor. Select **1:ClrDraw** from the **DRAW** menu. The instruction is copied to the cursor location. Press **ENTER**.

When **ClrDraw** is executed, it clears all drawings from the current graph and displays the message `Done`. When you display the graph again, all drawn points, lines, circles, and shaded areas will be gone.

```
ClrDraw      Done
```

Note: Before you clear drawings, you can store them with **StorePic**.

Drawing Line Segments

Drawing a Line Segment Directly on a Graph

To draw a line segment when a graph is displayed, follow these steps.

1. Select **2:Line(** from the **DRAW** menu.
2. Place the cursor on the point where you want the line segment to begin, and then press **ENTER**.
3. Move the cursor to the point where you want the line segment to end. The line is displayed as you move the cursor. Press **ENTER**.

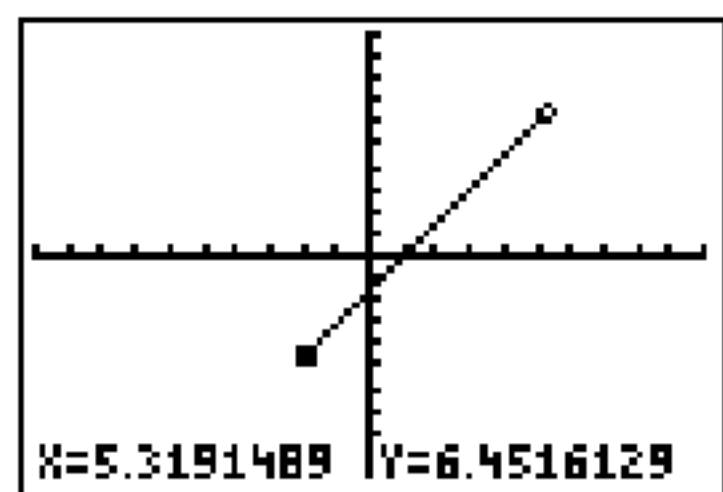

To continue drawing line segments, repeat steps 2 and 3. To cancel **Line(**, press **CLEAR**.

Drawing a Line Segment from the Home Screen or a Program

Line(also draws a line segment between the coordinates $(X1, Y1)$ and $(X2, Y2)$. The values may be entered as expressions.

Line($X1,Y1,X2,Y2$)

```
Line(0,0,6,9)■
```

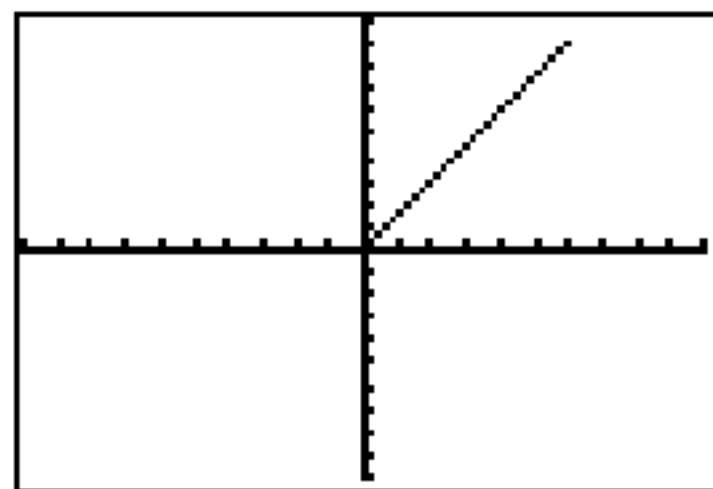

To erase a line segment, enter **Line**($X1,Y1,X2,Y2,0$)

```
Line(2,3,4,6,0)■
```

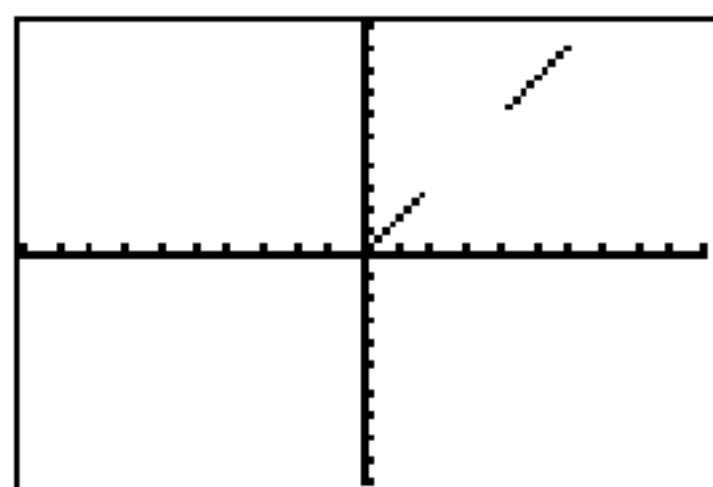

Drawing Horizontal and Vertical Lines

Drawing a Line Directly on a Graph

To draw a horizontal or vertical line when a graph is displayed, follow these steps.

1. Select **3:Horizontal** or **4:Vertical** from the **DRAW** menu. A line is displayed that moves as you move the cursor.
2. Place the cursor on the y-coordinate (for horizontal lines) or x-coordinate (for vertical lines) through which you want the drawn line to pass.

3. Press **ENTER** to draw the line on the graph.

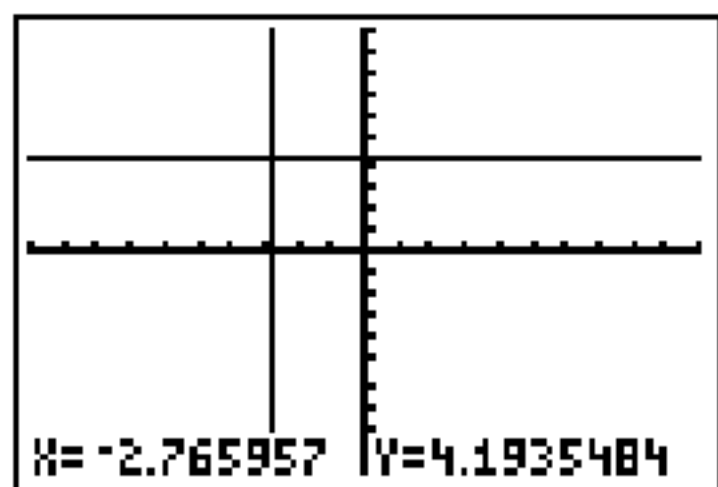

To continue drawing lines, repeat steps 2 and 3.

To cancel **Horizontal** or **Vertical**, press **CLEAR**.

Drawing a Line from the Home Screen or a Program

Horizontal (horizontal line) draws a horizontal line at $Y=y$. y can be an expression but not a list.

Horizontal y

Vertical (vertical line) draws a vertical line at $X=x$. x can be an expression but not a list.

Vertical x

To instruct the TI-84 Plus to draw more than one horizontal or vertical line, separate each instruction with a colon (:).

```
Horizontal 7:Ver  
tical 4:Vertical  
5
```

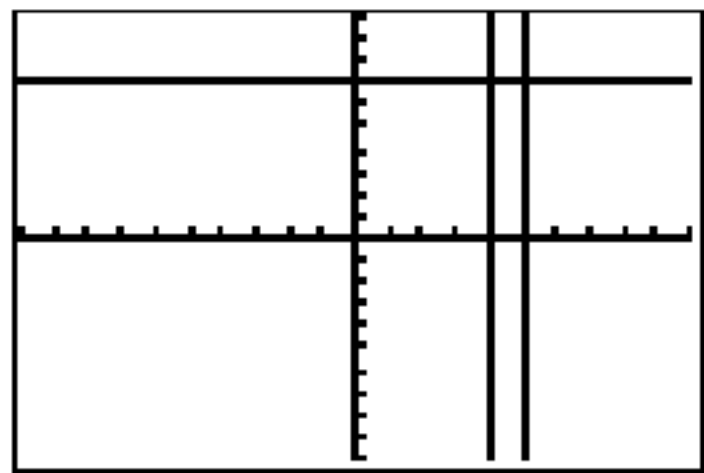

Drawing Tangent Lines

Drawing a Tangent Line Directly on a Graph

To draw a tangent line when a graph is displayed, follow these steps.

1. Select **5:Tangent(** from the **DRAW** menu.
2. Press \blacktriangledown and \blacktriangle to move the cursor to the function for which you want to draw the tangent line. The current graph's Y= function is displayed in the top-left corner, if **ExprOn** is selected.
3. Press \blacktriangleright and \blacktriangleleft or enter a number to select the point on the function at which you want to draw the tangent line.
4. Press **ENTER**. In **Func** mode, the X value at which the tangent line was drawn is displayed on the bottom of the screen, along with the equation of the tangent line. In all other modes, the **dy/dx** value is displayed.

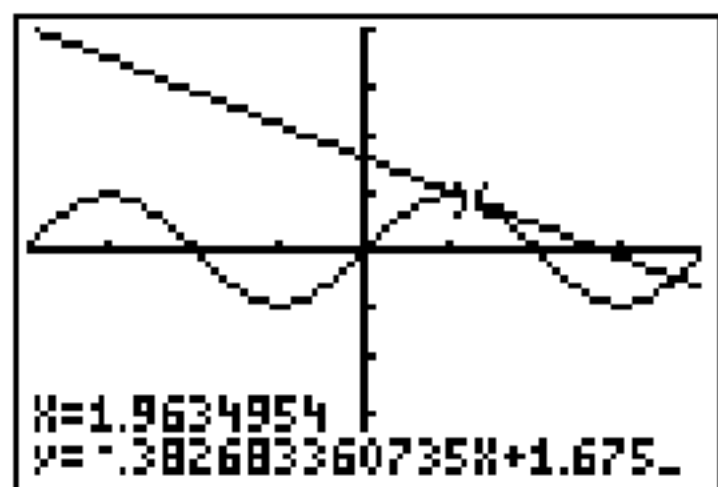

Note: Change the fixed decimal setting on the mode screen if you want to see fewer digits displayed for X and the equation for Y.

Drawing a Tangent Line from the Home Screen or a Program

Tangent((tangent line) draws a line tangent to *expression* in terms of X, such as Y1 or X^2 , at point $X=value$. X can be an expression. *expression* is interpreted as being in Func mode.

Tangent(*expression,value*)

```
Tangent(Y1,3)■
```

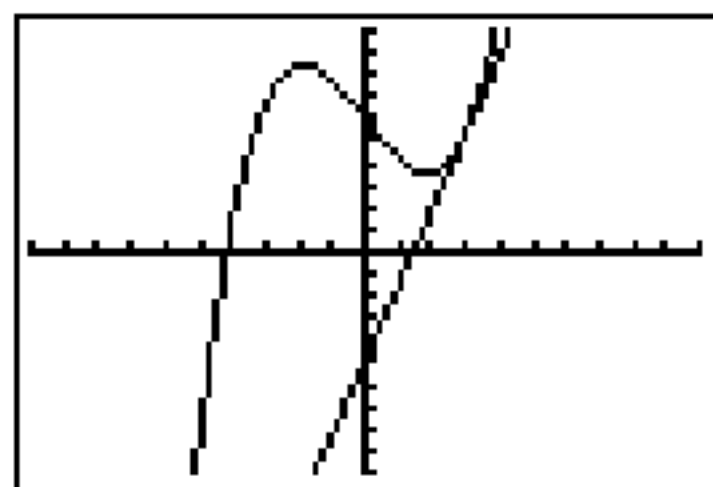

Drawing Functions and Inverses

Drawing a Function

DrawF (draw function) draws *expression* as a function in terms of X on the current graph. When you select **6:DrawF** from the **DRAW** menu, the TI-84 Plus returns to the home screen or the program editor. **DrawF** is not interactive.

DrawF *expression*

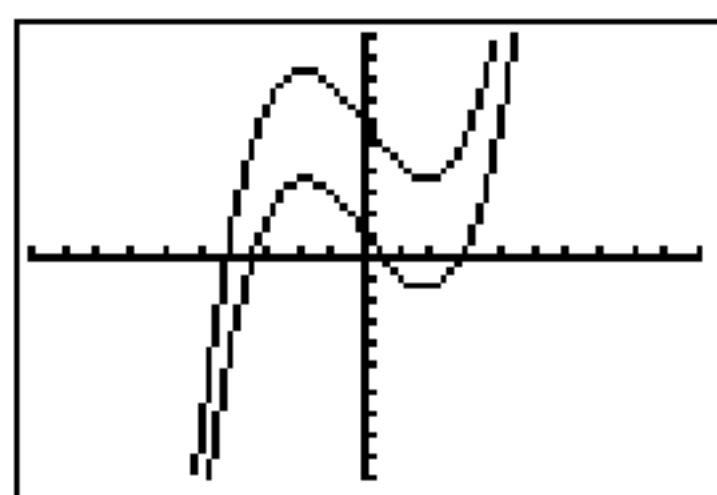
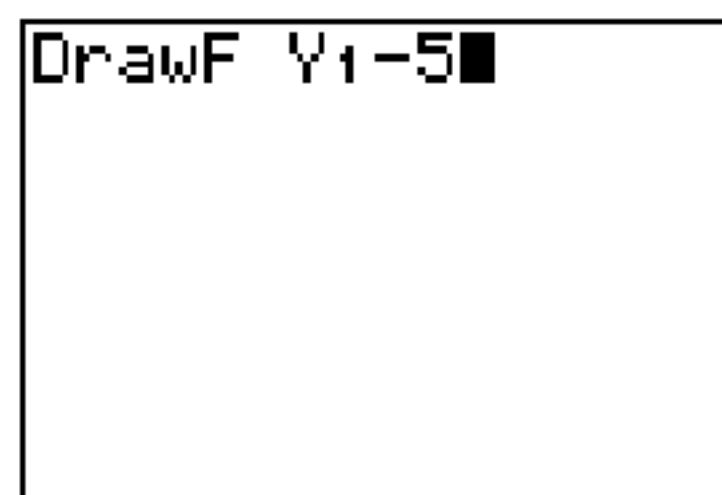

Note: You cannot use a list in *expression* to draw a family of curves.

Drawing an Inverse of a Function

DrawInv (draw inverse) draws the inverse of *expression* by plotting X values on the y-axis and Y values on the x-axis. When you select **8:DrawInv** from the **DRAW** menu, the TI-84 Plus returns to the home screen or the program editor. **DrawInv** is not interactive.

DrawInv works in Func mode only.

DrawInv *expression*

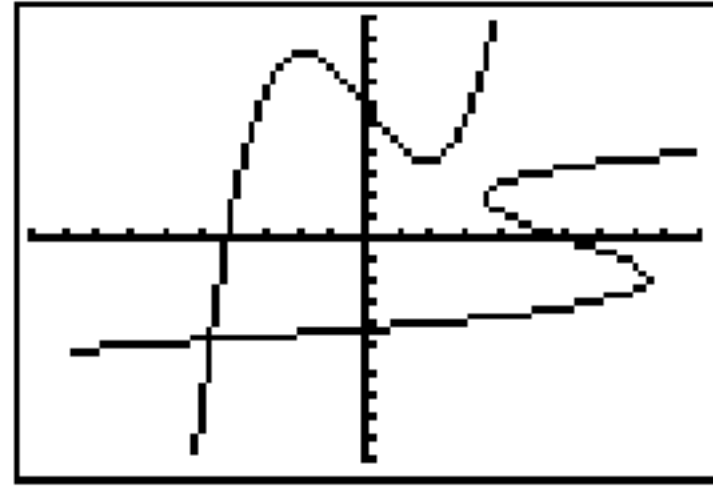

Note: You cannot use a list in *expression* to draw a family of curves.

Shading Areas on a Graph

Shading a Graph

To shade an area on a graph, select **7:Shade(** from the **DRAW** menu. The instruction is pasted to the home screen or to the program editor.

Shade(draws *lowerfunc* and *upperfunc* in terms of *X* on the current graph and shades the area that is specifically above *lowerfunc* and below *upperfunc*. Only the areas where $lowerfunc < upperfunc$ are shaded.

Xleft and *Xright*, if included, specify left and right boundaries for the shading. *Xleft* and *Xright* must be numbers between **Xmin** and **Xmax**, which are the defaults.

pattern specifies one of four shading patterns.

<i>pattern=1</i>	vertical (default)
<i>pattern=2</i>	horizontal
<i>pattern=3</i>	negative—slope 45°
<i>pattern=4</i>	positive—slope 45°

patres specifies one of eight shading resolutions.

<i>patres=1</i>	shades every pixel (default)
<i>patres=2</i>	shades every second pixel
<i>patres=3</i>	shades every third pixel
<i>patres=4</i>	shades every fourth pixel
<i>patres=5</i>	shades every fifth pixel
<i>patres=6</i>	shades every sixth pixel
<i>patres=7</i>	shades every seventh pixel
<i>patres=8</i>	shades every eighth pixel

Shade(*lowerfunc*,*upperfunc*[,*Xleft*,*Xright*,*pattern*,*patres*])

```
Shade(X3-8X,X-2)  
:Shade(X-2,X3-8X  
,-3,2,2,3)
```

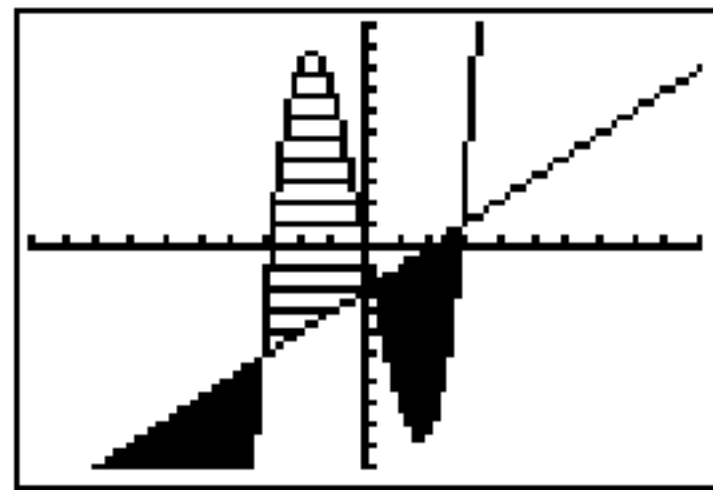

Drawing Circles

Drawing a Circle Directly on a Graph

To draw a circle directly on a displayed graph using the cursor, follow these steps.

1. Select **9:Circle(** from the **DRAW** menu.
2. Place the cursor at the center of the circle you want to draw. Press **ENTER**.
3. Move the cursor to a point on the circumference. Press **ENTER** to draw the circle on the graph.

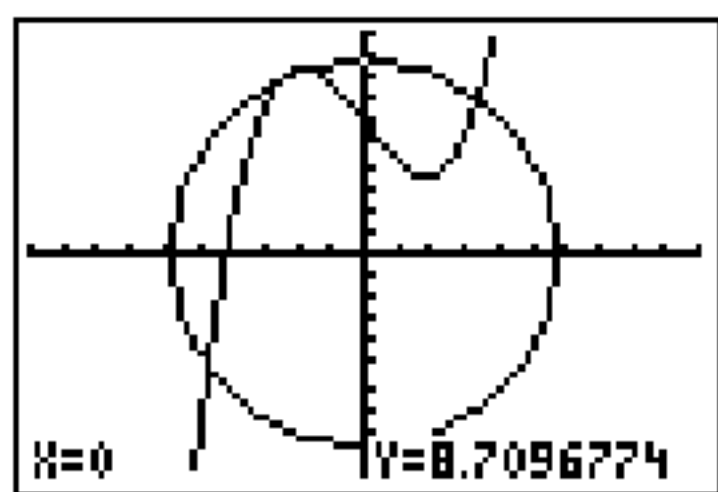

Note: This circle is displayed as circular, regardless of the window variable values, because you drew it directly on the display. When you use the **Circle(** instruction from the home screen or a program, the current window variables may distort the shape.

To continue drawing circles, repeat steps 2 and 3. To cancel **Circle(**, press **CLEAR**.

Drawing a Circle from the Home Screen or a Program

Circle(draws a circle with center (X,Y) and *radius*. These values can be expressions.

Circle($X,Y,radius$)

```
Circle(0,0,7)■
```

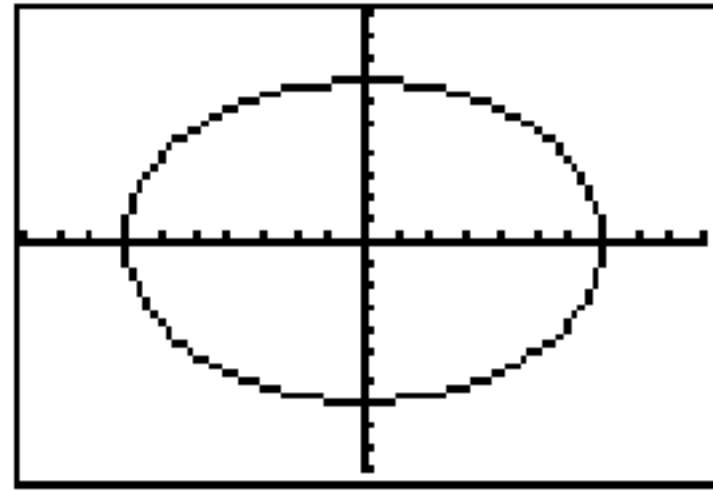
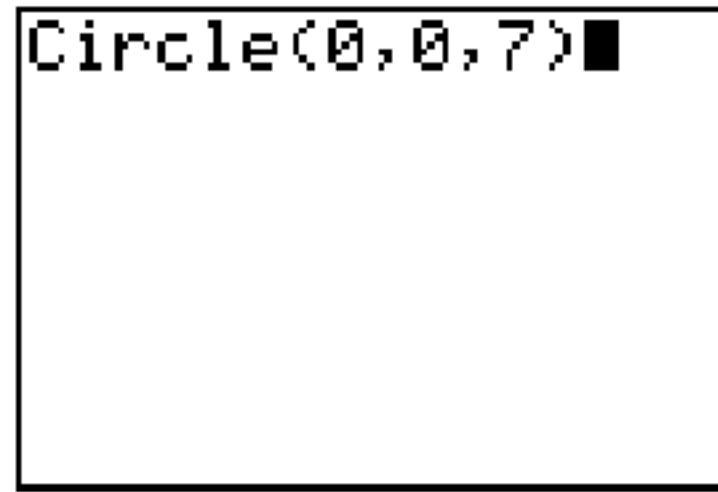

Note: When you use **Circle**(on the home screen or from a program, the current window values may distort the drawn circle. Use **ZSquare** (Chapter 3) before drawing the circle to adjust the window variables and make the circle circular.

Placing Text on a Graph

Placing Text Directly on a Graph

To place text on a graph when the graph is displayed, follow these steps.

1. Select **0:Text**(from the **DRAW** menu.
2. Place the cursor where you want the text to begin.
3. Enter the characters. Press **[ALPHA]** or **[2nd] [A-LOCK]** to enter letters and θ . You may enter TI-84 Plus functions, variables, and instructions. The font is proportional, so the exact number of characters you can place on the graph varies. As you type, the characters are placed on top of the graph.

To cancel **Text**(, press **[CLEAR]**.

Placing Text on a Graph from the Home Screen or a Program

Text(places on the current graph the characters comprising *value*, which can include TI-84 Plus functions and instructions. The top-left corner of the first character is at pixel (*row,column*), where *row* is an integer between 0 and 57 and *column* is an integer between 0 and 94. Both *row* and *column* can be expressions.

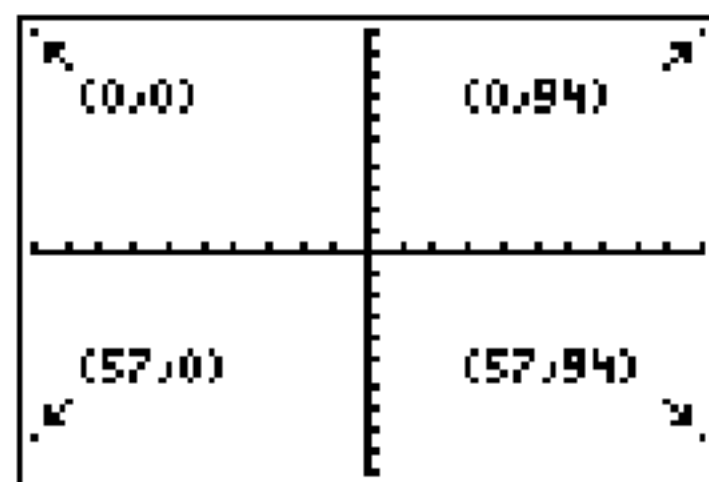

Text(*row,column,value,value...*)

value can be text enclosed in quotation marks ("), or it can be an expression. The TI-84 Plus will evaluate an expression and display the result with up to 10 characters.

```
Text(42,50,"Y1=.  
2X^3-2X+6")■
```

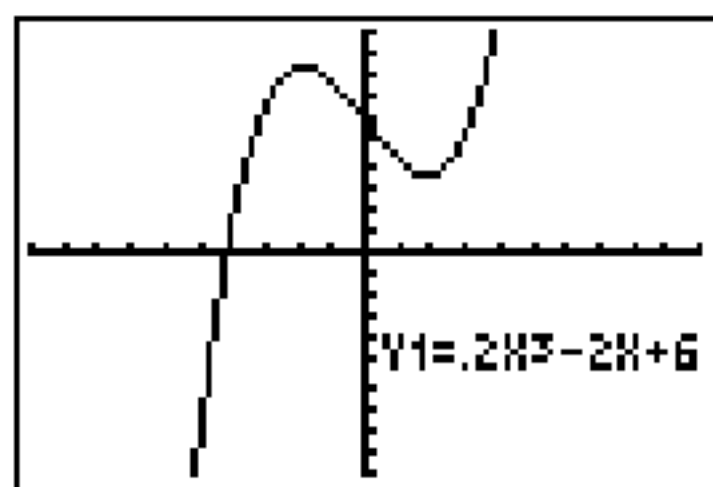

Split Screen

On a **Horiz** split screen, the maximum value for *row* is 25. On a **G-T** split screen, the maximum value for *row* is 45, and the maximum value for *column* is 46.

Using Pen to Draw on a Graph

Using Pen to Draw on a Graph

Pen draws directly on a graph only. You cannot execute **Pen** from the home screen or a program.

To draw on a displayed graph, follow these steps.

1. Select **A:Pen** from the **DRAW** menu.
2. Place the cursor on the point where you want to begin drawing. Press **ENTER** to turn on the pen.
3. Move the cursor. As you move the cursor, you draw on the graph, shading one pixel at a time.
4. Press **ENTER** to turn off the pen.

For example, **Pen** was used to create the arrow pointing to the local minimum of the selected function.

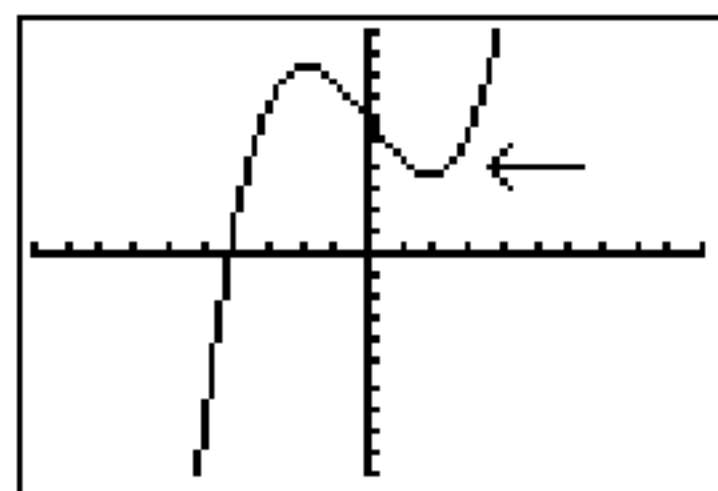

Note: To continue drawing on the graph, move the cursor to a new position where you want to begin drawing again, and then repeat steps 2, 3, and 4. To cancel **Pen**, press **CLEAR**.

Drawing Points on a Graph

DRAW POINTS Menu

To display the **DRAW POINTS** menu, press `[2nd] [DRAW] [▸]`. The TI-84 Plus's interpretation of these instructions depends on whether you accessed this menu from the home screen or the program editor or directly from a graph.

DRAW	POINTS	STO
1:	Pt-On (Turns on a point.
2:	Pt-Off (Turns off a point.
3:	Pt-Change (Toggles a point on or off.
4:	Pxl-On (Turns on a pixel.
5:	Pxl-Off (Turns off a pixel.
6:	Pxl-Change (Toggles a pixel on or off.
7:	pxl-Test (Returns 1 if pixel on, 0 if pixel off.

Drawing Points Directly on a Graph with Pt-On(

To draw a point on a graph, follow these steps.

1. Select **1:Pt-On(** from the **DRAW POINTS** menu.
2. Move the cursor to the position where you want to draw the point.
3. Press `[ENTER]` to draw the point.

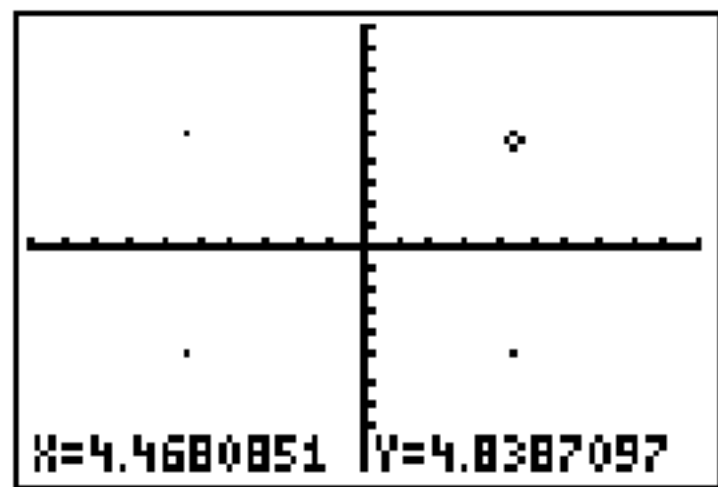

To continue drawing points, repeat steps 2 and 3. To cancel **Pt-On**(, press **CLEAR**).

Erasing Points with Pt-Off(

To erase (turn off) a drawn point on a graph, follow these steps.

1. Select **2:Pt-Off**((point off) from the **DRAW POINTS** menu.
2. Move the cursor to the point you want to erase.
3. Press **ENTER** to erase the point.

To continue erasing points, repeat steps 2 and 3. To cancel **Pt-Off**(, press **CLEAR**).

Changing Points with Pt-Change(

To change (toggle on or off) a point on a graph, follow these steps.

1. Select **3:Pt-Change**((point change) from the **DRAW POINTS** menu.
2. Move the cursor to the point you want to change.
3. Press **ENTER** to change the point's on/off status.

To continue changing points, repeat steps 2 and 3. To cancel **Pt-Change**(, press **CLEAR**).

Drawing Points from the Home Screen or a Program

Pt-On((point on) turns on the point at ($X=x, Y=y$). **Pt-Off**(turns the point off. **Pt-Change**(toggles the point on or off. *mark* is optional; it determines the point's appearance; specify 1, 2, or 3, where:

1 = • (dot; default) 2 = □ (box) 3 = + (cross)

Pt-On($x,y[,mark]$)

Pt-Off($x,y[,mark]$)

Pt-Change(x,y)

```
Pt-On(2,5,2):Pt-  
On(5,5,3):Pt-On(  
8,5,1)
```

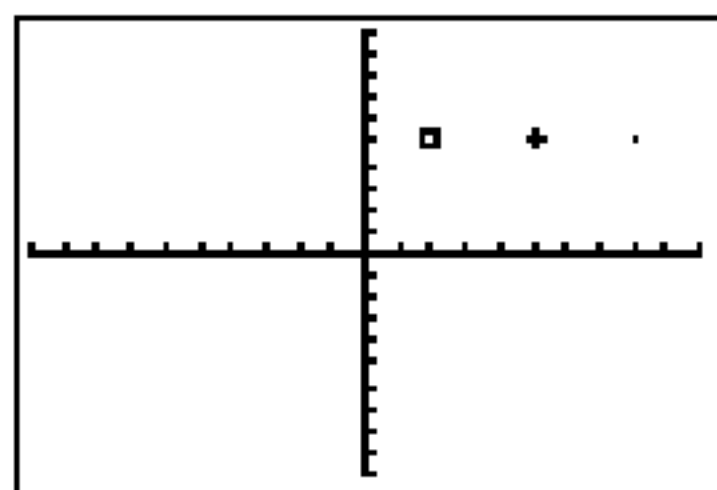

Note: If you specified *mark* to turn on a point with **Pt-On**(, you must specify *mark* when you turn off the point with **Pt-Off**(. **Pt-Change**(does not have the *mark* option.

Drawing Pixels

TI-84 Plus Pixels

A pixel is a square dot on the TI-84 Plus display. The **Pxl-** (pixel) instructions let you turn on, turn off, or reverse a pixel (dot) on the graph using the cursor. When you select a pixel instruction from the **DRAW POINTS** menu, the TI-84 Plus returns to the home screen or the program editor. The pixel instructions are not interactive.

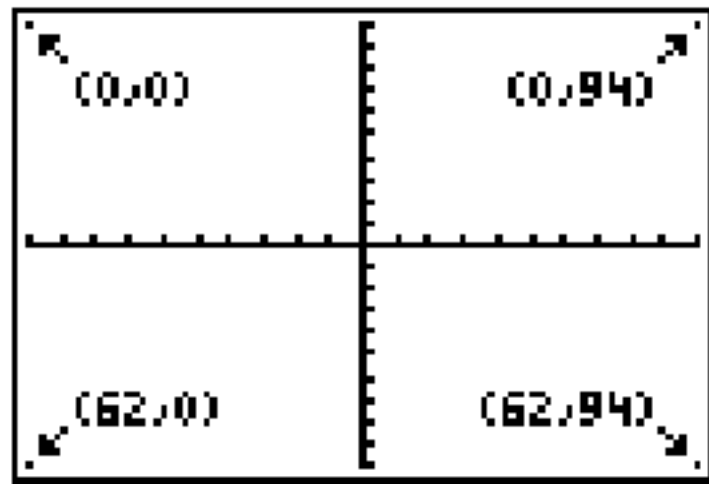

Turning On and Off Pixels with Pxl-On(and Pxl-Off(

Pxl-On((pixel on) turns on the pixel at $(row, column)$, where row is an integer between 0 and 62 and $column$ is an integer between 0 and 94.

Pxl-Off(turns the pixel off. **Pxl-Change(** toggles the pixel on and off.

Pxl-On(*row,column*)

Pxl-Off(*row,column*)

Pxl-Change(*row,column*)

Using pxl-Test(

pxl-Test((pixel test) returns 1 if the pixel at $(row, column)$ is turned on or 0 if the pixel is turned off on the current graph. row must be an integer between 0 and 62. $column$ must be an integer between 0 and 94.

pxl-Test(*row,column*)

Split Screen

On a **Horiz** split screen, the maximum value for *row* is 30 for **Pxl-On()**, **Pxl-Off()**, **Pxl-Change()**, and **pxl-Test()**.

On a **G-T** split screen, the maximum value for *row* is 50 and the maximum value for *column* is 46 for **Pxl-On()**, **Pxl-Off()**, **Pxl-Change()**, and **pxl-Test()**.

Storing Graph Pictures (Pic)

DRAW STO Menu

To display the **DRAW STO** menu, press $\boxed{2nd}$ \boxed{DRAW} $\boxed{\downarrow}$. When you select an instruction from the **DRAW STO** menu, the TI-84 Plus returns to the home screen or the program editor. The picture and graph database instructions are not interactive.

DRAW POINTS	STO
1: StorePic	Stores the current picture.
2: RecallPic	Recalls a saved picture.
3: StoreGDB	Stores the current graph database.
4: RecallGDB	Recalls a saved graph database.

Storing a Graph Picture

You can store up to 10 graph pictures, each of which is an image of the current graph display, in picture variables **Pic1** through **Pic9**, or **Pic0**. Later, you can superimpose the stored picture onto a displayed graph from the home screen or a program.

A picture includes drawn elements, plotted functions, axes, and tick marks. The picture does not include axes labels, lower and upper bound indicators, prompts, or cursor coordinates. Any parts of the display hidden by these items are stored with the picture.

To store a graph picture, follow these steps.

1. Select **1:StorePic** from the **DRAW STO** menu. **StorePic** is pasted to the current cursor location.
2. Enter the number (from 1 to 9, or 0) of the picture variable to which you want to store the picture. For example, if you enter 3, the TI-84 Plus will store the picture to **Pic3**.

```
StorePic 3
```

Note: You also can select a variable from the **PICTURE** secondary menu (**VAR** 4). The variable is pasted next to **StorePic**.

3. Press **ENTER** to display the current graph and store the picture.

Recalling Graph Pictures (Pic)

Recalling a Graph Picture

To recall a graph picture, follow these steps.

1. Select **2:RecallPic** from the **DRAW STO** menu. **RecallPic** is pasted to the current cursor location.
2. Enter the number (from 1 to 9, or 0) of the picture variable from which you want to recall a picture. For example, if you enter 3, the TI-84 Plus will recall the picture stored to **Pic3**.

```
RecallPic 3
```

Note: You also can select a variable from the **PICTURE** secondary menu (**VAR** 4). The variable is pasted next to **RecallPic**.

3. Press **ENTER** to display the current graph with the picture superimposed on it.
Note: Pictures are drawings. You cannot trace a curve that is part of a picture.

Deleting a Graph Picture

To delete graph pictures from memory, use the **MEMORY MANAGEMENT/DELETE** secondary menu (Chapter 18).

Storing Graph Databases (GDB)

What Is a Graph Database?

A graph database (GDB) contains the set of elements that defines a particular graph. You can recreate the graph from these elements. You can store up to 10 GDBs in variables GDB1 through GDB9, or GDB0 and recall them to recreate graphs.

A GDB stores five elements of a graph.

- Graphing mode
- Window variables
- Format settings
- All functions in the Y= editor and the selection status of each
- Graph style for each Y= function

GDBs do not contain drawn items or stat plot definitions.

Storing a Graph Database

To store a graph database, follow these steps.

1. Select **3:StoreGDB** from the **DRAW STO** menu. **StoreGDB** is pasted to the current cursor location.
2. Enter the number (from 1 to 9, or 0) of the **GDB** variable to which you want to store the graph database. For example, if you enter 7, the TI-84 Plus will store the **GDB** to **GDB7**.

```
StoreGDB 7
```

Note: You also can select a variable from the **GDB** secondary menu (**VAR** **3**). The variable is pasted next to **StoreGDB**.

3. Press **ENTER** to store the current database to the specified **GDB** variable.

Recalling Graph Databases (GDB)

Recalling a Graph Database

CAUTION: When you recall a GDB, it replaces all existing Y= functions. Consider storing the current Y= functions to another database before recalling a stored GDB.

To recall a graph database, follow these steps.

1. Select **4:RecallGDB** from the **DRAW STO** menu. **RecallGDB** is pasted to the current cursor location.
2. Enter the number (from 1 to 9, or 0) of the **GDB** variable from which you want to recall a **GDB**. For example, if you enter 7, the TI-84 Plus will recall the **GDB** stored to **GDB7**.

```
RecallGDB 7
```

Note: You also can select a variable from the **GDB** secondary menu (**VAR** **3**). The variable is pasted next to **RecallGDB**.

3. Press **ENTER** to replace the current **GDB** with the recalled **GDB**. The new graph is not plotted. The TI-84 Plus changes the graphing mode automatically, if necessary.

Deleting a Graph Database

To delete a GDB from memory, use the **MEMORY MANAGEMENT/DELETE** secondary menu (Chapter 18).

Chapter 9: Split Screen

Getting Started: Exploring the Unit Circle

Getting Started is a fast-paced introduction. Read the chapter for details.

Use **G-T** (graph-table) split-screen mode to explore the unit circle and its relationship to the numeric values for the commonly used trigonometric angles of 0° , 30° , 45° , 60° , 90° , and so on.

1. Press **MODE** to display the mode screen. Press \blacktriangledown \blacktriangleright **ENTER** to select **Degree** mode. Press \blacktriangledown \blacktriangleright **ENTER** to select **Par** (parametric) graphing mode.

Press \blacktriangledown \blacktriangledown \blacktriangledown \blacktriangleright \blacktriangleright **ENTER** to select **G-T** (graph-table) split-screen mode.

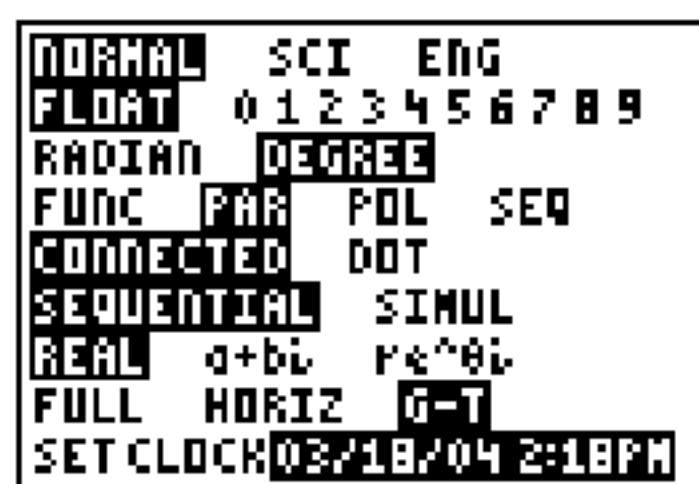

```
NORMAL SCI ENG
FLOAT 0123456789
RADIAN DEGREE
FUNC PAR POL SEQ
CONNECTED DOT
SEQUENTIAL SIMUL
REAL a+bi P<Q%
FULL HORIZ G-T
SETCLOCK03/18/04 2:18PM
```

2. Press **2nd** **[FORMAT]** to display the format screen. Press \blacktriangledown \blacktriangledown \blacktriangledown \blacktriangledown \blacktriangleright **ENTER** to select **ExprOff**.

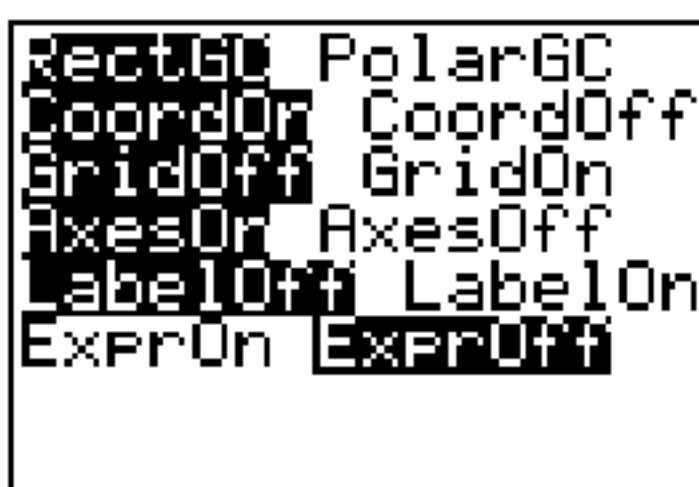

```
RectGC PolarGC
CoordOn CoordOff
GridOff GridOn
AxesOn AxesOff
LabelOff LabelOn
ExprOn ExprOff
```

3. Press $\boxed{Y=}$ to display the Y= editor for **Par** graphing mode. Press $\boxed{\text{COS}} \boxed{X,T,\theta,n} \boxed{)} \boxed{\text{ENTER}}$ to store $\cos(T)$ to **X1T**. Press $\boxed{\text{SIN}} \boxed{X,T,\theta,n} \boxed{)} \boxed{\text{ENTER}}$ to store $\sin(T)$ to **Y1T**.

```

Plot1 Plot2 Plot3
X1T = cos(T)
Y1T = sin(T)
X2T =
Y2T =
X3T =
Y3T =
X4T =

```

4. Press $\boxed{\text{WINDOW}}$ to display the window editor. Enter these values for the window variables.

Tmin=0 **Xmin=-2.3** **Ymin=-2.5**
Tmax=360 **Xmax=2.3** **Ymax=2.5**
Tstep=15 **Xscl=1** **Yscl=1**

5. Press $\boxed{\text{TRACE}}$. On the left, the unit circle is graphed parametrically in **Degree** mode and the trace cursor is activated. When $T=0$ (from the graph trace coordinates), you can see from the table on the right that the value of **X1T** ($\cos(T)$) is 1 and **Y1T** ($\sin(T)$) is 0. Press $\boxed{\rightarrow}$ to move the cursor to the next 15° angle increment. As you trace around the circle in steps of 15° , an approximation of the standard value for each angle is highlighted in the table.

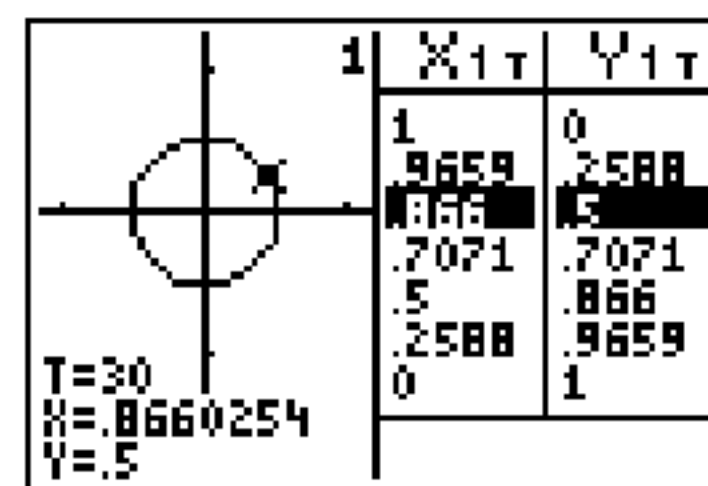

6. Press $\boxed{2nd} \boxed{[TBLSET]}$ and change **Indpnt** to **Ask**.
7. Press $\boxed{2nd} \boxed{[TABLE]}$ to make the table portion of the split screen active. Press $\boxed{\downarrow}$ or $\boxed{\uparrow}$ to highlight a value you want to edit, and then enter a new value directly in the table to overwrite the previous value.

Using Split Screen

Setting a Split-Screen Mode

To set a split-screen mode, press **MODE**, and then move the cursor to the next-to-last line on the mode screen.

- Select **Horiz** (horizontal) to display the graph screen and another screen split horizontally.
- Select **G-T** (graph-table) to display the graph screen and table screen split vertically.

```
NORMAL SCI ENG
FLOAT 0 1 2 3 4 5 6 7 8 9
RADIAN DEGREE
FUNC PAR POL SEQ
CONNECTED DOT
SEQUENTIAL SIMUL
REAL a+bi re^θi
FULL HORIZ G-T
SET CLOCH03/18/04 2:18PM
```

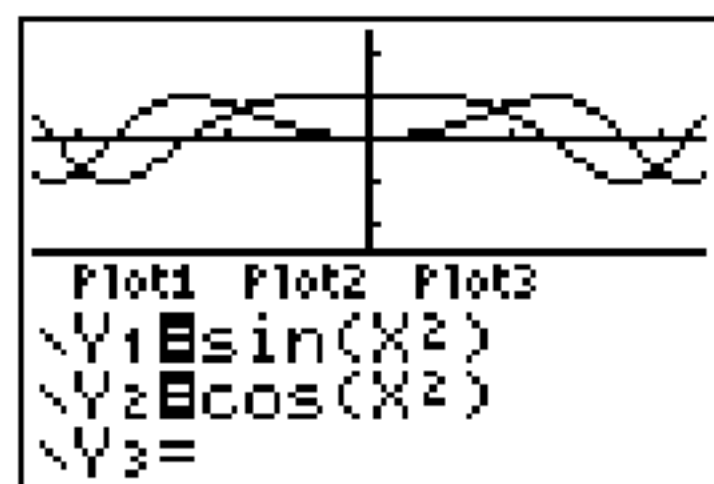

```
NORMAL SCI ENG
FLOAT 0 1 2 3 4 5 6 7 8 9
RADIAN DEGREE
FUNC PAR POL SEQ
CONNECTED DOT
SEQUENTIAL SIMUL
REAL a+bi re^θi
FULL HORIZ G-T
SET CLOCH03/18/04 2:18PM
```

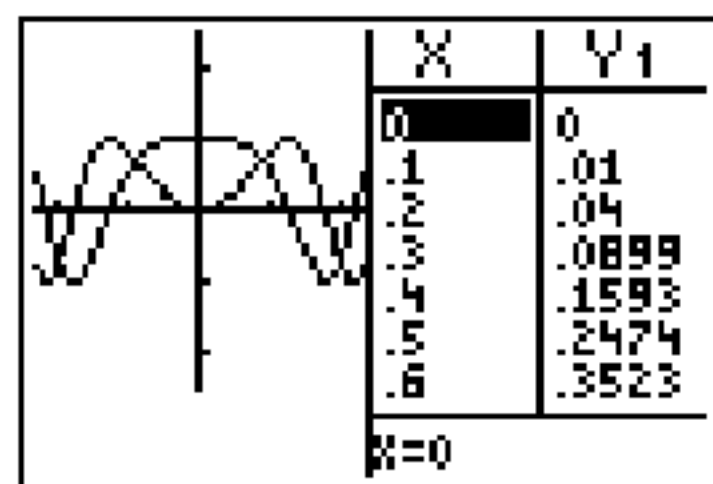

The split screen is activated when you press any key that applies to either half of the split screen.

If stat plots are turned on, the plots are shown along with the x-y plots in graphs. Press $\boxed{2\text{nd}} \boxed{[\text{TABLE}]}$ to make the table portion of the split screen active and to display the list data. Press $\boxed{\downarrow}$ or $\boxed{\uparrow}$ to highlight a value you want to edit, and then enter a new value directly in the table to overwrite the previous value. Press $\boxed{\rightarrow}$ repeatedly to display each column of data (both table and list data).

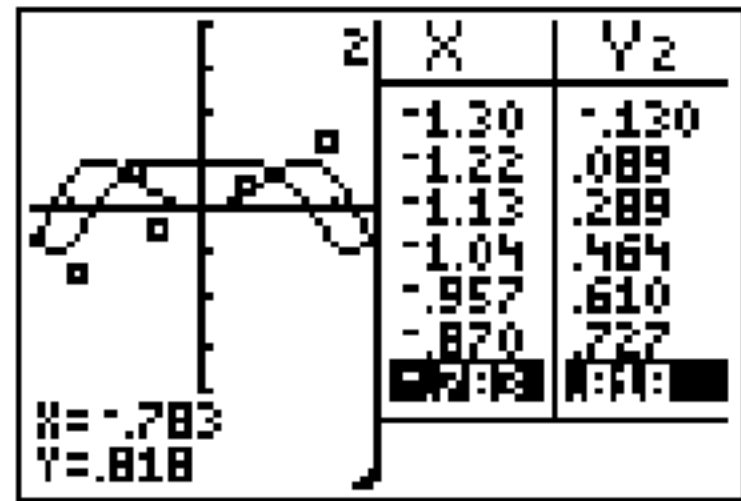

Split-screen display with both x-y plots and stat plots

Some screens are never displayed as split screens. For example, if you press $\boxed{[\text{MODE}]}$ in **Horiz** or **G-T** mode, the mode screen is displayed as a full screen. If you then press a key that displays either half of a split screen, such as $\boxed{[\text{TRACE}]}$, the split screen returns.

When you press a key or key combination in either **Horiz** or **G-T** mode, the cursor is placed in the half of the display for which that key applies. For example, if you press $\boxed{[\text{TRACE}]}$, the cursor is placed in the half in which the graph is displayed. If you press $\boxed{2\text{nd}} \boxed{[\text{TABLE}]}$, the cursor is placed in the half in which the table is displayed.

The TI-84 Plus will remain in split-screen mode until you change back to **Full** screen mode.

Horiz (Horizontal) Split Screen

Horiz Mode

In **Horiz** (horizontal) split-screen mode, a horizontal line splits the screen into top and bottom halves.

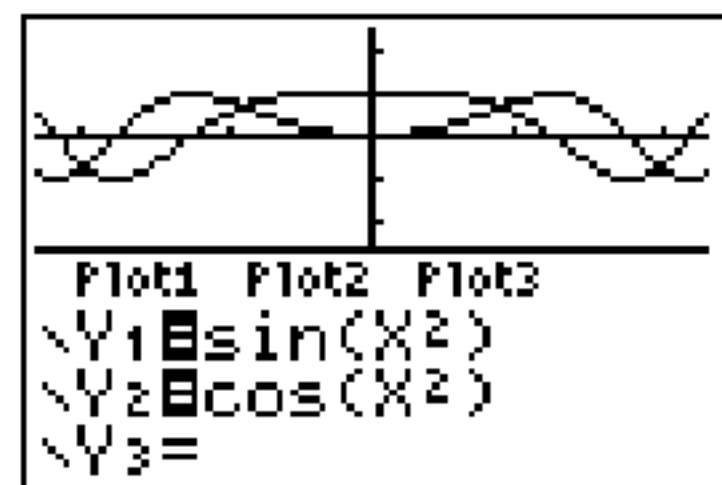

The top half displays the graph.

The bottom half displays any of these editors.

- Home screen (four lines)
- Y= editor (four lines)
- Stat list editor (two rows)
- Window editor (three settings)
- Table editor (two rows)

Moving from Half to Half in Horiz Mode

To use the top half of the split screen:

- Press **GRAPH** or **TRACE**.
- Select a ZOOM or CALC operation.

To use the bottom half of the split screen:

- Press any key or key combination that displays the home screen.
- Press **Y=** (Y= editor).
- Press **STAT** **ENTER** (stat list editor).
- Press **WINDOW** (window editor).
- Press **2nd** **TABLE** (table editor).

Full Screens in Horiz Mode

All other screens are displayed as full screens in **Horiz** split-screen mode.

To return to the **Horiz** split screen from a full screen when in **Horiz** mode, press any key or key combination that displays the graph, home screen, Y= editor, stat list editor, window editor, or table editor.

G-T (Graph-Table) Split Screen

G-T Mode

In **G-T** (graph-table) split-screen mode, a vertical line splits the screen into left and right halves.

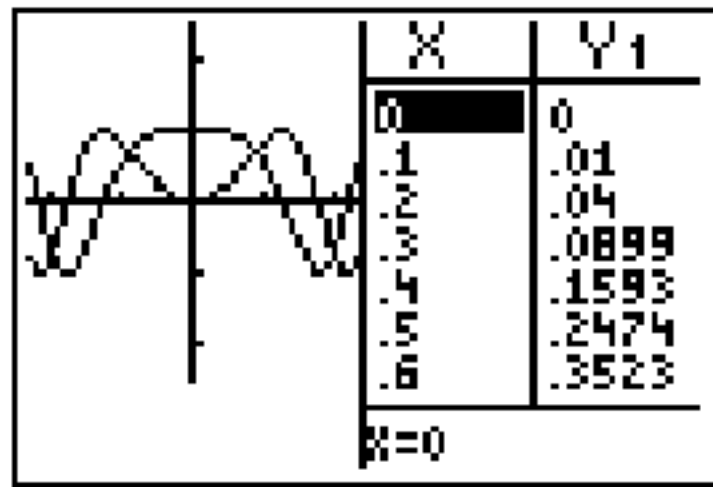

The left half displays all active graphs and plots.

The right half displays either table data corresponding to the graph at the left or list data corresponding to the plot at the left.

Moving from Half to Half in G-T Mode

To use the left half of the split screen:

- Press **GRAPH** or **TRACE**.
- Select a ZOOM or CALC operation.

To use the right half of the split screen, press **2nd** **[TABLE]**. If the values at the right are list data, these values can be edited similarly to using the Stat List Editor.

Using TRACE in G-T Mode

As you press **◀** or **▶** to move the trace cursor along a graph in the split screen's left half in **G-T** mode, the table on the right half automatically scrolls to match the current cursor values. If more than one graph or plot is active, you can press **▲** or **▼** to select a different graph or plot.

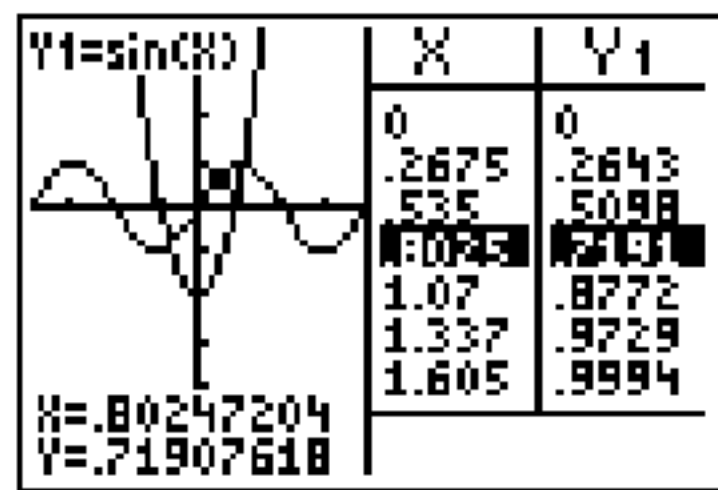

Note: When you trace in **Par** graphing mode, both components of an equation (X_nT and Y_nT) are displayed in the two columns of the table. As you trace, the current value of the independent variable T is displayed on the graph.

Full Screens in G-T Mode

All screens other than the graph and the table are displayed as full screens in **G-T** split-screen mode.

To return to the **G-T** split screen from a full screen when in **G-T** mode, press any key or key combination that displays the graph or the table.

TI-84 Plus Pixels in Horiz and G-T Modes

TI-84 Plus Pixels in Horiz and G-T Modes

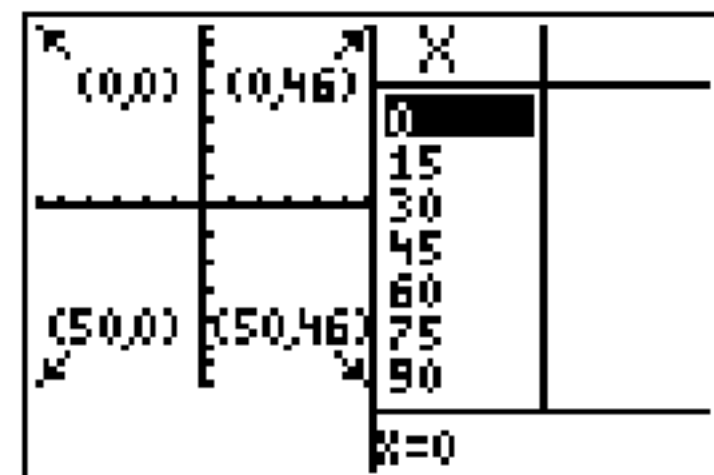
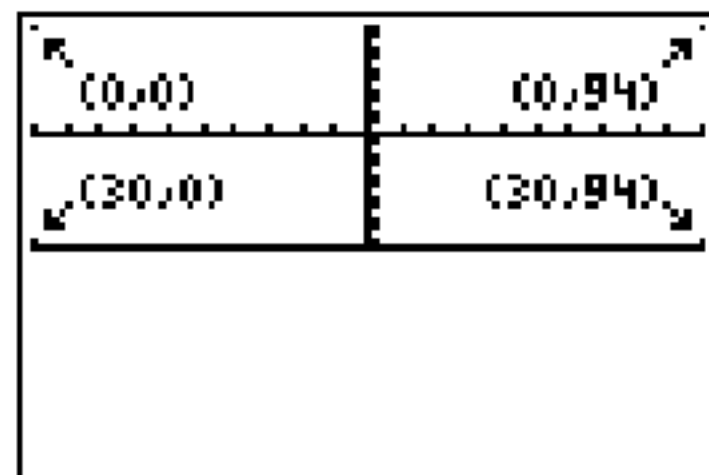

Note: Each set of numbers in parentheses above represents the row and column of a corner pixel, which is turned on.

DRAW POINTS Menu Pixel Instructions

For **Pxl-On**(, **Pxl-Off**(, **Pxl-Change**(, and **pxl-Test**(:

- In **Horiz** mode, *row* must be ≤ 30 ; *column* must be ≤ 94 .
- In **G-T** mode, *row* must be ≤ 50 ; *column* must be ≤ 46 .

Pxl-On(*row,column*)

DRAW Menu Text(Instruction

For the **Text**(instruction:

- In **Horiz** mode, *row* must be ≤ 25 ; *column* must be ≤ 94 .
- In **G-T** mode, *row* must be ≤ 45 ; *column* must be ≤ 46 .

Text(*row,column,"text"*)

PRGM I/O Menu Output(Instruction

For the **Output**(instruction:

- In **Horiz** mode, *row* must be ≤ 4 ; *column* must be ≤ 16 .
- In **G-T** mode, *row* must be ≤ 8 ; *column* must be ≤ 16 .

Output(*row,column,"text"*)

Note: The **Output**(instruction can only be used within a program.

Setting a Split-Screen Mode from the Home Screen or a Program

To set **Horiz** or **G-T** from a program, follow these steps.

1. Press **MODE** while the cursor is on a blank line in the program editor.
2. Select **Horiz** or **G-T**.

The instruction is pasted to the cursor location. The mode is set when the instruction is encountered during program execution. It remains in effect after execution.

Note: You also can paste **Horiz** or **G-T** to the home screen or program editor from the CATALOG (Chapter 15).

Chapter 10: Matrices

Getting Started: Systems of Linear Equations

Getting Started is a fast-paced introduction. Read the chapter for details.

Find the solution of $X + 2Y + 3Z = 3$ and $2X + 3Y + 4Z = 3$. On the TI-84 Plus, you can solve a system of linear equations by entering the coefficients as elements in a matrix, and then using `rref()` to obtain the reduced row-echelon form.

1. Press `2nd` `MATRIX`. Press `▶` `▶` to display the **MATRIX EDIT** menu. Press `1` to select **1: [A]**.
2. Press `2` `ENTER` `4` `ENTER` to define a 2×4 matrix. The rectangular cursor indicates the current element. Ellipses (...) indicate additional columns beyond the screen.
3. Press `1` `ENTER` to enter the first element. The rectangular cursor moves to the second column of the first row.

```
randBin(10,.5,40  
)  
{5 5 7 4 6 6 3 ...
```

```
randBin(10,.5,40  
)  
{5 5 7 4 6 6 3 ...  
Ans→L1  
{5 5 7 4 6 6 3 ...
```

- Press 2 $\boxed{\text{ENTER}}$ 3 $\boxed{\text{ENTER}}$ 3 $\boxed{\text{ENTER}}$ to complete the first row for $X + 2Y + 3Z = 3$.
- Press 2 $\boxed{\text{ENTER}}$ 3 $\boxed{\text{ENTER}}$ 4 $\boxed{\text{ENTER}}$ 3 $\boxed{\text{ENTER}}$ to enter the second row for $2X + 3Y + 4Z = 3$.

```
randBin(10,.5,40
)
(5 5 7 4 6 6 3 ...
Ans→L1
...2 5 3 6 5 7 5 ...
```

- Press $\boxed{2\text{nd}}$ $\boxed{\text{QUIT}}$ to return to the home screen. If necessary, press $\boxed{\text{CLEAR}}$ to clear the home screen. Press $\boxed{2\text{nd}}$ $\boxed{\text{MATRX}}$ $\boxed{\blacktriangleright}$ to display the **MATRX MATH** menu. Press $\boxed{\blacktriangle}$ to wrap to the end of the menu. Select **B:rref(** to copy **rref(** to the home screen.

```
rref(■
```

- Press $\boxed{2\text{nd}}$ $\boxed{\text{MATRX}}$ $\mathbf{1}$ to select **1:[A]** from the **MATRX NAMES** menu. Press $\boxed{\blacktriangleright}$ $\boxed{\text{ENTER}}$. The reduced row-echelon form of the matrix is displayed and stored in **Ans**.

```
rref([A])
[[1 0 -1 -3]
 [0 1 2 3 1]
```

$$\begin{array}{lll} 1X - 1Z = -3 & \text{therefore} & X = -3 + Z \\ 1Y + 2Z = 3 & \text{therefore} & Y = 3 - 2Z \end{array}$$

Defining a Matrix

What Is a Matrix?

A matrix is a two-dimensional array. You can display, define, or edit a matrix in the matrix editor. The TI-84 Plus has 10 matrix variables, **[A]** through **[J]**. You can define a matrix directly in an expression. A matrix, depending on available memory, may have up to 99 rows or columns. You can store only real numbers in TI-84 Plus matrices.

Selecting a Matrix

Before you can define or display a matrix in the editor, you first must select the matrix name. To do so, follow these steps.

1. Press $\boxed{2\text{nd}}$ $\boxed{\text{MATRX}}$ $\boxed{\downarrow}$ to display the **MATRIX EDIT** menu. The dimensions of any previously defined matrices are displayed.

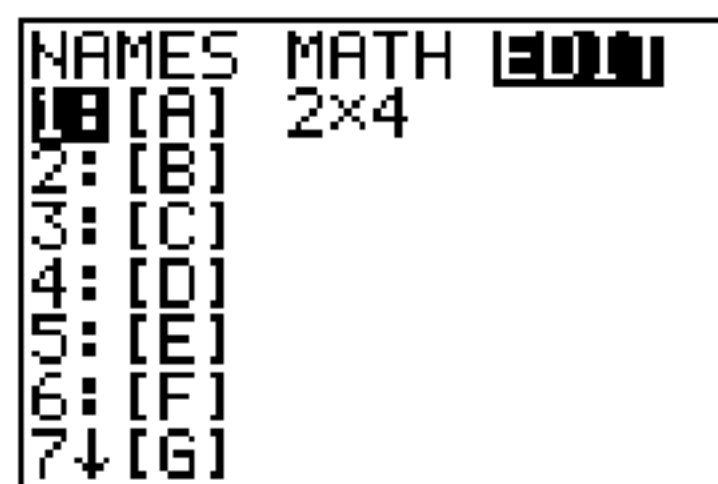

```
NAMES MATH  $\boxed{\text{EDIT}}$ 
1: [A] 2x4
2: [B]
3: [C]
4: [D]
5: [E]
6: [F]
7: [G]
```

2. Select the matrix you want to define. The **MATRIX EDIT** screen is displayed.

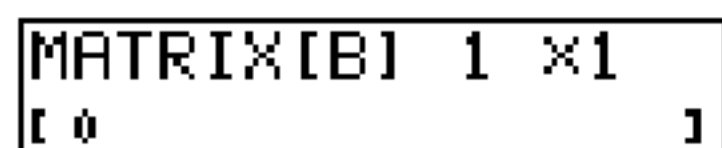

```
MATRIX[B] 1 x1
| 0 |
```

Accepting or Changing Matrix Dimensions

The dimensions of the matrix (*row* \times *column*) are displayed on the top line. The dimensions of a new matrix are 1×1 . You must accept or change the dimensions each time you edit a matrix. When you select a matrix to define, the cursor highlights the row dimension.

- To accept the row dimension, press $\boxed{\text{ENTER}}$.
- To change the row dimension, enter the number of rows (up to 99), and then press $\boxed{\text{ENTER}}$.

The cursor moves to the column dimension, which you must accept or change the same way you accepted or changed the row dimension. When you press **ENTER**, the rectangular cursor moves to the first matrix element.

Viewing and Editing Matrix Elements

Displaying Matrix Elements

After you have set the dimensions of the matrix, you can view the matrix and enter values for the matrix elements. In a new matrix, all values are zero.

Select the matrix from the **MATRIX EDIT** menu and enter or accept the dimensions. The center portion of the matrix editor displays up to seven rows and three columns of a matrix, showing the values of the elements in abbreviated form if necessary. The full value of the current element, which is indicated by the rectangular cursor, is displayed on the bottom line.

```
MATRIX[A] 8 x4
[ 3.14159  -3.142  13  -
[ -1      3.1416  0  -
[ 0       0       0  -
[ 0       0       88  -
[ 1.8     0       0  -
[ 0       .85714  0  -
[ 0       0       2  ↓
1, 1=3.141592653
```

This is an 8×4 matrix. Ellipses in the left or right column indicate additional columns. \uparrow or \downarrow in the right column indicate additional rows.

Deleting a Matrix

To delete matrices from memory, use the **MEMORY MANAGEMENT/DELETE** secondary menu (Chapter 18).

Viewing a Matrix

The matrix editor has two contexts, viewing and editing. In viewing context, you can use the cursor keys to move quickly from one matrix element to the next. The full value of the highlighted element is displayed on the bottom line.

Select the matrix from the **MATRIX EDIT** menu, and then enter or accept the dimensions.

```
MATRIX[A] 8 x4
[ 3.14159  -3.142  13  -
[ -1      3.1416  0  -
[ 0       0      0  -
[ 0       0      88  -
[ 1.8     0      0  -
[ 0       .85714  0  -
[ 0       0      2  4
1, 1=3.141592653
```

Viewing-Context Keys

Key	Function
◀ or ▶	Moves the rectangular cursor within the current row
▼ or ▲	Moves the rectangular cursor within the current column; on the top row, ▲ moves the cursor to the column dimension; on the column dimension, ▲ moves the cursor to the row dimension

Key	Function
ENTER	Switches to editing context; activates the edit cursor on the bottom line
CLEAR	Switches to editing context; clears the value on the bottom line
Any entry character	Switches to editing context; clears the value on the bottom line; copies the character to the bottom line
2nd [INS]	Nothing
DEL	Nothing

Editing a Matrix Element

In editing context, an edit cursor is active on the bottom line. To edit a matrix element value, follow these steps.

1. Select the matrix from the **MATRIX EDIT** menu, and then enter or accept the dimensions.
2. Press **←**, **↑**, **→**, and **↓** to move the cursor to the matrix element you want to change.
3. Switch to editing context by pressing **ENTER**, **CLEAR**, or an entry key.
4. Change the value of the matrix element using the editing-context keys described below. You may enter an expression, which is evaluated when you leave editing context.

Note: You can press **CLEAR** **ENTER** to restore the value at the rectangular cursor if you make a mistake.

5. Press **ENTER**, **←**, or **↓** to move to another element.

```

MATRIX[A] 8 x4
[ 3.1416  -3.142  13  -
[ 2222  3.1416  0  -
[ 0  0  0  -
[ 0  0  88  -
[ 1.8  0  0  -
[ 0  .85714  0  -
[ 0  0  2  ↓
3, 1=2X^2+3

```

```

MATRIX[A] 8 x4
[ 3.1416  -3.142  13  -
[ 2222  3.1416  0  -
[ 112.33  0  0  -
[ 0  0  88  -
[ 1.8  0  0  -
[ 0  .85714  0  -
[ 0  0  2  ↓
3, 2=0

```

Editing-Context Keys

Key	Function
← or →	Moves the edit cursor within the value
↓ or ↑	Stores the value displayed on the bottom line to the matrix element; switches to viewing context and moves the rectangular cursor within the column
ENTER	Stores the value displayed on the bottom line to the matrix element; switches to viewing context and moves the rectangular cursor to the next row element
CLEAR	Clears the value on the bottom line
Any entry character	Copies the character to the location of the edit cursor on the bottom line
2nd [INS]	Activates the insert cursor
DEL	Deletes the character under the edit cursor on the bottom line

Using Matrices with Expressions

Using a Matrix in an Expression

To use a matrix in an expression, you can do any of the following.

- Copy the name from the **MATRIX NAMES** menu.
- Recall the contents of the matrix into the expression with $\boxed{2\text{nd}}$ [RCL] (Chapter 1).
- Enter the matrix directly (see below).

Entering a Matrix in an Expression

You can enter, edit, and store a matrix in the matrix editor. You also can enter a matrix directly in an expression.

To enter a matrix in an expression, follow these steps.

1. Press $\boxed{2\text{nd}}$ [[] to indicate the beginning of the matrix.
2. Press $\boxed{2\text{nd}}$ [[] to indicate the beginning of a row.
3. Enter a value, which can be an expression, for each element in the row. Separate the values with commas.
4. Press $\boxed{2\text{nd}}$ []] to indicate the end of a row.
5. Repeat steps 2 through 4 to enter all of the rows.

6. Press $\boxed{2nd}$ $\boxed{[]}$ to indicate the end of the matrix.

Note: The closing $\boxed{]}$ are not necessary at the end of an expression or preceding \rightarrow .

The resulting matrix is displayed in the form:

$[[element1,1,\dots,element1,n],\dots,[elementm,1,\dots,elementm,n]]$

Any expressions are evaluated when the entry is executed.

```
2*[[1,2,3][4,5,6]
]]
      [[2 4 6 ]
      [8 10 12]]
```

Note: The commas that you must enter to separate elements are not displayed on output.

Displaying and Copying Matrices

Displaying a Matrix

To display the contents of a matrix on the home screen, select the matrix from the **MATRIX NAMES** menu, and then press \boxed{ENTER} .

```
[A]
      [[7 8 9]
      [3 2 1]]
```

Ellipses in the left or right column indicate additional columns. \uparrow or \downarrow in the right column indicate additional rows. Press $\boxed{\rightarrow}$, $\boxed{\leftarrow}$, $\boxed{\downarrow}$, and $\boxed{\uparrow}$ to scroll the matrix.

...46.0000	161.0↑
...116.0000	-188.0...
...49.0000	-62.0...
...235.0000	-96.0...
...2.0000	65.00...
...47.0000	136.0...
...3.0000	-69.0↓

Copying One Matrix to Another

To copy a matrix, follow these steps.

1. Press $\boxed{2\text{nd}} \boxed{[\text{MATRIX}]}$ to display the **MATRIX NAMES** menu.
2. Select the name of the matrix you want to copy.
3. Press $\boxed{\text{STO} \blacktriangleright}$.
4. Press $\boxed{2\text{nd}} \boxed{[\text{MATRIX}]}$ again and select the name of the new matrix to which you want to copy the existing matrix.
5. Press $\boxed{\text{ENTER}}$ to copy the matrix to the new matrix name.

[A] → [B]	
	[[7 8 9]
	[3 2 1]]

Accessing a Matrix Element

On the home screen or from within a program, you can store a value to, or recall a value from, a matrix element. The element must be within the currently defined matrix dimensions. Select *matrix* from the **MATRIX NAMES** menu.

$[matrix](row,column)$

```
0→[B](2,3):[B]
      [7 8 9]
      [3 2 0]
[B](2,3)
      0
```

Using Math Functions with Matrices

Using Math Functions with Matrices

You can use many of the math functions on the TI-84 Plus keyboard, the **MATH** menu, the **MATH NUM** menu, and the **MATH TEST** menu with matrices. However, the dimensions must be appropriate. Each of the functions below creates a new matrix; the original matrix remains the same.

Addition, Subtraction, Multiplication

To add (\oplus) or subtract (\ominus) matrices, the dimensions must be the same. The answer is a matrix in which the elements are the sum or difference of the individual corresponding elements.

$matrixA+matrixB$

$matrixA-matrixB$

To multiply (\otimes) two matrices together, the column dimension of $matrixA$ must match the row dimension of $matrixB$.

*matrixA*matrixB*

$$\begin{array}{l} [A] \\ [B] \end{array} \begin{array}{l} \begin{bmatrix} 2 & 2 \\ 3 & 4 \end{bmatrix} \\ \begin{bmatrix} 0 & 5 \\ 4 & 3 \end{bmatrix} \end{array}$$

$$\begin{array}{l} [A] + [B] \\ [A] * [B] \end{array} \begin{array}{l} \begin{bmatrix} 2 & 7 \\ 7 & 7 \end{bmatrix} \\ \begin{bmatrix} 8 & 16 \\ 16 & 27 \end{bmatrix} \end{array}$$

Multiplying a *matrix* by a *value* or a *value* by a *matrix* returns a matrix in which each element of *matrix* is multiplied by *value*.

*matrix*value*

*value*matrix*

$$[A] * 3 \begin{bmatrix} 6 & 6 \\ 9 & 12 \end{bmatrix}$$

Negation

Negating a matrix ($[-]$) returns a matrix in which the sign of every element is changed (reversed).

$-matrix$

$$\begin{array}{l} [A] \\ -[A] \end{array} \begin{array}{l} \begin{bmatrix} 2 & -2 \\ 3 & 4 \end{bmatrix} \\ \begin{bmatrix} -2 & 2 \\ -3 & -4 \end{bmatrix} \end{array}$$

abs(

abs((absolute value, **MATH NUM** menu) returns a matrix containing the absolute value of each element of *matrix*.

abs(matrix)

```
[C]
  [ [-23 -69]
  [ [-25 -14] ]
abs(C)
  [ [23 69]
  [ [25 14] ]
```

round(

round((**MATH NUM** menu) returns a matrix. It rounds every element in *matrix* to *#decimals* (≤ 9). If *#decimals* is omitted, the elements are rounded to 10 digits.

round(matrix[,#decimals])

```
MATRIX[A] 2 x2
[ 1.259  2.333 ]
[ 3.662  4.121 ]
```

```
round([A],2)
  [ [1.26 2.33]
  [ [3.66 4.12] ]
```

Inverse

Use the $^{-1}$ function ($\boxed{x^{-1}}$) to invert a matrix (\wedge^{-1} is not valid). *matrix* must be square. The determinant cannot equal zero.

$matrix^{-1}$

```
MATRIX[A] 2 x2  
[ [ 1 2 ]  
  [ 3 4 ] ]
```

```
[A]^-1  
[ [-2 1 ]  
  [ 1.5 -.5 ] ]
```

Powers

To raise a matrix to a power, *matrix* must be square. You can use ² (x^2), ³ (**MATH** menu), or ^{power} (x^{\wedge}) for integer *power* between 0 and 255.

$matrix^2$

$matrix^3$

$matrix^{\wedge}power$

```
MATRIX[A] 2 x2  
[ [ 1 2 ]  
  [ 3 4 ] ]
```

```
[A]^3  
[ [37 54 ]  
  [81 118 ] ]  
[A]^5  
[ [1069 1558 ]  
  [2337 3406 ] ]
```

Relational Operations

To compare two matrices using the relational operations = and \neq (**TEST** menu), they must have the same dimensions. = and \neq compare *matrixA* and *matrixB* on an element-by-element basis. The other relational operations are not valid with matrices.

$matrixA=matrixB$ returns 1 if every comparison is true; it returns 0 if any comparison is false.

$matrixA\neq matrixB$ returns 1 if at least one comparison is false; it returns 0 if no comparison is false.

[A]	[[1 2 3] [3 2 1]]
[B]	[[3 2 1] [1 2 3]]

[A]=[B]	0
[A]≠[B]	1

iPart(, fPart(, int(

iPart((integer part), **fPart(** (fractional part), and **int(** (greatest integer) are on the **MATH NUM** menu.

iPart(returns a matrix containing the integer part of each element of *matrix*.

fPart(returns a matrix containing the fractional part of each element of *matrix*.

int(returns a matrix containing the greatest integer of each element of *matrix*.

iPart(*matrix*)

fPart(*matrix*)

int(*matrix*)

```
[D]  
[[1.25  3.333]  
 [100.5 47.15]]
```

```
iPart([D])  
[[1  3 ]  
 [100 47]]  
fPart([D])  
[[.25 .333]  
 [.5  .15 ]]
```

Using the MATRX MATH Operations

MATRX MATH Menu

To display the **MATRX MATH** menu, press **2nd** **MATRX** **▸**.

NAMES	MATH	EDIT
1: det (Calculates the determinant.
2: T		Transposes the matrix.
3: dim (Returns the matrix dimensions.
4: Fill (Fills all elements with a constant.
5: identity (Returns the identity matrix.
6: randM (Returns a random matrix.
7: augment (Appends two matrices.
8: Matr▶list (Stores a matrix to a list.

9:	List▶matr(Stores a list to a matrix.
0:	cumSum(Returns the cumulative sums of a matrix.
A:	ref(Returns the row-echelon form of a matrix.
B:	rref(Returns the reduced row-echelon form.
C:	rowSwap(Swaps two rows of a matrix.
D:	row+(Adds two rows; stores in the second row.
E:	*row(Multiplies the row by a number.
F:	*row+(Multiplies the row, adds to the second row.

det(

det((determinant) returns the determinant (a real number) of a square *matrix*.

det(matrix)

Transpose

T (transpose) returns a matrix in which each element (row, column) is swapped with the corresponding element (column, row) of *matrix*.

$matrix^T$

```
[A]
[[1 2 3]
 [3 2 1]]
```

```
[A]^T
[[1 3]
 [2 2]
 [3 1]]
```

Accessing Matrix Dimensions with dim(

dim((dimension) returns a list containing the dimensions (*{rows columns}*) of *matrix*.

dim(matrix)

Note: **dim(matrix)→Ln:Ln(1)** returns the number of rows. **dim(matrix)→Ln:Ln(2)** returns the number of columns.

```
dim([[2,7,1],[-8,
3,1]])
      {2 3}
```

```
dim([[2,7,1],[-8,
3,1]])→L1:L1(1)
      2
```

Creating a Matrix with dim(

Use **dim(** with **[STO▶]** to create a new *matrixname* of dimensions *rows* × *columns* with 0 as each element.

{rows,columns}→dim(matrixname)

```

(2,2)→dim([E])
      (2 2)
[E]
      [[0 0]
       [0 0]]

```

Redimensioning a Matrix with dim(

Use **dim(** with **STO▶** to redimension an existing *matrixname* to dimensions *rows* × *columns*. The elements in the old *matrixname* that are within the new dimensions are not changed. Additional created elements are zeros. Matrix elements that are outside the new dimensions are deleted.

{rows,columns}→dim(matrixname)

Fill(

Fill(stores *value* to every element in *matrixname*.

Fill(value,matrixname)

```

Fill(5,[E])
      Done
[E]
      [[5 5]
       [5 5]]

```

identity(

identity(returns the identity matrix of *dimension* *ROWS* × *dimension* *COLUMNS*.

identity(*dimension*)

randM(

randM(create random matrix) returns a *rows* × *columns* random matrix of integers ≥ -9 and ≤ 9 . The seed value stored to the **rand** function controls the values (Chapter 2).

randM(*rows,columns*)

```
0→rand:randM(2,2)
)
      [[0 -7]
      [8 8 1]]
```

augment(

augment(appends *matrixA* to *matrixB* as new columns. *matrixA* and *matrixB* both must have the same number of rows.

augment(*matrixA,matrixB*)

```
[[[1,2][3,4]]→[A]
: [[5,6][7,8]]→[B]
]:augment([A],[B]
)
      [[1 2 5 6]
      [3 4 7 8]]
```

Matr▶list(

Matr►list((matrix stored to list) fills each *listname* with elements from each column in *matrix*. **Matr►list**(ignores extra *listname* arguments. Likewise, **Matr►list**(ignores extra *matrix* columns.

Matr►list(*matrix,listnameA,...,listname n*)

[A] [[1 2 3] [4 5 6]] Matr►list([A],L1 ,L2,L3) Done	→	L1 L2 L3 (1 4) (2 5) (3 6)
--	---	---

Matr►list(also fills a *listname* with elements from a specified *column#* in *matrix*. To fill a list with a specific column from *matrix*, you must enter *column#* after *matrix*.

Matr►list(*matrix,column#,listname*)

[A] [[1 2 3] [4 5 6]] Matr►list([A],3, L1) Done	→	L1 (3 6)
--	---	-------------

List►matr(

List►matr((lists stored to matrix) fills *matrixname* column by column with the elements from each *list*. If dimensions of all *lists* are not equal, **List►matr**(fills each extra *matrixname* row with 0. Complex lists are not valid.

ListMatr(*listA*,...,*list n*,*matrixname*)

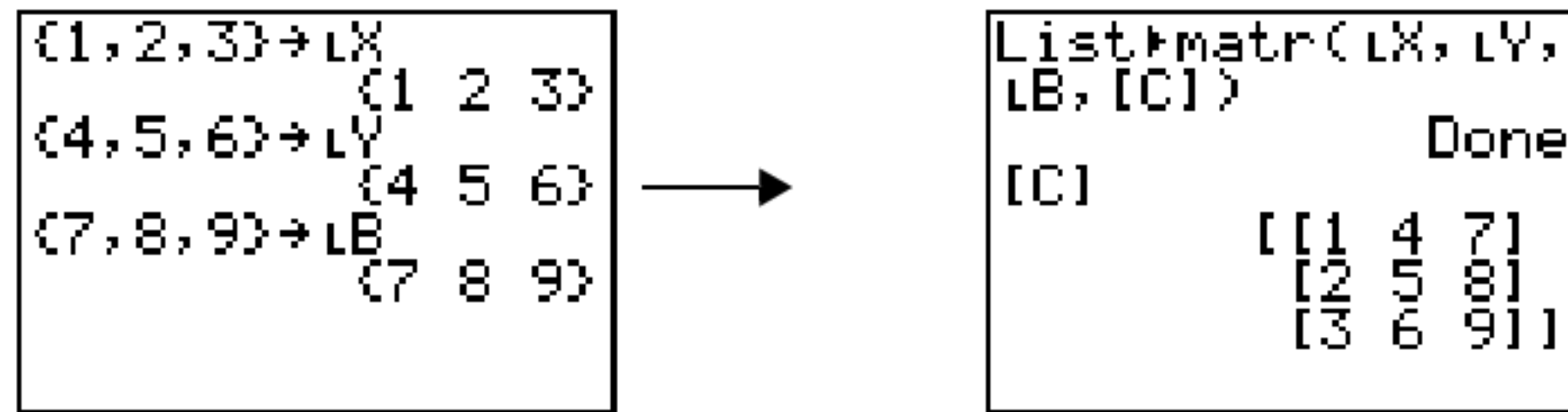

cumSum(

cumSum(returns cumulative sums of the elements in *matrix*, starting with the first element. Each element is the cumulative sum of the column from top to bottom.

cumSum(*matrix*)



Row Operations

MATRIX MATH menu items **A** through **F** are row operations. You can use a row operation in an expression. Row operations do not change *matrix* in memory. You can enter all row numbers and values as expressions. You can select the matrix from the **MATRIX NAMES** menu.

ref(), rref()

ref() (row-echelon form) returns the row-echelon form of a real *matrix*. The number of columns must be greater than or equal to the number of rows.

ref(matrix)

rref() (reduced row-echelon form) returns the reduced row-echelon form of a real *matrix*. The number of columns must be greater than or equal to the number of rows.

rref(matrix)

```
[B]
  [[4 5 6]
   [7 8 9]]
```

```
ref([B])
[[1 1.142857143...
 [0 1 ...
rref([B])
  [[1 0 -1]
   [0 1 2]]
```

rowSwap()

rowSwap() returns a matrix. It swaps *rowA* and *rowB* of *matrix*.

rowSwap(matrix,rowA,rowB)

```
[F]
  [[2 3 6 9]
   [5 8 4 7]
   [6 0 1 8]
   [2 0 4 7]]
```

```
rowSwap([F],2,4)
  [[2 3 6 9]
   [6 0 1 8]
   [5 8 4 7]
   [2 0 4 7]]
```

row+(

row+((row addition) returns a matrix. It adds *rowA* and *rowB* of *matrix* and stores the results in *rowB*.

row+(matrix,rowA,rowB)

```
[[[2, 5, 7] [8, 9, 4]]  
→ [0]  
   [[2 5 7]  
   [8 9 4]]
```

```
row+([0],1,2)  
   [[2 5 7]  
   [10 14 11]]
```

*row(

***row(** (row multiplication) returns a matrix. It multiplies *row* of *matrix* by *value* and stores the results in *row*.

***row(value,matrix,row)**

*row+(

***row+(** (row multiplication and addition) returns a matrix. It multiplies *rowA* of *matrix* by *value*, adds it to *rowB*, and stores the results in *rowB*.

***row+(value,matrix,rowA,rowB)**

```
[ [1, 2, 3] [4, 5, 6] ]  
→ [E]  
    [ [1 2 3]  
      [4 5 6] ]
```

```
*row+(3, [E], 1, 2)  
    [ [1 2 3 ]  
      [7 11 15] ]
```

Chapter 11: Lists

Getting Started: Generating a Sequence

Getting Started is a fast-paced introduction. Read the chapter for details.

Calculate the first eight terms of the sequence $1/A^2$. Store the results to a user-created list. Then display the results in fraction form. Begin this example on a blank line on the home screen.

1. Press $\boxed{2nd} \boxed{[LIST]} \boxed{\blacktriangleright}$ to display the **LIST OPS** menu.

```
NAMES  $\boxed{0/23}$  MATH
1:SortA(
2:SortD(
3:dim(
4:Fill(
5:seq(
6:cumSum(
7: $\blacktriangledown$ List(
```

2. Press **5** to select **5:seq(**, which pastes **seq(** to the current cursor location.

```
seq(1/A2,A,1,8,1
) $\rightarrow$ SEQ1
```

3. Press **1** $\boxed{\div}$ $\boxed{[ALPHA]} \boxed{[A]} \boxed{x^2}$ $\boxed{,}$ $\boxed{[ALPHA]} \boxed{[A]} \boxed{,}$ **1** $\boxed{,}$ **8** $\boxed{,}$ **1** $\boxed{)}$ $\boxed{[ENTER]}$ to enter the sequence.

4. Press $\boxed{[STO\blacktriangleright]}$, and then press $\boxed{2nd} \boxed{[ALPHA]}$ to turn on alpha-lock. Press $\boxed{[S]} \boxed{[E]} \boxed{[Q]}$, and then press $\boxed{[ALPHA]}$ to turn off alpha-lock. Press **1** to complete the list name.

5. Press **ENTER** to generate the list and store it in **SEQ1**. The list is displayed on the home screen. An ellipsis (...) indicates that the list continues beyond the viewing window. Press **▶** repeatedly (or press and hold **▶**) to scroll the list and view all the list elements.

```
seq(1/A^2,A,1,8,1
)→SEQ1
(1 .25 .1111111...
█
```

6. Press **2nd** **[LIST]** to display the **LIST NAMES** menu. Press **7** to select **7:seq(** to paste **LSEQ1** to the current cursor location. (If **SEQ1** is not item 7 on your **LIST NAMES** menu, move the cursor to **SEQ1** before you press **ENTER**.)

```
LIST OPS MATH
1:L1
2:L2
3:L3
4:L4
5:L5
6:L6
7:SEQ1
```

7. Press **MATH** to display the **MATH** menu. Press **1** to select **1:▶Frac**, which pastes **▶Frac** to the current cursor location.

```
seq(1/A^2,A,1,8,1
)→SEQ1
(1 .25 .1111111...
LSEQ1▶Frac
(1 1/4 1/9 1/16...
█
```

8. Press **ENTER** to show the sequence in fraction form. Press **▶** repeatedly (or press and hold **▶**) to scroll the list and view all the list elements.

Naming Lists

Using TI-84 Plus List Names L1 through L6

The TI-84 Plus has six list names in memory: **L1**, **L2**, **L3**, **L4**, **L5**, and **L6**. The list names **L1** through **L6** are on the keyboard above the numeric keys **1** through **6**. To paste one of these names to a valid screen, press **2nd**, and then press the appropriate key. **L1** through **L6** are stored in stat list editor columns **1** through **6** when you reset memory.

Creating a List Name on the Home Screen

To create a list name on the home screen, follow these steps.

1. Press $\boxed{2\text{nd}} \boxed{[]}$, enter one or more list elements, and then press $\boxed{2\text{nd}} \boxed{[]}$. Separate list elements with commas. List elements can be real numbers, complex numbers, or expressions.

```
{1,2,3,4}
```

2. Press $\boxed{\text{STO}\blacktriangleright}$.
3. Press $\boxed{\text{ALPHA}}$ [letter from A to Z or θ] to enter the first letter of the name.
4. Enter zero to four letters, θ , or numbers to complete the name.

```
{1,2,3,4}→TEST
```

5. Press $\boxed{\text{ENTER}}$. The list is displayed on the next line. The list name and its elements are stored in memory. The list name becomes an item on the **LIST NAMES** menu.

```
{1,2,3,4}→TEST  
  {1 2 3 4}
```

```
NAME OPS MATH  
1:SEQ1  
2:T123  
3:TEST
```

Note: If you want to view a user-created list in the stat list editor, you must store it in the stat list editor (Chapter 12).

You also can create a list name in these four places.

- At the **Name=** prompt in the stat list editor

- At an **Xlist:**, **Ylist:**, or **Data List:** prompt in the stat plot editor
- At a **List:**, **List1:**, **List2:**, **Freq:**, **Freq1:**, **Freq2:**, **XList:**, or **YList:** prompt in the inferential stat editors
- On the home screen using **SetUpEditor**

You can create as many list names as your TI-84 Plus memory has space to store.

Storing and Displaying Lists

Storing Elements to a List

You can store list elements in either of two ways.

- Use braces and $\boxed{\text{STO}} \blacktriangleright$ on the home screen.

```
(4+2i,5-3i)→L6
(4+2i 5-3i)
```

- Use the stat list editor (Chapter 12).

The maximum dimension of a list is 999 elements.

Note: When you store a complex number to a list, the entire list is converted to a list of complex numbers. To convert the list to a list of real numbers, display the home screen, and then enter **real(listname)**→*listname*.

Displaying a List on the Home Screen

To display the elements of a list on the home screen, enter the name of the list (preceded by `L`, if necessary, and then press `ENTER`). An ellipsis indicates that the list continues beyond the viewing window. Press `▸` repeatedly (or press and hold `▸`) to scroll the list and view all the list elements.

```
L1  
  (2 5 10)  
LDATA  
(2.154 50.47 9...
```

Copying One List to Another

To copy a list, store it to another list.

```
LTEST  
  (1 2 3 4)  
LTEST→TEST2  
  (1 2 3 4)
```

Accessing a List Element

You can store a value to or recall a value from a specific list *element*. You can store to any element within the current list dimension or one element beyond.

listname(*element*)

{1,2,3}→L ₃	{1 2 3}
4→L ₃ (4):L ₃	{1 2 3 4}
L ₃ (2)	2

Deleting a List from Memory

To delete lists from memory, including **L1** through **L6**, use the **MEMORY MANAGEMENT/DELETE** secondary menu (Chapter 18). Resetting memory restores **L1** through **L6**. Removing a list from the stat list editor does not delete it from memory.

Using Lists in Graphing

You can use lists to graph a family of curves (Chapter 3).

Entering List Names

Using the LIST NAMES Menu

To display the **LIST NAMES** menu, press $\boxed{2nd}$ [LIST]. Each item is a user-created list name except for **L1** through **L6**. **LIST NAMES** menu items are sorted automatically in alphanumerical order. Only the first 10 items are labeled, using 1 through 9, then 0. To jump to the first list name that begins with a particular alpha character or θ , press \boxed{ALPHA} [letter from A to Z or θ].

```
LIST NAMES OPS MATH
1: SEQ1
2: TEST
```

Note: From the top of a menu, press \blacktriangle to move to the bottom. From the bottom, press \blacktriangledown to move to the top.

When you select a list name from the **LIST NAMES** menu, the list name is pasted to the current cursor location.

- The list name symbol **L** precedes a list name when the name is pasted where non-list name data also is valid, such as the home screen.

```
LTEST
{1 2 3 4}
```

- The **L** symbol does not precede a list name when the name is pasted where a list name is the only valid input, such as the stat list editor's **Name=** prompt or the stat plot editor's **XList:** and **YList:** prompts.

Entering a User-Created List Name Directly

To enter an existing list name directly, follow these steps.

1. Press 2nd [LIST] \blacktriangleright to display the **LIST OPS** menu.

2. Select **B:L**, which pastes **L** to the current cursor location. **L** is not always necessary.

```
NAMES B:L MATH
6: cumSum(
7: ΔList(
8: Select(
9: augment(
0: List▶matr(
A: Matr▶list(
B:L
```

Note: You also can paste **L** to the current cursor location from the **CATALOG**.

3. Enter the characters that comprise the list name.

```
LT123
```

Attaching Formulas to List Names

Attaching a Formula to a List Name

You can attach a formula to a list name so that each list element is a result of the formula. When executed, the attached formula must resolve to a list.

When anything in the attached formula changes, the list to which the formula is attached is updated automatically.

- When you edit an element of a list that is referenced in the formula, the corresponding element in the list to which the formula is attached is updated.
- When you edit the formula itself, all elements in the list to which the formula is attached are updated.

For example, the first screen below shows that elements are stored to **L3**, and the formula **L3+10** is attached to the list name **LADD10**. The quotation marks designate the formula to be attached to **LADD10**. Each element of **LADD10** is the sum of an element in **L3** and 10.

```
{1,2,3}→L3
      {1 2 3}
"L3+10"→LADD10
L3+10
LADD10
      {11 12 13}
```

The next screen shows another list, **L4**. The elements of **L4** are the sum of the same formula that is attached to **L3**. However, quotation marks are not entered, so the formula is not attached to **L4**.

On the next line, **-6→L3(1):L3** changes the first element in **L3** to **-6**, and then redisplay **L3**.

```
L3+10→L4
      {11 12 13}
-6→L3(1):L3
      {-6 2 3}
```

The last screen shows that editing **L3** updated **LADD10**, but did not change **L4**. This is because the formula **L3+10** is attached to **LADD10**, but it is not attached to **L4**.

```
LADD10
      {4 12 13}
L4
      {11 12 13}
```

Note: To view a formula that is attached to a list name, use the stat list editor (Chapter 12).

Attaching a Formula to a List on the Home Screen or in a Program

To attach a formula to a list name from a blank line on the home screen or from a program, follow these steps.

1. Press $\boxed{\text{ALPHA}}$ $\boxed{[']}$, enter the formula (which must resolve to a list), and press $\boxed{\text{ALPHA}}$ $\boxed{[']}$ again.

Note: When you include more than one list name in a formula, each list must have the same dimension.

2. Press $\boxed{\text{STO}}\blacktriangleright$.
3. Enter the name of the list to which you want to attach the formula.
 - Press $\boxed{2\text{nd}}$, and then enter a TI-84 Plus list name **L1** through **L6**.
 - Press $\boxed{2\text{nd}}$ $\boxed{\text{LIST}}$ and select a user-created list name from the **LIST NAMES** menu.
 - Enter a user-created list name directly using **L**.
4. Press $\boxed{\text{ENTER}}$.

```
(4,8,9)→L1      {4 8 9}
"5*L1"→LLIST
5*L1
LLIST           {20 40 45}
```

Note: The stat list editor displays a formula-lock symbol next to each list name that has an attached formula. Chapter 12 describes how to use the stat list editor to attach formulas to lists, edit attached formulas, and detach formulas from lists.

Detaching a Formula from a List

You can detach (clear) an attached formula from a list in several ways.

For example:

- Enter "" → *listname* on the home screen.
- Edit any element of a list to which a formula is attached.
- Use the stat list editor (Chapter 12).
- Use **ClrList** or **ClrAllList** to detach a formula from a list (Chapter 18).

Using Lists in Expressions

Using a List in an Expression

You can use lists in an expression in any of three ways. When you press **ENTER**, any expression is evaluated for each list element, and a list is displayed.

- Use **L1–L6** or any user-created list name in an expression.

```
{2,5,10}→L1
20/L1
{10 4 2}
```

- Enter the list elements directly.

```
20/{2,5,10}
{10 4 2}
```

- Use $\boxed{2\text{nd}} \boxed{\text{RCL}}$ to recall the contents of the list into an expression at the cursor location (Chapter 1).

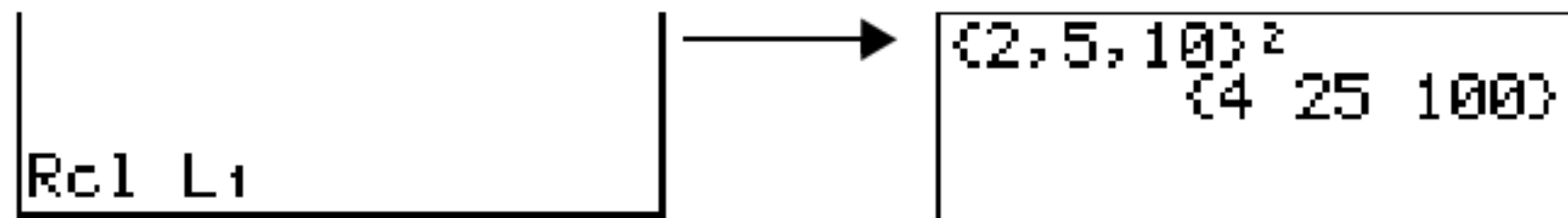

Note: You must paste user-created list names to the **Rcl** prompt by selecting them from the **LIST NAMES** menu. You cannot enter them directly using **L**.

Using Lists with Math Functions

You can use a list to input several values for some math functions. Other chapters and Appendix A specify whether a list is valid. The function is evaluated for each list element, and a list is displayed.

- When you use a list with a function, the function must be valid for every element in the list. In graphing, an invalid element, such as -1 in $\sqrt{\{1, 0, -1\}}$, is ignored.

$\boxed{\sqrt{\{1, 0, -1\}}}$

This returns an error.

$\boxed{\begin{array}{l} \text{Plot1 Plot2 Plot3} \\ \sqrt{X} \sqrt{\{1, 0, -1\}} \end{array}}$

This graphs $X \cdot \sqrt{1}$ and $X \cdot \sqrt{0}$, but skips $X \cdot \sqrt{-1}$.

- When you use two lists with a two-argument function, the dimension of each list must be the same. The function is evaluated for corresponding elements.

$\boxed{\{1, 2, 3\} + \{4, 5, 6\}}$
 $\{5 \ 7 \ 9\}$

- When you use a list and a value with a two-argument function, the value is used with each element in the list.

```
(1,2,3)+4  
(5 6 7)
```

LIST OPS Menu

LIST OPS Menu

To display the **LIST OPS** menu, press `2nd` `[LIST]` `▶`.

NAMES OPS MATH

1:	SortA (Sorts lists in ascending order.
2:	SortD (Sorts lists in descending order.
3:	dim (Sets the list dimension.
4:	Fill (Fills all elements with a constant.
5:	seq (Creates a sequence.
6:	cumSum (Returns a list of cumulative sums.
7:	ΔList (Returns difference of successive elements.

8: `Select (` Selects specific data points.
 9: `augment (` Concatenates two lists.
 0: `List▶matr (` Stores a list to a matrix.
 A: `Matr▶list (` Stores a matrix to a list.
 B: `L` Designates the list-name data type.

SortA(, SortD(

SortA((sort ascending) sorts list elements from low to high values. **SortD(** (sort descending) sorts list elements from high to low values. Complex lists are sorted based on magnitude (modulus).

With one list, **SortA(** and **SortD(** sort the elements of *listname* and update the list in memory.

SortA(listname)

SortD(listname)

```
(5,6,4)→L3
SortA(L3)
L3
```

{5 6 4}
Done
{4 5 6}

```
SortD(L3)
L3
```

Done
{6 5 4}

With two or more lists, **SortA(** and **SortD(** sort *keylistname*, and then sort each *dependlist* by placing its elements in the same order as the corresponding elements in *keylistname*. All lists must have the same dimension.

SortA(keylistname,dependlist1[,dependlist2,...,dependlist n])

SortD(keylistname,dependlist1[,dependlist2,...,dependlist n])

```
{5,6,4}→L4  
{5 6 4}  
{1,2,3}→L5  
{1 2 3}
```

```
SortA(L4,L5)  
Done  
L4 {4 5 6}  
L5 {3 1 2}
```

Note:

- In the example, 5 is the first element in **L4**, and 1 is the first element in **L5**. After **SortA(L4,L5)**, 5 becomes the second element of **L4**, and likewise, 1 becomes the second element of **L5**.
- **SortA**(and **SortD**(are the same as **SortA**(and **SortD**(on the **STAT EDIT** menu (Chapter 12).

Using dim(to Find List Dimensions

dim((dimension) returns the length (number of elements) of *list*.

dim(*list*)

```
dim({1,3,5,7})  
4
```

Using dim(to Create a List

You can use **dim(** with **STO▶** to create a new *listname* with dimension *length* from 1 to 999. The elements are zeros.

length→**dim(listname)**

```
3→dim(L2)
L2
{0 0 0}
```

Using dim(to Redimension a List

You can use **dim** with **STO▶** to redimension an existing *listname* to dimension *length* from 1 to 999.

- The elements in the old *listname* that are within the new dimension are not changed.
- Extra list elements are filled by 0.
- Elements in the old list that are outside the new dimension are deleted.

length→**dim(listname)**

```
{4,8,6}→L1
4→dim(L1)
L1
{4 8 6 0}
```

```
3→dim(L1)
L1
{4 8 6}
```

Fill(

Fill(replaces each element in *listname* with *value*.

Fill(value,listname)

<pre>{3,4,5}→L3 Fill(8,L3) L3 {8 8 8}</pre>	<pre>Fill(4+3i,L3) L3 {4+3i 4+3i 4+3i}</pre>
---	--

Note: **dim(** and **Fill(** are the same as **dim(** and **Fill(** on the **MATRX MATH** menu (Chapter 10).

seq(

seq((sequence) returns a list in which each element is the result of the evaluation of *expression* with regard to *variable* for the values ranging from *begin* to *end* at steps of *increment*. *variable* need not be defined in memory. *increment* can be negative; the default value for *increment* is 1. **seq(** is not valid within *expression*. Complex lists are not valid.

seq(expression,variable,begin,end[,increment])

<pre>seq(A^2,A,1,11,3) {1 16 49 100}</pre>
--

cumSum(

cumSum((cumulative sum) returns the cumulative sums of the elements in *list*, starting with the first element. *list* elements can be real or complex numbers.

cumSum(list)

```
cumSum({1,2,3,4,5})
{1 3 6 10 15}
```

ΔList(

ΔList(returns a list containing the differences between consecutive elements in *list*. **ΔList** subtracts the first element in *list* from the second element, subtracts the second element from the third, and so on. The list of differences is always one element shorter than the original *list*. *list* elements can be a real or complex numbers.

ΔList(list)

```
{20,30,45,70}→L0
LIST
{20 30 45 70}
ΔList(L0LIST)
{10 15 25}
```

Select(

Select(selects one or more specific data points from a scatter plot or xyLine plot (only), and then stores the selected data points to two new lists, *xlistname* and *ylistname*. For



example, you can use **Select**(to select and then analyze a portion of plotted CBL 2™/CBL™ or CBR™ data.

Select(*xlistname*,*ylistname*)

Note: Before you use **Select**(, you must have selected (turned on) a scatter plot or xyLine plot. Also, the plot must be displayed in the current viewing window.

Before Using Select(

Before using **Select**(, follow these steps.

1. Create two list names and enter the data.
2. Turn on a stat plot, select  (scatter plot) or  (xyLine), and enter the two list names for **Xlist:** and **Ylist:** (Chapter 12).
3. Use **ZoomStat** to plot the data (Chapter 3).

```
{1,2,3,4,5,6,7,8  
,9,9.5,10}→DIST  
{1,2,3,4,5,6,7...  
{15,15,15,13,11,  
9,7,5,3,2,2}→TIME  
[2nd][LIST]→  
{15,15,15,13,11...
```

```
Plot1 Plot2 Plot3  
Off Off  
Type: [ ] [ ] [ ]  
MH: MH  
Xlist: DIST  
Ylist: TIME  
Mark: [ ] + .
```

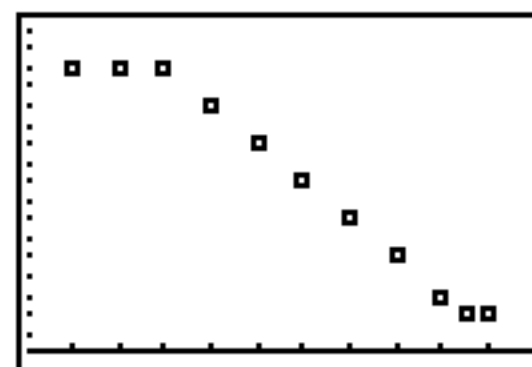

Using Select(to Select Data Points from a Plot

To select data points from a scatter plot or xyLine plot, follow these steps.

1. Press **[2nd]** **[LIST]** **[>]** **8** to select **8:Select**(from the **LIST OPS** menu. **Select**(is pasted to the home screen.

2. Enter *xlistname*, press `[,]`, enter *ylistname*, and then press `[)]` to designate list names into which you want the selected data to be stored.

```
Select(L1,L2)■
```

3. Press `[ENTER]`. The graph screen is displayed with `Left Bound?` in the bottom-left corner.

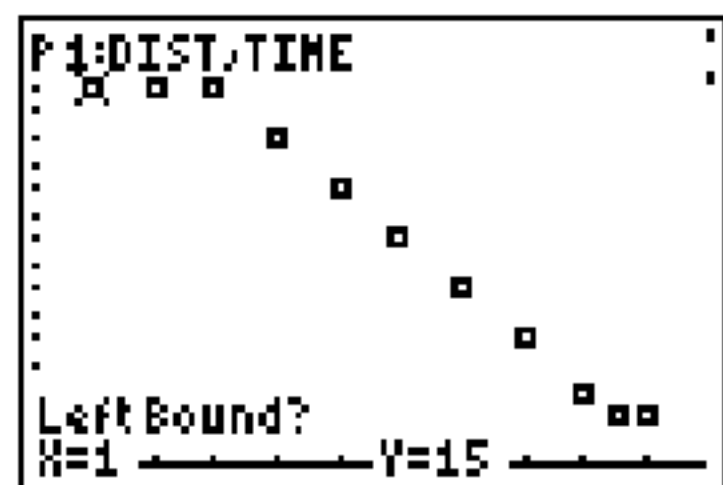

4. Press `[▲]` or `[▼]` (if more than one stat plot is selected) to move the cursor onto the stat plot from which you want to select data points.
5. Press `[◀]` and `[▶]` to move the cursor to the stat plot data point that you want as the left bound.

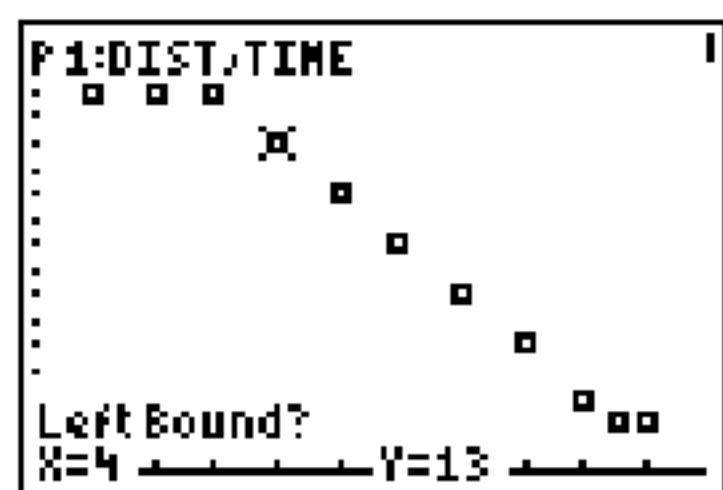

6. Press `[ENTER]`. A `▶` indicator on the graph screen shows the left bound. `Right Bound?` is displayed in the bottom-left corner.

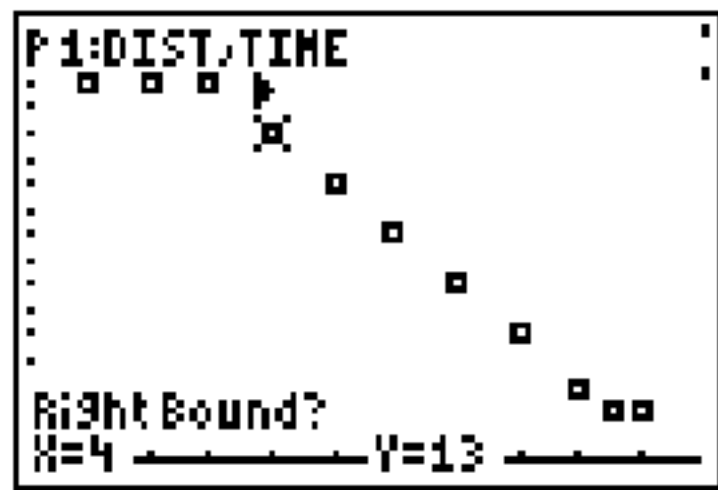

7. Press \leftarrow or \rightarrow to move the cursor to the stat plot point that you want for the right bound, and then press ENTER .

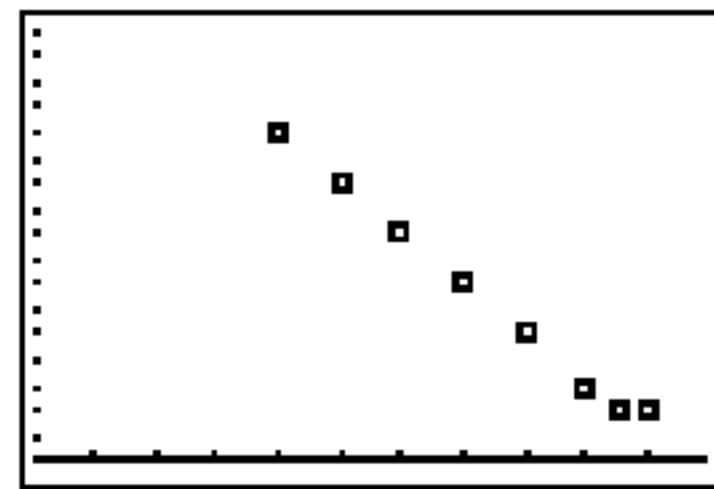
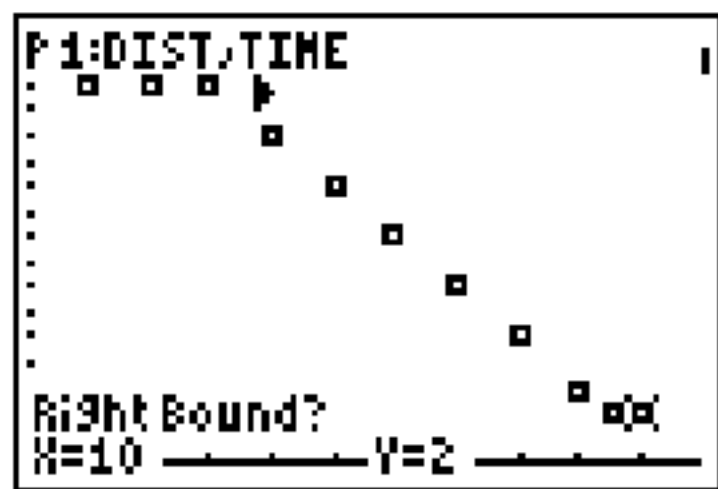

The x-values and y-values of the selected points are stored in *xlistname* and *ylistname*. A new stat plot of *xlistname* and *ylistname* replaces the stat plot from which you selected data points. The list names are updated in the stat plot editor.

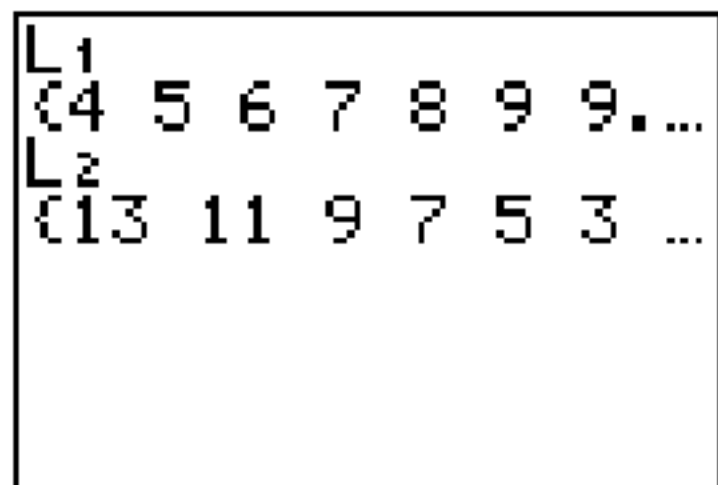

Note: The two new lists (*xlistname* and *ylistname*) will include the points you select as left bound and right bound. Also, *left-bound x-value* \leq *right-bound x-value* must be true.

augment(

augment(concatenates the elements of *listA* and *listB*. The list elements can be real or complex numbers.

augment(listA,listB)

```
{1,17,21}→L3
      {1 17 21}
augment(L3,{25,30,41})
{1 17 21 25 30 ...}
```

List▶matr(

List▶matr((lists stored to matrix) fills *matrixname* column by column with the elements from each list. If the dimensions of all lists are not equal, then **List▶matr(** fills each extra *matrixname* row with 0. Complex lists are not valid.

List▶matr(list1,list2, ... ,list n,matrixname)

```
{1,2,3}→LX
      {1 2 3}
{4,5,6}→LY
      {4 5 6}
{7,8,9}→LB
      {7 8 9}
→
List▶matr(LX,LY,
LB,[C])
      Done
[C]
      [[1 4 7]
       [2 5 8]
       [3 6 9]]
```

Matr▶list(

Matr▶list((matrix stored to lists) fills each *listname* with elements from each column in *matrix*. If the number of *listname* arguments exceeds the number of columns in *matrix*, then **Matr▶list**(ignores extra *listname* arguments. Likewise, if the number of columns in *matrix* exceeds the number of *listname* arguments, then **Matr▶list**(ignores extra *matrix* columns.

Matr▶list(*matrix*,*listname*1,*listname*2, . . . ,*listname* n)

<pre>[A] [[1 2 3] [4 5 6]] Matr▶list([A],L1 ,L2,L3) Done</pre>	→	<pre>L1 (1 4) L2 (2 5) L3 (3 6)</pre>
---	---	--

Matr▶list(also fills a *listname* with elements from a specified *column#* in *matrix*. To fill a list with a specific column from *matrix*, you must enter a *column#* after *matrix*.

Matr▶list(*matrix*,*column#*,*listname*)

<pre>[A] [[1 2 3] [4 5 6]] Matr▶list([A],3, L1) Done</pre>	→	<pre>L1 (3 6)</pre>
---	---	--------------------------

L preceding one to five characters identifies those characters as a user-created *listname*. *listname* may comprise letters, θ, and numbers, but it must begin with a letter from A to Z or θ.

L*listname*

Generally, **L** must precede a user-created list name when you enter a user-created list name where other input is valid, for example, on the home screen. Without the **L**, the TI-84 Plus may misinterpret a user-created list name as implied multiplication of two or more characters.

L need not precede a user-created list name where a list name is the only valid input, for example, at the **Name=** prompt in the stat list editor or the **Xlist:** and **Ylist:** prompts in the stat plot editor. If you enter **L** where it is not necessary, the TI-84 Plus will ignore the entry.

LIST MATH Menu

LIST MATH Menu

To display the **LIST MATH** menu, press **2nd** [LIST] **◀**.

NAMES OPS MATH

- | | | |
|----|------------------------|---------------------------------------|
| 1: | <code>min(</code> | Returns minimum element of a list. |
| 2: | <code>max(</code> | Returns maximum element of a list. |
| 3: | <code>mean(</code> | Returns mean of a list. |
| 4: | <code>median(</code> | Returns median of a list. |
| 5: | <code>sum(</code> | Returns sum of elements in a list. |
| 6: | <code>prod(</code> | Returns product of elements in list. |
| 7: | <code>stdDev(</code> | Returns standard deviation of a list. |
| 8: | <code>variance(</code> | Returns the variance of a list. |
-

min(, max(

min((minimum) and **max(** (maximum) return the smallest or largest element of *listA*. If two lists are compared, it returns a list of the smaller or larger of each pair of elements in *listA* and *listB*. For a complex list, the element with smallest or largest magnitude (modulus) is returned.

min(*listA*[,*listB*])

max(*listA*[,*listB*])

```
min({1,2,3},{3,2,1})
      {1 2 1}
max({1,2,3},{3,2,1})
      {3 2 3}
```

Note: **min(** and **max(** are the same as **min(** and **max(** on the **MATH NUM** menu.

mean(, median(

mean(returns the mean value of *list*. **median(** returns the median value of *list*. The default value for *freqlist* is 1. Each *freqlist* element counts the number of consecutive occurrences of the corresponding element in *list*. Complex lists are not valid.

mean(*list*[,*freqlist*])

median(*list*[,*freqlist*])

```
mean({1,2,3},{3,2,1})
      1.666666667
median({1,2,3})
      2
```

sum(, prod(

sum((summation) returns the sum of the elements in *list*. *start* and *end* are optional; they specify a range of elements. *list* elements can be real or complex numbers.

prod(returns the product of all elements of *list*. *start* and *end* elements are optional; they specify a range of list elements. *list* elements can be real or complex numbers.

sum(list[,start,end])

prod(list[,start,end])

L1	{1 2 5 8 10}
sum(L1)	
sum(L1,3,5)	26
	23

L1	{1 2 5 8 10}
prod(L1)	
prod(L1,3,5)	800
	400

Sums and Products of Numeric Sequences

You can combine **sum(** or **prod(** with **seq(** to obtain:

upper

upper

\sum *expression(x)*

\prod *expression(x)*

x=lower

x=lower

To evaluate $\sum 2^{(N-1)}$ from N=1 to 4:

```
sum(seq(2^(N-1),  
N, 1, 4, 1))  
15
```

stdDev(, variance(

stdDev(returns the standard deviation of the elements in *list*. The default value for *freqlist* is 1. Each *freqlist* element counts the number of consecutive occurrences of the corresponding element in *list*. Complex lists are not valid.

- **variance(** returns the variance of the elements in *list*. The default value for *freqlist* is 1. Each *freqlist* element counts the number of consecutive occurrences of the corresponding element in *list*. Complex lists are not valid.

stdDev(list[,freqlist])

```
stdDev({1, 2, 5, -6  
, 3, -2})  
3.937003937
```

variance(list[,freqlist])

```
variance({1, 2, 5,  
-6, 3, -2})  
15.5
```

Chapter 12: Statistics

Getting Started: Pendulum Lengths and Periods

Getting Started is a fast-paced introduction. Read the chapter for details.

A group of students is attempting to determine the mathematical relationship between the length of a pendulum and its period (one complete swing of a pendulum). The group makes a simple pendulum from string and washers and then suspends it from the ceiling. They record the pendulum's period for each of 12 string lengths.*

Length (cm)	Time (sec)	Length (cm)	Time (sec)
6.5	0.51	24.4	1.01
11.0	0.68	26.6	1.08
13.2	0.73	30.5	1.13
15.0	0.79	34.3	1.26
18.0	0.88	37.6	1.28
23.1	0.99	41.5	1.32

*This example is quoted and adapted from *Contemporary Precalculus Through Applications*, by the North Carolina School of Science and Mathematics, by permission of Janson Publications, Inc., Dedham, MA. 1-800-322-MATH. © 1992. All rights reserved.

1. Press **MODE** \blacktriangledown \blacktriangledown \blacktriangledown **ENTER** to set **Func** graphing mode.

- Press **[STAT]** **5** to select **5:SetUpEditor**. **SetUpEditor** is pasted to the home screen.

Press **[ENTER]**. This removes lists from stat list editor columns 1 through 20, and then stores lists **L1** through **L6** in columns 1 through 6.

Note: Removing lists from the stat list editor does not delete them from memory.

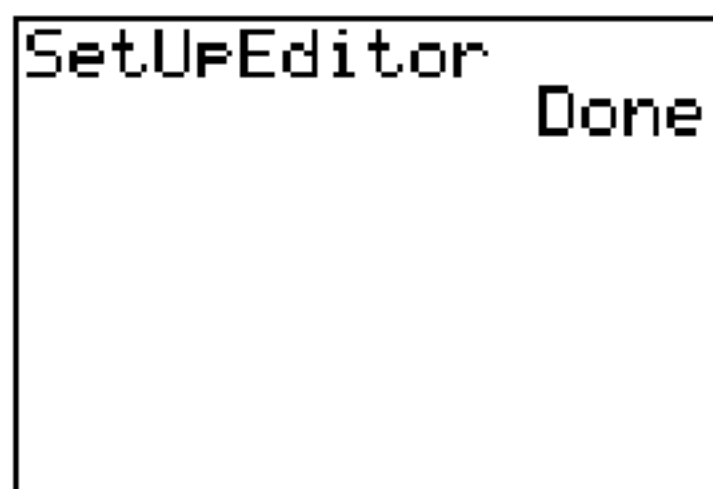

- Press **[STAT]** **1** to select **1:Edit** from the **STAT EDIT** menu. The stat list editor is displayed. If elements are stored in **L1** and **L2**, press **[↑]** to move the cursor onto **L1**, and then press **[CLEAR]** **[ENTER]** **[▶]** **[↑]** **[CLEAR]** **[ENTER]** to clear both lists. Press **[←]** to move the rectangular cursor back to the first row in **L1**.

L1	L2	L3	1
████████	-----	-----	
L1(1) =			

- Press **6** **[.]** **5** **[ENTER]** to store the first pendulum string length (6.5 cm) in **L1**. The rectangular cursor moves to the next row. Repeat this step to enter each of the 12 string length values in the table.

L1	L2	L3	1
24.4			
26.6			
30.5			
34.3			
37.6			
41.5			
████████			
L1(13) =			

- Press **[▶]** to move the rectangular cursor to the first row in **L2**.

Press **[.]** **51** **[ENTER]** to store the first time measurement (.51 sec) in **L2**. The rectangular cursor moves to the next row. Repeat this step to enter each of the 12 time values in the table.

L1	L2	L3	2
24.4	1.01		
26.6	1.08		
30.5	1.13		
34.3	1.26		
37.6	1.28		
41.5	1.32		
-----	████████		
L2(13) =			

6. Press $\boxed{Y=}$ to display the Y= editor.

If necessary, press $\boxed{\text{CLEAR}}$ to clear the function Y1. As necessary, press $\boxed{\uparrow}$, $\boxed{\text{ENTER}}$, and $\boxed{\rightarrow}$ to turn off **Plot1**, **Plot2**, and **Plot3** from the top line of the Y= editor (Chapter 3). As necessary, press $\boxed{\downarrow}$, $\boxed{\leftarrow}$, and $\boxed{\text{ENTER}}$ to deselect functions.

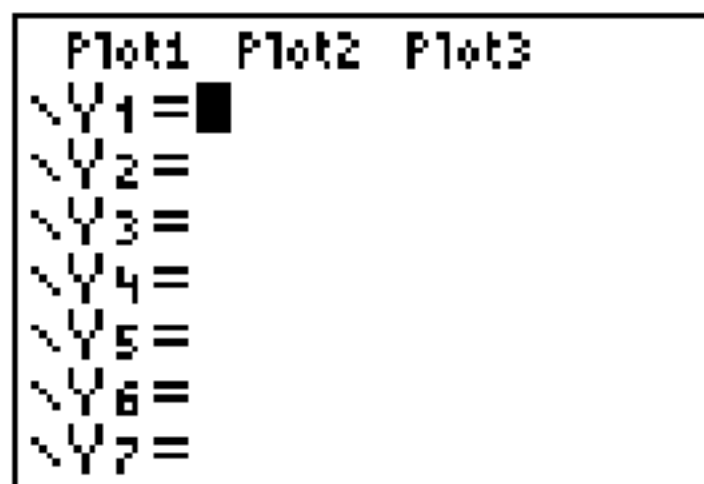

7. Press $\boxed{2\text{nd}} \boxed{\text{STAT PLOT}} \boxed{1}$ to select **1:Plot1** from the **STAT PLOTS** menu. The stat plot editor is displayed for plot 1.

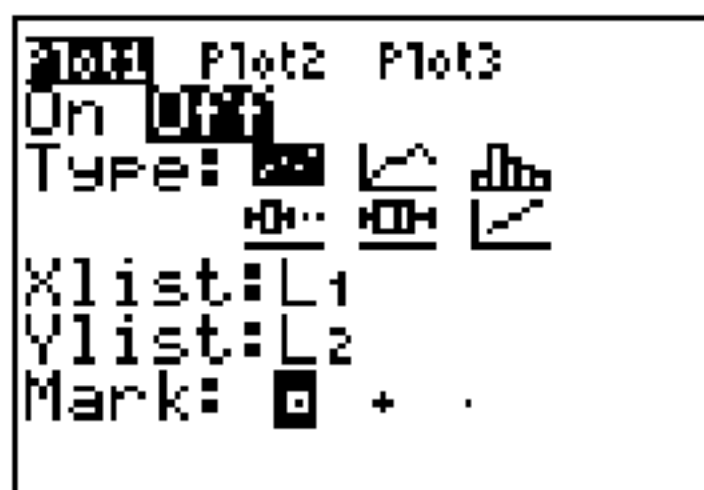

8. Press $\boxed{\text{ENTER}}$ to select **On**, which turns on plot 1. Press $\boxed{\downarrow} \boxed{\text{ENTER}}$ to select Scatter (scatter plot). Press $\boxed{\downarrow} \boxed{2\text{nd}} \boxed{\text{L1}}$ to specify **Xlist:L1** for plot 1. Press $\boxed{\downarrow} \boxed{2\text{nd}} \boxed{\text{L2}}$ to specify **Ylist:L2** for plot 1. Press $\boxed{\downarrow} \boxed{\rightarrow} \boxed{\text{ENTER}}$ to select **+** as the **Mark** for each data point on the scatter plot.

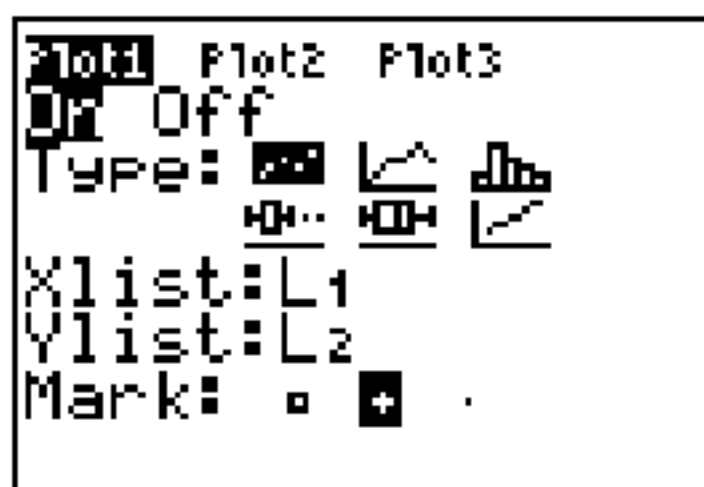

9. Press $\boxed{\text{ZOOM}} \boxed{9}$ to select **9:ZoomStat** from the **ZOOM** menu. The window variables are adjusted automatically, and plot 1 is displayed. This is a scatter plot of the time-versus-length data.

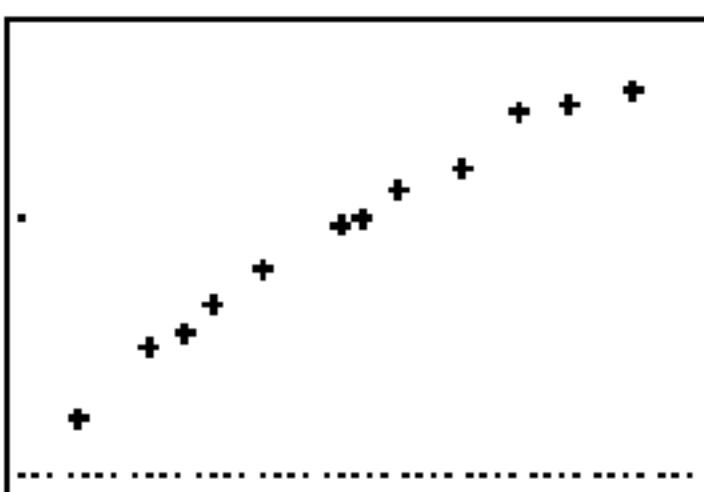

Since the scatter plot of time-versus-length data appears to be approximately linear, fit a line to the data.

10. Press **[STAT]** **[4]** to select **4:LinReg(ax+b)** (linear regression model) from the **STAT CALC** menu. **LinReg(ax+b)** is pasted to the home screen.

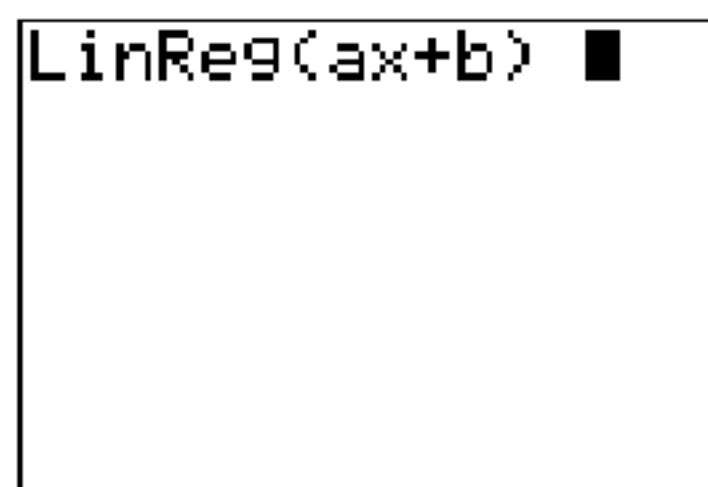

```
LinReg(ax+b) ■
```

11. Press **[2nd]** **[L1]** **[,]** **[2nd]** **[L2]** **[,]**. Press **[VARS]** **[1]** to display the **VAR Y-VARS FUNCTION** secondary menu, and then press **1** to select **1:Y1**. **L1**, **L2**, and **Y1** are pasted to the home screen as arguments to **LinReg(ax+b)**.

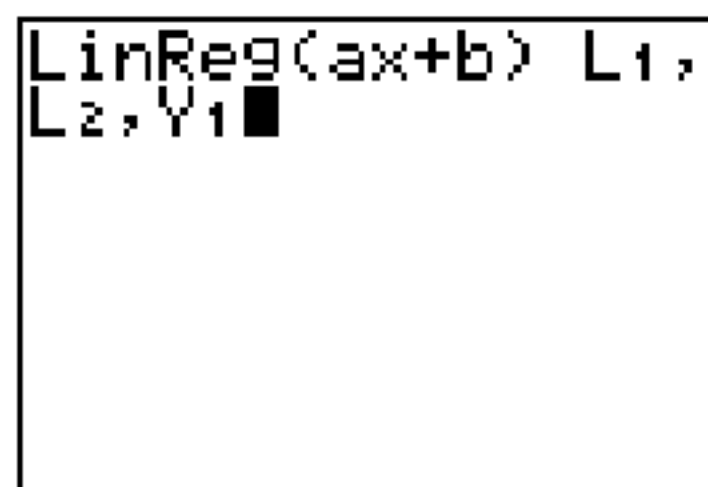

```
LinReg(ax+b) L1,  
L2,Y1 ■
```

12. Press **[ENTER]** to execute **LinReg(ax+b)**. The linear regression for the data in **L1** and **L2** is calculated. Values for **a** and **b** are displayed on the home screen. The linear regression equation is stored in **Y1**. Residuals are calculated and stored automatically in the list name **RESID**, which becomes an item on the **LIST NAMES** menu.

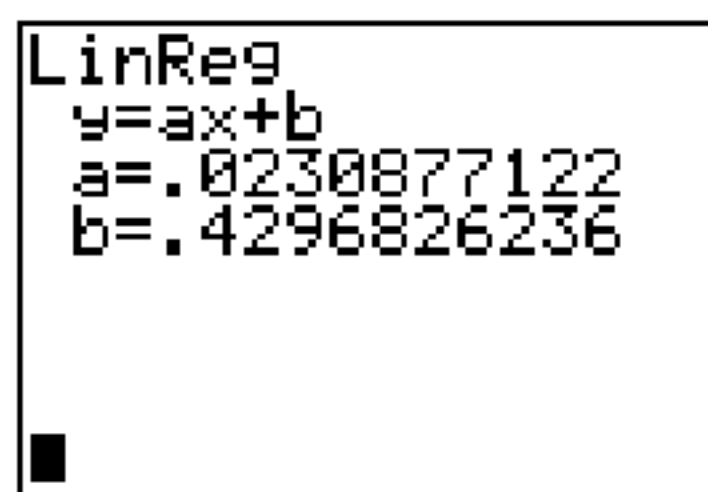

```
LinReg  
y=ax+b  
a=.0230877122  
b=.4296826236  
■
```

13. Press **[GRAPH]**. The regression line and the scatter plot are displayed.

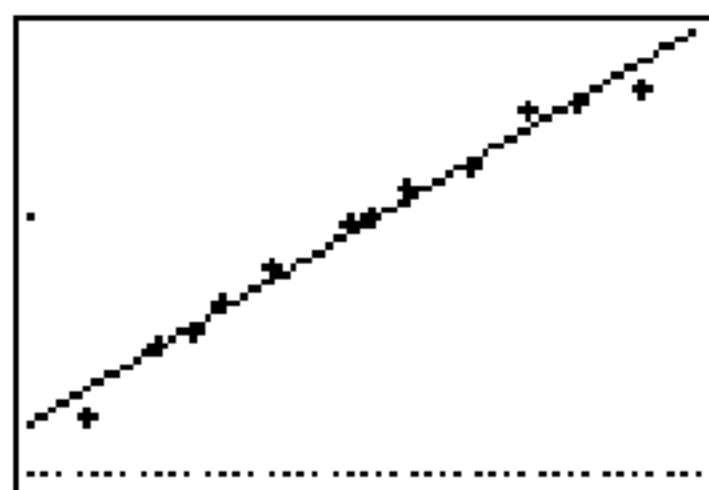

The regression line appears to fit the central portion of the scatter plot well. However, a residual plot may provide more information about this fit.

14. Press **[STAT]** **1** to select **1:Edit**. The stat list editor is displayed.

Press **[▶]** and **[▲]** to move the cursor onto **L3**.

Press **[2nd]** **[INS]**. An unnamed column is displayed in column 3; **L3**, **L4**, **L5**, and **L6** shift right one column. The **Name=** prompt is displayed in the entry line, and alpha-lock is on.

L1	L2	3
6.5	.51	
11	.68	
13.2	.73	
15	.79	
18	.88	
23.1	.99	
24.4	1.01	
Name=		

15. Press **[2nd]** **[LIST]** to display the **LIST NAMES** menu.

If necessary, press **[▼]** to move the cursor onto the list name **RESID**.

RESID	OPS	MATH
RESID		

16. Press **[ENTER]** to select **RESID** and paste it to the stat list editor's **Name=** prompt.

L1	L2	3
6.5	.51	
11	.68	
13.2	.73	
15	.79	
18	.88	
23.1	.99	
24.4	1.01	
Name=RESID		

17. Press **[ENTER]**. **RESID** is stored in column 3 of the stat list editor.

Press **[▼]** repeatedly to examine the residuals.

L1	L2	3
6.5	.51	-.0698
11	.68	-.0036
13.2	.73	-.0044
15	.79	.014
18	.88	.03474
23.1	.99	.02699
24.4	1.01	.01698
RESID = (-.0697527...		

Notice that the first three residuals are negative. They correspond to the shortest pendulum string lengths in **L1**. The next five residuals are positive, and three of the last four are negative. The latter correspond to the longer string lengths in **L1**. Plotting the residuals will show this pattern more clearly.

18. Press $\boxed{2nd}$ $\boxed{STAT PLOT}$ $\boxed{2}$ to select **2:Plot2** from the **STAT PLOTS** menu. The stat plot editor is displayed for plot 2.



19. Press \boxed{ENTER} to select **On**, which turns on plot 2. Press $\boxed{\downarrow}$ \boxed{ENTER} to select \square (scatter plot). Press $\boxed{\downarrow}$ $\boxed{2nd}$ $\boxed{L1}$ to specify **Xlist:L1** for plot 2. Press $\boxed{\downarrow}$ \boxed{R} \boxed{E} \boxed{S} \boxed{I} \boxed{D} (alpha-lock is on) to specify **Ylist:RESID** for plot 2. Press $\boxed{\downarrow}$ \boxed{ENTER} to select \square as the mark for each data point on the scatter plot.

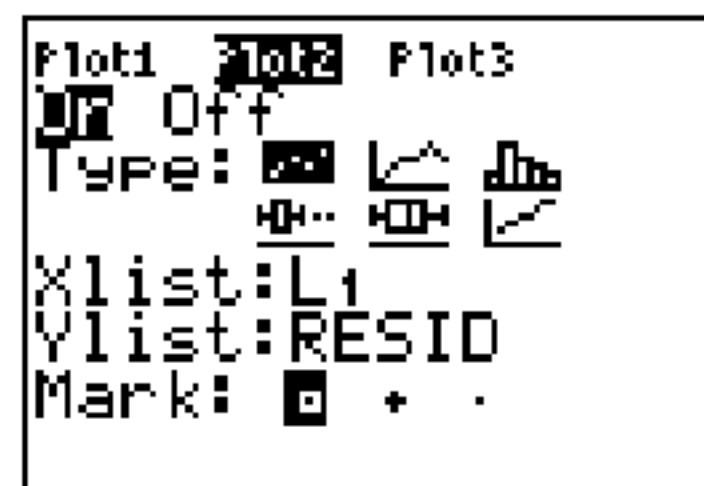

20. Press $\boxed{Y=}$ to display the Y= editor. Press $\boxed{\leftarrow}$ to move the cursor onto the = sign, and then press \boxed{ENTER} to deselect **Y1**. Press $\boxed{\uparrow}$ \boxed{ENTER} to turn off plot 1.

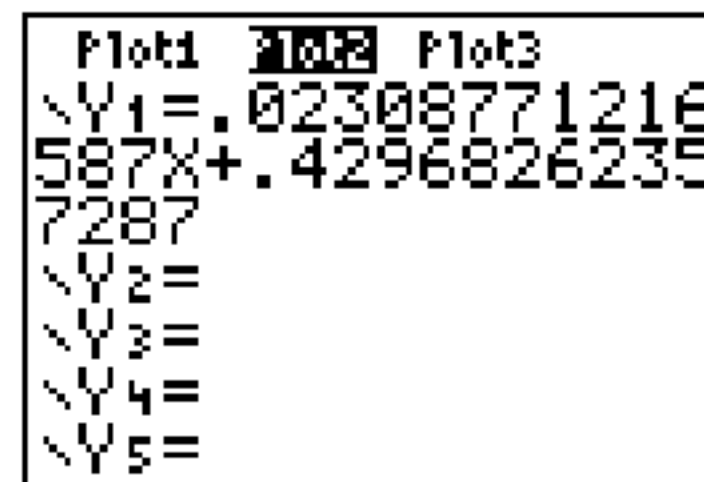

21. Press \boxed{ZOOM} $\boxed{9}$ to select **9:ZoomStat** from the **ZOOM** menu. The window variables are adjusted automatically, and plot 2 is displayed. This is a scatter plot of the residuals.

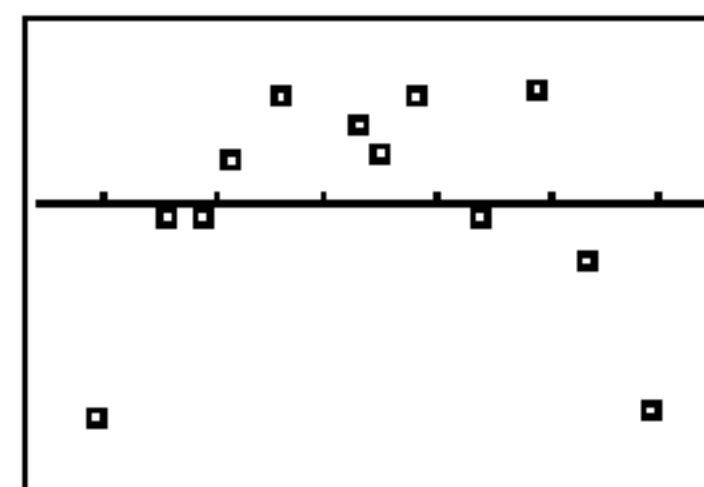

Notice the pattern of the residuals: a group of negative residuals, then a group of positive residuals, and then another group of negative residuals.

The residual pattern indicates a curvature associated with this data set for which the linear model did not account. The residual plot emphasizes a downward curvature, so a model that curves down with the data would be more accurate. Perhaps a function such as square root would fit. Try a power regression to fit a function of the form $y = a * x^b$.

22. Press $\boxed{Y=}$ to display the Y= editor.

Press \boxed{CLEAR} to clear the linear regression equation from **Y1**. Press $\boxed{\blacktriangle} \boxed{ENTER}$ to turn on plot 1. Press $\boxed{\blacktriangleright} \boxed{ENTER}$ to turn off plot 2.

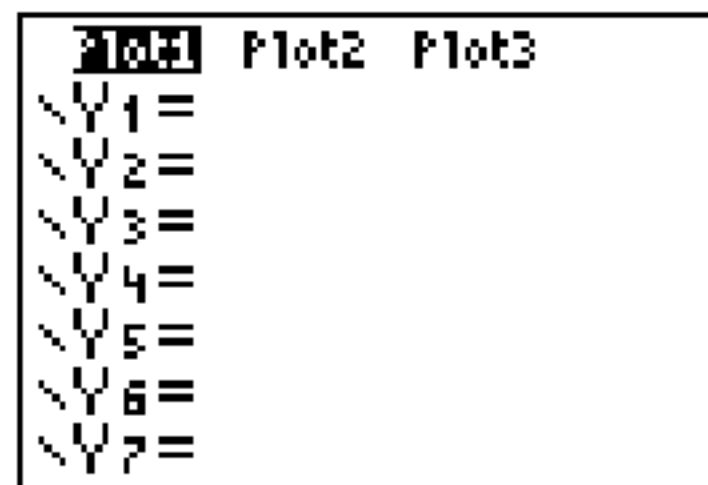

23. Press $\boxed{ZOOM} \boxed{9}$ to select **9:ZoomStat** from the **ZOOM** menu. The window variables are adjusted automatically, and the original scatter plot of time-versus-length data (plot 1) is displayed.

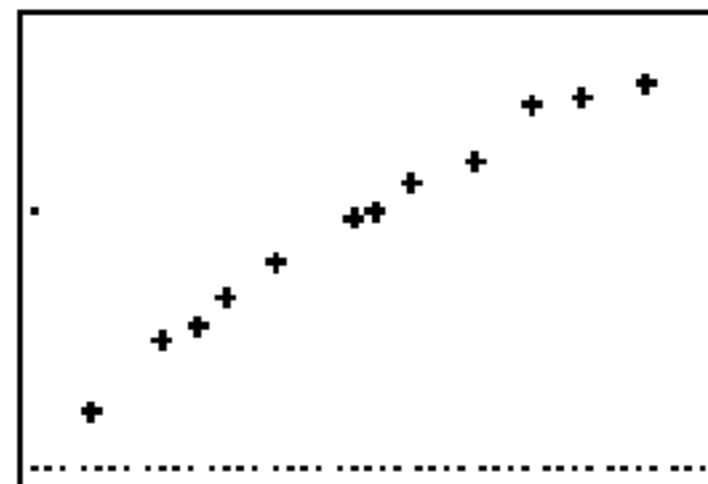

24. Press $\boxed{STAT} \boxed{\blacktriangleright} \boxed{ALPHA} \boxed{A}$ to select **A:PwrReg** from the **STAT CALC** menu. **PwrReg** is pasted to the home screen.

Press $\boxed{2nd} \boxed{[L1]} \boxed{,} \boxed{2nd} \boxed{[L2]} \boxed{,}$. Press $\boxed{VARS} \boxed{\blacktriangleright} \boxed{1}$ to display the **VARS Y-VARS FUNCTION** secondary menu, and then press **1** to select **1:Y1**. **L1**, **L2**, and **Y1** are pasted to the home screen as arguments to **PwrReg**.

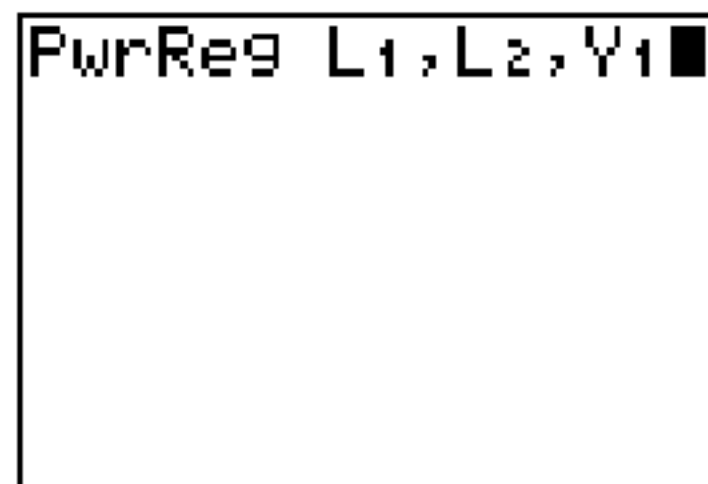

25. Press **ENTER** to calculate the power regression. Values for **a** and **b** are displayed on the home screen. The power regression equation is stored in **Y1**. Residuals are calculated and stored automatically in the list name **RESID**.

```
PwrReg
y=a*x^b
a=.1922828621
b=.5224982852
```

26. Press **GRAPH**. The regression line and the scatter plot are displayed.

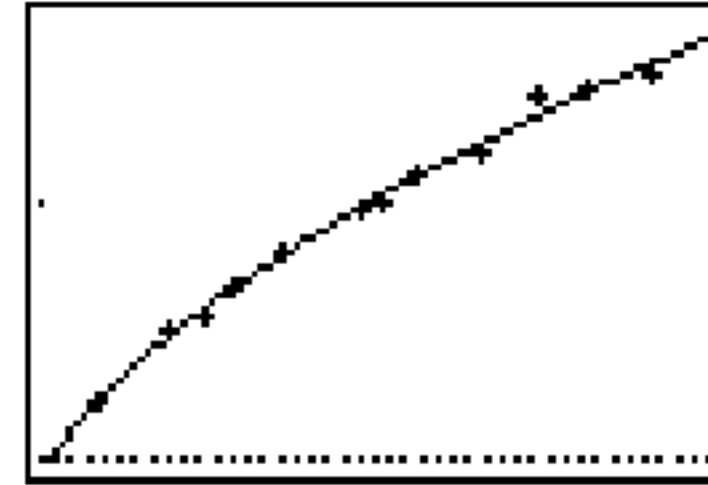

The new function $y = .192x^{.522}$ appears to fit the data well. To get more information, examine a residual plot.

27. Press **Y=** to display the Y= editor.

Press **LEFT** **ENTER** to deselect **Y1**.

Press **UP** **ENTER** to turn off plot 1. Press **RIGHT** **ENTER** to turn on plot 2.

Note: Step 19 defined plot 2 to plot residuals (**RESID**) versus string length (**L1**).

```
Plot1 Plot2 Plot3
\Y1=.19228286213
552X^.5224982852
096
\Y2=
\Y3=
\Y4=
\Y5=
```

28. Press **ZOOM** **9** to select **9:ZoomStat** from the **ZOOM** menu. The window variables are adjusted automatically, and plot 2 is displayed. This is a scatter plot of the residuals.

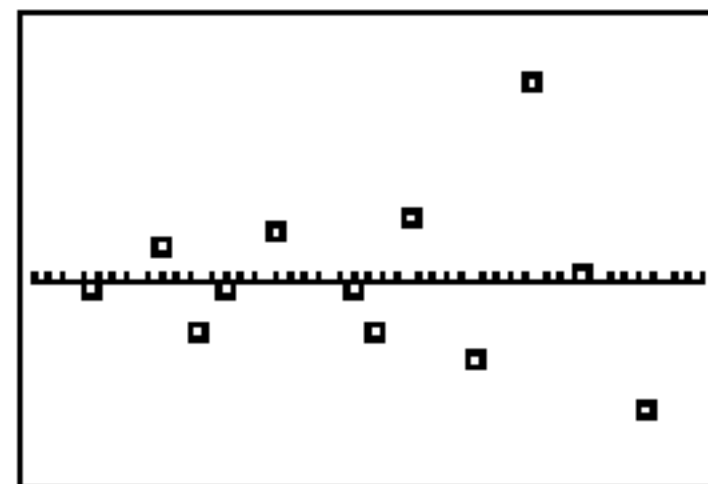

The new residual plot shows that the residuals are random in sign, with the residuals increasing in magnitude as the string length increases.

To see the magnitudes of the residuals, continue with these steps.

29. Press **TRACE**.

Press **▶** and **◀** to trace the data. Observe the values for Y at each point.

With this model, the largest positive residual is about 0.041 and the smallest negative residual is about -0.027. All other residuals are less than 0.02 in magnitude.

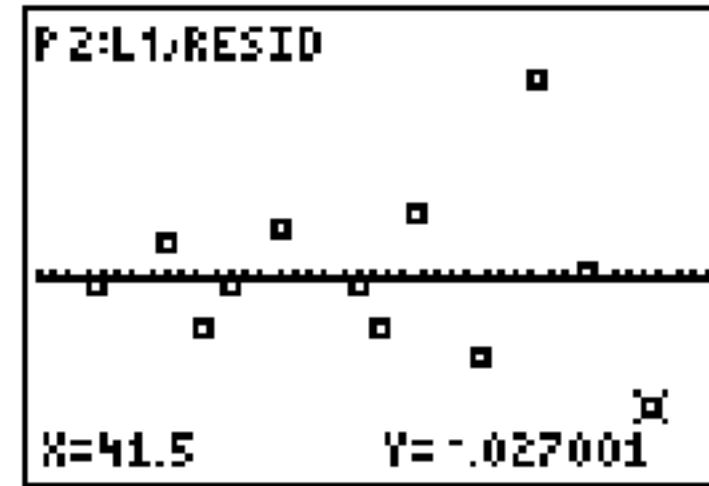

Now that you have a good model for the relationship between length and period, you can use the model to predict the period for a given string length. To predict the periods for a pendulum with string lengths of 20 cm and 50 cm, continue with these steps.

30. Press **VAR** **▶** **1** to display the **VAR** **Y-VARS** **FUNCTION** secondary menu, and then press **1** to select **1:Y1**. **Y1** is pasted to the home screen.

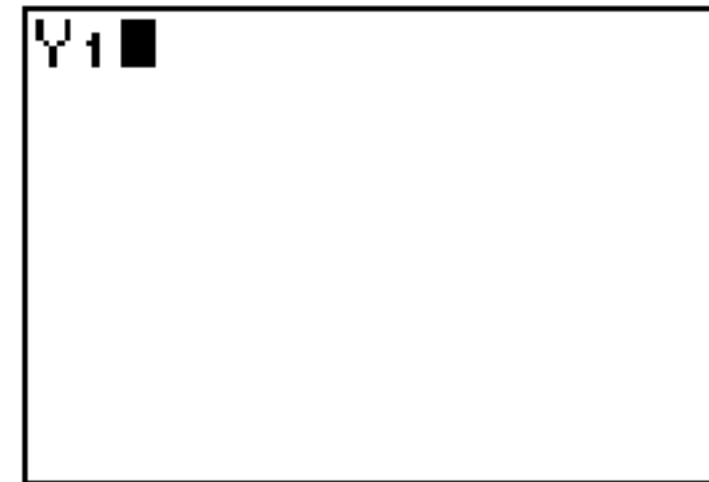

31. Press $\boxed{20}$ to enter a string length of 20 cm.

Press $\boxed{\text{ENTER}}$ to calculate the predicted time of about 0.92 seconds.

Based on the residual analysis, we would expect the prediction of about 0.92 seconds to be within about 0.02 seconds of the actual value.

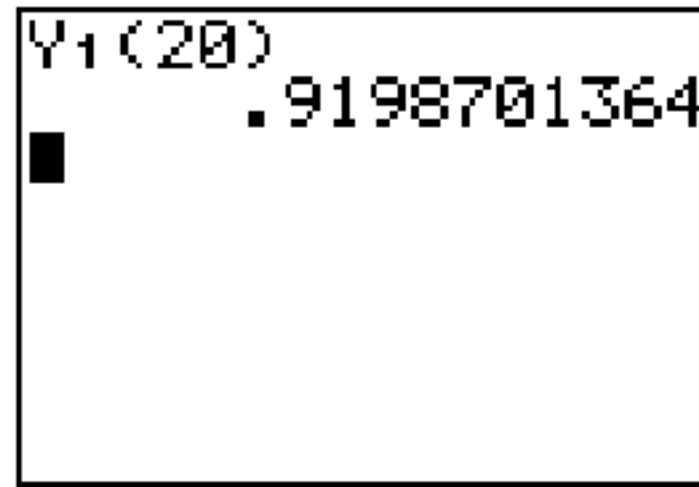

Y1(20)
■ .9198701364

32. Press $\boxed{2\text{nd}} \boxed{\text{ENTRY}}$ to recall the Last Entry.

Press $\boxed{\leftarrow} \boxed{\leftarrow} \boxed{\leftarrow} \boxed{5}$ to change the string length to 50 cm.

33. Press $\boxed{\text{ENTER}}$ to calculate the predicted time of about 1.48 seconds.

Since a string length of 50 cm exceeds the lengths in the data set, and since residuals appear to be increasing as string length increases, we would expect more error with this estimate.

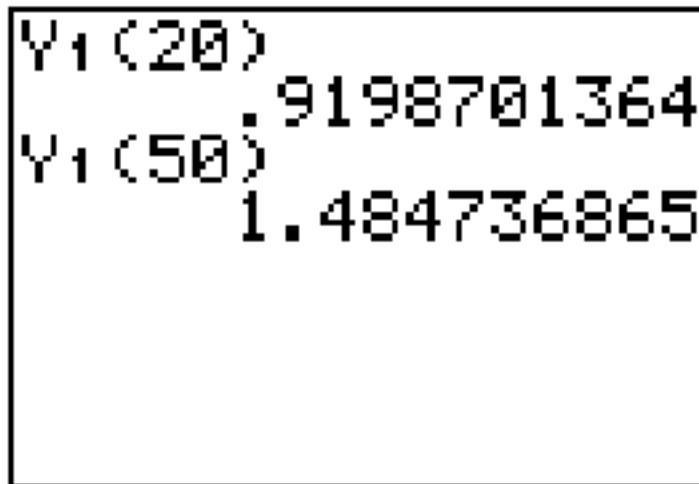

Y1(20) .9198701364
Y1(50) 1.484736865

Note: You also can make predictions using the table with the **TABLE SETUP** settings **Indpnt:Ask** and **Depend:Auto** (Chapter 7).

Setting Up Statistical Analyses

Using Lists to Store Data

Data for statistical analyses is stored in lists, which you can create and edit using the stat list editor. The TI-84 Plus has six list variables in memory, **L1** through **L6**, to which you

can store data for statistical calculations. Also, you can store data to list names that you create (Chapter 11).

Setting Up a Statistical Analysis

To set up a statistical analysis, follow these steps. Read the chapter for details.

1. Enter the statistical data into one or more lists.
2. Plot the data.
3. Calculate the statistical variables or fit a model to the data.
4. Graph the regression equation for the plotted data.
5. Graph the residuals list for the given regression model.

Displaying the Stat List Editor

The stat list editor is a table where you can store, edit, and view up to 20 lists that are in memory. Also, you can create list names from the stat list editor.

To display the stat list editor, press **[STAT]**, and then select **1:Edit** from the **STAT EDIT** menu.

```

SUMM CALC TESTS
1:Edit...
2:SortA(
3:SortD(
4:ClrList
5:SetUpEditor

```

L1	L2	L3	1
-----	-----	-----	
L1(1) =			

The top line displays list names. **L1** through **L6** are stored in columns 1 through 6 after a memory reset. The number of the current column is displayed in the top-right corner.

The bottom line is the entry line. All data entry occurs on this line. The characteristics of this line change according to the current context.

The center area displays up to seven elements of up to three lists; it abbreviates values when necessary. The entry line displays the full value of the current element.

Using the Stat List Editor

Entering a List Name in the Stat List Editor

To enter a list name in the stat list editor, follow these steps.

1. Display the **Name=** prompt in the entry line in either of two ways.
 - Move the cursor onto the list name in the column where you want to insert a list, and then press **2nd** [INS]. An unnamed column is displayed and the remaining lists shift right one column.
 - Press **▲** until the cursor is on the top line, and then press **▶** until you reach the unnamed column.

Note: If list names are stored to all 20 columns, you must remove a list name to make room for an unnamed column.

The **Name=** prompt is displayed and alpha-lock is on.

-----	L1	L2	1
	-----	-----	
Name=			

2. Enter a valid list name in any of four ways.
 - Select a name from the **LIST NAMES** menu (Chapter 11).
 - Enter **L1**, **L2**, **L3**, **L4**, **L5**, or **L6** from the keyboard.
 - Enter an existing user-created list name directly from the keyboard.
 - Enter a new user-created list name.

Name=ABC

3. Press **ENTER** or **▼** to store the list name and its elements, if any, in the current column of the stat list editor.

7374	L1	L2	1
-----	-----	-----	
ABC =			

To begin entering, scrolling, or editing list elements, press \square . The rectangular cursor is displayed.

Note: If the list name you entered in step 2 already was stored in another stat list editor column, then the list and its elements, if any, move to the current column from the previous column. Remaining list names shift accordingly.

Creating a Name in the Stat List Editor

To create a name in the stat list editor, follow these steps.

1. Display the **Name=** prompt.
2. Press [*letter from A to Z or θ*] to enter the first letter of the name. The first character cannot be a number.
3. Enter zero to four letters, θ , or numbers to complete the new user-created list name. List names can be one to five characters long.
4. Press \square or \square to store the list name in the current column of the stat list editor. The list name becomes an item on the **LIST NAMES** menu (Chapter 11).

Removing a List from the Stat List Editor

To remove a list from the stat list editor, move the cursor onto the list name and then press **DEL**. The list is not deleted from memory; it is only removed from the stat list editor.

Notes:

- To delete a list name from memory, use the **MEMORY MANAGEMENT/DELETE** secondary menu (Chapter 18).
- If you archive a list, it will be removed from the stat list editor.

Removing All Lists and Restoring L1 through L6

You can remove all user-created lists from the stat list editor and restore list names **L1** through **L6** to columns 1 through 6 in either of two ways.

- Use **SetUpEditor** with no arguments.
- Reset all memory (Chapter 18).

Clearing All Elements from a List

You can clear all elements from a list in any of five ways.

- Use **ClrList** to clear specified lists.
- In the stat list editor, press **▲** to move the cursor onto a list name, and then press **CLEAR** **ENTER**.
- In the stat list editor, move the cursor onto each element, and then press **DEL** one by one.

- On the home screen or in the program editor, enter **0**→**dim**(*listname*) to set the dimension of *listname* to 0 (Chapter 11).
- Use **ClrAllLists** to clear all lists in memory (Chapter 18).

Editing a List Element

To edit a list element, follow these steps.

1. Move the rectangular cursor onto the element you want to edit.
2. Press **ENTER** to move the cursor to the entry line.

Note: If you want to replace the current value, you can enter a new value without first pressing **ENTER**. When you enter the first character, the current value is cleared automatically.

3. Edit the element in the entry line.
 - Press one or more keys to enter the new value. When you enter the first character, the current value is cleared automatically.
 - Press **▶** to move the cursor to the character before which you want to insert, press **2nd** **[INS]**, and then enter one or more characters.
 - Press **▶** to move the cursor to a character you want to delete, and then press **DEL** to delete the character.

To cancel any editing and restore the original element at the rectangular cursor, press **CLEAR** **ENTER**.

ABC	L1	L2	1
5	-----	-----	
10			
15			
20			
25			

ABC(3)=25*1000			

Note: You can enter expressions and variables for elements.

- Press **ENTER**, **▲**, or **▼** to update the list. If you entered an expression, it is evaluated. If you entered only a variable, the stored value is displayed as a list element.

ABC	L1	L2	1
5	-----	-----	
10			
25000			
20			
25			

ABC(4)=20			

When you edit a list element in the stat list editor, the list is updated in memory immediately.

Attaching Formulas to List Names

Attaching a Formula to a List Name in Stat List Editor

You can attach a formula to a list name in the stat list editor, and then display and edit the calculated list elements. When executed, the attached formula must resolve to a list. Chapter 11 describes in detail the concept of attaching formulas to list names.

To attach a formula to a list name that is stored in the stat list editor, follow these steps.

1. Press **[STAT]** **[ENTER]** to display the stat list editor.
2. Press **[↑]** to move the cursor to the top line.
3. Press **[←]** or **[→]**, if necessary, to move the cursor onto the list name to which you want to attach the formula.

Note: If a formula in quotation marks is displayed on the entry line, then a formula is already attached to the list name. To edit the formula, press **[ENTER]**, and then edit the formula.

4. Press **[ALPHA]** **["]**, enter the formula, and press **[ALPHA]** **["]**.

Note: If you do not use quotation marks, the TI-84 Plus calculates and displays the same initial list of answers, but does not attach the formula for future calculations.

ABC	L1	L2	2
5	-----	-----	
10			
25000			
20			
25			

L1 = " LABC+10" ■			

Note: Any user-created list name referenced in a formula must be preceded by an **L** symbol (Chapter 11).

5. Press **[ENTER]**. The TI-84 Plus calculates each list element and stores it to the list name to which the formula is attached. A lock symbol is displayed in the stat list editor, next to the list name to which the formula is attached.

lock symbol

ABC	L1	#	L2	2
5	15		-----	
10	20			
25000	25010			
20	30			
25	35			
-----	-----			
L1(1) = 15				

Using the Stat List Editor When Formula-Generated Lists Are Displayed

When you edit an element of a list referenced in an attached formula, the TI-84 Plus updates the corresponding element in the list to which the formula is attached (Chapter 11).

ABC	L1	#	L2	1
5	15		-----	
10	20			
25000	25010			
20	30			
25	35			
-----	-----			
ABC(1) = 6				

ABC	L1	#	L2	1
6	16		-----	
10	20			
25000	25010			
20	30			
25	35			
-----	-----			
ABC(2) = 1				

When a list with a formula attached is displayed in the stat list editor and you edit or enter elements of another displayed list, then the TI-84 Plus takes slightly longer to accept each edit or entry than when no lists with formulas attached are in view.

Note: To speed editing time, scroll horizontally until no lists with formulas are displayed, or rearrange the stat list editor so that no lists with formulas are displayed.

Handling Errors Resulting from Attached Formulas

On the home screen, you can attach to a list a formula that references another list with dimension 0 (Chapter 11). However, you cannot display the formula-generated list in the stat list editor or on the home screen until you enter at least one element to the list that the formula references.

All elements of a list referenced by an attached formula must be valid for the attached formula. For example, if **Real** number mode is set and the attached formula is **log(L1)**, then each element of **L1** must be greater than 0, since the logarithm of a negative number returns a complex result.

Notes:

- If an error menu is returned when you attempt to display a formula-generated list in the stat list editor, you can select **2:Goto**, write down the formula that is attached to the list, and then press **CLEAR** **ENTER** to detach (clear) the formula. You then can use the stat list editor to find the source of the error. After making the appropriate changes, you can reattach the formula to a list.
- If you do not want to clear the formula, you can select **1:Quit**, display the referenced list on the home screen, and find and edit the source of the error. To edit an element of a list on the home screen, store the new value to *listname(element#)* (Chapter 11).

Detaching Formulas from List Names

Detaching a Formula from a List Name

You can detach (clear) a formula from a list name in several ways.

For example:

- In the stat list editor, move the cursor onto the name of the list to which a formula is attached. Press **ENTER** **CLEAR** **ENTER**. All list elements remain, but the formula is detached and the lock symbol disappears.
- In the stat list editor, move the cursor onto an element of the list to which a formula is attached. Press **ENTER**, edit the element, and then press **ENTER**. The element changes, the formula is detached, and the lock symbol disappears. All other list elements remain.
- Use **ClrList**. All elements of one or more specified lists are cleared, each formula is detached, and each lock symbol disappears. All list names remain.
- Use **ClrAllLists** (Chapter 18). All elements of all lists in memory are cleared, all formulas are detached from all list names, and all lock symbols disappear. All list names remain.

Editing an Element of a Formula-Generated List

As described above, one way to detach a formula from a list name is to edit an element of the list to which the formula is attached. The TI-84 Plus protects against inadvertently detaching the formula from the list name by editing an element of the formula-generated list.

Because of the protection feature, you must press **ENTER** before you can edit an element of a formula-generated list.

The protection feature does not allow you to delete an element of a list to which a formula is attached. To delete an element of a list to which a formula is attached, you must first detach the formula in any of the ways described above.

Switching Stat List Editor Contexts

Stat List Editor Contexts

The stat list editor has four contexts.

- View-elements context
- View-names context
- Edit-elements context
- Enter-name context

The stat list editor is first displayed in view-elements context. To switch through the four contexts, select **1:Edit** from the **STAT EDIT** menu and follow these steps.

ABC	L1	#	L2	1
5	15		-----	
10	20			
2.5E7	2.5E7			
20	30			
25	35			
-----	-----			
ABC = {5, 10, 25000...}				

1. Press \uparrow to move the cursor onto a list name. You are now in view-names context. Press \rightarrow and \leftarrow to view list names stored in other stat list editor columns.

ABC	L1	#	L2	1
5	15		-----	
10	20			
2.5E7	2.5E7			
20	30			
25	35			
-----	-----			
ABC = {5, 10, 25000...}				

2. Press **ENTER**. You are now in edit-elements context. You may edit any element in a list. All elements of the current list are displayed in braces ({ }) in the entry line. Press \rightarrow and \leftarrow to view more list elements.

ABC	L1	#	L2	2
5	15		-----	
10	20			
2.5E7	2.5E7			
20	30			
25	35			
-----	-----			
L1(3)=25000010				

3. Press **ENTER** again. You are now in view-elements context. Press \rightarrow , \leftarrow , \downarrow , and \uparrow to view other list elements. The current element's full value is displayed in the entry line.

ABC	L1	#	L2	2
5	15		-----	
10	20			
2.5E7	2.5E7			
20	30			
25	35			
-----	-----			
L1(3)=5000010				

4. Press **ENTER** again. You are now in edit-elements context. You may edit the current element in the entry line.

ABC	-----	L1	#	2
5		15		
10		20		
2.5E7		2.5E7		
20		30		
25		35		
-----		-----		
Name=				

5. Press **▲** until the cursor is on a list name, then press **2nd** **[INS]**. You are now in enter-name context.

ABC	-----	#	L2	2
5	15		-----	
10	20			
2.5E7	2.5E7			
20	30			
25	35			
-----	-----			
L1 = "LABC+10"				

6. Press **CLEAR**. You are now in view-names context.

ABC	L1	#	L2	2
5	15		-----	
10	20			
2.5E7	2.5E7			
20	30			
25	35			
-----	-----			
L1(1)=15				

7. Press **▼**. You are now back in view-elements context.

Stat List Editor Contexts

View-Elements Context

In view-elements context, the entry line displays the list name, the current element's place in that list, and the full value of the current element, up to 12 characters at a time. An ellipsis (...) indicates that the element continues beyond 12 characters.

ABC	L1	#	L2	2
5	15		-----	
10	20			
2.5E7	25010			
20	30			
25	35			
-----	-----			
L1(3)=2500010				

To page down the list six elements, press **[ALPHA]** **[↓]**. To page up six elements, press **[ALPHA]** **[↑]**. To delete a list element, press **[DEL]**. Remaining elements shift up one row. To insert a new element, press **[2nd]** **[INS]**. **0** is the default value for a new element.

Edit-Elements Context

In edit-elements context, the data displayed in the entry line depends on the previous context.

- When you switch to edit-elements context from view-elements context, the full value of the current element is displayed. You can edit the value of this element, and then press **[↓]** and **[↑]** to edit other list elements.

ABC	L1	#	L2	1
5	15		-----	
10	20			
250000	25010			
20	30			
25	35			
-----	-----			
ABC(3)=25000				

→

ABC	L1	#	L2	1
5	15		-----	
10	20			
25000	25010			
20	30			
25	35			
-----	-----			
ABC(3)=5000				

- When you switch to edit-elements context from view-names context, the full values of all elements in the list are displayed. An ellipsis indicates that list elements continue beyond the screen. You can press \blacktriangleright and \blacktriangleleft to edit any element in the list.

STAT	L1	#	L2	1
5	15		-----	
10	20			
25000	25010			
20	30			
25	35			
-----	-----			
ABC = {5, 10, 25000...}				

→

STAT	L1	#	L2	1
5	15		-----	
10	20			
25000	25010			
20	30			
25	35			
-----	-----			
ABC = ■5, 10, 25000...				

Note: In edit-elements context, you can attach a formula to a list name only if you switched to it from view-names context.

View-Names Context

In view-names context, the entry line displays the list name and the list elements.

STAT	L1	#	L2	1
5	15		-----	
10	20			
25000	25010			
20	30			
25	35			
-----	-----			
ABC = {5, 10, 25000...}				

To remove a list from the stat list editor, press DEL . Remaining lists shift to the left one column. The list is not deleted from memory.

To insert a name in the current column, press 2nd [INS] . Remaining columns shift to the right one column.

Enter-Name Context

In enter-name context, the **Name=** prompt is displayed in the entry line, and alpha-lock is on.

At the **Name=** prompt, you can create a new list name, paste a list name from **L1** to **L6** from the keyboard, or paste an existing list name from the **LIST NAMES** menu (Chapter 11). The **L** symbol is not required at the **Name=** prompt.

ABC	L1	# 1
5	15	
10	20	
25000	25010	
20	30	
25	35	
-----	-----	

Name=

To leave enter-name context without entering a list name, press **CLEAR**. The stat list editor switches to view-names context.

STAT EDIT Menu

STAT EDIT Menu

To display the **STAT EDIT** menu, press `[STAT]`.

EDIT CALC TESTS

1: Edit...	Displays the stat list editor.
2: SortA(Sorts a list in ascending order.
3: SortD(Sorts a list in descending order.
4: ClrList	Deletes all elements of a list.
5: SetUpEditor	Stores specified lists in the stat list editor.

Note: Chapter 13: Inferential Statistics describes the **STAT TESTS** menu items.

SortA(, SortD(

SortA((sort ascending) sorts list elements from low to high values. **SortD(** (sort descending) sorts list elements from high to low values. Complex lists are sorted based on magnitude (modulus). **SortA(** and **SortD(** each can sort in either of two ways.

- With one *listname*, **SortA(** and **SortD(** sort the elements in *listname* and update the list in memory.
- With two or more lists, **SortA(** and **SortD(** sort *keylistname*, and then sort each *dependlist* by placing its elements in the same order as the corresponding elements in

keylistname. This lets you sort two-variable data on X and keep the data pairs together. All lists must have the same dimension.

The sorted lists are updated in memory.

SortA(*listname*)

SortD(*listname*)

SortA(*keylistname*,*dependlist1* [,*dependlist2*, ..., *dependlist n*])

SortD(*keylistname*,*dependlist1* [,*dependlist2*, ..., *dependlist n*])

{5, 4, 3} → L ₃ {5 4 3}	L ₃ {3 4 5}
{1, 2, 3} → L ₄ {1 2 3}	L ₄ {3 2 1}
SortA(L ₃ , L ₄) Done	■

Note: **SortA**(and **SortD**(are the same as **SortA**(and **SortD**(on the **LIST OPS** menu.

ClrList

ClrList clears (deletes) from memory the elements of one or more *listnames*. **ClrList** also detaches any formula attached to a *listname*.

ClrList *listname1*, *listname2*, ..., *listname n*

Note: To clear from memory all elements of all list names, use **ClrAllLists** (Chapter 18).

SetUpEditor

With **SetUpEditor** you can set up the stat list editor to display one or more *listnames* in the order that you specify. You can specify zero to 20 *listnames*.

Additionally, if you want to use *listnames* which happen to be archived, the SetUp Editor will automatically unarchive the *listnames* and place them in the stat list editor at the same time.

SetUpEditor [*listname1*,*listname2*,...,*listname n*]

SetUpEditor with one to 20 *listnames* removes all list names from the stat list editor and then stores *listnames* in the stat list editor columns in the specified order, beginning in column 1.

```
SetUpEditor RESI
D,L3,L6,TIME,LON
G,A123
Done
```

RESID	L3	L6	# 1
.00013	1	11	
.00692	2	12	
-.0104	3	13	
-.0015	4	14	
.0094	5	15	
-.0018	6	16	
-.0106	-----	-----	
RESID(1) = -.0013125...			

TIME	LONG	A123	4
60	56	5	
120	82	10	
30	74	15	
180	55	20	
-----	36	25	
	98	30	
	74	-----	
TIME(1) = 60			

If you enter a *listname* that is not stored in memory already, then *listname* is created and stored in memory; it becomes an item on the **LIST NAMES** menu.

Restoring L1 through L6 to the Stat List Editor

SetUpEditor with no *listnames* removes all list names from the stat list editor and restores list names **L1** through **L6** in the stat list editor columns 1 through 6.

```
SetUpEditor Done
■
```

L1	L2	L3	1
6.5	.51	1	
11	.68	2	
13.2	.73	3	
15	.79	4	
18	.88	5	
23.1	.99	6	
24.4	1.01	-----	

L1(1)=6.5

L4	L5	L6	# 4
-----	-----	11	
		12	
		13	
		14	
		15	
		16	

L4(1)=

Regression Model Features

Regression Model Features

STAT CALC menu items **3** through **C** are regression models. The automatic residual list and automatic regression equation features apply to all regression models. Diagnostics display mode applies to some regression models.

Automatic Residual List

When you execute a regression model, the automatic residual list feature computes and stores the residuals to the list name **RESID**. **RESID** becomes an item on the **LIST NAMES** menu (Chapter 11).

```

NAME OPS MATH
1:ABC
2:RESID

```

The TI-84 Plus uses the formula below to compute RESID list elements. The next section describes the variable **RegEQ**.

$$\text{RESID} = Ylistname - \text{RegEQ}(Xlistname)$$

Automatic Regression Equation

Each regression model has an optional argument, *regequ*, for which you can specify a Y= variable such as **Y1**. Upon execution, the regression equation is stored automatically to the specified Y= variable and the Y= function is selected.

```

(1,2,3)→L1:(-1,-
2,-5)→L2
(-1 -2 -5)
LinReg(ax+b) L1,
L2,Y3

```

```

LinReg
y=ax+b
a=-2
b=1.333333333

```

```

Plot1 Plot2 Plot3
Y1=
Y2=
Y3=-2X+1.333333
3333333

```

Regardless of whether you specify a Y= variable for *regequ*, the regression equation always is stored to the TI-84 Plus variable **RegEQ**, which is item 1 on the **VARS Statistics EQ** secondary menu.

```

XY Σ [ ] TEST PTS
[ ] RegEQ
2:a
3:b

```

Note: For the regression equation, you can use the fixed-decimal mode setting to control the number of digits stored after the decimal point (Chapter 1). However, limiting the number of digits to a small number could affect the accuracy of the fit.

Diagnostics Display Mode

When you execute some regression models, the TI-84 Plus computes and stores diagnostics values for r (correlation coefficient) and r^2 (coefficient of determination) or for R^2 (coefficient of determination).

r and r^2 are computed and stored for these regression models.

LinReg(ax+b)	LnReg	PwrReg
LinReg(a+bx)	ExpReg	

R^2 is computed and stored for these regression models.

QuadReg	CubicReg	QuartReg
----------------	-----------------	-----------------

The r and r^2 that are computed for **LnReg**, **ExpReg**, and **PwrReg** are based on the linearly transformed data. For example, for **ExpReg** ($y=ab^x$), r and r^2 are computed on $\ln y = \ln a + x(\ln b)$.

By default, these values are not displayed with the results of a regression model when you execute it. However, you can set the diagnostics display mode by executing the **DiagnosticOn** or **DiagnosticOff** instruction. Each instruction is in the CATALOG (Chapter 15).

```
CATALOG
det(
DiagnosticOff
DiagnosticOn
dim(
```

Note: To set **DiagnosticOn** or **DiagnosticOff** from the home screen, press $\boxed{2nd}$ [CATALOG], and then select the instruction for the mode you want. The instruction is pasted to the home screen. Press \boxed{ENTER} to set the mode.

When **DiagnosticOn** is set, diagnostics are displayed with the results when you execute a regression model.

```
DiagnosticOn
LinReg(ax+b) L1,
L2 Done
```

```
LinReg
y=ax+b
a=-2
b=1.333333333
r2=.9230769231
r=-.9607689228
```

When **DiagnosticOff** is set, diagnostics are not displayed with the results when you execute a regression model.

```
DiagnosticOff
LinReg(ax+b) L1,
L2 Done
```

```
LinReg
y=ax+b
a=-2
b=1.333333333
```

STAT CALC Menu

STAT CALC Menu

To display the **STAT CALC** menu, press **STAT** **▸**.

EDIT	CALC	TESTS
1:	1-Var Stats	Calculates 1-variable statistics.
2:	2-Var Stats	Calculates 2-variable statistics.
3:	Med-Med	Calculates a median-median line.
4:	LinReg(ax+b)	Fits a linear model to data.
5:	QuadReg	Fits a quadratic model to data.
6:	CubicReg	Fits a cubic model to data.
7:	QuartReg	Fits a quartic model to data.
8:	LinReg(a+bx)	Fits a linear model to data.
9:	LnReg	Fits a logarithmic model to data.
0:	ExpReg	Fits an exponential model to data.
A:	PwrReg	Fits a power model to data.
B:	Logistic	Fits a logistic model to data.
C:	SinReg	Fits a sinusoidal model to data.
D:	Manual Linear Fit	Fits a linear equation interactively to a scatter plot.

For each **STAT CALC** menu item, if neither *Xlistname* nor *Ylistname* is specified, then the default list names are **L1** and **L2**. If you do not specify *freqlist*, then the default is 1 occurrence of each list element.

Frequency of Occurrence for Data Points

For most **STAT CALC** menu items, you can specify a list of data occurrences, or frequencies (*freqlist*).

Each element in *freqlist* indicates how many times the corresponding data point or data pair occurs in the data set you are analyzing.

For example, if **L1={15,12,9,14}** and **LFREQ={1,4,1,3}**, then the TI-84 Plus interprets the instruction **1-Var Stats L1, LFREQ** to mean that 15 occurs once, 12 occurs four times, 9 occurs once, and 14 occurs three times.

Each element in *freqlist* must be ≥ 0 , and at least one element must be > 0 .

Noninteger *freqlist* elements are valid. This is useful when entering frequencies expressed as percentages or parts that add up to 1. However, if *freqlist* contains noninteger frequencies, **Sx** and **Sy** are undefined; values are not displayed for **Sx** and **Sy** in the statistical results.

1-Var Stats

1-Var Stats (one-variable statistics) analyzes data with one measured variable. Each element in *freqlist* is the frequency of occurrence for each corresponding data point in *Xlistname*. *freqlist* elements must be real numbers > 0 .

1-Var Stats [*Xlistname*,*freqlist*]

```
1-Var Stats L1,L2
```

2-Var Stats

2-Var Stats (two-variable statistics) analyzes paired data. *Xlistname* is the independent variable. *Ylistname* is the dependent variable. Each element in *freqlist* is the frequency of occurrence for each data pair (*Xlistname*, *Ylistname*).

2-Var Stats [*Xlistname*, *Ylistname*, *freqlist*]

Med-Med (ax+b)

Med-Med (median-median) fits the model equation $y=ax+b$ to the data using the median-median line (resistant line) technique, calculating the summary points x_1 , y_1 , x_2 , y_2 , x_3 , and y_3 . **Med-Med** displays values for **a** (slope) and **b** (y-intercept).

Med-Med [*Xlistname*, *Ylistname*, *freqlist*, *regequ*]

```
Med-Med L3,L4,Y2
```

```
Med-Med  
y=ax+b  
a=.875  
b=1.541666667
```

LinReg (ax+b)

LinReg(ax+b) (linear regression) fits the model equation $y=ax+b$ to the data using a least-squares fit. It displays values for **a** (slope) and **b** (y-intercept); when **DiagnosticOn** is set, it also displays values for r^2 and r .

LinReg(ax+b) [*Xlistname*,*Ylistname*,*freqlist*,*regequ*]

QuadReg (ax^2+bx+c)

QuadReg (quadratic regression) fits the second-degree polynomial $y=ax^2+bx+c$ to the data. It displays values for **a**, **b**, and **c**; when **DiagnosticOn** is set, it also displays a value for R^2 . For three data points, the equation is a polynomial fit; for four or more, it is a polynomial regression. At least three data points are required.

QuadReg [*Xlistname*,*Ylistname*,*freqlist*,*regequ*]

CubicReg—(ax^3+bx^2+cx+d)

CubicReg (cubic regression) fits the third-degree polynomial $y=ax^3+bx^2+cx+d$ to the data. It displays values for **a**, **b**, **c**, and **d**; when **DiagnosticOn** is set, it also displays a value for R^2 . For four points, the equation is a polynomial fit; for five or more, it is a polynomial regression. At least four points are required.

CubicReg [*Xlistname*,*Ylistname*,*freqlist*,*regequ*]

QuartReg—($ax^4+bx^3+cx^2+dx+e$)

QuartReg (quartic regression) fits the fourth-degree polynomial $y=ax^4+bx^3+cx^2+dx+e$ to the data. It displays values for **a**, **b**, **c**, **d**, and **e**; when **DiagnosticOn** is set, it also displays a value for R^2 . For five points, the equation is a polynomial fit; for six or more, it is a polynomial regression. At least five points are required.

QuartReg [*Xlistname*,*Ylistname*,*freqlist*,*regequ*]

LinReg— $(a+bx)$

LinReg($a+bx$) (linear regression) fits the model equation $y=a+bx$ to the data using a least-squares fit. It displays values for **a** (y-intercept) and **b** (slope); when **DiagnosticOn** is set, it also displays values for r^2 and **r**.

LinReg($a+bx$) [*Xlistname*,*Ylistname*,*freqlist*,*regequ*]

LnReg— $(a+b \ln(x))$

LnReg (logarithmic regression) fits the model equation $y=a+b \ln(x)$ to the data using a least-squares fit and transformed values $\ln(x)$ and y . It displays values for **a** and **b**; when **DiagnosticOn** is set, it also displays values for r^2 and **r**.

LnReg [*Xlistname*,*Ylistname*,*freqlist*,*regequ*]

ExpReg— (ab^x)

ExpReg (exponential regression) fits the model equation $y=ab^x$ to the data using a least-squares fit and transformed values x and $\ln(y)$. It displays values for **a** and **b**; when **DiagnosticOn** is set, it also displays values for r^2 and **r**.

ExpReg [*Xlistname*,*Ylistname*,*freqlist*,*regequ*]

PwrReg— (ax^b)

PwrReg (power regression) fits the model equation $y=ax^b$ to the data using a least-squares fit and transformed values $\ln(x)$ and $\ln(y)$. It displays values for **a** and **b**; when **DiagnosticOn** is set, it also displays values for r^2 and **r**.

PwrReg [*Xlistname*,*Ylistname*,*freqlist*,*regequ*]

Logistic— $c/(1+a*e^{-bx})$

Logistic fits the model equation $y=c/(1+a*e^{-bx})$ to the data using an iterative least-squares fit. It displays values for **a**, **b**, and **c**.

Logistic [*Xlistname*,*Ylistname*,*freqlist*,*regequ*]

SinReg— $a \sin(bx+c)+d$

SinReg (sinusoidal regression) fits the model equation $y=a \sin(bx+c)+d$ to the data using an iterative least-squares fit. It displays values for **a**, **b**, **c**, and **d**. At least four data points are required. At least two data points per cycle are required in order to avoid aliased frequency estimates.

SinReg [*iterations*,*Xlistname*,*Ylistname*,*period*,*regequ*]

iterations is the maximum number of times the algorithm will iterate to find a solution. The value for *iterations* can be an integer ≥ 1 and ≤ 16 ; if not specified, the default is 3. The algorithm may find a solution before *iterations* is reached. Typically, larger values for *iterations* result in longer execution times and better accuracy for **SinReg**, and vice versa.

A *period* guess is optional. If you do not specify *period*, the difference between time values in *Xlistname* must be equal and the time values must be ordered in ascending sequential

order. If you specify *period*, the algorithm may find a solution more quickly, or it may find a solution when it would not have found one if you had omitted a value for *period*. If you specify *period*, the differences between time values in *Xlistname* can be unequal.

Note: The output of **SinReg** is always in radians, regardless of the Radian/Degree mode setting.

SinReg Example: Daylight Hours in Alaska for One Year

Compute the regression model for the number of hours of daylight in Alaska during one year.

```
seq(X,X,1,361,30
)→L1:(5.5,8,11,1
3.5,16.5,19,19.5
,17,14.5,12.5,8.
5,6.5,5.5)→L2
(5.5 8 11 13.5 ...
```

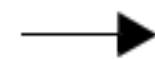

```
Plot1 Plot2 Plot3
Off Off
Type: [ ] [ ] [ ]
[ ] [ ] [ ]
Xlist:L1
Ylist:L2
Mark: [ ] [ ] [ ]
```

```
SinReg L1,L2,Y1
```

```
SinReg
y=a*sin(bx+c)+d
a=6.770292445
b=.0162697853
c=-1.215498579
d=12.18138372
```

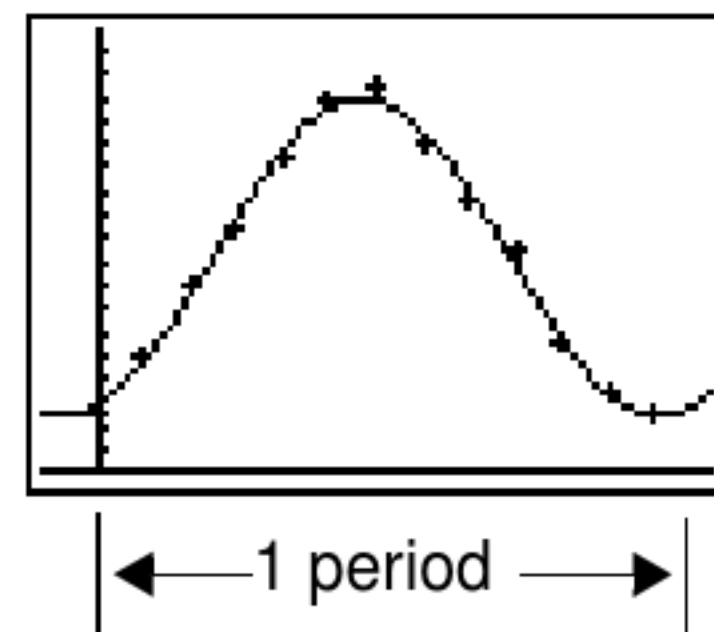

With noisy data, you will achieve better convergence results when you specify an accurate estimate for *period*. You can obtain a *period* guess in either of two ways.

- Plot the data and trace to determine the x-distance between the beginning and end of one complete period, or cycle. The illustration above and to the right graphically depicts a complete period, or cycle.
- Plot the data and trace to determine the x-distance between the beginning and end of N complete periods, or cycles. Then divide the total distance by N.

After your first attempt to use **SinReg** and the default value for *iterations* to fit the data, you may find the fit to be approximately correct, but not optimal. For an optimal fit, execute **SinReg 16,Xlistname,Ylistname,2 π /b** where *b* is the value obtained from the previous **SinReg** execution.

Manual Linear Fit

Manual Linear Fit allows you to visually fit a linear function to a scatter plot. Manual Linear Fit is an option in the **[STAT]** **[CALC]** menu.

After entering List data and viewing the StatPlot, select the Manual-Fit function.

1. Press **[STAT]** to display the Stat menu. Press **[▶]** to select **CALC**. Press **[▼]** several times to scroll down to select **D:Manual-Fit**. Press **[ENTER]**. This displays a free-floating cursor at the center of the display screen

```
EDIT  [ ] TESTS
8↑LinReg(a+bx)
9:LnReg
0:ExpReg
A:PwrReg
B:Logistic
C:SinReg
[ ]Manual-Fit
```

- Press the cursor navigation keys (\uparrow \downarrow \leftarrow \rightarrow) to move the cursor to the desired location. Press $\boxed{\text{ENTER}}$ to select the first point.
- Press the cursor navigation keys (\uparrow \downarrow \leftarrow \rightarrow) to move the cursor to the second location. Press $\boxed{\text{ENTER}}$. This displays a line containing the two points selected.

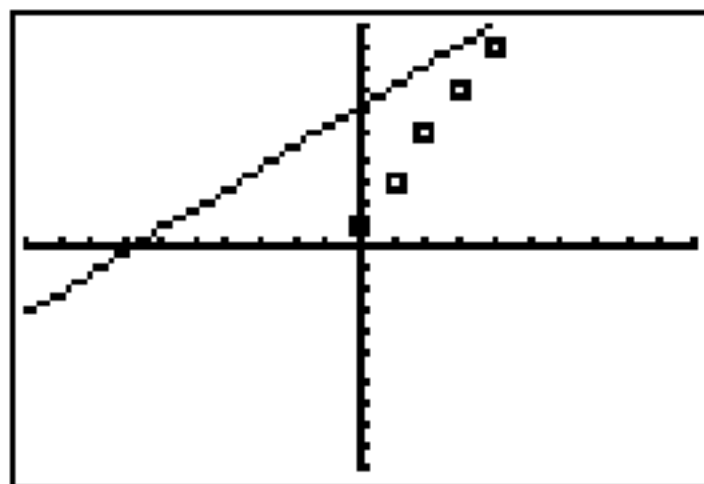

The linear function is displayed. The Manual-Fit Line equation displays in the form of $Y=mX+b$. The current value of the first parameter (m) is highlighted in the symbolic expression.

Modify parameter values

Press the cursor navigation keys (\leftarrow \rightarrow) to move from the first parameter (m) or (b) the second parameter. You can press $\boxed{\text{ENTER}}$ and type a new parameter value. Press $\boxed{\text{ENTER}}$ to display the new parameter value. When you edit the value of the selected parameter, the edit can include insert, delete, type over, or mathematical expression.

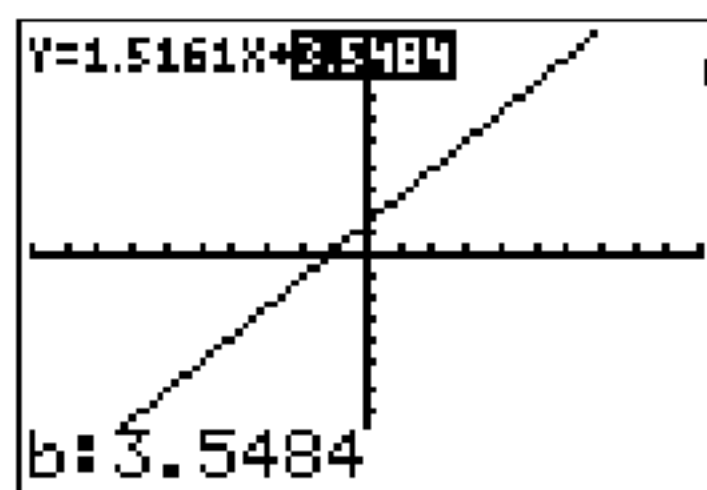
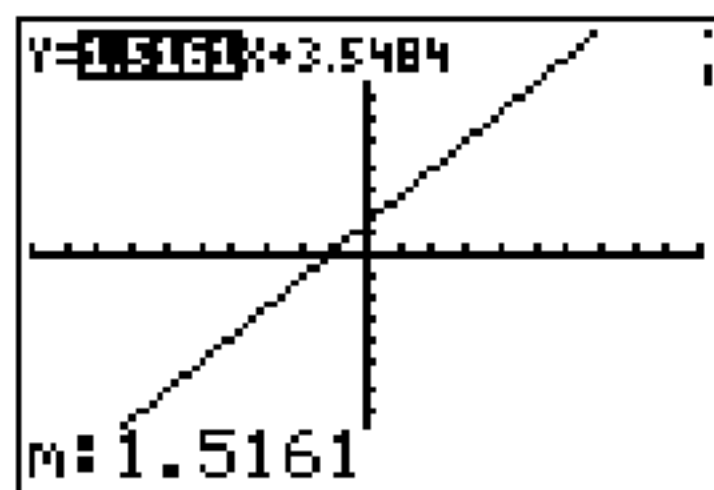

The screen dynamically displays the revised parameter value. Press $\boxed{\text{ENTER}}$ to complete the modification of the selected parameter, save the value, and refresh the displayed graph. The system displays the revised parameter value in the symbolic expression $Y=mX+B$, and refreshes the graph with the updated Manual-Fit Line.

Select $\boxed{2\text{nd}}$ [QUIT] to finish the Manual Fit function. The calculator stores the current $mX+b$ expression into Y1 and makes that function active for graphing. You can also select Manual-Fit while on the **Home** screen. You can then enter a different **Y-Var** such as **Y4** and then press $\boxed{\text{ENTER}}$. This takes you to the Graph screen and then pastes the Manual-Fit equation in the specified **Y-Var**. In this example, **Y4**.

Statistical Variables

The statistical variables are calculated and stored as indicated below. To access these variables for use in expressions, press $\boxed{\text{VARS}}$, and select **5:Statistics**. Then select the **VARS** menu shown in the column below under **VARS** menu. If you edit a list or change the type of analysis, all statistical variables are cleared.

Variables	1-Var Stats	2-Var Stats	Other	VARS menu
mean of x values	\bar{x}	\bar{x}		XY
sum of x values	Σx	Σx		Σ
sum of x^2 values	Σx^2	Σx^2		Σ
sample standard deviation of x	Sx	Sx		XY
population standard deviation of x	σx	σx		XY
number of data points	n	n		XY
mean of y values		\bar{y}		XY
sum of y values		Σy		Σ
sum of y^2 values		Σy^2		Σ
sample standard deviation of y		Sy		XY

Variables	1-Var Stats	2-Var Stats	Other	VARS menu
population standard deviation of y		σ_y		XY
sum of x * y		Σxy		Σ
minimum of x values	minX	minX		XY
maximum of x values	maxX	maxX		XY
minimum of y values		minY		XY
maximum of y values		maxY		XY
1st quartile	Q1			PTS
median	Med			PTS
3rd quartile	Q3			PTS
regression/fit coefficients			a, b	EQ
polynomial, Logistic , and SinReg coefficients			a, b, c, d, e	EQ
correlation coefficient			r	EQ
coefficient of determination			r^2, R^2	EQ
regression equation			RegEQ	EQ
summary points (Med-Med only)			x1, y1, x2, y2, x3, y3	PTS

Q1 and Q3

The first quartile (**Q1**) is the median of points between **minX** and **Med** (median). The third quartile (**Q3**) is the median of points between **Med** and **maxX**.

Statistical Analysis in a Program

Entering Stat Data

You can enter statistical data, calculate statistical results, and fit models to data from a program. You can enter statistical data into lists directly within the program (Chapter 11).

```
PROGRAM:STATS
:(1,2,3)→L1
:(-1,-2,-5)→L2
```

Statistical Calculations

To perform a statistical calculation from a program, follow these steps.

1. On a blank line in the program editor, select the type of calculation from the **STAT CALC** menu.
2. Enter the names of the lists to use in the calculation. Separate the list names with a comma.
3. Enter a comma and then the name of a Y= variable, if you want to store the regression equation to a Y= variable.

```
PROGRAM:STATS
:(1,2,3)→L1
:(-1,-2,-5)→L2
:LinReg(ax+b) L1
:L2,Y2
:█
```

Statistical Plotting

Steps for Plotting Statistical Data in Lists

You can plot statistical data that is stored in lists. The six types of plots available are scatter plot, xyLine, histogram, modified box plot, regular box plot, and normal probability plot. You can define up to three plots.

To plot statistical data in lists, follow these steps.

1. Store the stat data in one or more lists.
2. Select or deselect Y= functions as appropriate.
3. Define the stat plot.
4. Turn on the plots you want to display.
5. Define the viewing window.
6. Display and explore the graph.

Scatter

Scatter (☒) plots plot the data points from **Xlist** and **Ylist** as coordinate pairs, showing each point as a box (☐), cross (+), or dot (•). **Xlist** and **Ylist** must be the same length. You can use the same list for **Xlist** and **Ylist**.

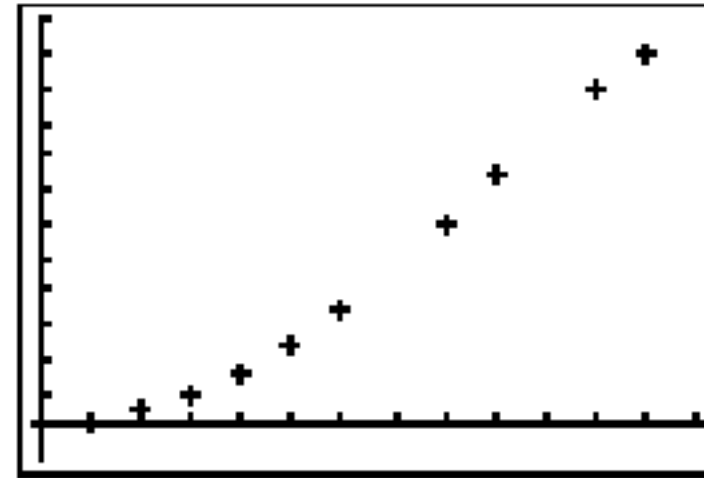
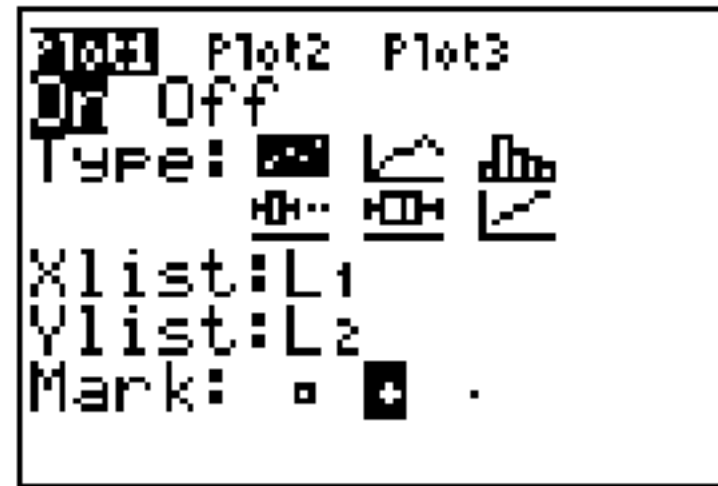

xyLine

xyLine (☒) is a scatter plot in which the data points are plotted and connected in order of appearance in **Xlist** and **Ylist**. You may want to use **SortA()** or **SortD()** to sort the lists before you plot them.

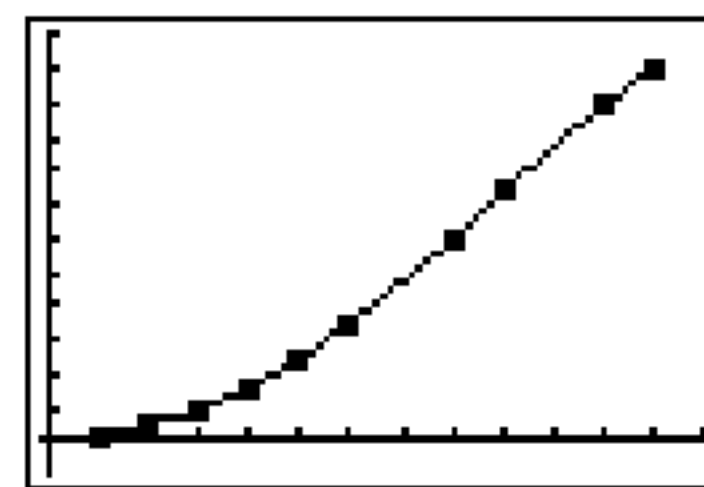
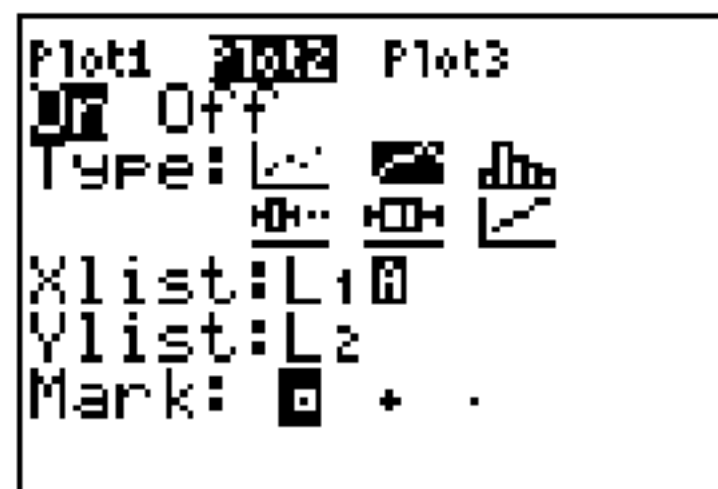

Histogram

Histogram (▭) plots one-variable data. The **Xscl** window variable value determines the width of each bar, beginning at **Xmin**. **ZoomStat** adjusts **Xmin**, **Xmax**, **Ymin**, and **Ymax** to include all values, and also adjusts **Xscl**. The inequality $(\mathbf{Xmax} - \mathbf{Xmin}) / \mathbf{Xscl} \leq 47$ must be true. A value that occurs on the edge of a bar is counted in the bar to the right.

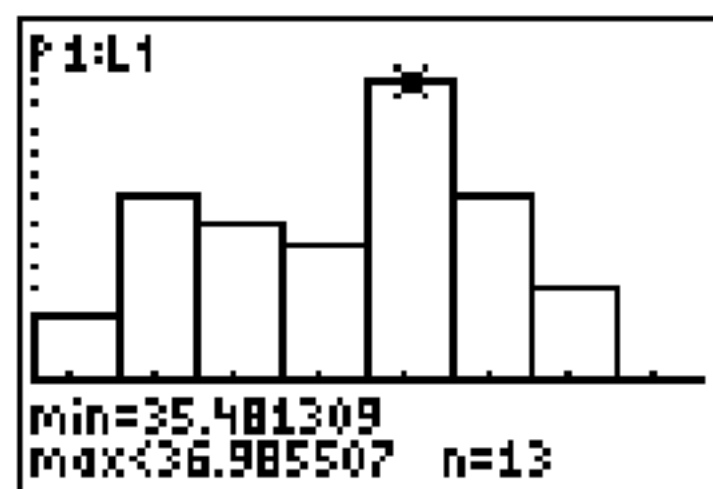
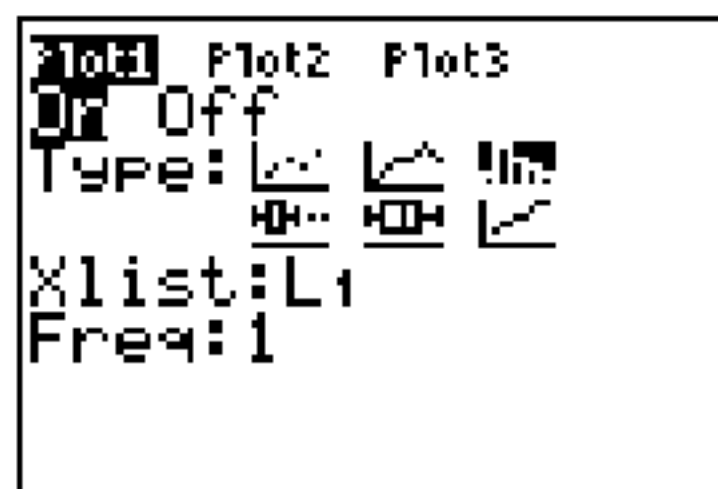

ModBoxplot

ModBoxplot (▭) (modified box plot) plots one-variable data, like the regular box plot, except points that are $1.5 * \text{Interquartile Range}$ beyond the quartiles. (The Interquartile Range is defined as the difference between the third quartile **Q3** and the first quartile **Q1**.) These points are plotted individually beyond the whisker, using the **Mark** (□ or + or •) you select. You can trace these points, which are called outliers.

The prompt for outlier points is **x=**, except when the outlier is the maximum point (**maxX**) or the minimum point (**minX**). When outliers exist, the end of each whisker will display **x=**. When no outliers exist, **minX** and **maxX** are the prompts for the end of each whisker. **Q1**, **Med** (median), and **Q3** define the box.

Box plots are plotted with respect to **Xmin** and **Xmax**, but ignore **Ymin** and **Ymax**. When two box plots are plotted, the first one plots at the top of the screen and the second plots

in the middle. When three are plotted, the first one plots at the top, the second in the middle, and the third at the bottom.

```

STAT PLOTS
1: Plot1...On
   L1 1 +
2: Plot2...On
   L2 1 +
3: Plot3...Off
   L1 L2 □
4↓ PlotsOff
  
```

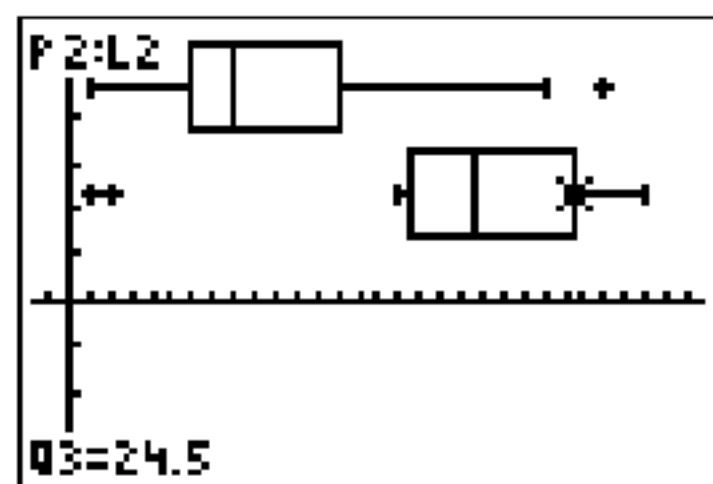

Boxplot

Boxplot () (regular box plot) plots one-variable data. The whiskers on the plot extend from the minimum data point in the set (**minX**) to the first quartile (**Q1**) and from the third quartile (**Q3**) to the maximum point (**maxX**). The box is defined by **Q1**, **Med** (median), and **Q3**.

Box plots are plotted with respect to **Xmin** and **Xmax**, but ignore **Ymin** and **Ymax**. When two box plots are plotted, the first one plots at the top of the screen and the second plots in the middle. When three are plotted, the first one plots at the top, the second in the middle, and the third at the bottom.

```

STAT PLOTS
1: Plot1...On
   L1 1
2: Plot2...On
   L2 1
3: Plot3...Off
   L3 1
4↓ PlotsOff
  
```

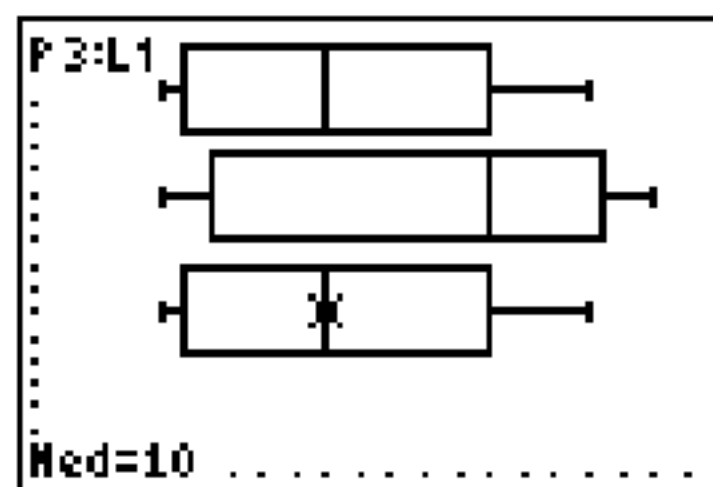







NormProbPlot

NormProbPlot () (normal probability plot) plots each observation X in **Data List** versus the corresponding quantile z of the standard normal distribution. If the plotted points lie close to a straight line, then the plot indicates that the data are normal.

Enter a valid list name in the **Data List** field. Select X or Y for the **Data Axis** setting.

- If you select X, the TI-84 Plus plots the data on the x-axis and the z-values on the y-axis.
- If you select Y, the TI-84 Plus plots the data on the y-axis and the z-values on the x-axis.

```
randNorm(35,2,90
)→L4
(35.11436075 36...
```

```
Plot1 Plot2 Plot3
Off
Type:   
Data List:L4
Data Axis:Y
Mark:   
```

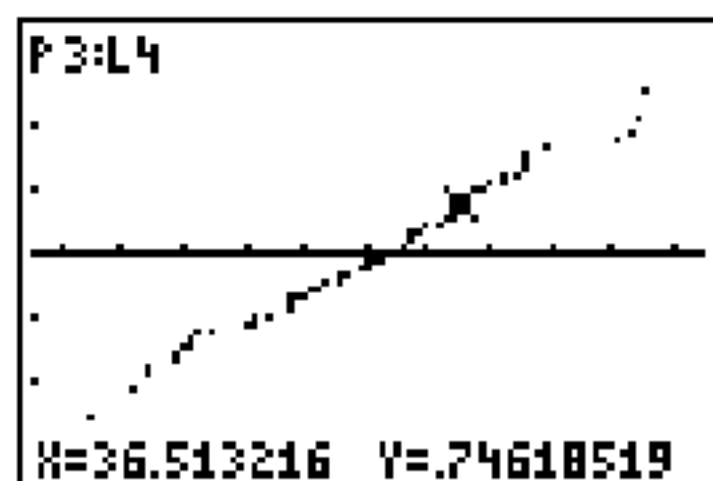

Defining the Plots

To define a plot, follow these steps.

1. Press **[2nd]** **[STAT PLOT]**. The **STAT PLOTS** menu is displayed with the current plot definitions.

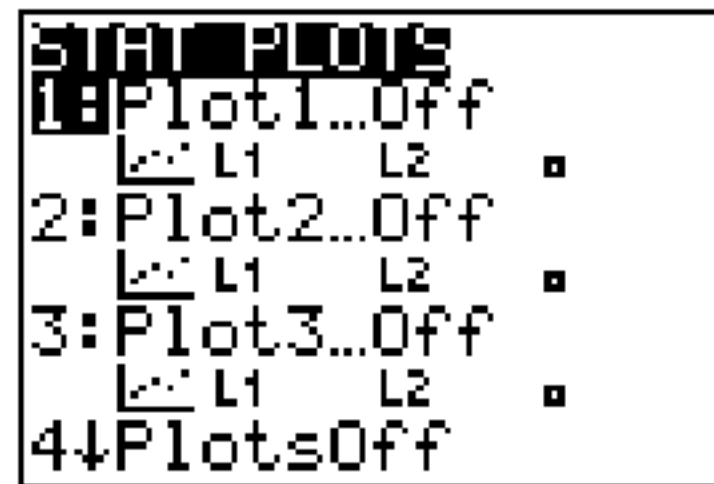

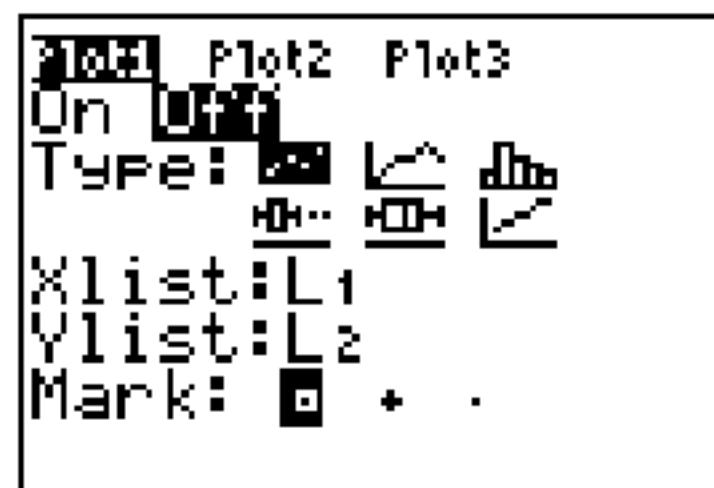

2. Select the plot you want to use. The stat plot editor is displayed for the plot you selected.





3. Press **[ENTER]** to select **On** if you want to plot the statistical data immediately. The definition is stored whether you select **On** or **Off**.
4. Select the type of plot. Each type prompts for the options checked in this table.

Plot Type	XList	YList	Mark	Freq	Data List	Data Axis
Scatter	<input checked="" type="checkbox"/>	<input checked="" type="checkbox"/>	<input checked="" type="checkbox"/>	<input type="checkbox"/>	<input type="checkbox"/>	<input type="checkbox"/>
xyLine	<input checked="" type="checkbox"/>	<input checked="" type="checkbox"/>	<input checked="" type="checkbox"/>	<input type="checkbox"/>	<input type="checkbox"/>	<input type="checkbox"/>
Histogram	<input checked="" type="checkbox"/>	<input type="checkbox"/>	<input type="checkbox"/>	<input checked="" type="checkbox"/>	<input type="checkbox"/>	<input type="checkbox"/>

Plot Type	XList	YList	Mark	Freq	Data List	Data Axis
 ModBoxplot	<input checked="" type="checkbox"/>	<input type="checkbox"/>	<input checked="" type="checkbox"/>	<input checked="" type="checkbox"/>	<input type="checkbox"/>	<input type="checkbox"/>
 Boxplot	<input checked="" type="checkbox"/>	<input type="checkbox"/>	<input type="checkbox"/>	<input checked="" type="checkbox"/>	<input type="checkbox"/>	<input type="checkbox"/>
 NormProbPlot	<input type="checkbox"/>	<input type="checkbox"/>	<input checked="" type="checkbox"/>	<input type="checkbox"/>	<input checked="" type="checkbox"/>	<input checked="" type="checkbox"/>

5. Enter list names or select options for the plot type.
 - **Xlist** (list name containing independent data)
 - **Ylist** (list name containing dependent data)
 - **Mark** (or + or •)
 - **Freq** (frequency list for **Xlist** elements; default is 1)
 - **Data List** (list name for **NormProbPlot**)
 - **Data Axis** (axis on which to plot **Data List**)

Displaying Other Stat Plot Editors

Each stat plot has a unique stat plot editor. The name of the current stat plot (**Plot1**, **Plot2**, or **Plot3**) is highlighted in the top line of the stat plot editor. To display the stat plot editor for a different plot, press  and  to move the cursor onto the name in the top line, and then press **ENTER**. The stat plot editor for the selected plot is displayed, and the selected name remains highlighted.

```

Plot1 Plot2 Plot3
On Off
Type: [Bar] [Line] [Box]
      [Dot] [Cross]
Xlist:L1
Ylist:L2
Mark: [ ] + .

```

Turning On and Turning Off Stat Plots

PlotsOn and **PlotsOff** allow you to turn on or turn off stat plots from the home screen or a program. With no plot number, **PlotsOn** turns on all plots and **PlotsOff** turns off all plots. With one or more plot numbers (1, 2, and 3), **PlotsOn** turns on specified plots, and **PlotsOff** turns off specified plots.

PlotsOff [1,2,3]

PlotsOn [1,2,3]

```

PlotsOff           Done
PlotsOn 3          Done
■

```

```

STAT PLOTS
1:Plot1...Off
  [Bar] L1 1 [ ]
2:Plot2...Off
  [Line] L1 RESID [ ]
3:Plot3...On
  [Box] L4 xAxis .
4↓PlotsOff

```

Note: You also can turn on and turn off stat plots in the top line of the Y= editor (Chapter 3).

Defining the Viewing Window

Stat plots are displayed on the current graph. To define the viewing window, press **WINDOW** and enter values for the window variables. **ZoomStat** redefines the viewing window to display all statistical data points.

Tracing a Stat Plot

When you trace a scatter plot or xyLine, tracing begins at the first element in the lists.

When you trace a histogram, the cursor moves from the top center of one column to the top center of the next, starting at the first column.

When you trace a box plot, tracing begins at **Med** (the median). Press **◀** to trace to **Q1** and **minX**. Press **▶** to trace to **Q3** and **maxX**.

When you press **▲** or **▼** to move to another plot or to another Y= function, tracing moves to the current or beginning point on that plot (not the nearest pixel).

The **ExprOn/ExprOff** format setting applies to stat plots (Chapter 3). When **ExprOn** is selected, the plot number and plotted data lists are displayed in the top-left corner.

Statistical Plotting in a Program

Defining a Stat Plot in a Program

To display a stat plot from a program, define the plot, and then display the graph.

To define a stat plot from a program, begin on a blank line in the program editor and enter data into one or more lists; then, follow these steps.

1. Press $\boxed{2nd}$ [STAT PLOT] to display the **STAT PLOTS** menu.

```
STAT PLOTS TYPE MARK
1:Plot1(
2:Plot2(
3:Plot3(
4:PlotsOff
5:PlotsOn
```

2. Select the plot to define, which pastes **Plot1(**, **Plot2(**, or **Plot3(** to the cursor location.

```
PROGRAM:PLOT
:(1,2,3,4)→L1
:(5,6,7,8)→L2
:Plot2(■
```

3. Press $\boxed{2nd}$ [STAT PLOT] $\boxed{\blacktriangleright}$ to display the **STAT TYPE** menu.

```
PLOTS TYPE MARK
1:Scatter
2:xyLine
3:Histogram
4:ModBoxPlot
5:BoxPlot
6:NormProbPlot
```

4. Select the type of plot, which pastes the name of the plot type to the cursor location.

```
PROGRAM:PLOT
:(1,2,3,4)→L1
:(5,6,7,8)→L2
:Plot2(Scatter■
```

5. Press \square . Enter the list names, separated by commas.
6. Press \square \square [2nd] [STAT PLOT] \square to display the **STAT PLOT MARK** menu. (This step is not necessary if you selected **3:Histogram** or **5:Boxplot** in step 4.)

```
PLOTS TYPE MARK
1: □
2: +
3: •
```

Select the type of mark (\square or $+$ or \bullet) for each data point. The selected mark symbol is pasted to the cursor location.

7. Press \square [ENTER] to complete the command line.

```
PROGRAM:PLOT
:(1,2,3,4) $\rightarrow$ L1
:(5,6,7,8) $\rightarrow$ L2
:Plot2(Scatter,L
1,L2,□)
:■
```

Displaying a Stat Plot from a Program

To display a plot from a program, use the **DispGraph** instruction (Chapter 16) or any of the **ZOOM** instructions (Chapter 3).

```
PROGRAM:PLOT
:(1,2,3,4) $\rightarrow$ L1
:(5,6,7,8) $\rightarrow$ L2
:Plot2(Scatter,L
1,L2,□)
:DispGraph
:■
```

```
PROGRAM:PLOT
:(1,2,3,4) $\rightarrow$ L1
:(5,6,7,8) $\rightarrow$ L2
:Plot2(Scatter,L
1,L2,□)
:ZoomStat
:■
```

Chapter 13: Inferential Statistics and Distributions

Getting Started: Mean Height of a Population

Getting Started is a fast-paced introduction. Read the chapter for details.

Suppose you want to estimate the mean height of a population of women given the random sample below. Because heights among a biological population tend to be normally distributed, a t distribution confidence interval can be used when estimating the mean. The 10 height values below are the first 10 of 90 values, randomly generated from a normally distributed population with an assumed mean of 165.1 centimeters and a standard deviation of 6.35 centimeters (**randNorm(165.1,6.35,90)** with a seed of 789).

Height (in centimeters) of Each of 10 Women

169.43 168.33 159.55 169.97 159.79 181.42 171.17 162.04 167.15 159.53

1. Press **[STAT]** **[ENTER]** to display the stat list editor.

Press **[↑]** to move the cursor onto **L1**, and then press **[2nd]** **[INS]**. The **Name=** prompt is displayed on the bottom line. The **α** cursor indicates that alpha-lock is on. The existing list name columns shift to the right.

	L1	L2	1
	-----	-----	
Name=			

Note: Your stat editor may not look like the one pictured here, depending on the lists you have already stored.

- Enter **[H] [G] [H] [T]** at the **Name=** prompt, and then press **[ENTER]**. The list to which you will store the women's height data is created.

Press **[↓]** to move the cursor onto the first row of the list. **HGHT(1)=** is displayed on the bottom line.

HGHT	L1	L2	1
██████	-----	-----	
HGHT(1) =			

- Press **169 [.] 43** to enter the first height value. As you enter it, it is displayed on the bottom line.

Press **[ENTER]**. The value is displayed in the first row, and the rectangular cursor moves to the next row.

HGHT	L1	L2	3
159.79			
181.42			
171.17			
162.04			
167.15			
159.53			
██████			
HGHT(11) =			

Enter the other nine height values the same way.

- Press **[STAT] [↓]** to display the **STAT TESTS** menu, and then press **[↓]** until **8:TInterval** is highlighted.

EDIT	CALC	TESTS
2:T-Test...		
3:2-SampZTest...		
4:2-SampTTest...		
5:1-PropZTest...		
6:2-PropZTest...		
7:ZInterval...		
8:TInterval...		

- Press **[ENTER]** to select **8:TInterval**. The inferential stat editor for **TInterval** is displayed. If **Data** is not selected for **Inpt:**, press **[↓] [ENTER]** to select **Data**.

Press **[↓]** and **[H] [G] [H] [T]** at the **List:** prompt (alpha-lock is on).

Press **[↓] [↓] [.] 99** to enter a 99 percent confidence level at the **C-Level:** prompt.

TInterval
Inpt: [Data] Stats
List: HGHT
Freq: 1
C-Level: .99
Calculate

6. Press \square to move the cursor onto **Calculate**, and then press \square . The confidence interval is calculated, and the **TInterval** results are displayed on the home screen.

```
TInterval
(159.74,173.94)
x̄=166.838
Sx=6.907879237
n=10
```

Interpret the results.

The first line, **(159.74,173.94)**, shows that the 99 percent confidence interval for the population mean is between about 159.74 centimeters and 173.94 centimeters. This is about a 14.2 centimeters spread.

The .99 confidence level indicates that in a very large number of samples, we expect 99 percent of the intervals calculated to contain the population mean. The actual mean of the population sampled is 165.1 centimeters, which is in the calculated interval.

The second line gives the mean height of the sample \bar{x} used to compute this interval. The third line gives the sample standard deviation **Sx**. The bottom line gives the sample size **n**.

To obtain a more precise bound on the population mean μ of women's heights, increase the sample size to 90. Use a sample mean \bar{x} of 163.8 and sample standard deviation **Sx**

of 7.1 calculated from the larger random sample. This time, use the **Stats** (summary statistics) input option.

7. Press **STAT** **↓** **8** to display the inferential stat editor for **TInterval**.

Press **▶** **ENTER** to select **Inpt:Stats**. The editor changes so that you can enter summary statistics as input.

```
TInterval
Inpt:Data Stats
x̄:166.838
Sx:6.907879237...
n:10
C-Level:.99
Calculate
```

8. Press **▼** **163** **.** **8** **ENTER** to store 163.8 to \bar{x} .

Press **7** **.** **1** **ENTER** to store 7.1 to **Sx**.

Press **90** **ENTER** to store 90 to **n**.

```
TInterval
Inpt:Data Stats
x̄:163.8
Sx:7.1
n:90
C-Level:.99
Calculate
```

9. Press **▼** to move the cursor onto **Calculate**, and then press **ENTER** to calculate the new 99 percent confidence interval. The results are displayed on the home screen.

```
TInterval
(161.83, 165.77)
x̄=163.8
Sx=7.1
n=90
```

If the height distribution among a population of women is normally distributed with a mean μ of 165.1 centimeters and a standard deviation σ of 6.35 centimeters, what height is exceeded by only 5 percent of the women (the 95th percentile)?

10. Press **CLEAR** to clear the home screen.

Press **2nd** **[DISTR]** to display the **DISTR** (distributions) menu.

```
DISTR DRAW
1:normalpdf(
2:normalcdf(
3:invNorm(
4:invT(
5:tpdf(
6:tcdf(
7:χ²pdf(
```

11. Press **3** to paste **invNorm(** to the home screen.

Press **.** **95** **,** **165** **.** **1** **,** **6** **.** **35** **)** **ENTER**.

.95 is the area, 165.1 is μ , and 6.35 is σ .

```
invNorm(.95,165.
1,6.35)
      175.5448205
█
```

The result is displayed on the home screen; it shows that five percent of the women are taller than 175.5 centimeters.

Now graph and shade the top 5 percent of the population.

12. Press **WINDOW** and set the window variables to these values.

Xmin=145 **Ymin=-.02** **Xres=1**
Xmax=185 **Ymax=.08**
Xscl=5 **Yscl=0**

```
WINDOW
Xmin=145
Xmax=185
Xscl=5
Ymin=-.02
Ymax=.08
Yscl=0
Xres=1
```

13. Press 2nd [DISTR] \blacktriangleright to display the **DISTR DRAW** menu.

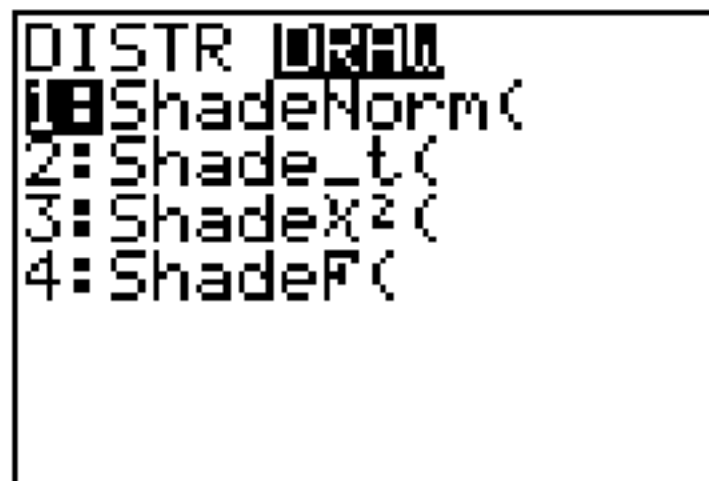

```
DISTR DRAW
1: ShadeNorm(
2: Shade_t(
3: ShadeX^2(
4: ShadeF(
```

14. Press ENTER to paste **ShadeNorm(** to the home screen.

Press 2nd [ANS] , 1 2nd [EE] 99 , 165 . 1 , 6 . 35) .

Ans (175.5448205 from step 11) is the lower bound. 1E99 is the upper bound. The normal curve is defined by a mean μ of 165.1 and a standard deviation σ of 6.35.

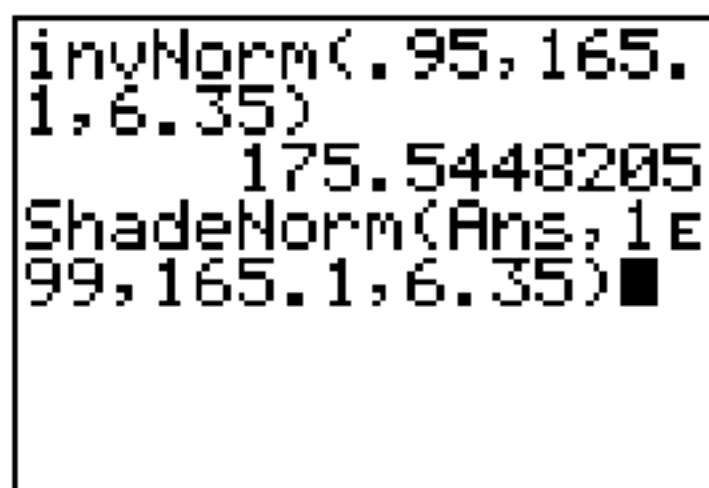

```
invNorm(.95, 165.1, 6.35)
175.5448205
ShadeNorm(Ans, 1E
99, 165.1, 6.35)
```

15. Press ENTER to plot and shade the normal curve.

Area is the area above the 95th percentile. **low** is the lower bound. **up** is the upper bound.

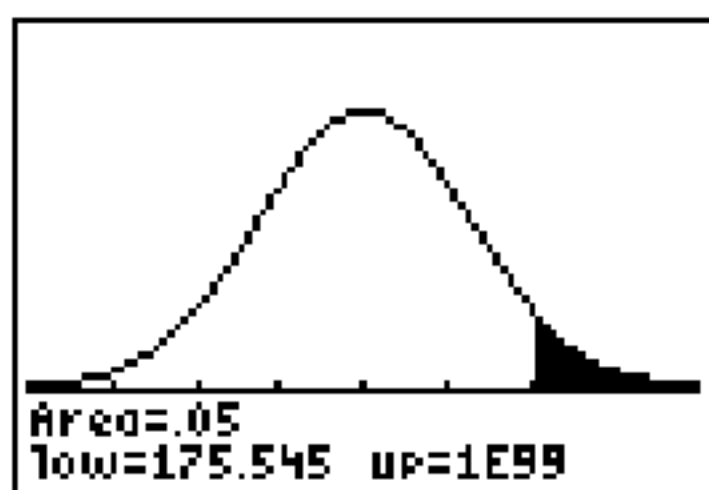

Inferential Stat Editors

Displaying the Inferential Stat Editors

When you select a hypothesis test or confidence interval instruction from the home screen, the appropriate inferential statistics editor is displayed. The editors vary

according to each test or interval's input requirements. Below is the inferential stat editor for **T-Test**.

```
T-Test
Inpt: DATA Stats
 $\mu_0$ : 0
List: L1
Frea: 1
 $\mu$ :  $\neq$   $<\mu_0$   $>\mu_0$ 
Calculate Draw
```

Note: When you select the **ANOVA(** instruction, it is pasted to the home screen. **ANOVA(** does not have an editor screen.

Using an Inferential Stat Editor

To use an inferential stat editor, follow these steps.

1. Select a hypothesis test or confidence interval from the **STAT TESTS** menu. The appropriate editor is displayed.
2. Select **Data** or **Stats** input, if the selection is available. The appropriate editor is displayed.
3. Enter real numbers, list names, or expressions for each argument in the editor.
4. Select the alternative hypothesis (\neq , $<$, or $>$) against which to test, if the selection is available.
5. Select **No** or **Yes** for the **Pooled** option, if the selection is available.
6. Select **Calculate** or **Draw** (when **Draw** is available) to execute the instruction.
 - When you select **Calculate**, the results are displayed on the home screen.
 - When you select **Draw**, the results are displayed in a graph.

This chapter describes the selections in the above steps for each hypothesis test and confidence interval instruction.

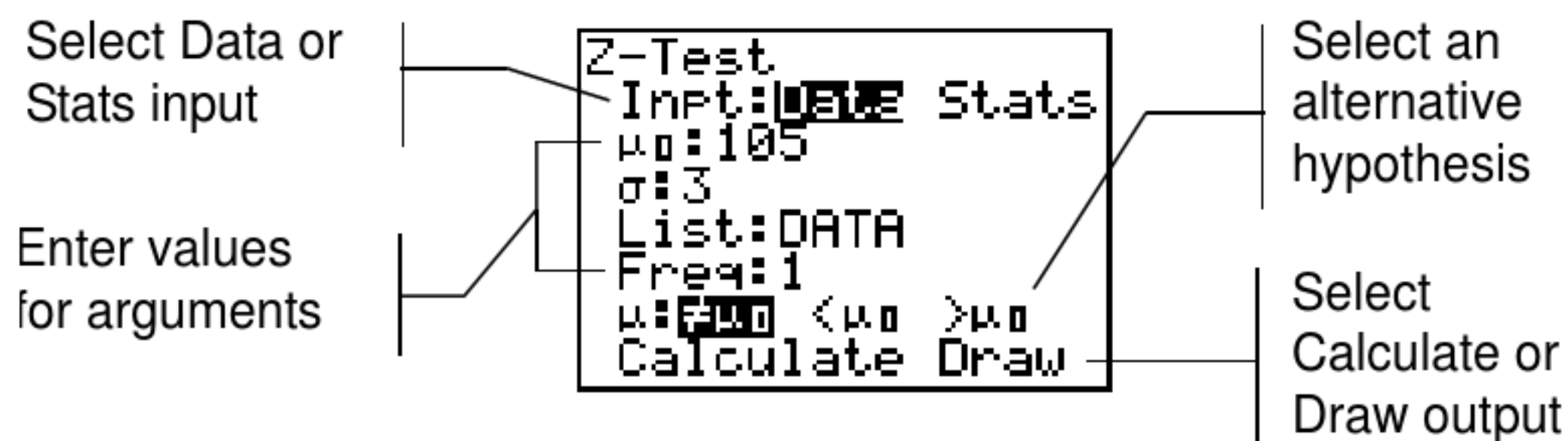

Selecting Data or Stats

Most inferential stat editors prompt you to select one of two types of input. (**1-PropZInt** and **2-PropZTest**, **1-PropZInt** and **2-PropZInt**, χ^2 -Test, χ^2 GOF-Test, **LinRegTInt**, and **LinRegTTest** do not.)

- Select **Data** to enter the data lists as input.
- Select **Stats** to enter summary statistics, such as \bar{x} , **Sx**, and **n**, as input.

To select **Data** or **Stats**, move the cursor to either **Data** or **Stats**, and then press **ENTER**.

Entering the Values for Arguments

Inferential stat editors require a value for every argument. If you do not know what a particular argument symbol represents, see the Inferential Statistics Input Descriptions tables.

When you enter values in any inferential stat editor, the TI-84 Plus stores them in memory so that you can run many tests or intervals without having to reenter every value.

Selecting an Alternative Hypothesis (\neq $<$ $>$)

Most of the inferential stat editors for the hypothesis tests prompt you to select one of three alternative hypotheses.

- The first is a \neq alternative hypothesis, such as $\mu \neq \mu_0$ for the **Z-Test**.
- The second is a $<$ alternative hypothesis, such as $\mu_1 < \mu_2$ for the **2-SampTTest**.
- The third is a $>$ alternative hypothesis, such as $p_1 > p_2$ for the **2-PropZTest**.

To select an alternative hypothesis, move the cursor to the appropriate alternative, and then press **ENTER**.

Selecting the Pooled Option

Pooled (**2-SampTTest** and **2-SampTInt** only) specifies whether the variances are to be pooled for the calculation.

- Select **No** if you do not want the variances pooled. Population variances can be unequal.
- Select **Yes** if you want the variances pooled. Population variances are assumed to be equal.

To select the **Pooled** option, move the cursor to **Yes**, and then press **ENTER**.

Selecting Calculate or Draw for a Hypothesis Test

After you have entered all arguments in an inferential stat editor for a hypothesis test, you must select whether you want to see the calculated results on the home screen (**Calculate**) or on the graph screen (**Draw**).

- **Calculate** calculates the test results and displays the outputs on the home screen.
- **Draw** draws a graph of the test results and displays the test statistic and p-value with the graph. The window variables are adjusted automatically to fit the graph.

To select **Calculate** or **Draw**, move the cursor to either **Calculate** or **Draw**, and then press `ENTER`. The instruction is immediately executed.

Selecting Calculate for a Confidence Interval

After you have entered all arguments in an inferential stat editor for a confidence interval, select **Calculate** to display the results. The **Draw** option is not available.

When you press `ENTER`, **Calculate** calculates the confidence interval results and displays the outputs on the home screen.

Bypassing the Inferential Stat Editors

To paste a hypothesis test or confidence interval instruction to the home screen without displaying the corresponding inferential stat editor, select the instruction you want from the **CATALOG** menu. Appendix A describes the input syntax for each hypothesis test and confidence interval instruction.

```
2-SampZTest(
```

Note: You can paste a hypothesis test or confidence interval instruction to a command line in a program. From within the program editor, select the instruction from either the **CATALOG** (Chapter 15) or the **STAT TESTS** menu.

STAT TESTS Menu

STAT TESTS Menu

To display the **STAT TESTS** menu, press `[STAT]` `[↓]`. When you select an inferential statistics instruction, the appropriate inferential stat editor is displayed.

Most **STAT TESTS** instructions store some output variables to memory. For a list of these variables, see the Test and Interval Output Variables table.

EDIT CALC TESTS

1: Z-Test...	Test for 1 μ , known σ
2: T-Test...	Test for 1 μ , unknown σ
3: 2-SampZTest...	Test comparing 2 μ 's, known σ 's
4: 2-SampTTest...	Test comparing 2 μ 's, unknown σ 's
5: 1-PropZTest...	Test for 1 proportion
6: 2-PropZTest...	Test comparing 2 proportions
7: ZInterval...	Confidence interval for 1 μ , known σ
8: TInterval...	Confidence interval for 1 μ , unknown σ
9: 2-SampZInt...	Confidence interval for difference of 2 μ 's, known σ 's

EDIT CALC TESTS

O:	2-SampTInt...	Confidence interval for difference of 2 μ 's, unknown σ 's
A:	1-PropZInt...	Confidence interval for 1 proportion
B:	2-PropZInt...	Confidence interval for difference of 2 proportions
C:	χ^2 -Test...	Chi-square test for 2-way tables
D:	χ^2 -GOF Test...	Chi-square Goodness of Fit test
E:	2-SampFTest...	Test comparing 2 σ 's
F:	LinRegTTest...	t test for regression slope and ρ
G:	LinRegTInt...	Confidence interval for linear regression slope coefficient b
H:	ANOVA (One-way analysis of variance

Note: When a new test or interval is computed, all previous output variables are invalidated.

Inferential Stat Editors for the STAT TESTS Instructions

In this chapter, the description of each **STAT TESTS** instruction shows the unique inferential stat editor for that instruction with example arguments.

- Descriptions of instructions that offer the **Data/Stats** input choice show both types of input screens.
- Descriptions of instructions that do not offer the **Data/Stats** input choice show only one input screen.

The description then shows the unique output screen for that instruction with the example results.

- Descriptions of instructions that offer the **Calculate/Draw** output choice show both types of screens: calculated and graphic results.
- Descriptions of instructions that offer only the **Calculate** output choice show the calculated results on the home screen.

Z-Test

Z-Test (one-sample z test; item 1) performs a hypothesis test for a single unknown population mean μ when the population standard deviation σ is known. It tests the null hypothesis $H_0: \mu = \mu_0$ against one of the alternatives below.

- $H_a: \mu \neq \mu_0$ ($\mu: \neq \mu_0$)
- $H_a: \mu < \mu_0$ ($\mu: < \mu_0$)
- $H_a: \mu > \mu_0$ ($\mu: > \mu_0$)

In the example:

L1={299.4 297.7 301 298.9 300.2 297}

Data

Stats

Input:

```
Z-Test
Inpt: Stats Stats
μ₀: 300
σ: 3
List: L1
Freq: 1
μ: ≠μ₀ <μ₀ >μ₀
Calculate Draw
```

```
Z-Test
Inpt: Data Stats
μ₀: 300
σ: 3
x̄: 299.0333
n: 6
μ: ≠μ₀ <μ₀ >μ₀
Calculate Draw
```



Calculated results:

```
Z-Test
μ < 300.0000
z = -.7893
p = .2150
x̄ = 299.0333
Sx = 1.5029
n = 6.0000
```

```
Z-Test
μ < 300.0000
z = -.7893
p = .2150
x̄ = 299.0333
n = 6.0000
```



Drawn results:

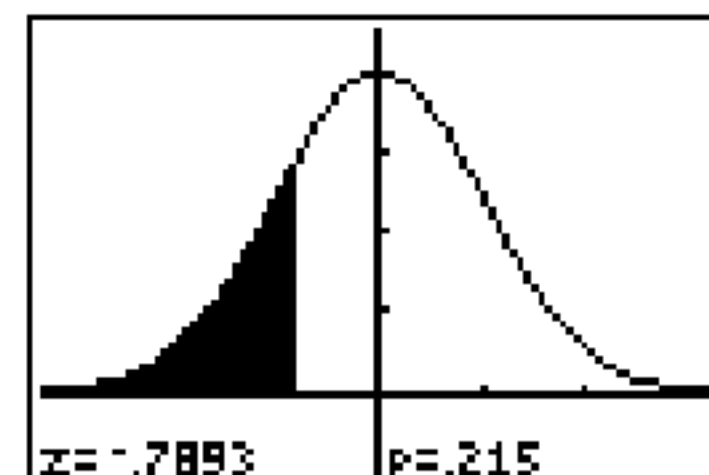
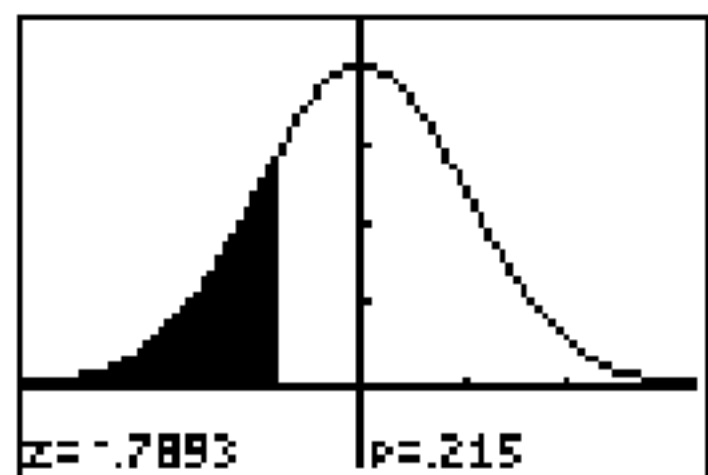

Note: All **STAT TESTS** examples assume a fixed-decimal mode setting of 4 (Chapter 1). If you set the decimal mode to **Float** or a different fixed-decimal setting, your output may differ from the output in the examples.

T-Test

T-Test (one-sample t test; item **2**) performs a hypothesis test for a single unknown population mean μ when the population standard deviation σ is unknown. It tests the null hypothesis $H_0: \mu = \mu_0$ against one of the alternatives below.

- $H_a: \mu \neq \mu_0$ ($\mu: \neq \mu_0$)
- $H_a: \mu < \mu_0$ ($\mu: < \mu_0$)
- $H_a: \mu > \mu_0$ ($\mu: > \mu_0$)

In the example:

TEST={91.9 97.8 111.4 122.3 105.4 95}

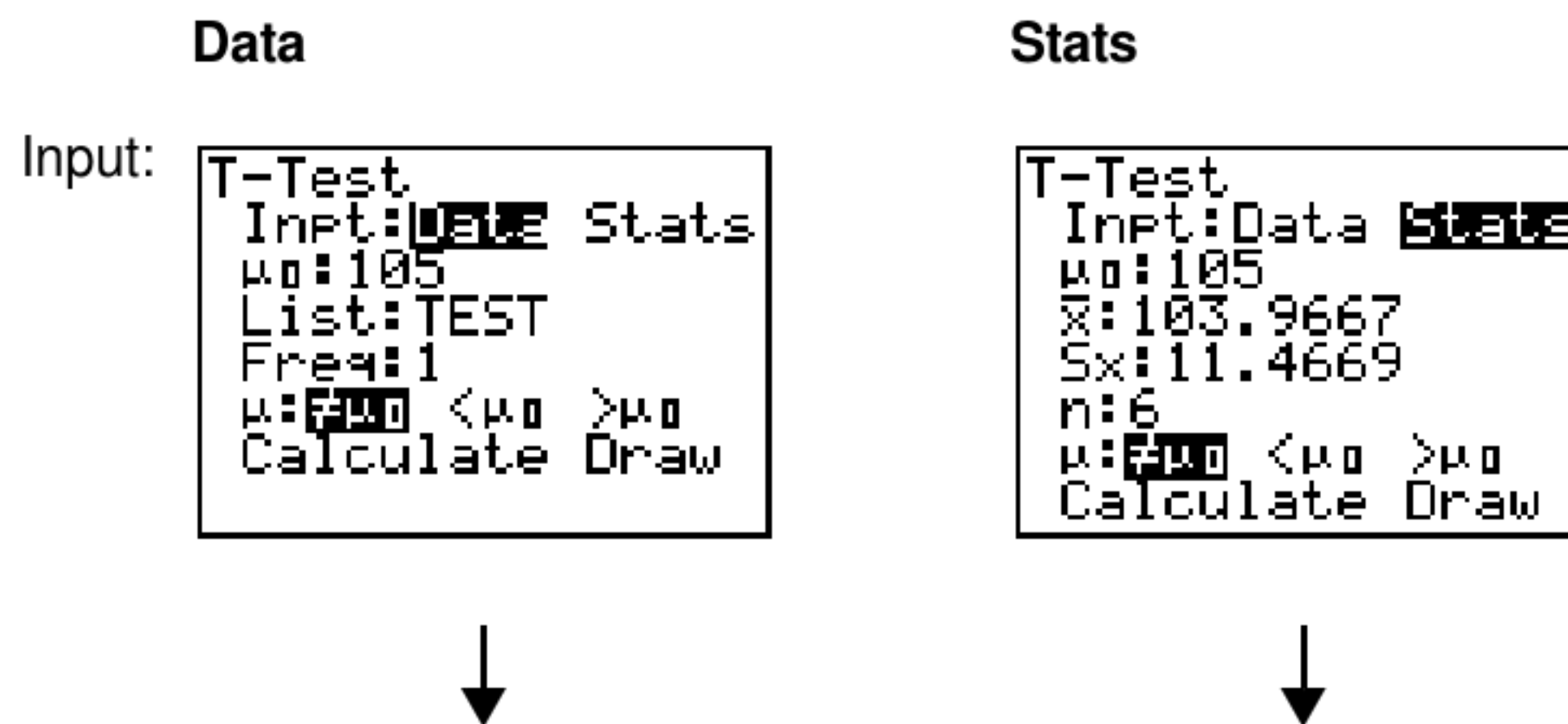

Data

Stats

Calculated
results:

```
T-Test
μ≠105.0000
t=-.2207
p=.8340
x̄=103.9667
Sx=11.4669
n=6.0000
```

```
T-Test
μ≠105.0000
t=-.2207
p=.8340
x̄=103.9667
Sx=11.4669
n=6.0000
```



Drawn
results:

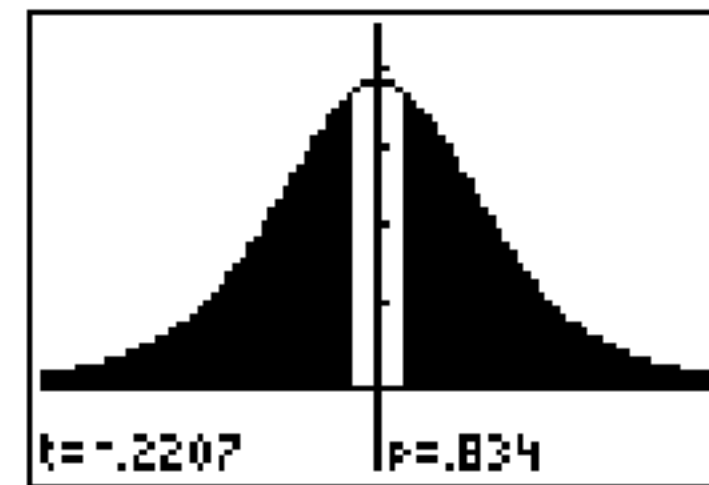
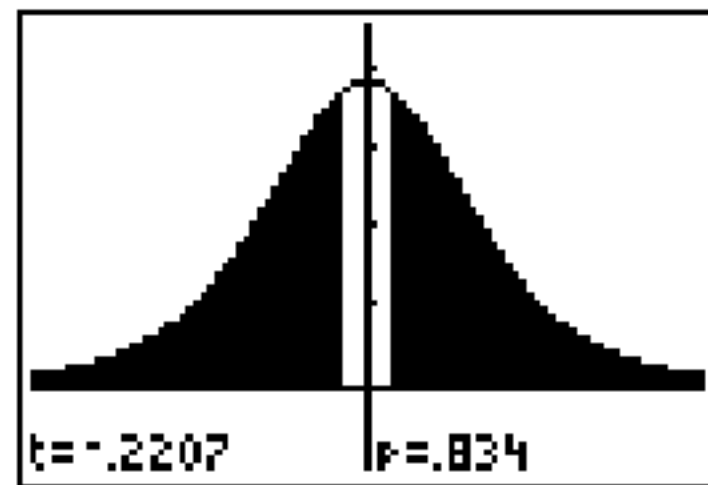

2-SampZTest

2-SampZTest (two-sample z test; item 3) tests the equality of the means of two populations (μ_1 and μ_2) based on independent samples when both population standard deviations (σ_1 and σ_2) are known. The null hypothesis $H_0: \mu_1 = \mu_2$ is tested against one of the alternatives below.

- $H_a: \mu_1 \neq \mu_2$ ($\mu_1 \neq \mu_2$)
- $H_a: \mu_1 < \mu_2$ ($\mu_1 < \mu_2$)
- $H_a: \mu_1 > \mu_2$ ($\mu_1 > \mu_2$)

In the example:

LISTA={154 109 137 115 140}

LISTB={108 115 126 92 146}

Data

Stats

Input:

```
2-SampZTest
Inpt: Stats Stats
σ1:15.5
σ2:13.5
List1:LISTA
List2:LISTB
Freq1:1
↓Freq2:1
```

```
2-SampZTest
Inpt:Data Stats
σ1:15.5
σ2:13.5
x̄1:131
n1:5
x̄2:117.4
↓n2:5
```

```
μ1:≠μ2 <μ2 >μ2
Calculate Draw
```

```
μ1:≠μ2 <μ2 >μ2
Calculate Draw
```



Calculated results:

```
2-SampZTest
μ1 > μ2
z=1.4795
P=.0695
x̄1=131.0000
x̄2=117.4000
↓Sx1=18.6145
```

```
2-SampZTest
μ1 > μ2
z=1.4795
P=.0695
x̄1=131.0000
x̄2=117.4000
↓n1=5.0000
```

```
Sx2=20.1941
n1=5.0000
n2=5.0000
```

```
n2=5.0000
```

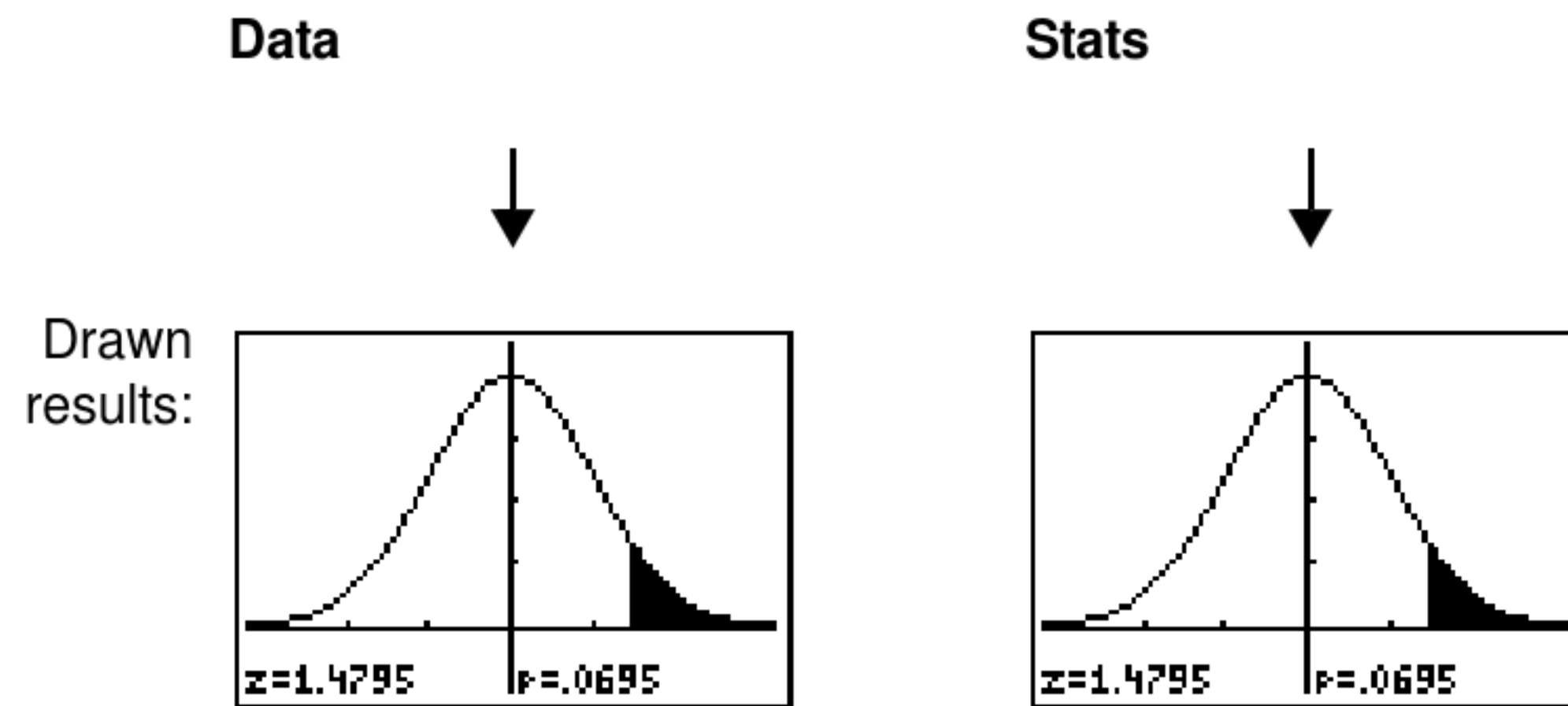

2-SampTTest

2-SampTTest (two-sample t test; item 4) tests the equality of the means of two populations (μ_1 and μ_2) based on independent samples when neither population standard deviation (σ_1 or σ_2) is known. The null hypothesis $H_0: \mu_1 = \mu_2$ is tested against one of the alternatives below.

- $H_a: \mu_1 \neq \mu_2$ ($\mu_1: \neq \mu_2$)
- $H_a: \mu_1 < \mu_2$ ($\mu_1: < \mu_2$)
- $H_a: \mu_1 > \mu_2$ ($\mu_1: > \mu_2$)

In the example:

SAMP1={12.207 16.869 25.05 22.429 8.456 10.589}

SAMP2={11.074 9.686 12.064 9.351 8.182 6.642}

Data

Stats

Input:

```
2-SampTTest
Inpt: Stats Stats
List1: SAMP1
List2: SAMP2
Freq1: 1
Freq2: 1
 $\mu_1$ : ≠ <  $\mu_2$  >  $\mu_2$ 
↓ Pooled: No Yes
```

```
2-SampTTest
Inpt: Data Stats
 $\bar{x}_1$ : 15.9333
 $s_{x1}$ : 6.7014
n1: 6
 $\bar{x}_2$ : 9.4998
 $s_{x2}$ : 1.9501
↓ n2: 6
```

Calculate Draw

```
 $\mu_1$ : ≠ <  $\mu_2$  >  $\mu_2$ 
Pooled: No Yes
Calculate Draw
```



Calculated results:

```
2-SampTTest
 $\mu_1 \neq \mu_2$ 
t=2.2579
P=.0659
df=5.8408
 $\bar{x}_1$ =15.9333
↓  $\bar{x}_2$ =9.4998
```

```
2-SampTTest
 $\mu_1 \neq \mu_2$ 
t=2.2579
P=.0659
df=5.8408
 $\bar{x}_1$ =15.9333
↓  $\bar{x}_2$ =9.4998
```

```
 $s_{x1}$ =6.7014
 $s_{x2}$ =1.9501
n1=6.0000
n2=6.0000
```

```
 $s_{x1}$ =6.7014
 $s_{x2}$ =1.9501
n1=6.0000
n2=6.0000
```



Data

Stats

Drawn
results:

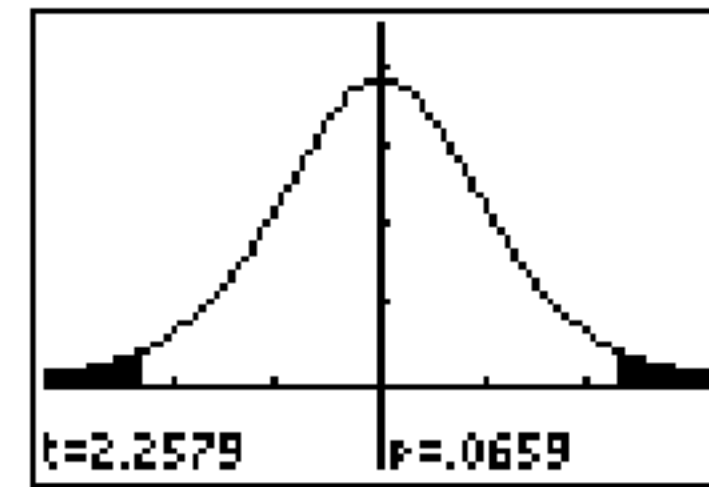
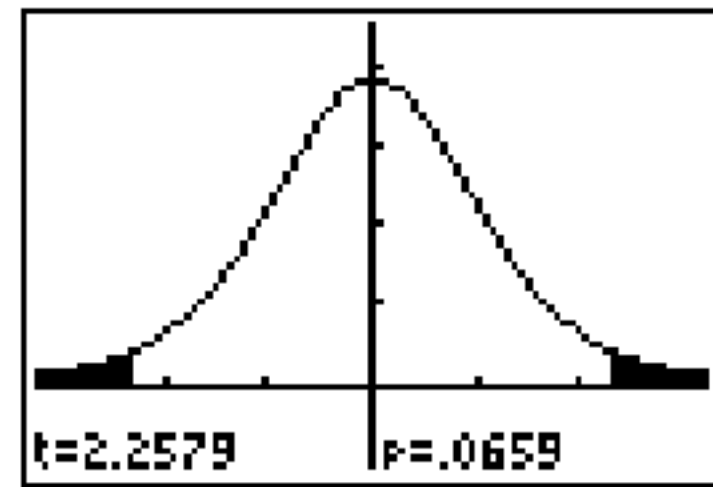

1-PropZTest

1-PropZTest (one-proportion z test; item 5) computes a test for an unknown proportion of successes (prop). It takes as input the count of successes in the sample x and the count of observations in the sample n . **1-PropZTest** tests the null hypothesis $H_0: \text{prop}=p_0$ against one of the alternatives below.

- $H_a: \text{prop} \neq p_0$ (**prop: $\neq p_0$**)
- $H_a: \text{prop} < p_0$ (**prop: $< p_0$**)
- $H_a: \text{prop} > p_0$ (**prop: $> p_0$**)

Input:

```
1-PropZTest
P0: .5
x: 2048
n: 4040
PROP  $\neq p_0$  <P0 >P0
Calculate Draw
```



Calculated
results:

```
1-PropZTest
Prop#: .5000
z= .8810
P= .3783
P̂= .5069
n= 4040.0000
```



Drawn
results:

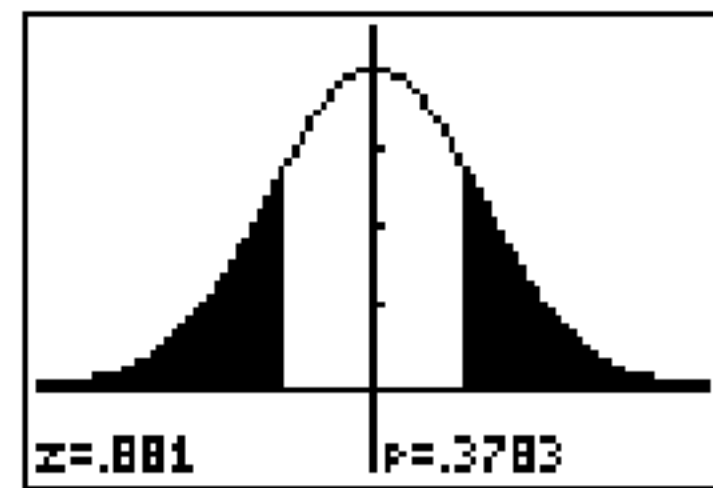

2-PropZTest

2-PropZTest (two-proportion z test; item 6) computes a test to compare the proportion of successes (p_1 and p_2) from two populations. It takes as input the count of successes in each sample (x_1 and x_2) and the count of observations in each sample (n_1 and n_2).

2-PropZTest tests the null hypothesis $H_0: p_1=p_2$ (using the pooled sample proportion \hat{p}) against one of the alternatives below.

- $H_a: p_1 \neq p_2$ (**p1:≠p2**)
- $H_a: p_1 < p_2$ (**p1:<p2**)

- $H_a: p_1 > p_2$ ($p_1 > p_2$)

Input:

```
2-PropZTest
x1:45
n1:61
x2:38
n2:62
P1:0.7377 <P2 >P2
Calculate Draw
```



Calculated results:

```
2-PropZTest
P1≠P2
z=1.4773
P=.1396
P1=.7377
P2=.6129
↓P=.6748
█
```

```
n1=61.0000
nz=62.0000
```



Drawn results:

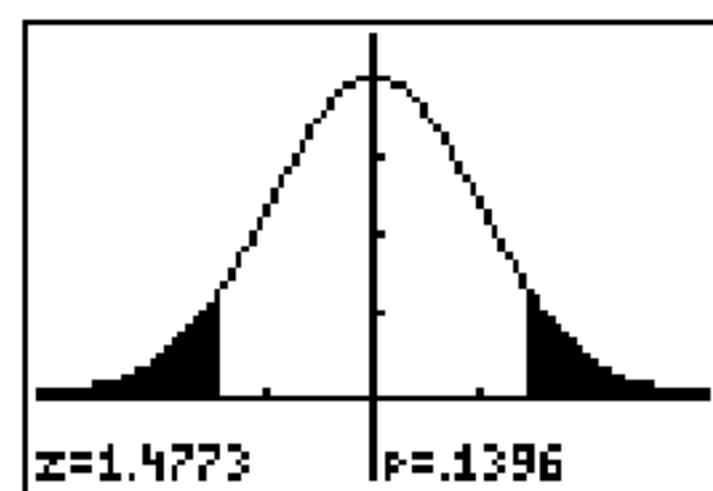

ZInterval

ZInterval (one-sample z confidence interval; item 7) computes a confidence interval for an unknown population mean μ when the population standard deviation σ is known. The computed confidence interval depends on the user-specified confidence level.

In the example:

$L1 = \{299.4 \ 297.7 \ 301 \ 298.9 \ 300.2 \ 297\}$

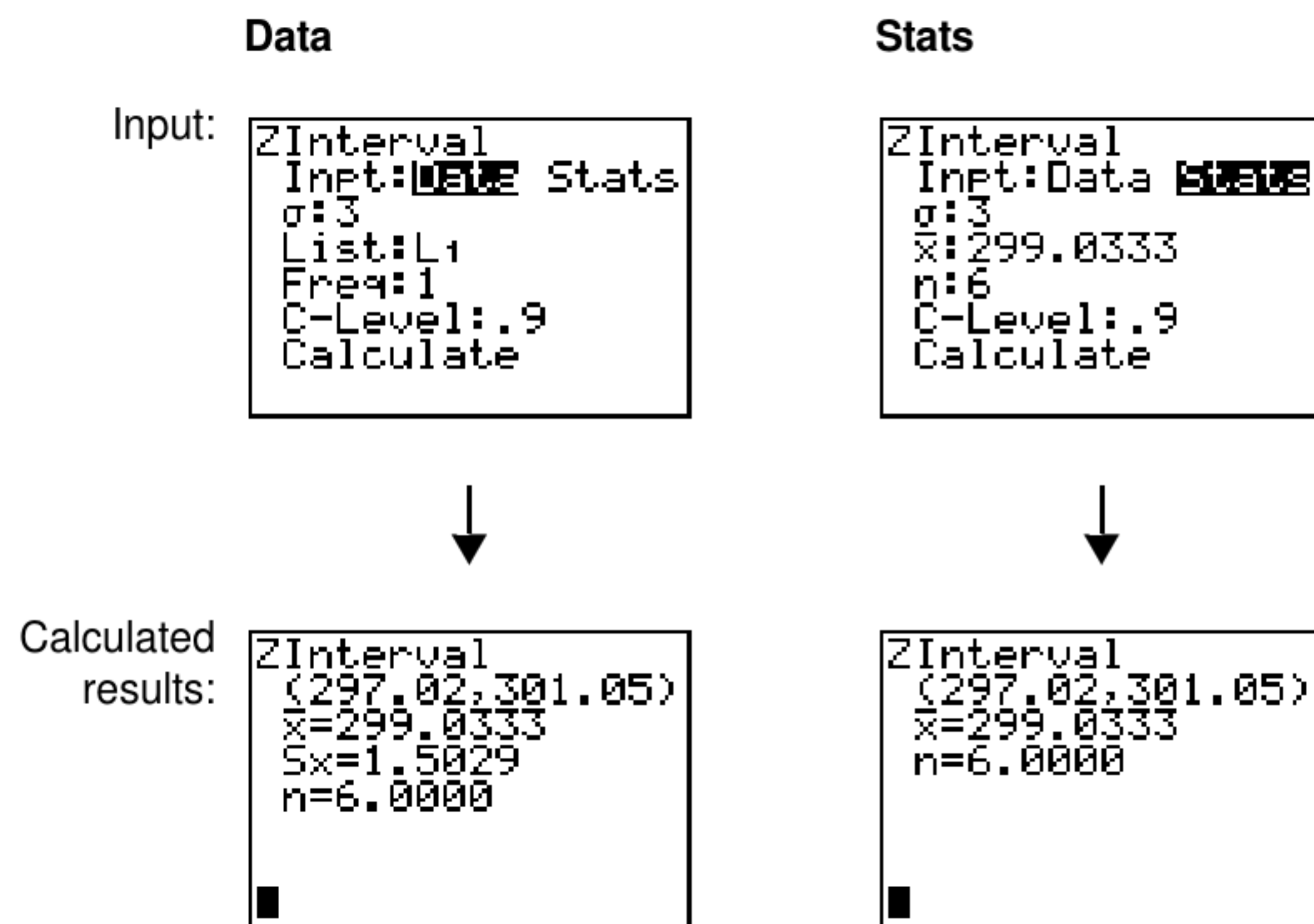

TInterval

TInterval (one-sample t confidence interval; item **8**) computes a confidence interval for an unknown population mean μ when the population standard deviation σ is unknown. The computed confidence interval depends on the user-specified confidence level.

In the example:

$L6 = \{1.6 \ 1.7 \ 1.8 \ 1.9\}$

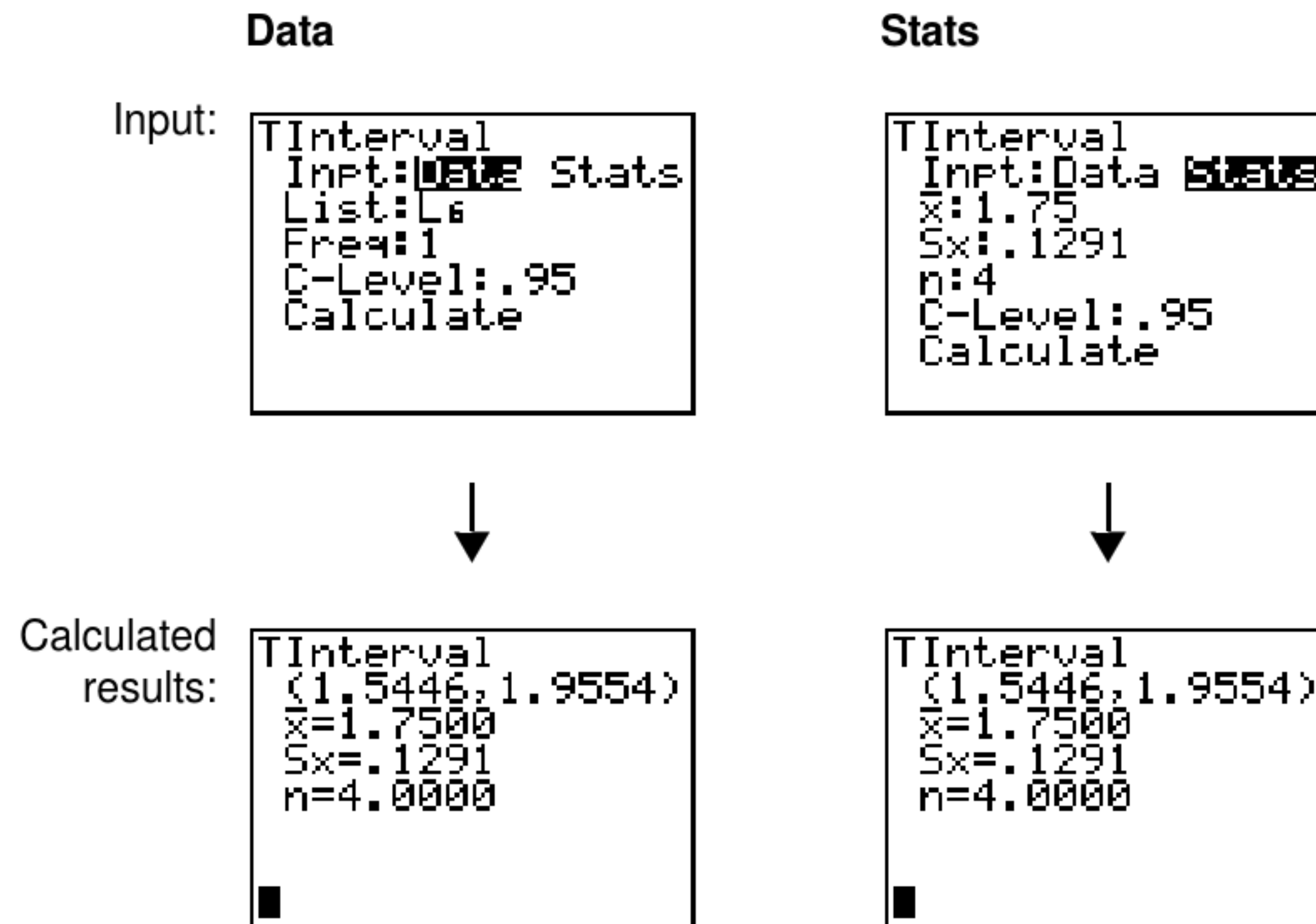

2-SampZInt

2-SampZInt (two-sample z confidence interval; item 9) computes a confidence interval for the difference between two population means ($\mu_1 - \mu_2$) when both population standard deviations (σ_1 and σ_2) are known. The computed confidence interval depends on the user-specified confidence level.

In the example:

LISTC={154 109 137 115 140}

LISTD={108 115 126 92 146}

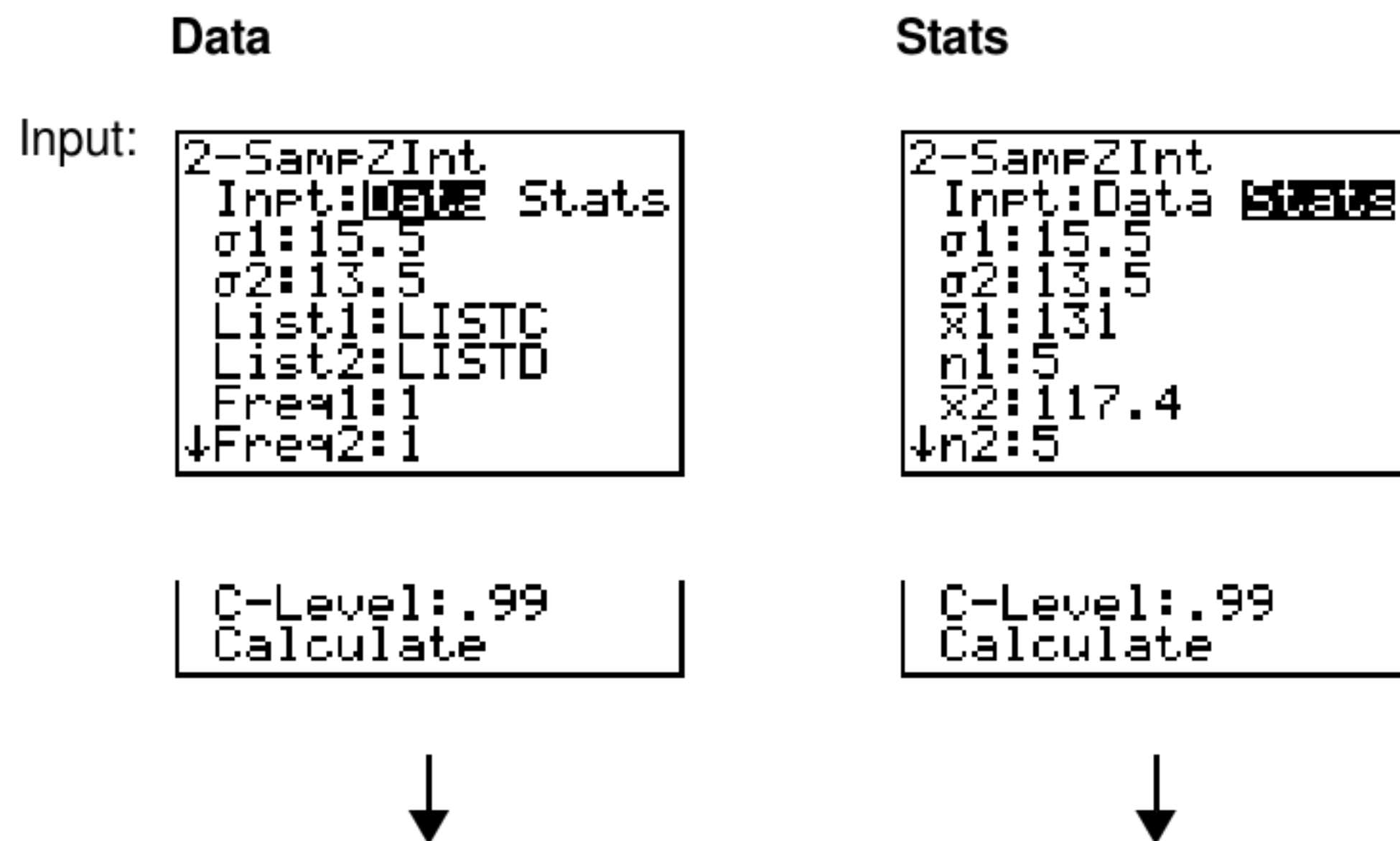

Data

Calculated
results:

```
2-SampZInt
(-10.08, 37.278)
x̄₁=131.0000
x̄₂=117.4000
sₓ₁=18.6145
sₓ₂=20.1941
↓n₁=5.0000
█
```

```
n₂=5.0000
█
```

Stats

```
2-SampZInt
(-10.08, 37.278)
x̄₁=131.0000
x̄₂=117.4000
n₁=5.0000
n₂=5.0000
█
```

2-SampTInt

2-SampTInt (two-sample t confidence interval; item **0**) computes a confidence interval for the difference between two population means ($\mu_1 - \mu_2$) when both population standard deviations (σ_1 and σ_2) are unknown. The computed confidence interval depends on the user-specified confidence level.

In the example:

SAMP1={12.207 16.869 25.05 22.429 8.456 10.589}

SAMP2={11.074 9.686 12.064 9.351 8.182 6.642}

Data

Stats

Input:

```
2-SampTInt
Inpt:  Data  Stats
List1: SAMP1
List2: SAMP2
Freq1: 1
Freq2: 1
C-Level: .95
↓ Pooled:  Yes
```

```
2-SampTInt
Inpt: Data  Stats
x1: 15.9333
Sx1: 6.7014
n1: 6
x2: 9.4998
Sx2: 1.9501
↓ n2: 6
```

Calculate

```
C-Level: .95
Pooled:  Yes
Calculate
```



Calculated results:

```
2-SampTInt
(-.5848, 13.452)
df=5.8408
x1=15.9333
x2=9.4998
Sx1=6.7014
↓ Sx2=1.9501
█
```

```
2-SampTInt
(-.5849, 13.452)
df=5.8408
x1=15.9333
x2=9.4998
Sx1=6.7014
↓ Sx2=1.9501
█
```

```
n1=6.0000
n2=6.0000
█
```

```
n1=6.0000
n2=6.0000
█
```

1-PropZInt

1-PropZInt (one-proportion z confidence interval; item **A**) computes a confidence interval for an unknown proportion of successes. It takes as input the count of successes in the sample x and the count of observations in the sample n . The computed confidence interval depends on the user-specified confidence level.

Input:

```
1-PropZInt
x: 2048
n: 4040
C-Level: .99
Calculate
```



Calculated results:

```
1-PropZInt
(.4867, .5272)
p̂ = .5069
n = 4040.0000
█
```

2-PropZInt

2-PropZInt (two-proportion z confidence interval; item **B**) computes a confidence interval for the difference between the proportion of successes in two populations ($p_1 - p_2$). It takes as input the count of successes in each sample (x_1 and x_2) and the count of

observations in each sample (n_1 and n_2). The computed confidence interval depends on the user-specified confidence level.

Input:

```
2-PropZInt
x1:49
n1:61
x2:38
n2:62
C-Level:.95
Calculate
```



Calculated results:

```
2-PropZInt
(.0334, .3474)
p1=.8033
p2=.6129
n1=61.0000
n2=62.0000
█
```

χ^2 -Test

χ^2 -Test (chi-square test; item **C**) computes a chi-square test for association on the two-way table of counts in the specified *Observed* matrix. The null hypothesis H_0 for a two-way table is: no association exists between row variables and column variables. The alternative hypothesis is: the variables are related.

Before computing a χ^2 -Test, enter the observed counts in a matrix. Enter that matrix variable name at the **Observed:** prompt in the χ^2 -Test editor; default=**[A]**. At the

Expected: prompt, enter the matrix variable name to which you want the computed expected counts to be stored; default=[B].

Matrix editor:

```
MATRIX[A] 3 x2
[ 5.0000 19.000 ]
[ 8.0000 16.000 ]
[ 11.000 13.000 ]
```

Note: Press $\boxed{2nd}$ \boxed{MATRX} $\boxed{\blacktriangleright}$ $\boxed{\blacktriangleright}$ $\boxed{1}$ to select 1:[A] from the **MATRIX EDIT** menu.

Input:

```
 $\chi^2$ -Test
Observed: [A]
Expected: [B]
Calculate Draw
```



Note: Press $\boxed{2nd}$ \boxed{MATRX} $\boxed{\blacktriangledown}$ \boxed{ENTER} to display matrix [B].

Calculated results:

```
 $\chi^2$ -Test
 $\chi^2=3.3750$ 
P=.1850
df=2.0000
```

```
[B]
[ 8.0000 16.000...
[ 8.0000 16.000...
[ 8.0000 16.000...
█
```



Drawn results:

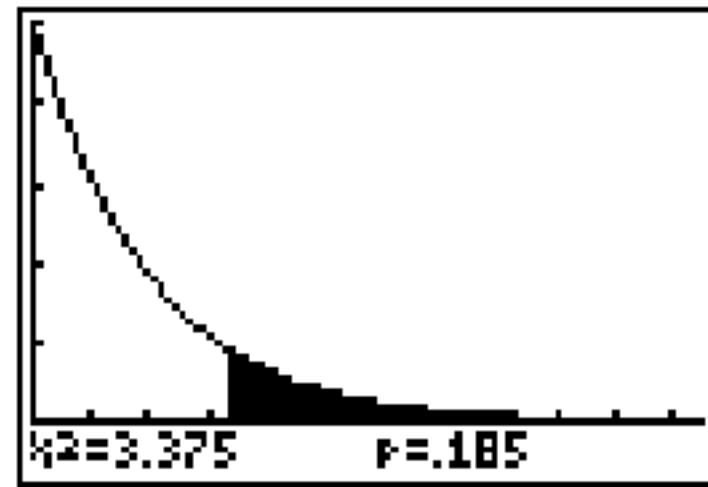

χ^2 GOF-Test

χ^2 GOF-Test (Chi Square Goodness of Fit; item D) performs a test to confirm that sample data is from a population that conforms to a specified distribution. For example, χ^2 GOF can confirm that the sample data came from a normal distribution.

In the example:

list 1={16,25,22,8,10}

list 2={16.2,21.6,16.2,14.4,12.6}

The Chi-square
Goodness of Fit
input screen:

```
χ²GOF-Test  
Observed: 01  
Expected: L2  
df: 4  
Calculate Draw
```

Note: Press **STAT** **▶** **▶** to select **TESTS**. Press **▼** several times to select **D:χ²GOF-Test...** Press **ENTER**. To enter data for df (degree of freedom), press **▼** **▼** **▼**. Type 4.



Calculated
results:

```
χ² GOF-Test  
χ²=5.995149912  
P=.1995107739  
df=4  
CNTRB=C.002469...
```



Drawn results:

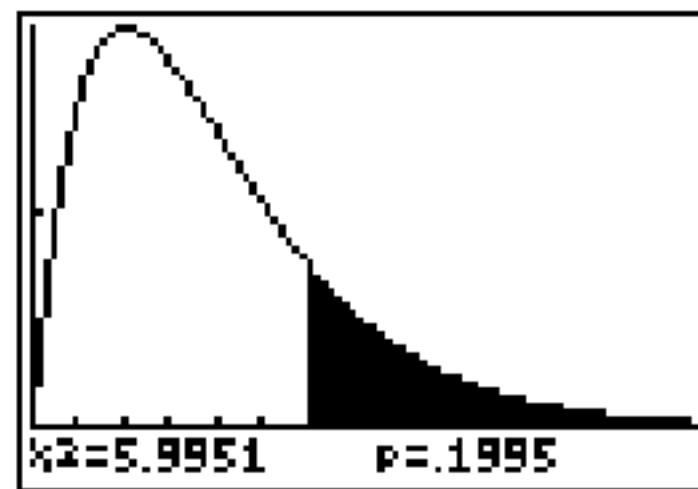

2-SampFTest

2-SampFTest (two-sample **F**-test; item **E**) computes an **F**-test to compare two normal population standard deviations (σ_1 and σ_2). The population means and standard deviations are all unknown. **2-SampFTest**, which uses the ratio of sample variances $Sx1^2/Sx2^2$, tests the null hypothesis $H_0: \sigma_1=\sigma_2$ against one of the alternatives below.

- $H_a: \sigma_1 \neq \sigma_2$ ($\sigma_1: \neq \sigma_2$)
- $H_a: \sigma_1 < \sigma_2$ ($\sigma_1: < \sigma_2$)
- $H_a: \sigma_1 > \sigma_2$ ($\sigma_1: > \sigma_2$)

In the example:

SAMP4={ 7 -4 18 17 -3 -5 1 10 11 -2}
SAMP5={ -1 12 -1 -3 3 -5 5 2 -11 -1 -3}

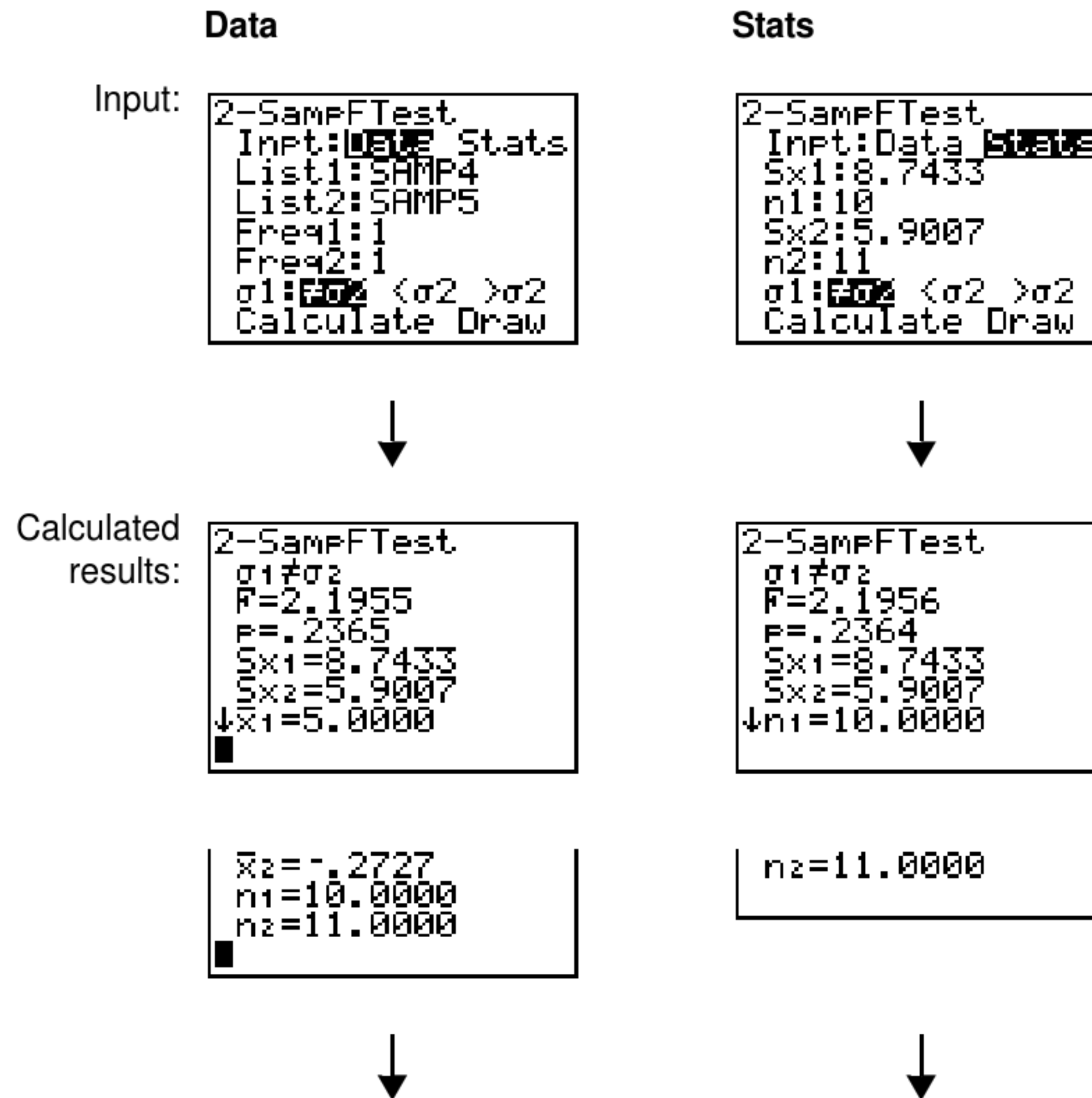

Data

Stats

Drawn results:

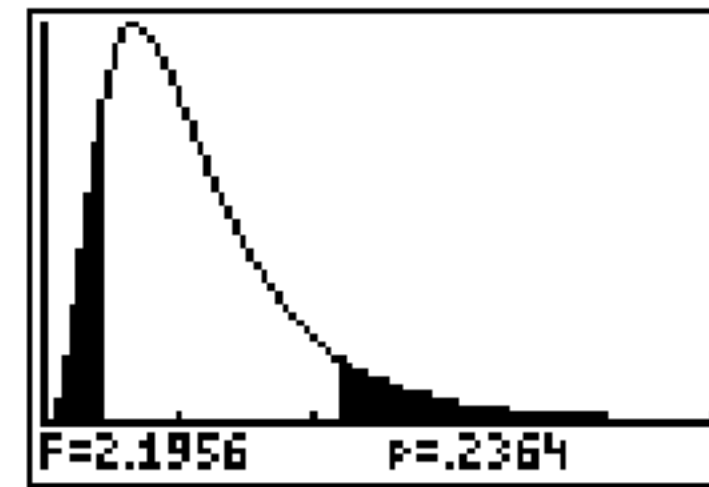
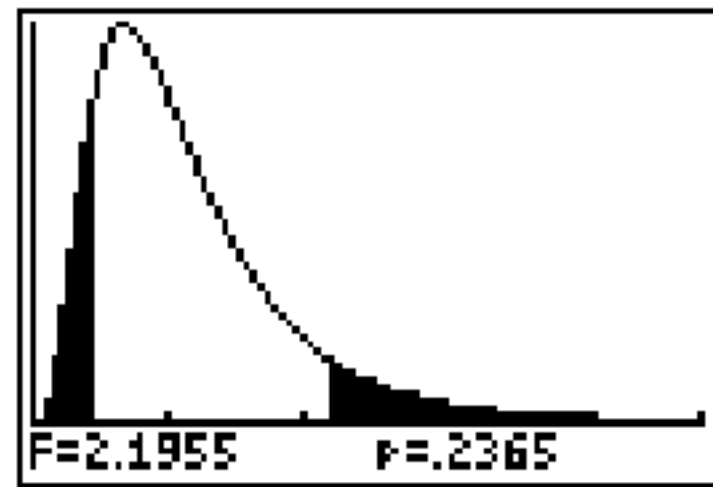

LinRegTTest

LinRegTTest (linear regression t test; item **F**) computes a linear regression on the given data and a t test on the value of slope β and the correlation coefficient ρ for the equation $y=\alpha+\beta x$. It tests the null hypothesis $H_0: \beta=0$ (equivalently, $\rho=0$) against one of the alternatives below.

- $H_a: \beta \neq 0$ and $\rho \neq 0$ (β & $\rho: \neq 0$)
- $H_a: \beta < 0$ and $\rho < 0$ (β & $\rho: < 0$)
- $H_a: \beta > 0$ and $\rho > 0$ (β & $\rho: > 0$)

The regression equation is automatically stored to **RegEQ** (**VARS Statistics EQ** secondary menu). If you enter a $Y=$ variable name at the **RegEQ:** prompt, the calculated regression equation is automatically stored to the specified $Y=$ equation. In the example below, the regression equation is stored to **Y1**, which is then selected (turned on).

In the example:

```
L3={ 38 56 59 64 74}
L4={ 41 63 70 72 84}
```

Input:

```

LinRegTTest
Xlist:L3
Ylist:L4
Freq:1
 $\beta$  &  $\rho$ :EQ <0 >0
RegEQ:Y1
Calculate

```



Calculated results:

```

LinRegTTest
y=a+bx
 $\beta \neq 0$  and  $\rho \neq 0$ 
t=15.9405
P=5.3684E-4
df=3.0000
↓a=-3.6596

```

```

Plot1 Plot2 Plot3
\Y1=-3.6596+1.19
69%
\Y2=
\Y3=
\Y4=
\Y5=
\Y6=

```

```

↑b=1.1969
s=1.9820
r2=.9883
r=.9941

```

When **LinRegTTest** is executed, the list of residuals is created and stored to the list name **RESID** automatically. **RESID** is placed on the **LIST NAMES** menu.

Note: For the regression equation, you can use the fix-decimal mode setting to control the number of digits stored after the decimal point (Chapter 1). However, limiting the number of digits to a small number could affect the accuracy of the fit.

LinRegTInt

LinRegTInt computes a linear regression T confidence interval for the slope coefficient b . If the confidence interval contains 0, this is insufficient evidence to indicate that the data exhibits a linear relationship.

In the example:

list 1={4, 5, 6, 7, 8}

list 2={1, 2, 3, 3.5, 4.5}

LinRegTInt input
screen:

```
LinRegTInt
Xlist:L1
Ylist:L2
Freq:1
C-Level:.95
RegEQ:
Calculate
```

Note: Press **[STAT]** **[>]** **[>]** to select **TESTS**. Press **[↓]** several times to select **G:LinRegTint...** Press **[ENTER]**. Press **[↓]** several times to select **Calculate**. Press **[ENTER]**.



Calculated
results:

```
LinRegTInt
y=a+bx
(.69088, 1.0091)
b=.85
df=3
s=.158113883
↓a=-2.3
```

```
↑df=3
s=.158113883
a=-2.3
r²=.9897260274
r=.9948497512
```

Xlist, Ylist is the list of independent and dependent variables. The list containing the **Freq** (frequency) values for the data is stored in **List**. The default is 1. All elements must be real numbers. Each element in the **Freq** list is the frequency of occurrence for each corresponding data point in the input list specified in the **List** fields. RegEQ (optional) is the designated Yn variable for storing the regression equation. StoreRegEqn (optional) is the designated variable for storing the regression equation. The C level is the Confidence level probability with default = .95.

ANOVA(

ANOVA((one-way analysis of variance; item **H**) computes a one-way analysis of variance for comparing the means of two to 20 populations. The **ANOVA** procedure for comparing these means involves analysis of the variation in the sample data. The null hypothesis $H_0: \mu_1 = \mu_2 = \dots = \mu_k$ is tested against the alternative H_a : not all $\mu_1 \dots \mu_k$ are equal.

ANOVA(*list1*,*list2*[,*...*],*list20*)

In the example:

L1={7 4 6 6 5}

L2={6 5 5 8 7}

L3={4 7 6 7 6}

Input:

```
ANOVA(L1,L2,L3)■
```



Calculated
results:

```
One-way ANOVA
F=.3111
p=.7384
Factor
df=2.0000
SS=.9333
↓ MS=.4667
█
```

```
Error
df=12.0000
SS=18.0000
MS=1.5000
SxP=1.2247
█
```

Note: **SS** is sum of squares and **MS** is mean square.

Inferential Statistics Input Descriptions

The tables in this section describe the inferential statistics inputs discussed in this chapter. You enter values for these inputs in the inferential stat editors. The tables present the inputs in the same order that they appear in this chapter.

Input	Description
μ_0	Hypothesized value of the population mean that you are testing.
σ	The known population standard deviation; must be a real number > 0 .

Input	Description
List	The name of the list containing the data you are testing.
Freq	The name of the list containing the frequency values for the data in List . Default=1. All elements must be integers ≥ 0 .
Calculate/Draw	Determines the type of output to generate for tests and intervals. Calculate displays the output on the home screen. In tests, Draw draws a graph of the results.
\bar{x} , Sx , n	Summary statistics (mean, standard deviation, and sample size) for the one-sample tests and intervals.
σ_1	The known population standard deviation from the first population for the two-sample tests and intervals. Must be a real number > 0 .
σ_2	The known population standard deviation from the second population for the two-sample tests and intervals. Must be a real number > 0 .
List1 , List2	The names of the lists containing the data you are testing for the two-sample tests and intervals. Defaults are L1 and L2 , respectively.
Freq1 , Freq2	The names of the lists containing the frequencies for the data in List1 and List2 for the two-sample tests and intervals. Defaults=1. All elements must be integers ≥ 0 .
\bar{x}_1 , Sx1 , n1 , \bar{x}_2 , Sx2 , n2	Summary statistics (mean, standard deviation, and sample size) for sample one and sample two in the two-sample tests and intervals.
Pooled	Specifies whether variances are to be pooled for 2-SampTTest and 2-SampTInt . No instructs the TI-84 Plus not to pool the variances. Yes instructs the TI-84 Plus to pool the variances.

Input	Description
p_0	The expected sample proportion for 1-PropZTest . Must be a real number, such that $0 < p_0 < 1$.
x	The count of successes in the sample for the 1-PropZTest and 1-PropZInt . Must be an integer ≥ 0 .
n	The count of observations in the sample for the 1-PropZTest and 1-PropZInt . Must be an integer > 0 .
x_1	The count of successes from sample one for the 2-PropZTest and 2-PropZInt . Must be an integer ≥ 0 .
x_2	The count of successes from sample two for the 2-PropZTest and 2-PropZInt . Must be an integer ≥ 0 .
n_1	The count of observations in sample one for the 2-PropZTest and 2-PropZInt . Must be an integer > 0 .
n_2	The count of observations in sample two for the 2-PropZTest and 2-PropZInt . Must be an integer > 0 .
C-Level	The confidence level for the interval instructions. Must be ≥ 0 and < 100 . If it is ≥ 1 , it is assumed to be given as a percent and is divided by 100. Default=0.95.
Observed (Matrix)	The matrix name that represents the columns and rows for the observed values of a two-way table of counts for the χ^2 - Test and χ^2 GOF-Test . Observed must contain all integers ≥ 0 . Matrix dimensions must be at least 2×2 .
Expected (Matrix)	The matrix name that specifies where the expected values should be stored. Expected is created upon successful completion of the χ^2 - Test and χ^2 GOF-Test .

Input	Description
df	df (degree of freedom) represents (number of sample categories) - (number of estimated parameters for the selected distribution + 1).
Xlist, Ylist	The names of the lists containing the data for LinRegTTest and LinRegTInt . Defaults are L1 and L2 , respectively. The dimensions of Xlist and Ylist must be the same.
RegEQ	The prompt for the name of the Y= variable where the calculated regression equation is to be stored. If a Y= variable is specified, that equation is automatically selected (turned on). The default is to store the regression equation to the RegEQ variable only.

Test and Interval Output Variables

The inferential statistics variables are calculated as indicated below. To access these variables for use in expressions, press **VAR** 5 (**5:Statistics**), and then select the **VAR** menu listed in the last column below.

Variables	Tests	Intervals	LinRegTTest, ANOVA	VAR Menu
p-value	p		p	TEST
test statistics	z, t, χ^2, F		t, F	TEST
degrees of freedom	df	df	df	TEST
sample mean of x values for sample 1 and sample 2	\bar{x}_1, \bar{x}_2	\bar{x}_1, \bar{x}_2		TEST
sample standard deviation of x for sample 1 and sample 2	Sx1, Sx2	Sx1, Sx2		TEST

Variables	Tests	Intervals	LinRegTTest, ANOVA	VARs Menu
number of data points for sample 1 and sample 2	n1, n2	n1, n2		TEST
pooled standard deviation	SxP	SxP	SxP	TEST
estimated sample proportion	\hat{p}	\hat{p}		TEST
estimated sample proportion for population 1	$\hat{p}1$	$\hat{p}1$		TEST
estimated sample proportion for population 2	$\hat{p}2$	$\hat{p}2$		TEST
confidence interval pair		lower, upper		TEST
mean of x values	\bar{x}	\bar{x}		XY
sample standard deviation of x	Sx	Sx		XY
number of data points	n	n		XY
standard error about the line			s	TEST
regression/fit coefficients			a, b	EQ
correlation coefficient			r	EQ
coefficient of determination			r2	EQ
regression equation			RegEQ	EQ

Note: The variables listed above cannot be archived.

Distribution Functions

DISTR menu

To display the DISTR menu, press $\boxed{2\text{nd}}$ [DISTR].

DISTR DRAW

1:	normalpdf (<i>nn</i> probability density function
2:	normalcdf (<i>nn</i> cumulative distribution function
3:	invNorm (Inverse cumulative normal distribution
4:	invT (Inverse cumulative Student- <i>t</i> distribution
5:	tpdf (Student- <i>t</i> probability density
6:	tcdf (Student- <i>t</i> distribution probability
7:	χ^2 pdf (Chi-square probability density
8:	χ^2 cdf	Chi-square distribution probability
9:	F pdf (F probability density
0:	F cdf (F distribution probability
A:	binompdf (Binomial probability

DISTR DRAW

B:	<code>binomcdf (</code>	Binomial cumulative density
C:	<code>poissonpdf (</code>	Poisson probability
D:	<code>poissoncdf (</code>	Poisson cumulative density
E:	<code>geometpdf (</code>	Geometric probability
F:	<code>geometcdf (</code>	Geometric cumulative density

Note: -1E99 and 1E99 specify infinity. If you want to view the area left of *upperbound*, for example, specify *lowerbound*= -1E99.

normalpdf(

normalpdf(computes the probability density function (**pdf**) for the normal distribution at a specified x value. The defaults are mean $\mu=0$ and standard deviation $\sigma=1$. To plot the normal distribution, paste **normalpdf(** to the Y= editor. The probability density function (pdf) is:

$$f(x) = \frac{1}{\sqrt{2\pi}\sigma} e^{-\frac{(x-\mu)^2}{2\sigma^2}}, \sigma > 0$$

normalpdf(x [, μ , σ])

```
Plot1 Plot2 Plot3
\Y1 normalpdf(X,
35, 2)
```

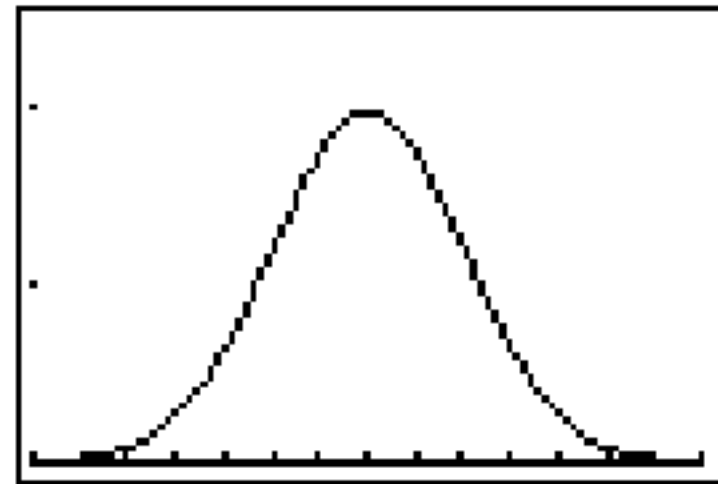

Note: For this example,

Xmin = 28

Xmax = 42

Ymin = 0

Ymax = .2

Xscl = 1

Yscl = .1

Note: For plotting the normal distribution, you can set window variables **Xmin** and **Xmax** so that the mean μ falls between them, and then select **0:ZoomFit** from the **ZOOM** menu.

normalcdf(

normalcdf(computes the normal distribution probability between *lowerbound* and *upperbound* for the specified mean μ and standard deviation σ . The defaults are $\mu=0$ and $\sigma=1$.

normalcdf(*lowerbound*,*upperbound* [, μ , σ])

```
normalcdf(-1E99,
36, 35, 2)
.6914624678
```

invNorm(

invNorm(computes the inverse cumulative normal distribution function for a given *area* under the normal distribution curve specified by mean μ and standard deviation σ . It calculates the *x* value associated with an *area* to the left of the *x* value. $0 \leq \text{area} \leq 1$ must be true. The defaults are $\mu=0$ and $\sigma=1$.

invNorm(area[, μ , σ])

```
invNorm(.6914624  
678.35,2)  
36.00000004
```

invT(

invT(computes the inverse cumulative Student-t probability function specified by Degree of Freedom, *df* for a given Area under the curve.

invT(area,df)

```
invT(.95,24)  
1.710882023
```

tpdf()

tpdf() computes the probability density function (**pdf**) for the Student- t distribution at a specified x value. df (degrees of freedom) must be > 0 . To plot the Student- t distribution, paste **tpdf()** to the Y= editor. The probability density function (**pdf**) is:

$$f(x) = \frac{\Gamma[(df+1)/2]}{\Gamma(df/2)} \frac{(1+x^2/df)^{-(df+1)/2}}{\sqrt{\pi df}}$$

tpdf(x,df)

```
Plot1 Plot2 Plot3
\Y1 tpdf(X,2)
```

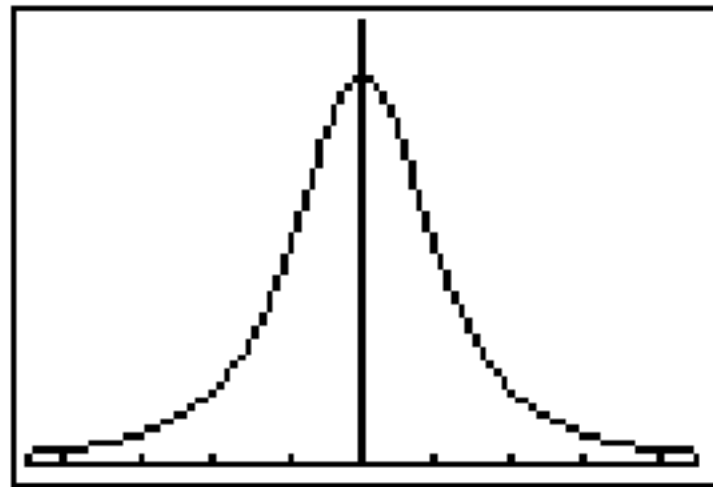

Note: For this example,

Xmin = -4.5

Xmax = 4.5

Ymin = 0

Ymax = .4

tcdf()

tcdf() computes the Student- t distribution probability between *lowerbound* and *upperbound* for the specified df (degrees of freedom), which must be > 0 .

tcdf(lowerbound,upperbound,df)

```
tcdf(-2,3,18)
.9657465644
```

χ^2 pdf()

χ^2 pdf() computes the probability density function (pdf) for the χ^2 (chi-square) distribution at a specified x value. df (degrees of freedom) must be an integer > 0 . To plot the χ^2 distribution, paste χ^2 pdf() to the Y= editor. The probability density function (pdf) is:

$$f(x) = \frac{1}{\Gamma(df/2)} (1/2)^{df/2} x^{df/2-1} e^{-x/2}, x \geq 0$$

χ^2 pdf(x, df)

```
Plot1 Plot2 Plot3
\Y1=X^2Pdf(X,9)
\Y2=X^2Pdf(X,7)
\Y3=
\Y4=
\Y5=
\Y6=
\Y7=
```

Note: For this example,
Xmin = 0
Xmax = 30
Ymin = -.02
Ymax = .132

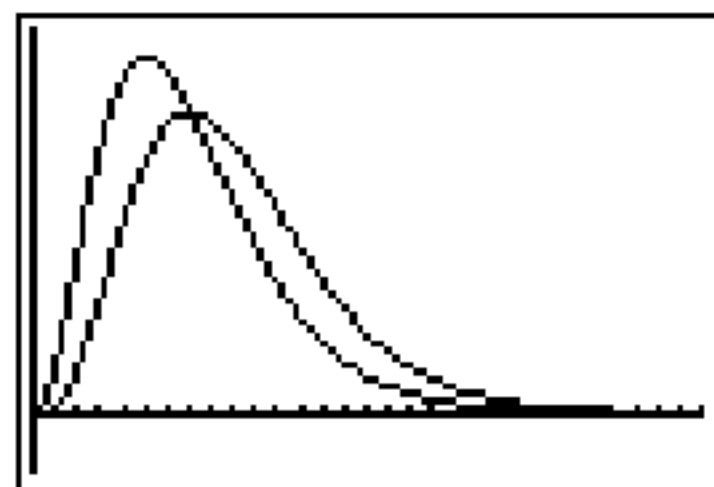

χ^2 cdf(

χ^2 cdf(computes the χ^2 (chi-square) distribution probability between *lowerbound* and *upperbound* for the specified *df* (degrees of freedom), which must be an integer > 0.

χ^2 cdf(lowerbound,upperbound,df)

```
χ²cdf(0,19.023,9)
.9750019601
```

Fpdf(

Fpdf(computes the probability density function (**pdf**) for the **F** distribution at a specified *x* value. *numerator df* (degrees of freedom) and *denominator df* must be integers > 0. To plot the **F** distribution, paste **Fpdf**(to the Y= editor. The probability density function (**pdf**) is:

$$f(x) = \frac{\Gamma[(n+d)/2]}{\Gamma(n/2)\Gamma(d/2)} \left(\frac{n}{d}\right)^{n/2} x^{n/2-1} (1+nx/d)^{-(n+d)/2}, x \geq 0$$

where n = numerator degrees of freedom
 d = denominator degrees of freedom

Fpdf(x , *numerator df*, *denominator df*)

```
Plot1 Plot2 Plot3
> Y1=Fpdf(X,24,19)
> █
```

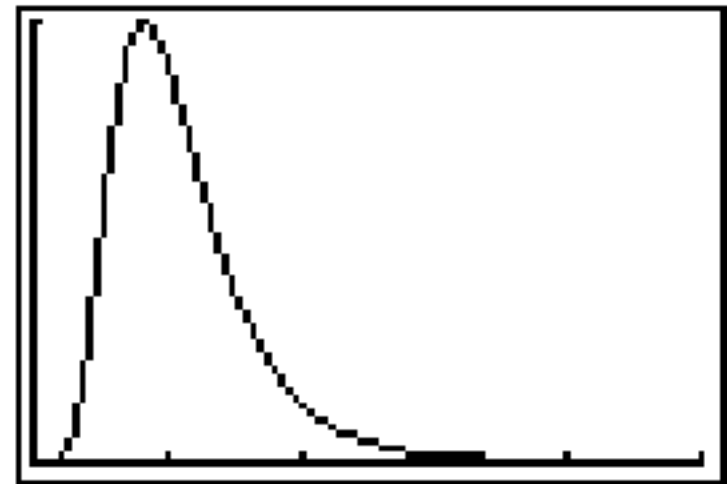

Note: For this example,

Xmin = 0

Xmax = 5

Ymin = 0

Ymax = 1

Fcdf(

Fcdf(computes the **F** distribution probability between *lowerbound* and *upperbound* for the specified *numerator df* (degrees of freedom) and *denominator df*. *numerator df* and *denominator df* must be integers > 0.

Fcdf(*lowerbound*, *upperbound*, *numerator df*, *denominator df*)

```
Fcdf(0,2.4523,24
,19)
.9749989576
```

binompdf

binompdf(computes a probability at x for the discrete binomial distribution with the specified *numtrials* and probability of success (p) on each trial. x can be an integer or a list

of integers. $0 \leq p \leq 1$ must be true. *numtrials* must be an integer > 0 . If you do not specify *x*, a list of probabilities from 0 to *numtrials* is returned. The probability density function (**pdf**) is:

$$f(x) = \binom{n}{x} p^x (1-p)^{n-x}, x = 0, 1, \dots, n$$

where $n = \text{numtrials}$

binompdf(*numtrials*,*p*[,*x*])

```
binompdf(5, .6, {3  
, 4, 5})  
{.3456 .2592 .0...
```

binomcdf(

binomcdf(computes a cumulative probability at *x* for the discrete binomial distribution with the specified *numtrials* and probability of success (*p*) on each trial. *x* can be a real number or a list of real numbers. $0 \leq p \leq 1$ must be true. *numtrials* must be an integer > 0 . If you do not specify *x*, a list of cumulative probabilities is returned.

binomcdf(*numtrials*,*p*[,*x*])

```
binomcdf(5, .6, {3  
, 4, 5})  
{.66304 .92224 ...
```

poissonpdf(

poissonpdf(computes a probability at x for the discrete Poisson distribution with the specified mean μ , which must be a real number > 0 . x can be an integer or a list of integers. The probability density function (**pdf**) is:

$$f(x) = e^{-\mu} \mu^x / x!, x = 0, 1, 2, \dots$$

poissonpdf(μ, x)

```
PoissonPdf(6, 10)
.0413030934
```

poissoncdf(

poissoncdf(computes a cumulative probability at x for the discrete Poisson distribution with the specified mean μ , which must be a real number > 0 . x can be a real number or a list of real numbers.

poissoncdf(μ, x)

```
Poissoncdf(.126,
{0, 1, 2, 3})
{.8816148468 .9...
```

geompdf(

geompdf(computes a probability at x , the number of the trial on which the first success occurs, for the discrete geometric distribution with the specified probability of success p .

$0 \leq p \leq 1$ must be true. x can be an integer or a list of integers. The probability density function (pdf) is:

$$f(x) = p(1-p)^{x-1}, x = 1, 2, \dots$$

geometpdf(p, x)

```
geometpdf(.4, 6)
.031104
```

geometcdf(

geometcdf(computes a cumulative probability at x , the number of the trial on which the first success occurs, for the discrete geometric distribution with the specified probability of success p . $0 \leq p \leq 1$ must be true. x can be a real number or a list of real numbers.

geometcdf(p, x)

```
geometcdf(.5, {1,
2, 3})
{.5 .75 .875}
```

Distribution Shading

DISTR DRAW Menu

To display the **DISTR DRAW** menu, press $\boxed{2nd}$ $\boxed{[DISTR]}$ $\boxed{\blacktriangleright}$. **DISTR DRAW** instructions draw various types of density functions, shade the area specified by *lowerbound* and *upperbound*, and display the computed area value.

To clear the drawings, select **1:ClrDraw** from the **DRAW** menu (Chapter 8).

Note: Before you execute a **DISTR DRAW** instruction, you must set the window variables so that the desired distribution fits the screen.

DISTR DRAW

- 1: ShadeNorm(Shades normal distribution.
 - 2: Shade_t(Shades Student-*t* distribution.
 - 3: Shade χ^2 (Shades χ^2 distribution.
 - 4: Shade**F**(Shades **F** distribution.
-

Note: -1E99 and 1E99 specify infinity. If you want to view the area left of *upperbound*, for example, specify *lowerbound*=-1E99.

ShadeNorm(

ShadeNorm(draws the normal density function specified by mean μ and standard deviation σ and shades the area between *lowerbound* and *upperbound*. The defaults are $\mu=0$ and $\sigma=1$.

ShadeNorm(*lowerbound*,*upperbound* [, μ , σ])

```
ShadeNorm(60,66,  
63.6,2.5)■
```

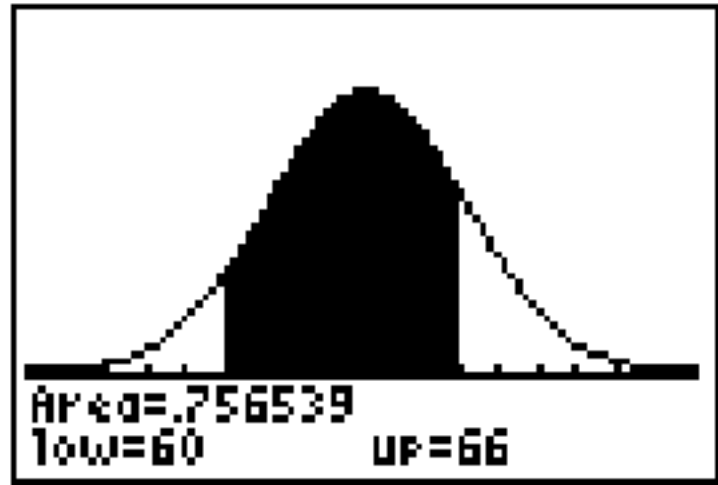

Note: For this example,
Xmin = 55
Xmax = 72
Ymin = -.05
Ymax = .2

Shade_t(

Shade_t(draws the density function for the Student-*t* distribution specified by *df* (degrees of freedom) and shades the area between *lowerbound* and *upperbound*.

Shade_t(*lowerbound*,*upperbound*,*df*)

```
Shade_t(-1,1E99,  
4)■
```

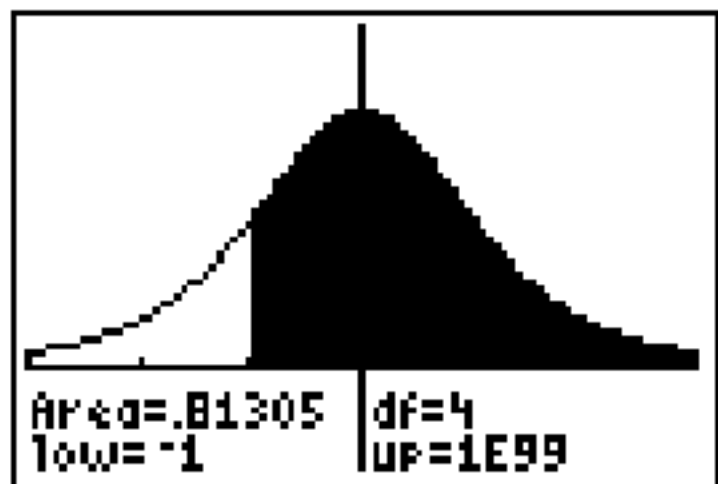

Note: For this example,
Xmin = -3
Xmax = 3
Ymin = -.15
Ymax = .5

Shade χ^2 (

Shade χ^2 (draws the density function for the χ^2 (chi-square) distribution specified by *df* (degrees of freedom) and shades the area between *lowerbound* and *upperbound*.

Shade χ^2 (*lowerbound,upperbound,df*)

```
ShadeX2(0,4,10)■
```

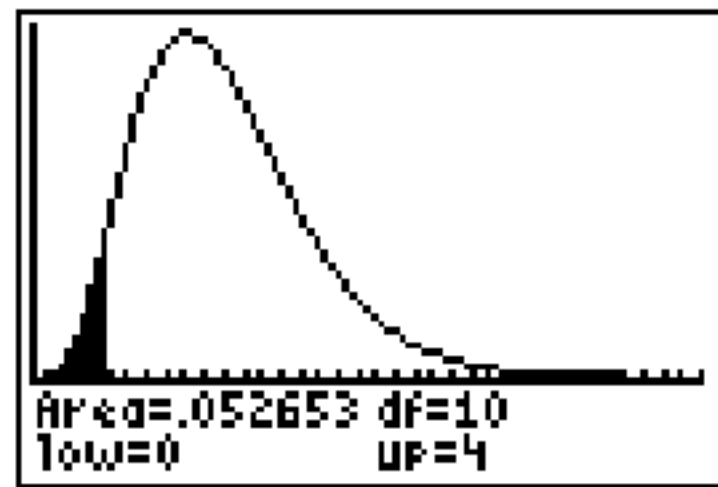

Note: For this example,

Xmin = 0

Xmax = 35

Ymin = -.025

Ymax = .1

ShadeF(

ShadeF(draws the density function for the **F** distribution specified by *numerator df* (degrees of freedom) and *denominator df* and shades the area between *lowerbound* and *upperbound*.

ShadeF(*lowerbound,upperbound,numerator df,denominator df*)

```
ShadeF(1,2,10,15)  
>
```

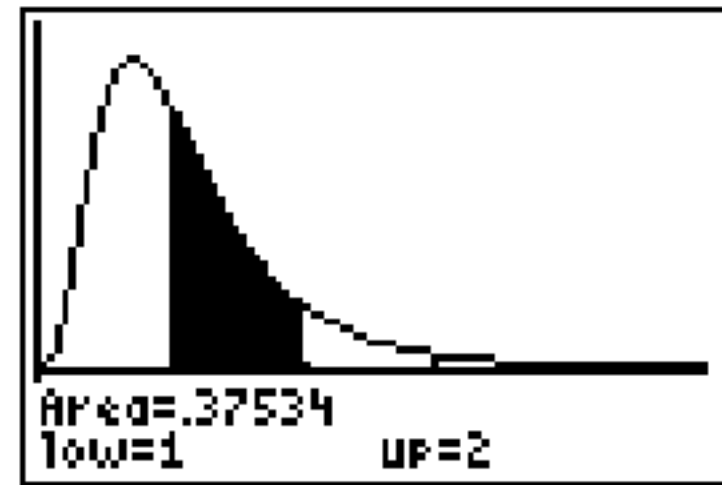

Note: For this example,

Xmin = 0

Xmax = 5

Ymin = -.25

Ymax = .9

Chapter 14: Applications

The Applications Menu

The TI-84 Plus comes with **Finance** and **EasyData App** and several other applications already listed on the **APPLICATIONS** menu. Except for the **Finance** application, you can add and remove applications as space permits. The **Finance** application is built into the TI-84 Plus code and cannot be deleted.

You can buy additional TI-84 Plus software applications that allow you to customize further your calculator's functionality. The calculator reserves 1.54 M of space within ROM memory specifically for applications.

Your TI-84 Plus includes Flash applications in addition to the ones mentioned above. Press **[APPS]** to see the complete list of applications that came with your calculator.

Documentation for applications are on the Texas Instruments Web site at: education.ti.com/guides .

Steps for Running the Finance Application

Follow these basic steps when using the Finance application.

1. Press **[APPS]** **[ENTER]** to select the **Finance** application.

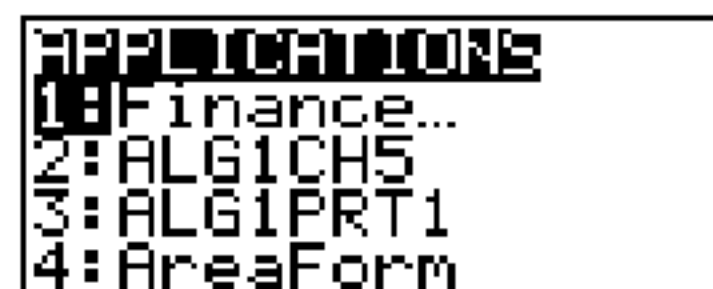

```
APPLICATIONS
1: Finance...
2: ALG1CH5
3: ALG1PRT1
4: AreaForm
```

2. Select from list of functions.

```

MODE VARS
1:TVM Solver...
2:tvm_Pmt
3:tvm_I%
4:tvm_PV
5:tvm_N
6:tvm_FV
7↓NPV(
  
```

Getting Started: Financing a Car

Getting Started is a fast-paced introduction. Read the chapter for details.

You have found a car you would like to buy. The car costs 9,000. You can afford payments of 250 per month for four years. What annual percentage rate (APR) will make it possible for you to afford the car?

1. Press **MODE** **▼** **▶** **▶** **▶** **ENTER** to set the fixed-decimal mode setting to 2. The TI-84 Plus will display all numbers with two decimal places).

```

NORMAL SCI ENG
FLOAT 0 1 2 3 4 5 6 7 8 9
RADIAN DEGREE
FUNC PAR POL SEQ
CONNECTED DOT
SEQUENTIAL SIMUL
REAL a+bi re^θi
FULL HORIZ G-T
SETCLOCK 03/18/04 2:18PM
  
```

2. Press **APPS** **ENTER** to select **1:Finance** from the **APPLICATIONS** menu.

```

MODE VARS
1:TVM Solver...
2:tvm_Pmt
3:tvm_I%
4:tvm_PV
5:tvm_N
6:tvm_FV
7↓NPV(
  
```

3. Press **ENTER** to select **1:TVM Solver** from the **CALC VARS** menu. The TVM Solver is displayed.

```
N=0.00
I%=0.00
PV=0.00
PMT=0.00
FV=0.00
P/Y=1.00
C/Y=1.00
PMT:END BEGIN
```

Press **48** **ENTER** to store 48 months to **N**. Press **9000** **ENTER** to store 9,000 to **PV**. Press **(-)** **250** **ENTER** to store -250 to **PMT**. (Negation indicates cash outflow.) Press **0** **ENTER** to store 0 to **FV**.

Press **12** **ENTER** to store 12 payments per year to **P/Y** and 12 compounding periods per year to **C/Y**. Setting **P/Y** to 12 will compute an annual percentage rate (compounded monthly) for **I%**. Press **ENTER** to select **PMT:END**, which indicates that payments are due at the end of each period.

```
N=48.00
I%=0.00
PV=9000.00
PMT=-250.00
FV=0.00
P/Y=12.00
C/Y=12.00
PMT:END BEGIN
```

4. Press **↑↑↑↑↑** to move the cursor to the **I%** prompt. Press **ALPHA** **[SOLVE]** to solve for **I%**. What APR should you look for?

```
N=48.00
I%=14.90
PV=9000.00
PMT=-250.00
FV=0.00
P/Y=12.00
C/Y=12.00
PMT:END BEGIN
```

Getting Started: Computing Compound Interest

At what annual interest rate, compounded monthly, will 1,250 accumulate to 2,000 in 7 years?

Note: Because there are no payments when you solve compound interest problems, **PMT** must be set to **0** and **P/Y** must be set to **1**.

1. Press **APPS** **ENTER** to select **1:Finance** from the **APPLICATIONS** menu.

```

VARX VARS
1: TVM Solver...
2: tvn_Pmt
3: tvn_I%
4: tvn_PV
5: tvn_N
6: tvn_FV
7: ↓nPV(
  
```

2. Press **ENTER** to select **1:TVM Solver** from the **CALC VARS** menu. The TVM Solver is displayed. Press **7** to enter the number of periods in years. Press **↓ ↓** **(-)** **1250** to enter the present value as a cash outflow (investment). Press **↓** **0** to specify no payments. Press **↓** **2000** to enter the future value as a cash inflow (return). Press **↓** **1** to enter payment periods per year. Press **↓** **12** to set compounding periods per year to **12**.

```

N=7
I%=0
PV=-1250
PMT=0
FV=2000
P/Y=1
C/Y=12
PMT: [END] BEGIN
  
```

3. Press **↑ ↑ ↑ ↑ ↑** to place the cursor on the **I%** prompt.

```

N=7
I%=█
PV=-1250
PMT=0
FV=2000
P/Y=1
C/Y=12
PMT: [END] BEGIN
  
```

4. Press **ALPHA** **[SOLVE]** to solve for **I%**, the annual interest rate.

```

N=7.00
I%=6.73
PV=-1250.00
PMT=0.00
FV=2000.00
P/Y=1.00
C/Y=12.00
PMT: [END] BEGIN
  
```

Using the TVM Solver

Using the TVM Solver

The TVM Solver displays the time-value-of-money (TVM) variables. Given four variable values, the TVM Solver solves for the fifth variable.

The **FINANCE VARS** menu section describes the five TVM variables (**N**, **I%**, **PV**, **PMT**, and **FV**) and **P/Y** and **C/Y**.

PMT: END BEGIN in the TVM Solver corresponds to the **FINANCE CALC** menu items **Pmt_End** (payment at the end of each period) and **Pmt_Bgn** (payment at the beginning of each period).

To solve for an unknown **TVM** variable, follow these steps.

1. Press **APPS** **ENTER** **ENTER** to display the TVM Solver. The screen below shows the default values with the fixed-decimal mode set to two decimal places.

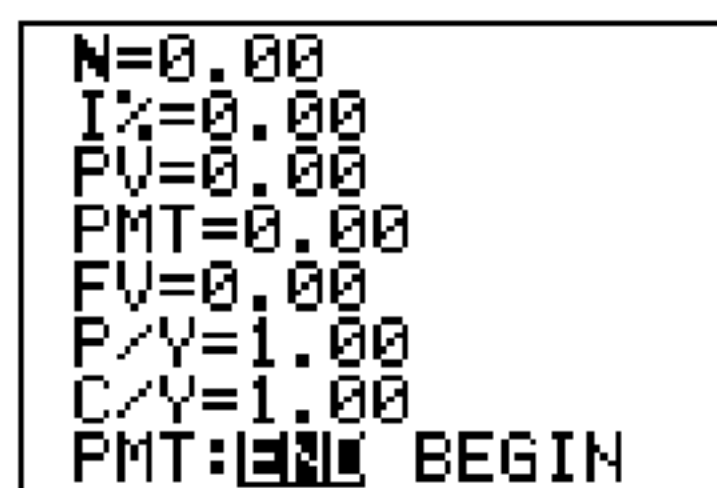

```
N=0.00
I%=0.00
PV=0.00
PMT=0.00
FV=0.00
P/Y=1.00
C/Y=1.00
PMT:[END] BEGIN
```

2. Enter the known values for four **TVM** variables.

Note: Enter cash inflows as positive numbers and cash outflows as negative numbers.

3. Enter a value for **P/Y**, which automatically enters the same value for **C/Y**; if **P/Y** \neq **C/Y**, enter a unique value for **C/Y**.
4. Select **END** or **BEGIN** to specify the payment method.
5. Place the cursor on the **TVM** variable for which you want to solve.
6. Press **[ALPHA]** **[SOLVE]**. The answer is computed, displayed in the TVM Solver, and stored to the appropriate **TVM** variable. An indicator square in the left column designates the solution variable.

```
N=360.00
I%=18.00
PV=100000.00
PMT=-1507.09
FV=0.00
P/Y=12.00
C/Y=12.00
PMT: [ ] BEGIN
```

Using the Financial Functions

Entering Cash Inflows and Cash Outflows

When using the TI-84 Plus financial functions, you must enter cash inflows (cash received) as positive numbers and cash outflows (cash paid) as negative numbers. The TI-84 Plus follows this convention when computing and displaying answers.

FINANCE CALC Menu

To display the **FINANCE CALC** menu, press **APPS** **ENTER**.

CALC VARS

1: TVM Solver...	Displays the TVM Solver.
2: tvm_Pmt	Computes the amount of each payment.
3: tvm_I%	Computes the interest rate per year.
4: tvm_PV	Computes the present value.
5: tvm_N	Computes the number of payment periods.
6: tvm_FV	Computes the future value.
7: npv (Computes the net present value.
8: irr (Computes the internal rate of return.
9: bal (Computes the amortization sched. balance.
0: Σ Prn (Computes the amort. sched. princ. sum.
A: Σ Int (Computes the amort. sched. interest sum.
B: \blacktriangleright Nom (Computes the nominal interest rate.
C: \blacktriangleright Eff (Computes the effective interest rate.
D: dbd (Calculates the days between two dates.
E: Pmt_End	Selects ordinary annuity (end of period).
F: Pmt_Bgn	Selects annuity due (beginning of period).

Use these functions to set up and perform financial calculations on the home screen.

TVM Solver

TVM Solver displays the TVM Solver.

Calculating Time Value of Money (TVM)

Calculating Time Value of Money

Use time-value-of-money (**TVM**) functions (menu items **2** through **6**) to analyze financial instruments such as annuities, loans, mortgages, leases, and savings.

Each **TVM** function takes zero to six arguments, which must be real numbers. The values that you specify as arguments for **TVM** functions are not stored to the **TVM** variables.

Note: To store a value to a **TVM** variable, use the TVM Solver or use $\boxed{\text{STO}} \blacktriangleright$ and any **TVM** variable on the **FINANCE VARS** menu.

If you enter less than six arguments, the TI-84 Plus substitutes a previously stored **TVM** variable value for each unspecified argument.

If you enter any arguments with a **TVM** function, you must place the argument or arguments in parentheses.

tvm_Pmt

tvm_Pmt computes the amount of each payment.

tvm_Pmt[(N,I%,PV,FV,P/Y,C/Y)]

```
N=360
I%=8.5
PV=100000
PMT=0
FV=0
P/Y=12
C/Y=12
PMT: [ ] BEGIN
```

```
tvm_Pmt      -768.91
tvm_Pmt(360,9.5)
              -840.85
```

Note: In the example above, the values are stored to the **TVM** variables in the TVM Solver. Then the payment (**tvm_Pmt**) is computed on the home screen using the values in the TVM Solver. Next, the interest rate is changed to 9.5 to illustrate the effect on the payment amount.

tvm_I%

tvm_I% computes the annual interest rate.

tvm_I% [(N,PV,PMT,FV,P/Y,C/Y)]

```
tvm_I%(48,10000,
-250,0,12)
          9.24
Ans→I%
          9.24
```

tvm_PV

tvm_PV computes the present value.

tvm_PV[(N,I%,PMT,FV,P/Y,C/Y)]

```
360→N:11→I%:-100
0→PMT:0→FV:12→P/
Y
tvm_PV      12.00
            105006.35
```

tvm_N

tvm_N computes the number of payment periods.

tvm_N[(I% ,PV,PMT,FV,P/Y,C/Y)]

```
6→I%:9000→PV:-35
0→PMT:0→FV:3→P/Y
tvm_N      3.00
          36.47
```

tvm_FV

tvm_FV computes the future value.

tvm_FV[(N,I%,PV,PMT,P/Y,C/Y)]

```
6→N:8→I%:-5500→P
V:0→PMT:1→P/Y
tvm_FV      1.00
          8727.81
```

Calculating Cash Flows

Calculating a Cash Flow

Use the cash flow functions (menu items 7 and 8) to analyze the value of money over equal time periods. You can enter unequal cash flows, which can be cash inflows or outflows. The syntax descriptions for `npv()` and `irr()` use these arguments.

- *interest rate* is the rate by which to discount the cash flows (the cost of money) over one period.
- *CF0* is the initial cash flow at time 0; it must be a real number.
- *CFList* is a list of cash flow amounts after the initial cash flow *CF0*.
- *CFFreq* is a list in which each element specifies the frequency of occurrence for a grouped (consecutive) cash flow amount, which is the corresponding element of *CFList*. The default is 1; if you enter values, they must be positive integers < 10,000.

For example, express this uneven cash flow in lists.

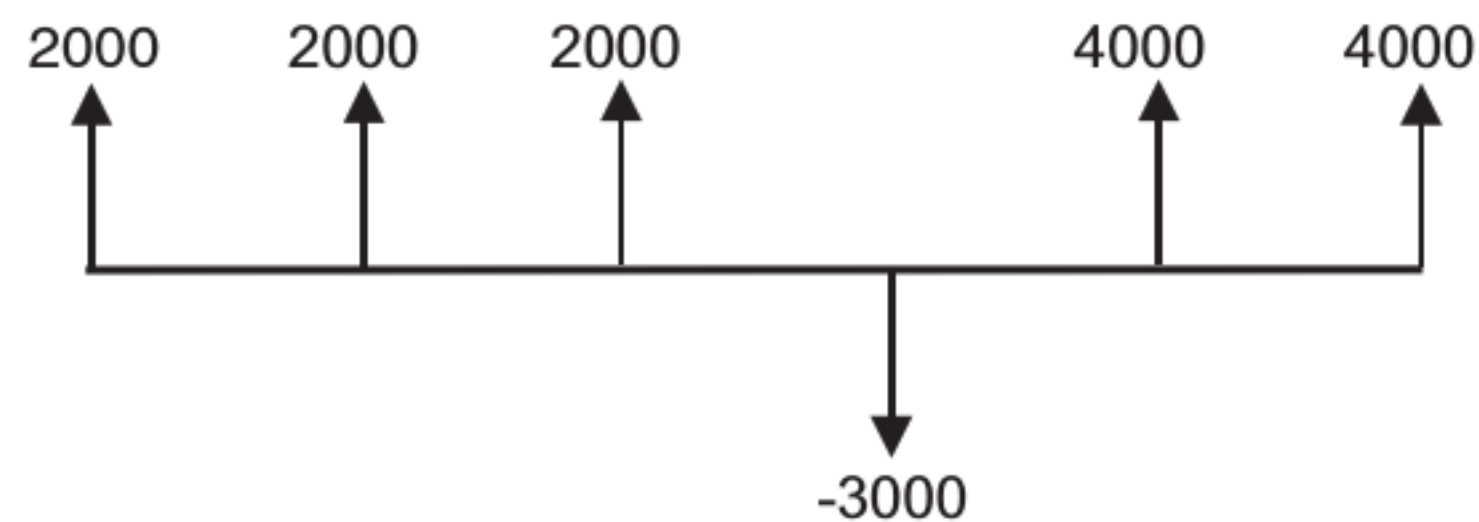

$CF0 = 2000$

$CFList = \{2000, L3000, 4000\}$

$CFFreq = \{2, 1, 2\}$

npv(, irr(

npv(net present value) is the sum of the present values for the cash inflows and outflows. A positive result for **npv** indicates a profitable investment.

npv(*interest rate*, *CF0*, *CFList*[, *CFFreq*])

irr(internal rate of return) is the interest rate at which the net present value of the cash flows is equal to zero.

irr(*CF0*, *CFList*[, *CFFreq*])

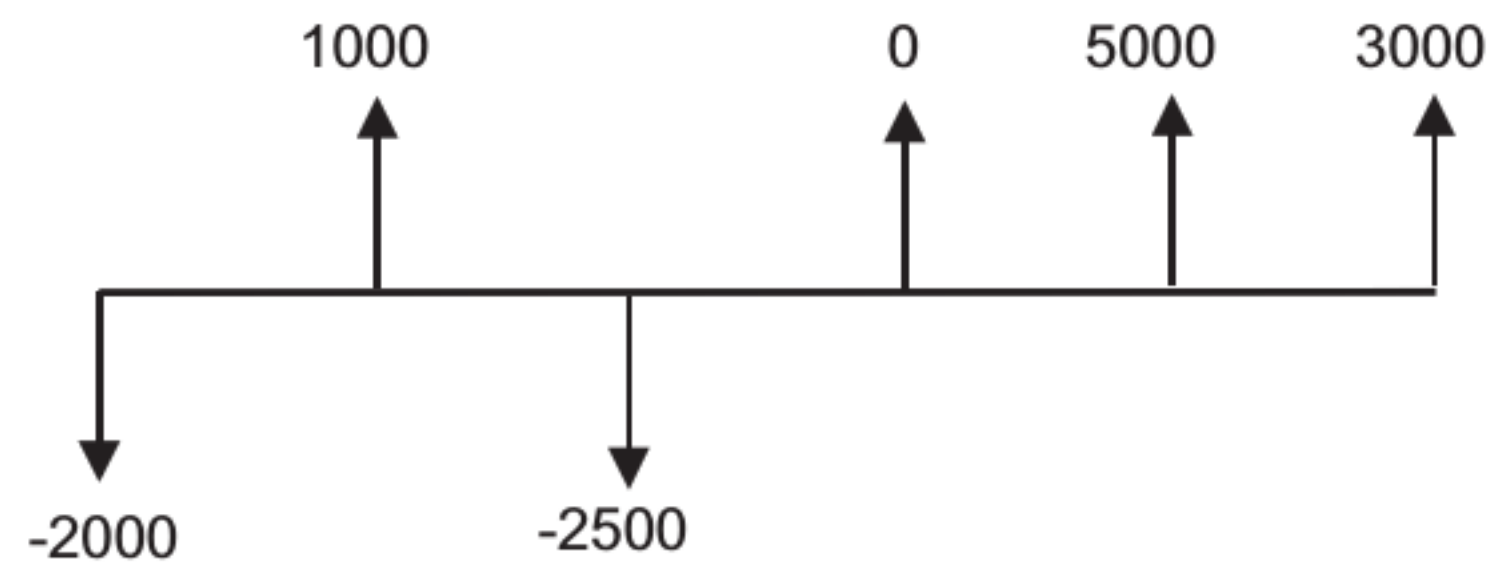

```
{1000, -2500, 0, 5000, 3000} → L1  
{1000.00 -2500.00 ...
```

```
NPV(6, -2000, L1)  
2920.65  
IRR(-2000, L1)  
27.88
```

Calculating Amortization

Calculating an Amortization Schedule

Use the amortization functions (menu items **9**, **0**, and **A**) to calculate balance, sum of principal, and sum of interest for an amortization schedule.

bal(

bal(computes the balance for an amortization schedule using stored values for **I%**, **PV**, and **PMT**. *npmt* is the number of the payment at which you want to calculate a balance. It must be a positive integer < 10,000. *roundvalue* specifies the internal precision the calculator uses to calculate the balance; if you do not specify *roundvalue*, then the TI-84 Plus uses the current **Float/Fix** decimal-mode setting.

bal(*npmt*[,*roundvalue*])

```
100000→PV:8.5→I%  
:-768.91→PMT:12→  
P/Y  
12.00
```

```
bal(12)  
99244.07
```

ΣPrn(, **ΣInt**(

ΣPrn(computes the sum of the principal during a specified period for an amortization schedule using stored values for **I%**, **PV**, and **PMT**. *pmt1* is the starting payment. *pmt2* is the ending payment in the range. *pmt1* and *pmt2* must be positive integers < 10,000. *roundvalue* specifies the internal precision the calculator uses to calculate the principal; if you do not specify *roundvalue*, the TI-84 Plus uses the current **Float/Fix** decimal-mode setting.

Note: You must enter values for **I%**, **PV**, **PMT**, and before computing the principal.

$\Sigma\text{Prn}(pmt1,pmt2[,roundvalue])$

$\Sigma\text{Int}()$ computes the sum of the interest during a specified period for an amortization schedule using stored values for **I%**, **PV**, and **PMT**. *pmt1* is the starting payment. *pmt2* is the ending payment in the range. *pmt1* and *pmt2* must be positive integers < 10,000. *roundvalue* specifies the internal precision the calculator uses to calculate the interest; if you do not specify *roundvalue*, the TI-84 Plus uses the current **Float/Fix** decimal-mode setting.

$\Sigma\text{Int}(pmt1,pmt2[,roundvalue])$

```
360→N:100000→PV:
8.5→I%:-768.91→P
MT:12→P/Y
12.00
```

```
ΣPrn(1,12)
-755.93
ΣInt(1,12)
-8470.99
```

Amortization Example: Calculating an Outstanding Loan Balance

You want to buy a home with a 30-year mortgage at 8 percent APR. Monthly payments are 800. Calculate the outstanding loan balance after each payment and display the results in a graph and in the table.

1. Press **MODE**. Press **▼** **▶** **▶** **▶** **ENTER** to set the fixed-decimal mode setting to 2. Press **▼** **▼** **▶** **ENTER** to select **Par** graphing mode.

```
NORMAL SCI ENG
FLOAT 01 2 3 4 5 6 7 8 9
RADIAN DEGREE
FUNC PAR POL SEQ
CONNECTED DOT
SEQUENTIAL SIMUL
REAL a+bi re^θi
FULL HORIZ G-T
SETCLOCK 03/18/04 2:19PM
```

- Press **APPS** **ENTER** **ENTER** to display the TVM Solver.
- Press **360** to enter number of payments. Press **8** to enter the interest rate. Press **800** to enter the payment amount. Press **0** to enter the future value of the mortgage. Press **12** to enter the payments per year, which also sets the compounding periods per year to 12. Press **ENTER** to select **PMT:END**.

```
N=360.00
I%=8.00
PV=0.00
PMT=-800.00
FV=0.00
P/Y=12.00
C/Y=12.00
PMT:END BEGIN
```

- Press **↑** **↑** **↑** **↑** **↑** to place the cursor on the **PV** prompt. Press **ALPHA** **[SOLVE]** to solve for the present value.

```
N=360.00
I%=8.00
PV=109026.80
PMT=-800.00
FV=0.00
P/Y=12.00
C/Y=12.00
PMT:END BEGIN
```

- Press **Y=** to display the parametric Y= editor. Turn off all stat plots. Press **X,T,θ,n** to define **X1T** as **T**. Press **APPS** **ENTER** **9** **X,T,θ,n** **)** to define **Y1T** as **bal(T)**.

```
Plot1 Plot2 Plot3
X1T= T
Y1T= bal(T)
```

- Press **WINDOW** to display the window variables. Enter the values below.

```
Tmin=0      Xmin=0      Ymin=0
Tmax=360    Xmax=360    Ymax=125000
Tstep=12    Xscl=50     Yscl=10000
```

- Press **TRACE** to draw the graph and activate the trace cursor. Press **→** and **←** to explore the graph of the outstanding balance over time. Press a number and then press **ENTER** to view the balance at a specific time **T**.

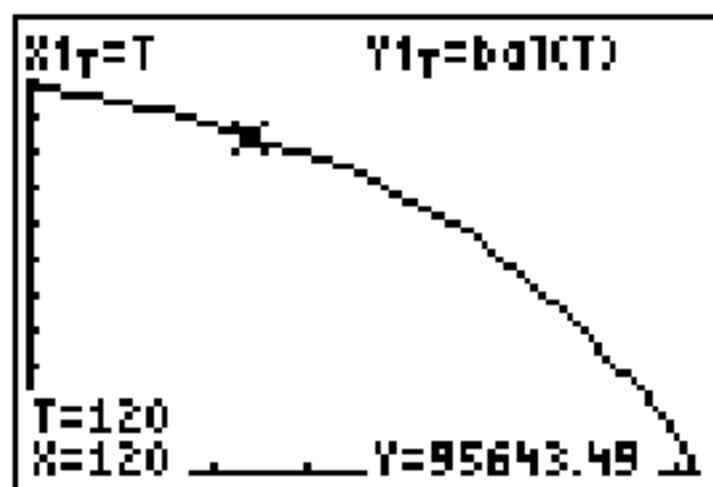

8. Press \square [2nd] [TBLSET] and enter the values below.

TblStart=0

Δ Tbl=12

9. Press \square [2nd] [TABLE] to display the table of outstanding balances (Y1T).

T	X1T	Y1T
0.00	0.00	109027
12.00	12.00	108116
24.00	24.00	107130
36.00	36.00	106061
48.00	48.00	104905
60.00	60.00	103652
72.00	72.00	102295

T=0

10. Press \square [MODE] \square \square \square \square \square \square \square \square \square [ENTER] to select G-T split-screen mode, in which the graph and table are displayed simultaneously.

Press \square [TRACE] to display X1T (time) and Y1T (balance) in the table.

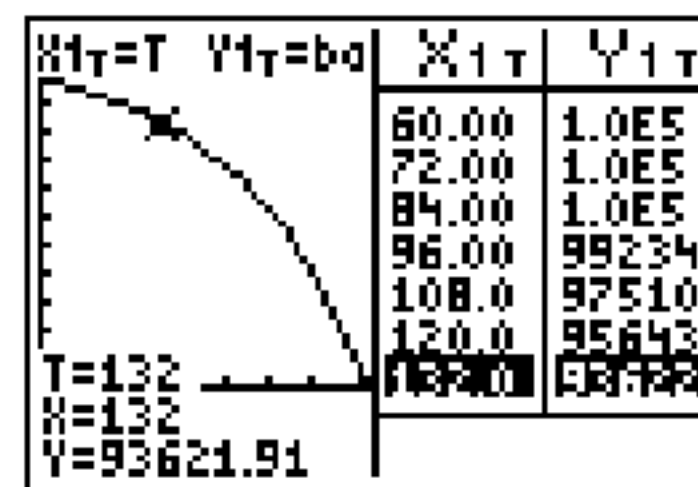

Calculating Interest Conversion

Calculating an Interest Conversion

Use the interest conversion functions (menu items **B** and **C**) to convert interest rates from an annual effective rate to a nominal rate (\blacktriangleright Nom()) or from a nominal rate to an annual effective rate (\blacktriangleright Eff()).

\blacktriangleright Nom(

►**Nom**(computes the nominal interest rate. *effective rate* and *compounding periods* must be real numbers. *compounding periods* must be >0.

►**Nom**(*effective rate,compounding periods*)

```
►Nom(15.87,4)
      15.00
```

►**Eff**(

►**Eff**(computes the effective interest rate. *nominal rate* and *compounding periods* must be real numbers. *compounding periods* must be >0.

►**Eff**(*nominal rate,compounding periods*)

```
►Eff(8,12)
      8.30
```

Finding Days between Dates/Defining Payment Method

dbd(

Use the date function **dbd**((menu item **D**) to calculate the number of days between two dates using the actual-day-count method. *date1* and *date2* can be numbers or lists of numbers within the range of the dates on the standard calendar.

Note: Dates must be between the years 1950 through 2049.

dbd(*date1*,*date2*)

You can enter *date1* and *date2* in either of two formats.

- MM.DDYY (United States)
- DDMM.YY (Europe)

The decimal placement differentiates the date formats.

```
dbd(12.3190,12.3  
192)          731.00
```

Defining the Payment Method

Pmt_End and **Pmt_Bgn** (menu items **E** and **F**) specify a transaction as an ordinary annuity or an annuity due. When you execute either command, the TVM Solver is updated.

Pmt_End

Pmt_End (payment end) specifies an ordinary annuity, where payments occur at the end of each payment period. Most loans are in this category. **Pmt_End** is the default.

Pmt_End

On the TVM Solver's **PMT:END BEGIN** line, select **END** to set **PMT** to ordinary annuity.

Pmt_Bgn

Pmt_Bgn (payment beginning) specifies an annuity due, where payments occur at the beginning of each payment period. Most leases are in this category.

Pmt_Bgn

On the TVM Solver's **PMT:END BEGIN** line, select **BEGIN** to set PMT to annuity due.

Using the TVM Variables

FINANCE VARS Menu

To display the **FINANCE VARS** menu, press **APPS** **ENTER** **▶**. You can use **TVM** variables in **TVM** functions and store values to them on the home screen.

CALC VARS

1: N	Total number of payment periods
2: I%	Annual interest rate
3: PV	Present value
4: PMT	Payment amount
5: FV	Future value
6: P/Y	Number of payment periods per year
7: C/Y	Number of compounding periods/year

N, I%, PV, PMT, FV

N, **I%**, **PV**, **PMT**, and **FV** are the five **TVM** variables. They represent the elements of common financial transactions, as described in the table above. **I%** is an annual interest rate that is converted to a per-period rate based on the values of **P/Y** and **C/Y**.

P/Y and C/Y

P/Y is the number of payment periods per year in a financial transaction.

C/Y is the number of compounding periods per year in the same transaction.

When you store a value to **P/Y**, the value for **C/Y** automatically changes to the same value. To store a unique value to **C/Y**, you must store the value to **C/Y** after you have stored a value to **P/Y**.

The EasyData App

The EasyData App by Vernier Software and Technology allows you to view and analyze real-world data when the TI-84 Plus is connected to data collection devices such as Texas Instruments CBR 2™, CBL 2™, Vernier LabPro®, Vernier USB sensors, Vernier Go!™ Motion, or Vernier Motion Detector Unit. The TI-84 Plus comes with the EasyData App already installed.

Note: The App will only work with Vernier auto-ID sensors when using CBL 2™ and Vernier LabPro®.

The EasyData app will autolaunch on your TI-84 Plus if you plug in a USB sensor such as the CBR 2™ or Vernier USB Temperature sensor.

Steps for Running the EasyData App

Follow these basic steps when using the EasyData App.

Starting EasyData

1. Attach your data collection device to your TI-84 Plus. Make sure the cables are firmly connected.
2. If the EasyData app has not auto-launched, press **APPS** and the **▲** or **▼** to select the EasyData App.
3. Press **ENTER**. The EasyData information screen is displayed for about three seconds followed by the main screen.

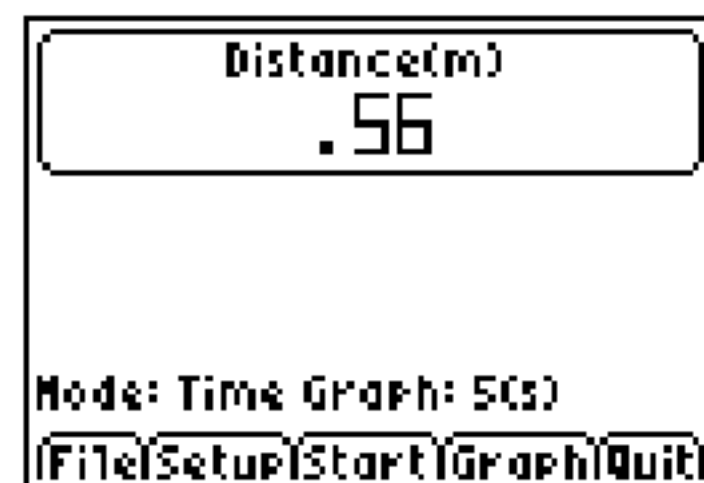

Quitting EasyData

1. To quit EasyData, select **Quit** (press **GRAPH**).
The **Ready to quit?** screen is displayed, which indicates that the collected data has been transferred to lists **L1** through **L4** on the TI-84 Plus.
2. Press **OK** (press **GRAPH**) to quit.

EasyData Settings

Changing EasyData settings

EasyData displays the most commonly used settings before data collection begins.

To change a predefined setting:

1. From the main screen in the EasyData App, choose **Setup** and select **2: Time Graph**. The current settings are displayed on the calculator.
Note: If using a motion detector, settings for **3: Distance Match** and **4: Ball Bounce** in the **Setup** menu are preset and cannot be changed.
2. Select **Next** (press **ZOOM**) to move to the setting you want to change. Press **CLEAR** to clear a setting.
3. Repeat to cycle through the available options. When the option is correct, select **Next** to move to the next option.
4. To change a setting, enter 1 or 2 digits, and then select **Next** (press **ZOOM**).
5. When all the settings are correct, select **OK** (press **GRAPH**) to return to the main menu.
6. Select **Start** (press **ZOOM**) to begin collecting data.

Restoring EasyData to the default settings

The default settings are appropriate for a wide variety of sampling situations. If you are unsure of the best settings, begin with the default settings, and then adjust the settings for your specific activity.

To restore the default settings in EasyData while a data collection device is connected to the TI-84 Plus, choose **File** and select **1:New**.

Starting and Stopping Data Collection

Starting Data Collection

To start sampling, select **Start** (press $\boxed{\text{ZOOM}}$). Sampling will automatically stop when the number of samples set in the **Time Graph Settings** menu is reached. The TI-84 Plus will then display a graph of the sampled data.

Stopping Data Collection

To stop sampling before it automatically stops, select **Stop** (press and hold $\boxed{\text{ZOOM}}$) at any time during the sampling process. When sampling stops, a graph of the sampled data is displayed.

Saving Collected Data

Collected data is automatically transferred to the TI-84 Plus and stored in lists **L1** through **L4** when data collection is complete. When you exit the EasyData App, a prompt reminds you of the lists in which time, distance, velocity, and acceleration are stored.

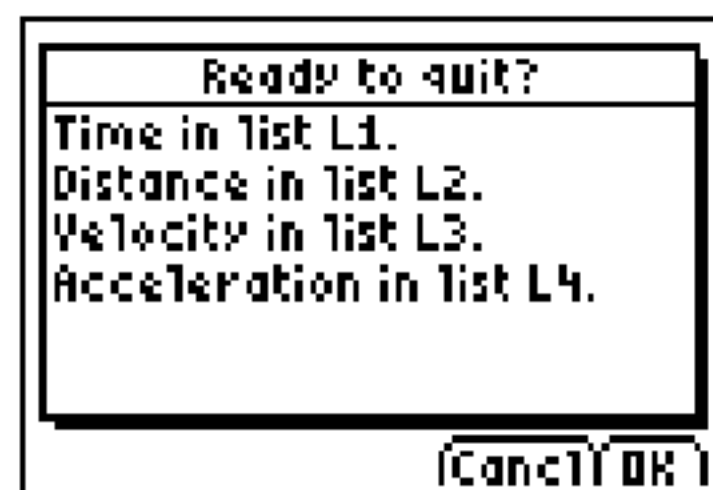

For more information about the EasyData app, refer to the Texas Instrument Web site at: education.ti.com/guides.

Chapter 15: CATALOG, Strings, Hyperbolic Functions

Browsing the TI-84 Plus CATALOG

What Is the CATALOG?

The CATALOG is an alphabetical list of all functions and instructions on the TI-84 Plus. You also can access each CATALOG item from a menu or the keyboard, except:

- The six string functions
- The six hyperbolic functions
- The **solve(** instruction without the equation solver editor (Chapter 2)
- The inferential stat functions without the inferential stat editors (Chapter 13)

Note: The only CATALOG programming commands you can execute from the home screen are **GetCalc(**, **Get(**, and **Send(**.

Selecting an Item from the CATALOG

To select a **CATALOG** item, follow these steps.

1. Press **[2nd]** **[CATALOG]** to display the **CATALOG**.

```
CATALOG A
▶abs(
  and
  angle(
  ANOVA(
  Ans
  Archive
  Asm(
```

The ▶ in the first column is the selection cursor.

2. Press ▼ or ▲ to scroll the **CATALOG** until the selection cursor points to the item you want.
 - To jump to the first item beginning with a particular letter, press that letter; alpha-lock is on.
 - Items that begin with a number are in alphabetical order according to the first letter after the number. For example, **2-PropZTest(** is among the items that begin with the letter **P**.
 - Functions that appear as symbols, such as $+$, $^{-1}$, $<$, and $\sqrt{}$, follow the last item that begins with **Z**. To jump to the first symbol, **!**, press [0].
3. Press ENTER to paste the item to the current screen.

```
abs(■
```

Note: From the top of the **CATALOG** menu, press ▲ to move to the bottom. From the bottom, press ▼ to move to the top.

Entering and Using Strings

What Is a String?

A string is a sequence of characters that you enclose within quotation marks. On the TI-84 Plus, a string has two primary applications.

- It defines text to be displayed in a program.
- It accepts input from the keyboard in a program.

Characters are the units that you combine to form a string.

- Count each number, letter, and space as one character.
- Count each instruction or function name, such as **sin(** or **cos(**, as one character; the TI-84 Plus interprets each instruction or function name as one character.

Entering a String

To enter a string on a blank line on the home screen or in a program, follow these steps.

1. Press **[ALPHA]** **["]** to indicate the beginning of the string.
2. Enter the characters that comprise the string.
 - Use any combination of numbers, letters, function names, or instruction names to create the string.
 - To enter a blank space, press **[ALPHA]** **[_]**.
 - To enter several alpha characters in a row, press **[2nd]** **[A-LOCK]** to activate alpha-lock.

3. Press **[ALPHA]** **[']** to indicate the end of the string.

`"string"`

4. Press **[ENTER]**. On the home screen, the string is displayed on the next line without quotations. An ellipsis (...) indicates that the string continues beyond the screen. To scroll the entire string, press **[▶]** and **[◀]**.

```
"ABCD 1234 EFGH
5678"
ABCD 1234 EFGH ...
```

Note: Quotation marks do not count as string characters.

Storing Strings to String Variables

String Variables

The TI-84 Plus has 10 variables to which you can store strings. You can use string variables with string functions and instructions.

To display the **VARs STRING** menu, follow these steps.

1. Press **[VARs]** to display the **VARs** menu. Move the cursor to **7:String**.

```
VARs V-VARS
1:Window...
2:Zoom...
3:GDB...
4:Picture...
5:Statistics...
6:Table...
7:String...
```

2. Press **ENTER** to display the **STRING** secondary menu.

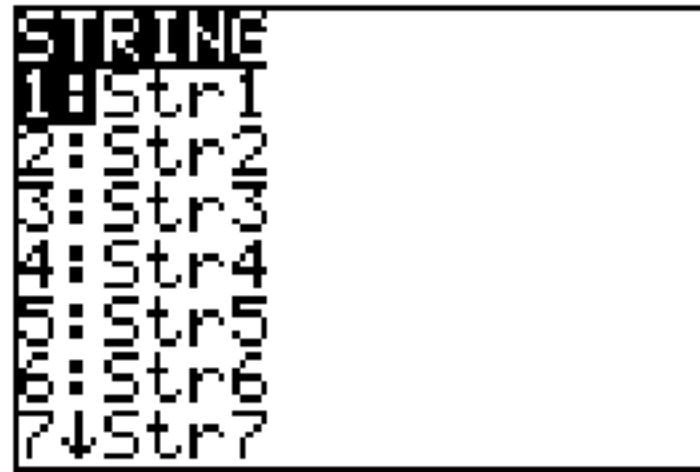

Storing a String to a String Variable

To store a string to a string variable, follow these steps.

1. Press **ALPHA** **["]**, enter the string, and press **ALPHA** **["]**.
2. Press **STO**.
3. Press **VAR** **7** to display the **VAR** **STRING** menu.
4. Select the string variable (from **Str1** to **Str9**, or **Str0**) to which you want to store the string.

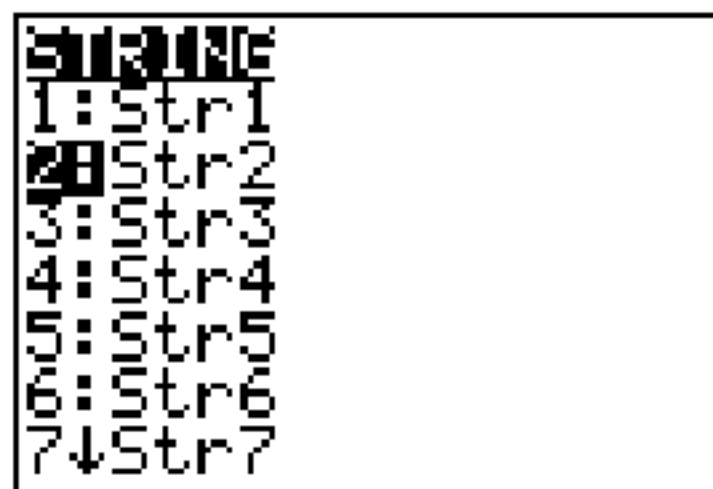

The string variable is pasted to the current cursor location, next to the store symbol (**→**).

5. Press `ENTER` to store the string to the string variable. On the home screen, the stored string is displayed on the next line without quotation marks.

```
"HELLO"→Str2  
HELLO
```

Displaying the Contents of a String Variable

To display the contents of a string variable on the home screen, select the string variable from the **VARS STRING** menu, and then press `ENTER`. The string is displayed.

```
Str2  
HELLO
```

String Functions and Instructions in the CATALOG

Displaying String Functions and Instructions in the CATALOG

String functions and instructions are available only from the CATALOG. The table below lists the string functions and instructions in the order in which they appear among the

other **CATALOG** menu items. The ellipses in the table indicate the presence of additional CATALOG items.

CATALOG

...

`Equ►String(` Converts an equation to a string.

`expr(` Converts a string to an expression.

...

`inString(` Returns a character's place number.

...

`length(` Returns a string's character length.

...

`String►Equ(` Converts a string to an equation.

`sub(` Returns a string subset as a string.

...

Concatenation

To concatenate two or more strings, follow these steps.

1. Enter *string1*, which can be a string or string name.
2. Press $\boxed{+}$.

3. Enter *string2*, which can be a string or string name. If necessary, press $\boxed{+}$ and enter *string3*, and so on.

string1+string2+string3...

4. Press $\boxed{\text{ENTER}}$ to display the strings as a single string.

```
"HIJK "+Str1:Str  
1+"LMNOP"  
HIJK LMNOP
```

Selecting a String Function from the CATALOG

To select a string function or instruction and paste it to the current screen, follow the steps for selecting an item from the CATALOG.

Equ►String(

Equ►String(converts to a string an equation that is stored to any VARS Y-VARS variable. Y_n contains the equation. **Str_n** (from **Str1** to **Str9**, or **Str0**) is the string variable to which you want the equation to be stored as a string.

Equ►String(Y_n ,Str_n)

```
"3X"→Y1  
Equ►String(Y1,St  
r1) Done  
Str1 Done  
3X
```

expr()

expr() converts the character string contained in *string* to an expression and executes it. *string* can be a string or a string variable.

expr(*string*)

```
2→X: "5X"→Str1
5X
expr(Str1)→A
A
10
10
```

```
expr("1+2+X²")
7
```

inString()

inString() returns the character position in *string* of the first character of *substring*. *string* can be a string or a string variable. *start* is an optional character position at which to start the search; the default is 1.

inString(*string*,*substring*[,*start*])

```
inString("PQRSTU
V", "STU")
4
inString("ABCABC
", "ABC", 4)
4
```

Note: If *string* does not contain *substring*, or *start* is greater than the length of *string*, **inString()** returns **0**.

length(

length(returns the number of characters in *string*. *string* can be a string or string variable.

Note: An instruction or function name, such as **sin(** or **cos(**, counts as one character.

length(*string*)

```
"WXYZ"→Str1
WXYZ
length(Str1) 4
```

String►Equ(

String►Equ(converts *string* into an equation and stores the equation to *Yn*. *string* can be a string or string variable. **String►Equ(** is the inverse of **Equ►String(**.

String►Equ(*string*,*Yn*)

```
"2X"→Str2
2X
String►Equ(Str2,
Yz)
Done
```

```
Plot1 Plot2 Plot3
\Y1=
\Yz=2X
```

sub(

sub(returns a string that is a subset of an existing *string*. *string* can be a string or a string variable. *begin* is the position number of the first character of the subset. *length* is the number of characters in the subset.

sub(string,begin,length)

```
"ABCDEFGH"→Str5  
ABCDEFGH  
sub(Str5,4,2)  
DE
```

Entering a Function to Graph during Program Execution

In a program, you can enter a function to graph during program execution using these commands.

```
PROGRAM: INPUT  
: Input "ENTRY=",  
Str3  
: String→Eqw(Str3  
,Y?)  
: DispGraph
```

```
PrgrmINPUT  
ENTRY=3X■
```

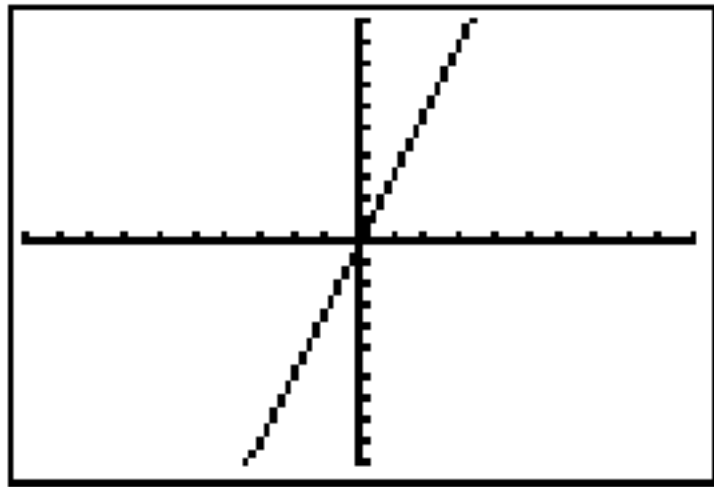
Note: When you execute this program, enter a function to store to **Y3** at the **ENTRY=** prompt.

Hyperbolic Functions in the CATALOG

Hyperbolic Functions

The hyperbolic functions are available only from the CATALOG. The table below lists the hyperbolic functions in the order in which they appear among the other **CATALOG** menu items. The ellipses in the table indicate the presence of additional CATALOG items.

CATALOG

...

`cosh (` Hyperbolic cosine

`cosh-1 (` Hyperbolic arccosine

...

`sinh (` Hyperbolic sine

CATALOG

$\sinh^{-1} ($	Hyperbolic arcsine
...	
$\tanh ($	Hyperbolic tangent
$\tanh^{-1} ($	Hyperbolic arctangent
...	

$\sinh($, $\cosh($, $\tanh($

$\sinh($, **$\cosh($, and **$\tanh($ are the hyperbolic functions. Each is valid for real numbers, expressions, and lists.****

$\sinh(value)$

$\cosh(value)$

$\tanh(value)$

```
sinh(.5)
.5210953055
cosh(.25,.5,1)
{1.0314131 1.12...
```

$\sinh^{-1} ($, $\cosh^{-1} ($, $\tanh^{-1} ($

$\sinh^{-1} ($ is the hyperbolic arcsine function. **$\cosh^{-1} ($ is the hyperbolic arccosine function.**

$\tanh^{-1} ($ is the hyperbolic arctangent function. Each is valid for real numbers, expressions, and lists.

$\sinh^{-1}(\text{value})$

$\cosh^{-1}(\text{value})$

$\sinh^{-1}(\text{value})$

```
sinh-1(0,1)
(0 .881373587)
tanh-1(-.5)
-.5493061443
```

Chapter 16: Programming

Getting Started: Volume of a Cylinder

Getting Started is a fast-paced introduction. Read the chapter for details.

A program is a set of commands that the TI-84 Plus executes sequentially, as if you had entered them from the keyboard. Create a program that prompts for the radius R and the height H of a cylinder and then computes its volume.

1. Press **PRGM** **▸** **▸** to display the **PRGM NEW** menu.



A screenshot of the TI-84 Plus PRGM NEW menu. The screen displays two options: 'EXEC EDIT NEW' and '1:Create New'. The '1:Create New' option is highlighted with a black bar on the left side.

2. Press **ENTER** to select **1:Create New**. The `Name=` prompt is displayed, and alpha-lock is on. Press **[C]** **[Y]** **[L]** **[I]** **[N]** **[D]** **[E]** **[R]**, and then press **ENTER** to name the program `CYLINDER`.

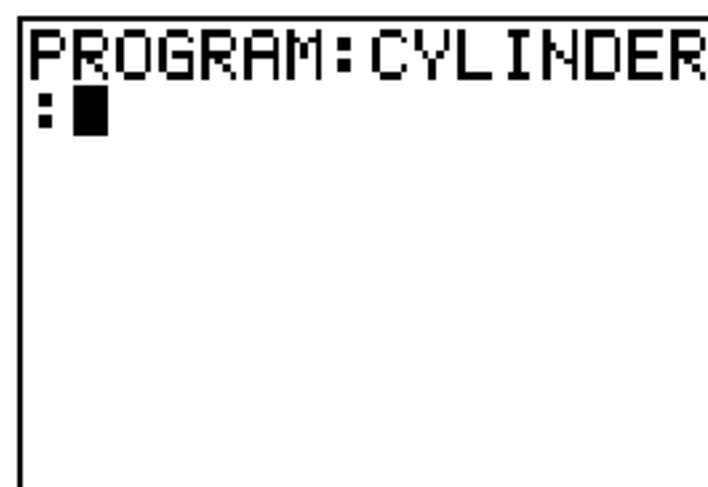

A screenshot of the TI-84 Plus program editor. The screen displays 'PROGRAM: CYLINDER' on the first line and a colon ':' followed by a cursor on the second line.

You are now in the program editor. The colon (:) in the first column of the second line indicates the beginning of a command line.

3. Press **[PRGM]** **[▶]** **[2]** to select **2:Prompt** from the **PRGM I/O** menu. **Prompt** is copied to the command line. Press **[ALPHA]** **[R]** **[,]** **[ALPHA]** **[H]** to enter the variable names for radius and height. Press **[ENTER]**.

```
PROGRAM:CYLINDER
:Prompt R,H
:█
```

4. Press **[2nd]** **[π]** **[ALPHA]** **[R]** **[x²]** **[ALPHA]** **[H]** **[STO▶]** **[ALPHA]** **[V]** **[ENTER]** to enter the expression $\pi R^2 H$ and store it to the variable **V**.

```
PROGRAM:CYLINDER
:Prompt R,H
:πR2H→V
:█
```

5. Press **[PRGM]** **[▶]** **[3]** to select **3:Disp** from the **PRGM I/O** menu. **Disp** is pasted to the command line. Press **[2nd]** **[A-LOCK]** **["]** **[V]** **[O]** **[L]** **[U]** **[M]** **[E]** **[_]** **[I]** **[S]** **["]** **[ALPHA]** **[,]** **[ALPHA]** **[V]** **[ENTER]** to set up the program to display the text **VOLUME IS** on one line and the calculated value of **V** on the next.

```
PROGRAM:CYLINDER
:Prompt R,H
:πR2H→V
:Disp "VOLUME IS
" V
:█
```

6. Press **[2nd]** **[QUIT]** to display the home screen.
7. Press **[PRGM]** to display the **PRGM EXEC** menu. The items on this menu are the names of stored programs.

```
EXEC EDIT NEW
CYLINDER
```

8. Press **ENTER** to paste `prgmCYLINDER` to the current cursor location. (If **CYLINDER** is not item 1 on your **PRGM EXEC** menu, move the cursor to **CYLINDER** before you press **ENTER**.)

```
PRGMCYLINDER█
```

9. Press **ENTER** to execute the program. Enter 1.5 for the radius, and then press **ENTER**. Enter 3 for the height, and then press **ENTER**. The text `VOLUME IS`, the value of V , and `Done` are displayed.

```
PRGMCYLINDER
R=?1.5
H=?3
VOLUME IS
      21.20575041
           Done
```

Repeat steps 7 through 9 and enter different values for **R** and **H**.

Creating and Deleting Programs

What Is a Program?

A program is a set of one or more command lines. Each line contains one or more instructions. When you execute a program, the TI-84 Plus performs each instruction on each command line in the same order in which you entered them. The number and size of programs that the TI-84 Plus can store is limited only by available memory.

Creating a New Program

To create a new program, follow these steps.

1. Press **PRGM** **◀** to display the **PRGM NEW** menu.

```
EXEC EDIT NEW
1:Create New
```

2. Press **[ENTER]** to select **1:Create New**. The **Name=** prompt is displayed, and alpha-lock is on.
3. Press a letter from A to Z or θ to enter the first character of the new program name.
Note: A program name can be one to eight characters long. The first character must be a letter from A to Z or θ . The second through eighth characters can be letters, numbers, or θ .
4. Enter zero to seven letters, numbers, or θ to complete the new program name.
5. Press **[ENTER]**. The program editor is displayed.
6. Enter one or more program commands.
7. Press **[2nd] [QUIT]** to leave the program editor and return to the home screen.

Managing Memory and Deleting a Program

To check whether adequate memory is available for a program you want to enter:

1. Press **[2nd] [MEM]** to display the **MEMORY** menu.
2. Select **2:Mem Mgmt/Del** to display the **MEMORY MANAGEMENT/DELETE** menu (Chapter 18).
3. Select **7:Prgm** to display the **PRGM** editor.

```
RAM FREE 19635
ARC FREE 847598
*PROGRAM1 3475
▶ PROGRAM2 2844
```

The TI-84 Plus expresses memory quantities in bytes.

You can increase available memory in one of two ways. You can delete one or more programs or you can archive some programs.

To increase available memory by deleting a specific program:

1. Press **[2nd] [MEM]** and then select **2:Mem Mgmt/Del** from the **MEMORY** menu.

```
MEMORY
1:About
2:Mem Mgmt/Del...
3:Clear Entries
4:ClrAllLists
5:Archive
6:UnArchive
7↓Reset...
```

2. Select **7:Prgm** to display the **PRGM** editor (Chapter 18).

```
RAM FREE   19635
ARC FREE   847598
*PROGRAM1  3475
▶ PROGRAM2  2844
```

3. Press **[↑]** and **[↓]** to move the selection cursor (**▶**) next to the program you want to delete, and then press **[DEL]**. The program is deleted from memory.

Note: You will receive a message asking you to confirm this delete action. Select **2:yes** to continue.

To leave the **PRGM** editor screen without deleting anything, press **[2nd] [QUIT]**, which displays the home screen.

To increase available memory by archiving a program:

4. Press **[2nd]** **[MEM]** and then select **2:Mem Mgmt/Del** from the **MEMORY** menu.
5. Select **2:Mem Mgmt/Del** to display the **MEM MGMT/DEL** menu.
6. Select **7:Prgm...** to display the **PRGM** menu.

```
RAM FREE 22464
ARC FREE 844751
*PROGRAM1 3475
▶*PROGRAM2 2844
```

7. Press **[ENTER]** to archive the program. An asterisk will appear to the left of the program to indicate it is an archived program.

To unarchive a program in this screen, put the cursor next to the archived program and press **[ENTER]**. The asterisk will disappear.

Note: Archive programs cannot be edited or executed. In order to edit or execute an archived program, you must first unarchive it.

Entering Command Lines and Executing Programs

Entering a Program Command Line

You can enter on a command line any instruction or expression that you could execute from the home screen. In the program editor, each new command line begins with a colon. To enter more than one instruction or expression on a single command line, separate each with a colon.

Note: A command line can be longer than the screen is wide; long command lines wrap to the next screen line.

While in the program editor, you can display and select from menus. You can return to the program editor from a menu in either of two ways.

- Select a menu item, which pastes the item to the current command line.
- Press **CLEAR**.

When you complete a command line, press **ENTER**. The cursor moves to the next command line.

Programs can access variables, lists, matrices, and strings saved in memory. If a program stores a new value to a variable, list, matrix, or string, the program changes the value in memory during execution.

You can call another program as a subroutine.

Executing a Program

To execute a program, begin on a blank line on the home screen and follow these steps.

1. Press **PRGM** to display the **PRGM EXEC** menu.
2. Select a program name from the **PRGM EXEC** menu. **prgmname** is pasted to the home screen (for example, **prgmCYLINDER**).
3. Press **ENTER** to execute the program. While the program is executing, the busy indicator is on.

Last Answer (**Ans**) is updated during program execution. Last Entry is not updated as each command is executed (Chapter 1).

The TI-84 Plus checks for errors during program execution. It does not check for errors as you enter a program.

Breaking a Program

To stop program execution, press **[ON]**. The **ERR:BREAK** menu is displayed.

- To return to the home screen, select **1:Quit**.
- To go where the interruption occurred, select **2:Goto**.

Editing Programs

Editing a Program

To edit a stored program, follow these steps.

1. Press **[PRGM]** **[▶]** to display the **PRGM EDIT** menu.
2. Select a program name from the **PRGM EDIT** menu. Up to the first seven lines of the program are displayed.
Note: The program editor does not display a ↓ to indicate that a program continues beyond the screen.
3. Edit the program command lines.
 - Move the cursor to the appropriate location, and then delete, overwrite, or insert.
 - Press **[CLEAR]** to clear all program commands on the command line (the leading colon remains), and then enter a new program command.

Note: To move the cursor to the beginning of a command line, press **2nd** **◀**; to move to the end, press **2nd** **▶**. To scroll the cursor down seven command lines, press **ALPHA** **▼**. To scroll the cursor up seven command lines, press **ALPHA** **▲**.

Inserting and Deleting Command Lines

To insert a new command line anywhere in the program, place the cursor where you want the new line, press **2nd** **[INS]**, and then press **ENTER**. A colon indicates a new line.

To delete a command line, place the cursor on the line, press **CLEAR** to clear all instructions and expressions on the line, and then press **DEL** to delete the command line, including the colon.

Copying and Renaming Programs

Copying and Renaming a Program

To copy all command lines from one program into a new program, follow steps 1 through 5 for Creating a New Program, and then follow these steps.

1. Press **2nd** **[RCL]**. **Rcl** is displayed on the bottom line of the program editor in the new program (Chapter 1).
2. Press **PRGM** **◀** to display the **PRGM EXEC** menu.
3. Select a name from the menu. **prgmname** is pasted to the bottom line of the program editor.
4. Press **ENTER**. All command lines from the selected program are copied into the new program.

Copying programs has at least two convenient applications.

- You can create a template for groups of instructions that you use frequently.
- You can rename a program by copying its contents into a new program.

Note: You also can copy all the command lines from one existing program to another existing program using **RCL**.

Scrolling the PRGM EXEC and PRGM EDIT Menus

The TI-84 Plus sorts **PRGM EXEC** and **PRGM EDIT** menu items automatically into alphanumerical order. Each menu only labels the first 10 items using 1 through 9, then 0.

To jump to the first program name that begins with a particular alpha character or θ , press **ALPHA** [*letter from A to Z or θ*].

Note: From the top of either the **PRGM EXEC** or **PRGM EDIT** menu, press **▲** to move to the bottom. From the bottom, press **▼** to move to the top. To scroll the cursor down the menu seven items, press **ALPHA** **▼**. To scroll the cursor up the menu seven items, press **ALPHA** **▲**.

PRGM CTL (Control) Instructions

PRGM CTL Menu

To display the **PRGM CTL** (program control) menu, press `PRGM` from the program editor only.

CTL	I/O	EXEC
1:	If	Creates a conditional test.
2:	Then	Executes commands when If is true.
3:	Else	Executes commands when If is false.
4:	For (Creates an incrementing loop.
5:	While	Creates a conditional loop.
6:	Repeat	Creates a conditional loop.
7:	End	Signifies the end of a block.
8:	Pause	Pauses program execution.
9:	Lbl	Defines a label.
0:	Goto	Goes to a label.
A:	IS> (Increments and skips if greater than.
B:	DS< (Decrements and skips if less than.
C:	Menu (Defines menu items and branches.

CTL I/O EXEC

D: prgm	Executes a program as a subroutine.
E: Return	Returns from a subroutine.
F: Stop	Stops execution.
G: DelVar	Deletes a variable from within program.
H: GraphStyle(Designates the graph style to be drawn.

These menu items direct the flow of an executing program. They make it easy to repeat or skip a group of commands during program execution. When you select an item from the menu, the name is pasted to the cursor location on a command line in the program.

To return to the program editor without selecting an item, press **CLEAR**.

Controlling Program Flow

Program control instructions tell the TI-84 Plus which command to execute next in a program. **If**, **While**, and **Repeat** check a defined condition to determine which command to execute next. Conditions frequently use relational or Boolean tests (Chapter 2), as in:

If A<7:A+1→A

or

If N=1 and M=1:Goto Z

If

Use **If** for testing and branching. If *condition* is false (zero), then the *command* immediately following **If** is skipped. If *condition* is true (nonzero), then the next *command* is executed. **If** instructions can be nested.

```
:if condition  
command (if true)  
command
```

Program

```
PROGRAM:COUNT  
:0→A  
:Lb1 Z  
:A+1→A  
:Disp "A IS",A  
:If A≥2  
:Stop  
:Goto Z
```

Output

```
Pr9mCOUNT  
A IS  
1  
A IS  
2  
Done
```

If-Then

Then following an **If** executes a group of *commands* if *condition* is true (nonzero). **End** identifies the end of the group of *commands*.

```
:if condition  
:Then  
command (if true)  
command (if true)
```

:End

:command

Program

```
PROGRAM:TEST  
:1→X:10→Y  
:If X<10  
:Then  
:2X+3→X  
:2Y-3→Y  
:End  
:DISP X,Y
```

Output

```
PRGMTEST  
17  
5  
Done
```

If-Then-Else

Else following **If-Then** executes a group of *commands* if *condition* is false (zero). **End** identifies the end of the group of *commands*.

:if *condition*

:Then

:command (if true)

:command (if true)

:Else

:command (if false)

:command (if false)

:End

:command

Program

Output

```

PROGRAM:TESTELSE
:Input "X=",X
:If X<0
:Then
:X $\rightarrow$ Y
:Else
:X $\rightarrow$ Y
:End

```

```

PrgrMTESTELSE
X=5
(5 5)
Done
X=-5
(-5 25)
Done

```

```
:Disp (X,Y)
```

For(

For(loops and increments. It increments *variable* from *begin* to *end* by *increment*. *increment* is optional (default is 1) and can be negative ($end < begin$). *end* is a maximum or minimum value not to be exceeded. **End** identifies the end of the loop. **For(** loops can be nested.

```

:For(variable,begin,end[,increment])
:command (while end not exceeded)
:command (while end not exceeded)
:End
:command

```

Program

```

PROGRAM:SQUARE
:For(A,0,8,2)
:Disp A2
:End

```

Output

```

PrgrMSQUARE
0
4
16
36
64
Done

```

While

While performs a group of *commands* while *condition* is true. *condition* is frequently a relational test (Chapter 2). *condition* is tested when **While** is encountered. If *condition* is true (nonzero), the program executes a group of *commands*. **End** signifies the end of the group. When *condition* is false (zero), the program executes each *command* following **End**. **While** instructions can be nested.

:While *condition*

:command (while *condition* is true)

:command (while *condition* is true)

:End

:command

Program

```
PROGRAM: LOOP
:0→I
:0→J
:While I<6
:J+1→J
:I+1→I
:End
:Disp "J=",J
```

Output

```
Pr9mLOOP
J=
6
Done
```

Repeat

Repeat repeats a group of *commands* until *condition* is true (nonzero). It is similar to **While**, but *condition* is tested when **End** is encountered; therefore, the group of *commands* is always executed at least once. **Repeat** instructions can be nested.

:Repeat *condition*

:command (until *condition* is true)

:command (until *condition* is true)

:End

:Command

Program

```
PROGRAM:RLOOP
:0→I
:0→J
:Repeat I≥6
:J+1→J
:I+1→I
:End
:Disp "J=",J
```

Output

```
Pr9mRLOOP
J=
6
Done
```

End

End identifies the end of a group of *commands*. You must include an **End** instruction at the end of each **For**(, **While**, or **Repeat** loop. Also, you must paste an **End** instruction at the end of each **If-Then** group and each **If-Then-Else** group.

Pause

Pause suspends execution of the program so that you can see answers or graphs. During the pause, the pause indicator is on in the top-right corner. Press **ENTER** to resume execution.

- **Pause** without a *value* temporarily pauses the program. If the **DispGraph** or **Disp** instruction has been executed, the appropriate screen is displayed.
- **Pause** with *value* displays *value* on the current home screen. *value* can be scrolled.

Pause [*value*]

Program

```
PROGRAM: PAUSE
: 10 → X
: "X²+2" → Y₁
: Disp "X=", X
: Pause
: Disp Graph
: Pause
: Disp
```

Output

```
Pr9mPAUSE
X=
10
```

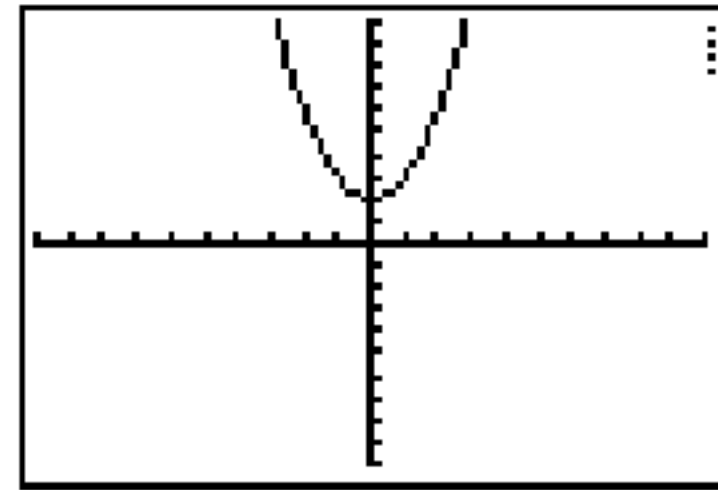

```
Pr9mPAUSE
X=
10
Done
```

Lbl, Goto

Lbl (label) and **Goto** (go to) are used together for branching.

Lbl specifies the *label* for a command. *label* can be one or two characters (A through Z, 0 through 99, or θ).

Lbl *label*

Goto causes the program to branch to *label* when **Goto** is encountered.

Goto label

Program

```
PROGRAM: CUBE
: Lbl 99
: Input A
: If A ≥ 100
: Stop
: Disp A
: Pause
: Goto 99
```

Output

```
Pr9mCUBE
?2          8
?3          27
?105       Done
```

IS>(

IS>((increment and skip) adds 1 to *variable*. If the answer is $> value$ (which can be an expression), the next *command* is skipped; if the answer is $\leq value$, the next *command* is executed. *variable* cannot be a system variable.

:IS>(variable,value)

:command (if answer $\leq value$)

:command (if answer $> value$)

Program

```
PROGRAM: ISKIP
: 7→A
: IS>(A,6)
: Disp "NOT > 6"
: Disp "> 6"
```

Output

```
Pr9mISKIP
> 6          Done
```

Note: **IS>(** is not a looping instruction.

DS<(

DS<((decrement and skip) subtracts 1 from *variable*. If the answer is $< value$ (which can be an expression), the next *command* is skipped; if the answer is $\geq value$, the next *command* is executed. *variable* cannot be a system variable.

:DS<(*(variable,value)*

:command (if answer $\geq value$)

:command (if answer $< value$)

Program

```
PROGRAM:DSKIP  
:1→A  
:DS<(A,6)  
:DISP "> 6"  
:DISP "NOT > 6"
```

Output

```
prgmDSKIP  
NOT > 6  
Done
```

Note: **DS<(** is not a looping instruction.

Menu(

Menu(sets up branching within a program. If **Menu(** is encountered during program execution, the menu screen is displayed with the specified menu items, the pause indicator is on, and execution pauses until you select a menu item.

The menu *title* is enclosed in quotation marks ("). Up to seven pairs of menu items follow. Each pair comprises a *text* item (also enclosed in quotation marks) to be displayed as a menu selection, and a *label* item to which to branch if you select the corresponding menu selection.

Menu("title","text1",label1,"text2",label2, . . .)

Program

```
PROGRAM:TOSSDICE  
:Menu("TOSS DICE  
","FAIR DICE",A,  
"WEIGHTED DICE",  
B)
```

Output

```
TOSS DICE  
1:FAIR DICE  
2:WEIGHTED DICE
```

The program above pauses until you select **1** or **2**. If you select **2**, for example, the menu disappears and the program continues execution at **Lbl B**.

prgm

Use **prgm** to execute other programs as subroutines. When you select **prgm**, it is pasted to the cursor location. Enter characters to spell a program *name*. Using **prgm** is equivalent to selecting existing programs from the **PRGM EXEC** menu; however, it allows you to enter the name of a program that you have not yet created.

prgm*name*

Note: You cannot directly enter the subroutine name when using **RCL**. You must paste the name from the **PRGM EXEC** menu.

Return

Return quits the subroutine and returns execution to the calling program, even if encountered within nested loops. Any loops are ended. An implied **Return** exists at the end of any program that is called as a subroutine. Within the main program, **Return** stops execution and returns to the home screen.

Stop

Stop stops execution of a program and returns to the home screen. **Stop** is optional at the end of a program.

DelVar

DelVar deletes from memory the contents of *variable*.

DelVar *variable*

```
PROGRAM:DELMATR
:DelVar [A]■
```

GraphStyle(

GraphStyle(designates the style of the graph to be drawn. *function#* is the number of the Y= function name in the current graphing mode. *graphstyle* is a number from 1 to 7 that corresponds to the graph style, as shown below.

1 = \ (line)

2 = ¶ (thick)

3 = ¶ (shade above)

4 = ¶ (shade below)

5 = ¶ (path)

6 = ¶ (animate)

7 = · (dot)

GraphStyle(*function#*,*graphstyle*)

For example, **GraphStyle(1,5)** in **Func** mode sets the graph style for Y1 to ¶ (path; 5).

Not all graph styles are available in all graphing modes. For a detailed description of each graph style, see the Graph Styles table in Chapter 3.

PRGM I/O (Input/Output) Instructions

PRGM I/O Menu

To display the **PRGM I/O** (program input/output) menu, press **PRGM** **▸** from within the program editor only.

CTL	I/O	EXEC
1:	Input	Enters a value or uses the cursor.
2:	Prompt	Prompts for entry of variable values.
3:	Disp	Displays text, value, or the home screen.
4:	DispGraph	Displays the current graph.
5:	DispTable	Displays the current table.
6:	Output (Displays text at a specified position.
7:	getKey	Checks the keyboard for a keystroke.
8:	ClrHome	Clears the display.
9:	ClrTable	Clears the current table.
0:	GetCalc (Gets a variable from another TI-84 Plus.
A:	Get (Gets a variable from CBL 2™ or CBR™.
B:	Send (Sends a variable to CBL 2 or CBR.

These instructions control input to and output from a program during execution. They allow you to enter values and display answers during program execution.

To return to the program editor without selecting an item, press `CLEAR`.

Displaying a Graph with Input

Input without a variable displays the current graph. You can move the free-moving cursor, which updates X and Y (and R and θ for **PolarGC** format). The pause indicator is on. Press `ENTER` to resume program execution.

Input

Program

```
PROGRAM:GINPUT
:FnOff
:ZDecimal
:Input
:Disp X,Y
```

Output

```
PRGMGINPUT
```

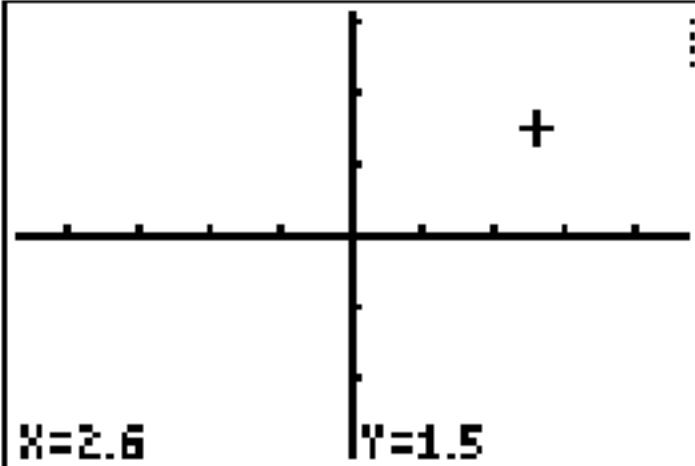

```
X=2.6 Y=1.5
```

```
PRGMGINPUT
      2.6
      1.5
     Done
```

Storing a Variable Value with Input

Input with *variable* displays a ? (question mark) prompt during execution. *variable* may be a real number, complex number, list, matrix, string, or Y= function. During program execution, enter a value, which can be an expression, and then press **ENTER**. The value is evaluated and stored to *variable*, and the program resumes execution.

Input [*variable*]

You can display *text* or the contents of **Str_n** (a string variable) of up to 16 characters as a prompt. During program execution, enter a value after the prompt and then press **ENTER**. The value is stored to *variable*, and the program resumes execution.

Input ["*text*",*variable*]

Input [**Str_n**,*variable*]

Program

```
PROGRAM:HINPUT
:Input A
:Input L1
:Input "Y1=",Y1
:Input "DATA=",L
DATA
:Disp Y1(A)
:Disp Y1(L1)

:Disp Y1(LDATA)
```

Output

```
PrgrmHINPUT
?2
?(1,2,3)
Y1="2X+2"
DATA={4,5,6}
      {4 6 8}
      {10 12 14}
      Done
```

Note: When a program prompts for input of lists and **Y_n** functions during execution, you must include the braces ({ }) around the list elements and quotation marks (") around the expressions.

Prompt

During program execution, **Prompt** displays each *variable*, one at a time, followed by =?. At each prompt, enter a value or expression for each *variable*, and then press **ENTER**. The values are stored, and the program resumes execution.

Prompt *variableA[,variableB,...,variable n]*

Program

```
PROGRAM:WINDOW
:Prompt Xmin
:Prompt Xmax
:Prompt Ymin
:Prompt Ymax
```

Output

```
PrgrmWINDOW
Xmin=?-10
Xmax=?10
Ymin=?-3
Ymax=?3
Done
```

Note: Y= functions are not valid with **Prompt**.

Displaying the Home Screen

Disp (display) without a value displays the home screen. To view the home screen during program execution, follow the **Disp** instruction with a **Pause** instruction.

Disp

Displaying Values and Messages

Disp with one or more *values* displays the value of each.

Disp [*valueA,valueB,valueC,...,value n*]

- If *value* is a variable, the current value is displayed.
- If *value* is an expression, it is evaluated and the result is displayed on the right side of the next line.
- If *value* is text within quotation marks, it is displayed on the left side of the current display line. → is not valid as text.

Program

```
PROGRAM:A
:Disp "THE ANSWE
R IS ",π/2
```

Output

```
PRGMA
THE ANSWER IS
      1.570796327
                Done
```

If **Pause** is encountered after **Disp**, the program halts temporarily so you can examine the screen. To resume execution, press **ENTER**.

Note: If a matrix or list is too large to display in its entirety, ellipses (...) are displayed in the last column, but the matrix or list cannot be scrolled. To scroll, use **Pause** *value*.

DispGraph

DispGraph (display graph) displays the current graph. If **Pause** is encountered after **DispGraph**, the program halts temporarily so you can examine the screen. Press **ENTER** to resume execution.

DispTable

DispTable (display table) displays the current table. The program halts temporarily so you can examine the screen. Press **ENTER** to resume execution.

Output(

Output(displays *text* or *value* on the current home screen beginning at *row* (1 through 8) and *column* (1 through 16), overwriting any existing characters.

Note: You may want to precede **Output(** with **ClrHome**.

Expressions are evaluated and values are displayed according to the current mode settings. Matrices are displayed in entry format and wrap to the next line. \rightarrow is not valid as text.

Output(row,column,"text")

Output(row,column,value)

Program

```
PROGRAM: OUTPUT
: 3+5÷B
: ClrHome
: Output(5, 4, "ANS
WER: "
: Output(5, 12, B)
```

Output

```
ANSWER: 8
```

For **Output(** on a **Horiz** split screen, the maximum value for *row* is 4.

getKey

getKey returns a number corresponding to the last key pressed, according to the key code diagram below. If no key has been pressed, **getKey** returns 0. Use **getKey** inside loops to transfer control, for example, when creating video games.

Program

```
PROGRAM:GETKEY  
:While 1  
:getKey→K  
:While K=0  
:getKey→K  
:End  
:Disp K  
:If K=105
```

```
:Stop  
:End
```

Output

```
Pr9mGETKEY  
41  
42  
43  
105  
Done
```

Note: **MATH**, **APPS**, **PRGM**, and **ENTER** were pressed during program execution.

Note: You can press **ON** at any time during execution to break the program.

TI-84 Plus Key Code Diagram

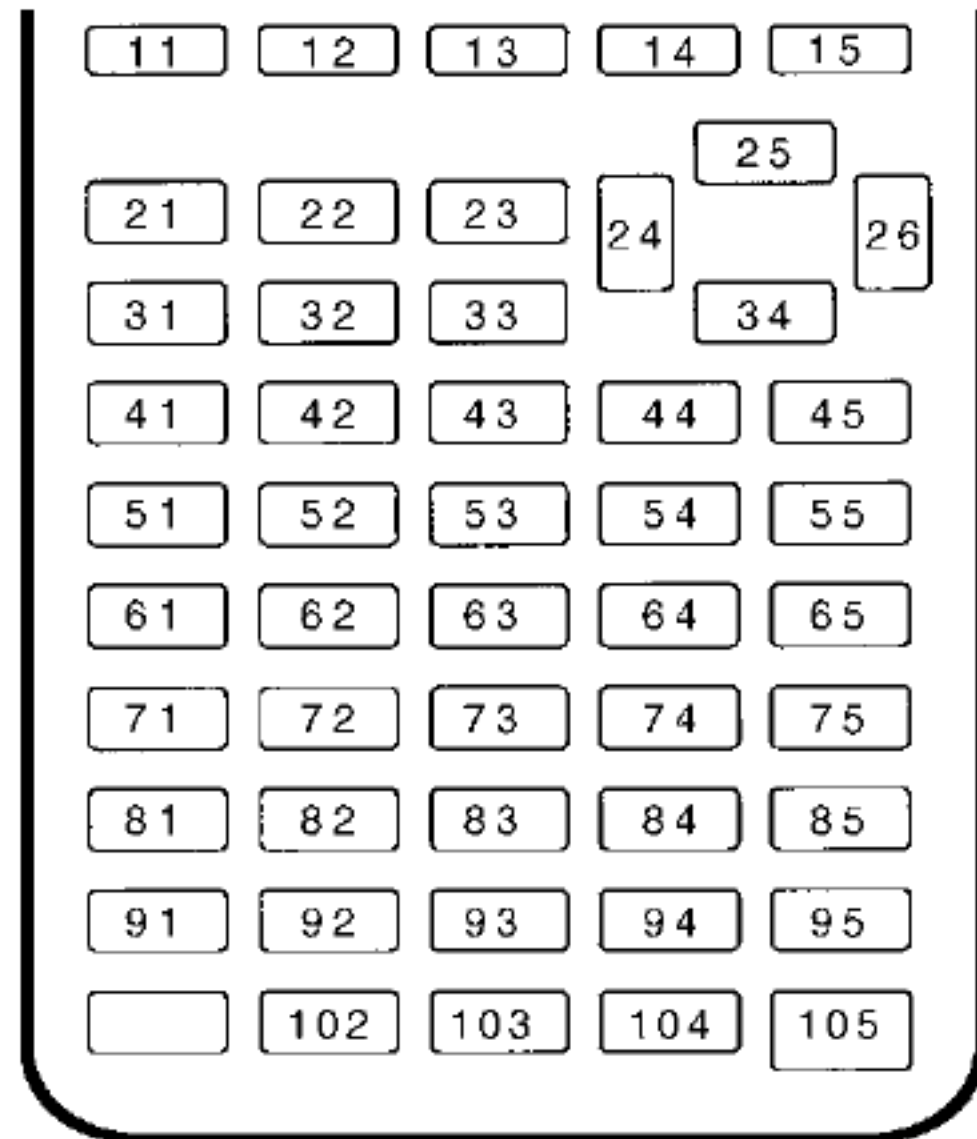

ClrHome, ClrTable

ClrHome (clear home screen) clears the home screen during program execution.

ClrTable (clear table) clears the values in the table during program execution.

GetCalc(

GetCalc(gets the contents of *variable* on another TI-84 Plus and stores it to *variable* on the receiving TI-84 Plus. *variable* can be a real or complex number, list element, list name, matrix element, matrix name, string, Y= variable, graph database, or picture.

GetCalc(variable[,portflag])

By default, the TI-84 Plus uses the USB port if it is connected. If the USB cable is not connected, it uses the I/O port. If you want to specify either the USB or I/O port, use the following portflag numbers:

portflag=0 use USB port if connected;

portflag=1 use USB port;

portflag=2 use I/O port

Note: **GetCalc()** does not work between TI-82 and TI-83 Plus or a TI-82 and TI-84 Plus calculators.

Get(, Send(

Get() gets data from the CBL 2™ or CBR™ and stores it to *variable* on the receiving TI-84 Plus. *variable* can be a real number, list element, list name, matrix element, matrix name, string, Y= variable, graph database, or picture.

Get(*variable*)

Note: If you transfer a program that references the **Get()** command to the TI-84 Plus from a TI-82, the TI-84 Plus will interpret it as the **Get()** described above. Use **GetCalc()** to get data from another TI-84 Plus.

Send() sends the contents of *variable* to the CBL 2™ or CBR™. You cannot use it to send to another TI-84 Plus. *variable* can be a real number, list element, list name, matrix element, matrix name, string, Y= variable, graph database, or picture. *variable* can be a list of elements.

Send(*variable*)

```
PROGRAM:GETSOUND
:Send( (3, .00025,
99, 1, 0, 0, 0, 0, 1) )
:
:Get(L1)
:Get(L2)
```

Note: This program gets sound data and time in seconds from CBL 2™.

Note: You can access **Get**(, **Send**(, and **GetCalc**(from the CATALOG to execute them from the home screen (Chapter 15).

Calling Other Programs as Subroutines

Calling a Program from Another Program

On the TI-84 Plus, any stored program can be called from another program as a subroutine. Enter the name of the program to use as a subroutine on a line by itself.

You can enter a program name on a command line in either of two ways.

- Press **PRGM** **◀** to display the **PRGM EXEC** menu and select the name of the program **prgmname** is pasted to the current cursor location on a command line.
- Select **prgm** from the **PRGM CTL** menu, and then enter the program name.

prgmname

When **prgmname** is encountered during execution, the next command that the program executes is the first command in the second program. It returns to the subsequent

command in the first program when it encounters either **Return** or the implied **Return** at the end of the second program.

Program

```
PROGRAM:VOLCYL
:Input "D=",D
:Input "H=",H
:PrgrmAREACIR
:A*H→V
:Disp V
```

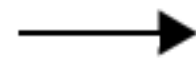

Output

```
PrgrmVOLCYL
D=4
H=5
        62.83185307
                Done
```

Subroutine ↓ ↑

```
PROGRAM:AREACIR
:D/2→R
:π*R²→A
:Return
```

Notes about Calling Programs

Variables are global.

label used with **Goto** and **Lbl** is local to the program where it is located. *label* in one program is not recognized by another program. You cannot use **Goto** to branch to a *label* in another program.

Return exits a subroutine and returns to the calling program, even if it is encountered within nested loops.

Running an Assembly Language Program

You can run programs written for the TI-84 Plus in assembly language. Typically, assembly language programs run much faster and provide greater control than the keystroke programs that you write with the built-in program editor.

Note: Because an assembly language program has greater control over the calculator, if your assembly language program has error(s), it may cause your calculator to reset and lose all data, programs, and applications stored in memory.

When you download an assembly language program, it is stored among the other programs as a **PRGM** menu item. You can:

- Transmit it using the TI-84 Plus communication link (Chapter 19).
- Delete it using the MEM MGMT DEL screen (Chapter 18).

To run an assembly Program, the syntax is: **Asm**(*assemblyprgmname*)

If you write an assembly language program, use the two instructions below from the CATALOG to identify and compile the program.

Instructions	Comments
AsmComp (<i>prgmASM1</i> , <i>prgmASM2</i>)	Compiles an assembly language program written in ASCII and stores the hex version
AsmPrgm	Identifies an assembly language program; must be entered as the first line of an assembly language program

To compile an assembly program that you have written:

1. Follow the steps for writing a program (16-4) but be sure to include **AsmPrgm** as the first line of your program.
2. From the home screen, press **[2nd]** **[CATALOG]** and then select **AsmComp(** to paste it to the screen.
3. Press **[PRGM]** to display the **PRGM EXEC** menu.
4. Select the program you want to compile. It will be pasted to the home screen.
5. Press **[,]** and then select **prgm** from the **CATALOG**.
6. Key in the name you have chosen for the output program.

Note: This name must be unique — not a copy of an existing program name.

7. Press **[)]** to complete the sequence.

The sequence of the arguments should be as follows:

AsmComp(*prgmASM1*, *prgmASM2*)

8. Press **[ENTER]** to compile your program and generate the output program.

Chapter 17: Activities

The Quadratic Formula

Entering a Calculation

Use the quadratic formula to solve the quadratic equations $3x^2 + 5x + 2 = 0$ and $2x^2 - x + 3 = 0$. Begin with the equation $3x^2 + 5x + 2 = 0$.

1. Press **3** **[STO▶]** **[ALPHA]** **[A]** (above **[MATH]**) to store the coefficient of the x^2 term.
2. Press **[ALPHA]** **[:]** (above **[.]**). The colon allows you to enter more than one instruction on a line.
3. Press **5** **[STO▶]** **[ALPHA]** **[B]** (above **[APPS]**) to store the coefficient of the X term. Press **[ALPHA]** **[:]** to enter a new instruction on the same line. Press **2** **[STO▶]** **[ALPHA]** **[C]** (above **[PRGM]**) to store the constant.
4. Press **[ENTER]** to store the values to the variables A, B, and C.

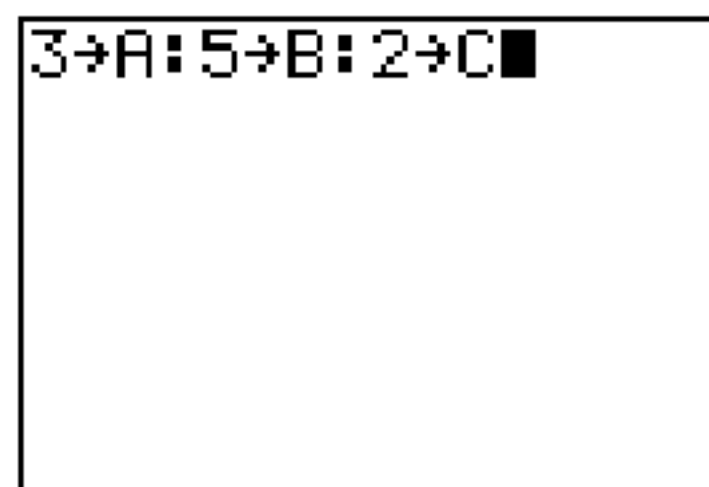

```
3→A:5→B:2→C
```

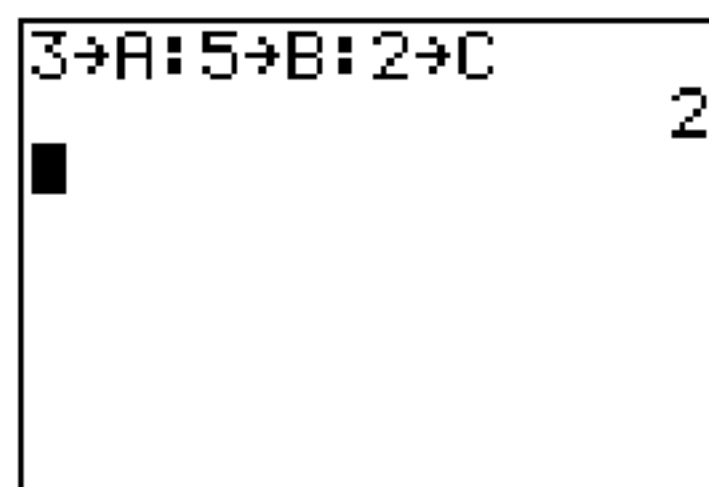

```
3→A:5→B:2→C      2
█
```

The last value you stored is shown on the right side of the display. The cursor moves to the next line, ready for your next entry.

5. Press $($ $(-)$ ALPHA $[B]$ $+$ 2nd $[\sqrt{\quad}]$ ALPHA $[B]$ x^2 $-$ 4 ALPHA $[A]$ ALPHA $[C]$ $)$ $)$ \div $($ 2 ALPHA $[A]$ $)$ to enter the expression for one of the solutions for the quadratic formula,

$$\frac{-b \pm \sqrt{b^2 - 4ac}}{2a}$$

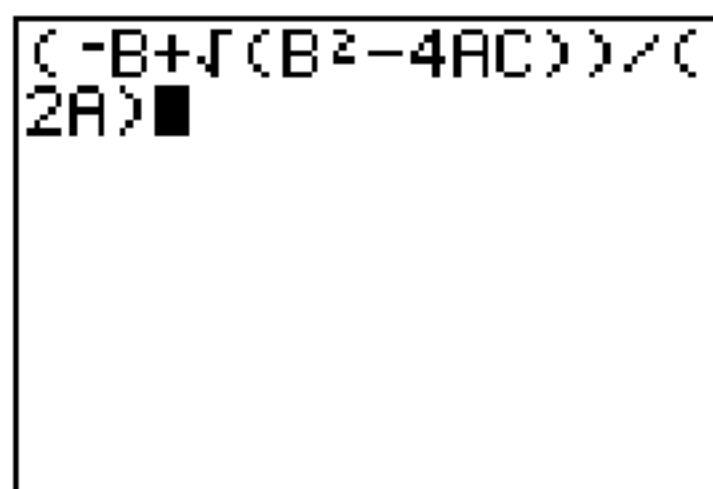

TI-84 Plus calculator screen showing the quadratic formula expression: $(-B + \sqrt{B^2 - 4AC}) / (2A)$

6. Press ENTER to find one solution for the equation $3x^2 + 5x + 2 = 0$.

The answer is shown on the right side of the display. The cursor moves to the next line, ready for you to enter the next expression.

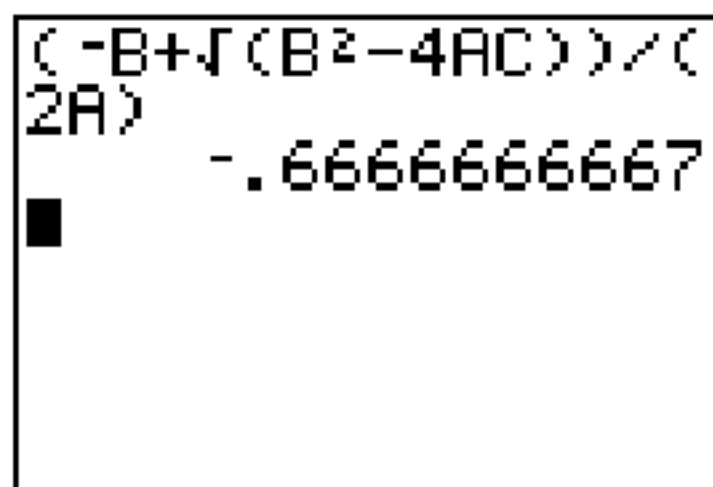

TI-84 Plus calculator screen showing the quadratic formula expression and its decimal result: $(-B + \sqrt{B^2 - 4AC}) / (2A) = -.6666666667$

Converting to a Fraction

You can show the solution as a fraction.

1. Press MATH to display the **MATH** menu.

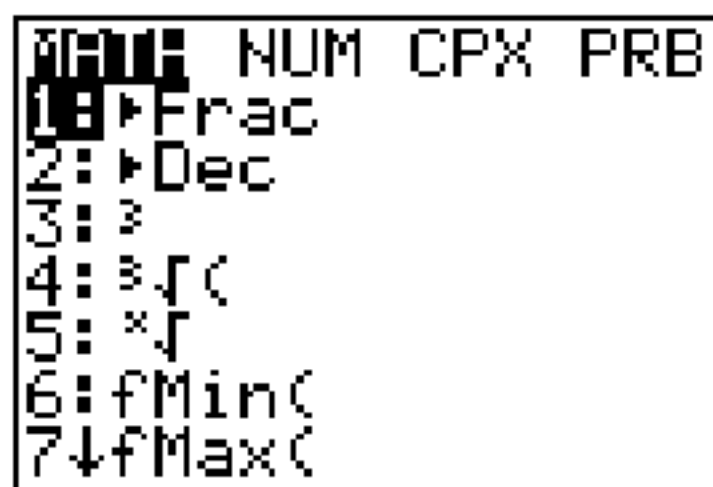

TI-84 Plus calculator MATH menu:

- 1: $\frac{\square}{\square}$ Frac
- 2: \square Dec
- 3: \square
- 4: $\sqrt[\square]{\square}$
- 5: $\sqrt{\square}$
- 6: fMin(\square)
- 7: fMax(\square)

2. Press **1** to select **1→Frac** from the **MATH** menu.

When you press **1**, **Ans→Frac** is displayed on the home screen. **Ans** is a variable that contains the last calculated answer.

```
(-B+√(B²-4AC))/(2A)
-.6666666667
Ans→Frac■
```

3. Press **ENTER** to convert the result to a fraction.

```
(-B+√(B²-4AC))/(2A)
-.6666666667
Ans→Frac
-2/3
■
```

To save keystrokes, you can recall the last expression you entered, and then edit it for a new calculation.

4. Press **2nd** **ENTRY** (above **ENTER**) to recall the fraction conversion entry, and then press **2nd** **ENTRY** again to recall the quadratic-formula expression,

$$\frac{-b + \sqrt{b^2 - 4ac}}{2a}$$

```
(-B+√(B²-4AC))/(2A)
-.6666666667
Ans→Frac
-2/3
(-B+√(B²-4AC))/(2A)■
```

5. Press \uparrow to move the cursor onto the + sign in the formula. Press \square to edit the quadratic-formula expression to become:

$$\frac{-b - \sqrt{b^2 - 4ac}}{2a}$$

```

2A)      -.6666666667
Ans▶Frac      -2/3
(-B-√(B²-4AC))/2A)
2A)      -1

```

6. Press \square to find the other solution for the quadratic equation $3x^2 + 5x + 2 = 0$.

Displaying Complex Results

Now solve the equation $2x^2 - x + 3 = 0$. When you set **a+bi** complex number mode, the TI-84 Plus displays complex results.

1. Press \square \downarrow \downarrow \downarrow \downarrow \downarrow \downarrow (6 times), and then press \rightarrow to position the cursor over **a+bi**. Press \square to select **a+bi** complex-number mode.

```

NORMAL SCI ENG
FLOAT 0 1 2 3 4 5 6 7 8 9
RADIAN DEGREE
FUNC PAR POL SEQ
CONNECTED DOT
SEQUENTIAL SIMUL
REAL a+bi P<°Q
FULL HORIZ G-T
SETCLOCK 03/18/04 2:24PM

```

2. Press $\boxed{2\text{nd}} \boxed{\text{QUIT}}$ (above $\boxed{\text{MODE}}$) to return to the home screen, and then press $\boxed{\text{CLEAR}}$ to clear it.

2->A: -1->B: 3->C
█

3. Press $2 \boxed{\text{STO}} \boxed{\text{ALPHA}} \boxed{\text{A}} \boxed{\text{ALPHA}} \boxed{[:]} \boxed{(-)} \boxed{1} \boxed{\text{STO}} \boxed{\text{ALPHA}} \boxed{\text{B}} \boxed{\text{ALPHA}} \boxed{[:]} \boxed{3} \boxed{\text{STO}} \boxed{\text{ALPHA}} \boxed{\text{C}} \boxed{\text{ENTER}}$.

The coefficient of the x^2 term, the coefficient of the X term, and the constant for the new equation are stored to A, B, and C, respectively.

4. Press $\boxed{2\text{nd}} \boxed{\text{ENTRY}}$ to recall the store instruction, and then press $\boxed{2\text{nd}} \boxed{\text{ENTRY}}$ again to recall the quadratic-formula expression,

2->A: -1->B: 3->C
(-B-√(B²-4AC))/(2A)█

$$\frac{-b - \sqrt{b^2 - 4ac}}{2a}$$

5. Press $\boxed{\text{ENTER}}$ to find one solution for the equation $2x^2 - x + 3 = 0$.

2->A: -1->B: 3->C
(-B-√(B²-4AC))/(2A)
.25-1.198957881i
█

6. Press $\boxed{2nd}$ \boxed{ENTRY} repeatedly until this quadratic-formula expression is displayed:

$$\frac{-b + \sqrt{b^2 - 4ac}}{2a}$$

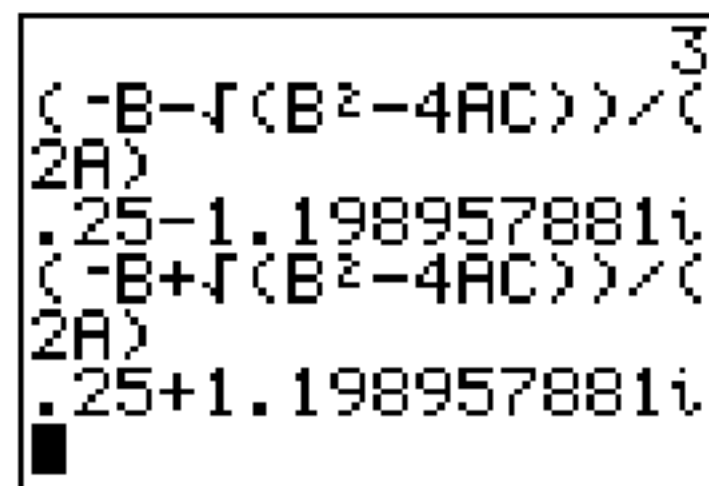

The calculator display shows the quadratic formula expression and its numerical result for a specific equation. The expression is $\frac{-B - \sqrt{B^2 - 4AC}}{2A}$ and the result is $.25 - 1.198957881i$. The expression is also shown as $\frac{-B + \sqrt{B^2 - 4AC}}{2A}$ and the result is $.25 + 1.198957881i$.

7. Press \boxed{ENTER} to find the other solution for the quadratic equation: $2x^2 - x + 3 = 0$.

Note: An alternative for solving equations for real numbers is to use the built-in Equation Solver.

Box with Lid

Defining a Function

Take a 20 cm \times 25 cm. sheet of paper and cut $X \times X$ squares from two corners. Cut $X \times 12\frac{1}{2}$ cm rectangles from the other two corners as shown in the diagram below. Fold the paper into a box with a lid. What value of X would give your box the maximum volume V ? Use the table and graphs to determine the solution.

Begin by defining a function that describes the volume of the box.

From the diagram:

$$2X + A = 20$$

$$2X + 2B = 25$$

$$V = A*B*X$$

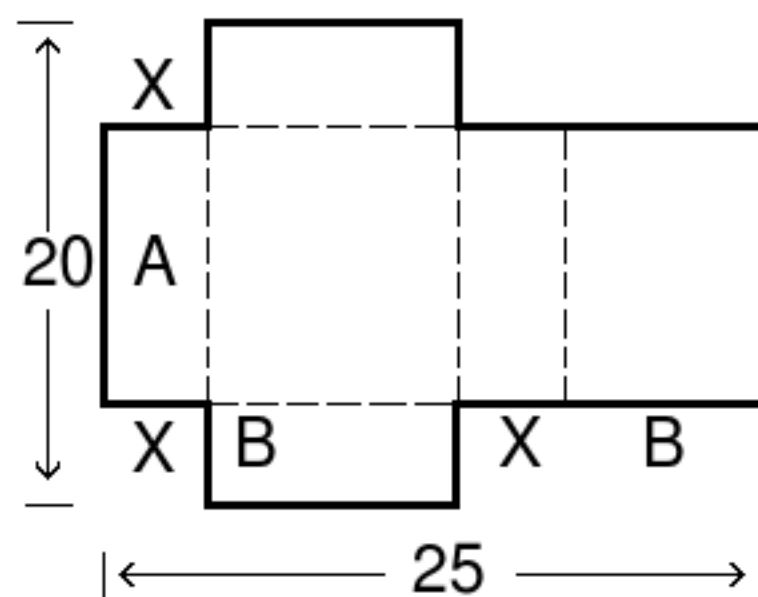

1. Press $\boxed{Y=}$ to display the $Y=$ editor, which is where you define functions for tables and graphing.

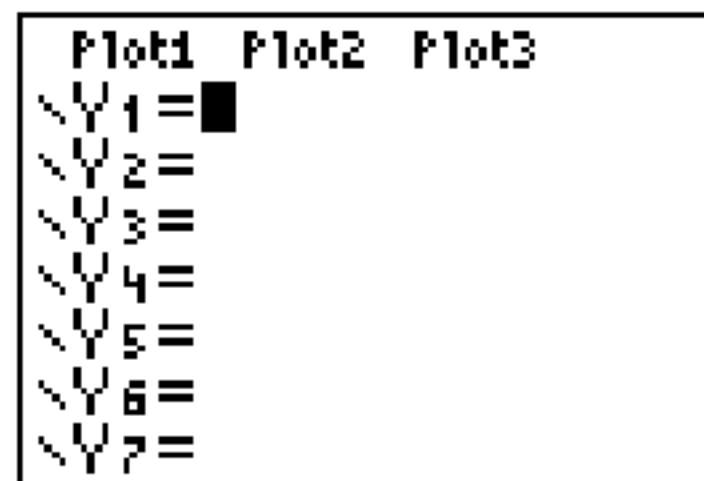

2. Press $($ 20 $-$ 2 X,T,θ,n $)$ $($ 25 \div 2 $-$ X,T,θ,n $)$ X,T,θ,n ENTER to define the volume function as **Y1** in terms of **X**.

X,T,θ,n lets you enter **X** quickly, without having to press ALPHA . The highlighted = sign indicates that **Y1** is selected.

```

Plot1 Plot2 Plot3
Y1=(20-2X)(25/2-
X)X
Y2=
Y3=
Y4=
Y5=
Y6=

```

Defining a Table of Values

The table feature of the TI-84 Plus displays numeric information about a function. You can use a table of values from the function you just defined to estimate an answer to the problem.

1. Press 2^{nd} [TBLSET] (above [WINDOW]) to display the **TABLE SETUP** menu.
2. Press ENTER to accept **TblStart=0**.
3. Press **1** ENTER to define the table increment $\Delta\text{Tbl}=1$. Leave **Indpnt: Auto** and **Depend: Auto** so that the table will be generated automatically.
4. Press 2^{nd} [TABLE] (above [GRAPH]) to display the table.

```

TABLE SETUP
TblStart=0
ΔTbl=1
Indpnt: Auto Ask
Depend: Auto Ask

```

Notice that the maximum value for **Y1** (box's volume) occurs when **X** is about **4**, between **3** and **5**.

X	Y1
0	0
1	207
2	336
3	399
4	408
5	375
6	312

X=0

- Press and hold \blacktriangledown to scroll the table until a negative result for **Y1** is displayed.

Notice that the maximum length of **X** for this problem occurs where the sign of **Y1** (box's volume) changes from positive to negative, between **10** and **11**.

X	Y1	
6	312	
7	231	
8	144	
9	63	
10	0	
11	-33	
12	-24	

X=12

- Press 2nd [TBLSET].

Notice that **TblStart** has changed to **6** to reflect the first line of the table as it was last displayed. (In step 5, the first value of **X** displayed in the table is **6**.)

TABLE SETUP		
TblStart=	6	
Δ Tbl=	1	
Indent:	Auto	Ask
Depend:	Auto	Ask

Zooming In on the Table

You can adjust the way a table is displayed to get more information about a defined function. With smaller values for Δ **Tbl**, you can zoom in on the table.

- Press **3** [ENTER] to set **TblStart**. Press . **1** [ENTER] to set Δ **Tbl**.

This adjusts the table setup to get a more accurate estimate of **X** for maximum volume **Y1**.

TABLE SETUP		
TblStart=	3	
Δ Tbl=	.1	
Indent:	Auto	Ask
Depend:	Auto	Ask

2. Press $\boxed{2nd}$ [TABLE].

3. Press $\boxed{\downarrow}$ and $\boxed{\uparrow}$ to scroll the table.

Notice that the maximum value for **Y1** is **410.26**, which occurs at **X=3.7**. Therefore, the maximum occurs where $3.6 < X < 3.8$.

X	Y1	
3.6	410.11	
3.7	410.26	
3.8	409.94	
3.9	409.19	
4	408	
4.1	406.39	
4.2	404.38	

4. Press $\boxed{2nd}$ [TBLSET]. Press $3 \boxed{.} 6 \boxed{ENTER}$ to set **TblStart**. Press $\boxed{.} 01 \boxed{ENTER}$ to set **ΔTbl**.

TABLE SETUP
TblStart=3.6
ΔTbl=.01
Indent: \boxed{Auto} Ask
Depend: \boxed{Auto} Ask

5. Press $\boxed{2nd}$ [TABLE], and then press $\boxed{\downarrow}$ and $\boxed{\uparrow}$ to scroll the table.

Four equivalent maximum values are shown, **410.26** at **X=3.67, 3.68, 3.69, and 3.70**.

X	Y1	
3.66	410.25	
3.67	410.26	
3.68	410.26	
3.69	410.26	
3.7	410.26	
3.71	410.25	
3.72	410.23	

6. Press $\boxed{\downarrow}$ or $\boxed{\uparrow}$ to move the cursor to **3.67**. Press $\boxed{\rightarrow}$ to move the cursor into the **Y1** column.

The value of **Y1** at **X=3.67** is displayed on the bottom line in full precision as **410.261226**.

X	Y1	
3.66	410.25	
3.67	410.26	
3.68	410.26	
3.69	410.26	
3.7	410.26	
3.71	410.25	
3.72	410.23	

Y1=410.261226

7. Press \square to display the other maximum.

The value of **Y1** at **X=3.68** in full precision is **410.264064**, at **X=3.69** is **410.262318** and at **X=3.7** is **410.256**.

The maximum volume of the box would occur at **3.68** if you could measure and cut the paper at .01-centimeter increments.

X	Y1	
3.66	410.25	
3.67	410.26	
3.68	410.264064	
3.69	410.26	
3.7	410.256	
3.71	410.25	
3.72	410.23	
Y1=410.264064		

Setting the Viewing Window

You also can use the graphing features of the TI-84 Plus to find the maximum value of a previously defined function. When the graph is activated, the viewing window defines the displayed portion of the coordinate plane. The values of the window variables determine the size of the viewing window.

1. Press **WINDOW** to display the window editor, where you can view and edit the values of the window variables.

```
WINDOW
Xmin=-10
Xmax=10
Xscl=1
Ymin=-10
Ymax=10
Yscl=1
Xres=1
```

The standard window variables define the viewing window as shown. **Xmin**, **Xmax**, **Ymin**, and **Ymax** define the boundaries of the display. **Xscl** and **Yscl** define the distance between tick marks on the **X** and **Y** axes. **Xres** controls resolution.

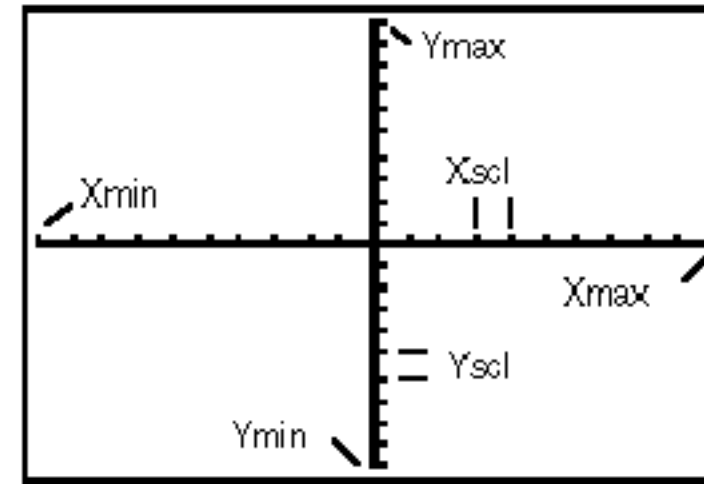

2. Press **0** **[ENTER]** to define **Xmin**.
3. Press **20** **[÷]** **2** to define **Xmax** using an expression.
4. Press **[ENTER]**. The expression is evaluated, and **10** is stored in **Xmax**. Press **[ENTER]** to accept **Xscl** as **1**.
5. Press **0** **[ENTER]** **500** **[ENTER]** **100** **[ENTER]** **1** **[ENTER]** to define the remaining window variables.

```
WINDOW
Xmin=0
Xmax=20/2
Xscl=1
Ymin=-10
Ymax=10
Yscl=1
Xres=1
```

```
WINDOW
Xmin=0
Xmax=10
Xscl=1
Ymin=0
Ymax=500
Yscl=100
Xres=1
```

Displaying and Tracing the Graph

Now that you have defined the function to be graphed and the window in which to graph it, you can display and explore the graph. You can trace along a function using the **TRACE** feature.

1. Press **GRAPH** to graph the selected function in the viewing window.

The graph of $Y1=(20-2X)(25/2-X)X$ is displayed.

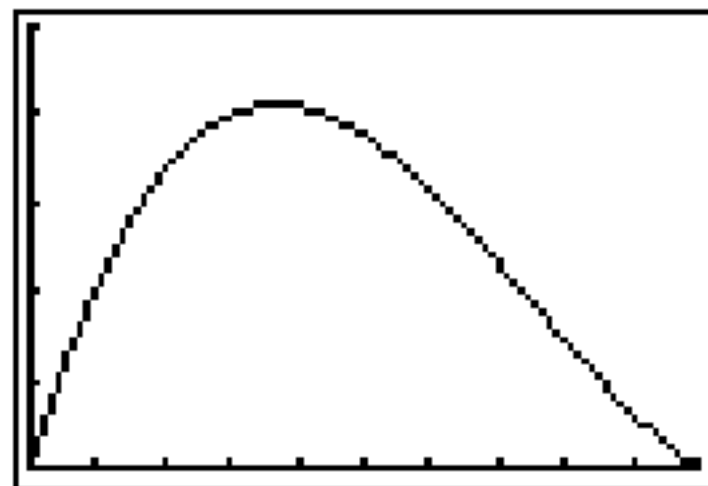

2. Press **▸** to activate the free-moving graph cursor.

The **X** and **Y** coordinate values for the position of the graph cursor are displayed on the bottom line.

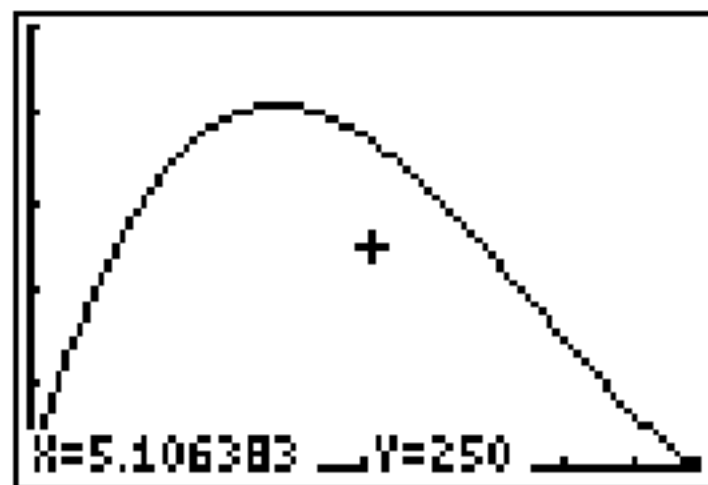

3. Press **◀**, **▶**, **▲**, and **▼** to move the free-moving cursor to the apparent maximum of the function.

As you move the cursor, the **X** and **Y** coordinate values are updated continually.

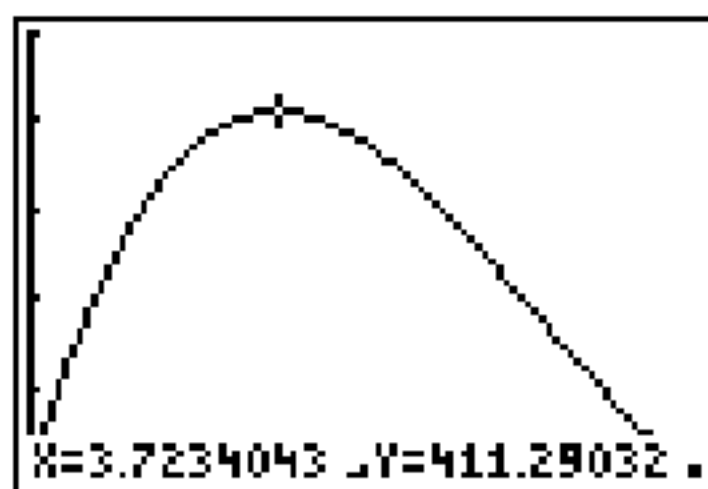

4. Press **TRACE**. The trace cursor is displayed on the **Y1** function.

The function that you are tracing is displayed in the top-left corner.

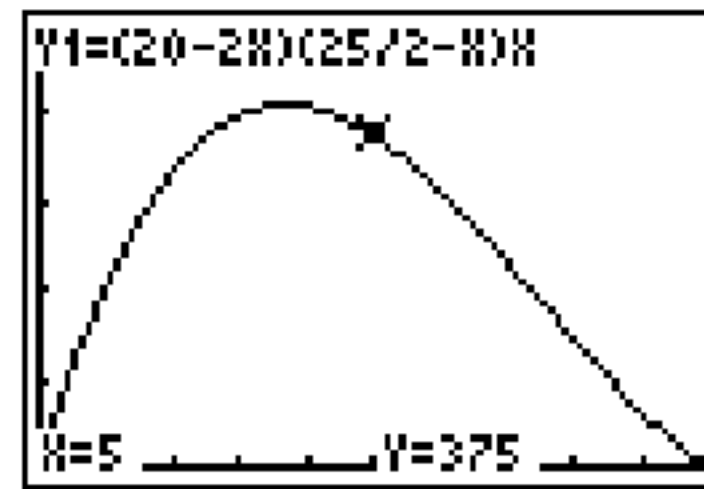

5. Press **◀** and **▶** to trace along **Y1**, one **X** dot at a time, evaluating **Y1** at each **X**.

You also can enter your estimate for the maximum value of **X**.

6. Press **3** **□** **8**. When you press a number key while in **TRACE**, the **X=** prompt is displayed in the bottom-left corner.

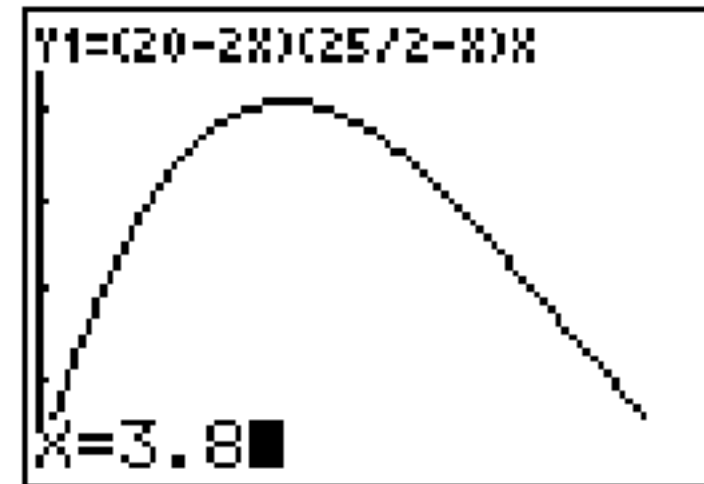

7. Press **ENTER**.

The trace cursor jumps to the point on the **Y1** function evaluated at **X=3.8**.

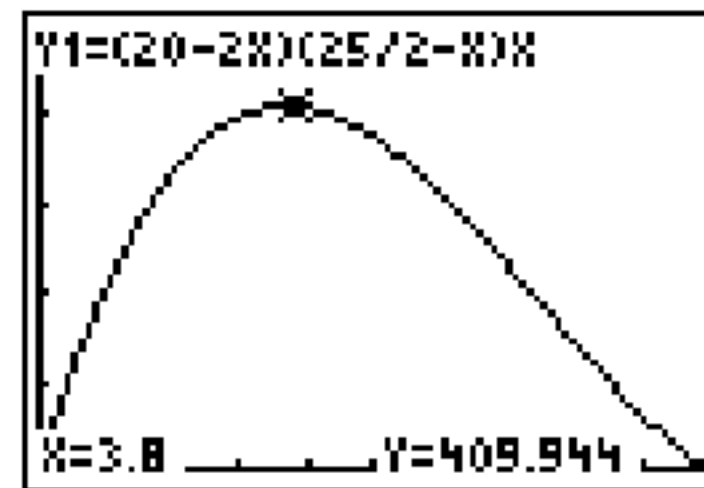

8. Press **◀** and **▶** until you are on the maximum **Y** value.

This is the maximum of **Y1(X)** for the **X** pixel values. The actual, precise maximum may lie between pixel values.

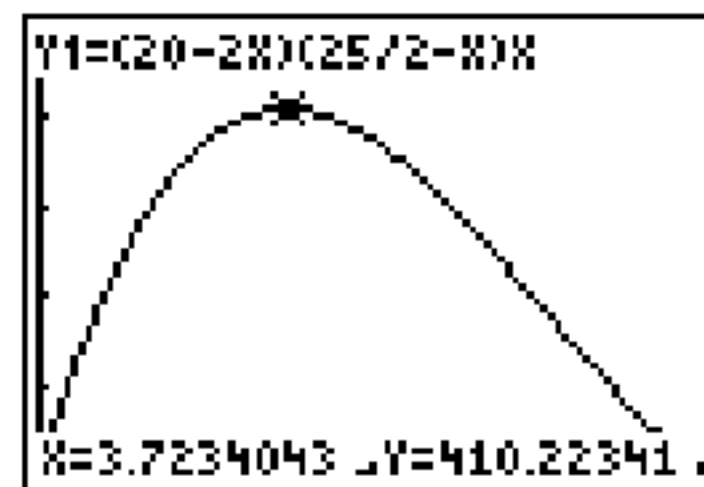

Zooming In on the Graph

To help identify maximums, minimums, roots, and intersections of functions, you can magnify the viewing window at a specific location using the **ZOOM** instructions.

1. Press **ZOOM** to display the **ZOOM** menu.

This menu is a typical TI-84 Plus menu. To select an item, you can either press the number or letter next to the item, or you can press **↓** until the item number or letter is highlighted, and then press **ENTER**.

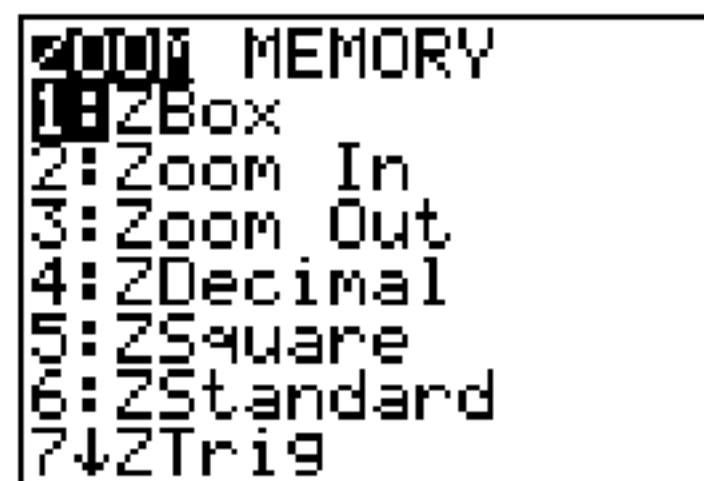

2. Press **2** to select **2:Zoom In**.

The graph is displayed again. The cursor has changed to indicate that you are using a **ZOOM** instruction.

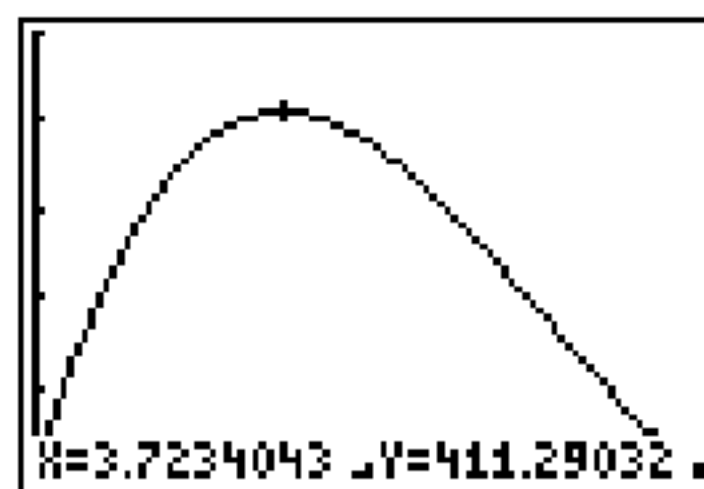

3. With the cursor near the maximum value of the function, press **ENTER**.

The new viewing window is displayed. Both **Xmax-Xmin** and **Ymax-Ymin** have been adjusted by factors of 4, the default values for the zoom factors.

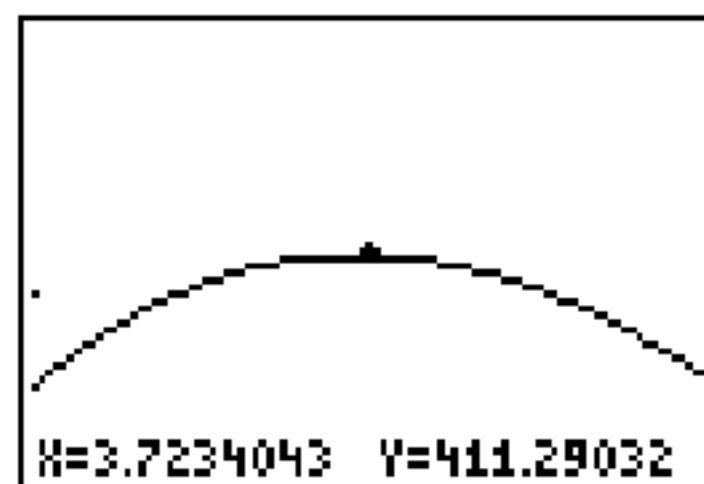

4. Press **WINDOW** to display the new window settings.

```
WINDOW
Xmin=2.4734042...
Xmax=4.9734042...
Xscl=1
Ymin=348.79032...
Ymax=473.79032...
Yscl=100
Xres=1
```

Finding the Calculated Maximum

You can use a **CALCULATE** menu operation to calculate a local maximum of a function.

1. Press **2nd** **[CALC]** (above **TRACE**) to display the **CALCULATE** menu. Press **4** to select **4:maximum**.

The graph is displayed again with a **Left Bound?** prompt.

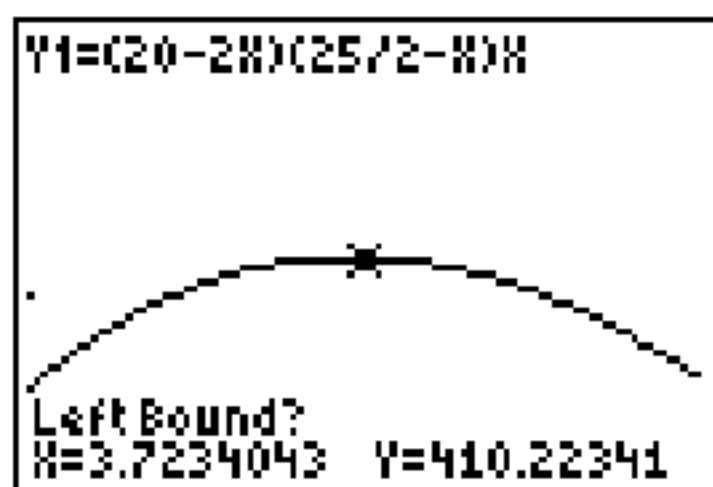

2. Press **←** to trace along the curve to a point to the left of the maximum, and then press **ENTER**.

A **▶** at the top of the screen indicates the selected bound.

A **Right Bound?** prompt is displayed.

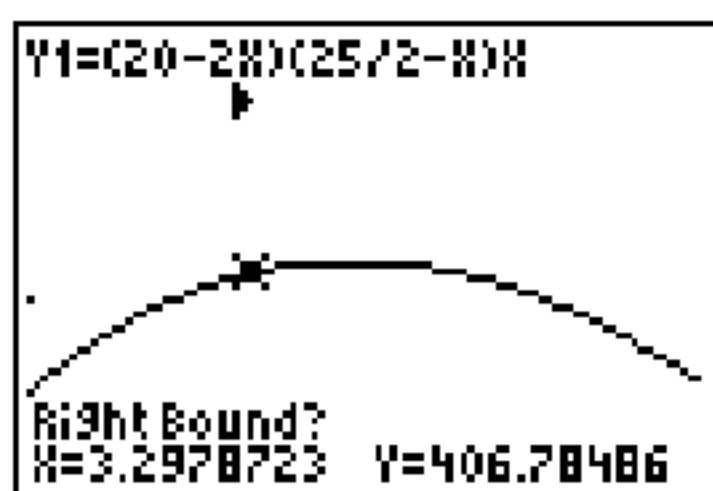

- Press \rightarrow to trace along the curve to a point to the right of the maximum, and then press ENTER .

A \blacktriangleleft at the top of the screen indicates the selected bound.

A **Guess?** prompt is displayed.

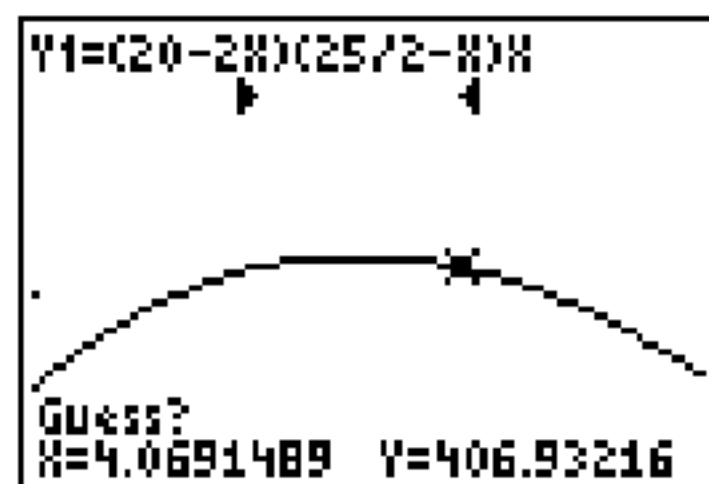

- Press \leftarrow to trace to a point near the maximum, and then press ENTER .

Or, press $3 \square 8$, and then press ENTER to enter a guess for the maximum.

When you press a number key in **TRACE**, the **X=** prompt is displayed in the bottom-left corner.

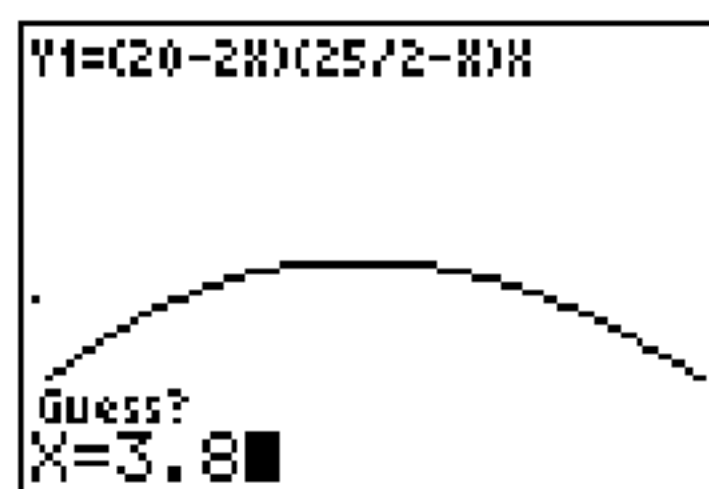

Notice how the values for the calculated maximum compare with the maximums found with the free-moving cursor, the trace cursor, and the table.

Note: In steps 2 and 3 above, you can enter values directly for Left Bound and Right Bound, in the same way as described in step 4.

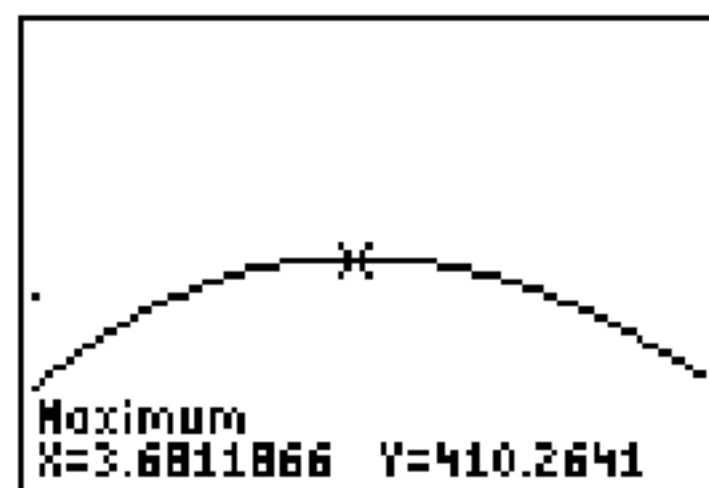

Comparing Test Results Using Box Plots

Problem

An experiment found a significant difference between boys and girls pertaining to their ability to identify objects held in their left hands, which are controlled by the right side of their brains, versus their right hands, which are controlled by the left side of their brains. The TI Graphics team conducted a similar test for adult men and women.

The test involved 30 small objects, which participants were not allowed to see. First, they held 15 of the objects one by one in their left hands and guessed what they were. Then they held the other 15 objects one by one in their right hands and guessed what they were. Use box plots to compare visually the correct-guess data from this table.

Each row in the table represents the results observed for one subject. Note that 10 women and 12 men were tested.

Correct Guesses			
Women Left	Women Right	Men Left	Men Right
8	4	7	12
9	1	8	6
12	8	7	12
11	12	5	12
10	11	7	7
8	11	8	11
12	13	11	12

Correct Guesses			
Women Left	Women Right	Men Left	Men Right
7	12	4	8
9	11	10	12
11	12	14	11
		13	9
		5	9

Procedure

1. Press **[STAT]** **5** to select **5:SetUpEditor**. Enter list names **WLEFT**, **WRGHT**, **MLEFT**, and **MRGHT**, separated by commas. Press **[ENTER]**. The stat list editor now contains only these four lists.
2. Press **[STAT]** **1** to select **1:Edit**.
3. Enter into **WLEFT** the number of correct guesses each woman made using her left hand (**Women Left**). Press **[▶]** to move to **WRGHT** and enter the number of correct guesses each woman made using her right hand (**Women Right**).
4. Likewise, enter each man's correct guesses in **MLEFT** (**Men Left**) and **MRGHT** (**Men Right**).
5. Press **[2nd]** **[STAT PLOT]**. Select **1:Plot1**. Turn on plot 1; define it as a modified box plot  that uses **WLEFT**. Move the cursor to the top line and select **Plot2**. Turn on plot 2; define it as a modified box plot that uses **WRGHT**.
6. Press **[Y=]**. Turn off all functions.

7. Press **WINDOW**. Set **Xscl=1** and **Yscl=0**. Press **ZOOM 9** to select **9:ZoomStat**. This adjusts the viewing window and displays the box plots for the women's results.
8. Press **TRACE**.

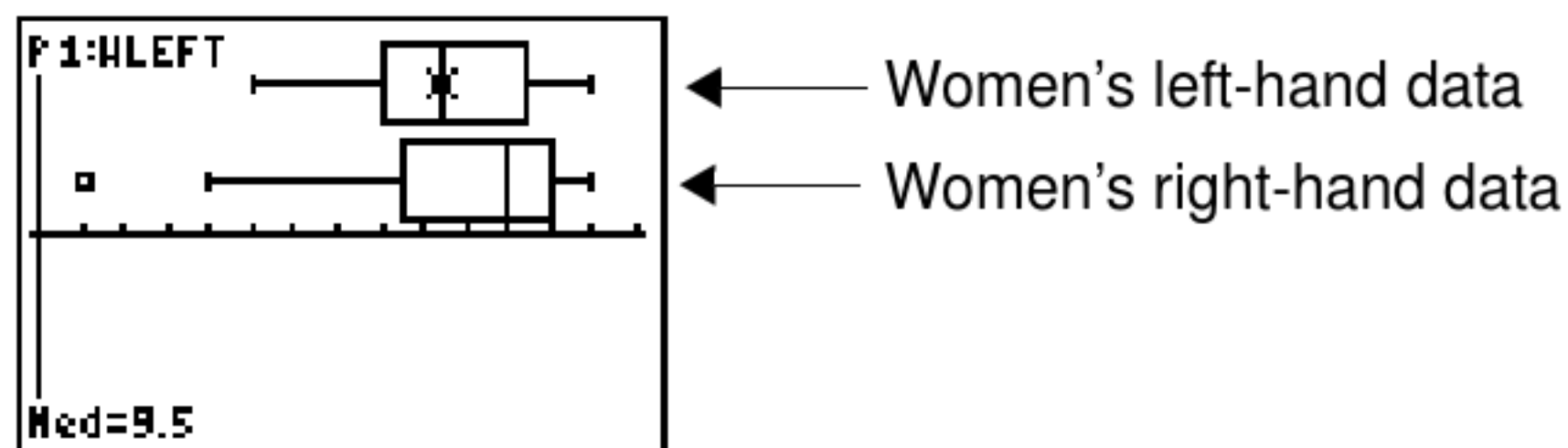

Use **◀** and **▶** to examine **minX**, **Q1**, **Med**, **Q3**, and **maxX** for each plot. Notice the outlier to the women's right-hand data. What is the median for the left hand? For the right hand? With which hand were the women more accurate guessers, according to the box plots?

9. Examine the men's results. Redefine plot 1 to use **MLEFT**, redefine plot 2 to use **MRGHT**. Press **TRACE**.

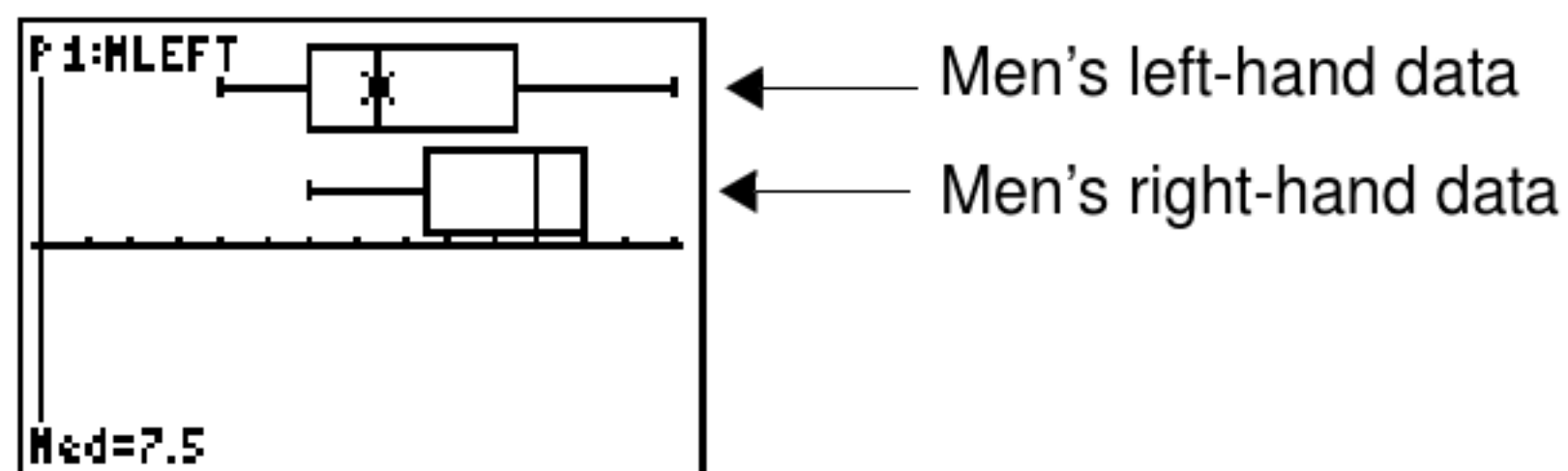

Press **◀** and **▶** to examine **minX**, **Q1**, **Med**, **Q3**, and **maxX** for each plot. What difference do you see between the plots?

10. Compare the left-hand results. Redefine plot 1 to use **WLEFT**, redefine plot 2 to use **MLEFT**, and then press **TRACE** to examine **minX**, **Q1**, **Med**, **Q3**, and **maxX** for each plot. Who were the better left-hand guessers, men or women?

11. Compare the right-hand results. Define plot 1 to use **WRGHT**, define plot 2 to use **MRGHT**, and then press **TRACE** to examine **minX**, **Q1**, **Med**, **Q3**, and **maxX** for each plot. Who were the better right-hand guessers?

In the original experiment boys did not guess as well with right hands, while girls guessed equally well with either hand. This is not what our box plots show for adults. Do you think that this is because adults have learned to adapt or because our sample was not large enough?

Graphing Piecewise Functions

Problem

The fine for speeding on a road with a speed limit of 45 kilometers per hour (kph) is 50; plus 5 for each kph from 46 to 55 kph; plus 10 for each kph from 56 to 65 kph; plus 20 for each kph from 66 kph and above. Graph the piecewise function that describes the cost of the ticket.

The fine (Y) as a function of kilometers per hour (X) is:

$$\begin{array}{ll} Y = 0 & 0 < X \leq 45 \\ Y = 50 + 5(X - 45) & 45 < X \leq 55 \\ Y = 50 + 5 * 10 + 10(X - 55) & 55 < X \leq 65 \\ Y = 50 + 5 * 10 + 10 * 10 + 20(X - 65) & 65 < X \end{array}$$

Procedure

1. Press **MODE**. Select **Func** and the default settings.
2. Press **Y=**. Turn off all functions and stat plots. Enter the **Y=** function to describe the fine. Use the **TEST** menu operations to define the piecewise function. Set the graph style for **Y1** to **.** (dot).

```
Plot1 Plot2 Plot3
Y1=(50+5(X-45))
(45<X)(X≤55)+(10
0+10(X-55))(55<X
)(X≤65)+(200+20(
X-65))(65<X)
Y2=
Y3=
```

3. Press **WINDOW** and set **Xmin=-2**, **Xscl=10**, **Ymin=-5**, and **Yscl=10**. Ignore **Xmax** and **Ymax**; they are set by ΔX and ΔY in step 4.
4. Press **2nd** **[QUIT]** to return to the home screen. Store **1** to ΔX , and then store **5** to ΔY . ΔX and ΔY are on the **VARS Window X/Y** secondary menu. ΔX and ΔY specify the horizontal and vertical distance between the centers of adjacent pixels. Integer values for ΔX and ΔY produce nice values for tracing.
5. Press **TRACE** to plot the function. At what speed does the ticket exceed 250?

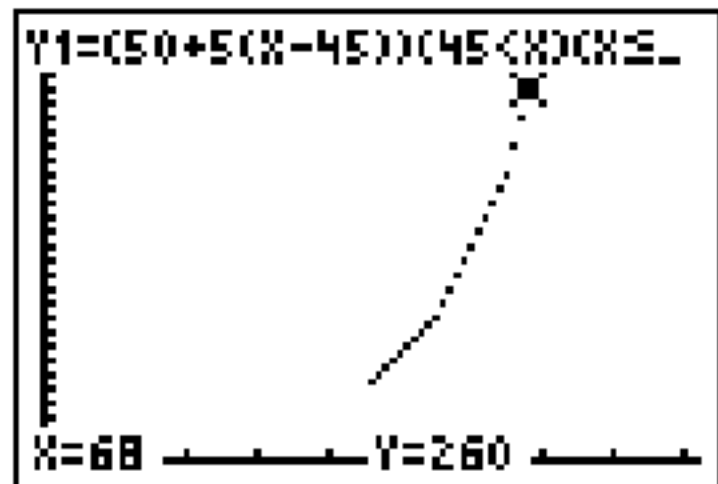

Graphing Inequalities

Problem

Graph the inequality $0.4x^3 - 3x + 5 < 0.2x + 4$. Use the **TEST** menu operations to explore the values of X where the inequality is true and where it is false.

Procedure

1. Press **MODE**. Select **Dot**, **Simul**, and the default settings. Setting **Dot** mode changes all graph style icons to \cdot (dot) in the **Y=** editor.
2. Press **Y=**. Turn off all functions and stat plots. Enter the left side of the inequality as **Y4** and the right side as **Y5**.

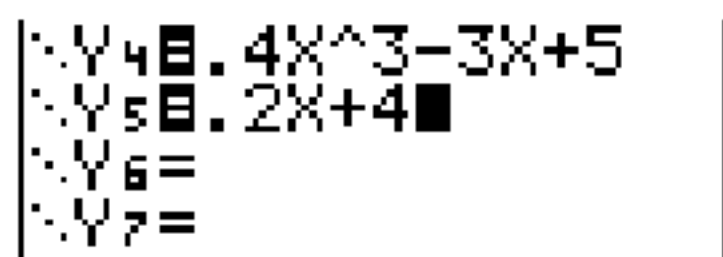

```
Y4 = .4X^3-3X+5
Y5 = .2X+4
Y6 =
Y7 =
```

3. Enter the statement of the inequality as **Y6**. This function evaluates to **1** if true or **0** if false.

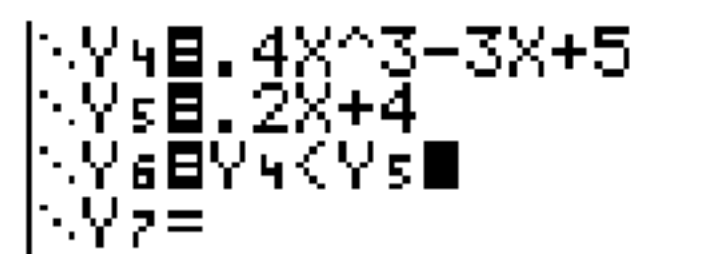

```
Y4 = .4X^3-3X+5
Y5 = .2X+4
Y6 = Y4 < Y5
Y7 =
```

4. Press **ZOOM** **6** to graph the inequality in the standard window.
5. Press **TRACE** \downarrow \downarrow to move to **Y6**. Then press \leftarrow and \rightarrow to trace the inequality, observing the value of **Y**.

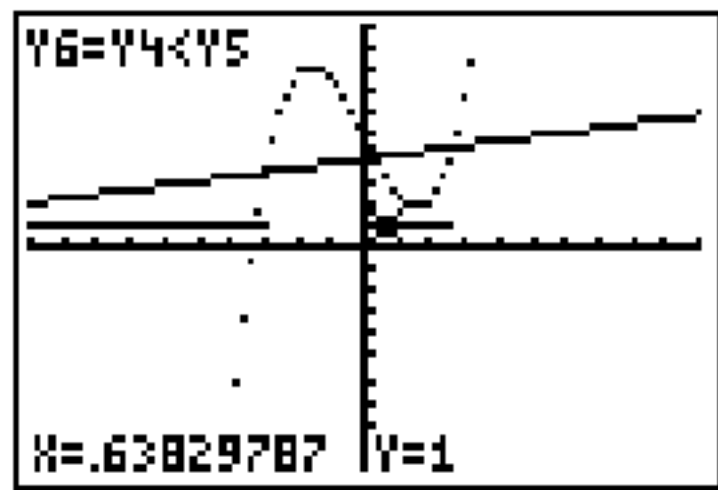

6. Press $\boxed{Y=}$. Turn off **Y4**, **Y5**, and **Y6**. Enter equations to graph only the inequality.

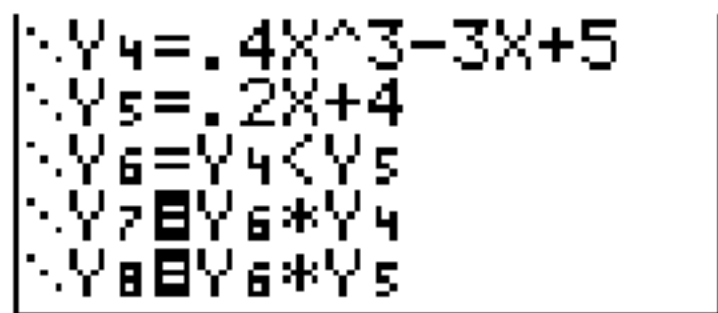

7. Press $\boxed{\text{TRACE}}$. Notice that the values of **Y7** and **Y8** are zero where the inequality is false.

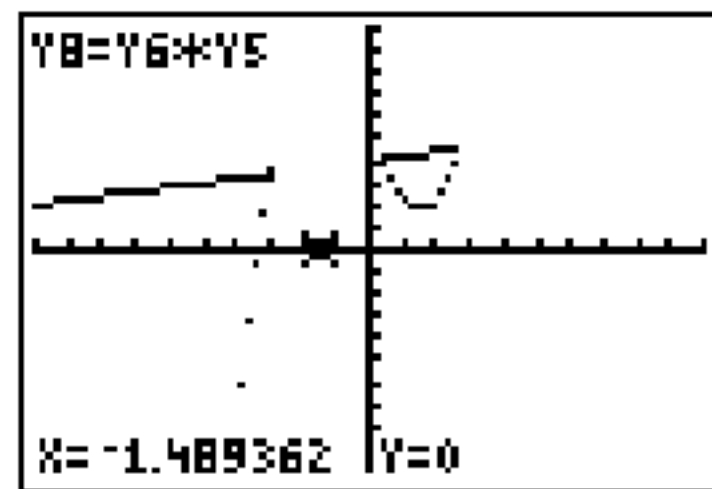
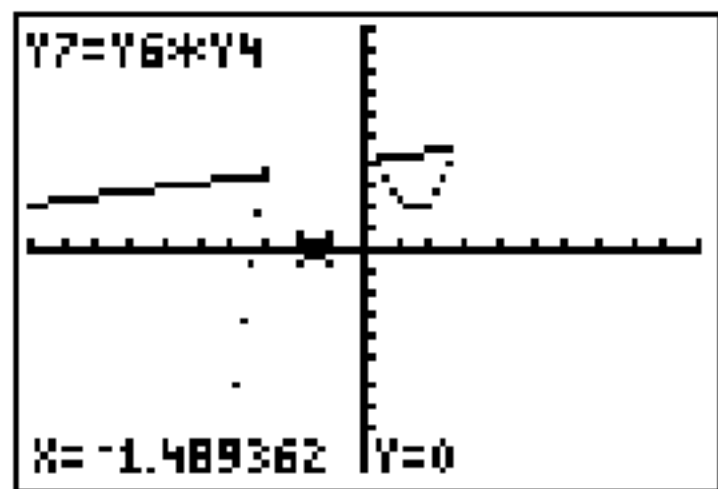

Solving a System of Nonlinear Equations

Problem

Using a graph, solve the equation $x^3 - 2x = 2\cos(x)$. Stated another way, solve the system of two equations and two unknowns: $y = x^3 - 2x$ and $y = 2\cos(x)$. Use **ZOOM** factors to control the decimal places displayed on the graph.

Procedure

1. Press **[MODE]**. Select the default mode settings. Press **[Y=]**. Turn off all functions and stat plots. Enter the functions.

```
\Y1 = X3 - 2X  
\Y2 = 2cos(X)
```

2. Press **[ZOOM]** **4** to select **4:ZDecimal**. The display shows that two solutions may exist (points where the two functions appear to intersect).

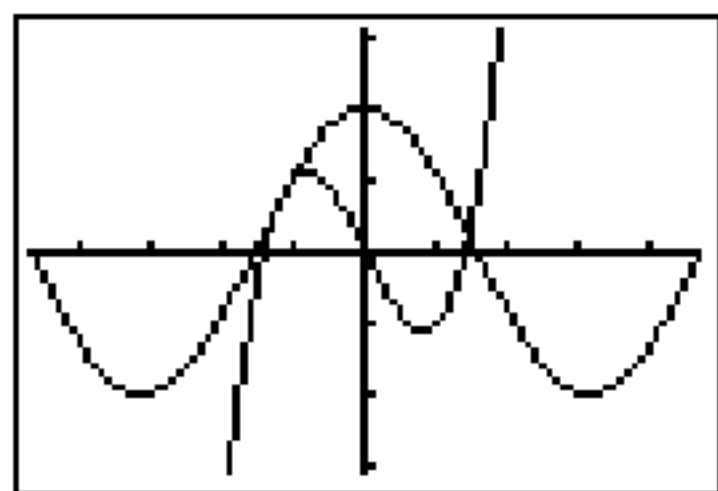

3. Press **[ZOOM]** **[>]** **4** to select **4:SetFactors** from the **ZOOM MEMORY** menu. Set **XFact=10** and **YFact=10**.

4. Press **ZOOM** 2 to select **2:Zoom In**. Use \leftarrow , \rightarrow , \uparrow , and \downarrow to move the free-moving cursor onto the apparent intersection of the functions on the right side of the display. As you move the cursor, notice that the **X** and **Y** values have one decimal place.
5. Press **ENTER** to zoom in. Move the cursor over the intersection. As you move the cursor, notice that now the **X** and **Y** values have two decimal places.
6. Press **ENTER** to zoom in again. Move the free-moving cursor onto a point exactly on the intersection. Notice the number of decimal places.
7. Press **2nd** [CALC] 5 to select **5:intersect**. Press **ENTER** to select the first curve and **ENTER** to select the second curve. To guess, move the trace cursor near the intersection. Press **ENTER**. What are the coordinates of the intersection point?
8. Press **ZOOM** 4 to select **4:ZDecimal** to redisplay the original graph.
9. Press **ZOOM**. Select **2:Zoom In** and repeat steps 4 through 8 to explore the apparent function intersection on the left side of the display.

Using a Program to Create the Sierpinski Triangle

Setting up the Program

This program creates a drawing of a famous fractal, the Sierpinski Triangle, and stores the drawing to a picture. To begin, press `PRGM` `▶` `▶` **1**. Name the program **SIERPINS**, and then press `ENTER`. The program editor is displayed.

Program

```
PROGRAM:SIERPINS  
:FnOff :ClrDraw  
:PlotsOff  
:AxesOff
```

```
:0→Xmin:1→Xmax  
:0→Ymin:1→Ymax
```

} Set viewing window.

```
:rand→X:rand→Y
```

```
:For (K, 1, 3000)  
:rand→N
```

} Beginning of **For** group.

```
:If N≤1/3  
:Then  
:.5X→X  
:.5Y→Y  
:End
```

} **If/Then** group

```
:If 1/3 < N and N ≤ 2/3
:Then
:.5 (.5 + X) → X
:.5 (1 + Y) → Y
:End
```

} **If/Then** group.

```
:If 2/3 < N
:Then
:.5 (1 + X) → X
:.5 Y → Y
:End
```

} **If/Then** group.

```
:Pt-On (X, Y)
:End
:StorePic 6
```

Draw point.
End of **For** group.
Store picture.

After you execute the program above, you can recall and display the picture with the instruction **RecallPic 6**.

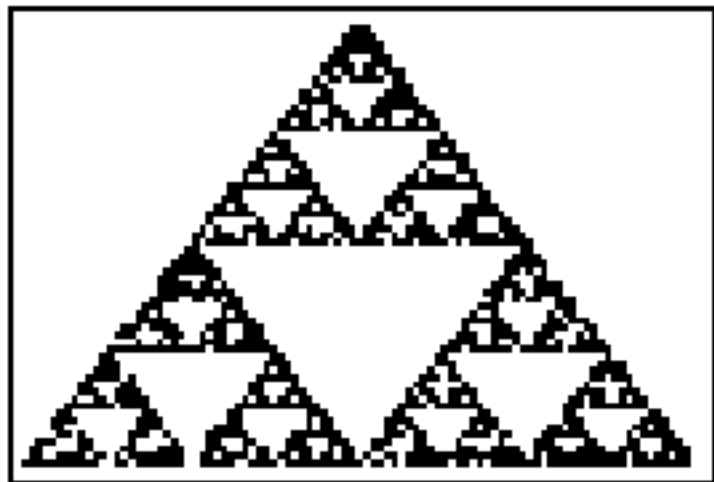

Graphing Cobweb Attractors

Problem

Using **Web** format, you can identify points with attracting and repelling behavior in sequence graphing.

Procedure

1. Press **[MODE]**. Select **Seq** and the default mode settings. Press **[2nd]** **[FORMAT]**. Select **Web** format and the default format settings.
2. Press **[Y=]**. Clear all functions and turn off all stat plots. Enter the sequence that corresponds to the expression $Y = K X(1-X)$.

$$u(n)=Ku(n-1)(1-u(n-1))$$

$$u(nMin)=.01$$

3. Press **[2nd]** **[QUIT]** to return to the home screen, and then store **2.9** to **K**.
4. Press **[WINDOW]**. Set the window variables.

$$nMin=0$$

$$Xmin=0$$

$$Ymin=-.26$$

$$nMax=10$$

$$Xmax=1$$

$$Ymax=1.1$$

$$PlotStart=1$$

$$Xscl=1$$

$$Yscl=1$$

$$PlotStep=1$$

5. Press **[TRACE]** to display the graph, and then press **[▶]** to trace the cobweb. This is a cobweb with one attractor.

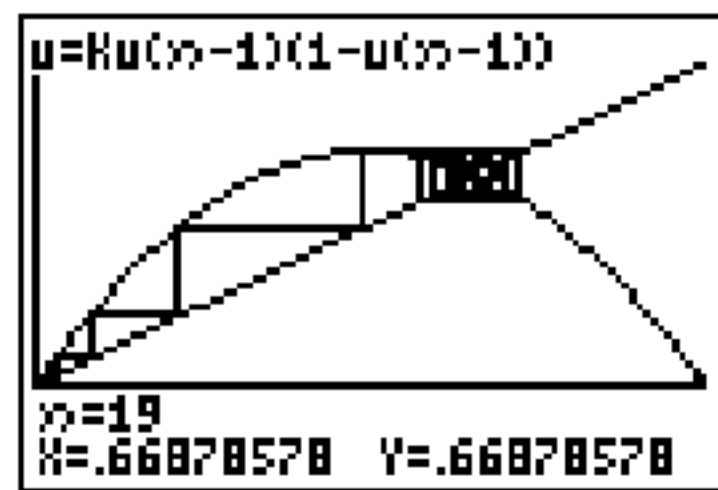

6. Change **K** to **3.44** and trace the graph to show a cobweb with two attractors.
7. Change **K** to **3.54** and trace the graph to show a cobweb with four attractors.

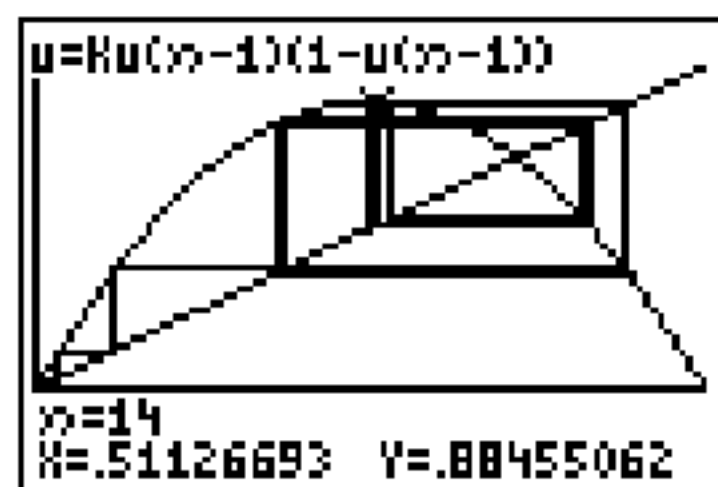

Using a Program to Guess the Coefficients

Setting Up the Program

This program graphs the function $A \sin(BX)$ with random integer coefficients between 1 and 10. Try to guess the coefficients and graph your guess as $C \sin(DX)$. The program continues until your guess is correct.

Program

```
PROGRAM:GUESS
:PlotsOff :Func
:FnOff :Radian
:ClrHome

:"Asin(BX)"→Y1      } Define equations.
:"Csin(DX)"→Y2

:GraphStyle(1,1)    } Set line and path graph styles.
:GraphStyle(2,5)

:FnOff 2

:randInt(1,10)→A    } Initialize coefficients.
:randInt(1,10)→B
:0→C:0→D
```

```

:-2π→Xmin
:2π→Xmax
:π/2→Xscl
:-10→Ymin
:10→Ymax
:1→Yscl

```

} Set viewing window.

```

:DispGraph
:Pause

```

} Display graph.

```

:FnOn 2
:Lbl Z

:Prompt C,D

```

Prompt for guess.

```

:DispGraph
:Pause

```

} Display graph.

```

:If C=A
:Text(1,1,"C IS OK")
:If C≠A
:Text(1,1,"C IS
WRONG")
:If D=B
:Text(1,50,"D IS OK")
:If D≠B
:Text(1,50,"D IS
WRONG")

```

} Display results.

```

:DispGraph
:Pause

```

} Display graph.

```
:If C=A and D=B  
:Stop  
:Goto Z
```

} Quit if guesses are correct.

Graphing the Unit Circle and Trigonometric Curves

Problem

Using parametric graphing mode, graph the unit circle and the sine curve to show the relationship between them.

Any function that can be plotted in **Func** mode can be plotted in **Par** mode by defining the **X** component as **T** and the **Y** component as **F(T)**.

Procedure

1. Press **MODE**. Select **Par**, **Simul**, and the default settings.
2. Press **WINDOW**. Set the viewing window.

Tmin=0	Xmin=-2	Ymin=-3
Tmax=2π	Xmax=7.4	Ymax=3
Tstep=.1	Xscl=$\pi/2$	Yscl=1

3. Press **Y=**. Turn off all functions and stat plots. Enter the expressions to define the unit circle centered on (0,0).

```
Plot1 Plot2 Plot3
X1T cos(T)
Y1T sin(T)
X2T T
Y2T sin(T)
```

4. Enter the expressions to define the sine curve.

```

Plot1 Plot2 Plot3
X1T  $\cos(T)$ 
Y1T  $\sin(T)$ 
X2T  $T$ 
Y2T  $\sin(T)$ 

```

5. Press **TRACE**. As the graph is plotting, you may press **ENTER** to pause and **ENTER** again to resume graphing as you watch the sine function “unwrap” from the unit circle.

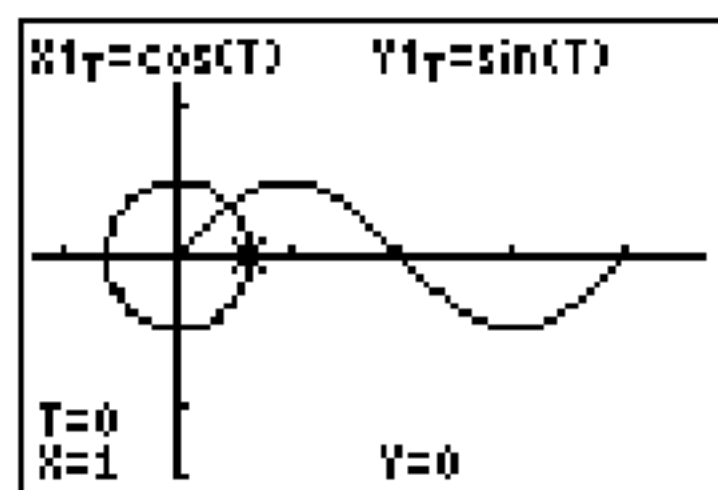

Note: You can generalize the unwrapping. Replace **sin(T)** in **Y2T** with any other trig function to unwrap that function.

Finding the Area between Curves

Problem

Find the area of the region bounded by:

$$f(x) = 300x / (x^2 + 625)$$

$$g(x) = 3\cos(.1x)$$

$$x = 75$$

Procedure

1. Press **MODE**. Select the default mode settings.
2. Press **WINDOW**. Set the viewing window.

Xmin=0	Ymin=-5	Xres=1
Xmax=100	Ymax=10	
Xscl=10	Yscl=1	

3. Press **Y=**. Turn off all functions and stat plots. Enter the upper and lower functions.

$$Y1=300X/(X^2+625)$$

$$Y2=3\cos(.1X)$$

4. Press **2nd** **[CALC]** **5** to select **5:Intersect**. The graph is displayed. Select a first curve, second curve, and guess for the intersection toward the left side of the display. The solution is displayed, and the value of **X** at the intersection, which is the lower limit of the integral, is stored in **Ans** and **X**.

5. Press $\boxed{2\text{nd}}$ [QUIT] to go to the home screen. Press $\boxed{2\text{nd}}$ [DRAW] 7 and use **Shade(** to see the area graphically.

Shade(Y2,Y1,Ans,75)

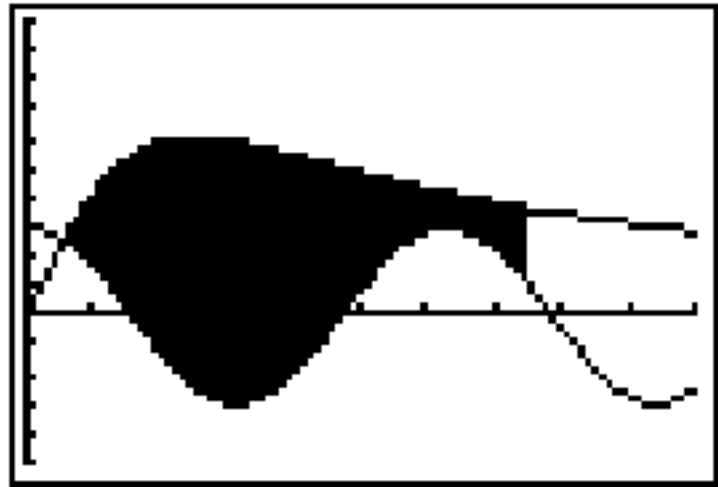

6. Press $\boxed{2\text{nd}}$ [QUIT] to return to the home screen. Enter the expression to evaluate the integral for the shaded region.

fnInt(Y1-Y2,X,Ans,75)

The area is **325.839962**.

Using Parametric Equations: Ferris Wheel Problem

Problem

Using two pairs of parametric equations, determine when two objects in motion are closest to each other in the same plane.

A ferris wheel has a diameter (d) of 20 meters and is rotating counterclockwise at a rate (s) of one revolution every 12 seconds. The parametric equations below describe the location of a ferris wheel passenger at time T , where α is the angle of rotation, $(0,0)$ is the bottom center of the ferris wheel, and $(10,10)$ is the passenger's location at the rightmost point, when $T=0$.

$$\begin{aligned} X(T) &= r \cos \alpha && \text{where } \alpha = 2\pi Ts \text{ and } r = d/2 \\ Y(T) &= r + r \sin \alpha \end{aligned}$$

A person standing on the ground throws a ball to the ferris wheel passenger. The thrower's arm is at the same height as the bottom of the ferris wheel, but 25 meters (b) to the right of the ferris wheel's lowest point $(25,0)$. The person throws the ball with velocity (v_0) of 22 meters per second at an angle (θ) of 66° from the horizontal. The parametric equations below describe the location of the ball at time T .

$$\begin{aligned} X(T) &= b - Tv_0 \cos\theta \\ Y(T) &= Tv_0 \sin\theta - (g/2) T^2 \quad \text{where } g = 9.8 \text{ m/sec}^2 \end{aligned}$$

Procedure

1. Press **[MODE]**. Select **Par**, **Simul**, and the default settings. **Simul** (simultaneous) mode simulates the two objects in motion over time.
2. Press **[WINDOW]**. Set the viewing window.

Tmin=0	Xmin=-13	Ymin=0
Tmax=12	Xmax=34	Ymax=31
Tstep=.1	Xscl=10	Yscl=10

3. Press **[Y=]**. Turn off all functions and stat plots. Enter the expressions to define the path of the ferris wheel and the path of the ball. Set the graph style for **X2T** to \rightarrow (path).

```
Plot1 Plot2 Plot3
X1T = 10cos(πT/6)
Y1T = 10+10sin(πT/6)
X2T = 25-22Tcos(66°)
Y2T = 22Tsin(66°)
```

```
-(9.8/2)T²
```

Note: Try setting the graph styles to \rightarrow **X1T** and \rightarrow **X2T**, which simulates a chair on the ferris wheel and the ball flying through the air when you press **[GRAPH]**.

4. Press **[GRAPH]** to graph the equations. Watch closely as they are plotted. Notice that the ball and the ferris wheel passenger appear to be closest where the paths cross in the top-right quadrant of the ferris wheel.

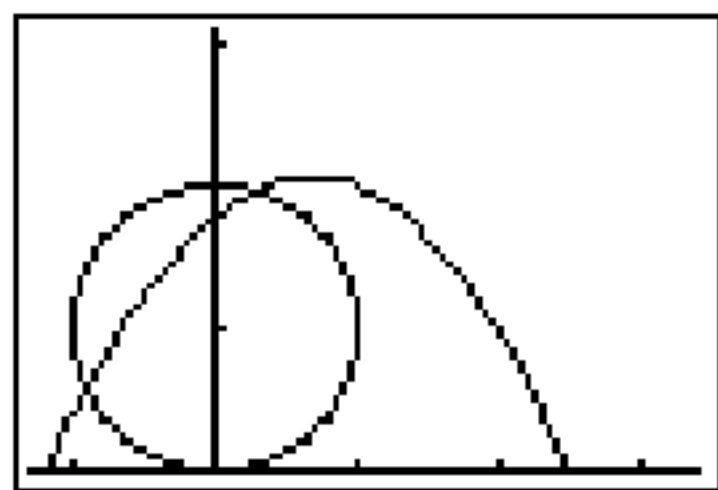

5. Press **WINDOW**. Change the viewing window to concentrate on this portion of the graph.

Tmin=1	Xmin=0	Ymin=10
Tmax=3	Xmax=23.5	Ymax=25.5
Tstep=.03	Xscl=10	Yscl=10

6. Press **TRACE**. After the graph is plotted, press \blacktriangleright to move near the point on the ferris wheel where the paths cross. Notice the values of **X**, **Y**, and **T**.

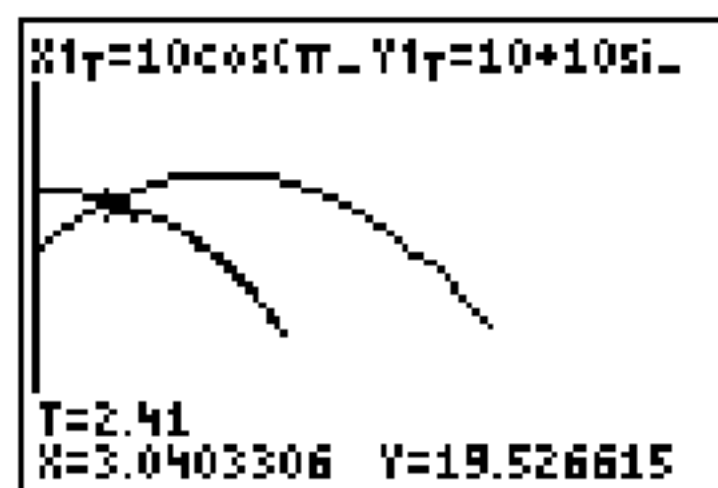

7. Press \blacktriangledown to move to the path of the ball. Notice the values of **X** and **Y** (**T** is unchanged). Notice where the cursor is located. This is the position of the ball when the ferris wheel passenger passes the intersection. Did the ball or the passenger reach the intersection first?

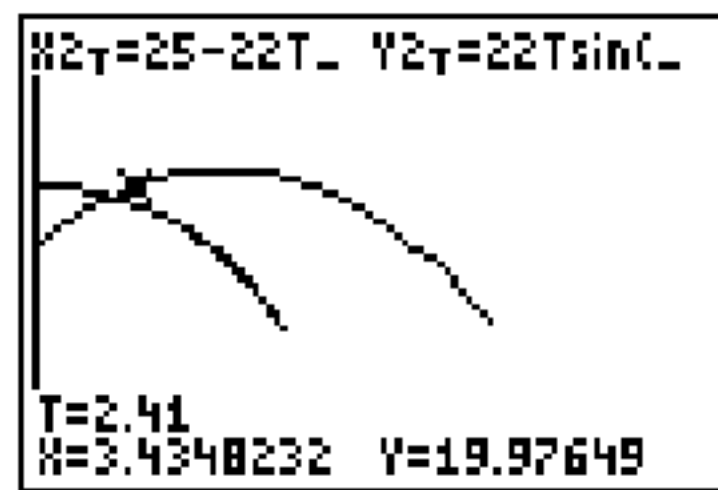

You can use **TRACE** to, in effect, take snapshots in time and explore the relative behavior of two objects in motion.

Demonstrating the Fundamental Theorem of Calculus

Problem 1

Using the functions **fnInt**(and **nDeriv**(from the **MATH** menu to graph functions defined by integrals and derivatives demonstrates graphically that:

$$F(x) = \int_1^x dt = \ln(x), x > 0 \text{ and that}$$

$$D_x \left[\int_1^x \frac{1}{t} dt \right] = \frac{1}{x}$$

Procedure 1

1. Press **MODE**. Select the default settings.
2. Press **WINDOW**. Set the viewing window.

Xmin=.01	Ymin=-1.5	Xres=3
Xmax=10	Ymax=2.5	
Xscl=1	Yscl=1	

3. Press **Y=**. Turn off all functions and stat plots. Enter the numerical integral of $1/T$ from 1 to X and the function $\ln(X)$. Set the graph style for **Y1** to \int (line) and **Y2** to $\frac{d}{dx}$ (path).

```

Plot1 Plot2 Plot3
\Y1=fnInt(1/T,T,
1,X)
\Y2=ln(X)

```

4. Press **TRACE**. Press **←**, **↑**, **→**, and **↓** to compare the values of **Y1** and **Y2**.
5. Press **Y=**. Turn off **Y1** and **Y2**, and then enter the numerical derivative of the integral of $1/X$ and the function $1/X$. Set the graph style for **Y3** to \cdot (line) and **Y4** to thick .

```

Plot1 Plot2 Plot3
\Y1=fnInt(1/T,T,
1,X)
\Y2=ln(X)
\Y3=nDeriv(Y1,X,
X)
\Y4=1/X

```

6. Press **TRACE**. Again, use the cursor keys to compare the values of the two graphed functions, **Y3** and **Y4**.

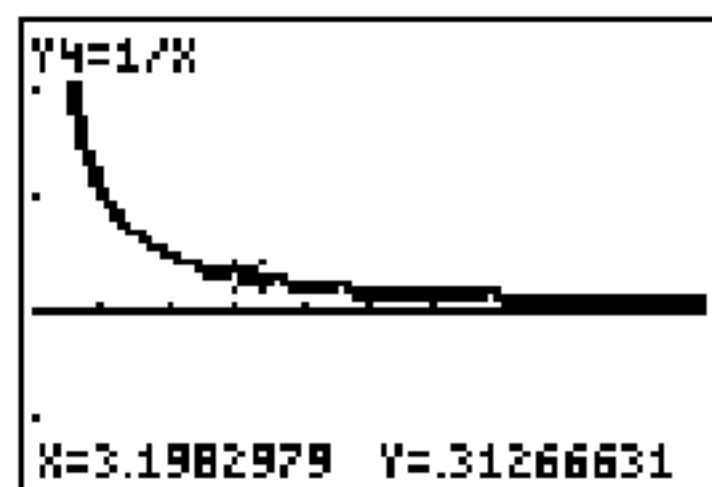
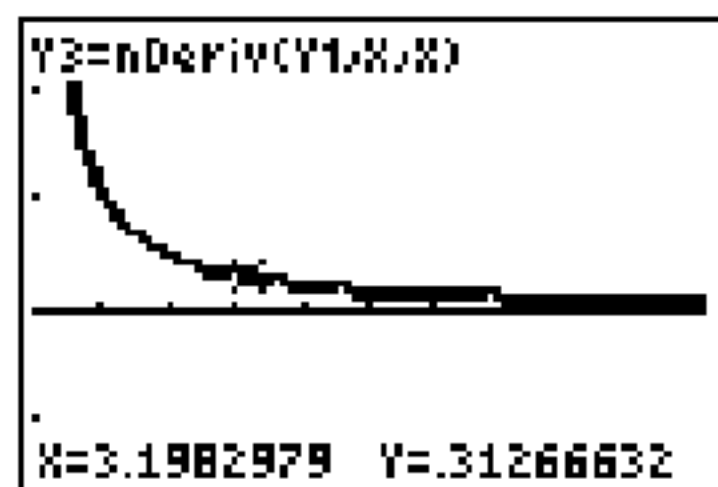

Problem 2

Explore the functions defined by

$$y = \int_2^x t^2 dt, \int_0^x t^2 dt, \text{ and } \int_2^x t^2 dt$$

Procedure 2

1. Press $\boxed{Y=}$. Turn off all functions and stat plots. Use a list to define these three functions simultaneously. Store the function in **Y5**.

```
Plot1 Plot2 Plot3
1,X)
0Y2=ln(X)
\Y3=nDeriv(Y1,X,
X)
\Y4=1/X
\Y5=fnInt(T^2,T,{
-2,0,2},X)
```

2. Press $\boxed{\text{ZOOM}}$ **6** to select **6:ZStandard**.
3. Press $\boxed{\text{TRACE}}$. Notice that the functions appear identical, only shifted vertically by a constant.
4. Press $\boxed{Y=}$. Enter the numerical derivative of **Y5** in **Y6**.

```

Plot1 Plot2 Plot3
\Y3=nDeriv(Y1,X,
X)
\Y4=1/X
\Y5=fnInt(T^2,T,(-
-2,0,2),X)
\Y6=nDeriv(Y5,X,
X)

```

5. Press **TRACE**. Notice that although the three graphs defined by **Y5** are different, they share the same derivative.

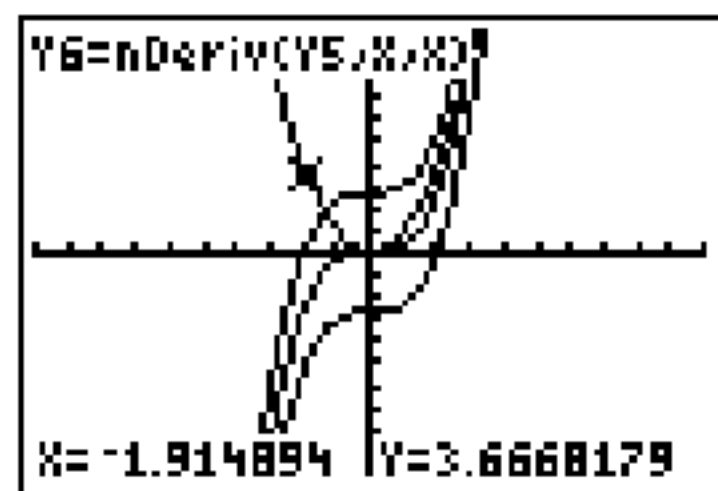

Computing Areas of Regular N-Sided Polygons

Problem

Use the equation solver to store a formula for the area of a regular N-sided polygon, and then solve for each variable, given the other variables. Explore the fact that the limiting case is the area of a circle, πr^2 .

Consider the formula $A = NB^2 \sin(\pi/N) \cos(\pi/N)$ for the area of a regular polygon with N sides of equal length and B distance from the center to a vertex.

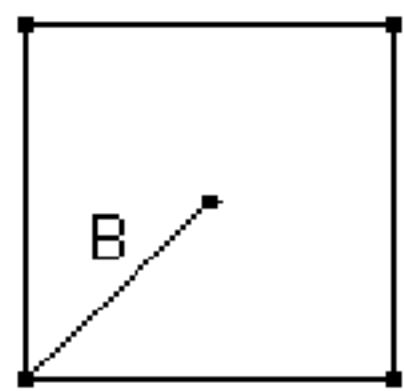

N = 4 sides

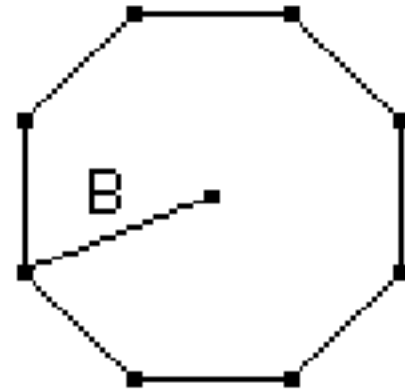

N = 8 sides

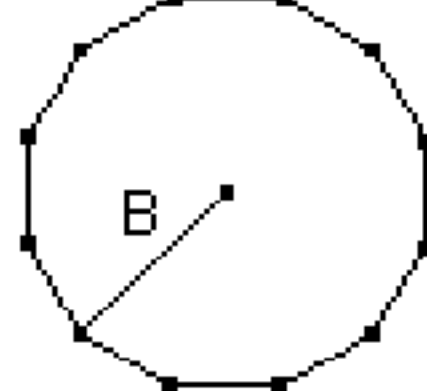

N = 12 sides

Procedure

1. Press **MATH** **0** to select **0:Solver** from the **MATH** menu. Either the equation editor or the interactive solver editor is displayed. If the interactive solver editor is displayed, press **▴** to display the equation editor.
2. Enter the formula as $0=A-NB^2\sin(\pi / N)\cos(\pi / N)$, and then press **ENTER**. The interactive solver editor is displayed.

```
A-NB^2sin(pi/N)...=0
A=0
N=0
B=0
bound={-1E99,1...
```

3. Enter **N=4** and **B=6** to find the area (**A**) of a square with a distance (**B**) from center to vertex of 6 centimeters.
4. Press $\uparrow \uparrow$ to move the cursor onto **A**, and then press $\boxed{\text{ALPHA}}$ [SOLVE]. The solution for **A** is displayed on the interactive solver editor.

```
A-NB^2sin(pi/N)...=0
▪ A=72.000000000...
N=4
B=6
bound={-1E99,1...
▪ left-rt=0
```

5. Now solve for **B** for a given area with various number of sides. Enter **A=200** and **N=6**. To find the distance **B**, move the cursor onto **B**, and then press $\boxed{\text{ALPHA}}$ [SOLVE].
6. Enter **N=8**. To find the distance **B**, move the cursor onto **B**, and then press $\boxed{\text{ALPHA}}$ [SOLVE]. Find **B** for **N=9**, and then for **N=10**.

Find the area given **B=6**, and **N=10**, **100**, **150**, **1000**, and **10000**. Compare your results with $\pi 6^2$ (the area of a circle with radius 6), which is approximately 113.097.

7. Enter **B=6**. To find the area **A**, move the cursor onto **A**, and then press $\boxed{\text{ALPHA}}$ [SOLVE]. Find **A** for **N=10**, then **N=100**, then **N=150**, then **N=1000**, and finally **N=10000**. Notice that as **N** gets large, the area **A** approaches $\pi \mathbf{B}^2$.

Now graph the equation to see visually how the area changes as the number of sides gets large.

8. Press **MODE**. Select the default mode settings.
9. Press **WINDOW**. Set the viewing window.

Xmin=0	Ymin=0	Xres=1
Xmax=200	Ymax=150	
Xscl=10	Yscl=10	

10. Press **Y=**. Turn off all functions and stat plots. Enter the equation for the area. Use **X** in place of **N**. Set the graph styles as shown.

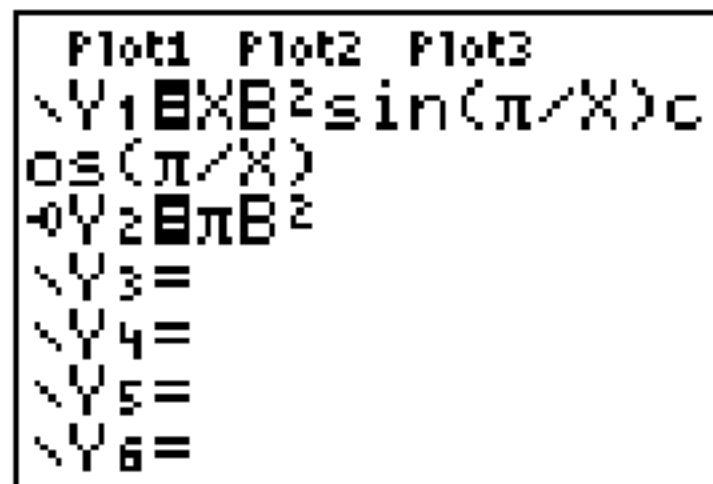

```
Plot1 Plot2 Plot3
\Y1=XB^2sin(π/X)c
0S(π/X)
-Y2=πB^2
\Y3=
\Y4=
\Y5=
\Y6=
```

11. Press **TRACE**. After the graph is plotted, press **100** **ENTER** to trace to **X=100**. Press **150** **ENTER**. Press **188** **ENTER**. Notice that as **X** increases, the value of **Y** converges to $\pi 6^2$, which is approximately 113.097. **Y2=πB²** (the area of the circle) is a horizontal

asymptote to $Y1$. The area of an N -sided regular polygon, with r as the distance from the center to a vertex, approaches the area of a circle with radius r (πr^2) as N gets large.

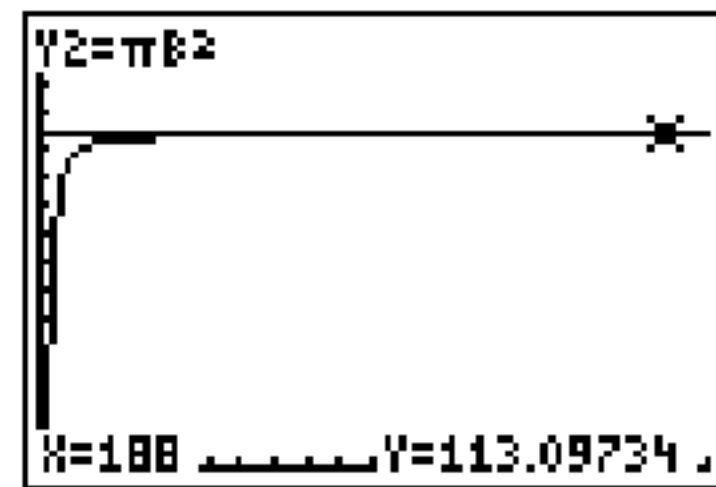
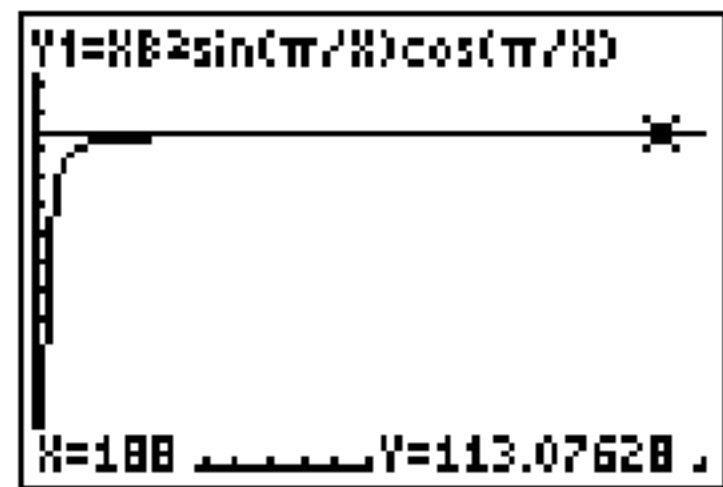

Computing and Graphing Mortgage Payments

Problem

You are a loan officer at a mortgage company, and you recently closed on a 30-year home mortgage at 8 percent interest with monthly payments of 800. The new home owners want to know how much will be applied to the interest and how much will be applied to the principal when they make the 240th payment 20 years from now.

Procedure

1. Press **MODE** and set the fixed-decimal mode to 2 decimal places. Set the other mode settings to the defaults.
2. Press **APPS** **ENTER** **ENTER** to display the **TVM Solver**. Enter these values.

```
N=360.00
I%=8.00
PV=0.00
PMT=800.00
FV=0.00
P/Y=12.00
C/Y=12.00
PMT: END BEGIN
```

Note: Enter a positive number (800) to show **PMT** as a cash inflow. Payment values will be displayed as positive numbers on the graph. Enter 0 for **FV**, since the future value of a loan is 0 once it is paid in full. Enter **PMT: END**, since payment is due at the end of a period.

3. Move the cursor onto the **PV=** prompt, and then press **ALPHA** **[SOLVE]**. The present value, or mortgage amount, of the house is displayed at the **PV=** prompt.

```

N=360.00
I%=8.00
PV=-109026.80
PMT=800.00
FV=0.00
P/Y=12.00
C/Y=12.00
PMT: [ ] [ ] BEGIN

```

Now compare the graph of the amount of interest with the graph of the amount of principal for each payment.

4. Press **[MODE]**. Set **Par** and **Simul**.
5. Press **[Y=]**. Turn off all functions and stat plots. Enter these equations and set the graph styles as shown.

```

Plot1 Plot2 Plot3
Y1T [ ] [ ]
Y1T [ ] [ ] ΣPrn(T,T)
Y2T [ ] [ ]
Y2T [ ] [ ] ΣInt(T,T)
Y3T [ ] [ ]
Y3T [ ] [ ] Y1T+Y2T

```

Note: $\Sigma\text{Prn}()$ and $\Sigma\text{Int}()$ are located on the **FINANCE** menu (**APPS 1:FINANCE**).

6. Press **[WINDOW]**. Set these window variables.

Tmin=1	Xmin=0	Ymin=0
Tmax=360	Xmax=360	Ymax=1000
Tstep=12	Xscl=10	Yscl=100

Note: To increase the graph speed, change **Tstep** to **24**.

7. Press **[TRACE]**. After the graph is drawn, press **240 [ENTER]** to move the trace cursor to **T=240**, which is equivalent to 20 years of payments.

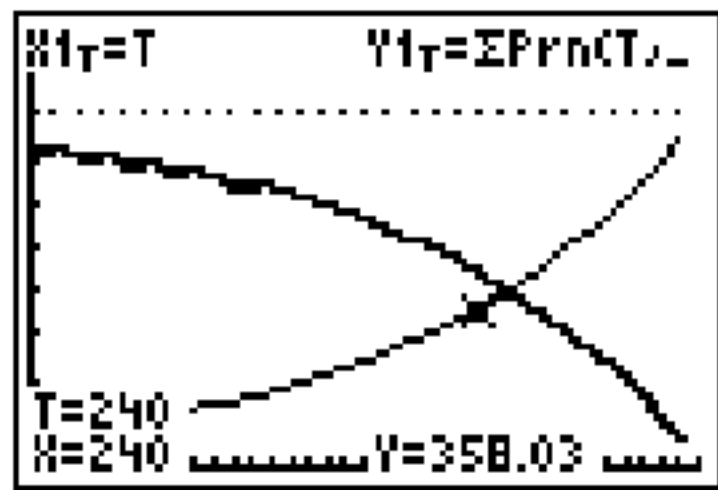

The graph shows that for the 240th payment ($X=240$), 358.03 of the 800 payment is applied to principal ($Y=358.03$).

Note: The sum of the payments ($Y3T=Y1T+Y2T$) is always 800.

8. Press \square to move the cursor onto the function for interest defined by $X2T$ and $Y2T$. Enter **240**.

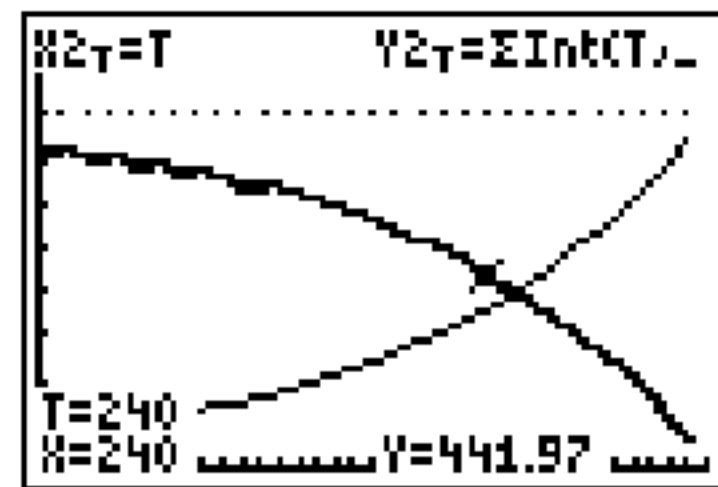

The graph shows that for the 240th payment ($X=240$), 441.97 of the 800 payment is interest ($Y=441.97$).

9. Press \square [QUIT] \square [APPS] \square [ENTER] **9** to paste **9:bal(** to the home screen. Check the figures from the graph.

```
bal(239)
-66295.33
Ans*(.08/12)
-441.97
```

At which monthly payment will the principal allocation surpass the interest allocation?

Chapter 18: Memory and Variable Management

Checking Available Memory

MEMORY Menu

At any time you can check available memory or manage existing memory by selecting items from the **MEMORY** menu. To access this menu, press `[2nd] [MEM]`.

MEMORY

- | | |
|--------------------|---|
| 1: About... | Displays information about the graphing calculator including current OS version number. |
| 2: Mem Mgmt/Del... | Reports memory availability and variable usage. |
| 3: Clear Entries | Clears ENTRY (last-entry storage). |
| 4: ClrAllLists | Clears all lists in memory. |
| 5: Archive... | Archives a selected variable. |
| 6: UnArchive... | UnArchives a selected variable. |
| 7: Reset... | Displays the RAM , ARCHIVE , and ALL menus |
| 8: Group... | Displays GROUP and UNGROUP menus. |
-

To check memory availability, first press `[2nd] [MEM]` and then select **2:Mem Mgmt/Del**.

```

RAM FREE  24298
ARC FREE  311200
1:All...
2:Real...
3:Complex...
4>List...
5:Matrix...
6↓Y-Vars...

```

RAM FREE displays the amount of available RAM.

ARC FREE displays the amount of available Archive.

Available RAM, Archive, and App Slots

The TI-84 Plus / TI-84 Plus Silver Edition has Archive, RAM, and Application (App) slot memory for you to use and manage. The available RAM stores computations, lists, variables, and data. The available Archive lets you store programs, Apps, groups, and other variables. The App slots are actually individual sectors of Flash ROM where Apps are stored.

Graphing calculator	Available RAM	Available Archive	App Slots
TI-84 Plus	24 Kilobytes	491 Kilobytes	30
TI-84 Plus Silver Edition	24 Kilobytes	1.5 Megabytes	94

Note: Some Apps take up several App slots.

Displaying the About Screen

About displays information about the TI-84 Plus Operating System (OS) Version, Product Number, Product Identification (ID), and Flash Application (App) Certificate Revision Number. To display the About screen, press **[2nd] [MEM]** and then select **1:About**.

Displays the type of graphing calculator.

Displays the OS version. As new software upgrades become available, you can electronically upgrade your unit.

```
TI-84 Plus Silver Edition
  2.30
PROD #: 0A-2-02-14
ID: 0A3C3-79DF1-E362
Help: education.ti.com
```

Displays the Product ID. Each Flash-based graphing calculator has a unique product ID, which you may need if you contact technical support. You can also use this 14 digit ID to register your calculator at education.ti.com, or identify your calculator in the event that it is lost or stolen.

Displaying the MEMORY MANAGEMENT/DELETE Menu

Mem Mgmt/Del displays the **MEMORY MANAGEMENT/DELETE** menu. The two lines at the top report the total amount of available RAM (**RAM FREE**) and Archive (**ARC FREE**) memory. By selecting menu items on this screen, you can see the amount of memory each variable type is using. This information can help you determine if you need to delete variables from memory to make room for new data, such as programs or Apps.

To check memory usage, follow these steps.

1. Press **[2nd] [MEM]** to display the **MEMORY** menu.

```
MEMORY
1:About
2:Mem Mgmt/Del...
3:Clear Entries
4:ClrAllLists
5:Archive
6:UnArchive
7↓Reset...
```

Note: The ↑ and ↓ in the top or bottom of the left column indicate that you can scroll up or down to view more variable types.

2. Select **2:Mem Mgmt/Del** to display the **MEMORY MANAGEMENT/DELETE** menu. The TI-84 Plus expresses memory quantities in bytes.

```
RAM FREE 24317
ARC FREE 1540K
1:All...
2:Real...
3:Complex...
4>List...
5:Matrix...
6↓Y-Vars...
```

```
7↑Prgm...
8:Pic...
9:GDB...
0:String...
A:Apps...
B↓AppVars...
```

```
C:GROUP...
```

3. Select variable types from the list to display memory usage.

Notes: **Real**, **List**, **Y-Vars**, and **Prgm** variable types never reset to zero, even after memory is cleared.

Apps are independent applications which are stored in Flash ROM. **AppVars** is a variable holder used to store variables created by Apps. You cannot edit or change variables in **AppVars** unless you do so through the application which created them.

To leave the **MEMORY MANAGEMENT/DELETE** menu, press either `[2nd]` `[QUIT]` or `[CLEAR]`. Both options display the home screen.

Deleting Items from Memory

Deleting an Item

To increase available memory by deleting the contents of any variable (real or complex number, list, matrix, Y= variable, program, Apps, AppVars, picture, graph database, or string), follow these steps.

1. Press **[2nd] [MEM]** to display the **MEMORY** menu.
2. Select **2:Mem Mgmt/Del** to display the **MEMORY MANAGEMENT/DELETE** menu.
3. Select the type of data you want to delete, or select **1:All** for a list of all variables of all types. A screen is displayed listing each variable of the type you selected and the number of bytes each variable is using.

For example, if you select **4:List**, the **LIST** editor screen is displayed.

RAM	FREE	24317
ARC	FREE	1540K
	L1	12
▶	L2	12
	L3	12

4. Press \uparrow and \downarrow to move the selection cursor (\blacktriangleright) next to the item you want to delete, and then press DEL . The variable is deleted from memory. You can delete individual variables one by one from this screen. No warning will be given to verify the deletion.

Note: If you are deleting programs or Apps, you will receive a message asking you to confirm this delete action. Select **2:Yes** to continue.

To leave any variable screen without deleting anything, press 2nd [QUIT], which displays the home screen.

You cannot delete some system variables, such as the last-answer variable **Ans** and the statistical variable **RegEQ**.

Clearing Entries and List Elements

Clear Entries

Clear Entries clears the contents of the **ENTRY** (last entry on home screen) storage area. To clear the **ENTRY** storage area, follow these steps.

1. Press `[2nd] [MEM]` to display the **MEMORY** menu.
2. Select **3:Clear Entries** to paste the instruction to the home screen.
3. Press `[ENTER]` to clear the **ENTRY** storage area.

```
Clear Entries
Done
```

To cancel **Clear Entries**, press `[CLEAR]`.

Note: If you select **3:Clear Entries** from within a program, the **Clear Entries** instruction is pasted to the program editor, and the **Entry** (last entry) is cleared when the program is executed.

ClrAllLists

ClrAllLists sets the dimension of each list in RAM to **0**.

To clear all elements from all lists, follow these steps.

1. Press `[2nd] [MEM]` to display the **MEMORY** menu.
2. Select **4:ClrAllLists** to paste the instruction to the home screen.

3. Press **ENTER** to set the dimension of each list in memory to **0**.

```
ClrAllLists Done
```

To cancel **ClrAllLists**, press **CLEAR**.

ClrAllLists does not delete list names from memory, from the **LIST NAMES** menu, or from the stat list editor.

Note: If you select **4:ClrAllLists** from within a program, the **ClrAllLists** instruction is pasted to the program editor. The lists are cleared when the program is executed.

Archiving and UnArchiving Variables

Archiving and UnArchiving Variables

Archiving lets you store data, programs, or other variables to the user data archive (ARC) where they cannot be edited or deleted inadvertently. Archiving also allows you to free up RAM for variables that may require additional memory.

Archived variables cannot be edited or executed. They can only be seen and unarchived. For example, if you archive list **L1**, you will see that **L1** exists in memory but if you select it and paste the name **L1** to the home screen, you won't be able to see its contents or edit it.

Note: Not all variables may be archived. Not all archived variables may be unarchived. For example, system variables including r , t , x , y , and θ cannot be archived. Apps and Groups always exist in Flash ROM so there is no need to archive them. Groups cannot be unarchived. However, you can ungroup or delete them.

Variable Type	Names	Archive? (yes/no)	UnArchive? (yes/no)
Real numbers	A, B, ... , Z	yes	yes
Complex numbers	A, B, ... , Z	yes	yes
Matrices	[A], [B], [C], ... , [J]	yes	yes
Lists	L1, L2, L3, L4, L5, L6, and user-defined names	yes	yes
Programs		yes	yes

Variable Type	Names	Archive? (yes/no)	UnArchive? (yes/no)
Functions	Y1, Y2, . . . , Y9, Y0	no	not applicable
Parametric equations	X1T and Y1T, ... , X6T and Y6T	no	not applicable
Polar functions	r1, r2, r3, r4, r5, r6	no	not applicable
Sequence functions	u, v, w	no	not applicable
Stat plots	Plot1, Plot2, Plot3	no	not applicable
Graph databases	GDB1, GDB2,...	yes	yes
Graph pictures	Pic1, Pic2, ... , Pic9, Pic0	yes	yes
Strings	Str1, Str2, . . . Str9, Str0	yes	yes
Tables	TblStart, Tb1, TblInput	no	not applicable
Apps	Applications	see Note above	no
AppVars	Application variables	yes	yes
Groups		see Note above	no
Variables with reserved names	minX, maxX, RegEQ, and others	no	not applicable

Variable Type	Names	Archive? (yes/no)	UnArchive? (yes/no)
System variables	Xmin , Xmax , and others	no	not applicable

Archiving and unarchiving can be done in two ways:

- Use the **5:Archive** or **6:UnArchive** commands from the **MEMORY** menu or **CATALOG**.
- Use a Memory Management editor screen.

Before archiving or unarchiving variables, particularly those with a large byte size (such as large programs) use the **MEMORY** menu to:

- Find the size of the variable.
- See if there is enough free space.

For:	Sizes must be such that:
Archive	Archive free size > variable size
UnArchive	RAM free size > variable size

Note: If there is not enough space, unarchive or delete variables as necessary. Be aware that when you unarchive a variable, not all the memory associated with that variable in user data archive will be released since the system keeps track of where the variable has been and where it is now in RAM.

Even if there appears to be enough free space, you may see a Garbage Collection message when you attempt to archive a variable. Depending on the usability of empty blocks in the user data archive, you may need to unarchive existing variables to create more free space.

To archive or unarchive a list variable (L1) using the Archive/UnArchive options from the **MEMORY** menu:

1. Press **[2nd] [MEM]** to display the **MEMORY** menu.

```
MEMORY
1:About
2:Mem Mgmt/Del...
3:Clear Entries
4:ClrAllLists
5:Archive
6:UnArchive
7↓Reset...
```

2. Select **5:Archive** or **6:UnArchive** to place the command in the **Home** screen.
3. Press **[2nd] [L1]** to place the **L1** variable in the **Home** screen.

```
Archive L1
```

4. Press **[ENTER]** to complete the archive process.

```
Archive L1      Done
```

Note: An asterisk will be displayed to the left of the Archived variable name to indicate it is archived.

To archive or unarchive a list variable (L1) using a Memory Management editor:

1. Press **[2nd] [MEM]** to display the **MEMORY** menu.

```
MEM MGMT
1:About
2:Mem Mgmt/Del...
3:Clear Entries
4:ClrAllLists
5:Archive
6:UnArchive
7↓Reset...
```

2. Select **2:Mem Mgmt/Del** to display the **MEMORY MANAGEMENT/DELETE** menu.

```
RAM FREE 23896
ARC FREE 868260
1:All...
2:Real...
3:Complex...
4>List...
5:Matrix...
6↓Y-Vars...
```

3. Select **4>List** to display the **LIST** menu.

```
RAM FREE 23896
ARC FREE 868260
* L1 12
L2 12
L3 12
L4 12
L5 12
L6 12
```

4. Press **[ENTER]** to archive **L1**. An asterisk will appear to the left of **L1** to indicate it is an archived variable. To unarchive a variable in this screen, put the cursor next to the archived variable and press **[ENTER]**. The asterisk will disappear.

RAM	FREE	23894
ARC	FREE	868235
*L1		12
L2		12
L3		12
L4		12
L5		12
L6		12

5. Press `[2nd]` `[QUIT]` to leave the **LIST** menu.

Note: You can access an archived variable for the purpose of linking, deleting, or unarchiving it, but you cannot edit it.

Resetting the TI-84 Plus

RAM ARCHIVE ALL Menu

Reset displays the **RAM ARCHIVE ALL** menu. This menu gives you the option of resetting all memory (including default settings) or resetting selected portions of memory while preserving other data stored in memory, such as programs and **Y=** functions. For instance, you can choose to reset all of RAM or just restore the default settings. Be aware that if you choose to reset RAM, all data and programs in RAM will be erased. For archive memory, you can reset variables (**Vars**), applications (**Apps**), or both of these. Be aware that if you choose to reset **Vars**, all data and programs in archive memory will be erased. If you choose to reset **Apps**, all applications in archive memory will be erased.

When you reset defaults on the TI-84 Plus, all defaults in RAM are restored to the factory settings. Stored data and programs are not changed.

These are some examples of TI-84 Plus defaults that are restored by resetting the defaults.

- Mode settings such as **Normal** (notation); **Func** (graphing); **Real** (numbers); and **Full** (screen)
- **Y=** functions off
- Window variable values such as **Xmin=-10**, **Xmax=10**, **Xscl=1**, **Yscl=1**, and **Xres=1**
- **STAT PLOTS** off
- Format settings such as **CoordOn** (graphing coordinates on); **AxesOn**; and **ExprOn** (expression on)
- **rand** seed value to 0

Displaying the RAM ARCHIVE ALL Menu

To display the **RAM ARCHIVE ALL** menu on the TI-84 Plus, follow these steps.

1. Press **[2nd] [MEM]** to display the **MEMORY** menu.
2. Select **7:Reset** to display the **RAM ARCHIVE ALL** menu.



```
RAM ARCHIVE ALL
1:All RAM...
2:Defaults...
```

Resetting RAM Memory

Resetting all RAM restores RAM system variables to factory settings and deletes all nonsystem variables and all programs. Resetting RAM defaults restores all system variables to default settings without deleting variables and programs in RAM. Resetting all RAM or resetting defaults does not affect variables and applications in user data archive.

Note: Before you reset all RAM memory, consider restoring sufficient available memory by deleting only selected data.

To reset all **RAM** memory or **RAM** defaults on the TI-84 Plus, follow these steps.

1. From the **RAM ARCHIVE ALL** menu, select **1:All RAM** to display the **RESET RAM** menu or **2:Defaults** to display the **RESET DEFAULTS** menu.

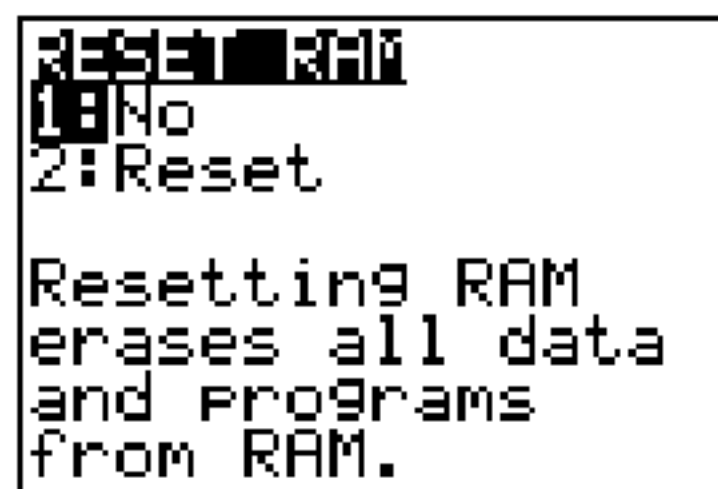

```
RESET RAM
1:No
2:Reset

Resetting RAM
erases all data
and programs
from RAM.
```

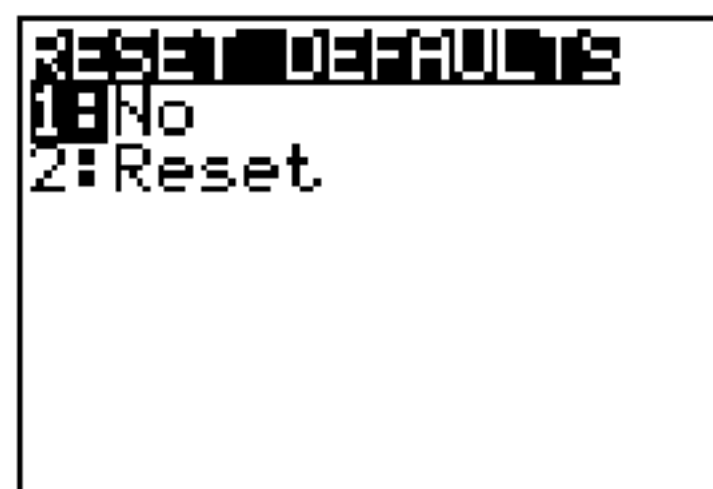

```
RESET DEFAULTS
1:No
2:Reset
```

2. If you are resetting RAM, read the message below the **RESET RAM** menu.
 - To cancel the reset and return to the **HOME** screen, press **ENTER**.
 - To erase RAM memory or reset defaults, select **2:Reset**. Depending on your choice, the message **RAM cleared** or **Defaults set** is displayed on the home screen.

Resetting Archive Memory

When resetting archive memory on the TI-84 Plus, you can choose to delete from user data archive all variables, all applications, or both variables and applications.

To reset all or part of user data archive memory, follow these steps.

1. From the **RAM ARCHIVE ALL** menu, press **▶** to display the **ARCHIVE** menu.

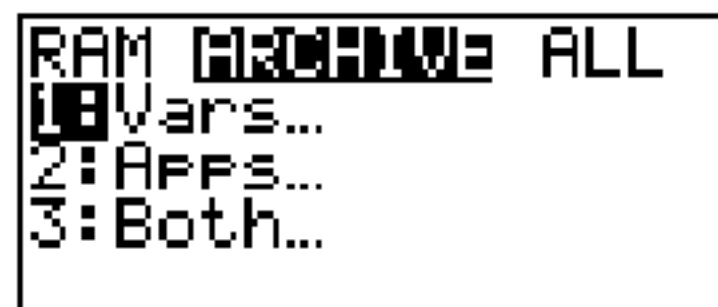

```
RAM ARCHIVE ALL
1:Vars...
2:Apps...
3:Both...
```

2. Select one of the following:

1:Vars to display the **RESET ARC VARS** menu.

```
RESET ARC VARS
1:No
2:Reset

Resetting Vars
erases all data
and Programs
from Archive.
```

2:Apps to display the **RESET ARC APPS** menu.

```
RESET ARC APPS
1:No
2:Reset

Resetting APPS
erases all APPS
from Archive.
```

3:Both to display the **RESET ARC BOTH** menu.

```
RESET ARC BOTH
1:No
2:Reset

Resetting Both
erases all data,
Programs & APPS
from Archive.
```

3. Read the message below the menu.

- To cancel the reset and return to the **HOME** screen, press **ENTER**.



- To continue with the reset, select **2:Reset**. A message indicating the type of archive memory cleared will be displayed on the **HOME** screen.

Resetting All Memory

When resetting all memory on the TI-84 Plus, RAM and user data archive memory is restored to factory settings. All nonsystem variables, applications, and programs are deleted. All system variables are reset to default settings.

Before you reset all memory, consider restoring sufficient available memory by deleting only selected data.

To reset all memory on the TI-84 Plus, follow these steps.

1. From the **RAM ARCHIVE ALL** menu, press   to display the **ALL** menu.



```
RAM ARCHIVE ALL
1:All Memory...
```

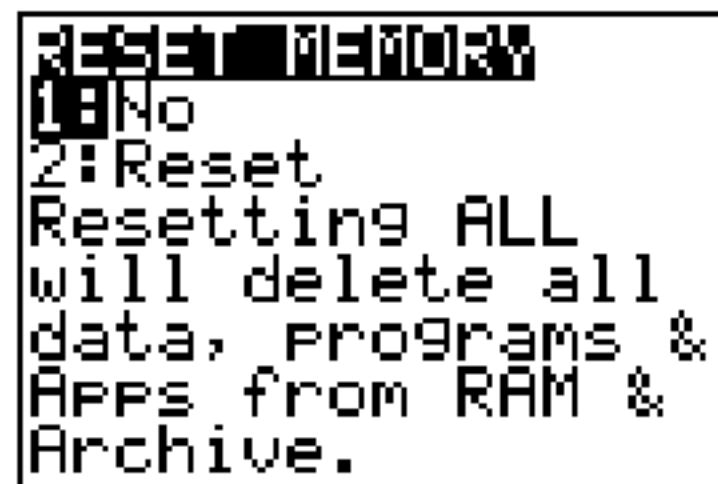

2. Select **1:All Memory** to display the **RESET MEMORY** menu.



```
RESET MEMORY
1:No
2:Reset
Resetting ALL
will delete all
data, programs &
Apps from RAM &
Archive.
```

3. Read the message below the **RESET MEMORY** menu.
 - To cancel the reset and return to the **HOME** screen, press .

- To continue with the reset, select **2:Reset**. The message **MEM cleared** is displayed on the **HOME** screen.

When you clear memory, the contrast sometimes changes. If the screen is faded or blank, adjust the contrast by pressing **2nd**  or .

Grouping and Ungrouping Variables

Grouping Variables

Grouping allows you to make a copy of two or more variables residing in RAM and then store them as a group in user data archive. The variables in RAM are not erased. The variables must exist in RAM before they can be grouped. In other words, archived data cannot be included in a group. Once grouped, the variables can be deleted from RAM to open memory. When the variables are needed later, they can be ungrouped for use.

To create a group of variables:

1. Press **[2nd] [MEM]** to display the **MEMORY** menu.

```
MEMORY
2:Mem Mgmt/Del...
3:Clear Entries
4:ClrAllLists
5:Archive
6:UnArchive
7:Reset...
8:GROUP...
```

2. Select **8:Group** to display **GROUP UNGROUP** menu.

```
GROUP UNGROUP
1:Create New
```

3. Press **[ENTER]** to display the **GROUP** menu.

```
GROUP
Name=
```

4. Enter a name for the new group and press **ENTER**.

Note: A group name can be one to eight characters long. The first character must be a letter from A to Z or θ . The second through eighth characters can be letters, numbers, or θ .

```
GROUP
Name=GROUPA
```

5. Select the type of data you want to group. You can select **1:All+** which shows all variables of all types available and selected. You can also select **2:All-** which shows all variables of all types available but not selected. A screen is displayed listing each variable of the type you selected.

```
GROUP
1:All+...
2:All-...
3:Pr9M...
4:List...
5:GDB...
6:Pic...
7↓Matrix...
```

For example, suppose some variables have been created in RAM, and selecting **2:All-** displays the following screen.

```

SELECT Done
▶ PROGRAM1 PRGM
PROGRAM2 PRGM
GDB1 GDB
L1 LIST
L2 LIST
L3 LIST
L4 LIST

```

- Press and to move the selection cursor (▶) next to the first item you want to copy into a group, and then press . A small square will remain to the left of all variables selected for grouping.

```

SELECT Done
■ PROGRAM1 PRGM
■ PROGRAM2 PRGM
■ GDB1 GDB
■ L1 LIST
■ L2 LIST
* L3 LIST
L4 LIST

```

Repeat the selection process until all variables for the new group are selected and then press to display the **DONE** menu.

```

SELECT Done
Done

```

- Press to complete the grouping process.

```

Copying
Variables to
Group:
GROUPA
Done

```

Note: You can only group variables in RAM. You cannot group some system variables, such as the last-answer variable **Ans** and the statistical variable **RegEQ**.

Ungrouping Variables

Ungrouping allows you to make a copy of variables in a group stored in user data archive and place them ungrouped in **RAM**.

DuplicateName Menu

During the ungrouping action, if a duplicate variable name is detected in **RAM**, the **DUPLICATE NAME** menu is displayed.

DuplicateName

1: Rename	Prompts to rename receiving variable.
2: Overwrite	Overwrites data in receiving duplicate variable.
3: Overwrite All	Overwrites data in all receiving duplicate variables.
4: Omit	Skips ungrouping of sending variable.
5: Quit	Stops ungrouping at duplicate variable.

Notes about Menu Items:

- When you select **1:Rename**, the **Name=** prompt is displayed, and alpha-lock is on. Enter a new variable name, and then press **ENTER**. Ungrouping resumes.

- When you select **2:Overwrite**, the unit overwrites the data of the duplicate variable name found in RAM. Ungrouping resumes.
- When you select **3: Overwrite All**, the unit overwrites the data of all duplicate variable names found in RAM. Ungrouping resumes.
- When you select **4:Omit**, the unit does not ungroup the variable in conflict with the duplicated variable name found in RAM. Ungrouping resumes with the next item.
- When you select **5:Quit**, ungrouping stops, and no further changes are made.

To ungroup a group of variables:

1. Press **[2nd] [MEM]** to display the **MEMORY** menu.

```

1:MEM
2:Mem Mgmt/Del...
3:Clear Entries
4:ClrAllLists
5:Archive
6:UnArchive
7:Reset...
8:GROUP...

```

2. Select **8:Group** to display the **GROUP UNGROUP** menu.
3. Press **[▶]** to display the **UNGROUP** menu.

```

GROUP UNGROUP
1:*GROUP1
2:*GROUPA
3:*GROUPC

```

4. Press `↑` and `↓` to move the selection cursor (▸) next to the group variable you want to ungroup, and then press `ENTER`.

```
Ungrouping:
GROUP1
                Done
```

The ungroup action is completed.

Note: Ungrouping does not remove the group from user data archive. You must delete the group in user data archive to remove it.

Garbage Collection

Garbage Collection Message

If you use the user data archive extensively, you may see a **Garbage Collect?** message. This occurs if you try to archive a variable when there is not enough free contiguous archive memory.

The **Garbage Collect?** message lets you know an archive will take longer than usual. It also alerts you that the archive will fail if there is not enough memory.

The message can also alert you when a program is caught in a loop that repetitively fills the user data archive. Select **No** to cancel the garbage collection process, and then find and correct the errors in your program.

When YES is selected, the TI-84 Plus will attempt to rearrange the archived variables to make additional room.

Responding to the Garbage Collection Message

- To cancel, select **1:No**.
- If you select **1:No**, the message **ERR:ARCHIVE FULL** will be displayed.
- To continue archiving, select **2:Yes**.
- If you select **2:Yes**, the process message **Garbage Collecting...** or **Defragmenting...** will be displayed.

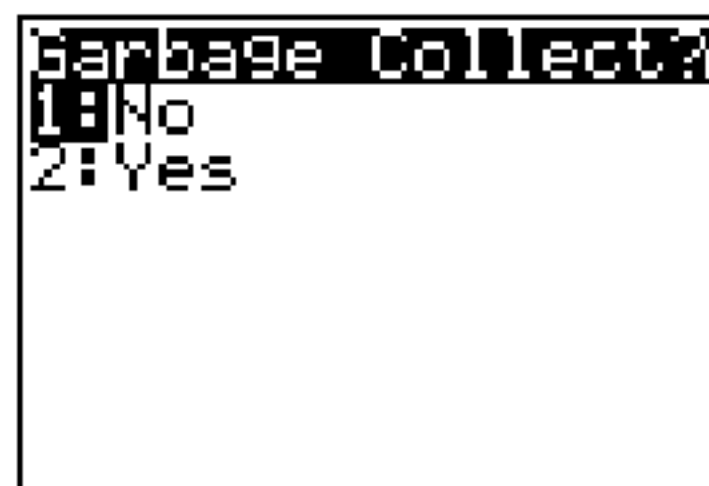

Note: The process message **Defragmenting...** is displayed whenever an application marked for deletion is encountered. Garbage collection may take up to 20 minutes, depending on how much of archive memory has been used to store variables.

After garbage collection, depending on how much additional space is freed, the variable may or may not be archived. If not, you can unarchive some variables and try again.

Why Is Garbage Collection Necessary?

The user data archive is divided into sectors. When you first begin archiving, variables are stored consecutively in sector 1. This continues to the end of the sector.

An archived variable is stored in a continuous block within a single sector. Unlike an application stored in user data archive, an archived variable cannot cross a sector boundary. If there is not enough space left in the sector, the next variable is stored at the beginning of the next sector. Typically, this leaves an empty block at the end of the previous sector.

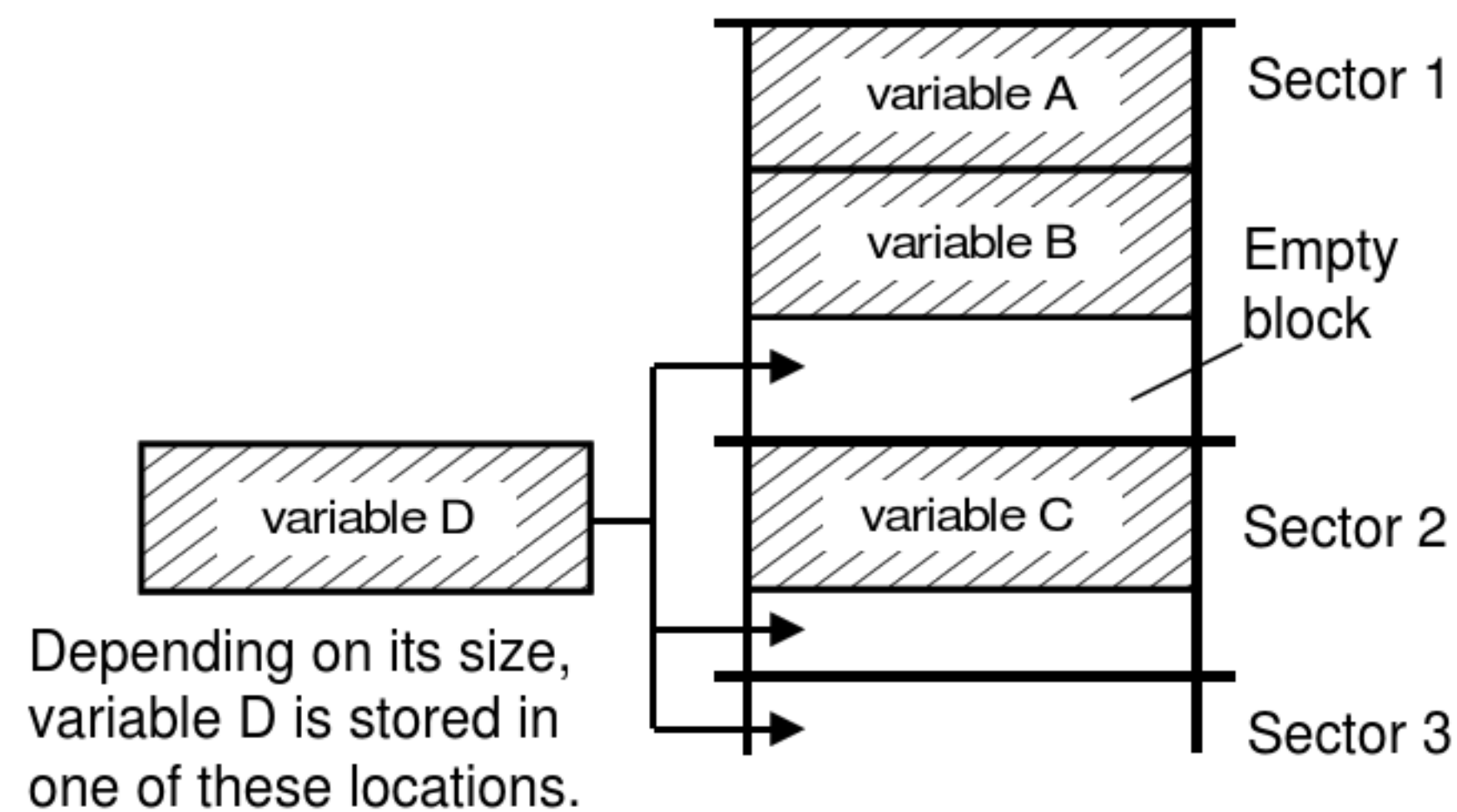

Each variable that you archive is stored in the first empty block large enough to hold it.

This process continues to the end of the last sector. Depending on the size of individual variables, the empty blocks may account for a significant amount of space. Garbage collection occurs when the variable you are archiving is larger than any empty block.

How Unarchiving a Variable Affects the Process

When you unarchive a variable, it is copied to RAM but it is not actually deleted from user data archive memory. Unarchived variables are “marked for deletion,” meaning they will be deleted during the next garbage collection.

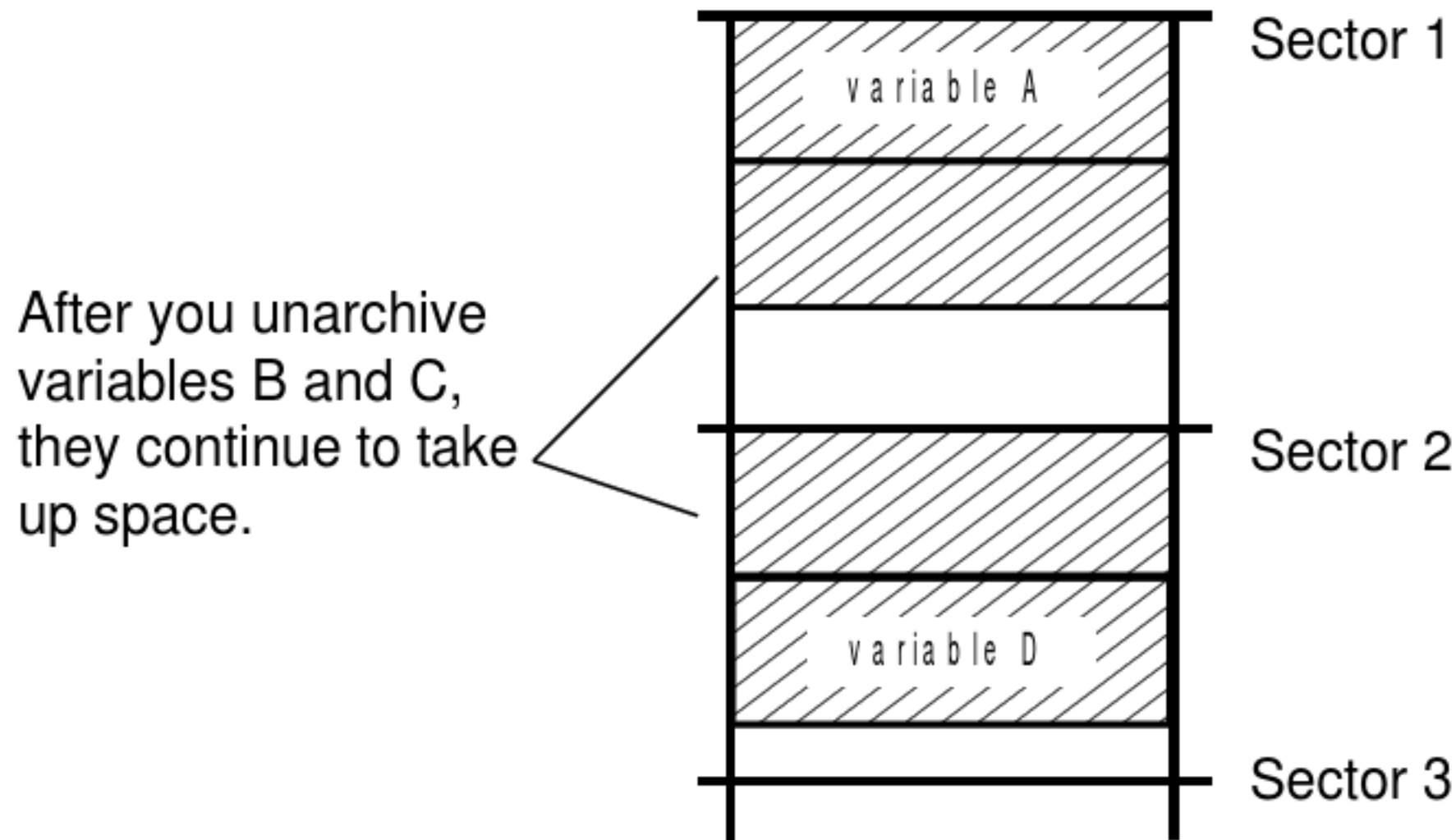

If the MEMORY Screen Shows Enough Free Space

Even if the **MEMORY** screen shows enough free space to archive a variable or store an application, you may still get a **Garbage Collect?** message or an **ERR: ARCHIVE FULL** message.

When you unarchive a variable, the **Archive free** amount increases immediately, but the space is not actually available until after the next garbage collection.

If the **Archive free** amount shows enough available space for your variable, there probably will be enough space to archive it after garbage collection (depending on the usability of any empty blocks).

The Garbage Collection Process

The garbage collection process:

- Deletes unarchived variables from the user data archive.
- Rearranges the remaining variables into consecutive blocks.

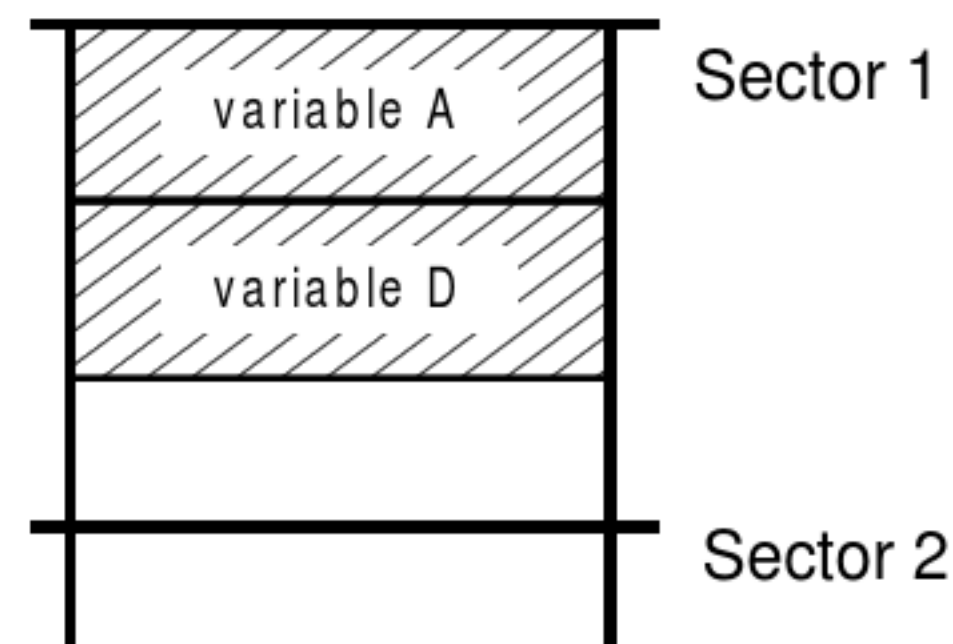

Note: Power loss during garbage collection may cause all memory (RAM and Archive) to be deleted.

Using the GarbageCollect Command

You can reduce the number of automatic garbage collections by periodically optimizing memory. This is done by using the **GarbageCollect** command.

To use the **GarbageCollect** command, follow these steps.

1. From the **HOME** screen, press **[2nd]** **[CATALOG]** to display the **CATALOG**.

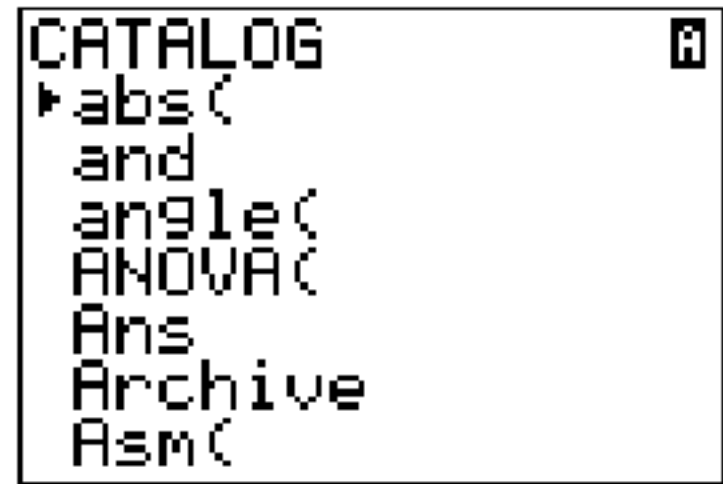

```
CATALOG [A]
▶abs(
and
angle(
ANOVA(
Ans
Archive
Asm(
```

2. Press **[↓]** or **[↑]** to scroll the **CATALOG** until the selection cursor points to the **GarbageCollect** command or press **G** to skip to the commands starting with the letter **G**.
3. Press **[ENTER]** to paste the command to the **HOME** screen.
4. Press **[ENTER]** to display the **Garbage Collect?** message.
5. Select **2:Yes** to begin garbage collection.

ERR:ARCHIVE FULL Message

Even if the **MEMORY** screen shows enough free space to archive a variable or store an application, you may still get an **ERR:ARCHIVE FULL** message.

```
ERR:ARCHIVE FULL
Quit

Largest single
Variable= 9662
APP      = 0
```

An **ERR:ARCHIVE FULL** message may be displayed:

- When there is insufficient space to archive a variable within a continuous block and within a single sector.
- When there is insufficient space to store an application within a continuous block of memory.

When the message is displayed, it will indicate the largest single space of memory available for storing a variable and an application.

To resolve the problem, use the **GarbageCollect** command to optimize memory. If memory is still insufficient, you must delete variables or applications to increase space.

Chapter 19: Communication Link

Getting Started: Sending Variables

Getting Started is a fast-paced introduction. Read the chapter for details.

Create and store a variable and a matrix, and then transfer them to another TI-84 Plus.

1. On the home screen of the sending unit, press **5** **.** **5** **STO▶** **ALPHA** **Q**. Press **ENTER** to store 5.5 to **Q**.

```
5.5→Q
[[1,2][3,4]]→[A]
                    5.5
                    [[1 2]
                    [3 4]]
```

2. Press **2nd** **[]** **2nd** **[]** **1** **,** **2** **2nd** **[]** **2nd** **[]** **3** **,** **4** **2nd** **[]** **2nd** **[]** **STO▶** **2nd** **[MATRIX]** **1**. Press **ENTER** to store the matrix to **[A]**.

3. On the sending unit, press **2nd** **[MEM]** to display the **MEMORY** menu.

```
MEMORY
1:About
2:Mem Mgmt/Del...
3:Clear Entries
4:ClrAllLists
5:Archive
6:UnArchive
7↓Reset...
```

4. On the sending unit, press **2** to select **2:Mem Mgmt/Del**. The **MEMORY MANAGEMENT** menu is displayed.

```
RAM FREE 23896
ARC FREE 868260
1:All...
2:Real...
3:Complex...
4>List...
5:Matrix...
6↓Y-Vars...
```

5. On the sending unit, press **5** to select **5:Matrix**. The **MATRIX** editor screen is displayed.

```
RAM FREE 23896
ARC FREE 868260
▶ [A] 47
```

6. On the sending unit, press **ENTER** to archive [A]. An asterisk (*) will appear, signifying that [A] is now archived.

```
RAM FREE 23934
ARC FREE 868210
▶*[A] 47
```

7. Connect the graphing calculators with the USB unit-to-unit cable. Push both ends in firmly.

8. On the receiving unit, press **2nd** **[LINK]** **▶** to display the **RECEIVE** menu. Press **1** to select **1:Receive**. The message **Waiting...** is displayed and the busy indicator is on.

```
SEND RECEIVE
1:Receive
```

9. On the sending unit, press **2nd** **[LINK]** to display the **SEND** menu.

```
SEND RECEIVE
1:All+...
2:All-...
3:Prgm...
4>List...
5:Lists to TI82...
6:GDB...
7↓Pic...
```

10. Press **2** to select **2:All-**. The **All- SELECT** screen is displayed.

11. Press **▶** until the selection cursor (▶) is next to [A] **MATRIX**. Press **ENTER**.

```
SEND TRANSMIT
▶*[A] MATRIX
Y1 EQU
Y2 EQU
Window WINDW
RclWindow ZSTO
TblSet TABLE
* Q REAL
```

12. Press **▶** until the selection cursor is next to **Q REAL**. Press **ENTER**. A square dot next to [A] and **Q** indicates that each is selected to send.

13. On the sending unit, press  to display the **TRANSMIT** menu.

```
SELECT TRANSMIT
[1] Transmit
```

14. On the sending unit, press **1** to select **1:Transmit** and begin transmission. The receiving unit displays the message **Receiving...**. When the items are transmitted, both units display the name and type of each transmitted variable.

```
Receiving...
*[A]          MATRX
▶ Q           REAL
              Done
```

TI-84 Plus LINK

This chapter describes how to communicate with compatible TI units. The TI-84 Plus has a USB port to connect and communicate with another TI-84 Plus or TI-84 Plus Silver Edition. A USB unit-to-unit cable is included with the TI-84 Plus.

The TI-84 Plus also has an I/O port using a I/O unit-to-unit cable to communicate with:

- TI-83 Plus Silver Edition
- TI-83 Plus
- TI-83
- TI-82
- TI-73
- CBL 2™ or a CBR™

Connecting Two Graphing Calculators with a USB Unit-to-Unit Cable or an I/O Unit-to-Unit Cable

USB Unit-to-Unit Cable

The TI-84 Plus USB link port is located at the top right edge of the graphing calculator.

1. Firmly insert either end of the USB unit-to-unit cable into the USB port.
2. Insert the other end of the cable into the other graphing calculator's USB port.



I/O Unit-to-Unit Cable

The TI-84 Plus I/O link port is located at the top left edge of the graphing calculator.

1. Firmly insert either end of the I/O unit-to-unit cable into the port.
2. Insert the other end of the cable into the other graphing calculator's I/O port.

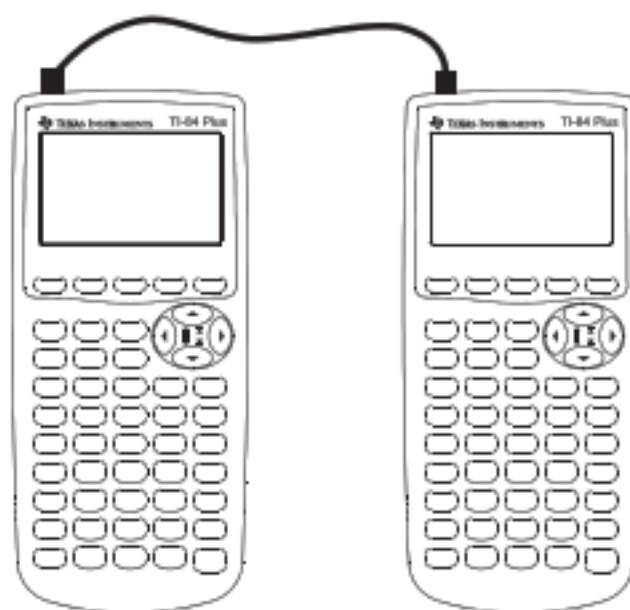

TI-84 Plus to a TI-83 Plus using I/O Unit-to-Unit Cable

The TI-84 Plus I/O link port is located at the top left edge of the graphing calculator. The TI-83 Plus I/O link port is located at the bottom edge of the graphing calculator.

3. Firmly insert either end of the I/O unit-to-unit cable into the port.
4. Insert the other end of the cable into the other graphing calculator's I/O port.



Linking to the CBL/CBR System

The CBL 2™ and the CBR™ are optional accessories that also connect to a TI-84 Plus with the I/O unit-to-unit cable. With a CBL 2 or CBR and a TI-84 Plus, you can collect and analyze real-world data.

Linking to a Computer

With TI Connect™ software and the USB computer cable that is included with your TI-84 Plus, you can link the graphing calculator to a personal computer.

Selecting Items to Send

LINK SEND Menu

To display the **LINK SEND** menu, press **[2nd] [LINK]**.

SEND	RECEIVE
1: All+...	Displays all items as selected, including RAM and Flash applications.
2: All-...	Displays all items as deselected.
3: Prgm...	Displays all program names.
4: List...	Displays all list names.
5: Lists to TI82...	Displays list names L1 through L6 .
6: GDB...	Displays all graph databases.
7: Pic...	Displays all picture data types.
8: Matrix...	Displays all matrix data types.
9: Real...	Displays all real variables.
0: Complex...	Displays all complex variables.
A: Y-Vars...	Displays all Y= variables.
B: String...	Displays all string variables.
C: Apps...	Displays all software applications.

SEND RECEIVE

D: AppVars...	Displays all software application variables.
E: Group...	Displays all grouped variables.
F: SendId	Sends the Calculator ID number immediately. (You do not need to select SEND .)
G: SendOS	Sends operating system updates to another TI-84 Plus Silver Edition or TI-84 Plus. You can not send the operating system to the TI-83 Plus product family.
H: Back Up...	Selects all RAM and mode settings (no Flash applications or archived items) for backup to another TI-84 Plus, TI-84 Plus Silver Edition, TI-83 Plus Silver Edition, or to a TI-83 Plus.

When you select an item on the **LINK SEND** menu, the corresponding **SELECT** screen is displayed.

Note: Each **SELECT** screen, except **All+...**, is initially displayed with nothing pre-selected. **All+...** is displayed with everything pre-selected.

To select items to send:

1. Press **[2nd]** **[LINK]** on the sending unit to display the **LINK SEND** menu.
2. Select the menu item that describes the data type to send. The corresponding **SELECT** screen is displayed.
3. Press **[▲]** and **[▼]** to move the selection cursor (▶) to an item you want to select or deselect.
4. Press **[ENTER]** to select or deselect the item. Selected names are marked with a ■.

```

SELECT TRANSMIT
[*]PROGRAM1 PRGM
PROGRAM2 PRGM
[*]GOB1 GOB
L1 LIST
[*]L2 LIST
[*]L3 LIST
L4 LIST

```

Note: An asterisk (*) to the left of an item indicates the item is archived.

- Repeat steps 3 and 4 to select or deselect additional items.

Sending the Selected Items

After you have selected items to send on the sending unit and set the receiving unit to receive, follow these steps to transmit the items. To set the receiving unit, see Receiving Items.

- Press  on the sending unit to display the **TRANSMIT** menu.

```

SELECT TRANSMIT
[ ]Transmit

```

- Confirm that **Waiting...** is displayed on the receiving unit, which indicates it is set to receive.

3. Press **ENTER** to select **1:Transmit**. The name and type of each item are displayed line-by-line on the sending unit as the item is queued for transmission, and then on the receiving unit as each item is accepted.

*PROGRAM1	PRGM	Receiving...	*PROGRAM1	PRGM
*GDB1	GDB		*GDB1	GDB
L1	LIST		L1	LIST
*L2	LIST		*L2	LIST
*L3	LIST		*L3	LIST
	Done			Done

Note: Items sent from the RAM of the sending unit are transmitted to the RAM of the receiving unit. Items sent from user data archive (flash) of the sending unit are transmitted to user data archive (flash) of the receiving unit.

After all selected items have been transmitted, the message **Done** is displayed on both calculators. Press **▲** and **▼** to scroll through the names.

Sending to a TI-84 Plus Silver Edition or TI-84 Plus

You can transfer variables (all types), programs, and Flash applications to another TI-84 Plus Silver Edition or TI-84 Plus. You can also backup the RAM memory of one unit to another.

Note: Keep in mind that the TI-84 Plus has less Flash memory than the TI-84 Plus Silver Edition.

- Variables stored in RAM on the sending TI-84 Plus Silver Edition will be sent to the RAM of the receiving TI-84 Plus Silver Edition or TI-84 Plus.

- Variables and applications stored in the user data archive of the sending TI-84 Plus Silver Edition will be sent to the user data archive of the receiving TI-84 Plus Silver Edition or TI-84 Plus.

After sending or receiving data, you can repeat the same transmission to additional TI-84 Plus Silver Edition or TI-84 Plus units—from either the sending unit or the receiving unit—without having to reselect data to send. The current items remain selected. However, you cannot repeat transmission if you selected **All+** or **All-**.

To send data to an additional TI-84 Plus Silver Edition or a TI-84 Plus:

1. Use a USB unit-to-unit cable to link two units together.
2. On the sending unit press **[2nd] [LINK]** and select a data type and items to **SEND**.
3. Press **[▶]** on the sending unit to display the **TRANSMIT** menu.
4. On the other unit, press **[2nd] [LINK] [▶]** to display the **RECEIVE** menu.
5. Press **[ENTER]** on the receiving unit.
6. Press **[ENTER]** on the sending unit. A copy of the selected item(s) is sent to the receiving unit.
7. Disconnect the link cable only from the receiving unit and connect it to another unit.
8. Press **[2nd] [LINK]** on the sending unit.
9. Select only the data type. For example, if the unit just sent a list, select **4:LIST**.

Note: The item(s) you want to send are pre-selected from the last transmission. Do not select or deselect any items. If you select or deselect an item, all selections or deselections from the last transmission are cleared.

10. Press **[▶]** on the sending unit to display the **TRANSMIT** menu.
11. On the new receiving unit, press **[2nd] [LINK] [▶]** to display the **RECEIVE** menu.

12. Press **ENTER** on the receiving unit.
13. Press **ENTER** on the sending unit. A copy of the selected item(s) is sent to the receiving unit.
14. Repeat steps 7 through 13 until the items are sent to all additional units.

Sending to a TI-83 Plus or TI-83 Plus Silver Edition

You can send all variables from a TI-84 Plus to a TI-83 Plus or TI-83 Plus Silver Edition *except* Flash applications with new features, or programs with new features in them.

If archived variables on the TI-84 Plus are variable types recognized and used on the TI-83 Plus or TI-83 Plus Silver Edition, you can send these variables to the TI-83 Plus or TI-83 Plus Silver Edition. They will be automatically sent to the RAM of the TI-83 Plus or TI-83 Plus Silver Edition during the transfer process. It will send to archive if the item is from archive.

To send data to a TI-83 Plus or TI-83 Plus Silver Edition:

1. Use an I/O unit-to-unit cable to link the two units together.
2. Set the TI-83 Plus or TI-83 Plus Silver Edition to receive.
3. Press **2nd** **[LINK]** on the sending TI-84 Plus to display the **LINK SEND** menu.
4. Select the menu of the items you want to transmit.
5. Press **[▶]** on the sending TI-84 Plus to display the **LINK TRANSMIT** menu.
6. Confirm that the receiving unit is set to receive.
7. Press **ENTER** on the sending TI-84 Plus to select **1:Transmit** and begin transmitting.

Receiving Items

LINK RECEIVE Menu

To display the **LINK RECEIVE** menu, press **[2nd] [LINK] [▶]**.

SEND RECEIVE

1: Receive Sets unit to receive data transmission.

Receiving Unit

When you select **1:Receive** from the **LINK RECEIVE** menu on the receiving unit, the message **Waiting...** and the busy indicator are displayed. The receiving unit is ready to receive transmitted items. To exit the receive mode without receiving items, press **[ON]**, and then select **1:Quit** from the **Error in Xmit** menu.

When transmission is complete, the unit exits the receive mode. You can select **1:Receive** again to receive more items. The receiving unit then displays a list of items received. Press **[2nd] [QUIT]** to exit the receive mode.

DuplicateName Menu

During transmission, if a variable name is duplicated, the **DuplicateName** menu is displayed on the receiving unit.

DuplicateName

- 1: `Rename` Prompts to rename receiving variable.
 - 2: `Overwrite` Overwrites data in receiving variable.
 - 3: `Omit` Skips transmission of sending variable.
 - 4: `Quit` Stops transmission at duplicate variable.
-

When you select **1:Rename**, the **Name=** prompt is displayed, and alpha-lock is on. Enter a new variable name, and then press `ENTER`. Transmission resumes.

When you select **2:Overwrite**, the sending unit's data overwrites the existing data stored on the receiving unit. Transmission resumes.

When you select **3:Omit**, the sending unit does not send the data in the duplicated variable name. Transmission resumes with the next item.

When you select **4:Quit**, transmission stops, and the receiving unit exits receive mode.

Receiving from a TI-84 Plus Silver Edition or TI-84 Plus

The TI-84 Plus Silver Edition and the TI-84 Plus are totally compatible. Keep in mind, however that the TI-84 Plus has less Flash memory than a TI-84 Plus Silver Edition.

You cannot send memory backups between the TI-84 Plus product family and the TI-83 Plus product family.

Receiving from a TI-83 Plus Silver Edition or TI-83 Plus

The TI-84 Plus product family and the TI-83 Plus product family are compatible with a few exceptions.

Receiving from a TI-83

You can transfer all variables and programs from a TI-83 to a TI-84 Plus if they fit in the RAM of the TI-84 Plus. The RAM of the TI-84 Plus is slightly less than the RAM of the TI-83.

Backing Up RAM Memory

Warning: H:Back Up overwrites the RAM memory and mode settings in the receiving unit. All information in the RAM memory of the receiving unit is lost.

Note: Archived items on the receiving unit are not overwritten.

You can backup the contents of RAM memory and mode settings (no Flash applications or archived items) to another TI-84 Plus Silver Edition. You can also backup RAM memory and mode settings to a TI-84 Plus.

To perform a RAM memory backup:

1. Use a USB unit-to-unit cable to link two TI-84 Plus units, or a TI-84 Plus and a TI-84 Plus Silver Edition together.
2. On the sending unit press **[2nd] [LINK]** and select **H:Back Up**. The **MEMORYBACKUP** screen displays.



```
MEMORYBACKUP
1:Transmit
2:Quit
```

3. On the receiving unit, press **[2nd] [LINK] [▶]** to display the **RECEIVE** menu.
4. Press **[ENTER]** on the receiving unit.
5. Press **[ENTER]** on the sending unit. A **WARNING — Backup** message displays on the receiving unit.

6. Press **ENTER** on the receiving unit to continue the backup.

— or —

Press **2:Quit** on the receiving unit to cancel the backup and return to the **LINK SEND** menu

Note: If a transmission error is returned during a backup, the receiving unit is reset.

Memory Backup Complete

When the backup is complete, both the sending graphing calculator and receiving graphing calculator display a confirmation screen.

```
MEMORY BACKUP
Done
```

Error Conditions

A transmission error occurs after one or two seconds if:

- A cable is not attached to the sending unit.
- A cable is not attached to the receiving unit.
- **Note:** If the cable is attached, push it in firmly and try again.
- The receiving unit is not set to receive transmission.
- You attempt a backup between a TI-73, TI-82, TI-83, TI-83 Plus, or TI-83 Plus Silver Edition.
- You attempt a data transfer from a TI-84 Plus to a TI-83 Plus, TI-83 Plus Silver Edition, TI-83, TI-82, or TI-73 with variables or features not recognized by the TI-83 Plus, TI-83 Plus Silver Edition, TI-83, TI-82, or TI-73.

New variable types and features not recognized by the TI-83, TI-83 Plus, TI-82, or TI-73 include applications, application variables, grouped variables, new variable types, or programs with new features in them such as **Archive**, **UnArchive**, **SendID**, **SendOS**, **Asm(**, **AsmComp(**, **AsmPrgm**, **checkTmr(**, **ClockOff**, **ClockOn**, **dayOfWk(**, **getDate**, **getDtFmt**, **getDtStr(**, **getTime**, **getTmFmt**, **getTmStr**, **isClockOn**, **setDate(**, **setDtFmt(**, **setTime(**, **setTmFmt(**, **startTmr**, and **timeCnv**.

- You attempt a data transfer from a TI-84 Plus to a TI-82 with data other than real lists **L1** through **L6** or without using menu item **5:Lists to TI82**.
- You attempt a data transfer from a TI-84 Plus to a TI-73 with data other than real numbers, pics, real lists **L1** through **L6** or named lists with θ as part of the name.
- Although a transmission error does not occur, these two conditions may prevent successful transmission.
- You try to use **Get(** with a graphing calculator instead of a CBL 2™ or CBR™.

- You try to use **GetCalc()** with a TI-83 instead of a TI-84 Plus or TI-84 Plus Silver Edition.

Insufficient Memory in Receiving Unit

- During transmission, if the receiving unit does not have sufficient memory to receive an item, the **Memory Full** menu is displayed on the receiving unit.
- To skip this item for the current transmission, select **1:Omit**. Transmission resumes with the next item.
- To cancel the transmission and exit receive mode, select **2:Quit**.

Appendix A: Functions and Instructions

Functions return a value, list, or matrix. You can use functions in an expression. Instructions initiate an action. Some functions and instructions have arguments. Optional arguments and accompanying commas are enclosed in brackets ([]). For details about an item, including argument descriptions and restrictions, turn to the page listed on the right side of the table.

From the **CATALOG**, you can paste any function or instruction to the home screen or to a command line in the program editor. However, some functions and instructions are not valid on the home screen. The items in this table appear in the same order as they appear in the **CATALOG**.

† indicates either keystrokes that are valid in the program editor only or ones that paste certain instructions when you are in the program editor. Some keystrokes display menus that are available only in the program editor. Others paste mode, format, or table-set instructions only when you are in the program editor.

Function or Instruction/Arguments	Result	Key or Keys/Menu or Screen/Item
abs (<i>value</i>)	Returns the absolute value of a real number, expression, list, or matrix.	MATH NUM 1:abs(
abs (<i>complex value</i>)	Returns the magnitude of a complex number or list.	MATH CPX 5:abs(

Function or Instruction/Arguments	Result	Key or Keys/Menu or Screen/Item
<i>valueA</i> and <i>valueB</i>	Returns 1 if both <i>valueA</i> and <i>valueB</i> are $\neq 0$. <i>valueA</i> and <i>valueB</i> can be real numbers, expressions, or lists.	$\boxed{2\text{nd}}$ [TEST] LOGIC 1:and
angle (<i>value</i>)	Returns the polar angle of a complex number or list of complex numbers.	$\boxed{\text{MATH}}$ CPX 4:angle(
ANOVA (<i>list1</i> , <i>list2</i> [, <i>list3</i> ,..., <i>list20</i>])	Performs a one-way analysis of variance for comparing the means of two to 20 populations.	$\boxed{\text{STAT}}$ TESTS H:ANOVA(
Ans	Returns the last answer.	$\boxed{2\text{nd}}$ [ANS]
Archive	Moves the specified variables from RAM to the user data archive memory.	$\boxed{2\text{nd}}$ [MEM] 5:Archive
Asm (<i>assemblyprgmname</i>)	Executes an assembly language program.	$\boxed{2\text{nd}}$ [CATALOG] Asm(
AsmComp (<i>prgmASM1</i> , <i>prgmASM2</i>)	Compiles an assembly language program written in ASCII and stores the hex version.	$\boxed{2\text{nd}}$ [CATALOG] AsmComp(
AsmPrgm	Must be used as the first line of an assembly language program.	$\boxed{2\text{nd}}$ [CATALOG] AsmPrgm

Function or Instruction/Arguments	Result	Key or Keys/Menu or Screen/Item
augment (<i>matrixA</i> , <i>matrixB</i>)	Returns a matrix, which is <i>matrixB</i> appended to <i>matrixA</i> as new columns.	$\boxed{2\text{nd}}$ [MATRIX] MATH 7:augment(
augment (<i>listA</i> , <i>listB</i>)	Returns a list, which is <i>listB</i> concatenated to the end of <i>listA</i> .	$\boxed{2\text{nd}}$ [LIST] OPS 9:augment(
AxesOff	Turns off the graph axes.	† $\boxed{2\text{nd}}$ [FORMAT] AxesOff
AxesOn	Turns on the graph axes.	† $\boxed{2\text{nd}}$ [FORMAT] AxesOn
a+bi	Sets the mode to rectangular complex number mode (a+bi).	† [MODE] a+bi
bal (<i>npmt</i> [, <i>roundvalue</i>])	Computes the balance at <i>npmt</i> for an amortization schedule using stored values for PV , I% , and PMT and rounds the computation to <i>roundvalue</i> .	[APPS] 1:Finance CALC 9:bal(
binomcdf (<i>numtrials</i> , <i>p</i> [, <i>x</i>])	Computes a cumulative probability at <i>x</i> for the discrete binomial distribution with the specified <i>numtrials</i> and probability <i>p</i> of success on each trial.	$\boxed{2\text{nd}}$ [DISTR] DISTR B:binomcdf(

Function or Instruction/Arguments	Result	Key or Keys/Menu or Screen/Item
binompdf (<i>numtrials</i> , <i>p</i> [, <i>x</i>])	Computes a probability at <i>x</i> for the discrete binomial distribution with the specified <i>numtrials</i> and probability <i>p</i> of success on each trial.	$\boxed{2\text{nd}}$ [DISTR] DISTR A:binompdf(
χ^2 cdf (<i>lowerbound</i> , <i>upperbound</i> , <i>df</i>)	Computes the χ^2 distribution probability between <i>lowerbound</i> and <i>upperbound</i> for the specified degrees of freedom <i>df</i> .	$\boxed{2\text{nd}}$ [DISTR] DISTR 8:χ^2cdf(
χ^2 pdf (<i>x</i> , <i>df</i>)	Computes the probability density function (pdf) for the χ^2 distribution at a specified <i>x</i> value for the specified degrees of freedom <i>df</i> .	$\boxed{2\text{nd}}$ [DISTR] DISTR 7:χ^2pdf(
χ^2 -Test (<i>observedmatrix</i> , <i>expectedmatrix</i> [, <i>drawflag</i>])	Performs a chi-square test. <i>drawflag</i> = 1 draws results; <i>drawflag</i> = 0 calculates results.	† $\boxed{\text{STAT}}$ TESTS C:χ^2-Test(
χ^2 GOF-Test (<i>observedlist</i> , <i>expectedlist</i> , <i>df</i>)	Performs a test to confirm that sample data is from a population that conforms to a specified distribution.	† $\boxed{\text{STAT}}$ TESTS D:χ^2GOF-Test(

Function or Instruction/Arguments	Result	Key or Keys/Menu or Screen/Item
checkTmr (<i>starttime</i>)	Returns the number of seconds since you used startTmr to start the timer. The <i>starttime</i> is the value displayed by startTmr .	$\boxed{2nd}$ [CATALOG] checkTmr (
Circle (<i>X,Y,radius</i>)	Draws a circle with center (<i>X,Y</i>) and <i>radius</i> .	$\boxed{2nd}$ [DRAW] DRAW 9:Circle (
Clear Entries	Clears the contents of the Last Entry storage area.	$\boxed{2nd}$ [MEM] MEMORY 3:Clear Entries
ClockOff	Turns off the clock display in the mode screen.	$\boxed{2nd}$ [CATALOG] ClockOff
ClockOn	Turns on the clock display in the mode screen.	$\boxed{2nd}$ [CATALOG] ClockOn
ClrAllLists	Sets to 0 the dimension of all lists in memory.	$\boxed{2nd}$ [MEM] MEMORY 4:ClrAllLists
ClrDraw	Clears all drawn elements from a graph or drawing.	$\boxed{2nd}$ [DRAW] DRAW 1:ClrDraw
ClrHome	Clears the home screen.	† \boxed{PRGM} I/O 8:ClrHome

Function or Instruction/Arguments	Result	Key or Keys/Menu or Screen/Item
ClrList <i>listname1</i> [, <i>listname2</i> , ..., <i>listname n</i>]	Sets to 0 the dimension of one or more <i>listnames</i> .	[STAT] EDIT 4:ClrList
ClrTable	Clears all values from the table.	† [PRGM] I/O 9:ClrTable
conj (<i>value</i>)	Returns the complex conjugate of a complex number or list of complex numbers.	[MATH] CPX 1:conj(
Connected	Sets connected plotting mode; resets all Y= editor graph-style settings to \cdot .	† [MODE] Connected
CoordOff	Turns off cursor coordinate value display.	† [2nd] [FORMAT] CoordOff
CoordOn	Turns on cursor coordinate value display.	† [2nd] [FORMAT] CoordOn
cos (<i>value</i>)	Returns cosine of a real number, expression, or list.	[COS]
cos⁻¹ (<i>value</i>)	Returns arccosine of a real number, expression, or list.	[2nd] [COS⁻¹]
cosh (<i>value</i>)	Returns hyperbolic cosine of a real number, expression, or list.	[2nd] [CATALOG] cosh(

Function or Instruction/Arguments	Result	Key or Keys/Menu or Screen/Item
\cosh^{-1} (<i>value</i>)	Returns hyperbolic arccosine of a real number, expression, or list.	$\boxed{2\text{nd}}$ [CATALOG] cosh⁻¹(
CubicReg [<i>Xlistname</i> , <i>Ylistname</i> , <i>freqlist</i> , <i>regequ</i>]	Fits a cubic regression model to <i>Xlistname</i> and <i>Ylistname</i> with frequency <i>freqlist</i> , and stores the regression equation to <i>regequ</i> .	$\boxed{\text{STAT}}$ CALC 6:CubicReg
cumSum (<i>list</i>)	Returns a list of the cumulative sums of the elements in <i>list</i> , starting with the first element.	$\boxed{2\text{nd}}$ [LIST] OPS 6:cumSum(
cumSum (<i>matrix</i>)	Returns a matrix of the cumulative sums of <i>matrix</i> elements. Each element in the returned matrix is a cumulative sum of a <i>matrix</i> column from top to bottom.	$\boxed{2\text{nd}}$ [MATRIX] MATH 0:cumSum(
dayOfWk (<i>year</i> , <i>month</i> , <i>day</i>)	Returns an integer from 1 to 7, with each integer representing a day of the week. Use dayOfWk(to determine on which day of the week a particular date would occur. The <i>year</i> must be 4 digits; <i>month</i> and <i>day</i> can be 1 or 2 digit.	$\boxed{2\text{nd}}$ [CATALOG] dayOfWk(1:Sunday 2:Monday 3:Tuesday...

Function or Instruction/Arguments	Result	Key or Keys/Menu or Screen/Item
dbd (<i>date1</i> , <i>date2</i>)	Calculates the number of days between <i>date1</i> and <i>date2</i> using the actual-day-count method.	[APPS] 1:Finance CALC D:dbd(
<i>value</i> → Dec	Displays a real or complex number, expression, list, or matrix in decimal format.	[MATH] MATH 2:→Dec
Degree	Sets degree angle mode.	† [MODE] Degree
DelVar <i>variable</i>	Deletes from memory the contents of <i>variable</i> .	† [PRGM] CTL G:DelVar
DependAsk	Sets table to ask for dependent-variable values.	† [2nd] [TBLSET] Depend: Ask
DependAuto	Sets table to generate dependent-variable values automatically.	† [2nd] [TBLSET] Depend: Auto
det (<i>matrix</i>)	Returns determinant of <i>matrix</i> .	[2nd] [MATRIX] MATH 1:det(
DiagnosticOff	Sets diagnostics-off mode; r , r² , and R² are not displayed as regression model results.	[2nd] [CATALOG] DiagnosticOff

Function or Instruction/Arguments	Result	Key or Keys/Menu or Screen/Item
DiagnosticOn	Sets diagnostics-on mode; r , r^2 , and R^2 are displayed as regression model results.	$\boxed{2nd}$ [CATALOG] DiagnosticOn
dim (<i>listname</i>)	Returns the dimension of <i>listname</i> .	$\boxed{2nd}$ [LIST] OPS 3:dim (
dim (<i>matrixname</i>)	Returns the dimension of <i>matrixname</i> as a list.	$\boxed{2nd}$ [MATRIX] MATH 3:dim (
<i>length</i> → dim (<i>listname</i>)	Assigns a new dimension (<i>length</i>) to a new or existing <i>listname</i> .	$\boxed{2nd}$ [LIST] OPS 3:dim (
{ <i>rows</i> , <i>columns</i> }→ dim (<i>matrixname</i>)	Assigns new dimensions to a new or existing <i>matrixname</i> .	$\boxed{2nd}$ [MATRIX] MATH 3:dim (
Disp	Displays the home screen.	† \boxed{PRGM} I/O 3:Disp
Disp [<i>valueA</i> , <i>valueB</i> , <i>valueC</i> ,..., <i>value n</i>]	Displays each value.	† \boxed{PRGM} I/O 3:Disp
DispGraph	Displays the graph.	† \boxed{PRGM} I/O 4:DispGraph

Function or Instruction/Arguments	Result	Key or Keys/Menu or Screen/Item
DispTable	Displays the table.	† [PRGM] I/O 5:DispTable
<i>value</i> → DMS	Displays <i>value</i> in DMS format.	[2nd] [ANGLE] ANGLE 4: → DMS
Dot	Sets dot plotting mode; resets all Y= editor graph-style settings to ' . .	† [MODE] Dot
DrawF <i>expression</i>	Draws <i>expression</i> (in terms of X) on the graph.	[2nd] [DRAW] DRAW 6:DrawF
DrawInv <i>expression</i>	Draws the inverse of <i>expression</i> by plotting X values on the y-axis and Y values on the x-axis.	[2nd] [DRAW] DRAW 8:DrawInv
:DS< (<i>variable,value</i>) <i>:commandA</i> <i>:commands</i>	Decrements <i>variable</i> by 1; skips <i>commandA</i> if <i>variable</i> < <i>value</i> .	† [PRGM] CTL B:DS< (
e[^] (<i>power</i>)	Returns e raised to <i>power</i> .	[2nd] [e ^x]
e[^] (<i>list</i>)	Returns a list of e raised to a <i>list</i> of powers.	[2nd] [e ^x]
Exponent: <i>valueE</i> <i>exponent</i>	Returns <i>value</i> times 10 to the <i>exponent</i> .	[2nd] [EE]

Function or Instruction/Arguments	Result	Key or Keys/Menu or Screen/Item
Exponent: <i>list</i> Exponent	Returns <i>list</i> elements times 10 to the <i>exponent</i> .	[2nd] [EE]
Exponent: <i>matrix</i> Exponent	Returns <i>matrix</i> elements times 10 to the <i>exponent</i> .	[2nd] [EE]
►Eff(<i>nominal rate, compounding periods</i>)	Computes the effective interest rate.	[APPS] 1:Finance CALC C►Eff(
Else See If:Then:Else		
End	Identifies end of For , If-Then-Else , Repeat , or While loop.	† [PRGM] CTL 7:End
Eng	Sets engineering display mode.	† [MODE] Eng
Equ►String (<i>Y= var</i> , Strn)	Converts the contents of a Y= var to a string and stores it in Strn .	[2nd] [CATALOG] Equ►String(
expr (<i>string</i>)	Converts <i>string</i> to an expression and executes it.	[2nd] [CATALOG] expr(
ExpReg [<i>Xlistname, Ylistname, freqlist, regequ</i>]	Fits an exponential regression model to <i>Xlistname</i> and <i>Ylistname</i> with frequency <i>freqlist</i> , and stores the regression equation to <i>regequ</i> .	[STAT] CALC 0:ExpReg

Function or Instruction/Arguments	Result	Key or Keys/Menu or Screen/Item
ExprOff	Turns off the expression display during TRACE .	† [2nd] [FORMAT] ExprOff
ExprOn	Turns on the expression display during TRACE .	† [2nd] [FORMAT] ExprOn
Fcdf (<i>lowerbound</i> , <i>upperbound</i> , <i>numerator df</i> , <i>denominator df</i>)	Computes the F distribution probability between <i>lowerbound</i> and <i>upperbound</i> for the specified <i>numerator df</i> (degrees of freedom) and <i>denominator df</i> .	[2nd] [DISTR] DISTR 0:Fcdf(
Fill (<i>value</i> , <i>matrixname</i>)	Stores <i>value</i> to each element in <i>matrixname</i> .	[2nd] [MATRIX] MATH 4:Fill(
Fill (<i>value</i> , <i>listname</i>)	Stores <i>value</i> to each element in <i>listname</i> .	[2nd] [LIST] OPS 4:Fill(
Fix #	Sets fixed-decimal mode for # of decimal places.	† [MODE] 0123456789 (select one)
Float	Sets floating decimal mode.	† [MODE] Float

Function or Instruction/Arguments	Result	Key or Keys/Menu or Screen/Item
fMax (<i>expression</i> , <i>variable</i> , <i>lower</i> , <i>upper</i> [, <i>tolerance</i>])	Returns the value of <i>variable</i> where the local maximum of <i>expression</i> occurs, between <i>lower</i> and <i>upper</i> , with specified <i>tolerance</i> .	MATH MATH 7:fMax(
fMin (<i>expression</i> , <i>variable</i> , <i>lower</i> , <i>upper</i> [, <i>tolerance</i>])	Returns the value of <i>variable</i> where the local minimum of <i>expression</i> occurs, between <i>lower</i> and <i>upper</i> , with specified <i>tolerance</i> .	MATH MATH 6:fMin(
fnInt (<i>expression</i> , <i>variable</i> , <i>lower</i> , <i>upper</i> [, <i>tolerance</i>])	Returns the function integral of <i>expression</i> with respect to <i>variable</i> , between <i>lower</i> and <i>upper</i> , with specified <i>tolerance</i> .	MATH MATH 9:fnInt(
FnOff [<i>function#</i> , <i>function#</i> , ..., <i>function n</i>]	Deselects all Y= functions or specified Y= functions.	VAR Y-VARS 4:On/Off 2:FnOff
FnOn [<i>function#</i> , <i>function#</i> , ..., <i>function n</i>]	Selects all Y= functions or specified Y= functions.	VAR Y-VARS 4:On/Off 1:FnOn

Function or Instruction/Arguments	Result	Key or Keys/Menu or Screen/Item
:For (<i>variable,begin,end</i> [, <i>increment</i>]) <i>:commands</i> :End <i>:commands</i>	Executes <i>commands</i> through End , incrementing <i>variable</i> from <i>begin</i> by <i>increment</i> until <i>variable</i> > <i>end</i> .	† PRGM CTL 4:For(
fPart (<i>value</i>)	Returns the fractional part or parts of a real or complex number, expression, list, or matrix.	MATH NUM 4:fPart(
Fpdf (<i>x,numerator df, denominator df</i>)	Computes the F distribution probability between <i>lowerbound</i> and <i>upperbound</i> for the specified <i>numerator df</i> (degrees of freedom) and <i>denominator df</i> .	2nd [DISTR] DISTR 9:Fpdf(
<i>value</i> ► Frac	Displays a real or complex number, expression, list, or matrix as a fraction simplified to its simplest terms.	MATH MATH 1►Frac
Full	Sets full screen mode.	† MODE Full
Func	Sets function graphing mode.	† MODE Func

Function or Instruction/Arguments	Result	Key or Keys/Menu or Screen/Item
GarbageCollect	Displays the garbage collection menu to allow cleanup of unused archive memory.	2nd [CATALOG] GarbageCollect
gcd (<i>valueA</i> , <i>valueB</i>)	Returns the greatest common divisor of <i>valueA</i> and <i>valueB</i> , which can be real numbers or lists.	MATH NUM 9:gcd (
geometcdf (<i>p</i> , <i>x</i>)	Computes a cumulative probability at <i>x</i> , the number of the trial on which the first success occurs, for the discrete geometric distribution with the specified probability of success <i>p</i> .	2nd [DISTR] DISTR F:geometcdf (
geometpdf (<i>p</i> , <i>x</i>)	Computes a probability at <i>x</i> , the number of the trial on which the first success occurs, for the discrete geometric distribution with the specified probability of success <i>p</i> .	2nd [DISTR] DISTR E:geometpdf (
Get (<i>variable</i>)	Gets data from the CBL 2™ or CBR™ System and stores it in <i>variable</i> .	† PRGM I/O A:Get (

Function or Instruction/Arguments	Result	Key or Keys/Menu or Screen/Item
GetCalc (<i>variable</i> [, <i>portflag</i>])	Gets contents of <i>variable</i> on another TI-84 Plus and stores it to <i>variable</i> on the receiving TI-84 Plus. By default, the TI-84 Plus uses the USB port if it is connected. If the USB cable is not connected, it uses the I/O port. <i>portflag</i> =0 use USB port if connected; <i>portflag</i> =1 use USB port; <i>portflag</i> =2 use I/O port.	† [PRGM] I/O 0:GetCalc(
getDate	Returns a list giving the date according to the current value of the clock. The list is in { <i>year,month,day</i> } format.	[2nd] [CATALOG] getDate
getDtFmt	Returns an integer representing the date format that is currently set on the device. 1 = M/D/Y 2 = D/M/Y 3 = Y/M/D	[2nd] [CATALOG] getDtFmt

Function or Instruction/Arguments	Result	Key or Keys/Menu or Screen/Item
getDtStr (<i>integer</i>)	Returns a string of the current date in the format specified by <i>integer</i> , where: 1 = M/D/Y 2 = D/M/Y 3 = Y/M/D	[2nd] [CATALOG] getDtStr(
getKey	Returns the key code for the current keystroke, or 0 , if no key is pressed.	† [PRGM] I/O 7:getKey
getTime	Returns a list giving the time according to the current value of the clock. The list is in <i>{hour,minute,second}</i> format. The time is returned in the 24 hour format.	[2nd] [CATALOG] getTime
getTmFmt	Returns an integer representing the clock time format that is currently set on the device. 12 = 12 hour format 24 = 24 hour format	[2nd] [CATALOG] getTmFmt
getTmStr (<i>integer</i>)	Returns a string of the current clock time in the format specified by <i>integer</i> , where: 12 = 12 hour format 24 = 24 hour format	[2nd] [CATALOG] getTmStr(

Function or Instruction/Arguments	Result	Key or Keys/Menu or Screen/Item
Goto <i>label</i>	Transfers control to <i>label</i> .	† [PRGM] CTL 0:Goto
GraphStyle (<i>function#</i> , <i>graphstyle#</i>)	Sets a <i>graphstyle</i> for <i>function#</i> .	† [PRGM] CTL H:GraphStyle(
GridOff	Turns off grid format.	† [2nd] [FORMAT] GridOff
GridOn	Turns on grid format.	† [2nd] [FORMAT] GridOn
G-T	Sets graph-table vertical split-screen mode.	† [MODE] G-T
Horiz	Sets horizontal split-screen mode.	† [MODE] Horiz
Horizontal <i>y</i>	Draws a horizontal line at <i>y</i> .	[2nd] [DRAW] DRAW 3:Horizontal
identity (<i>dimension</i>)	Returns the identity matrix of <i>dimension</i> rows x <i>dimension</i> columns.	[2nd] [MATRIX] MATH 5:identity(
:if <i>condition</i> :commandA :commands	If <i>condition</i> = 0 (false), skips <i>commandA</i> .	† [PRGM] CTL 1:if

Function or Instruction/Arguments	Result	Key or Keys/Menu or Screen/Item
:If <i>condition</i> :Then <i>commands</i> :End <i>commands</i>	Executes <i>commands</i> from Then to End if <i>condition</i> = 1 (true).	† [PRGM] CTL 2:Then
:If <i>condition</i> :Then <i>commands</i> :Else <i>commands</i> :End <i>commands</i>	Executes <i>commands</i> from Then to Else if <i>condition</i> = 1 (true); from Else to End if <i>condition</i> = 0 (false).	† [PRGM] CTL 3:Else
imag (<i>value</i>)	Returns the imaginary (nonreal) part of a complex number or list of complex numbers.	[MATH] CPX 3:imag(
IndpntAsk	Sets table to ask for independent-variable values.	† [2nd] [TBLSET] Indpnt: Ask
IndpntAuto	Sets table to generate independent-variable values automatically.	† [2nd] [TBLSET] Indpnt: Auto
Input	Displays graph.	† [PRGM] I/O 1:Input

Function or Instruction/Arguments	Result	Key or Keys/Menu or Screen/Item
Input [<i>variable</i>] Input [" <i>text</i> ", <i>variable</i>]	Prompts for value to store to <i>variable</i> .	† [PRGM] I/O 1:Input
Input [Str <i>n</i> , <i>variable</i>]	Displays Str <i>n</i> and stores entered value to <i>variable</i> .	† [PRGM] I/O 1:Input
inString (<i>string</i> , <i>substring</i> [, <i>start</i>])	Returns the character position in <i>string</i> of the first character of <i>substring</i> beginning at <i>start</i> .	[2nd] [CATALOG] inString (
int (<i>value</i>)	Returns the largest integer \leq a real or complex number, expression, list, or matrix.	[MATH] NUM 5:int(
ΣInt (<i>pmt1</i> , <i>pmt2</i> [, <i>roundvalue</i>])	Computes the sum, rounded to <i>roundvalue</i> , of the interest amount between <i>pmt1</i> and <i>pmt2</i> for an amortization schedule.	[APPS] 1:Finance CALC A: ΣInt (
invNorm (<i>area</i> [, μ , σ])	Computes the inverse cumulative normal distribution function for a given <i>area</i> under the normal distribution curve specified by μ and σ .	[2nd] [DISTR] DISTR 3:invNorm(

Function or Instruction/Arguments	Result	Key or Keys/Menu or Screen/Item
invT (<i>area,df</i>)	Computes the inverse cumulative student-t probability function specified by degree of freedom, <i>df</i> for a given area under the curve.	$\boxed{2nd}$ [DISTR] DISTR 4:invT(
iPart (<i>value</i>)	Returns the integer part of a real or complex number, expression, list, or matrix.	\boxed{MATH} NUM 3:iPart(
irr (<i>CF0,CFList[,CFFreq]</i>)	Returns the interest rate at which the net present value of the cash flow is equal to zero.	\boxed{APPS} 1:Finance CALC 8:irr(
:IS> (<i>variable,value</i>) <i>:commandA</i> <i>:commands</i>	Increments <i>variable</i> by 1; skips <i>commandA</i> if <i>variable</i> > <i>value</i> .	\uparrow \boxed{PRGM} CTL A:IS>(
isClockOn	Identifies if clock is ON or OFF. Returns 1 if the clock is ON. Returns 0 if the clock is OFF.	$\boxed{2nd}$ [CATALOG] isClockOn
L <i>listname</i>	Identifies the next one to five characters as a user-created list name.	$\boxed{2nd}$ [LIST] OPS B:L
LabelOff	Turns off axes labels.	\uparrow $\boxed{2nd}$ [FORMAT] LabelOff

Function or Instruction/Arguments	Result	Key or Keys/Menu or Screen/Item
LabelOn	Turns on axes labels.	† [2nd] [FORMAT] LabelOn
Lbl <i>label</i>	Creates a <i>label</i> of one or two characters.	† [PRGM] CTL 9:Lbl
lcm (<i>valueA,valueB</i>)	Returns the least common multiple of <i>valueA</i> and <i>valueB</i> , which can be real numbers or lists.	[MATH] NUM 8:lcm(
length (<i>string</i>)	Returns the number of characters in <i>string</i> .	[2nd] [CATALOG] length(
Line (<i>X1,Y1,X2,Y2</i>)	Draws a line from (<i>X1,Y1</i>) to (<i>X2,Y2</i>).	[2nd] [DRAW] DRAW 2:Line(
Line (<i>X1,Y1,X2,Y2,0</i>)	Erases a line from (<i>X1,Y1</i>) to (<i>X2,Y2</i>).	[2nd] [DRAW] DRAW 2:Line(
LinReg(a+bx) [<i>Xlistname</i> , <i>Ylistname</i> , <i>freqlist</i> , <i>regequ</i>]	Fits a linear regression model to <i>Xlistname</i> and <i>Ylistname</i> with frequency <i>freqlist</i> , and stores the regression equation to <i>regequ</i> .	[STAT] CALC 8:LinReg(a+bx)

Function or Instruction/Arguments	Result	Key or Keys/Menu or Screen/Item
LinReg(ax+b) [<i>Xlistname</i> , <i>Ylistname</i> , <i>freqlist</i> , <i>regequ</i>]	Fits a linear regression model to <i>Xlistname</i> and <i>Ylistname</i> with frequency <i>freqlist</i> , and stores the regression equation to <i>regequ</i> .	[STAT] CALC 4:LinReg(ax+b)
LinRegTTest [<i>Xlistname</i> , <i>Ylistname</i> , <i>freqlist</i> , <i>alternative</i> , <i>regequ</i>]	Performs a linear regression and a <i>t</i> -test. <i>alternative</i> =-1 is <; <i>alternative</i> =0 is ≠; <i>alternative</i> =1 is >.	† [STAT] TESTS F:LinRegTTest
LinRegTInt [<i>Xlistname</i> , <i>Ylistname</i> , <i>freqlist</i> , <i>confidence level</i> , <i>regequ</i>]	Performs a linear regression and computes the <i>t</i> confidence interval for the slope coefficient <i>b</i> .	† [STAT] TESTS G:LinRegTInt
ΔList(list)	Returns a list containing the differences between consecutive elements in <i>list</i> .	[2nd] [LIST] OPS 7:ΔList(
List ▶ matr(listname1, ..., listname n, matrixname)	Fills <i>matrixname</i> column by column with the elements from each specified <i>listname</i> .	[2nd] [LIST] OPS 0>List ▶ matr(
ln(value)	Returns the natural logarithm of a real or complex number, expression, or list.	[LN]

Function or Instruction/Arguments	Result	Key or Keys/Menu or Screen/Item
LnReg [<i>Xlistname</i> , <i>Ylistname</i> , <i>freqlist</i> , <i>regequ</i>]	Fits a logarithmic regression model to <i>Xlistname</i> and <i>Ylistname</i> with frequency <i>freqlist</i> , and stores the regression equation to <i>regequ</i> .	STAT CALC 9:LnReg
log (<i>value</i>)	Returns logarithm of a real or complex number, expression, or list.	LOG
Logistic [<i>Xlistname</i> , <i>Ylistname</i> , <i>freqlist</i> , <i>regequ</i>]	Fits a logistic regression model to <i>Xlistname</i> and <i>Ylistname</i> with frequency <i>freqlist</i> , and stores the regression equation to <i>regequ</i> .	STAT CALC B:Logistic
Manual-Fit <i>equname</i>	Fits a linear equation to a scatter plot.	STAT CALC D:Manual-Fit
Matr→list (<i>matrix</i> , <i>listnameA</i> , ..., <i>listname n</i>)	Fills each <i>listname</i> with elements from each column in <i>matrix</i> .	2nd [LIST] OPS A:Matr→list(
Matr→list (<i>matrix</i> , <i>column#</i> , <i>listname</i>)	Fills a <i>listname</i> with elements from a specified <i>column#</i> in <i>matrix</i> .	2nd [LIST] OPS A:Matr→list(

Function or Instruction/Arguments	Result	Key or Keys/Menu or Screen/Item
max (<i>valueA,valueB</i>)	Returns the larger of <i>valueA</i> and <i>valueB</i> .	MATH NUM 7:max(
max (<i>list</i>)	Returns largest real or complex element in <i>list</i> .	2nd [LIST] MATH 2:max(
max (<i>listA,listB</i>)	Returns a real or complex list of the larger of each pair of elements in <i>listA</i> and <i>listB</i> .	2nd [LIST] MATH 2:max(
max (<i>value,list</i>)	Returns a real or complex list of the larger of <i>value</i> or each <i>list</i> element.	2nd [LIST] MATH 2:max(
mean (<i>list[,freqlist]</i>)	Returns the mean of <i>list</i> with frequency <i>freqlist</i> .	2nd [LIST] MATH 3:mean(
median (<i>list[,freqlist]</i>)	Returns the median of <i>list</i> with frequency <i>freqlist</i> .	2nd [LIST] MATH 4:median(
Med-Med [<i>Xlistname</i> , <i>Ylistname</i> , <i>freqlist</i> , <i>regequ</i>]	Fits a median-median model to <i>Xlistname</i> and <i>Ylistname</i> with frequency <i>freqlist</i> , and stores the regression equation to <i>regequ</i> .	STAT CALC 3:Med-Med

Function or Instruction/Arguments	Result	Key or Keys/Menu or Screen/Item
Menu ("title","text1", <i>label1</i> [,...,"text7", <i>label7</i>])	Generates a menu of up to seven items during program execution.	† PRGM CTL C:Menu(
min (<i>valueA</i> , <i>valueB</i>)	Returns smaller of <i>valueA</i> and <i>valueB</i> .	MATH NUM 6:min(
min (<i>list</i>)	Returns smallest real or complex element in <i>list</i> .	2nd [LIST] MATH 1:min(
min (<i>listA</i> , <i>listB</i>)	Returns real or complex list of the smaller of each pair of elements in <i>listA</i> and <i>listB</i> .	2nd [LIST] MATH 1:min(
min (<i>value</i> , <i>list</i>)	Returns a real or complex list of the smaller of <i>value</i> or each <i>list</i> element.	2nd [LIST] MATH 1:min(
<i>valueA</i> nCr <i>valueB</i>	Returns the number of combinations of <i>valueA</i> taken <i>valueB</i> at a time.	MATH PRB 3:nCr
<i>value</i> nCr <i>list</i>	Returns a list of the combinations of <i>value</i> taken each element in <i>list</i> at a time.	MATH PRB 3:nCr

Function or Instruction/Arguments	Result	Key or Keys/Menu or Screen/Item
<i>list</i> nCr <i>value</i>	Returns a list of the combinations of each element in <i>list</i> taken <i>value</i> at a time.	MATH PRB 3:nCr
<i>listA</i> nCr <i>listB</i>	Returns a list of the combinations of each element in <i>listA</i> taken each element in <i>listB</i> at a time.	MATH PRB 3:nCr
nDeriv (<i>expression</i> , <i>variable</i> , <i>value</i> , ϵ)	Returns approximate numerical derivative of <i>expression</i> with respect to <i>variable</i> at <i>value</i> , with specified ϵ .	MATH MATH 8:nDeriv(
►Nom (<i>effective rate</i> , <i>compounding periods</i>)	Computes the nominal interest rate.	APPS 1:Finance CALC B:►Nom(
Normal	Sets normal display mode.	† MODE Normal
normalcdf (<i>lowerbound</i> , <i>upperbound</i> , μ , σ)	Computes the normal distribution probability between <i>lowerbound</i> and <i>upperbound</i> for the specified μ and σ .	2nd [DISTR] DISTR 2:normalcdf(

Function or Instruction/Arguments	Result	Key or Keys/Menu or Screen/Item
normalpdf (x [, μ , σ])	Computes the probability density function for the normal distribution at a specified x value for the specified μ and σ .	2nd [DISTR] DISTR 1:normalpdf(
not (<i>value</i>)	Returns 0 if <i>value</i> is $\neq 0$. <i>value</i> can be a real number, expression, or list.	2nd [TEST] LOGIC 4:not(
<i>valueA</i> nPr <i>valueB</i>	Returns the number of permutations of <i>valueA</i> taken <i>valueB</i> at a time.	MATH PRB 2:nPr
<i>value</i> nPr <i>list</i>	Returns a list of the permutations of <i>value</i> taken each element in <i>list</i> at a time.	MATH PRB 2:nPr
<i>list</i> nPr <i>value</i>	Returns a list of the permutations of each element in <i>list</i> taken <i>value</i> at a time.	MATH PRB 2:nPr
<i>listA</i> nPr <i>listB</i>	Returns a list of the permutations of each element in <i>listA</i> taken each element in <i>listB</i> at a time.	MATH PRB 2:nPr
npv (<i>interest rate</i> , <i>CF0</i> , <i>CFList</i> [, <i>CFFreq</i>])	Computes the sum of the present values for cash inflows and outflows.	APPS 1:Finance CALC 7:npv(

Function or Instruction/Arguments	Result	Key or Keys/Menu or Screen/Item
<i>valueA</i> or <i>valueB</i>	Returns 1 if <i>valueA</i> or <i>valueB</i> is $\neq 0$. <i>valueA</i> and <i>valueB</i> can be real numbers, expressions, or lists.	$\boxed{2nd}$ [TEST] LOGIC 2:or
Output (<i>row,column, "text"</i>)	Displays <i>text</i> beginning at specified <i>row</i> and <i>column</i> .	\dagger \boxed{PRGM} I/O 6:Output(
Output (<i>row,column, value</i>)	Displays <i>value</i> beginning at specified <i>row</i> and <i>column</i> .	\dagger \boxed{PRGM} I/O 6:Output(
Param	Sets parametric graphing mode.	\dagger \boxed{MODE} Par
Pause	Suspends program execution until you press \boxed{ENTER} .	\dagger \boxed{PRGM} CTL 8:Pause
Pause [<i>value</i>]	Displays <i>value</i> ; suspends program execution until you press \boxed{ENTER} .	\dagger \boxed{PRGM} CTL 8:Pause
Plot# (<i>type,Xlistname, Ylistname,mark</i>)	Defines Plot# (1, 2, or 3) of <i>type</i> Scatter or xyLine for <i>Xlistname</i> and <i>Ylistname</i> using <i>mark</i> .	\dagger $\boxed{2nd}$ [STAT PLOT] STAT PLOTS 1:Plot1- 2:Plot2- 3:Plot3-

Function or Instruction/Arguments	Result	Key or Keys/Menu or Screen/Item
Plot# (<i>type,Xlistname, freqlist</i>)	Defines Plot# (1, 2, or 3) of <i>type</i> Histogram or Boxplot for <i>Xlistname</i> with frequency <i>freqlist</i> .	† [2nd] [STAT PLOT] STAT PLOTS 1:Plot1- 2:Plot2- 3:Plot3-
Plot# (<i>type,Xlistname, freqlist,mark</i>)	Defines Plot# (1, 2, or 3) of <i>type</i> ModBoxplot for <i>Xlistname</i> with frequency <i>freqlist</i> using <i>mark</i> .	† [2nd] [STAT PLOT] STAT PLOTS 1:Plot1- 2:Plot2- 3:Plot3-
Plot# (<i>type,datalistname, data axis,mark</i>)	Defines Plot# (1, 2, or 3) of <i>type</i> NormProbPlot for <i>datalistname</i> on <i>data axis</i> using <i>mark</i> . <i>data axis</i> can be X or Y .	† [2nd] [STAT PLOT] STAT PLOTS 1:Plot1- 2:Plot2- 3:Plot3-
PlotsOff [1,2,3]	Deselects all stat plots or one or more specified stat plots (1, 2, or 3).	[2nd] [STAT PLOT] STAT PLOTS 4:PlotsOff
PlotsOn [1,2,3]	Selects all stat plots or one or more specified stat plots (1, 2, or 3).	[2nd] [STAT PLOT] STAT PLOTS 5:PlotsOn
Pmt_Bgn	Specifies an annuity due, where payments occur at the beginning of each payment period.	[APPS] 1:Finance CALC F:Pmt_Bgn

Function or Instruction/Arguments	Result	Key or Keys/Menu or Screen/Item
Pmt_End	Specifies an ordinary annuity, where payments occur at the end of each payment period.	[APPS] 1:Finance CALC E:Pmt_End
poissoncdf(μ, x)	Computes a cumulative probability at x for the discrete Poisson distribution with specified mean μ .	[2nd] [DISTR] DISTR D:poissoncdf(
poissonpdf(μ, x)	Computes a probability at x for the discrete Poisson distribution with the specified mean μ .	[2nd] [DISTR] DISTR C:poissonpdf(
Polar	Sets polar graphing mode.	† [MODE] Pol
<i>complex value</i> ►Polar	Displays <i>complex value</i> in polar format.	[MATH] CPX 7:►Polar
PolarGC	Sets polar graphing coordinates format.	† [2nd] [FORMAT] PolarGC
prgm <i>name</i>	Executes the program <i>name</i> .	† [PRGM] CTRL D:prgm

Function or Instruction/Arguments	Result	Key or Keys/Menu or Screen/Item
$\Sigma\text{Prn}(pmt1, pmt2$ [,roundvalue])	Computes the sum, rounded to <i>roundvalue</i> , of the principal amount between <i>pmt1</i> and <i>pmt2</i> for an amortization schedule.	[APPS] 1:Finance CALC 0: $\Sigma\text{Prn}()$
prod (list[,start,end])	Returns product of <i>list</i> elements between <i>start</i> and <i>end</i> .	[2nd] [LIST] MATH 6:prod()
Prompt <i>variableA</i> [, <i>variableB</i> ,..., <i>variable n</i>]	Prompts for value for <i>variableA</i> , then <i>variableB</i> , and so on.	† [PRGM] I/O 2:Prompt
1-PropZInt (<i>x,n</i> [, <i>confidence level</i>])	Computes a one-proportion <i>z</i> confidence interval.	† [STAT] TESTS A:1-PropZInt()
2-PropZInt (<i>x1,n1,x2,n2</i> [, <i>confidence level</i>])	Computes a two-proportion <i>z</i> confidence interval.	† [STAT] TESTS B:2-PropZInt()
1-PropZTest (<i>p0,x,n</i> [, <i>alternative,drawflag</i>])	Computes a one-proportion <i>z</i> test. <i>alternative</i> =-1 is <; <i>alternative</i> =0 is ≠; <i>alternative</i> =1 is >. <i>drawflag</i> =1 draws results; <i>drawflag</i> =0 calculates results.	† [STAT] TESTS 5:1-PropZTest()

Function or Instruction/Arguments	Result	Key or Keys/Menu or Screen/Item
2-PropZTest ($x1, n1, x2, n2$ [, <i>alternative</i> , <i>drawflag</i>])	Computes a two-proportion z test. <i>alternative</i> =-1 is <; <i>alternative</i> =0 is \neq ; <i>alternative</i> =1 is >. <i>drawflag</i> =1 draws results; <i>drawflag</i> =0 calculates results.	† [STAT] TESTS 6:2-PropZTest(
Pt-Change (x, y)	Reverses a point at (x, y).	[2nd] [DRAW] POINTS 3:Pt-Change(
Pt-Off (x, y [, <i>mark</i>])	Erases a point at (x, y) using <i>mark</i> .	[2nd] [DRAW] POINTS 2:Pt-Off(
Pt-On (x, y [, <i>mark</i>])	Draws a point at (x, y) using <i>mark</i> .	[2nd] [DRAW] POINTS 1:Pt-On(
PwrReg [<i>Xlistname</i> , <i>Ylistname</i> , <i>freqlist</i> , <i>regequ</i>]	Fits a power regression model to <i>Xlistname</i> and <i>Ylistname</i> with frequency <i>freqlist</i> , and stores the regression equation to <i>regequ</i> .	[STAT] CALC A:PwrReg
Pxl-Change (<i>row</i> , <i>column</i>)	Reverses pixel at (<i>row</i> , <i>column</i>); $0 \leq \textit{row} \leq 62$ and $0 \leq \textit{column} \leq 94$.	[2nd] [DRAW] POINTS 6:Pxl-Change(

Function or Instruction/Arguments	Result	Key or Keys/Menu or Screen/Item
Pxl-Off (<i>row,column</i>)	Erases pixel at (<i>row,column</i>); $0 \leq row \leq 62$ and $0 \leq column \leq 94$.	$\boxed{2nd}$ [DRAW] POINTS 5:Pxl-Off(
Pxl-On (<i>row,column</i>)	Draws pixel at (<i>row,column</i>); $0 \leq row \leq 62$ and $0 \leq column \leq 94$.	$\boxed{2nd}$ [DRAW] POINTS 4:Pxl-On(
pxl-Test (<i>row,column</i>)	Returns 1 if pixel (<i>row,column</i>) is on, 0 if it is off; $0 \leq row \leq 62$ and $0 \leq column \leq 94$.	$\boxed{2nd}$ [DRAW] POINTS 7:pxl-Test(
P►Rx (<i>r,θ</i>)	Returns X , given polar coordinates <i>r</i> and θ or a list of polar coordinates.	$\boxed{2nd}$ [ANGLE] ANGLE 7:P►Rx(
P►Ry (<i>r,θ</i>)	Returns Y , given polar coordinates <i>r</i> and θ or a list of polar coordinates.	$\boxed{2nd}$ [ANGLE] ANGLE 8:P►Ry(
QuadReg [<i>Xlistname</i> , <i>Ylistname</i> , <i>freqlist</i> , <i>regequ</i>]	Fits a quadratic regression model to <i>Xlistname</i> and <i>Ylistname</i> with frequency <i>freqlist</i> , and stores the regression equation to <i>regequ</i> .	\boxed{STAT} CALC 5:QuadReg

Function or Instruction/Arguments	Result	Key or Keys/Menu or Screen/Item
QuartReg [<i>Xlistname</i> , <i>Ylistname</i> , <i>freqlist</i> , <i>regequ</i>]	Fits a quartic regression model to <i>Xlistname</i> and <i>Ylistname</i> with frequency <i>freqlist</i> , and stores the regression equation to <i>regequ</i> .	[STAT] CALC 7:QuartReg
Radian	Sets radian angle mode.	† [MODE] Radian
rand [(<i>numtrials</i>)]	Returns a random number between 0 and 1 for a specified number of trials <i>numtrials</i> .	[MATH] PRB 1:rand
randBin (<i>numtrials</i> , <i>prob</i> [, <i>numsimulations</i>])	Generates and displays a random real number from a specified Binomial distribution.	[MATH] PRB 7:randBin(
randInt (<i>lower</i> , <i>upper</i> [, <i>numtrials</i>])	Generates and displays a random integer within a range specified by <i>lower</i> and <i>upper</i> integer bounds for a specified number of trials <i>numtrials</i> .	[MATH] PRB 5:randInt(
randM (<i>rows</i> , <i>columns</i>)	Returns a random matrix of <i>rows</i> (1-99) × <i>columns</i> (1-99).	[2nd] [MATRIX] MATH 6:randM(

Function or Instruction/Arguments	Result	Key or Keys/Menu or Screen/Item
randNorm (μ, σ [, <i>numtrials</i>])	Generates and displays a random real number from a specified Normal distribution specified by μ and σ for a specified number of trials <i>numtrials</i> .	MATH PRB 6:randNorm(
re^{θi}	Sets the mode to polar complex number mode (re^{θi}).	† MODE re^{θi}
Real	Sets mode to display complex results only when you enter complex numbers.	† MODE Real
real (<i>value</i>)	Returns the real part of a complex number or list of complex numbers.	MATH CPX 2:real(
RecallGDB <i>n</i>	Restores all settings stored in the graph database variable GDB_n .	2nd [DRAW] STO 4:RecallGDB
RecallPic <i>n</i>	Displays the graph and adds the picture stored in Pic_n .	2nd [DRAW] STO 2:RecallPic
<i>complex value</i> ▶ Rect	Displays <i>complex value</i> or list in rectangular format.	MATH CPX 6:▶Rect

Function or Instruction/Arguments	Result	Key or Keys/Menu or Screen/Item
RectGC	Sets rectangular graphing coordinates format.	† [2nd] [FORMAT] RectGC
ref (<i>matrix</i>)	Returns the row-echelon form of a <i>matrix</i> .	[2nd] [MATRIX] MATH A:ref (
:Repeat <i>condition</i> <i>:commands</i> :End <i>:commands</i>	Executes <i>commands</i> until <i>condition</i> is true.	† [PRGM] CTL 6:Repeat
Return	Returns to the calling program.	† [PRGM] CTL E:Return
round (<i>value</i> [, <i>#decimals</i>])	Returns a number, expression, list, or matrix rounded to <i>#decimals</i> (≤ 9).	[MATH] NUM 2:round (
*row (<i>value, matrix, row</i>)	Returns a matrix with <i>row</i> of <i>matrix</i> multiplied by <i>value</i> and stored in <i>row</i> .	[2nd] [MATRIX] MATH E:*row (
row+ (<i>matrix, rowA, rowB</i>)	Returns a matrix with <i>rowA</i> of <i>matrix</i> added to <i>rowB</i> and stored in <i>rowB</i> .	[2nd] [MATRIX] MATH D:row+ (
*row+ (<i>value, matrix, rowA, rowB</i>)	Returns a matrix with <i>rowA</i> of <i>matrix</i> multiplied by <i>value</i> , added to <i>rowB</i> , and stored in <i>rowB</i> .	[2nd] [MATRIX] MATH F:*row+ (

Function or Instruction/Arguments	Result	Key or Keys/Menu or Screen/Item
rowSwap (<i>matrix</i> , <i>rowA</i> , <i>rowB</i>)	Returns a matrix with <i>rowA</i> of <i>matrix</i> swapped with <i>rowB</i> .	$\boxed{2\text{nd}}$ [MATRIX] MATH C:rowSwap(
rref (<i>matrix</i>)	Returns the reduced row-echelon form of a <i>matrix</i> .	$\boxed{2\text{nd}}$ [MATRIX] MATH B:rref(
R►Pr (<i>x,y</i>)	Returns R , given rectangular coordinates <i>x</i> and <i>y</i> or a list of rectangular coordinates.	$\boxed{2\text{nd}}$ [ANGLE] ANGLE 5:R►Pr(
R►Pθ (<i>x,y</i>)	Returns θ , given rectangular coordinates <i>x</i> and <i>y</i> or a list of rectangular coordinates.	$\boxed{2\text{nd}}$ [ANGLE] ANGLE 6:R►Pθ(
2-SampFTest [<i>listname1</i> , <i>listname2</i> , <i>freqlist1</i> , <i>freqlist2</i> , <i>alternative</i> , <i>drawflag</i>] (Data list input)	Performs a two-sample F test. <i>alternative</i> =-1 is <; <i>alternative</i> =0 is ≠; <i>alternative</i> =1 is >. <i>drawflag</i> =1 draws results; <i>drawflag</i> =0 calculates results.	† [STAT] TESTS E:2-SampFTest

Function or Instruction/Arguments	Result	Key or Keys/Menu or Screen/Item
2-SampFTest $Sx1, n1, Sx2, n2$ [, <i>alternative</i> , <i>drawflag</i>] (Summary stats input)	Performs a two-sample F test. <i>alternative</i> =-1 is <; <i>alternative</i> =0 is ≠; <i>alternative</i> =1 is >. <i>drawflag</i> =1 draws results; <i>drawflag</i> =0 calculates results.	† [STAT] TESTS E:2-SampFTest
2-SampTInt [<i>listname1</i> , <i>listname2</i> , <i>freqlist1</i> , <i>freqlist2</i> , <i>confidence level</i> , <i>pooled</i>] (Data list input)	Computes a two-sample <i>t</i> confidence interval. <i>pooled</i> =1 pools variances; <i>pooled</i> =0 does not pool variances.	† [STAT] TESTS 0:2-SampTInt
2-SampTInt $\bar{X}1, Sx1, n1, \bar{X}2, Sx2, n2$ [, <i>confidence level</i> , <i>pooled</i>] (Summary stats input)	Computes a two-sample <i>t</i> confidence interval. <i>pooled</i> =1 pools variances; <i>pooled</i> =0 does not pool variances.	† [STAT] TESTS 0:2-SampTInt
2-SampTTest [<i>listname1</i> , <i>listname2</i> , <i>freqlist1</i> , <i>freqlist2</i> , <i>alternative</i> , <i>pooled</i> , <i>drawflag</i>] (Data list input)	Computes a two-sample <i>t</i> test. <i>alternative</i> =-1 is <; <i>alternative</i> =0 is ≠; <i>alternative</i> =1 is >. <i>pooled</i> =1 pools variances; <i>pooled</i> =0 does not pool variances. <i>drawflag</i> =1 draws results; <i>drawflag</i> =0 calculates results.	† [STAT] TESTS 4:2-SampTTest

Function or Instruction/Arguments	Result	Key or Keys/Menu or Screen/Item
2-SampTTest $\bar{x}1, Sx1, n1, v2, Sx2, n2$ [, <i>alternative</i> , <i>pooled</i> , <i>drawflag</i>] (Summary stats input)	Computes a two-sample <i>t</i> test. <i>alternative</i> =-1 is <; <i>alternative</i> =0 is ≠; <i>alternative</i> =1 is >. <i>pooled</i> =1 pools variances; <i>pooled</i> =0 does not pool variances. <i>drawflag</i> =1 draws results; <i>drawflag</i> =0 calculates results.	† [STAT] TESTS 4:2-SampTTest
2-SampZInt (σ_1, σ_2 [, <i>listname1</i> , <i>listname2</i> , <i>freqlist1</i> , <i>freqlist2</i> , <i>confidence level</i>]) (Data list input)	Computes a two-sample <i>z</i> confidence interval.	† [STAT] TESTS 9:2-SampZInt(
2-SampZInt ($\sigma_1, \sigma_2, \bar{x}1, n1, \bar{x}2, n2$ [, <i>confidence level</i>]) (Summary stats input)	Computes a two-sample <i>z</i> confidence interval.	† [STAT] TESTS 9:2-SampZInt(
2-SampZTest (σ_1, σ_2 [, <i>listname1</i> , <i>listname2</i> , <i>freqlist1</i> , <i>freqlist2</i> , <i>alternative</i> , <i>drawflag</i>]) (Data list input)	Computes a two-sample <i>z</i> test. <i>alternative</i> =-1 is <; <i>alternative</i> =0 is ≠; <i>alternative</i> =1 is >. <i>drawflag</i> =1 draws results; <i>drawflag</i> =0 calculates results.	† [STAT] TESTS 3:2-SampZTest(

Function or Instruction/Arguments	Result	Key or Keys/Menu or Screen/Item
2-SampZTest ($\sigma_1, \sigma_2, \bar{x}_1, n_1, \bar{x}_2, n_2$, [<i>alternative</i> , <i>drawflag</i>]) (Summary stats input)	Computes a two-sample z test. <i>alternative</i> =-1 is <; <i>alternative</i> =0 is \neq ; <i>alternative</i> =1 is >. <i>drawflag</i> =1 draws results; <i>drawflag</i> =0 calculates results.	† [STAT] TESTS 3:2-SampZTest(
Sci	Sets scientific notation display mode.	† [MODE] Sci
Select (<i>Xlistname</i> , <i>Ylistname</i>)	Selects one or more specific data points from a scatter plot or xyLine plot (only), and then stores the selected data points to two new lists, <i>Xlistname</i> and <i>Ylistname</i> .	[2nd] [LIST] OPS 8:Select(
Send (<i>variable</i>)	Sends contents of <i>variable</i> to the CBL 2™ or CBR™ System.	† [PRGM] I/O B:Send (
seq (<i>expression</i> , <i>variable</i> , <i>begin</i> , <i>end</i> , [<i>increment</i>])	Returns list created by evaluating <i>expression</i> with regard to <i>variable</i> , from <i>begin</i> to <i>end</i> by <i>increment</i> .	[2nd] [LIST] OPS 5:seq(
Seq	Sets sequence graphing mode.	† [MODE] Seq

Function or Instruction/Arguments	Result	Key or Keys/Menu or Screen/Item
Sequential	Sets mode to graph functions sequentially.	† MODE Sequential
setDate (<i>year,month,day</i>)	Sets the date using a year, month, day format. The <i>year</i> must be 4 digits; <i>month</i> and <i>day</i> can be 1 or 2 digit.	2nd [CATALOG] setDate (
setDtFmt (<i>integer</i>)	Sets the date format. 1 = M/D/Y 2 = D/M/Y 3 = Y/M/D	2nd [CATALOG] setDtFmt (
setTime (<i>hour,minute,second</i>)	Sets the time using an hour, minute, second format. The <i>hour</i> must be in 24 hour format, in which 13 = 1 p.m.	2nd [CATALOG] setTime (
setTmFmt (<i>integer</i>)	Sets the time format. 12 = 12 hour format 24 = 24 hour format	2nd [CATALOG] setTmFmt (
SetUpEditor	Removes all list names from the stat list editor, and then restores list names L1 through L6 to columns 1 through 6 .	STAT EDIT 5:SetUpEditor

Function or Instruction/Arguments	Result	Key or Keys/Menu or Screen/Item
SetUpEditor <i>listname1</i> [, <i>listname2</i> ,..., <i>listname20</i>]	Removes all list names from the stat list editor, then sets it up to display one or more <i>listnames</i> in the specified order, starting with column 1.	[STAT] EDIT 5:SetUpEditor
Shade (<i>lowerfunc</i> , <i>upperfunc</i> [, <i>Xleft</i> , <i>Xright</i> , <i>pattern</i> , <i>patres</i>])	Draws <i>lowerfunc</i> and <i>upperfunc</i> in terms of X on the current graph and uses <i>pattern</i> and <i>patres</i> to shade the area bounded by <i>lowerfunc</i> , <i>upperfunc</i> , <i>Xleft</i> , and <i>Xright</i> .	[2nd] [DRAW] DRAW 7:Shade(
Shade χ^2 (<i>lowerbound</i> , <i>upperbound</i> , <i>df</i>)	Draws the density function for the χ^2 distribution specified by degrees of freedom <i>df</i> and shades the area between <i>lowerbound</i> and <i>upperbound</i> .	[2nd] [DISTR] DRAW 3:Shade χ^2 (
ShadeF (<i>lowerbound</i> , <i>upperbound</i> , <i>numerator df</i> , <i>denominator df</i>)	Draws the density function for the F distribution specified by <i>numerator df</i> and <i>denominator df</i> and shades the area between <i>lowerbound</i> and <i>upperbound</i> .	[2nd] [DISTR] DRAW 4:ShadeF(

Function or Instruction/Arguments	Result	Key or Keys/Menu or Screen/Item
ShadeNorm (<i>lowerbound</i> , <i>upperbound</i> [, μ , σ])	Draws the normal density function specified by μ and σ and shades the area between <i>lowerbound</i> and <i>upperbound</i> .	$\boxed{2nd}$ [DISTR] DRAW 1:ShadeNorm(
Shade_t (<i>lowerbound</i> , <i>upperbound</i> , <i>df</i>)	Draws the density function for the Student-t distribution specified by degrees of freedom <i>df</i> , and shades the area between <i>lowerbound</i> and <i>upperbound</i> .	$\boxed{2nd}$ [DISTR] DRAW 2:Shade_t(
Simul	Sets mode to graph functions simultaneously.	\dagger \boxed{MODE} Simul
sin (<i>value</i>)	Returns the sine of a real number, expression, or list.	\boxed{SIN}
sin⁻¹ (<i>value</i>)	Returns the arcsine of a real number, expression, or list.	$\boxed{2nd}$ [SIN ⁻¹]
sinh (<i>value</i>)	Returns the hyperbolic sine of a real number, expression, or list.	$\boxed{2nd}$ [CATALOG] sinh(
sinh⁻¹ (<i>value</i>)	Returns the hyperbolic arcsine of a real number, expression, or list.	$\boxed{2nd}$ [CATALOG] sinh⁻¹(

Function or Instruction/Arguments	Result	Key or Keys/Menu or Screen/Item
SinReg [<i>iterations</i> , <i>Xlistname</i> , <i>Ylistname</i> , <i>period</i> , <i>regequ</i>]	Attempts <i>iterations</i> times to fit a sinusoidal regression model to <i>Xlistname</i> and <i>Ylistname</i> using a <i>period</i> guess, and stores the regression equation to <i>regequ</i> .	STAT CALC C:SinReg
solve (<i>expression</i> , <i>variable</i> , <i>guess</i> , { <i>lower</i> , <i>upper</i> })	Solves <i>expression</i> for <i>variable</i> , given an initial <i>guess</i> and <i>lower</i> and <i>upper</i> bounds within which the solution is sought.	† MATH MATH 0:solve(
SortA (<i>listname</i>)	Sorts elements of <i>listname</i> in ascending order.	2nd [LIST] OPS 1:SortA(
SortA (<i>keylistname</i> , <i>dependlist1</i> [, <i>dependlist2</i> , ..., <i>dependlist n</i>])	Sorts elements of <i>keylistname</i> in ascending order, then sorts each <i>dependlist</i> as a dependent list.	2nd [LIST] OPS 1:SortA(
SortD (<i>listname</i>)	Sorts elements of <i>listname</i> in descending order.	2nd [LIST] OPS 2:SortD(

Function or Instruction/Arguments	Result	Key or Keys/Menu or Screen/Item
SortD (<i>keylistname</i> , <i>dependlist1</i> [, <i>dependlist2</i> , ..., <i>dependlist n</i>])	Sorts elements of <i>keylistname</i> in descending order, then sorts each <i>dependlist</i> as a dependent list.	$\boxed{2nd}$ [LIST] OPS 2:SortD(
startTmr	Starts the clock timer. Store or note the displayed value, and use it as the argument for checkTmr() to check the elapsed time.	$\boxed{2nd}$ [CATALOG] startTmr
stdDev (<i>list</i> [, <i>freqlist</i>])	Returns the standard deviation of the elements in <i>list</i> with frequency <i>freqlist</i> .	$\boxed{2nd}$ [LIST] MATH 7:stdDev(
Stop	Ends program execution; returns to home screen.	† \boxed{PRGM} CTL F:Stop
Store: <i>value</i> → <i>variable</i>	Stores <i>value</i> in <i>variable</i> .	\boxed{STO} →
StoreGDB <i>n</i>	Stores current graph in database GDB <i>n</i> .	$\boxed{2nd}$ [DRAW] STO 3:StoreGDB
StorePic <i>n</i>	Stores current picture in picture Pic <i>n</i> .	$\boxed{2nd}$ [DRAW] STO 1:StorePic
String → Equ (<i>string</i> , Y= <i>var</i>)	Converts <i>string</i> into an equation and stores it in Y= <i>var</i> .	$\boxed{2nd}$ [CATALOG] String → Equ(

Function or Instruction/Arguments	Result	Key or Keys/Menu or Screen/Item
sub (<i>string,begin,length</i>)	Returns a string that is a subset of another <i>string</i> , from <i>begin</i> to <i>length</i> .	$\boxed{2\text{nd}}$ [CATALOG] sub (
sum (<i>list[,start,end]</i>)	Returns the sum of elements of <i>list</i> from <i>start</i> to <i>end</i> .	$\boxed{2\text{nd}}$ [LIST] MATH 5:sum (
tan (<i>value</i>)	Returns the tangent of a real number, expression, or list.	$\boxed{\text{TAN}}$
tan ⁻¹ (<i>value</i>)	Returns the arctangent of a real number, expression, or list.	$\boxed{2\text{nd}}$ [TAN ⁻¹]
Tangent (<i>expression, value</i>)	Draws a line tangent to <i>expression</i> at X = <i>value</i> .	$\boxed{2\text{nd}}$ [DRAW] DRAW 5:Tangent (
tanh (<i>value</i>)	Returns hyperbolic tangent of a real number, expression, or list.	$\boxed{2\text{nd}}$ [CATALOG] tanh (
tanh ⁻¹ (<i>value</i>)	Returns the hyperbolic arctangent of a real number, expression, or list.	$\boxed{2\text{nd}}$ [CATALOG] tanh ⁻¹ (
tcdf (<i>lowerbound, upperbound,df</i>)	Computes the Student- <i>t</i> distribution probability between <i>lowerbound</i> and <i>upperbound</i> for the specified degrees of freedom <i>df</i> .	$\boxed{2\text{nd}}$ [DISTR] DISTR 6:tcdf (

Function or Instruction/Arguments	Result	Key or Keys/Menu or Screen/Item
Text (<i>row,column,text1, text2,...,text n</i>)	Writes <i>text</i> on graph beginning at pixel (<i>row,column</i>), where $0 \leq \textit{row} \leq 57$ and $0 \leq \textit{column} \leq 94$.	$\boxed{2\text{nd}}$ [DRAW] DRAW 0:Text(
Then <i>See If:Then</i>		
Time	Sets sequence graphs to plot with respect to time.	\dagger $\boxed{2\text{nd}}$ [FORMAT] Time
timeCnv (<i>seconds</i>)	Converts seconds to units of time that can be more easily understood for evaluation. The list is in <i>{days,hours,minutes,seconds}</i> format.	$\boxed{2\text{nd}}$ [CATALOG] timeCnv
TInterval [<i>listname, freqlist,confidence level</i>] (Data list input)	Computes a <i>t</i> confidence interval.	\dagger $\boxed{\text{STAT}}$ TESTS 8:TInterval
TInterval \bar{x},Sx,n [, <i>confidence level</i>] (Summary stats input)	Computes a <i>t</i> confidence interval.	\dagger $\boxed{\text{STAT}}$ TESTS 8:TInterval

Function or Instruction/Arguments	Result	Key or Keys/Menu or Screen/Item
tpdf (x, df)	Computes the probability density function (pdf) for the Student- t distribution at a specified x value with specified degrees of freedom df .	$\boxed{2nd}$ $\boxed{[DISTR]}$ DISTR 5:tpdf(
Trace	Displays the graph and enters TRACE mode.	\boxed{TRACE}
T-Test μ_0 [$listname, freqlist, alternative, drawflag$] (Data list input)	Performs a t test with frequency $freqlist$. $alternative=-1$ is $<$; $alternative=0$ is \neq ; $alternative=1$ is $>$. $drawflag=1$ draws results; $drawflag=0$ calculates results.	\dagger \boxed{STAT} TESTS 2:T-Test
T-Test μ_0, \bar{X}, Sx, n [$alternative, drawflag$] (Summary stats input)	Performs a t test with frequency $freqlist$. $alternative=-1$ is $<$; $alternative=0$ is \neq ; $alternative=1$ is $>$. $drawflag=1$ draws results; $drawflag=0$ calculates results.	\dagger \boxed{STAT} TESTS 2:T-Test
tvm_FV [($N, I\%, PV, PMT, P/Y, C/Y$)]	Computes the future value.	\boxed{APPS} 1:Finance CALC 6:tvm_FV

Function or Instruction/Arguments	Result	Key or Keys/Menu or Screen/Item
tvm_I% [(N,PV,PMT,FV,P/Y,C/Y)]	Computes the annual interest rate.	[APPS] 1:Finance CALC 3:tvm_I%
tvm_N [(I%,PV,PMT,FV,P/Y,C/Y)]	Computes the number of payment periods.	[APPS] 1:Finance CALC 5:tvm_N
tvm_Pmt [(N,I%,PV,FV,P/Y,C/Y)]	Computes the amount of each payment.	[APPS] 1:Finance CALC 2:tvm_Pmt
tvm_PV [(N,I%,PMT,FV,P/Y,C/Y)]	Computes the present value.	[APPS] 1:Finance CALC 4:tvm_PV
UnArchive	Moves the specified variables from the user data archive memory to RAM. To archive variables, use Archive .	[2nd] [MEM] 6:UnArchive
uvAxes	Sets sequence graphs to plot $u(n)$ on the x-axis and $v(n)$ on the y-axis.	† [2nd] [FORMAT] uv
uwAxes	Sets sequence graphs to plot $u(n)$ on the x-axis and $w(n)$ on the y-axis.	† [2nd] [FORMAT] uw

Function or Instruction/Arguments	Result	Key or Keys/Menu or Screen/Item
1-Var Stats [<i>Xlistname</i> , <i>freqlist</i>]	Performs one-variable analysis on the data in <i>Xlistname</i> with frequency <i>freqlist</i> .	$\boxed{\text{STAT}}$ CALC 1:1-Var Stats
2-Var Stats [<i>Xlistname</i> , <i>Ylistname</i> , <i>freqlist</i>]	Performs two-variable analysis on the data in <i>Xlistname</i> and <i>Ylistname</i> with frequency <i>freqlist</i> .	$\boxed{\text{STAT}}$ CALC 2:2-Var Stats
variance (<i>list</i> [, <i>freqlist</i>])	Returns the variance of the elements in <i>list</i> with frequency <i>freqlist</i> .	$\boxed{2\text{nd}}$ [LIST] MATH 8:variance(
Vertical <i>x</i>	Draws a vertical line at <i>x</i> .	$\boxed{2\text{nd}}$ [DRAW] DRAW 4:Vertical
vwAxes	Sets sequence graphs to plot v (<i>n</i>) on the x-axis and w (<i>n</i>) on the y-axis.	† $\boxed{2\text{nd}}$ [FORMAT] vw
Web	Sets sequence graphs to trace as webs.	† $\boxed{2\text{nd}}$ [FORMAT] Web
:While <i>condition</i> <i>:commands</i> :End <i>:command</i>	Executes <i>commands</i> while <i>condition</i> is true.	† $\boxed{\text{PRGM}}$ CTL 5:While

Function or Instruction/Arguments	Result	Key or Keys/Menu or Screen/Item
$valueA$ xor $valueB$	Returns 1 if only $valueA$ or $valueB = 0$. $valueA$ and $valueB$ can be real numbers, expressions, or lists.	$\boxed{2nd}$ [TEST] LOGIC 3:xor
ZBox	Displays a graph, lets you draw a box that defines a new viewing window, and updates the window.	\dagger \boxed{ZOOM} ZOOM 1:ZBox
ZDecimal	Adjusts the viewing window so that $\Delta X=0.1$ and $\Delta Y=0.1$, and displays the graph screen with the origin centered on the screen.	\dagger \boxed{ZOOM} ZOOM 4:ZDecimal
ZInteger	Redefines the viewing window using these dimensions: $\Delta X=1$ Xscl=10 $\Delta Y=1$ Yscl=10	\dagger \boxed{ZOOM} ZOOM 8:ZInteger
ZInterval σ [<i>listname</i> , <i>freqlist,confidence level</i>] (Data list input)	Computes a z confidence interval.	\dagger \boxed{STAT} TESTS 7:ZInterval
ZInterval σ, \bar{x}, n [<i>confidence level</i>] (Summary stats input)	Computes a z confidence interval.	\dagger \boxed{STAT} TESTS 7:ZInterval

Function or Instruction/Arguments	Result	Key or Keys/Menu or Screen/Item
Zoom In	Magnifies the part of the graph that surrounds the cursor location.	† ZOOM 2:Zoom In
Zoom Out	Displays a greater portion of the graph, centered on the cursor location.	† ZOOM 3:Zoom Out
ZoomFit	Recalculates Ymin and Ymax to include the minimum and maximum Y values, between Xmin and Xmax , of the selected functions and replots the functions.	† ZOOM 0:ZoomFit
ZoomRcl	Graphs the selected functions in a user-defined viewing window.	† ZOOM MEMORY 3:ZoomRcl
ZoomStat	Redefines the viewing window so that all statistical data points are displayed.	† ZOOM 9:ZoomStat
ZoomSto	Immediately stores the current viewing window.	† ZOOM MEMORY 2:ZoomSto

Function or Instruction/Arguments	Result	Key or Keys/Menu or Screen/Item
ZPrevious	Replots the graph using the window variables of the graph that was displayed before you executed the last ZOOM instruction.	† ZOOM MEMORY 1:ZPrevious
ZSquare	Adjusts the X or Y window settings so that each pixel represents an equal width and height in the coordinate system, and updates the viewing window.	† ZOOM ZOOM 5:ZSquare
ZStandard	Replots the functions immediately, updating the window variables to the default values.	† ZOOM ZOOM 6:ZStandard
Z-Test (μ_0, σ [, <i>listname</i> , <i>freqlist</i> , <i>alternative</i> , <i>drawflag</i>]) (Data list input)	Performs a <i>z</i> test with frequency <i>freqlist</i> . <i>alternative</i> =-1 is <; <i>alternative</i> =0 is ≠; <i>alternative</i> =1 is >. <i>drawflag</i> =1 draws results; <i>drawflag</i> =0 calculates results.	† STAT TESTS 1:Z-Test(

Function or Instruction/Arguments	Result	Key or Keys/Menu or Screen/Item
Z-Test ($\mu_0, \sigma, \bar{x}, n$ [, <i>alternative</i> , <i>drawflag</i>]) (Summary stats input)	Performs a z test. <i>alternative</i> =-1 is <; <i>alternative</i> =0 is \neq ; <i>alternative</i> =1 is >. <i>drawflag</i> =1 draws results; <i>drawflag</i> =0 calculates results.	† [STAT] TESTS 1: Z-Test (
ZTrig	Replots the functions immediately, updating the window variables to preset values for plotting trig functions.	† [ZOOM] ZOOM 7: ZTrig
Factorial: <i>value</i> !	Returns factorial of <i>value</i> .	[MATH] PRB 4:!
Factorial: <i>list</i> !	Returns factorial of <i>list</i> elements.	[MATH] PRB 4:!
Degrees notation: <i>value</i> [°]	Interprets <i>value</i> as degrees; designates degrees in DMS format.	[2nd] [ANGLE] ANGLE 1:°
Radian: <i>angle</i> ^r	Interprets <i>angle</i> as radians.	[2nd] [ANGLE] ANGLE 3: ^r

Function or Instruction/Arguments	Result	Key or Keys/Menu or Screen/Item
Transpose: $matrix^T$	Returns a matrix in which each element (row, column) is swapped with the corresponding element (column, row) of $matrix$.	$\boxed{2nd}$ [MATRIX] MATH $2:^T$
$x^{th}root^x\sqrt{value}$	Returns $x^{th}root$ of $value$.	\boxed{MATH} MATH $5:^x\sqrt{}$
$x^{th}root^x\sqrt{list}$	Returns $x^{th}root$ of $list$ elements.	\boxed{MATH} MATH $5:^x\sqrt{}$
$list^x\sqrt{value}$	Returns $list$ roots of $value$.	\boxed{MATH} MATH $5:^x\sqrt{}$
$listA^x\sqrt{listB}$	Returns $listA$ roots of $listB$.	\boxed{MATH} MATH $5:^x\sqrt{}$
Cube: $value^3$	Returns the cube of a real or complex number, expression, list, or square matrix.	\boxed{MATH} MATH $3:3$
Cube root: $^3\sqrt{(value)}$	Returns the cube root of a real or complex number, expression, or list.	\boxed{MATH} MATH $4:3\sqrt{($

Function or Instruction/Arguments	Result	Key or Keys/Menu or Screen/Item
Equal: $valueA=valueB$	Returns 1 if $valueA = valueB$. Returns 0 if $valueA \neq valueB$. $valueA$ and $valueB$ can be real or complex numbers, expressions, lists, or matrices.	$\boxed{2nd}$ [TEST] TEST 1:=
Not equal: $valueA \neq valueB$	Returns 1 if $valueA \neq valueB$. Returns 0 if $valueA = valueB$. $valueA$ and $valueB$ can be real or complex numbers, expressions, lists, or matrices.	$\boxed{2nd}$ [TEST] TEST 2:\neq
Less than: $valueA < valueB$	Returns 1 if $valueA < valueB$. Returns 0 if $valueA \geq valueB$. $valueA$ and $valueB$ can be real or complex numbers, expressions, or lists.	$\boxed{2nd}$ [TEST] TEST 5:<
Greater than: $valueA > valueB$	Returns 1 if $valueA > valueB$. Returns 0 if $valueA \leq valueB$. $valueA$ and $valueB$ can be real or complex numbers, expressions, or lists.	$\boxed{2nd}$ [TEST] TEST 3:>

Function or Instruction/Arguments	Result	Key or Keys/Menu or Screen/Item
Less than or equal: $valueA \leq valueB$	Returns 1 if $valueA \leq valueB$. Returns 0 if $valueA > valueB$. $valueA$ and $valueB$ can be real or complex numbers, expressions, or lists.	$\boxed{2nd}$ [TEST] TEST 6: \leq
Greater than or equal: $valueA \geq valueB$	Returns 1 if $valueA \geq valueB$. Returns 0 if $valueA < valueB$. $valueA$ and $valueB$ can be real or complex numbers, expressions, or lists.	$\boxed{2nd}$ [TEST] TEST 4: \geq
Inverse: $value^{-1}$	Returns 1 divided by a real or complex number or expression.	$\boxed{x^{-1}}$
Inverse: $list^{-1}$	Returns 1 divided by $list$ elements.	$\boxed{x^{-1}}$
Inverse: $matrix^{-1}$	Returns $matrix$ inverted.	$\boxed{x^{-1}}$
Square: $value^2$	Returns $value$ multiplied by itself. $value$ can be a real or complex number or expression.	$\boxed{x^2}$
Square: $list^2$	Returns $list$ elements squared.	$\boxed{x^2}$
Square: $matrix^2$	Returns $matrix$ multiplied by itself.	$\boxed{x^2}$

Function or Instruction/Arguments	Result	Key or Keys/Menu or Screen/Item
Powers: $value^{power}$	Returns $value$ raised to $power$. $value$ can be a real or complex number or expression.	\square^{\wedge}
Powers: $list^{power}$	Returns $list$ elements raised to $power$.	\square^{\wedge}
Powers: $value^{list}$	Returns $value$ raised to $list$ elements.	\square^{\wedge}
Powers: $matrix^{power}$	Returns $matrix$ elements raised to $power$.	\square^{\wedge}
Negation: $-value$	Returns the negative of a real or complex number, expression, list, or matrix.	$\square^{(-)}$
Power of ten: $10^{(value)}$	Returns 10 raised to the $value$ power. $value$ can be a real or complex number or expression.	$\square^{[2nd]} [10^x]$
Power of ten: $10^{(list)}$	Returns a list of 10 raised to the $list$ power.	$\square^{[2nd]} [10^x]$
Square root: $\sqrt{(value)}$	Returns square root of a real or complex number, expression, or list.	$\square^{[2nd]} [\sqrt{\quad}]$
Multiplication: $valueA * valueB$	Returns $valueA$ times $valueB$.	\square^{\times}

Function or Instruction/Arguments	Result	Key or Keys/Menu or Screen/Item
Multiplication: $value * list$	Returns $value$ times each $list$ element.	\times
Multiplication: $list * value$	Returns each $list$ element times $value$.	\times
Multiplication: $listA * listB$	Returns $listA$ elements times $listB$ elements.	\times
Multiplication: $value * matrix$	Returns value times $matrix$ elements.	\times
Multiplication: $matrixA * matrixB$	Returns $matrixA$ times $matrixB$.	\times
Division: $valueA / valueB$	Returns $valueA$ divided by $valueB$.	\div
Division: $list / value$	Returns $list$ elements divided by value.	\div
Division: $value / list$	Returns value divided by $list$ elements.	\div
Division: $listA / listB$	Returns $listA$ elements divided by $listB$ elements.	\div
Addition: $valueA + valueB$	Returns $valueA$ plus $valueB$.	$+$
Addition: $list + value$	Returns list in which $value$ is added to each $list$ element.	$+$
Addition: $listA + listB$	Returns $listA$ elements plus $listB$ elements.	$+$

Function or Instruction/Arguments	Result	Key or Keys/Menu or Screen/Item
Addition: $matrixA+matrixB$	Returns $matrixA$ elements plus $matrixB$ elements.	$\boxed{+}$
Concatenation: $string1+string2$	Concatenates two or more strings.	$\boxed{+}$
Subtraction: $valueA-valueB$	Subtracts $valueB$ from $valueA$.	$\boxed{-}$
Subtraction: $value-list$	Subtracts $list$ elements from $value$.	$\boxed{-}$
Subtraction: $list-value$	Subtracts $value$ from $list$ elements.	$\boxed{-}$
Subtraction: $listA-listB$	Subtracts $listB$ elements from $listA$ elements.	$\boxed{-}$
Subtraction: $matrixA-matrixB$	Subtracts $matrixB$ elements from $matrixA$ elements.	$\boxed{-}$
Minutes notation: $degrees^{\circ}minutes'seconds''$	Interprets $minutes$ angle measurement as minutes.	$\boxed{2nd}$ [ANGLE] ANGLE 2:'
Seconds notation: $degrees^{\circ}minutes'seconds''$	Interprets $seconds$ angle measurement as seconds.	\boxed{ALPHA} ["]

Appendix B: Reference Information

Variables

User Variables

The TI-84 Plus uses the variables listed below in various ways. Some variables are restricted to specific data types.

The variables **A** through **Z** and θ are defined as real or complex numbers. You may store to them. The TI-84 Plus can update **X**, **Y**, **R**, θ , and **T** during graphing, so you may want to avoid using these variables to store nongraphing data.

The variables (list names) **L1** through **L6** are restricted to lists; you cannot store another type of data to them.

The variables (matrix names) **[A]** through **[J]** are restricted to matrices; you cannot store another type of data to them.

The variables **Pic1** through **Pic9** and **Pic0** are restricted to pictures; you cannot store another type of data to them.

The variables **GDB1** through **GDB9** and **GDB0** are restricted to graph databases; you cannot store another type of data to them.

The variables **Str1** through **Str9** and **Str0** are restricted to strings; you cannot store another type of data to them.

Except for system variables, you can store any string of characters, functions, instructions, or variables to the functions Y_n , (1 through 9, and 0), X_nT/Y_nT (1 through 6), r_n (1 through 6), $u(n)$, $v(n)$, and $w(n)$ directly or through the $Y=$ editor. The validity of the string is determined when the function is evaluated.

Archive Variables

You can store data, programs or any variable from RAM to user data archive memory where they cannot be edited or deleted inadvertently. Archiving also allows you to free up RAM for variables that may require additional memory. The names of archived variables are preceded by an asterisk “*” indicating they are in user data archive.

System Variables

The variables below must be real numbers. You may store to them. Since the TI-84 Plus can update some of them, as the result of a **ZOOM**, for example, you may want to avoid using these variables to store nongraphing data.

- **Xmin, Xmax, Xscl, ΔX, XFact, Tstep, PlotStart, nMin**, and other window variables.
- **ZXmin, ZXmax, ZXscl, ZTstep, ZPlotStart, Zu(nMin)**, and other **ZOOM** variables.

The variables below are reserved for use by the TI-84 Plus. You cannot store to them.

n, \bar{x} , Sx, σ_x , minX, maxX, Gy, Σy^2 , Σxy , a, b, c, RegEQ, x1, x2, y1, z, t, F, χ^2 , \hat{p} , \bar{x}_1 , Sx1, n1, lower, upper, r^2 , R^2 and other statistical variables.

Statistics Formulas

This section contains statistics formulas for the **Logistic** and **SinReg** regressions, **ANOVA**, **2-SampFTest**, and **2-SampTTest**.

Logistic

The logistic regression algorithm applies nonlinear recursive least-squares techniques to optimize the following cost function:

$$J = \sum_{i=1}^N \left(\frac{c}{1 + ae^{-bx_i}} - y_i \right)^2$$

which is the sum of the squares of the residual errors,

where: x = the independent variable list
 y = the dependent variable list
 N = the dimension of the lists

This technique attempts to estimate the constants a , b , and c recursively to make J as small as possible.

SinReg

The sine regression algorithm applies nonlinear recursive least-squares techniques to optimize the following cost function:

$$J = \sum_{i=1}^N [a \sin(bx_i + c) + d - y_i]^2$$

which is the sum of the squares of the residual errors,

where: x = the independent variable list
 y = the dependent variable list
 N = the dimension of the lists

This technique attempts to recursively estimate the constants a , b , c , and d to make J as small as possible.

ANOVA(

The **ANOVA F** statistic is:

$$\mathbf{F} = \frac{\text{FactorMS}}{\text{ErrorMS}}$$

The mean squares (*MS*) that make up **F** are:

$$FactorMS = \frac{FactorSS}{Factordf}$$

$$ErrorMS = \frac{ErrorSS}{Errordf}$$

The sum of squares (*SS*) that make up the mean squares are:

$$FactorSS = \sum_{i=1}^I n_i(\bar{x}_i - \bar{x})^2$$

$$ErrorSS = \sum_{i=1}^I (n_i - 1)Sx_i^2$$

The degrees of freedom *df* that make up the mean squares are:

$$Factordf = I - 1 = \text{numerator}df \text{ for } \mathbf{F}$$

$$Errordf = \sum_{i=1}^I (n_i - 1) = \text{denominator}df \text{ for } \mathbf{F}$$

where: *I* = number of populations
 \bar{x}_i = the mean of each list
Sxi = the standard deviation of each list
ni = the length of each list
 \bar{x} = the mean of all lists

2-SampFTest

Below is the definition for the **2-SampFTest**.

$Sx1, Sx2$ = Sample standard deviations having n_1-1 and n_2-1 degrees of freedom df , respectively.

F = F-statistic = $\left(\frac{Sx1}{Sx2}\right)^2$

$df(x, n_1-1, n_2-1)$ = Fpdf() with degrees of freedom df, n_1-1 , and n_2-1

p = reported p value

2-SampFTest for the alternative hypothesis $\sigma_1 > \sigma_2$.

$$p = \int_F^{\alpha} f(x, n_1-1, n_2-1) dx$$

2-SampFTest for the alternative hypothesis $\sigma_1 < \sigma_2$.

$$p = \int_0^F f(x, n_1-1, n_2-1) dx$$

2-SampFTest for the alternative hypothesis $\sigma_1 \neq \sigma_2$. Limits must satisfy the following:

$$\frac{P}{2} = \int_0^{Lbnd} f(x, n_1 - 1, n_2 - 1) dx = \int_{Ubnd}^{\infty} f(x, n_1 - 1, n_2 - 1) dx$$

where: $[Lbnd, Ubnd]$ = lower and upper limits

The **F**-statistic is used as the bound producing the smallest integral. The remaining bound is selected to achieve the preceding integral's equality relationship.

2-SampTTest

The following is the definition for the **2-SampTTest**. The two-sample t statistic with degrees of freedom df is:

$$t = \frac{\bar{x}_1 - \bar{x}_2}{S}$$

where the computation of S and df are dependent on whether the variances are pooled. If the variances are not pooled:

$$S = \sqrt{\frac{Sx_1^2}{n_1} + \frac{Sx_2^2}{n_2}}$$

$$df = \frac{\left(\frac{Sx_1^2}{n_1} + \frac{Sx_2^2}{n_2}\right)^2}{\frac{1}{n_1 - 1} \left(\frac{Sx_1^2}{n_1}\right)^2 + \frac{1}{n_2 - 1} \left(\frac{Sx_2^2}{n_2}\right)^2}$$

otherwise:

$$Sx_p = \frac{(n_1 - 1)Sx_1^2 + (n_2 - 1)Sx_2^2}{df}$$

$$S = \sqrt{\frac{1}{n_1} + \frac{1}{n_2} Sx_p}$$

$$df = n_1 + n_2 - 2$$

and Sx_p is the pooled variance.

Financial Formulas

This section contains financial formulas for computing time value of money, amortization, cash flow, interest-rate conversions, and days between dates.

Time Value of Money

$$i = [e^{(y \times \ln(x + 1))}] - 1$$

where $PMT \neq 0$

: $y = C/Y \div P/Y$

$x = (.01 \times I\%) \div C/Y$

$C/Y =$ compounding periods per year

$P/Y =$ payment periods per year

$I\% =$ interest rate per year

$$i = (-FV \div PV)^{(1 \div N)} - 1$$

where: $PMT = 0$

The iteration used to compute i :

$$0 = PV + PMT \times G_i \left[\frac{1 - (1 + i)^{-N}}{i} \right] + FV \times (1 + i)^{-N}$$

$$I\% = 100 \times C/Y \times [e^{(y \times \ln(x + 1))} - 1]$$

where: $x = i$

$$y = P/Y \div C/Y$$

$$G_i = 1 + i \times k$$

where: $k = 0$ for end-of-period payments

$k = 1$ for beginning-of-period payments

$$N = \frac{\ln\left(\frac{PMT \times G_i - FV \times i}{PMT \times G_i + PV \times i}\right)}{\ln(1 + i)}$$

where: $i \neq 0$

$$N = -(PV + FV) \div PMT$$

where: $i = 0$

$$PMT = \frac{-i}{G_i} \times \left[PV + \frac{PV + FV}{(1+i)^N - 1} \right]$$

where: $i \neq 0$

$$PMT = -(PV + FV) \div N$$

where: $i = 0$

$$PV = \left[\frac{PMT \times G_i}{i} - FV \right] \times \frac{1}{(1+i)^N} - \frac{PMT \times G_i}{i}$$

where: $i \neq 0$

$$PV = -(FV + PMT \times N)$$

where: $i = 0$

$$FV = \frac{PMT \times G_i}{i} - (1+i)^N \times \left(PV + \frac{PMT \times G_i}{i} \right)$$

where: $i \neq 0$

$$FV = -(PV + PMT \times N)$$

where: $i = 0$

Amortization

If computing $bal()$, $pmt2 = npmt$

Let $bal(0) = RND(PV)$

Iterate from $m = 1$ to $pmt2$

$$\begin{cases} I_m = RND[RND12(-i \times bal(m-1))] \\ bal(m) = bal(m-1) - I_m + RND(PMT) \end{cases}$$

then:

$$bal() = bal(pmt2)$$

$$\Sigma Prn() = bal(pmt2) - bal(pmt1)$$

$$\Sigma Int() = (pmt2 - pmt1 + 1) \times RND(PMT) - \Sigma Prn()$$

where: RND = round the display to the number of decimal places selected

$RND12$ = round to 12 decimal places

Balance, principal, and interest are dependent on the values of **PMT**, **PV**, **I%**, and $pmt1$ and $pmt2$.

Cash Flow

$$npv() = CF_0 + \sum_{j=1}^N CF_j (1+i)^{-S_j-1} \frac{(1-(1+i)^{-n_j})}{i}$$

$$\text{where: } S_j = \begin{cases} \sum_{i=1}^j n_i & j \geq 1 \\ 0 & j = 0 \end{cases}$$

Net present value is dependent on the values of the initial cash flow (CF_0), subsequent cash flows (CF_j), frequency of each cash flow (n_j), and the specified interest rate (i).

$$irr() = 100 \times i, \text{ where } i \text{ satisfies } npv() = 0$$

Internal rate of return is dependent on the values of the initial cash flow (CF_0) and subsequent cash flows (CF_j).

$$i = I\% \div 100$$

Interest Rate Conversions

$$\blacktriangleright Eff = 100 \times (e^{CP \times \ln(x+1)} - 1)$$

$$\text{where: } x = .01 \times Nom \div CP$$

$$\blacktriangleright \text{Nom} = 100 \times CP \times [e^{1 \div CP \times \ln(x+1)} - 1]$$

where: $x = .01 \times \text{Eff}$

$\text{Eff} = \text{effective rate}$

$CP = \text{compounding periods}$

$\text{Nom} = \text{nominal rate}$

Days between Dates

With the **dbd()** function, you can enter or compute a date within the range Jan. 1, 1950, through Dec. 31, 2049.

Actual/actual day-count method (assumes actual number of days per month and actual number of days per year):

dbd() (days between dates) = Number of Days II - Number of Days I

$$\begin{aligned} \text{Number of Days I} &= (Y1 - YB) \times 365 \\ &+ (\text{number of days } MB \text{ to } M1) \\ &+ DT1 \\ &+ \frac{(Y1 - YB)}{4} \end{aligned}$$

$$\text{Number of Days II} = (Y2 - YB) \times 365$$

$$\begin{aligned}
&+ \text{ (number of days } MB \text{ to } M2) \\
&+ DT2 \\
&+ \frac{(Y2 - YB)}{4}
\end{aligned}$$

where: *M1* = month of first date
DT1 = day of first date
Y1 = year of first date
M2 = month of second date
DT2 = day of second date
Y2 = year of second date
MB = base month (January)
DB = base day (1)
YB = base year (first year after leap year)

Important Things You Need to Know About Your TI-84 Plus

TI-84 Plus Results

There may be a number of reasons that your TI-84 Plus is not displaying the expected results; however, the most common solutions involve order of operations or mode settings. Your calculator uses an Equation Operating System (EOS) which evaluates the functions in an expression in the following order:

1. Functions that precede the argument, such as square root, $\sin()$, or $\log()$
2. Functions that are entered after the argument, such as exponents, factorial, $r, ^\circ$, and conversions
3. Powers and roots, such as 2^5 , or $5 \times \text{square root}(32)$
4. Permutations (nPr) and combinations (nCr)
5. Multiplication, implied multiplication, and division
6. Addition and subtraction
7. Relational functions, such as $>$ or $<$
8. Logic operator and
9. Logic operators or and xor

Remember that EOS evaluates from left to right and calculations within parentheses are evaluated first. You should use parentheses where the rules of algebra may not be clear.

If you are using trigonometric functions or performing polar and rectangular conversions, the unexpected results may be caused by an angle mode setting. The Radian and Degree angle mode settings control how the TI-84 Plus interprets angle values.

To change the angle mode settings, follow these steps:

1. Press **MODE** to display the Mode settings.
2. Select **Degree** or **Radian**.
3. Press **ENTER** to save the angle mode setting.

ERR:DIM MISMATCH Error

Your TI-84 Plus displays the **ERR:DIM MISMATCH** error if you are trying to perform an operation that references one or more lists or matrices whose dimensions do not match. For example, multiplying $L1 * L2$, where $L1 = \{1, 2, 3, 4, 5\}$ and $L2 = \{1, 2\}$ produces an **ERR:DIM MISMATCH** error because the number of elements in $L1$ and $L2$ do not match.

ERR:INVALID DIM Error

The **ERR:INVALID DIM** error message may occur if you are trying to graph a function that does not involve the stat plot features. The error can be corrected by turning off the stat plots. To turn the stat plots off, press **2nd** [STAT PLOT] and then select **4:PlotsOff**.

Contrast Feature

If the contrast setting is too dark (set to 9) or too dim (set to 0) the unit may appear as if it is malfunctioning or turned off. To adjust the contrast, press *and* release **2nd**, and then press and hold **▲** or **▼**.

TI-84 Plus Identification Code

Your graphing calculator has a unique identification (ID) code that you should record and keep. You can use this 14 digit ID to register your calculator at education.ti.com or identify your calculator in the event that it is lost or stolen. A valid ID includes numbers 0 through 9 and the letters A through F.

You can view the calculator's Operating System, Product Number, ID, and Certificate Revision Number from the **About** screen. To display the **About** screen, press $\boxed{2nd}$ [MEM] and then select **1>About**.

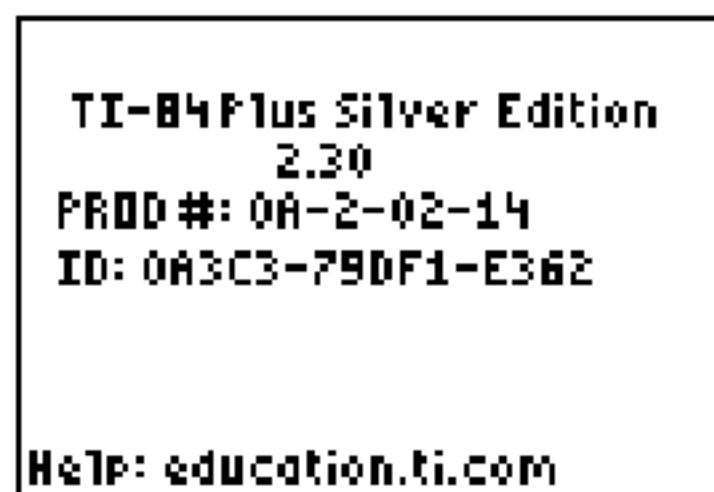

Your unique product ID code: _____

Backups

Your TI-84 Plus is similar to a computer, in that it stores files and Apps that are important to you. It is always a good idea to back up your graphing calculator device files and Apps using the TI Connect™ software and a USB computer cable. You can find the specific procedures for backing up your calculator's device files and Apps in the TI Connect™ Help file.

Apps

TI-84 Plus Software Applications (Apps) is software that you can add to your calculator in the same way you would add software to your computer. Apps let you customize your calculator for peak performance in specific areas of study. You can find apps for the TI-84 Plus at the TI Online Store at education.ti.com.

TI-Cares KnowledgeBase

The TI-Cares KnowledgeBase provides 24-hour access through the Web to find answers to frequently asked questions. The TI-Cares KnowledgeBase searches its repository of known solutions and presents you with the solutions that are most likely to solve your problem. You can search the TI-Cares KnowledgeBase at education.ti.com/support.

Error Conditions

When the TI-84 Plus detects an error, it returns an error message as a menu title, such as **ERR:SYNTAX** or **ERR:DOMAIN**. This table contains each error type, possible causes, and suggestions for correction. The error types listed in this table are each preceded by **ERR:** on your graphing calculator display. For example, you will see **ERR:ARCHIVED** as a menu title when your graphing calculator detects an **ARCHIVED** error type.

Error Type	Possible Causes and Suggested Remedies
ARCHIVED	You have attempted to use, edit, or delete an archived variable. For example, the expression <code>dim(L1)</code> produces an error if L1 is archived.
ARCHIVE FULL	You have attempted to archive a variable and there is not enough space in archive to receive it.
ARGUMENT	<p>A function or instruction does not have the correct number of arguments. See Appendix A for function and instruction syntax.</p> <p>Appendix A displays the arguments and punctuation needed to execute the function or instruction. For example, stdDev(<i>list</i>[<i>freqlist</i>]) is a function of the TI-84 Plus. The arguments are shown in italics. The arguments in brackets are optional and you need not type them. You must also be sure to separate multiple arguments with a comma (,). For example, stdDev(<i>list</i>[<i>freqlist</i>]) might be entered as <code>stdDev(L1)</code> or <code>stdDev(L1,L2)</code> since the frequency list or <i>freqlist</i> is optional.</p>
BAD ADDRESS	You have attempted to send or receive an application and an error (e.g. electrical interference) has occurred in the transmission.

Error Type	Possible Causes and Suggested Remedies
BAD GUESS	<ul style="list-style-type: none"> • In a CALC operation, you specified a Guess that is not between Left Bound and Right Bound. • For the solve(function or the equation solver, you specified a <i>guess</i> that is not between <i>lower</i> and <i>upper</i>. • Your guess and several points around it are undefined. <p>Examine a graph of the function. If the equation has a solution, change the bounds and/or the initial guess.</p>
BOUND	<ul style="list-style-type: none"> • In a CALC operation or with Select(, you defined Left Bound > Right Bound. • In fMin(, fMax(, solve(, or the equation solver, you entered $lower \geq upper$.
BREAK	<p>You pressed the ON key to break execution of a program, to halt a DRAW instruction, or to stop evaluation of an expression.</p>
DATA TYPE	<p>You entered a value or variable that is the wrong data type.</p> <ul style="list-style-type: none"> • For a function (including implied multiplication) or an instruction, you entered an argument that is an invalid data type, such as a complex number where a real number is required. See Appendix A and the appropriate chapter. • In an editor, you entered a type that is not allowed, such as a matrix entered as an element in the stat list editor. See the appropriate chapter. • You attempted to store an incorrect data type, such as a matrix, to a list.

Error Type	Possible Causes and Suggested Remedies
DIM MISMATCH	Your calculator displays the ERR:DIM MISMATCH error if you are trying to perform an operation that references one or more lists or matrices whose dimensions do not match. For example, multiplying $L1 * L2$, where $L1 = \{1, 2, 3, 4, 5\}$ and $L2 = \{1, 2\}$ produces an ERR:DIM MISMATCH error because the number of elements in $L1$ and $L2$ do not match.
DIVIDE BY 0	<ul style="list-style-type: none"> • You attempted to divide by zero. This error is not returned during graphing. The TI-84 Plus allows for undefined values on a graph. • You attempted a linear regression with a vertical line.
DOMAIN	<ul style="list-style-type: none"> • You specified an argument to a function or instruction outside the valid range. This error is not returned during graphing. The TI-84 Plus allows for undefined values on a graph. See Appendix A. • You attempted a logarithmic or power regression with a -X or an exponential or power regression with a -Y. • You attempted to compute $\Sigma Prn($ or $\Sigma Int($ with $pmt2 < pmt1$.
DUPLICATE	You attempted to create a duplicate group name.
Duplicate Name	A variable you attempted to transmit cannot be transmitted because a variable with that name already exists in the receiving unit.
EXPIRED	You have attempted to run an application with a limited trial period which has expired.

Error Type	Possible Causes and Suggested Remedies
Error in Xmit	<ul style="list-style-type: none"> • The TI-84 Plus was unable to transmit an item. Check to see that the cable is firmly connected to both units and that the receiving unit is in receive mode. • You pressed [ON] to break during transmission. • You attempted to perform a backup from a TI-82 to a TI-84 Plus. • You attempted to transfer data (other than L1 through L6) from a TI-84 Plus to a TI-82. • You attempted to transfer L1 through L6 from a TI-84 Plus to a TI-82 without using 5:Lists to TI82 on the LINK SEND menu.
ID NOT FOUND	<p>This error occurs when the SendID command is executed but the proper graphing calculator ID cannot be found.</p>
ILLEGAL NEST	<ul style="list-style-type: none"> • You attempted to use an invalid function in an argument to a function, such as seq(within <i>expression</i> for seq(.
INCREMENT	<ul style="list-style-type: none"> • The increment in seq(is 0 or has the wrong sign. This error is not returned during graphing. The TI-84 Plus allows for undefined values on a graph. • The increment in a For(loop is 0.

Error Type	Possible Causes and Suggested Remedies
INVALID	<ul style="list-style-type: none"> • You attempted to reference a variable or use a function where it is not valid. For example, Y_n cannot reference Y, X_{min}, ΔX, or $TblStart$. • You attempted to reference a variable or function that was transferred from the TI-82 and is not valid for the TI-84 Plus. For example, you may have transferred U_{n-1} to the TI-84 Plus from the TI-82 and then tried to reference it. • In Seq mode, you attempted to graph a phase plot without defining both equations of the phase plot. • In Seq mode, you attempted to graph a recursive sequence without having input the correct number of initial conditions. • In Seq mode, you attempted to reference terms other than $(n-1)$ or $(n-2)$. • You attempted to designate a graph style that is invalid within the current graph mode. • You attempted to use Select(without having selected (turned on) at least one xyLine or scatter plot.
INVALID DIM	<ul style="list-style-type: none"> • The ERR:INVALID DIM error message may occur if you are trying to graph a function that does not involve the stat plot features. The error can be corrected by turning off the stat plots. To turn the stat plots off, press $\boxed{2nd}$ [STAT PLOT] and then select 4:PlotsOff. • You specified a list dimension as something other than an integer between 1 and 999. • You specified a matrix dimension as something other than an integer between 1 and 99. • You attempted to invert a matrix that is not square.

Error Type	Possible Causes and Suggested Remedies
ITERATIONS	<ul style="list-style-type: none"> The solve() function or the equation solver has exceeded the maximum number of permitted iterations. Examine a graph of the function. If the equation has a solution, change the bounds, or the initial guess, or both. irr() has exceeded the maximum number of permitted iterations. When computing I%, the maximum number of iterations was exceeded.
LABEL	The label in the Goto instruction is not defined with a Lbl instruction in the program.
MEMORY	<p>Memory is insufficient to perform the instruction or function. You must delete items from memory before executing the instruction or function.</p> <p>Recursive problems return this error; for example, graphing the equation Y1=Y1.</p> <p>Branching out of an If/Then, For(), While, or Repeat loop with a Goto also can return this error because the End statement that terminates the loop is never reached.</p>
MemoryFull	<ul style="list-style-type: none"> You are unable to transmit an item because the receiving unit's available memory is insufficient. You may skip the item or exit receive mode. During a memory backup, the receiving unit's available memory is insufficient to receive all items in the sending unit's memory. A message indicates the number of bytes the sending unit must delete to do the memory backup. Delete items and try again.

Error Type	Possible Causes and Suggested Remedies
MODE	You attempted to store to a window variable in another graphing mode or to perform an instruction while in the wrong mode; for example, DrawInv in a graphing mode other than Func .
NO SIGN CHNG	<ul style="list-style-type: none"> • The solve(function or the equation solver did not detect a sign change. • You attempted to compute I% when FV, (N*PMT), and PV are all ≥ 0, or when FV, (N*PMT), and PV are all ≤ 0. • You attempted to compute irr(when neither <i>CFList</i> nor <i>CFO</i> is > 0, or when neither <i>CFList</i> nor <i>CFO</i> is < 0.
NONREAL ANS	In Real mode, the result of a calculation yielded a complex result. This error is not returned during graphing. The TI-84 Plus allows for undefined values on a graph.
OVERFLOW	You attempted to enter, or you have calculated, a number that is beyond the range of the graphing calculator. This error is not returned during graphing. The TI-84 Plus allows for undefined values on a graph.
RESERVED	You attempted to use a system variable inappropriately. See Appendix A.

Error Type	Possible Causes and Suggested Remedies
SINGULAR MAT	<ul style="list-style-type: none"> A singular matrix (determinant = 0) is not valid as the argument for -1. The SinReg instruction or a polynomial regression generated a singular matrix (determinant = 0) because it could not find a solution, or a solution does not exist. <p>This error is not returned during graphing. The TI-84 Plus allows for undefined values on a graph.</p>
SINGULARITY	<p><i>expression</i> in the solve(function or the equation solver contains a singularity (a point at which the function is not defined). Examine a graph of the function. If the equation has a solution, change the bounds or the initial guess or both.</p>
STAT	<p>You attempted a stat calculation with lists that are not appropriate.</p> <ul style="list-style-type: none"> Statistical analyses must have at least two data points. Med-Med must have at least three points in each partition. When you use a frequency list, its elements must be ≥ 0. $(\mathbf{Xmax} - \mathbf{Xmin}) / \mathbf{Xscl}$ must be ≤ 47 for a histogram.
STAT PLOT	<p>You attempted to display a graph when a stat plot that uses an undefined list is turned on.</p>

Error Type	Possible Causes and Suggested Remedies
SYNTAX	<p>The command contains a syntax error. Look for misplaced functions, arguments, parentheses, or commas. Appendix A displays the arguments and punctuation needed to execute the function or instruction.</p> <p>For example, stdDev(<i>list</i>[,<i>freqlist</i>]) is a function of the TI-84 Plus. The arguments are shown in italics. The arguments in brackets are optional and you need not type them. You must also be sure to separate multiple arguments with a comma (,). For example stdDev(<i>list</i>[,<i>freqlist</i>]) might be entered as stdDev(L1) or stdDev(L1,L2) since the frequency list or <i>freqlist</i> is optional.</p>
TOL NOT MET	<p>You requested a tolerance to which the algorithm cannot return an accurate result.</p>
UNDEFINED	<p>You referenced a variable that is not currently defined. For example, you referenced a stat variable when there is no current calculation because a list has been edited, or you referenced a variable when the variable is not valid for the current calculation, such as a after Med-Med.</p>
VALIDATION	<p>Electrical interference caused a link to fail or this graphing calculator is not authorized to run the application.</p>

Error Type	Possible Causes and Suggested Remedies
VARIABLE	<p>You have tried to archive a variable that cannot be archived or you have tried to unarchive an application or group.</p> <p>Examples of variables that cannot be archived include:</p> <ul style="list-style-type: none"> • Real numbers LRESID, R, T, X, Y, Theta, Statistic variables under Vars, STATISTICS menu, Yvars, and the AppldList.
VERSION	<p>You have attempted to receive an incompatible variable version from another graphing calculator.</p>
WINDOW RANGE	<p>A problem exists with the window variables.</p> <ul style="list-style-type: none"> • You defined Xmax ≤ Xmin or Ymax ≤ Ymin. • You defined θmax ≤ θmin and θstep > 0 (or vice versa). • You attempted to define Tstep=0. • You defined Tmax ≤ Tmin and Tstep > 0 (or vice versa). • Window variables are too small or too large to graph correctly. You may have attempted to zoom in or zoom out to a point that exceeds the TI-84 Plus's numerical range.
ZOOM	<ul style="list-style-type: none"> • A point or a line, instead of a box, is defined in ZBox. • A ZOOM operation returned a math error.

Accuracy Information

Computational Accuracy

To maximize accuracy, the TI-84 Plus carries more digits internally than it displays. Values are stored in memory using up to 14 digits with a two-digit exponent.

- You can store a value in the window variables using up to 10 digits (12 for **Xscl**, **Yscl**, **Tstep**, and **θstep**).
- Displayed values are rounded as specified by the mode setting with a maximum of 10 digits and a two-digit exponent.
- **RegEQ** displays up to 14 digits in **Float** mode. Using a fixed-decimal setting other than **Float** causes **RegEQ** results to be rounded and stored with the specified number of decimal places.

Xmin is the center of the leftmost pixel, **Xmax** is the center of the next-to-the-rightmost pixel. (The rightmost pixel is reserved for the busy indicator.) ΔX is the distance between the centers of two adjacent pixels.

- In **Full** screen mode, ΔX is calculated as $(X_{max} - X_{min}) / 94$. In **G-T** split-screen mode, ΔX is calculated as $(X_{max} - X_{min}) / 46$.
- If you enter a value for ΔX from the home screen or a program in **Full** screen mode, **Xmax** is calculated as $X_{min} + \Delta X * 94$. In **G-T** split-screen mode, **Xmax** is calculated as $X_{min} + \Delta X * 46$.

Ymin is the center of the next-to-the-bottom pixel; **Ymax** is the center of the top pixel. ΔY is the distance between the centers of two adjacent pixels.

- In **Full** screen mode, ΔY is calculated as $(Y_{\max} - Y_{\min}) / 62$. In **Horiz** split-screen mode, ΔY is calculated as $(Y_{\max} - Y_{\min}) / 30$. In **G-T** split-screen mode, ΔY is calculated as $(Y_{\max} - Y_{\min}) / 50$.
- If you enter a value for ΔY from the home screen or a program in **Full** screen mode, Y_{\max} is calculated as $Y_{\min} + \Delta Y * 62$. In **Horiz** split-screen mode, Y_{\max} is calculated as $Y_{\min} + \Delta Y * 30$. In **G-T** split-screen mode, Y_{\max} is calculated as $Y_{\min} + \Delta Y * 50$.

Cursor coordinates are displayed as eight-character numbers (which may include a negative sign, decimal point, and exponent) when **Float** mode is selected. **X** and **Y** are updated with a maximum accuracy of eight digits.

minimum and **maximum** on the **CALCULATE** menu are calculated with a tolerance of $1E-5$; $\int f(x)dx$ is calculated at $1E-3$. Therefore, the result displayed may not be accurate to all eight displayed digits. For most functions, at least five accurate digits exist. For **fMin()**, **fMax()**, and **fnInt()** on the **MATH** menu and **solve()** in the **CATALOG**, the tolerance can be specified.

Function Limits

Function	Range of Input Values
sin x , cos x , tan x	$0 \leq x < 10^{12}$ (radian or degree)
sin ⁻¹ x , cos ⁻¹ x	$-1 \leq x \leq 1$
ln x , log x	$10^{-100} < x < 10^{100}$
e x	$-10^{100} < x \leq 230.25850929940$
10 x	$-10^{100} < x < 100$

Function	Range of Input Values
$\sinh x, \cosh x$	$ x \leq 230.25850929940$
$\tanh x$	$ x < 10^{100}$
$\sinh^{-1} x$	$ x < 5 \times 10^{99}$
$\cosh^{-1} x$	$1 \leq x < 5 \times 10^{99}$
$\tanh^{-1} x$	$-1 < x < 1$
\sqrt{x} (real mode)	$0 \leq x < 10^{100}$
\sqrt{x} (complex mode)	$ x < 10^{100}$
$x!$	$-.5 \leq x \leq 69$, where x is a multiple of .5

Function Results

Function	Range of Result
$\sin^{-1} x, \tan^{-1} x$	-90° to 90° or $-\pi / 2$ to $\pi / 2$ (radians)
$\cos^{-1} x$	0° to 180° or 0 to π (radians)

Appendix C: Service and Warranty Information

Texas Instruments Support and Service

For general information

Home Page:	education.ti.com
KnowledgeBase and e-mail inquiries:	education.ti.com/support
Phone:	(800) TI-CARES / (800) 842-2737 For U.S., Canada, Mexico, Puerto Rico, and Virgin Islands only
International information:	education.ti.com/international

For technical support

KnowledgeBase and support by e-mail:	education.ti.com/support
Phone (not toll-free):	(972) 917-8324

For product (hardware) service

Customers in the U.S., Canada, Mexico, Puerto Rico and Virgin Islands: Always contact Texas Instruments Customer Support before returning a product for service.

All other customers: Refer to the leaflet enclosed with this product (hardware) or contact your local Texas Instruments retailer/distributor.

Texas Instruments (TI) Warranty Information

Customers in the U.S. and Canada Only

One-Year Limited Warranty for Commercial Electronic Product

This Texas Instruments ("TI") electronic product warranty extends only to the original purchaser and user of the product.

Warranty Duration. This TI electronic product is warranted to the original purchaser for a period of one (1) year from the original purchase date.

Warranty Coverage. This TI electronic product is warranted against defective materials and construction. **THIS WARRANTY IS VOID IF THE PRODUCT HAS BEEN DAMAGED BY ACCIDENT OR UNREASONABLE USE, NEGLIGENCE, IMPROPER SERVICE, OR OTHER CAUSES NOT ARISING OUT OF DEFECTS IN MATERIALS OR CONSTRUCTION.**

Warranty Disclaimers. ANY IMPLIED WARRANTIES ARISING OUT OF THIS SALE, INCLUDING BUT NOT LIMITED TO THE IMPLIED WARRANTIES OF MERCHANTABILITY AND FITNESS FOR A PARTICULAR PURPOSE, ARE LIMITED IN DURATION TO THE ABOVE ONE-YEAR PERIOD. TEXAS INSTRUMENTS SHALL NOT BE LIABLE FOR LOSS OF USE OF THE PRODUCT OR OTHER INCIDENTAL OR CONSEQUENTIAL COSTS, EXPENSES, OR DAMAGES INCURRED BY THE CONSUMER OR ANY OTHER USER.

Some states/provinces do not allow the exclusion or limitation of implied warranties or consequential damages, so the above limitations or exclusions may not apply to you.

Legal Remedies. This warranty gives you specific legal rights, and you may also have other rights that vary from state to state or province to province.

Warranty Performance. During the above one (1) year warranty period, your defective product will be either repaired or replaced with a reconditioned model of an equivalent quality (at TI's option) when the product is returned, postage prepaid, to Texas Instruments Service Facility. The warranty of the repaired or replacement unit will continue for the warranty of the original unit or six (6) months, whichever is longer. Other than the postage requirement, no charge will be made for such repair and/or replacement. TI strongly recommends that you insure the product for value prior to mailing.

Software. Software is licensed, not sold. TI and its licensors do not warrant that the software will be free from errors or meet your specific requirements. **All software is provided "AS IS."**

Copyright. The software and any documentation supplied with this product are protected by copyright.

One-Year Limited Warranty for Commercial Electronic Product

This Texas Instruments electronic product warranty extends only to the original purchaser and user of the product.

Warranty Duration. This Texas Instruments electronic product is warranted to the original purchaser for a period of one (1) year from the original purchase date.

Warranty Coverage. This Texas Instruments electronic product is warranted against defective materials and construction. This warranty is void if the product has been damaged by accident or unreasonable use, neglect, improper service, or other causes not arising out of defects in materials or construction.

Warranty Disclaimers. Any implied warranties arising out of this sale, including but not limited to the implied warranties of merchantability and fitness for a particular purpose, are limited in duration to the above one-year period. Texas Instruments shall not be liable for loss of use of the product or other incidental or consequential costs, expenses, or damages incurred by the consumer or any other user.

Except as expressly provided in the One-Year Limited Warranty for this product, Texas Instruments does not promise that facilities for the repair of this product or parts for the repair of this product will be available.

Some jurisdictions do not allow the exclusion or limitation of implied warranties or consequential damages, so the above limitations or exclusions may not apply to you.

Legal Remedies. This warranty gives you specific legal rights, and you may also have other rights that vary from jurisdiction to jurisdiction.

Warranty Performance. During the above one (1) year warranty period, your defective product will be either repaired or replaced with a new or reconditioned model of an equivalent quality (at TI's option) when the product is returned to the original point of purchase. The repaired or replacement unit will continue for the warranty of the original unit or six (6) months, whichever is longer. Other than your cost to return the product, no charge will be made for such repair and/or replacement. TI strongly recommends that you insure the product for value if you mail it.

Software. Software is licensed, not sold. TI and its licensors do not warrant that the software will be free from errors or meet your specific requirements. **All software is provided "AS IS."**

Copyright. The software and any documentation supplied with this product are protected by copyright.

All Other Customers

For information about the length and terms of the warranty, refer to your package and/or to the warranty statement enclosed with this product, or contact your local Texas Instruments retailer/distributor.

Battery Information

When to Replace the Batteries

The TI-84 Plus uses five batteries: four AAA alkaline batteries and one SR44SW or 303 silver oxide backup battery. The silver oxide battery provides auxiliary power to retain memory while you replace the AAA batteries.

When the battery voltage level drops below a usable level, the TI-84 Plus:

Displays this message when you turn on the unit.

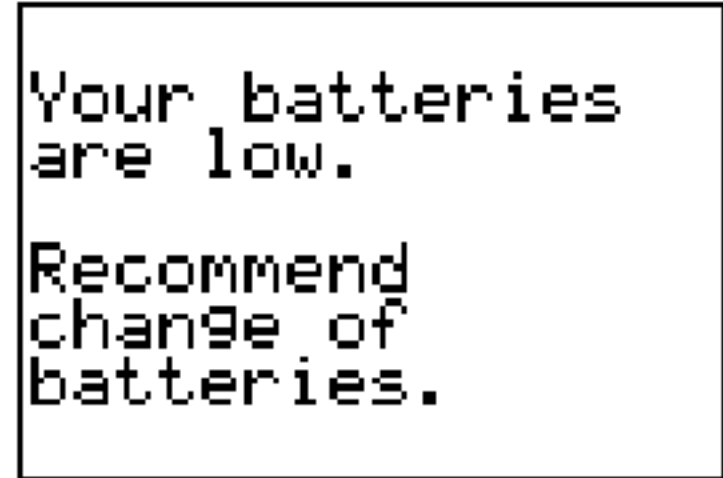

```
Your batteries  
are low.  
  
Recommend  
change of  
batteries.
```

Message A

Displays this message when you attempt to download an application.

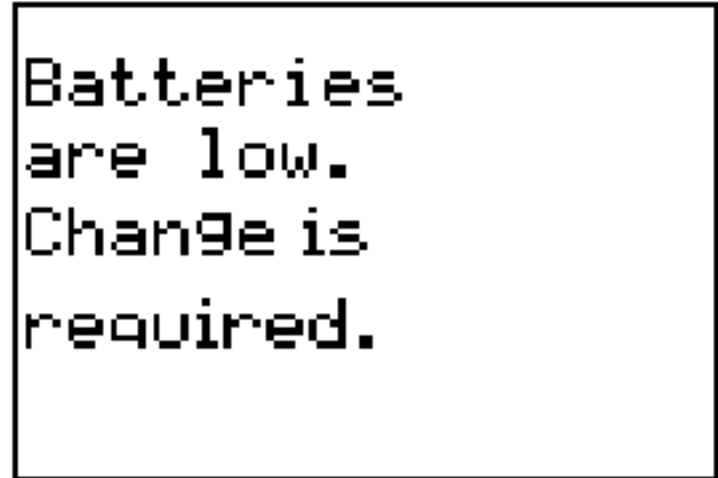

```
Batteries  
are low.  
Change is  
required.
```

Message B

After **Message A** is first displayed, you can expect the batteries to function for about one or two weeks, depending on usage. (This one-week to two-week period is based on tests with alkaline batteries; the performance of other types of batteries may vary.)

If **Message B** is displayed, you must replace the batteries immediately to successfully download an application.

Replace the silver oxide battery every three or four years.

Effects of Replacing the Batteries

Do not remove both types of batteries (AAA and silver oxide) at the same time. **Do not** allow the batteries to lose power completely. If you follow these guidelines and the steps for replacing batteries, you can replace either type of battery without losing any information in memory.

Battery Precautions

Take these precautions when replacing batteries.

- Do not leave batteries within reach of children
- Do not mix new and used batteries. Do not mix brands (or types within brands) of batteries.
- Do not mix rechargeable and nonrechargeable batteries.
- Install batteries according to polarity (+ and -) diagrams.
- Do not place nonrechargeable batteries in a battery recharger.
- Properly dispose of used batteries immediately. Do not leave them within the reach of children.
- Do not incinerate or dismantle batteries.

Replacing the Batteries

To replace the batteries, follow these steps.

1. Turn off the graphing calculator. Replace the slide cover over the keyboard to avoid inadvertently turning on the graphing calculator. Turn the back of the unit toward you.
2. Hold the graphing calculator upright, push downward on the latch on the top of the battery cover, and then pull the cover toward you.

Note: To avoid loss of information stored in memory, you must turn off the graphing calculator. Do not remove the AAA batteries and the silver oxide battery simultaneously.

3. Replace all four AAA alkaline batteries simultaneously. Or, replace the silver oxide battery.
 - To replace the AAA alkaline batteries, remove all four discharged AAA batteries and install new ones according to the polarity (+ and -) diagram in the battery compartment.

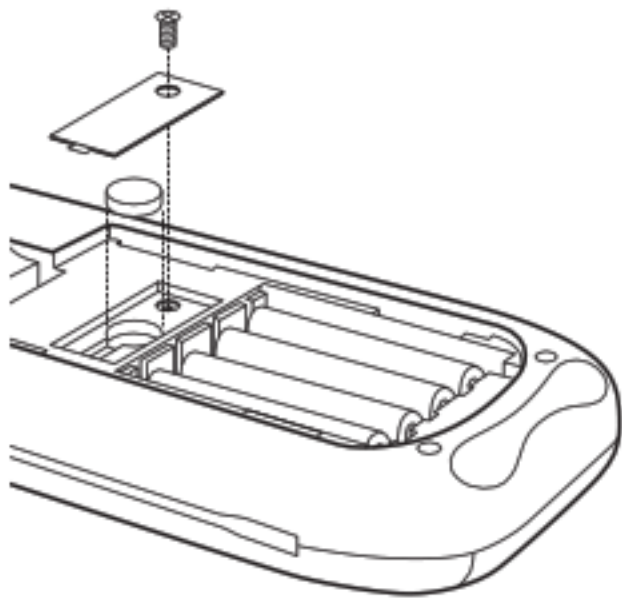

- To replace the silver oxide battery, remove the screw from the silver oxide battery cover, and then remove the cover. Install the new battery, + side up. Replace the cover and secure it with the screw. Use a SR44SW or 303 (or equivalent) silver oxide battery.
4. Replace the battery compartment cover. Turn the graphing calculator on and adjust the display contrast, if necessary, by pressing **[2nd]** **[▲]** or **[▼]**.

In Case of Difficulty

Handling a Difficulty

To handle a difficulty, follow these steps.

1. If you cannot see anything on the screen, you may need to adjust the graphing calculator contrast.

To darken the screen, press *and* release $\boxed{2nd}$, and then press and hold $\boxed{\blacktriangle}$ until the display is sufficiently dark.

To lighten the screen, press *and* release $\boxed{2nd}$, and then press and hold $\boxed{\blacktriangledown}$ until the display is sufficiently light.

2. If an error menu is displayed, follow these steps:

- Note the error type (**ERR:***error type*).
- Select **2:GOTO**, if it is available. The previous screen is displayed with the cursor at or near the error location.
- Determine the error.
- Correct the expression.

Refer to the Error Conditions table for details about specific errors, if necessary.

3. If the busy indicator (dotted line) is displayed, a graph or program has been paused; the TI-84 Plus is waiting for input. Press \boxed{ENTER} to continue or press \boxed{ON} to break.

4. If a checkerboard cursor (\blacksquare) is displayed, then either you have entered the maximum number of characters in a prompt, or memory is full. If memory is full:

- Press $\boxed{2nd}$ $\boxed{[MEM]}$ **2** to display the **MEMORY MANAGEMENT / DELETE** menu.





- Select the type of data you want to delete, or select **1:All** for a list of all variables of all types. A screen is displayed listing each variable of the type you selected and the number of bytes each variable is using.
 - Press \uparrow and \downarrow to move the selection cursor (\blacktriangleright) next to the item you want to delete, and then press $\boxed{\text{DEL}}$.
5. If the graphing calculator does not seem to work at all, be sure the alkaline batteries are fresh and that they are installed properly.
 6. If the TI-84 Plus does not function even though you are sure that the batteries are fresh, you can try manually resetting it.
 - Remove all of the AAA batteries from the graphing calculator.
 - Press and hold the $\boxed{\text{ON}}$ key for ten seconds.
 - Replace the batteries.
 - Turn on the unit.

When you reset your graphing calculator, the contrast sometimes changes. If the screen is faded or blank, adjust the contrast by pressing $\boxed{2\text{nd}}$ and releasing \uparrow or \downarrow .

7. If the above solutions do not work you can reset all of the memory. The RAM, user data archive memory, and system variables are restored to factory settings when you reset all memory. All nonsystem variables, applications (Apps), and programs are deleted.
 - Press $\boxed{2\text{nd}}$ $\boxed{\text{MEM}}$ to display the **MEMORY** menu.
 - Select **7:Reset** to display the **RAM ARCHIVE ALL** menu.
 - Press $\boxed{\blacktriangleright}$ $\boxed{\blacktriangleright}$ to display the **ALL** menu.
 - Select **1:All Memory** to display the **RESET MEMORY** menu.
 - To continue with the reset, select **2:Reset**. The message **Mem cleared** is displayed on the home screen.

Index

Symbols

→dim((assign dimension)	261	:	(colon)	430
° (degrees notation)	620	<	(less than)	88, 622
- (negation)	42, 55, 624	=	(equal-to relational test)	88, 622
– (subtraction)	53, 626	>	(greater than)	88, 622
! (factorial)	620	[]	(matrix indicator)	228
→ Store	27, 611	^	(power)	54, 624
→dim((assign dimension)	238, 574	≤	(less than or equal to)	623
≠ (not equal to)	622	≥	(greater than or equal to)	88, 623
√((square root)	54, 624	²	(square)	54, 623
□, •, + (pixel mark)	203, 322	³	(cube)	58, 621
 (plot type, histogram)	320	³ √((cube root)	58, 621	
' (minutes notation)	84, 626	“ ”	(string indicator)	413
() (parentheses)	41	►Dec	(to decimal conversion)	57, 573
 (plot type, normal probability)	322	►DMS	(to degrees/minutes/seconds)	86, 575
∑Int((sum of interest)	585	►Eff((to effective interest rate)	402, 403
∑Prn((sum of principal)	597	►Frac	(to fraction)	57, 579
* (multiplication)	53, 624	►Nom((to nominal interest rate)	402, 592
 (plot type, modified box)	320	►Polar	(to polar)	79, 596
∫f(x)dx operation on a graph	131	►Rect	(to rectangular)	78, 601
*row(.	244, 602	χ ² pdf((chi-square pdf)	377
*row+(.	602	χ ² -Test	(chi-square test)	358, 360, 378
+ (addition)	53, 625	ΔTbl	(table step variable)	177
+ (concatenation)	417, 626	ΔX	window variable	107
+ (pixel mark)	203, 322	ΔY	window variable	107
 (plot type, box)	321	Fcdf(.	378
/ (division)	53, 625	Fpdf(.	378
⁻¹ (inverse)	233, 623	⁻¹	(inverse)	54

{ } (list indicator) 249

Numerics

10^((power of ten) 624

1-PropZInt (one-proportion z confidence interval) 357, 597

1-PropZTest (one-proportion z test) .349, 597

1-Var Stats (one-variable statistics) .307, 616

2-PropZInt (two-proportion z confidence interval) 357, 597

2-PropZTest (two-proportion z test) .350, 598

2-SampFTest (two-sample F -Test) . .361, 603

2-SampTInt (two-sample t confidence interval) 355, 604

2-SampTTest (two-sample t test) . . .347, 605

2-SampZInt (two-sample z confidence interval) 354, 605

2-SampZTest (two-sample z test) . . .345, 604, 605

2-Var Stats (two-variable statistics) .308, 616

A

a+bi (rectangular complex mode) .24, 72, 568

about 514

above graph style 101

abs((absolute value) . . .68, 78, 233, 566

accuracy information

 computational and graphing 656

 function limits and results 657

 graphing 114

addition (+) 53, 625

alpha cursor 9

alpha-lock 19

alternative hypothesis 338

amortization

Σ Int((sum of interest) 585

Σ Prn((sum of principal) 597

 bal((amortization balance) .399, 568

 calculating schedules 399

 formula 638

and (Boolean operator) 90, 567

ANGLE menu 84

angle modes 22

angle(. 77, 567

animate graph style 101

ANOVA((one-way variance analysis) . . .

 366, 567, 630

Ans (last answer) 32, 519, 567

APD (Automatic Power Down) 4

applications *See* examples, applications .

 52

Apps 26, 517

AppVars 26, 517

arccosine ($\cos^{-1}()$) 53

Archive 28, 523, 567

archive full error	546, 646
garbage collection	542
memory error	542
archived variables	628
arcsine ($\sin^{-1}()$)	53
arctangent ($\tan^{-1}()$)	53
Asm()	458, 567
AsmComp()	458, 567
AsmPrgm()	458, 567
assembly language programs	458
augment()	240, 267, 568
Automatic Power Down (APD)	4
automatic regression equation	303
automatic residual list (RESID)	302
axes format, sequence graphing	161
axes, displaying (AxesOn, AxesOff)	110, 568
AxesOff	110, 568
AxesOn	110, 568

B

backing up calculator memory	556, 562
bal((amortization balance)	399, 568
batteries	5, 664
below graph style	101
binomcdf()	380, 568
binompdf()	379, 569
block	542
Boolean logic	90
box pixel mark (\square)	203, 322
Boxplot plot type (\square)	321

busy indicator	9
----------------	---

C

C/Y (compounding-periods-per-year variable)	391, 406
χ^2 cdf((chi-square cdf)	569
χ^2 pdf((chi-square pdf)	569
χ^2 -Test (chi-square test)	569
CALCULATE menu	126
Calculate output option	336, 339
cash flow	
calculating	397
formula	639
irr((internal rate of return)	398, 586
npv((net present value)	398, 593
CATALOG	411
CBL 2™	455, 551, 580
CBR™	455, 551, 580
check memory	514
checkTmr((check timer)	570
Chi	360
chi-square cdf (χ^2 cdf()	378, 569
chi-square goodness of fit test	360
chi-square pdf (χ^2 pdf()	377, 569
chi-square test (χ^2 -Test)	358, 360, 569
Circle((draw circle)	197, 570
Clear Entries	514, 570
clearing	
all lists (ClrAllLists)	514, 570
drawing (ClrDraw)	188, 570
entries (Clear Entries)	514, 570

home screen (ClrHome) . . .	454, 570	►Dec (to decimal)	57, 573
list (ClrList)	300, 571	►DMS (to degrees/minutes/ seconds)	
table (ClrTable)	454, 571	86,	575
Clock	11	►Eff (to effective interest rate) . . .	402
Clock Off	14	►Frac (to fraction conversion) 57, 579	
Clock On	13	►Nom (to nominal interest rate	
ClockOff, turn clock off	570	conversion)	402, 592
ClockOn, turn clock on	570	►Polar (to polar conversion) .79, 596	
ClrAllLists (clear all lists)	514, 570	►Rect (to rectangular conversion) 78,	
ClrDraw (clear drawing)	188, 570	601	
ClrHome (clear home screen) . 454, 570		Equ►String((equation-to-string	
ClrList (clear list)	300, 571	conversion)	418, 576
ClrTable (clear table)	454, 571	List►matr((list-to-matrix conversion) .	
coefficients of determination (r ² , R ²)	304	241,	267, 588
colon separator (:)	430	Matr►list((matrix-to-list conversion) .	
combinations (nCr)	80, 591	240,	267, 589
compiling an assembly program	458, 567	P►Rx(, P►Ry((polar-to-rectangular	
complex		conversion)	86, 599
modes (a+bi, re ^θ i) . 24, 72, 568, 601		R►Pr(, R►Pθ((rectangular-to-polar	
numbers	24, 72, 601	conversion)	603
compounding-periods-per-year variable		R►Pr(, R►Pθ((rectangular-to-polar	
(C/Y)	391, 406	conversion)	86
concatenation (+)	417, 626	String►Equ((string-to-equation	
confidence intervals	52, 339	conversion)	420, 611
conj((conjugate)	76, 571	convert time, timeCnv()	613
Connected (plotting mode)	23, 571	CoordOff	109, 571
connecting two calculators	550, 551, 558	CoordOn	109, 571
contact information	659	correlation coefficient (r)	304
contrast (display)	6	cos((cosine)	53, 571
convergence, sequence graphing . .	167	cos ⁻¹ ((arccosine)	53, 571
conversions		cosh((hyperbolic cosine)	423, 571

\cosh^{-1} ((hyperbolic arccosine) .. 423, 572
 cosine (cos() 53
 cosine (cos() 571
 cross pixel mark (+) 203, 322
 cube (³) 58, 621
 cube root ($\sqrt[3]{}$ () 58
 cube root ($\sqrt[3]{}$ () 621
 cubic regression (CubicReg) .. 309, 572
 CubicReg (cubic regression) .. 309, 572
 cumSum((cumulative sum) 242, 263, 572
 cumulative sum (cumSum() ... 242, 263
 cumulative sum (cumSum() 572
 cursors 9, 19
 customer support and service 659

D

Data input option 336, 337
 dayOfWk((day of week) 572
 days between dates (dbd() 403
 days between dates (dbd() ... 573, 640
 dbd((days between dates) 403, 573, 640
 decimal mode (float or fixed) 22
 decrement and skip (DS<() 444
 decrement and skip (DS<() 575
 definite integral 60, 130, 143
 defragmenting 541
 Degree angle mode 22, 84, 573
 degrees notation (°) 85, 620
 delete variable contents (DelVar) ... 446,
 573
 deleting items from memory 519

DependAsk 177, 180, 573
 DependAuto 177, 180, 573
 derivative *See* numerical derivative ... 52
 det((determinant) 237, 573
 determinant (det() 237
 determinant (det() 573
 DiagnosticOff 304, 573
 DiagnosticOn 304, 574
 diagnostics display mode(r, r2, R2) .. 304
 differentiation 61, 130, 143, 151
 dim((dimension) 238, 260, 574
 dimensioning a list or matrix .. 238, 260,
 574
 Disp (display) 450, 574
 DispGraph (display graph) 451, 574
 display contrast 6
 display cursors 9
 Displaying the Clock Settings 12
 DispTable (display table) 451, 575
 DISTR (distributions menu) 372
 DISTR DRAW (distributions drawing
 menu) 382
 distribution functions
 binomcdf(..... 380, 568
 binompdf(..... 379, 569
 χ^2 cdf(..... 569
 χ^2 pdf(..... 569
 Fcdf(..... 376, 612
 Fpdf(..... 376, 614
 geometcdf(..... 382, 580
 geometpdf(..... 381, 580

invNorm(.	375, 585	text (Text)	198
normalcdf(.	374, 592	using Pen	200
normalpdf(.	373, 593	DrawInv (draw inverse)	194, 575
poissoncdf(.	381, 596	DS<((decrement and skip)	444, 575
poissonpdf(.	381, 596	DuplicateName menu	560
distribution shading instructions		dx/dt operation on a graph	130, 143
Shade_t(.	384, 609	dy/dx operation on a graph	130, 143, 151
Shade χ^2 (.	385, 608		
ShadeF(.	385, 608	E	
ShadeNorm(.	383, 609	ε (exponent)	16, 21, 575
division (/)	53, 625	e^((exponential)	55, 575
ΔList(.	263, 588	edit keys table	18
DMS (degrees/minutes/seconds entry notation)	84, 626	Else	438
Dot (plotting mode)	23, 575	End	439, 576
dot graph style	101	Eng (engineering notation mode)	21, 576
dot pixel mark (•)	203, 322	ENTRY (last entry key)	29
dr/dθ operation on a graph	151	entry cursor	9
DRAW menu	186	EOS (Equation Operating System)	40
Draw output option	336, 339	eqn (equation variable)	61
DRAW POINTS menu	201	Equ►String((equation-to-string conversion)	418, 576
DRAW STO (draw store menu)	205	equal-to relational test (=)	88, 622
DrawF (draw a function)	194, 575	Equation Operating System (EOS)	40
drawing on a graph		Equation Solver	61
circles (Circle()	197	equations with multiple roots	66
functions and inverses (DrawF, DrawInv)	194	errors	
line segments (Line()	189	diagnosing and correcting	49
lines (Horizontal, Line(, Vertical)	191	messages	646
points (Pt-Change, Pt-Off, Pt-On)	201	examples—applications	
tangents (Tangent)	192	area between curves	496

areas of regular n-sided polygons . . .	506	mean height of a population	330
box plots	477	path of a ball	133
box with lid	466	pendulum lengths and periods . .	273
defining a	466	polar rose	144
defining a table of values	467	roots of a function	175
setting the viewing window	470	sending variables	547
tracing the graph	472	solving a system of linear equations .	221
zooming in on the graph	474	unit circle	211
zooming in on the table	468	volume of a cylinder	425
cobweb attractors	489	examples—miscellaneous	
fundamental theorem of calculus	502	calculating outstanding loan balances	
guess the coefficients	491	400
inequalities	483	convergence	167
mortgage payments	510	daylight hours in Alaska	312
parametric equations, ferris wheel		predator-prey model	169
problem	498	examples—Getting Started	
piecewise functions	481	graphing a circle	92
quadratic formula		exponential regression (ExpReg) . .	310,
converting to a fraction	461	576	
displaying complex results	463	expr((string-to-expression conversion) . .	
entering a calculation	460	419,	576
Sierpinski triangle	487	ExpReg (exponential regression) . .	310,
solving a system of nonlinear		576	
equations	485	expression	15
unit circle and trig curves	494	converting from string (expr() . . .	419
examples—Getting Started		converting from string (expr() . . .	576
coin flip	51	turning on and off (ExprOn	110, 577
compound interest	389	ExprOff (expression off)	110, 577
drawing a tangent line	184	ExprOn (expression on)	110, 577
financing a car	388		
forest and trees	152		
generating a sequence	246		

F	
Faceplates	10
factorial (!)	620
family of curves	112
FCC statement	iii
Fill(239, 577
FINANCE CALC menu	393
FINANCE VARS menu	405
financial functions	
amortization schedules	399
cash flows	397
days between dates	403
interest rate conversions	402
payment method	404
time value of money (TVM)	394
Fix (fixed-decimal mode)	22, 577
fixed-decimal mode (Fix)	22, 577
Float (floating-decimal mode)	22, 577
floating-decimal mode (Float)	22, 577
fMax((function maximum)	578
fMin((function minimum)	59, 578
fnInt((function integral)	61, 578
FnOff (function off)	100, 578
FnOn (function on)	100, 578
For(439, 579
format settings	108, 161
formulas	
amortization	638
ANOVA	630
cash flow	639
days between dates	640
interest rate conversions	639
logistic regression	629
sine regression	630
time value of money	635
two-sample F-Test	632
two-sample t test	633
fPart((fractional part)	69, 235, 579
free-moving cursor	113
frequency	307
Full (full-screen mode)	24, 579
full-screen mode (Full)	24, 579
Func (function graphing mode)	23, 579
function graphing	
accuracy	114
CALC (calculate menu)	126
defining and displaying	94
defining in the Y= editor	96
defining on the home screen, in a program	98
deselecting	99
displaying	94, 105, 111
ΔX and ΔY window variables	107
evaluating	98
family of curves	112
format settings	108
free-moving cursor	113
graph styles	101
maximum of (fMax()	59
maximum of (fMax()	578
minimum of (fMin()	578
modes	23, 95, 579

moving the cursor to a value . . .	116	GetCalc((get data from TI-84 Plus)	454, 581
overlaying functions on a graph .	112	getDate, get current date	581
panning	117	getDtFmt, get date format	581
pausing or stopping a graph	111	getDtStr((get date string)	582
Quick Zoom	117	getKey	453, 582
selecting	99, 100, 578	getTime, get current time	582
shading	103	Getting Started <i>See</i> examples, Getting	
Smart Graph	111	Started	52
tracing	115	getTmFmt, get time format	582
viewing window	105	getTmStr((get time string)	582
window variables	105, 106	Goto	442, 583
Y= editor	96	graph database (GDB)	207
ZOOM MEMORY menu	123	graph style	
ZOOM menu	118	above	101
function integral (fnInt()	61	animate	101
function integral (fnInt()	578	below	101
function, definition of	17	dot	101
functions and instructions table	566	line	101
future value	391, 396	path	101
FV (future-value variable)	391, 406	shade above	101
		shade below	101
		thick	101
G		graph styles	101
garbage collecting	541	graphing modes	23
GarbageCollect	543, 580	graphing-order modes	23
gcd((greatest common divisor) .	71, 580	GraphStyle(.	446, 583
GDB (graph database)	207	graph-table split-screen mode (G-T) .	24, 216,
geometcdf(.	382, 580		583
geometpdf(.	381, 580	greater than (>)	88, 622
Get((get data from CBL 2™ or CBR™) .		greater than or equal to (≥)	88, 623
455,	580		

greatest common divisor (gcd() 71
greatest common divisor (gcd() 580
greatest integer (int() 70, 235
greatest integer (int() 585
GridOff 109, 583
GridOn 109, 583
grouping 535
G-T (graph-table split-screen mode) .24,
216, 583

H

Histogram plot type () 320
home screen 7
Horiz (horizontal split-screen mode) .24,
215, 583
Horizontal (draw line) 191, 583
hyperbolic functions 422
hypothesis tests 342

I

i (complex number constant) 74
I% (annual interest rate variable) . . .391,
406
identity(. 239, 583
If instructions
 If 437, 583
 If-Then 437, 584
 If-Then-Else 438, 584
imag((imaginary part) 77, 584
imaginary part (imag() 77
imaginary part (imag() 584

implied multiplication 41
increment and skip (IS>() 443
increment and skip (IS>() 586
independent variable177, 180, 584
IndpntAsk177, 180, 584
IndpntAuto177, 180, 584
inferential stat editors 335
inferential statistics
 alternative hypotheses 338
 bypassing editors 339
 calculating test results (Calculate) . .
 339
 confidence interval calculations . 339
 data input or stats input 337
 entering argument values 337
 graphing test results (Draw) 339
 input descriptions table 367
 pooled option 338
 STAT TESTS menu 340
 test and interval output variables 370
inferential statistics *See* stat tests 52
Input 448, 449, 584
insert cursor 9
Installing New Faceplates 11
Installing new faceplates 11
inString((in string) 419, 585
instruction, definition of 17
int((greatest integer) 70, 235, 585
integer part (iPart() 69, 235
integer part (iPart() 586
integral *See* numerical integral 52

interest rate conversions
 ▶Eff((compute effective interest rate)
 402, 403
 ▶Nom((compute nominal interest rate)
 402
 calculating 402
 formula 639
 internal rate of return (irr() 398
 internal rate of return (irr() 586
 intersect operation on a graph 129
 inverse (⁻¹) 54, 233, 623
 inverse cumulative normal distribution
 (invNorm() 375
 inverse cumulative normal distribution
 (invNorm() 585
 inverse trig functions 53
 invNorm((inverse cumulative normal
 distribution) 375, 585
 invT (inverse Student T distribution) . 375
 iPart((integer part) 69, 235, 586
 irr((internal rate of return) 398, 586
 IS>((increment and skip) 443, 586
 isClockOn, is clock on 586

K

keyboard
 layout 1
 math operations 52
 key-code diagram 454



L

L (user-created list name symbol) ... 268
 LabelOff 110, 586
 LabelOn 110, 587
 labels
 graph 110, 586
 program 442, 587
 Last Entry 29
 Lbl (label) 442, 587
 lcm((least common multiple) ... 71, 587
 least common multiple (lcm() 71
 least common multiple (lcm() 587
 length(of string 420, 587
 less than (<) 88, 622
 less than or equal to (≤) 88, 623
 line graph style 101
 line segments, drawing 189
 Line((draw line) 190, 587
 lines, drawing 190, 191
 LINK RECEIVE menu 559
 LINK SEND menu 553
 linking
 receiving items 559
 to a CBL 2™ or CBR™ 551
 to a PC or Macintosh 552
 to a TI-84 Plus Silver Edition or TI-84
 Plus 562
 transmitting items 547
 two TI-84 Plus units 556
 LinReg(a+bx) (linear regression) 310, 587
 LinReg(ax+b) (linear regression) 308, 588

LinRegTTest (linear regression t test) . . .
 363, 588
 LinReqTInt (confidence interval for slope)
 365
 LIST MATH menu 269
 LIST NAMES menu 251
 LIST OPS menu 258
 List▶matr((lists-to-matrix conversion) 241,
 267, 588
 lists
 accessing an element 250
 attaching formulas . . . 253, 255, 289
 clearing all elements 287
 copying 250
 creating 248, 286
 deleting from memory 251, 519
 detaching formulas 256, 292
 dimension 249
 entering list names 252, 284
 indicator ({ }) 249
 naming lists 247
 storing and displaying 249
 using in expressions 256
 using to graph a family of curves 112,
 251
 using with math operations . 52, 257
 ln(. 54, 588
 LnReg (logarithmic regression) 310, 589
 log(. 54, 589
 Logistic (regression) 311, 589
 logistic regression formula 629

M

Manual 313
 Manual Linear Fit 306, 313
 marked for deletion 542
 MATH CPX (complex menu) 76
 MATH menu 57
 MATH NUM (number menu) 68
 math operations 52
 MATH PRB (probability menu) 79
 Matr▶list((matrix-to-list conversion) . 240,
 267, 589
 matrices
 accessing elements 230
 copying 230
 defined 222
 deleting from memory 225
 dimensions 223, 238
 displaying a matrix 229
 displaying matrix elements 224
 editing matrix elements 226
 indicator ([]) 228
 inverse ($^{-1}$) 233
 math functions 231
 matrix math functions (det(, T , dim(
 Fill(, identity(, randM(, augment(
 Matr▶list(, List▶matr(, cumSum()
 236
 referencing in expressions 228
 relational operations 234
 row operations (ref(, rref(, rowSwap(
 row+(, *row(, *row+() 242

selecting	223	minimum of a function (fMin()	59
viewing	225	minimum of a function (fMin()	578
MATRIX EDIT menu	223	minimum operation on a graph	129
MATRIX MATH menu	236	minutes notation (')	84, 626
MATRIX NAMES menu	228	ModBoxplot plot type ()	320
max((maximum)	70, 270, 590	mode settings	19
maximum of a function (fMax()	59	a+bi (complex rectangular)	24, 72, 568
maximum of a function (fMax()	578	Connected (plotting)	23, 571
maximum operation on a graph	129	Degree (angle)	22, 85, 573
mean(.	270, 590	Dot (plotting)	23, 575
Med(Med (median-median)	308	Eng (notation)	21, 576
median(.	270, 590	Fix (decimal)	22, 577
Med-Med (median-median)	590	Float (decimal)	22, 577
Mem Mgmt/Del menu	516	Full (screen)	24, 579
memory		Func (graphing)	23, 579
backing up	562	G-T (screen)	24, 583
checking available	514	Horiz (screen)	24, 583
clearing all list elements from	521	Normal (notation)	21, 592
clearing entries from	521	Par/Param (graphing)	23, 594
deleting items from	519	Pol/Polar (graphing)	23, 596
error	543	Radian (angle)	22, 85, 600
insufficient during transmission	565	re ^θ i (complex polar)	601
resetting defaults	530	re ^θ i (complex polar)	24, 72
resetting memory	530	Real	24, 601
MEMORY menu	514	Sci (notation)	21, 606
Menu((define menu)	444, 591	Seq (graphing)	23, 606
menus	34, 35	Sequential (graphing order)	23, 607
defining (Menu()	444	Simul (graphing order)	23, 609
defining (Menu()	591	modified box plot type ()	320
scrolling	36	multiple entries on a line	16
min((minimum)	70, 270, 591		

multiplication (*) 53, 624
multiplicative inverse 54

N

N (number of payment periods variable) .
391, 406
nCr (number of combinations) . . 80, 591
nDeriv((numerical derivative) . . . 60, 592
negation (-) 42, 55, 624
nonrecursive sequences 157
normal distribution probability
(normalcdf() 374, 592
Normal notation mode 21, 592
normal probability plot type (↙) . . . 322
normalcdf((normal distribution probability)
. 374
normalpdf((probability density function) .
373, 593
NormProbPlot plot type (↙) 322
not equal to (\neq) 88, 622
not((Boolean operator) 91, 593
nPr (permutations) 80, 593
npv((net present value) 398, 593
numerical derivative . . 60, 130, 143, 151
numerical integral 60, 131

O

Omit 538, 560
one-proportion z confidence interval
(1-PropZInt) 357, 597

one-proportion z test (1-PropZTest) 349,
597
one-sample t confidence interval
(TInterval) 353, 613
one-variable statistics (1-Var Stats) 307,
616
or (Boolean) operator 90, 594
order of evaluating equations 40
Output(. 219, 452, 594
Overwrite 538, 560
Overwrite All 538

P

P/Y (number-of-payment-periods-per-year
variable) 391, 406
P►Rx(, P►Ry((polar-to-rectangular
conversions) 86, 599
panning 117
Par/Param (parametric graphing mode) .
23, 594
parametric equations 138
parametric graphing
CALC (calculate operations on a
graph) 143
defining and editing 138
free-moving cursor 141
graph format 139
graph styles 137
moving the cursor to a value 142
selecting and deselecting 138
setting parametric mode 137

tracing	141	polar form, complex numbers	75
window variables	139	polar graphing	
Y= editor	137	CALC (calculate operations on a	
zoom operations	143	graph)	151
parentheses	41	defining and displaying	146
path graph style	101	equations	147
Pause	441, 594	free-moving cursor	150
pausing a graph	111	graph format	148
Pen	200	graph styles	146
permutations (nPr)	80, 593	mode (Pol/Polar)	23, 146, 596
phase plots	169	moving the cursor to a value	151
Pic (pictures)	206	selecting and deselecting	147
pictures (Pic)	206	tracing	150
pixels in Horiz/G-T modes	205, 219	window variables	147
Plot1(322, 594	Y= editor	146
Plot2(322, 594	ZOOM operations	151
Plot3(322, 594	PolarGC (polar graphing coordinates)	
PlotsOff	325, 595	109,	596
PlotsOn	325, 595	pooled option	336, 338
plotting modes	23	power (^)	54, 624
plotting stat data	318	power of ten (10^()	54
PMT (payment amount variable)	391, 406	power of ten (10^()	624
Pmt_Bgn (payment beginning variable)		present value	391, 395
405,	595	previous entry (Last Entry)	29
Pmt_End (payment end variable)	404,	prgm (program name)	445, 596
596		PRGM CTL (program control menu)	435
poissoncdf(381, 596	PRGM EDIT menu	434
poissonpdf(381, 596	PRGM EXEC menu	434
Pol/Polar (polar graphing mode)	23, 146,	PRGM NEW menu	427
596		probability	79
polar equations	147		

probability density function (normalpdf()
 373
 probability density function (normalpdf()
 593
 prod((product) 271, 597
 programming
 copying and renaming 433
 creating new 427
 defined 427
 deleting 428
 deleting command lines 433
 editing 432
 entering command lines 430
 executing 431
 inserting command lines 433
 instructions 435
 name (prgm) 445, 596
 renaming 433
 running assembly language program
 458
 stopping 432
 subroutines 456
 Prompt 450, 597
 Pt-Change(..... 202, 598
 Pt-Off(..... 202, 598
 Pt-On(..... 201, 598
 PV (present value variable) ... 391, 406
 p-value 370
 PwrReg (power regression) ... 310, 598
 Pxl-Change(..... 204, 598
 Pxl-Off(..... 204, 599

Pxl-On(..... 204, 599
 pxl-Test(..... 204, 599

Q

QuadReg (quadratic regression) 309, 599
 QuartReg (quartic regression) .. 309, 600
 Quick Zoom 117
 Quit 538, 560

R

r (correlation coefficient) 304
 r (radian notation) 85, 620
 r², R² (coefficients of determination) 304
 R►Pr(, R►Pθ((rectangular-to-polar
 conversions) 603
 R►Pr(, R►Pθ((rectangular-to-polar
 conversions) 86
 Radian angle mode 22, 85, 600
 radian notation (r) 85, 620
 RAM ARCHIVE ALL menu 529
 rand (random number) 80, 600
 randBin((random binomial) 83, 600
 randInt((random integer) 82, 600
 randM((random matrix) 240, 600
 randNorm((random Normal) 82, 601
 random seed 80
 RCL (recall) 28, 256
 re^{θi} (polar complex mode) 601
 re^{θi} (polar complex mode) 24, 72
 Real mode 24, 601
 real((real part) 77, 601

RecallGDB 209, 601
 RecallPic 206, 601
 rectangular form, complex numbers .. 74
 RectGC (rectangular graphing
 coordinates) 109, 602
 recursive sequences 158
 ref((row-echelon form) 243, 602
 RegEQ (regression equation variable) ..
 303, 519
 regression model
 automatic regression equation .. 303
 automatic residual list feature .. 302
 diagnostics display mode 304
 models 307
 relational operations 88, 234
 Removing a Faceplate 10
 Repeat 440, 602
 RESET MEMORY menu 533
 resetting
 all memory 533
 archive memory 531
 defaults 530
 memory 530
 RAM memory 530
 residual list (RESID) 302
 Return 445, 602
 root ($\sqrt[x]{}$) 59, 621
 root of a function 127
 round(..... 69, 233, 602
 row+(..... 602
 rowSwap(..... 243, 603

rref((reduced-row-echelon form) .. 243,
 603

S

Sci (scientific notation mode) ... 21, 606
 scientific notation 16
 screen modes 24
 second cursor (2nd) 9
 second key (2nd) 3
 seconds DMS notation (") 84
 sector 542
 Select(..... 263, 606
 selecting
 data points from a plot 264
 functions from the home screen or a
 program 100
 functions in the Y= editor 100
 stat plots from the Y= editor 100
 Send((send to CBL 2™ or CBR™) . 455,
 606
 SendID 554
 sending *See* transmitting 52
 SendSW 554
 Seq (sequence graphing mode) .23, 606
 seq((sequence) 262, 606
 sequence graphing
 axes format 161
 CALC (calculate menu) 164
 evaluating 165
 free-moving cursor 162
 graph format 162

graph styles	156	Shade(.	195, 608
moving the cursor to a value . . .	163	Shade_t(.	384, 609
nonrecursive sequences	157	Shade χ^2 (.	385, 608
recursive sequences	158	ShadeF(.	385, 608
selecting and deselecting	156	ShadeNorm(.	383, 609
TI-84 Plus versus TI-82 table . . .	173	shading graph areas	103, 195
tracing	162	Simul (simultaneous graphing order	
web plots	165	mode)	23, 609
window variables	159	sin((sine)	53, 609
Y= editor	155	sin ⁻¹ ((arcsine)	53, 609
ZOOM (zoom menu)	164	sine (sin()	53
Sequential (graphing order mode) . .	23,	sine (sin()	609
607		sinh((hyperbolic sine)	423, 609
service and support	659	sinh ⁻¹ ((hyperbolic arcsine)	423, 609
setDate((set date)	607	SinReg (sinusoidal regression) .	311, 610
setDtFmt((set date format)	607	Smart Graph	111
setTime((set time)	607	solve(.	66, 610
setting		Solver	61
display contrast	6	solving for variables in the equation solver	
graph styles	102	64
graph styles from a program . . .	104	SortA((sort ascending) . . .	259, 299, 610
modes	20	SortD((sort descending) . .	259, 299, 610
modes from a program	21	split-screen modes	
split-screen modes	213	G-T (graph-table) mode	216
split-screen modes from a program .		Horiz (horizontal) mode	215
220		setting	213, 220
tables from a program	178	split-screen values	199, 205, 219
setTmFmt((set time format)	607	square (²)	54, 623
SetUpEditor	301, 607	square root ($\sqrt{}$ ()	54
shade above graph style	101	square root ($\sqrt{}$ ()	624
shade below graph style	101	startTmr, start timer	611

STAT CALC menu	306	2-SampFTest (two-sample F -Test)	361
STAT EDIT menu	299	2-SampTInt (two-sample t confidence interval)	355
stat list editor		2-SampTTest (two-sample t test)	347
attaching formulas to list names	289	2-SampZInt (two-sample z confidence interval)	354
clearing elements from lists	287	2-SampZTest (two-sample z test)	345
creating list names	286	ANOVA((one-way analysis of variance)	363
detaching formulas from list names	292	χ^2 -Test (chi-square test)	358, 360
displaying	283	χ^2 -Test (chi-square test)	358, 360
edit-elements context	296	LinRegTTest (linear regression t test)	363
editing elements of formula-generated lists	293	TInterval (one-sample t confidence interval)	353
editing list elements	288	T-Test (one-sample t test)	344
entering list names	284	ZInterval (one-sample z confidence interval)	352
enter-names context	298	Z-Test (one-sample z test)	342
formula-generated list names	291	STAT TESTS menu	340
removing lists	287	statistical distribution functions	<i>See</i>
restoring list names L1–L6	287	distribution functions	52
switching contexts	294	statistical plotting	318
view-elements context	295	Boxplot (regular box plot)	321
view-names context	297	defining	322
STAT PLOTS menu	322	from a program	326
stat tests and confidence intervals		Histogram	320
1-PropZInt (one-proportion z confidence interval)	357	ModBoxplot (modified box plot)	320
1-PropZTest (one-proportion z test)	349	NormProbPlot (normal probability plot)	322
2-PropZInt (two-proportion z confidence interval)	357		
2-PropZTest (two-proportion z test)	350		

tracing 326
 turning on/off stat plots 100, 325
 viewing window 326
 xyLine 319
 statistical variables table 315
 Stats input option 336, 337
 stdDev((standard deviation) .. 272, 611
 Stop 446, 611
 Store (→) 27, 611
 StoreGDB 208, 611
 StorePic 206, 611
 storing
 graph databases (GDBs) 208
 graph pictures 205
 variable values 27
 String►Equ((string-to-equation
 conversions) 420, 611
 strings
 concatenation (+) 417, 626
 converting 418
 defined 413
 displaying contents 416
 entering 413
 functions in CATALOG 416
 indicator (") 413
 length (length() 420
 length (length() 587
 storing 415
 variables 414, 415
 student-*t* distribution
 probability (tcdf() 376

probability (tcdf() 612
 student-*t* distribution
 probability density function (tpdf() ..
 376
 probability density function (tpdf() ..
 614
 sub((substring) 421, 612
 subroutines 445
 subtraction (−) 53, 626
 sum((summation) 271, 612
 support and service 659
 system variables 628

T

T (transpose matrix) 237, 621
 TABLE SETUP screen 176
 tables
 description 180
 variables 177, 178
 tan((tangent) 53, 612
 tan⁻¹((arctangent) 53, 612
 tangent (tan() 53
 tangent (tan() 612
 tangent lines, drawing 192
 Tangent((draw line) 192, 612
 tanh((hyperbolic tangent) 423, 612
 tanh⁻¹((hyperbolic arctangent) .. 423, 612
 TblStart (table start variable) 177
 tcdf((student-*t* distribution probability) ..
 376, 612
 TEST (relational menu) 88

TEST LOGIC (Boolean menu)	90	variables	405
Text(timeCnv(), convert time	613
instruction	198, 219, 613	TInterval (one-sample t confidence	
placing on a graph	198, 219	interval)	613
Then	437, 584	TInterval (one-sample t confidence	
thick graph style	101	interval)	353
TI Connect™	552	tpdf((student- t distribution probability	
TI-84 Plus		density function)	376, 614
key code diagram	454	TRACE	
keyboard	1	cursor	116
Time axes format	161, 613	entering numbers during	116, 142,
time value of money (TVM)		150,	162
C/Y variable (number of compounding		expression display	110, 116
periods per year)	406	Trace instruction in a program :	118,
calculating	394	614	
formulas	635	transmitting	
FV variable (future value)	406	error conditions	564
I% variable (annual interest rate)	406	from a TI-83	562
N variable (number of payment		from a TI-83 Plus Silver Edition or	
periods)	406	TI-83 Plus	562
P/Y variable (number of payment		from a TI-84 Plus Silver Edition or	
periods per year)	406	TI-84 Plus	562
PMT variable (payment amount)	406	stopping	556
PV variable (present value)	406	to a TI-84 Plus Silver Edition or TI-84	
TVM Solver	391	Plus	556
tvm_FV (future value)	396, 614	transpose matrix (T)	237, 621
tvm_I% (interest rate)	615	trigonometric functions	53
tvm_I% (interest rate)	395	T-Test (one-sample t test)	344, 614
tvm_ N (# payment periods)	396, 615	turn clock off, ClockOff	570
tvm_Pmt (payment amount)	394, 615	turn clock on, ClockOn	570
tvm_PV (present value)	395, 615	turning on and off	

axes	110
calculator	4
coordinates	109
expressions	110
functions	100
grid	109
labels	110
points	201
stat plots	100, 325
tvm_FV (future value)	396, 614
tvm_I% (interest rate)	615
tvm_I% (interest rate)	395
tvm_N (# payment periods)	396, 615
tvm_Pmt (payment amount)	394, 615
tvm_PV (present value)	395, 615
two-proportion z confidence interval (2-PropZInt)	357, 597
two-proportion z test (2-PropZTest)	350, 598
two-sample F-Test formula	632
two-sample t test formula	633
two-variable statistics (2-Var Stats)	308, 616

U

u sequence function	154
UnArchive	28, 523, 615
ungrouping	535
user variables	627
uv/uvAxes (axes format)	161, 615
uw/uwAxes (axes format)	161, 615

V

v sequence function	154
value operation on a graph	126
variables	
complex	25
displaying and storing values	27
equation solver	64
graph databases	25
graph pictures	25
independent/dependent	180
list	25, 247
matrix	25, 222
real	25
recalling values	28
solver editor	63
statistical	315
string	414, 415
test and interval output	370
types	25
user and system	26, 627
VARS and Y-VARS menus	38
variance of a list (variance())	272
variance of a list (variance())	616
variance((variance of a list)	272, 616
VARS menu	
GDB	38
Picture	38
Statistics	38
String	38
Table	38
Window	38

Zoom	38
Vertical (draw line)	191, 616
viewing window	105
vw/uvAxes (axes format)	161, 616

W

w sequence function	154
warranty	661
Web (axes format)	161, 616
web plots	165
While	440, 616
window variables	
function graphing	105
parametric graphing	140
polar graphing	147

X

$x\sqrt{\quad}$ (root)	621
XFact zoom factor	125
x-intercept of a root	127
xor (Boolean) exclusive or operator	90, 617
xth root ($x\sqrt{\quad}$)	59
xyLine (⎓) plot type	319

Y

Y= editor	
function graphing	96
parametric graphing	137
polar graphing	146

sequence graphing	155
YFact zoom factor	125
Y-VARS menu	
Function	39
On/Off	39
Parametric	39
Polar	39

Z

ZBox	119, 617
ZDecimal	121, 617
zero operation on a graph	127
ZInteger	122, 617
ZInterval (one-sample z confidence interval)	352, 617
zoom 118, 119, 120, 121, 122, 123, 124, 125	
cursor	119
factors	124
function graphing	118
parametric graphing	143
polar graphing	151
sequence graphing	164
Zoom In (zoom in)	120, 618
ZOOM MEMORY menu	123
ZOOM menu	118
Zoom Out (zoom out)	120, 618
ZoomFit (zoom to fit function)	123, 618
ZoomRcl (recall stored window)	124, 618
ZoomStat (statistics zoom)	123, 618
ZoomSto (store zoom window)	124, 618

ZPrevious (use previous window) . . . 619
ZSquare (set square pixels) . . . 121, 619
ZStandard (use standard window) . . 122,
619
Z-Test (one-sample z test) 342, 619
ZTrig (trigonometric window) . . 122, 620