

A GUIDE FOR TEACHERS 教师指南
UNA GUIA PARA PROFESORES
GUIDE POUR INSTITUTEURS
UNA GUÍA PARA MAESTROS
คู่มือแนะนำสำหรับครู



TI-30X II

TI-30 X IIS:

A Guide for Teachers

Developed by
Texas Instruments Incorporated

Activities developed by
Gary Hanson and Aletta Paskett

Illustrated by
Jay Garrison

About the Authors

Gary Hanson and Alet ha Pasket t are mat h t eachers in t he Jordan Independent School Dist rict in Sandy, Ut ah. They developed t he Act ivit ies sect ion and assist ed in evaluat ing t he appropriat eness of t he examples in t he How t o Use t he TI-30 X IIS sect ion of t his guide.

Important Notice Regarding Book Materials

Texas Instruments makes no warranty, either expressed or implied, including but not limited to any implied warranties of merchantability and fitness for a particular purpose, regarding any programs or book materials and makes such materials available **solely** on an “as-is” basis. In no event shall Texas Instruments be liable to anyone for special, collateral, incidental, or consequential damages in connection with or arising out of the purchase or use of these materials, and the sole and exclusive liability of Texas Instruments, regardless of the form of action, shall not exceed the purchase price of this book. Moreover, Texas Instruments shall not be liable for any claim of any kind whatsoever against the use of these materials by any other party.

Note: Using calculators other than the TI-30X IIS may produce results different from those described in these materials.

Permission To Reprint or Photocopy

Permission is hereby granted to teachers to reprint or photocopy in classroom, workshop, or seminar quantities, the pages or sheets in this book that carry a Texas Instruments copyright notice. These pages are designed to be reproduced by teachers for use in classes, workshops, or seminars, provided each copy made shows the copyright notice. Such copies may not be sold, and further distribution is expressly prohibited. Except as authorized above, prior written permission must be obtained from Texas Instruments Incorporated to reproduce or transmit this work or portions thereof in any other form or by any other electronic or mechanical means, including any information storage or retrieval system, unless expressly permitted by federal copyright law.

Send inquiries to this address:
Texas Instruments Incorporated
7800 Banner Drive, M/S 3918
Dallas, TX 75251
Attention: Manager, Business Services

Note: If you request photocopies of all or portions of this book from others, you must include this page (with the permission statement above) to the supplier of the photocopying services.



www.ti.com/calc
ti-cares@ti.com

Copyright © 1999 Texas Instruments Incorporated.
Except for the specific rights granted herein, all rights are reserved.
Printed in the United States of America.

Automatic Power Down, APD, and EOS are trademarks of Texas Instruments Incorporated.

About the Teacher Guide



How the Teacher Guide is Organized

This guide consists of two sections: Activities and How to Use the TI-30XIIS. The Activities section is a collection of activities for integrating the TI-30XIIS into mathematics instruction. The How To Use the TI-30XIIS section is designed to help you teach students how to use the calculator.

Activities

The activities are designed to be teacher-directed. They are intended to help develop mathematical concepts while incorporating the TI-30XIIS as a teaching tool. Each activity is self-contained and includes the following:

- An overview of the mathematical purpose of the activity.
- The mathematical concepts being developed.
- The materials needed to perform the activity.
- The detailed procedure, including step-by-step TI-30XIIS key presses.
- A student activity sheet.

How to Use the TI-30XIIS

This section contains examples on transparency masters. Chapters are numbered and include the following.

- An introductory page describing the calculator keys presented in the example, the location of those keys on the TI-30XIIS, and any pertinent notes about their functions.
- Transparency masters following the introductory page provide examples of practical applications of the key(s) being discussed. The key(s) being discussed are circled on the TI-30XIIS keyboard.

Things to Keep in Mind

- While many of the examples on the transparency masters may be used to develop mathematical concepts, they were not designed specifically for that purpose.
- For maximum flexibility, each example and activity is independent of the others. Select the transparency master appropriate for the key you are teaching, or select the activity appropriate for the mathematical concept you are teaching.
- If an example does not seem appropriate for your curriculum or grade level, use it to teach the function of a key (or keys), and then provide relevant examples of your own.
- To ensure that everyone starts at the same point, have students reset the calculator by pressing **ON** and **CLEAR** simultaneously or by pressing **2nd** **[RESET]** and then selecting **Y** (yes).

Conventions Used in the Teacher Guide

- In the text, brackets [] around a key's symbol/name indicate that the key is a second, or alternate, function.
For example: **[SIN⁻¹]**
- On the transparency masters, second functions are shown just as they appear on the keyboard.

For example: **^{SIN⁻¹}**[SIN]****

How to Order Additional Teacher Guides

To place an order or to request information about Texas Instruments (TI) calculators, use our e-mail address: **ti-cares@ti.com** visit our TI calculator home page: **www.ti.com/calc** or, call our toll-free number:

1-800-TI-CARES (1-800-842-2737)

About the TI-30XIIS



Two-Line Display

The first line (entry line) displays an entry of up to 88 digits (47 digits for the stat and constant entry lines). Entries begin on the left; those with more than 11 digits scroll to the right. Press \leftarrow and \rightarrow to scroll the entry line. Press 2^{nd} \leftarrow or 2^{nd} \rightarrow to move the cursor immediately to the beginning or end of the entry.

The second line (result line) displays a result of up to 10 digits, plus a decimal point, negative sign, **x10** indicator, and 2-digit positive or negative exponent. Results that exceed the digit limit are displayed in scientific notation.

Display Indicators

Refer to Appendix B for a list of the display indicators.

Order of Operations

The TI-30XIIS uses the Equation Operating System (EOS™) to evaluate expressions. The operation priorities are listed on the transparency master in Chapter 4, Order of Operations and Parentheses (page 41).

Because operations inside parentheses are performed first, you can use $()$ to change the order of operations and, therefore, change the result.

2nd Functions

Pressing 2^{nd} displays the **2nd** indicator, and then accesses the function printed above the next key pressed. For example, 2^{nd} $\sqrt{}$ 25 $)$ ENTER calculates the square root of 25 and returns the result, **5**.

Menus

Certain TI-30XIIS keys display menus:

MEMVAR , 2^{nd} RCL , STO , 2^{nd} STAT , STATVAR , 2^{nd} EXIT STAT , PRB , DRG , 2^{nd} $\text{R}\leftrightarrow\text{P}$, $^{\circ}$, 2^{nd} SCI/ENG , 2^{nd} FIX and 2^{nd} RESET .

Press \leftarrow or \rightarrow to move the cursor and underline a menu item. To return to the previous screen without selecting the item, press CLEAR . To select a menu item:

- Press ENTER while the item is underlined, or
- For menu items followed by an argument value (for example, **nPr**), enter the value while the item is underlined. The item and the argument value are displayed on the previous screen.

Previous Entries \uparrow \downarrow

After an expression is evaluated, use \uparrow and \downarrow to scroll through previous entries, which are stored in the TI-30XIIS history. You cannot retrieve previous entries while in **STAT** mode.

Error Messages

Refer to Appendix C for a listing of the error messages.

Last Answer (Ans)

The most recently calculated result is stored to the variable **Ans**. **Ans** is retained in memory, even after the TI-30XIIS is turned off. To recall the value of **Ans**:

- Press 2^{nd} ANS (**Ans** displays on the screen), or
- Press any operation key ($+$, $-$, etc.) as the first part of an entry. **Ans** and the operator are both displayed.

About the TI-30XIIS (Continued)

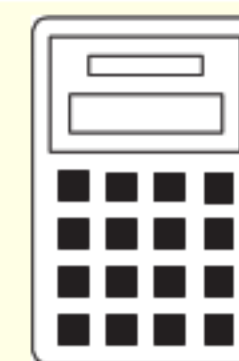

Resetting the TI-30X IIS

Pressing **ON** and **CLEAR** simultaneously or pressing **2nd** **[RESET]** and then selecting **Y** (yes) resets the calculator.

Resetting the calculator:

- Returns settings to their defaults—standard notation (floating decimal) and degree (**DEG**) mode.
- Clears memory variables, pending operations, entries in history, statistical data, constants, and **Ans** (Last Answer).

Note: The examples on the transparency masters assume all default settings.

Automatic Power Down™ (APD™)

If the TI-30X IIS remains inactive for about 5 minutes, APD turns it off automatically. Press **ON** after APD. The display, pending operations, settings, and memory are retained.

Table of Contents



<i>About the Authors</i>	<i>ii</i>	How to Use the TI-30 X IIS (Continued)	
<i>About the Teacher Guide</i>	<i>iii</i>	10 Powers, Roots, and Reciprocals	61
<i>About the TI-30 X IIS</i>	<i>iv</i>	11 Probability	68
		12 Statistics	75
Activities		13 Trigonometry	81
The Better Batter —		14 Notation	88
The FIX Key	2	15 Logarithms and Antilogarithms	91
Star Voyage —		16 Angle Settings and Conversions	94
Scientific Notation	6	17 Polar and Rectangular Conversions	98
Trig Functions	10	18 Hyperbolics	100
What's My Score —			
1-Variable Statistics	14	Appendix A	A-1
Heart Rates —		Quick Reference to Keys	
1-Variable Statistics	17	Appendix B	B-1
WNBA Stats —		Display Indicators	
2-Variable Statistics	23	Appendix C	C-1
		Error Messages	
		Appendix D	D-1
		Support and Service Information	
		Appendix E	E-1
		Warranty Information	
How to Use the TI-30 X IIS			
1 TI-30 X IIS Basic Operations	29		
2 Clear, Insert, and Delete	33		
3 Basic Math	36		
4 Order of Operations and Parentheses	40		
5 Constant	43		
6 Decimals and Decimal Places	45		
7 Memory	47		
8 Fractions	52		
9 Pi	58		



Activities

The Better Batter — The FIX Key	2
Star Voyage — Scientific Notation	6
Trig Functions	10
What's My Score? — 1-Variable Statistics	14
Heart Rates — 1-Variable Statistics	17
WNBA Stats — 2-Variable Statistics	23

The Better Batter — The FIX Key

Overview

Students use $\boxed{2nd}$ [FIX] on the TI-30X IIS to change numbers to different place values. Students calculate batting averages using the TI-30X IIS and then round their answers to 3 decimal places.

Math Concepts

- rounding
- place value
- division
- comparing and ordering decimals

Materials

- TI-30X IIS
- pencil
- student activity

Introduction

1. Have students practice rounding the following numbers to 3 decimal places using pencil and paper.

- | | |
|------------|---------------|
| a. 2.35647 | <i>2.356</i> |
| b. 15.3633 | <i>15.363</i> |
| c. 0.02698 | <i>0.027</i> |

2. Have students round the following numbers to 4 decimal places using the TI-30X IIS.

- | | |
|--------------|----------------|
| a. 4.39865 | <i>4.3987</i> |
| b. 72.965912 | <i>72.9659</i> |
| c. 0.29516 | <i>0.2952</i> |
| d. 0.00395 | <i>0.0040</i> |

Activity

Present the following problem to students:

You are going to play Virtual Baseball. You need to select 9 players from the list to be on your team. Choose the players with the best batting averages. Find the batting averages (number of hits \div number of times at bat) rounded to 3 decimal places for each player. Make a list of your players in order, from highest to lowest.

See the table on page 3 for solutions.

1. Enter the first number.
4.39865
2. Press $\boxed{2nd}$ [FIX] to display the menu that lets you set the number of decimal places.
F0123456789
3. Press 4 to select 4 decimal places.
4.39865
4. Press \boxed{ENTER} .
4.39865
4.3987

The Better Batter — The FIX Key (Continued)

Player	Number of Hits	Number of Times at Bat	Batting Average
C. Ripken	122	368	0.332
Puckett	119	363	0.328
Molitor	119	364	0.327
Greenwell	104	334	0.311
Tartabull	103	311	0.331
Palmeiro	120	366	0.328
Franco	109	344	0.317
Joyner	105	338	0.311
Boggs	106	329	0.322
Baines	91	290	0.314
Sax	113	388	0.291
Williams	20	74	0.270
Sheridan	15	63	0.238
Barfield	64	284	0.225
Mattingly	109	367	0.297
Hall	87	280	0.311

The Better Batter — The FIX Key

Name _____

Date _____



Problems

1. Round the following numbers to 3 decimal places.

a. 2.35647 _____

b. 15.3633 _____

c. 0.02698 _____

2. Using the TI-30X IIS, round the following numbers to 4 decimal places.

a. 4.39865 _____

b. 72.965912 _____

c. 0.29516 _____

d. 0.00395 _____

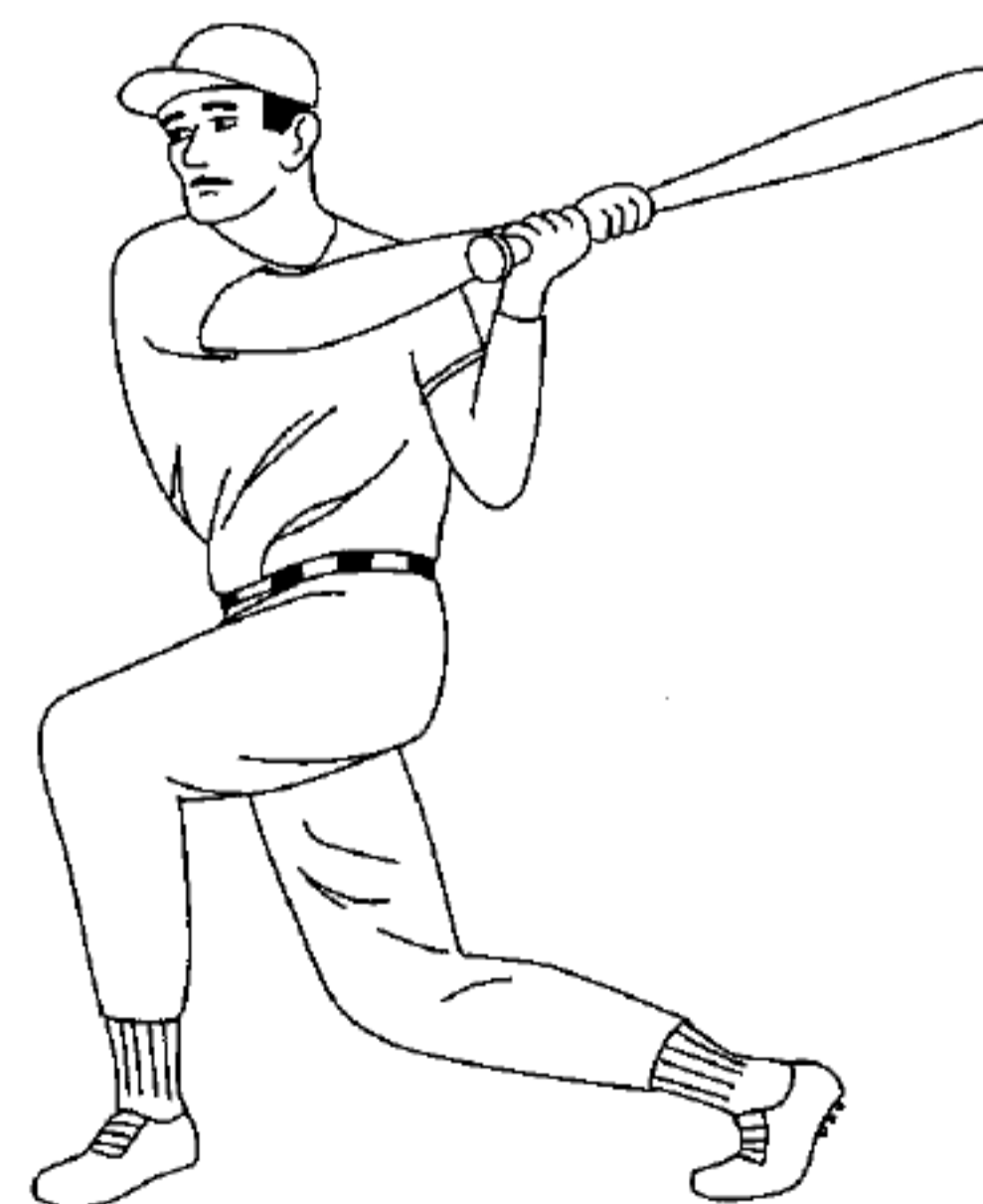

The Better Batter — The FIX Key

Name _____

Date _____



Problem

You are going to play Virtual Baseball. You need to select 9 players from the list to be on your team. Choose the players with the best batting averages.

Procedure

1. Find the batting averages (number of hits \div number of times at bat) rounded to 3 decimal places for each player.

Player	Number of Hits	Number of Times at Bat	Batting Average (rounded to 3 decimal places)
C. Ripken	122	368	
Puckett	119	363	
Molitor	119	364	
Greenwell	104	334	
Tartabull	103	311	
Palmeiro	120	366	
Franco	109	344	
Joyner	105	338	
Boggs	106	329	
Baines	91	290	
Sax	113	388	
Williams	20	74	
Sheridan	15	63	
Barfield	64	284	
Mattingly	109	367	
Hall	87	280	

2. Make a list of your players in order, from highest to lowest.

Player 1 _____

Player 6 _____

Player 2 _____

Player 7 _____

Player 3 _____

Player 8 _____

Player 4 _____

Player 9 _____

Player 5 _____

Star Voyage — Scientific Notation

Overview

Students investigate scientific notation by changing numbers into scientific notation, and then using them in calculations.

Math Concepts

- scientific notation
- addition
- division

Materials

- TI-30 X IIS
- pencil
- student activity

Introduction

Set up the activity by telling your students:

The standard form for scientific notation is $a \times 10^n$, where a is greater than or equal to 1 and less than 10, and n is an integer.

1. Have students practice writing the following numbers in scientific notation using pencil and paper.

- | | |
|---------------------|------------------------|
| a. 93 000 000 | 9.3×10^7 |
| b. 384 000 000 000 | 3.84×10^{11} |
| c. 0.00000000000234 | 2.34×10^{-12} |
| d. 0.0000000157 | 1.57×10^{-8} |

2. Have students change the following numbers into scientific notation using the TI-30X IIS.

- | | |
|----------------|----------------------|
| a. 12 000 000 | 1.2×10^7 |
| b. 974 000 000 | 9.74×10^8 |
| c. 0.0000034 | 3.4×10^{-6} |
| d. 0.000000004 | 4×10^{-9} |

Note: Answers assume the default floating decimal setting.

3. Have students change the following numbers into floating decimal (standard notation).

- | | |
|-------------------------|------------|
| a. 5.8×10^7 | 58 000 000 |
| b. 7.32×10^5 | 732 000 |
| c. 6.2×10^{-6} | 0.0000062 |
| d. 3×10^{-8} | 0.00000003 |

Note: To enter a negative number, press $\boxed{-}$ and then enter the number.

1. Enter the first number.
12000000
2. Press $\boxed{2nd}$ $\boxed{[SCI/ENG]}$.
FLO SCI ENG
3. Press $\boxed{\rightarrow}$ \boxed{ENTER} \boxed{ENTER} .
12000000
1.2x10⁰⁷

1. Enter **5.8**; press $\boxed{2nd}$ $\boxed{[EE]}$.
5.8E
2. Enter **7**; press $\boxed{2nd}$ $\boxed{[SCI/ENG]}$.
FLO SCI ENG
3. Press $\boxed{\downarrow}$.
FLO SCI ENG
4. Press \boxed{ENTER} \boxed{ENTER} .
5.8E7
58000000.

Star Voyage — Scientific Notation (Continued)

Activity

Present the following problem to students:

You are a captain of a starship. You have been assigned to go to Alpha Centauri and you have 5 years to get there. The distance from the sun to Alpha Centauri is 2.5×10^{13} miles. The distance from the earth to the sun is approximately 9.3×10^7 miles. Your ship can travel at the speed of light. You know that light can travel a distance of 6×10^{12} miles in 1 light year. Will you be able to get to Alpha Centauri on time?

Procedure

1. Using the TI-30X IIS, find the total distance you need to travel.

$$2.5 \times 10^{13} + 9.3 \times 10^7 = 2.5000093 \times 10^{13} \text{ miles}$$

2. Next, find out how long it will take you to travel the distance. (distance traveled \div 1 light year)

$$2.5000093 \times 10^{13} \div 6 \times 10^{12} = 4.166682167 \text{ years}$$

3. Can you make the trip in the given time?

Yes

Extension

Now that you have been successful, you have been asked to make another trip. The distance from the Sun to Delta Centauri is 9×10^{13} miles. How long will it take you to get there from Earth?

≈ 15 years

Hint: Make sure your calculator is in scientific notation mode before beginning addition.

Hint: The Earth is approximately 9.3×10^7 miles from the Sun.

Star Voyage — Scientific Notation

Name _____

Date _____



Problems

1. Write the following numbers in scientific notation.

Standard Notation

Scientific Notation

a. 93 000 000

b. 384 000 000 000

c. 0.00000000000234

d. 0.0000000157

2. Using the TI-30X IIS, change the following numbers into scientific notation.

Standard Notation **Scientific Notation**

a. 12 000 000

b. 974 000 000

c. 0.0000034

d. 0.000000004

3. Using the TI-30X IIS, change the following numbers into floating decimal notation (standard).

Scientific Notation

Standard Notation

a. 5.8×10^7

b. 7.32×10^5

c. 6.2×10^{-6}

d. 3×10^{-8}

Star Voyage — Scientific Notation

Name _____

Date _____



Problem

You are a captain of a starship. You have been assigned to go to Alpha Centauri, and you have 5 years to get there. The distance from the Sun to Alpha Centauri is 2.5×10^{13} miles. The distance from the Earth to the Sun is approximately 9.3×10^7 miles. Your ship can travel at the speed of light. You know that light can travel a distance of 6×10^{12} miles in 1 light year. Will you be able to get to Alpha Centauri on time?

Procedure

1. Using the TI-30X IIS, find the total distance that you need to travel.

Hint: Make sure your calculator is in scientific notation mode before you begin addition.

2. Next, find out how long it will take you to travel the distance. (distance traveled \div 1 light year) _____

3. Can you make the trip in the given time? _____

Extension

Now that you have been successful, you have been asked to make another trip. The distance from the Sun to Delta Centauri is 9×10^{13} miles. How long will it take you to get there from Earth?

Hint: The Earth is approximately 9.3×10^7 miles from the Sun.

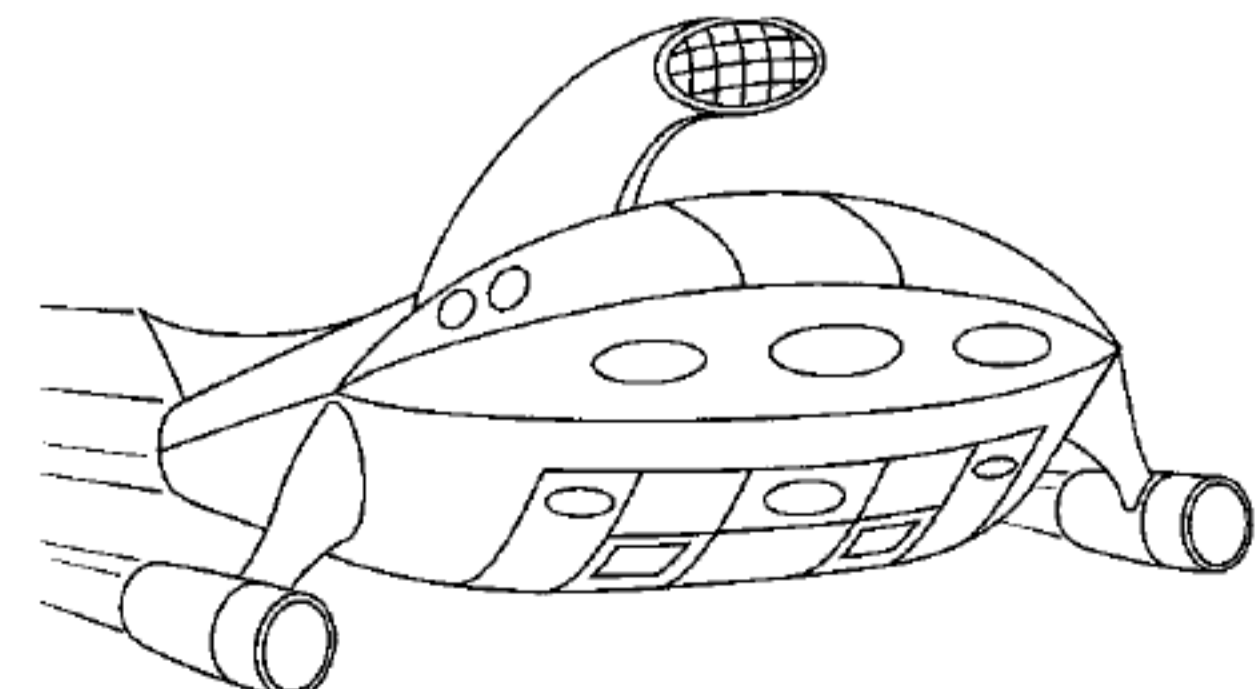

Trig Functions

Overview

Students practice solving sine, cosine, and tangent ratios, and solve problems involving trigonometric ratios.

Math Concepts

- multiplication
- division
- trigonometric ratios

Materials

- TI-30 X IIS
- pencil
- student activity

Introduction

Introduce the trigonometric ratios to students.

$$\sin = \text{opposite leg} \div \text{hypotenuse}$$

$$\cos = \text{adjacent leg} \div \text{hypotenuse}$$

$$\tan = \text{opposite leg} \div \text{adjacent leg}$$

1. Have students find the trigonometric ratios for the triangle using the above definitions. Round to the nearest hundredth if necessary. (Use $\boxed{2\text{nd}}$ $\boxed{[FIX]}$ for rounding.)

- | | |
|-------------|-------------------|
| a. $\sin C$ | $3 \div 5 = 0.60$ |
| b. $\cos C$ | $4 \div 5 = 0.80$ |
| c. $\tan C$ | $3 \div 4 = 0.75$ |
| d. $\sin A$ | $4 \div 5 = 0.80$ |
| e. $\cos A$ | $3 \div 5 = 0.60$ |
| f. $\tan A$ | $4 \div 3 = 1.33$ |

2. Have students find the value of each ratio using the TI-30X IIS. Round to the nearest 10 thousandth.

- | | |
|--------------------|----------|
| a. $\sin 71^\circ$ | 0.9455 |
| b. $\tan 31^\circ$ | 0.6009 |
| c. $\cos 25^\circ$ | 0.9063 |

3. Have students find the measure of each angle using the TI-30X IIS. Round to the nearest degree.

- | | |
|----------------------|----------------------|
| a. $\sin B = 0.4567$ | 27 degrees |
| b. $\cos A = 0.6758$ | 47 degrees |
| c. $\tan C = 5.83$ | 80 degrees |

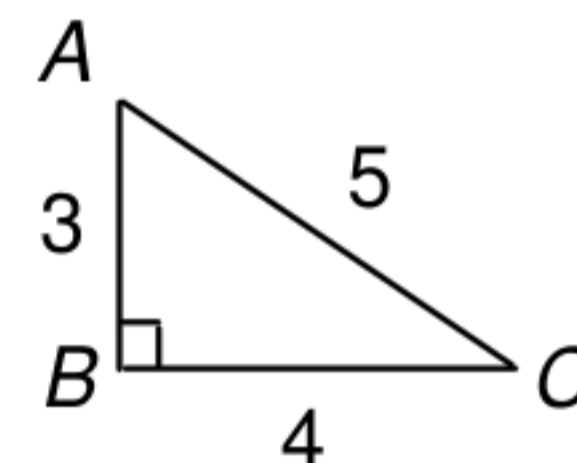

- $\boxed{\text{TI}}$ To set 2 decimal places:

1. Press $\boxed{2\text{nd}}$ $\boxed{[FIX]}$.
F0123456789
2. Press **2** to select 2 decimal places.

- $\boxed{\text{TI}}$ To find $\sin 71^\circ$:

1. Press $\boxed{[SIN]}$.
sin(
2. Enter **71**; press $\boxed{)}$ $\boxed{[ENTER]}$.
sin(71)
0.945518576
3. Press $\boxed{2\text{nd}}$ $\boxed{[FIX]}$ **4**.
sin(71)
0.9455

- $\boxed{\text{TI}}$ To find B when $\sin B = 0.4567$:

1. Press $\boxed{2\text{nd}}$ $\boxed{[SIN^{-1}]}$.
sin⁻¹(
2. Enter **.4567**; press $\boxed{)}$ $\boxed{[ENTER]}$.
sin⁻¹(.4567)
27.1744
3. Press $\boxed{2\text{nd}}$ $\boxed{[FIX]}$ **0**.
sin⁻¹(.4567)
27.

Trig Functions (Continued)

Activity

Present the following problem to students:

You need to build a ramp to your front door. The distance from the ground to the bottom of the door is 1.5 feet. You don't want the angle of incline to be more than 6 degrees. The distance from the street to the door is 20 feet. Is there enough room to build the ramp?

Procedure

1. Make a drawing of the problem.

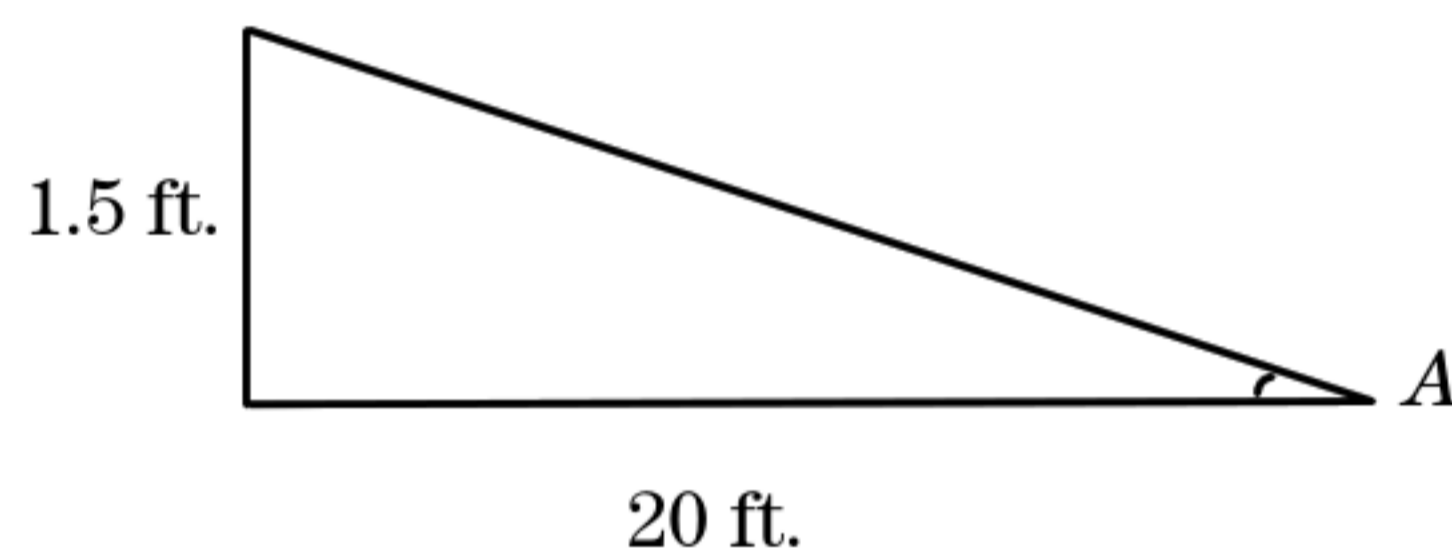

2. Use the trigonometric ratio

$$\tan = \text{opposite leg} \div \text{adjacent leg}$$

to find angle A.

Angle A is 4.3 degrees (rounded to the nearest tenth). Yes, there is enough room to build the ramp.

Extension

Present the following problem to students:

You want to start the ramp 15 feet away from the door. Can you do that and still have the angle of incline be less than 6 degrees?

Yes, angle A is 5.7°.

1. Press $\boxed{2\text{nd}}$ $\boxed{[\text{TAN}^{-1}]}$.
 $\tan^{-1}(\$
2. Enter $1.5 \div 20$ and press $\boxed{)} \boxed{[\text{ENTER}]}$.
 $\tan^{-1}(1.5/20)$
4.3

1. Press $\boxed{2\text{nd}}$ $\boxed{[\text{TAN}^{-1}]}$.
 $\tan^{-1}(\$
2. Enter $1.5 \div 15$ and press $\boxed{)} \boxed{[\text{ENTER}]}$.
 $\tan^{-1}(1.5/15)$
5.7

Trig Functions

Name _____

Date _____



Problems

1. Find the trigonometric ratios for the triangle. Round to the nearest hundredth. (Use $\boxed{2nd}$ \boxed{FIX} for rounding.)

- a. $\sin C$ _____
- b. $\cos C$ _____
- c. $\tan C$ _____
- d. $\sin A$ _____
- e. $\cos A$ _____
- f. $\tan A$ _____

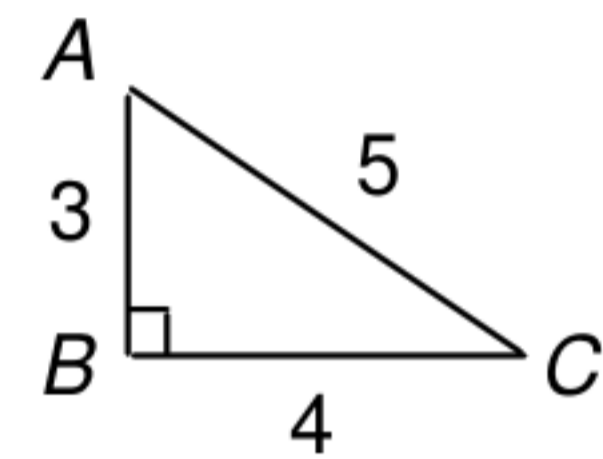

2. Using the TI-30X IIS, find the value of each ratio. Round to the nearest ten thousandth.

- a. $\sin 71^\circ$ _____
- b. $\tan 31^\circ$ _____
- c. $\cos 25^\circ$ _____

3. Using the TI-30X IIS, find the measure of each angle. Round to the nearest degree.

- a. $\sin B = 0.4567$ _____
- b. $\cos A = 0.6758$ _____
- c. $\tan C = 5.83$ _____

Trig Functions

Name _____

Date _____



Problem

You need to build a ramp to your front door. The distance from the ground to the bottom of the door is 1.5 feet. You don't want the angle of incline to be more than 6 degrees. The distance from the street to the door is 20 feet. Is there enough room to build the ramp?

Procedure

1. Make a drawing of the problem.

2. Use the trigonometric ratio $\tan = \text{opposite leg} \div \text{adjacent leg}$ to find angle A. (Round your answer to the nearest tenth.) _____

3. Is there room to build the ramp? _____

Extension

You want to start the ramp 15 feet away from the door. Can you do that and still have the angle of incline be less than 6 degrees?

What's My Score? — 1-Variable Statistics

Overview

Students use the given test scores to find averages.

Math Concepts

- averages

Materials

- TI-30 X IIS
- pencil
- student activity

Introduction

Discuss finding averages with your students.

Activity

Present the following problem to students:

You and your friend are having a contest. The one who gets the highest average on their math tests for one quarter wins. Your scores are 98, 89, 78, 98, and 100. Your friend's scores are 89, 89, 97, 90, and 100. Who is the winner?

Procedure

1. Have students find the average of their scores using the TI-30X IIS. Remember to enter 2 as the frequency for 98 and 1 for all others.

1. Press 2nd [STAT] ENTER to select **1-VAR** mode.
2. Press DATA and enter your first score.
X1 = 98
3. Press DOWN and enter 2 as the frequency for 98.
FRQ = 2
4. Press DOWN . Continue entering your scores and frequencies, pressing DOWN after each score and frequency.
5. When finished, press STATVAR RIGHT to select \bar{x} , the average. Write it down.
n \bar{x} Sx σ_x
92.6

What's My Score? — 1-Variable Statistics (Continued)

2. Now find the average of your friend's scores. Remember to put 2 as the frequency for 89 and 1 for all others.
3. Who won?

Your friend: 93 (You had 92.6.)

Extension

Present the following problem to students:

Your friend took a test on the day you were absent and scored 95. What score do you need to get so that you are the winner?

The score you need: 98

Note: Make sure you exit the **STAT** mode before going on to another problem.

1. Press $\boxed{2\text{nd}} \boxed{[\text{STAT}]} \downarrow \downarrow \boxed{[\text{ENTER}]}$ to select **CLRDATA**.
2. Press $\boxed{[\text{DATA}]}$ and enter the friend's first score.
X1 = 89
3. Continue entering the friend's scores and frequencies, following steps 3 and 4 on the previous page.
4. When finished, press $\boxed{[\text{STATVAR}]} \downarrow$ to select \bar{x} , the average. Write it down.
n \bar{x} Sx σ_x
93.0

1. Press $\boxed{2\text{nd}} \boxed{[\text{STAT}]} \downarrow \downarrow$ to **CLRDATA**. Press $\boxed{[\text{ENTER}]}$.
2. Recalculate your friend's average, making sure to include the new score.
3. Use guess and check to figure out what score you need to get.
4. To exit **STAT** mode, press $\boxed{2\text{nd}} \boxed{[\text{EXIT STAT}]} \boxed{[\text{ENTER}]}$.

What's My Score? — 1-Variable Statistics

Name _____

Date _____



Problems

1. You and your friend are having a contest. Whoever gets the highest average on their math tests for one quarter wins. Your scores are 98, 89, 78, 98, and 100. Your friend's scores are 89, 89, 97, 90, and 100. Who is the winner?

Your average _____

Your friend's average _____

2. Your friend took a test on the day you were absent and scored 95. What score do you need to get so that you are the winner?

Your friend's new average _____

The score you need _____

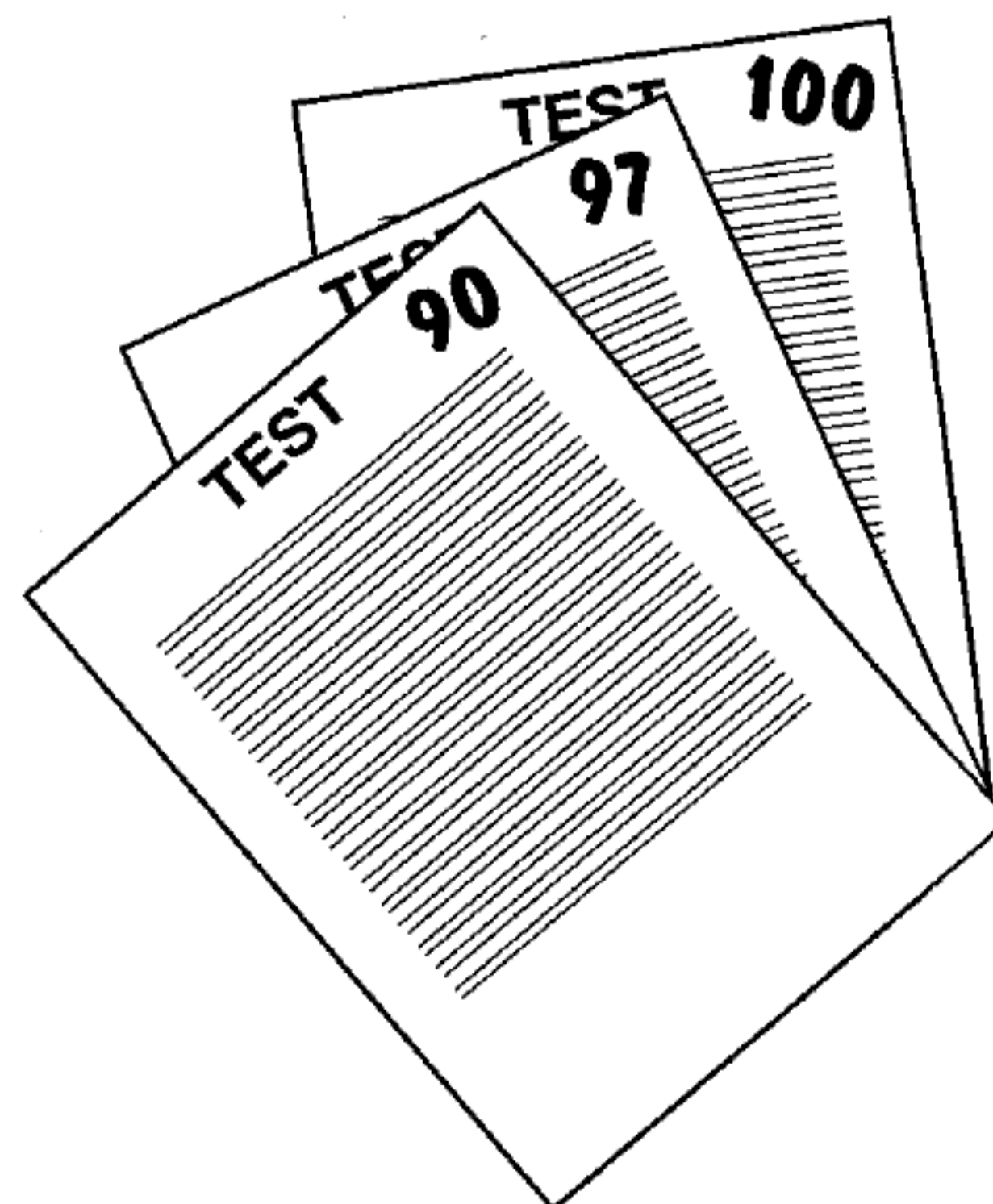

Heart Rates — 1-Variable Statistics

Overview

Students use the statistics functions of the TI-30X IIS calculator to investigate the effect of exercise on heart rate.

Math Concepts

- mean, minimum, maximum, and range

Materials

- TI-30X IIS
- stopwatch or a watch with a second hand
- student activity

Introduction

Students may be placed in smaller groups for this activity to minimize the amount of data to be entered. Ask students:

- *What do you think the average heart rate is for someone your age?*
- *What about after exercising?*

Activity

Have students complete the following investigation to check their estimations.

1. Have students check their resting heart rate by timing their pulse for 1 minute. (You could have them time for 10 seconds and then multiply by 6, but this could be the quietest minute of your day!)
2. Collect data on the chart. Enter each student's heart rate and a mark in the frequency column. As other students have the same heart rate, add another tally mark in the frequency column.
3. Enter the heart rate data into the TI-30X IIS.
 - a. Enter the first heart rate on the chart as the first **X** value, and the number of tallies for that heart rate as the frequency.
 - b. You must press \ominus between entries. For example, enter the first heart rate, and then press \ominus . Enter the first frequency, and then press \ominus .

For example, assume a class of 22 students:

Rate	Students	Rate	Students
60	3	63	3
61	5	64	1
62	6	65	4

1. Press 2nd [STAT] ENTER .
2. Press DATA to enter the heart rates and frequencies.
X1=
3. Enter first heart rate and press \ominus .
FRQ=
4. Enter the first frequency and press \ominus .
5. Continue entering until you have entered all the heart rates and frequencies.

Heart Rates — 1-Variable Statistics (Continued)

4. Check the statistics calculations. After students display Σx (Sigma x), explain that Σx is the sum of all the heart rates. Ask students:

- *How many heartbeats were there in one minute?*
- *Is the average heart rate higher or lower than you expected?*

5. Now we will see the effect of some exercise on heart rate. Tell students:

If at any point during this portion of the activity you experience pain, weakness, or shortness of breath, stop immediately.

6. Have the students run in place for 2 minutes and then give them these instructions:

- Time your pulse for 1 minute.*
- Record your heart rate as before.*
- Enter the data into the calculator.*
- Compare the average heart rate after running with the resting heart rate.*

7. Now have the students do jumping jacks for 2 minutes. Instruct them to time their pulse for 1 minute again and record as before. Have them enter the data into the calculator again and calculate the average heart rate after jumping jacks. Compare to the other 2 averages.

8. How fit is the class? If the class (or individual) heart rate after jumping jacks is less than 90, then you are in great shape. If it is higher than 125, then you are in poor shape.

9. Instruct students to make a histogram of the 3 sets of data they collected. Ask students:

- *How are the histograms the same?*
- *How are they different?*
- *Is the data grouped the same, or is it more spread out in one graph compared to another?*

1. Press $\boxed{\text{STATVAR}}$.

n \bar{x} Sx σx
22.

n should equal the total number of student sampled.

2. Press \blacktriangleright to \bar{x} to see the average heart rate.

n \bar{x} Sx σx
62.

3. Press \blacktriangleright \blacktriangleright \blacktriangleright to Σx .

Σx Σx^2
1370.

Note: The numbers show the results for the example described above. Your students' results will vary depending on the size of group and the heart rate readings.

Heart Rates — 1-Variable Statistics

Name _____

Date _____



Problem

What do you think the average heart rate is for someone your age? What about after exercising?

Procedure

1. Use this table to record your class or group data (resting).

Heartbeats per minute (resting)	Frequency

2. What is the class (group) average? _____
3. What is the total number of heartbeats for the minute? _____

Heart Rates — 1-Variable Statistics

Name _____

Date _____



4. Use this table to record your class or group data (running).

Heartbeats per minute (running)	Frequency

5. What is the class (group) average? _____

6. What is the total number of heartbeats for the minute? _____



Heart Rates — 1-Variable Statistics

Name _____

Date _____



7. Use this table to record your class or group data (jumping).

Heartbeats per minute (jumping)	Frequency

8. What is the class (group) average? _____

9. What is the total number of heartbeats for the minute? _____

10. How fit is the class? _____

Note: If the class (or individual) heart rate after jumping jacks is less than 90, then you are in great shape. If it is higher than 125, then you are in poor shape.

Heart Rates — 1-Variable Statistics

Name _____

Date _____



11. Now make a histogram for each of the 3 sets of data you collected.

Resting

Running

Jumping

12. How are the histograms the same? How are they different? _____

13. Is the data grouped the same or is it more spread out in one graph compared to another? _____

WNBA Stats — 2-Variable Statistics

Overview

Students use WNBA statistics to explore the relationship between 2 variables. They use the TI-30 X IIS to compute the regression equation and evaluate some values.

Math Concepts

- 2-variable statistics

Materials

- TI-30 X IIS
- pencils
- student activity

Activity

Present the following problem to students:

Do you think WNBA (Women's National Basketball Association) playing time (in minutes per game) is related to how many points a player scores? Do you think it is related to how many rebounds a player gets? Or is it related to the player's field goal percentage?

Procedure

1. Put the calculator in **STAT** mode and choose **2-VAR** statistics.
2. Using the table in the activity (page 26), enter the data. Enter points per game as the **X**-variable and minutes per game (playing time) as the **Y**-variable.

1. Press 2nd [STAT] and then 2 .
1-VAR 2-VAR
2. Press ENTER to select **2-VAR**.

1. Press [DATA].
X1=
2. Enter **10.1** (points per game for the first player, Rhonda Mapp).
X1=10.1
3. Press 2 .
Y1=1
4. Enter **21.7** (minutes per game for Rhonda Mapp).
Y1=21.7
5. Press 2 and enter data for the second player.
6. Enter data for each player in the table. Press 2 after entering each data point.

WNBA Stats — 2-Variable Statistics (Continued)

3. Calculate the statistical data.

You may want to fix the decimal to 2 places before doing the statistical calculations.

Ask students:

- *What is the average points scored for the players shown?*
- *What is the average playing time?*
- *What is the total number of points scored per game for all the given players?*

You may want to discuss the other statistical variables and what they mean.

4. The form of the equation is $y = ax + b$. Write the equation for the line of best fit (round to the nearest hundredth).

$$1.56x + 7.02$$

5. The closer the correlation coefficient value is to 1 (or -1), the better the correlation between the two variables. Write the correlation coefficient.

$$r = .91$$

6. Now calculate how many minutes you would expect a player to play if she averages 15 points per game.

1. Press $\boxed{2\text{nd}} \boxed{[FIX]}$.
F0123456789

2. Press **2**.

1. Press $\boxed{[STATVAR]}$.
n \bar{x} Sx σ_x \bar{y}
12.00

2. Press \blacktriangleright to \bar{x} .

n \bar{x} Sx σ_x \bar{y}
9.33

3. Press $\blacktriangleright \blacktriangleright \blacktriangleright$ to \bar{y} .

n \bar{x} Sx σ_x \bar{y}
21.59

4. Press $\blacktriangleright \blacktriangleright \blacktriangleright$ to Σx .

Sy σ_y Σx
112.00

1. Press \blacktriangleright until you get to **a**. This is the slope of the line of best fit.

ΣXY a b r
1.56

2. Press \blacktriangleright to **b**. This is the y-intercept of the line.

ΣXY a b r
7.02

3. Press \blacktriangleright to **r**. This is the correlation coefficient.

ΣXY a b r
0.91

1. Press $\blacktriangleright \blacktriangleright$ to y' .
x' y'

2. Press $\boxed{[ENTER]}$.

3. Type **15** $\boxed{[]}$ and press $\boxed{[ENTER]}$.

y'(15)
30.44

WNBA Stats — 2-Variable Statistics (Continued)

- Now calculate how many points you would expect a player to score if she plays 35 minutes a game.
- Discuss the correlation as a class. Ask students:
 - Are there other factors affecting the players' minutes per game besides points scored?*
 - What about defense, rebounding, etc.?*

Extension

Now have students use the calculator to investigate the correlation of the other data in the chart such as the relation of field goal percentage to minutes per game, or rebounds per game to minutes per game. (Remember, since you have already entered the minutes in **Y**, you only need to enter the new data in **X**.)

Ask students:

Which 2 variables have the closest correlations? (That is, which have the correlation coefficient closest to 1 or -1?)

- Press **STATVAR**.
 $n \bar{x} Sx \sigma x \bar{y}$
12.00
- Press **◀ ▶** to **x'**.
 $x'(y)$
- Press **ENTER**.
- Type **35** **▢** and press **ENTER**.
 $x'(35)$
17.92

WNBA Stats — 2-Variable Statistics

Name _____

Date _____



Problem

Do you think WNBA playing time (in minutes per game) is related to how many points a player scores? Do you think it is related to how many rebounds a player gets? Or is it related to the player's field goal percentage?

Procedure

Use the following table of data to explore the relationships of different pairs of data. Begin by entering the points per game as the X -variable and the minutes per game as the Y -variable.

Player	Field Goal Percentage	Points per Game	Rebounds per Game	Minutes per Game
1. Rhonda Mapp	.506	10.1	4.3	21.7
2. Vicky Bullet	.441	13.3	6.5	31.6
3. Janeth Arcain	.426	6.8	3.6	21.9
4. Cynthia Cooper	.446	22.7	3.7	35
5. Elena Baranova	.420	12.9	9.3	33.6
6. Malgozata Dydek	.482	12.9	7.6	28
7. Heidi Burge	.509	6.7	3.3	16.7
8. Keri Chaconas	.297	4.8	.8	13.2
9. Rebecca Lobo	.484	11.7	6.9	29.2
10. Coquese Washington	.294	1.9	.9	8.1
11. Toni Foster	.467	4.9	1.9	13.6
12. Maria Stepanova	.426	3.3	1.9	6.5

WNBA Stats — 2-Variable Statistics

Name _____

Date _____



Extension

Use the calculator to investigate the correlation of the other data in the table such as the relation of field goal percentage to minutes per game, or rebounds per game to minutes per game. (Remember, since you have already entered the minutes per game in **Y**, you only need to enter the new data in **X**.)

1. What is the average field goal percentage?

2. Write the equation for the line of best fit.

3. Write the correlation coefficient.

4. What is the average number of rebounds per game?

5. Write the equation for the line of best fit.

6. What is the total number of rebounds per game for all the given players?

7. Write the equation for the line of best fit.

8. Write the correlation coefficient.

9. Which 2 variables have the closest correlation? (That is, which have the correlation coefficient closest to 1 or -1 ?)



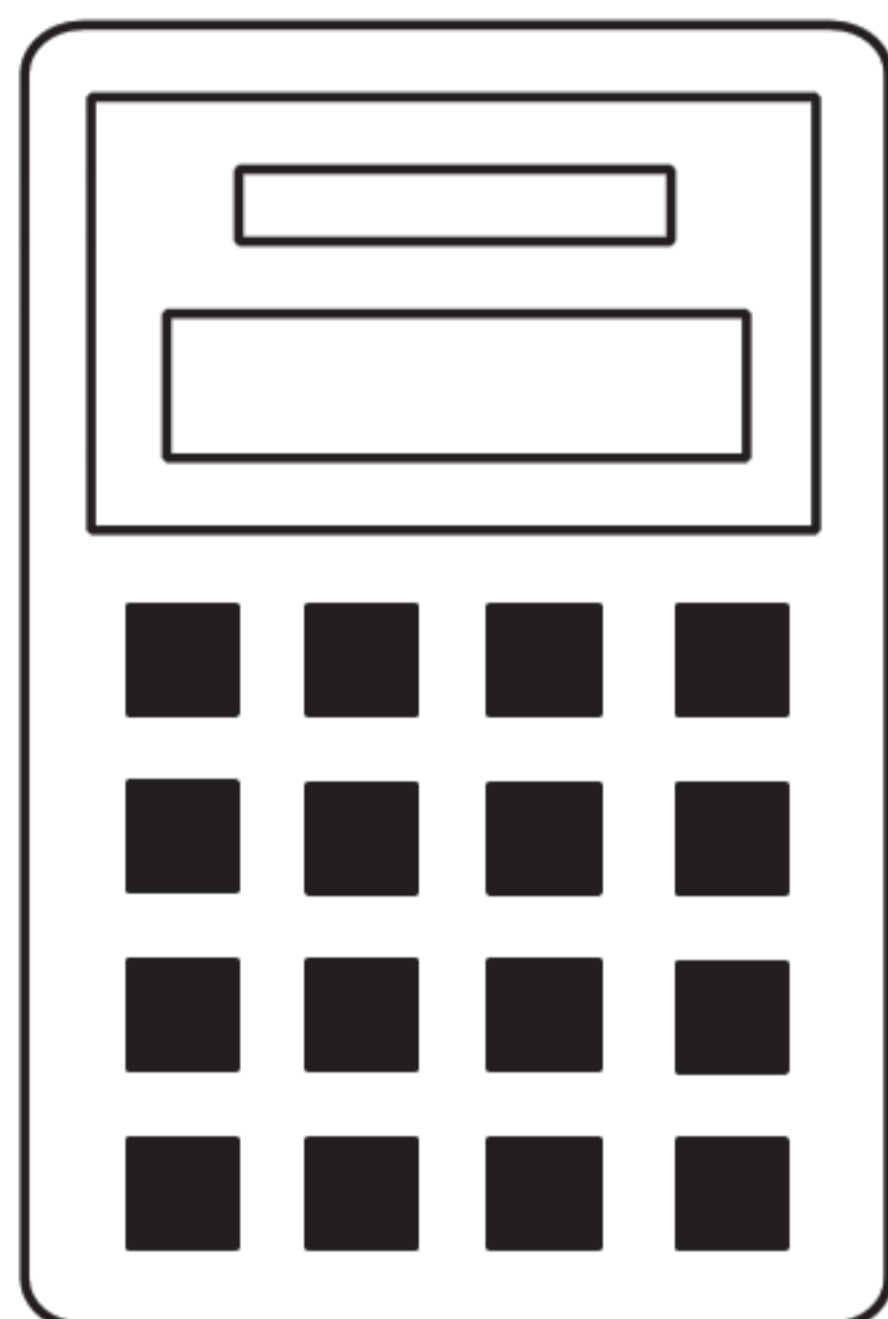

How to Use the TI-30 X IIS

TI-30 X IIS Basic Operations	29
Clear, Insert, and Delete	33
Basic Math	36
Order of Operations and Parentheses	40
Constant	43
Decimals and Decimal Places	45
Memory	47
Fractions	52
Pi	58
Powers, Roots, and Reciprocals	61
Probability	68
Statistics	75
Trigonometry	81
Notation	88
Logarithms and Antilogarithms	91
Angle Settings and Conversions	94
Polar and Rectangular Conversions	98
Hyperbolics	100

Keys

1. **[ON]** turns on the calculator.
2. **[2nd]** turns on the **2nd** indicator and accesses the function shown above the next key you press.
3. **[2nd]** **[OFF]** turns off the calculator and clears the display.
4. **[ENTER]** completes the operation or executes the command.
5. **[2nd]** **[ANS]** recalls the most recently calculated result and displays it as **Ans**.
6. **[←]** and **[→]** move the cursor left and right to scroll the entry line. Press **[2nd]** **[←]** or **[2nd]** **[→]** to scroll to the beginning or end of the entry line.

[↑] and **[↓]** move the cursor up and down through previous entries. **[2nd]** **[↑]** or **[2nd]** **[↓]** scroll to the beginning or end of history.

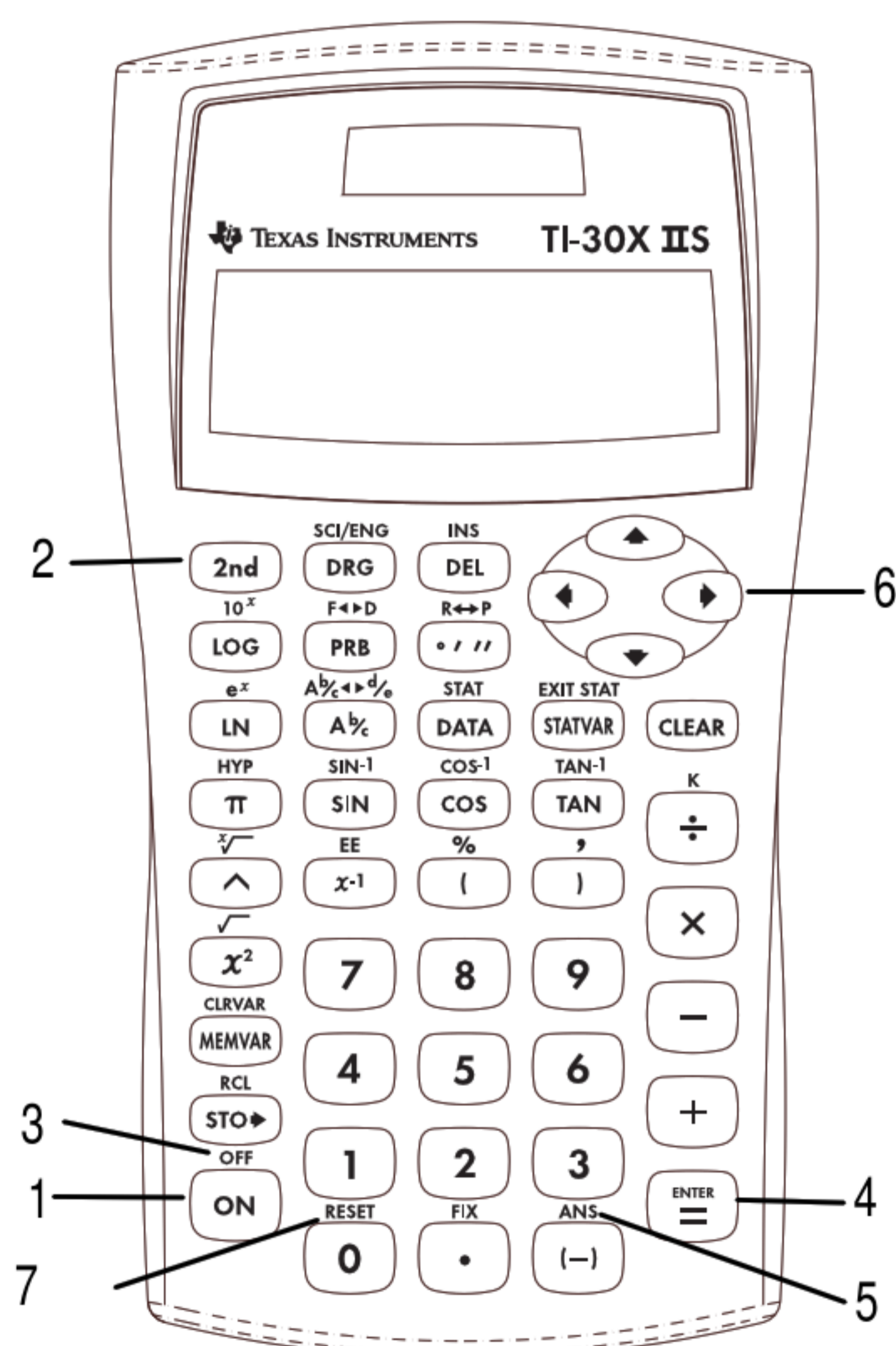

7. **[2nd]** **[RESET]** displays the **RESET** menu.

RESET: N Y

- Press **[ENTER]** when **N** (no) is underlined to return to the previous screen without resetting the calculator.
- Press **[ENTER]** when **Y** (yes) is underlined to reset the calculator. The message **MEM CLEARED** is displayed.

Note: Pressing **[ON]** and **[CLEAR]** **simultaneously** resets the calculator immediately. No menu or message is displayed.

Notes

- The examples on the transparency masters assume all default settings.
- Resetting the calculator:
 - Returns settings to their defaults: floating decimal (standard) notation and degree (**DEG**) mode.
 - Clears memory variables, pending operations, entries in history, statistical data, constants, and **Ans** (Last Answer).
- The entry line can contain up to 88 characters. When **←** or **→** appear in the display, the entry line contains more characters to the left or right. When **↑** or **↓** appear, more characters are located above or below the entry line.
- Press **[ON]** after Automatic Power Down™ (APD™). The display, pending operations, settings, and memory are retained.

Second, Off, Arrows, Equals

Enter 46 - 23. Change 46 to 41. Change 23 to 26 and complete the operation. Enter 81 + 57 and complete the operation. Scroll to see your previous entries.

Press

Display

46 $\boxed{-}$ 23

46-23
DEG

$\leftarrow \leftarrow \leftarrow \leftarrow 1$
 $\rightarrow \rightarrow 6$ $\boxed{=}$

41-26
15.
DEG

81 $\boxed{+}$ 57 $\boxed{=}$

81+57
138.
DEG

$\boxed{2nd}$ $\overset{OFF}{\boxed{ON}}$ \boxed{ON}

\blacksquare
DEG

$\uparrow \uparrow \downarrow$

81+57
DEG

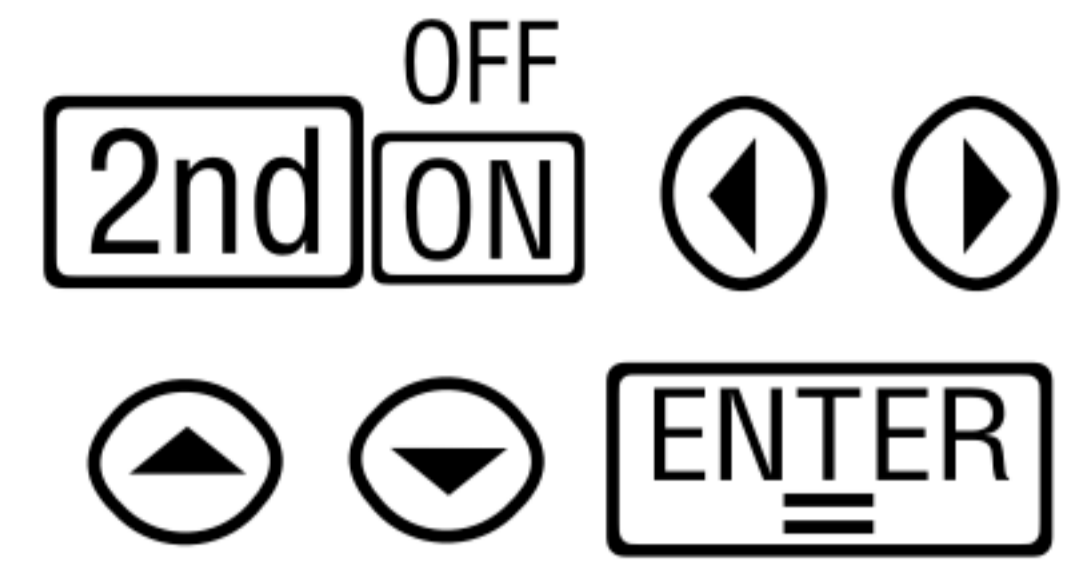

Reset

Reset the calculator.

Press

Display

$\boxed{\text{2nd}}^{\text{RESET}} \boxed{0}$

RESET: N Y

DEG



RESET: N Y

DEG

$\boxed{\text{ENTER}}$

MEM CLEARED

DEG

$\boxed{\text{CLEAR}}$



DEG

Pressing $\boxed{\text{ON}}$ and $\boxed{\text{CLEAR}}$ at the same time also resets the calculator immediately. No menu or message is displayed.

Using $\boxed{\text{2nd}}^{\text{RESET}} \boxed{0}$ or $\boxed{\text{ON}}$ and $\boxed{\text{CLEAR}}$ returns all settings to their defaults and clears the memory.

$\boxed{\text{2nd}}^{\text{RESET}} \boxed{0}$



Last Answer (Ans)

Use Last Answer (**Ans**) to calculate e
 $(2+2)^2$.

Press

Display

2 **+** 2 **ENTER**

2+2 ↑
4.
DEG

2nd ^{ANS}**(-)** **x²**
ENTER

Ans² ↑
16.
DEG

2nd ^{ANS}**(-)**



Keys

1. **[CLEAR]** clears characters and error messages. Once the display is clear, it moves the cursor to the most recent entry.
2. **[2nd] [INS]** lets you insert a character at the cursor.
3. **[DEL]** deletes the character at the cursor. Hold **[DEL]** down to delete all characters to the right. Then, each time you press **[DEL]**, it deletes 1 character to the left of the cursor.

Notes

- The examples on the transparency masters assume all default settings.
- Pressing **[CLEAR]** does not affect the memory, statistical registers, angle units, or numeric notation.

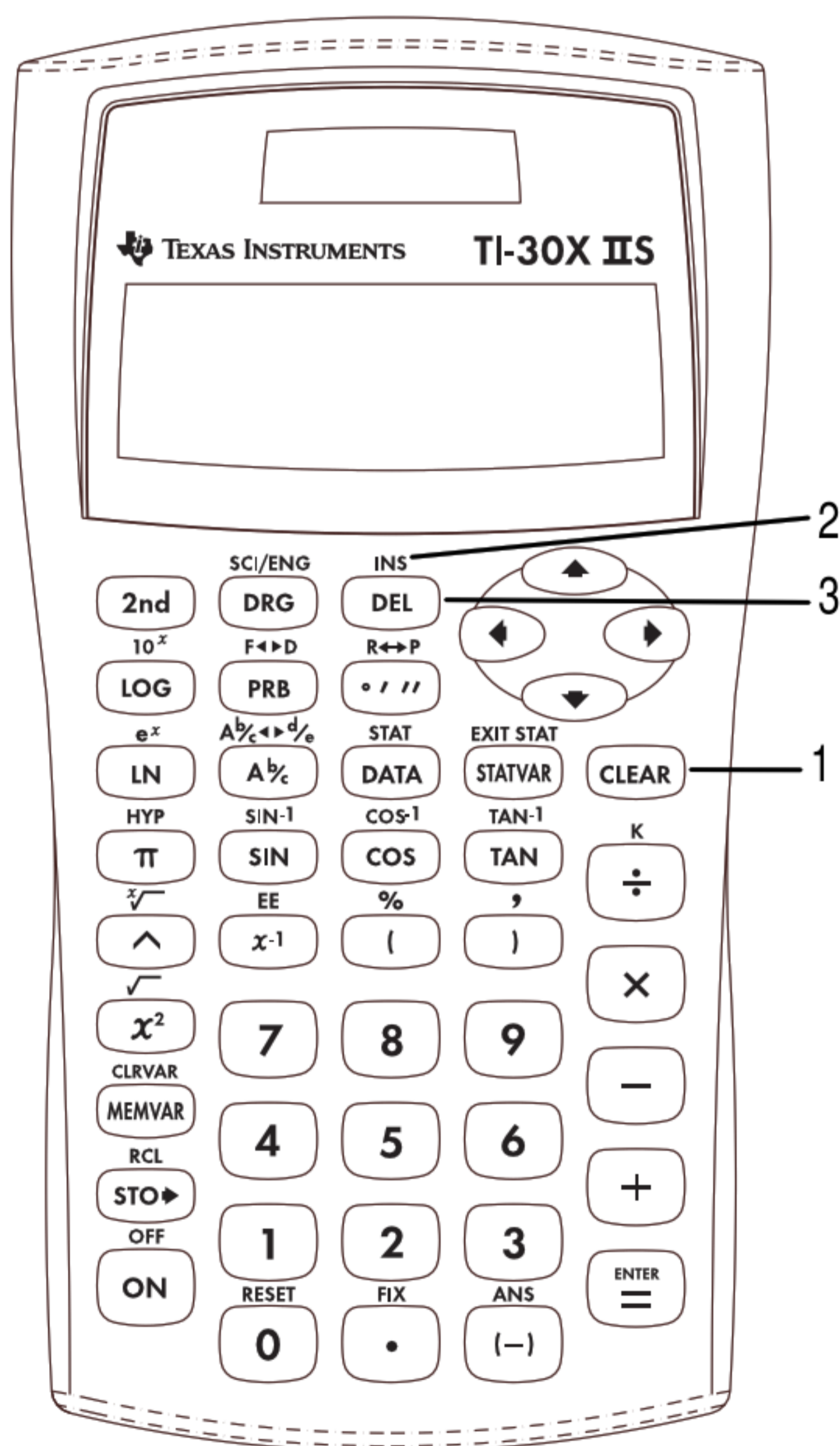

Delete and Insert

Enter $4569 + 285$, and then change it to $459 + 2865$. Complete the problem.

Press	Display
4569 $\boxed{+}$ 285	4569+285 DEG
\leftarrow \leftarrow \leftarrow \leftarrow \leftarrow \leftarrow $\boxed{\text{DEL}}$	459+285 DEG
\rightarrow \rightarrow \rightarrow \rightarrow $\boxed{\text{2nd}} \overset{\text{INS}}{\boxed{\text{DEL}}} 6$	459+2865 DEG
$\boxed{\text{ENTER}}$	459+2865 \uparrow 3324. DEG

$\boxed{\text{DEL}}$ $\boxed{\text{2nd}} \overset{\text{INS}}{\boxed{\text{DEL}}}$



Clear

Enter 21595.
 Clear the 95.
 Clear the entry.

CLEAR

Press Display

21595

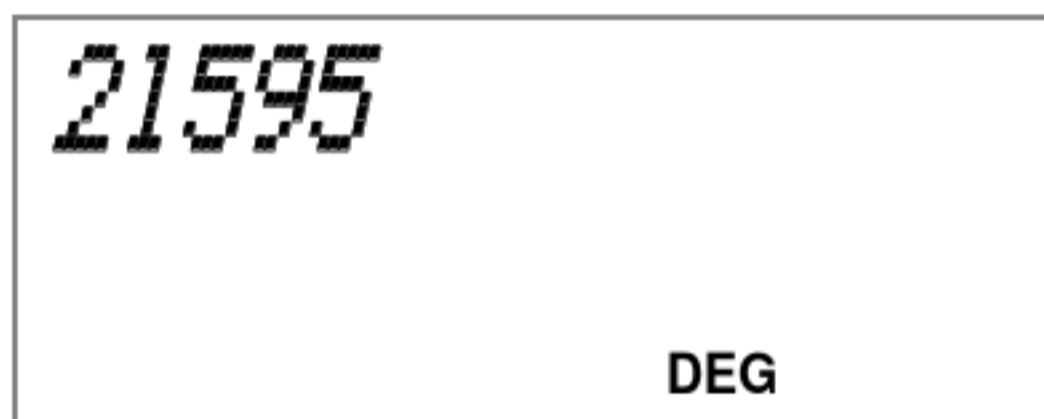

◀ ◀ **CLEAR**
 (Clear to right)



CLEAR
 (Clear entry)



Keys

1. $\boxed{+}$ adds.
2. $\boxed{-}$ subtracts.
3. $\boxed{\times}$ multiplies.
4. $\boxed{\div}$ divides.
5. $\boxed{\text{ENTER}}$ completes the operation or executes the command.
6. $\boxed{(-)}$ lets you enter a negative number.
7. $\boxed{2\text{nd}} \boxed{\%}$ changes a real number to a percent.

Notes

- The examples on the transparency masters assume all default settings.
- The TI-30XIIS allows implied multiplication.
Example: $3(4+3) = 21$
- Do not confuse $\boxed{(-)}$ with $\boxed{-}$. $\boxed{-}$ allows subtraction.
- Results of percent calculations display according to the decimal notation mode setting.

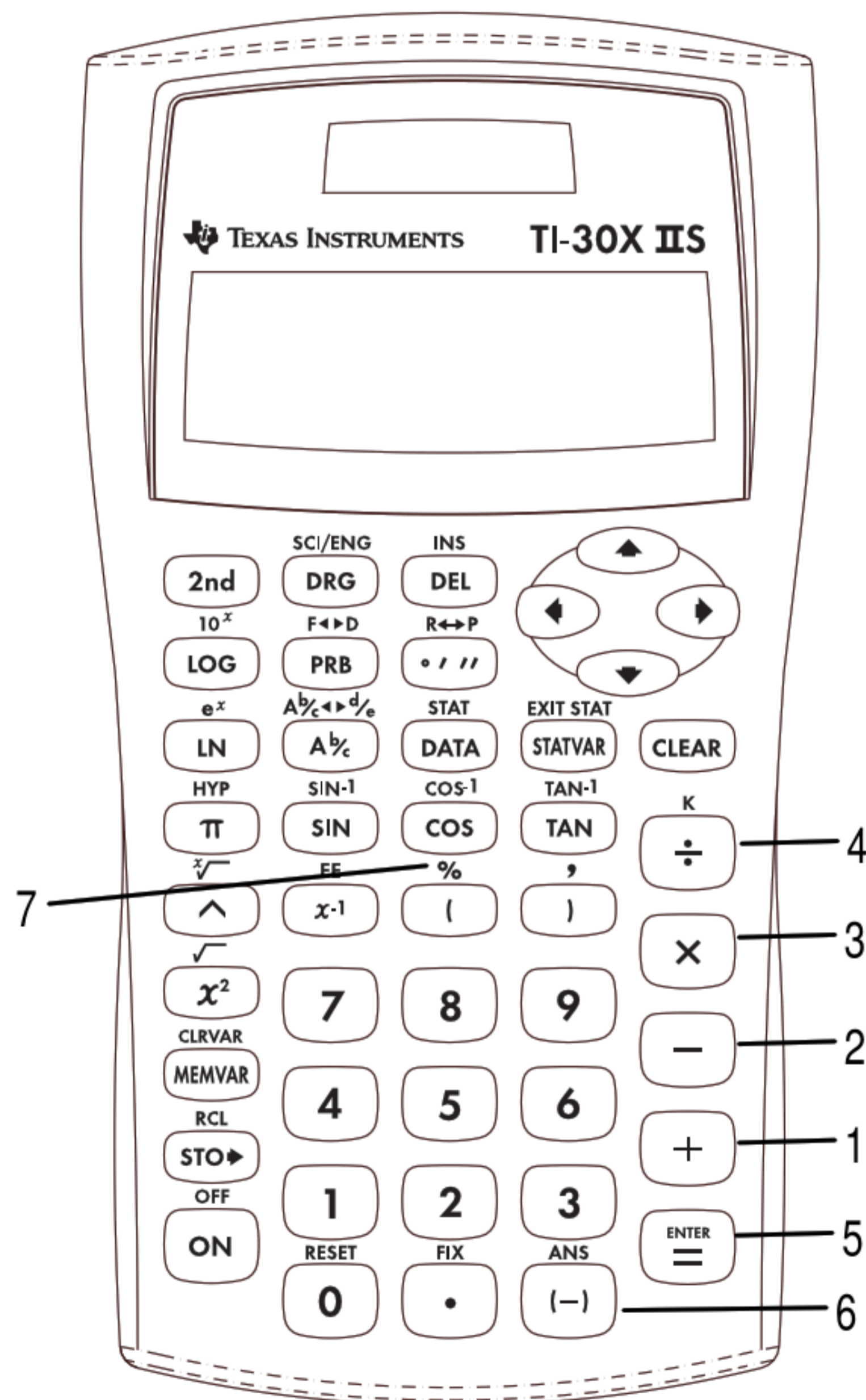

Add, Subtract, Multiply, Divide, Equals

Find: $2 + 54 - 6 =$
 $16 \times 21 =$
 $78 \div 2 =$
 $12 \times (5 + 6) =$

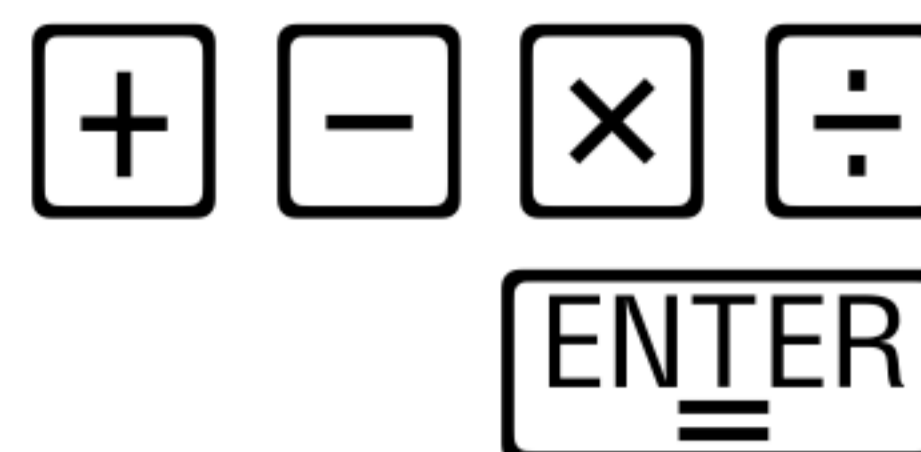

Press

Display

2 $\boxed{+}$ 54 $\boxed{-}$ 6

$\boxed{\text{ENTER}}$

2+54-6 ↑
50.
 DEG

16 $\boxed{\times}$ 21 $\boxed{\text{ENTER}}$

*16*21* ↑
336.
 DEG

78 $\boxed{\div}$ 2 $\boxed{\text{ENTER}}$

78/2 ↑
39.
 DEG

12 $\boxed{\times}$ $\boxed{(}$ 5 $\boxed{+}$

6 $\boxed{)}$ $\boxed{\text{ENTER}}$

12(5+6)* ↑
132.
 DEG

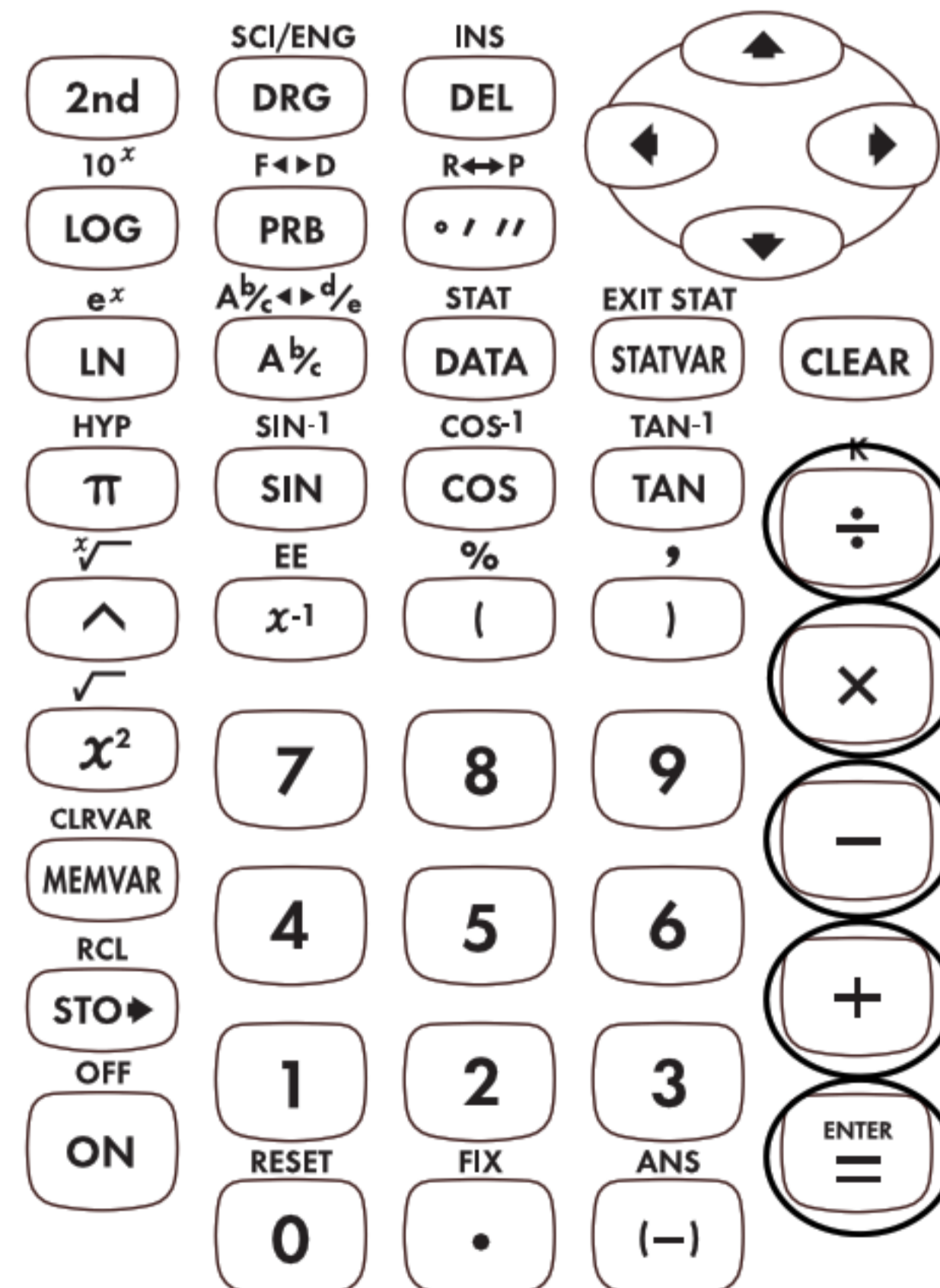

Negative Numbers

The temperature in Utah was -3°C at 6:00 a.m. By 10:00 a.m. the temperature had risen 12°C . What was the temperature at 10:00 a.m.?

Press

Display

$(-)$ 3 $+$ 12

$\underline{\underline{\text{ENTER}}}$

$-3+12$ †
9.
DEG

$(-)$

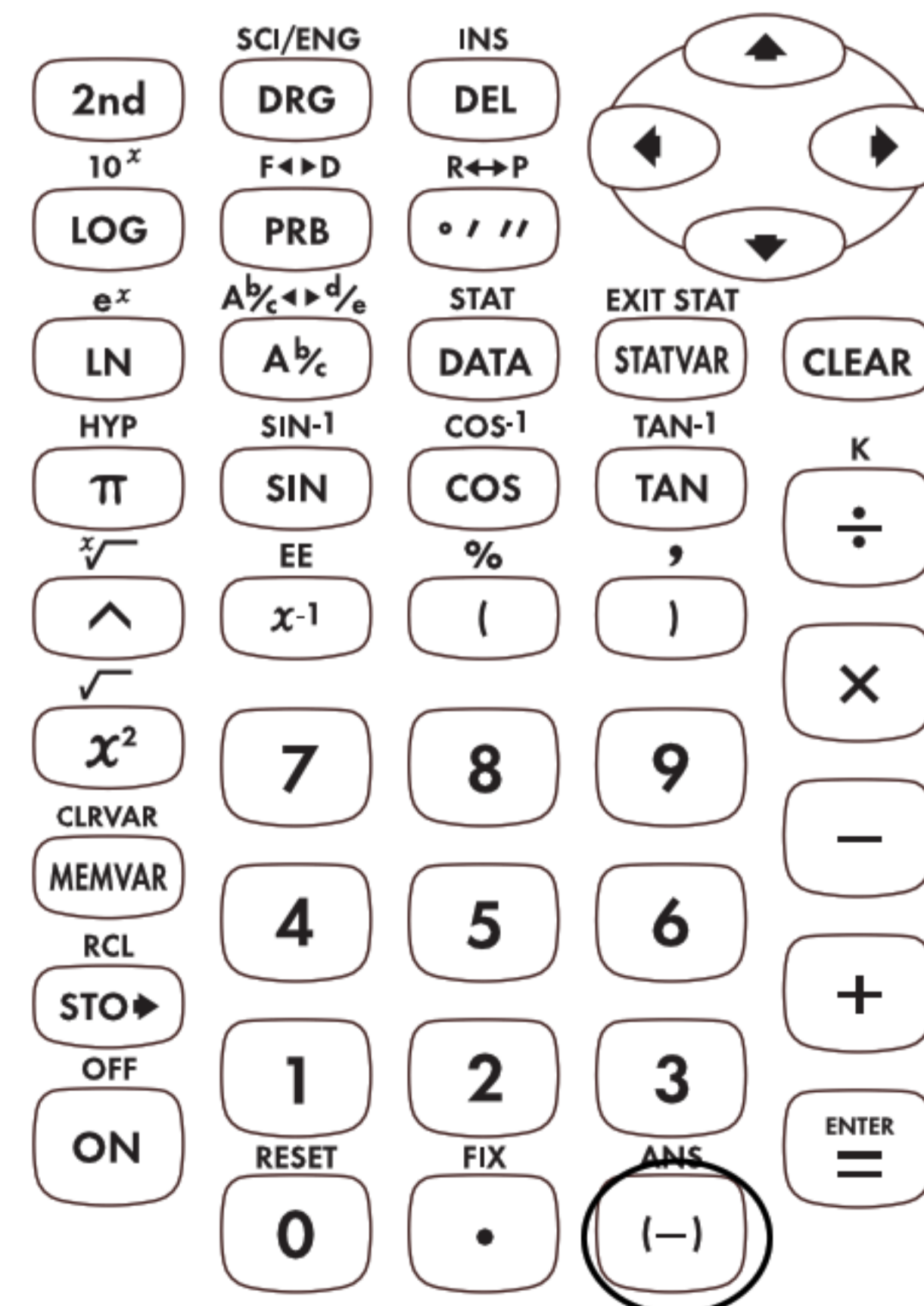

Percent

Mike makes \$80 per week. He saves 15% of his earnings. How much does Mike save per week?

Press

Display

15

15
DEG

$\boxed{2^{nd}}$ $\boxed{\%}$ $\boxed{\times}$ 80
 $\boxed{=}$

15%*80
12.
DEG

$\boxed{2^{nd}}$ $\boxed{\%}$



Order of Operations and Parent heses

4

Keys

1. () opens a parent het ical expression.
2.) closes a parent het ical expression.

Notes

- The examples on the transparency masters assume all default settings.
- The transparency master showing the Equation Operating System (EOS™) demonstrates the order in which the TI-30XIIS completes calculations.
- Operations inside parent heses are performed first. Use () to change the order of operations and, therefore, change the result.

Example: $1 + 2 \times 3 = 7$
 $(1 + 2) \times 3 = 9$

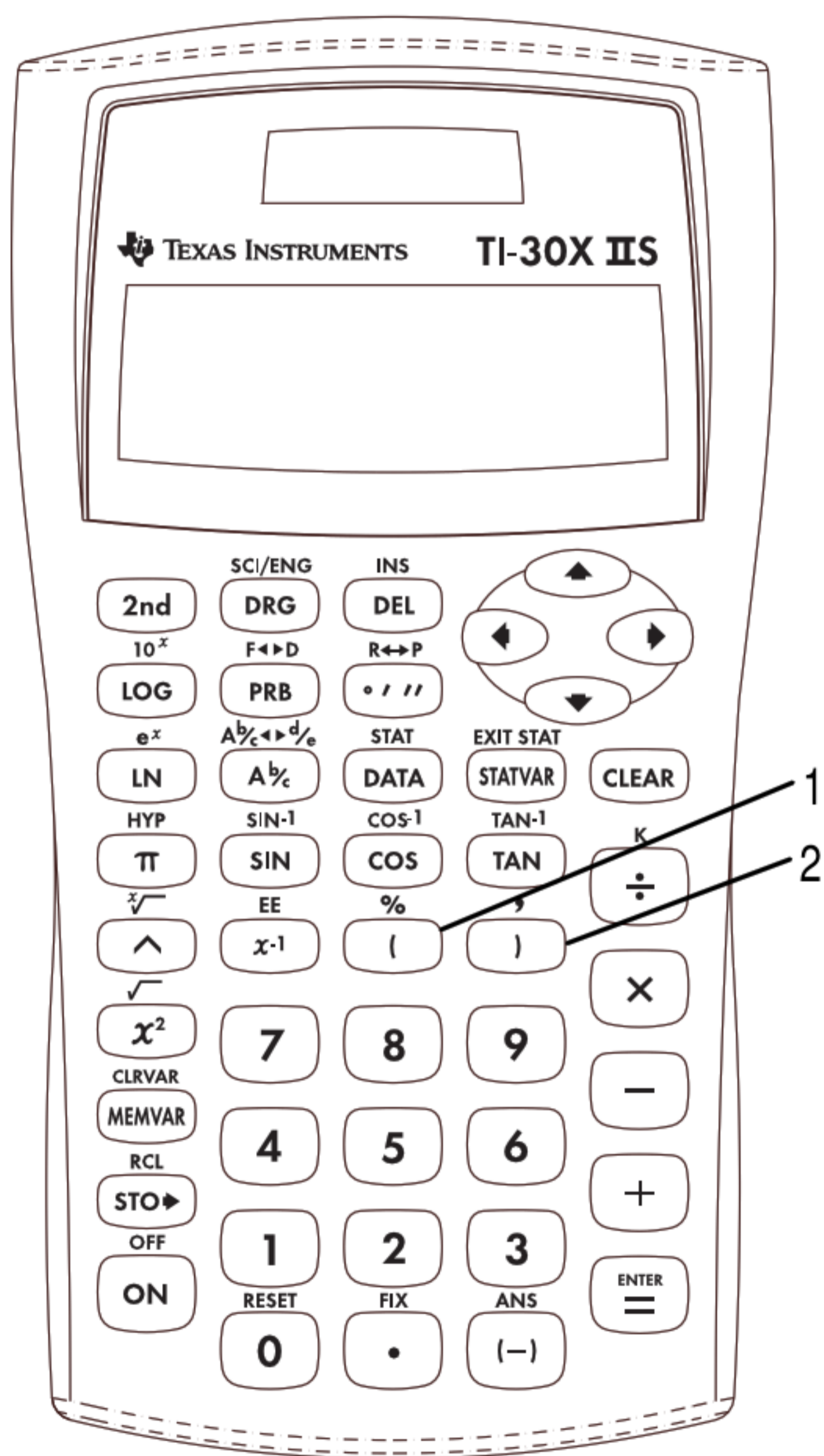

1 (first)	Expressions inside ()
2	Functions that need a) and precede the expression, such as the [SIN], [LOG], or [2nd] ^{R↔P} [0, //] menu items
3	Functions entered after the expression, such as [x ²] and angle unit modifiers (°, ', ", r, g)
4	Fractions
5	Exponentiation (^) and roots ([2nd] ^{x√} [^])
6	Negation ([-])
7	Permutations (nPr) and combinations (nCr)
8	Multiplication, implied multiplication, and division
9	Addition and subtraction
10	Conversions ([2nd] ^{Ab/c↔d/e} [Ab/c], [2nd] ^{F↔D} [PRB], and ► DMS)
11 (last)	[ENTER] completes all operations and closes all open parentheses.

Order of Operations

$$1 + 2 \times 3 =$$

Press

1 $\boxed{+}$ 2 $\boxed{\times}$ 3
 $\boxed{\text{ENTER}}$

Display

$1+2*3$ ↑
7.
 DEG

$$(1 + 2) \times 3 =$$

Press

$\boxed{(}$ 1 $\boxed{+}$ 2 $\boxed{)}$ $\boxed{\times}$
 3 $\boxed{\text{ENTER}}$

Display

$(1+2)*3$ ↑
9.
 DEG

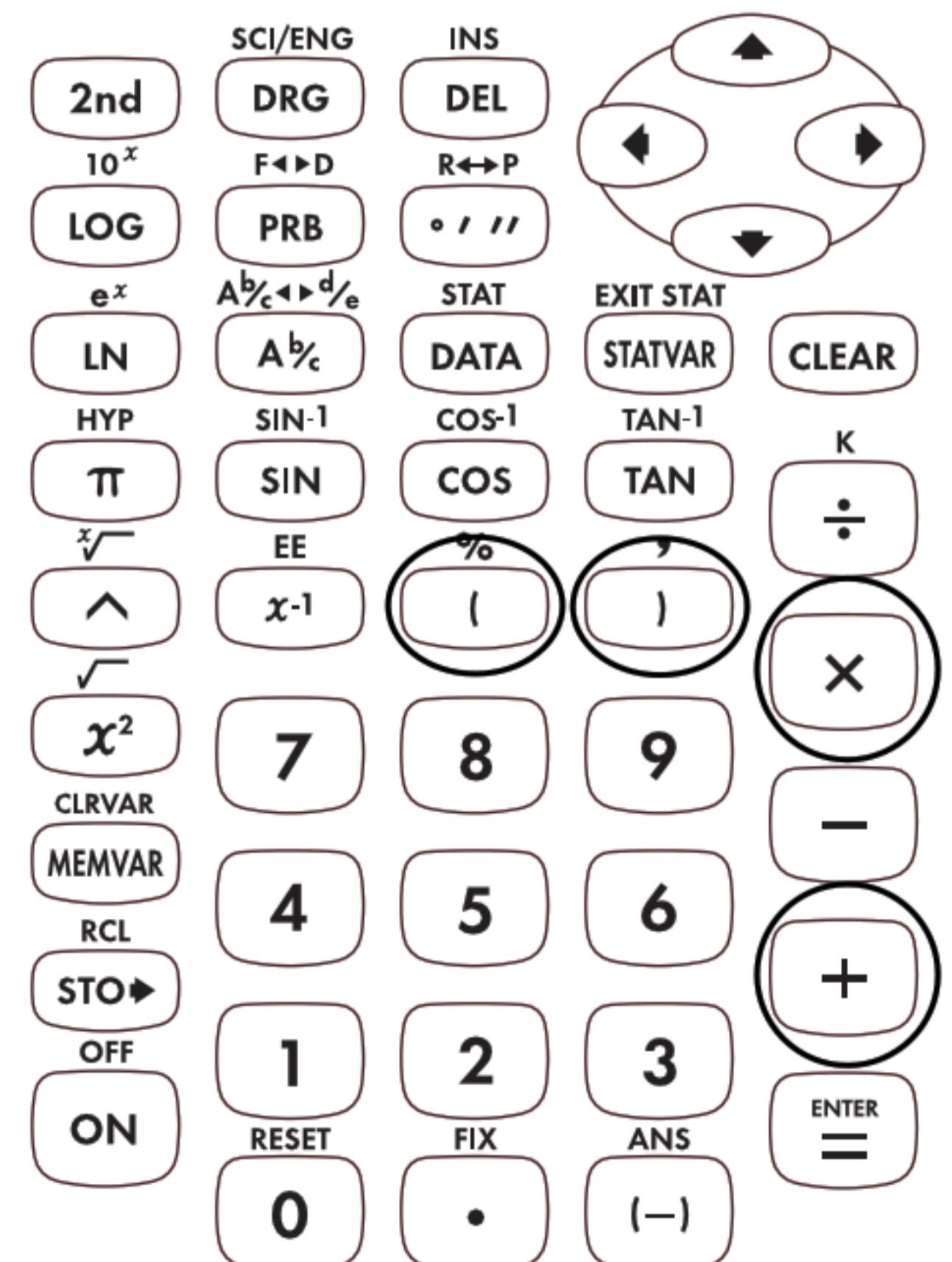

Keys

1. $\boxed{2\text{nd}} \boxed{K}$ turns on the constant mode and lets you define a constant. A **K** displays when the constant mode is on.
2. $\boxed{\text{ENTER}}$ places the contents of **K** at the end of the expression in the display.

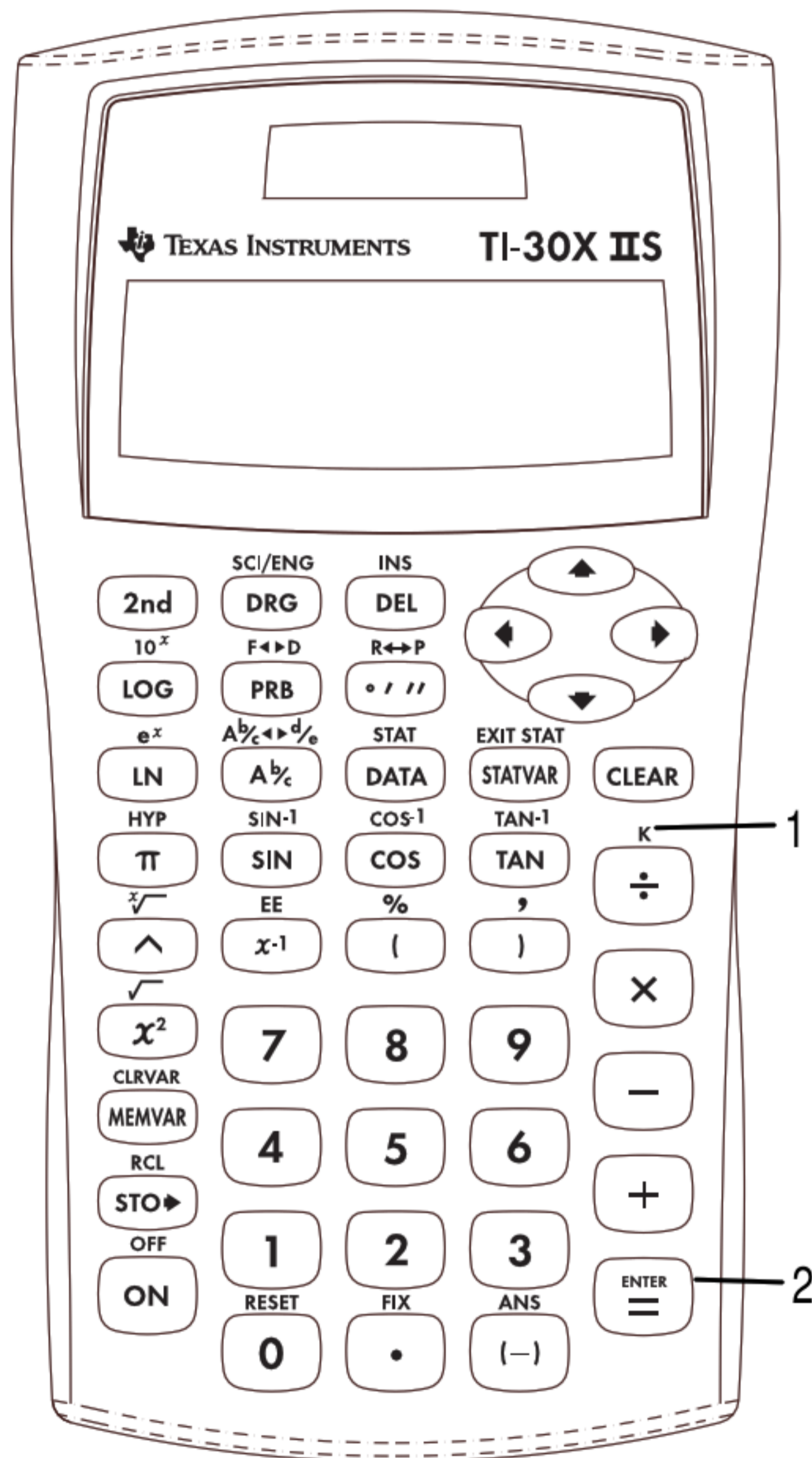

Notes

- The examples on the transparency masters assume all default settings.
- All functions, except statistics, work in constant mode.
- To enter a constant:
 1. Press $\boxed{2\text{nd}} \boxed{K}$. If a constant is already stored, press $\boxed{\text{CLEAR}}$ to clear it.
 2. Enter your constant (any set of operations, functions, and values).
 3. Press $\boxed{\text{ENTER}}$ to turn on the constant mode. **K** appears in the display.
 4. Press $\boxed{\text{CLEAR}}$ to clear the display.
 5. Enter an initial value. If you do not enter a value, 0 is assumed, and **Ans** will appear in the display.
 6. Press $\boxed{\text{ENTER}}$ to place the contents of **K** at the end of the expression and evaluate it.
 7. Continue pressing $\boxed{\text{ENTER}}$ to repeat the constant.

The result is stored in **Ans**, which is displayed, and the constant is used to evaluate the new expression.

Constant

Three people babysit for \$3.25 each per hour. First person works 16 hours. Second person works 12 hours. Third person works 17 hours. How much did each person earn?

Press

Display

$\boxed{2\text{nd}} \overset{\text{K}}{\boxed{\div}}$

$K =$
DEG

$\boxed{\times} 3.25 \boxed{\text{ENTER}}$

$K = *3.25$
DEG K

$\boxed{\text{CLEAR}}$

\blacksquare ↑
DEG K

16 $\boxed{\text{ENTER}}$

$16*3.25$ ↑
52.
DEG K

12 $\boxed{\text{ENTER}}$

$12*3.25$ ↑
39.
DEG K

17 $\boxed{\text{ENTER}}$

$17*3.25$ ↑
55.25
DEG K

$\boxed{2\text{nd}} \overset{\text{K}}{\boxed{\div}}$

\blacksquare ↑
DEG K

(Constant mode is off.)

$\overset{\text{K}}{\boxed{2\text{nd}} \boxed{\div}}$



Keys

1. \cdot enters a decimal point.
2. 2^{nd} [FIX] displays the following menu, which lets you set the number of decimal places.

F 0 1 2 3 4 5 6 7 8 9

F Sets floating decimal (standard) notation.

0-9 Sets the number of decimal places.

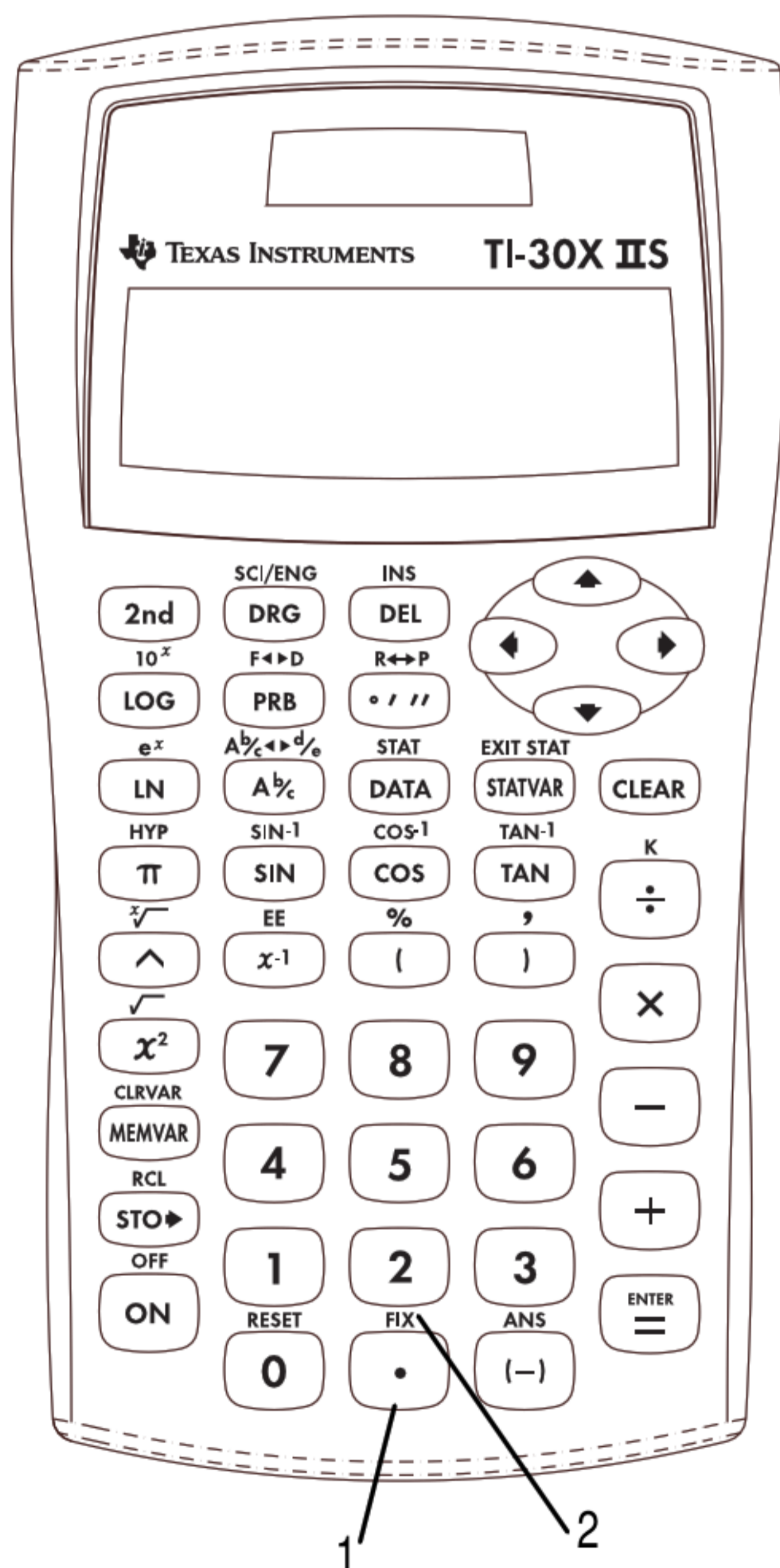

Notes

- The examples on the transparency masters assume all default settings.
- 2^{nd} [FIX] \cdot removes the setting and returns to standard notation (floating decimal).
- The **FIX** setting affects all decimal results and the mantissa of scientific and engineering notation results.
- The TI-30X IIS automatically rounds the result to the number of decimal places selected. For example, when the decimal is set to 2 places, 0.147 becomes 0.15 when you press $\overline{\text{ENTER}}$. The TI-30X IIS also rounds or pads resulting values with trailing zeros to fit the selected setting. For example, when the decimal is set to 5 places, 0.147 becomes 0.14700 when you press $\overline{\text{ENTER}}$.
- All results are displayed to the **FIX** setting until you clear the setting by either pressing 2^{nd} [FIX] \cdot or selecting **F** (floating) on the decimal notation menu. Resetting the calculator also clears the **FIX** setting.
- After pressing 2^{nd} [FIX], you can select the number of decimal places in 2 ways:
 - Press \leftarrow or \rightarrow to move to the number of decimal places you want, and then press $\overline{\text{ENTER}}$, or
 - Press the number key that corresponds to the number of decimal places you want.
- **FIX** affects only the results, not the entry.

Decimal, FIX

Round 12.345 to the hundredths place, to the tenths place, and then cancel the **FIX** setting.

Press

Display

12 \square . 345

12.345

DEG

\square ^{FIX}
2nd \square .

F0123456789

DEG

\blacktriangleright \blacktriangleright \blacktriangleright

F0123456789

DEG

ENTER

12.345

FIX DEG

ENTER

12.345

12.35

FIX DEG

\square ^{FIX}
2nd \square . 1

12.345

12.3

FIX DEG

\square ^{FIX}
2nd \square . \square

12.345

12.345

DEG

\square \square ^{FIX}
2nd \square .

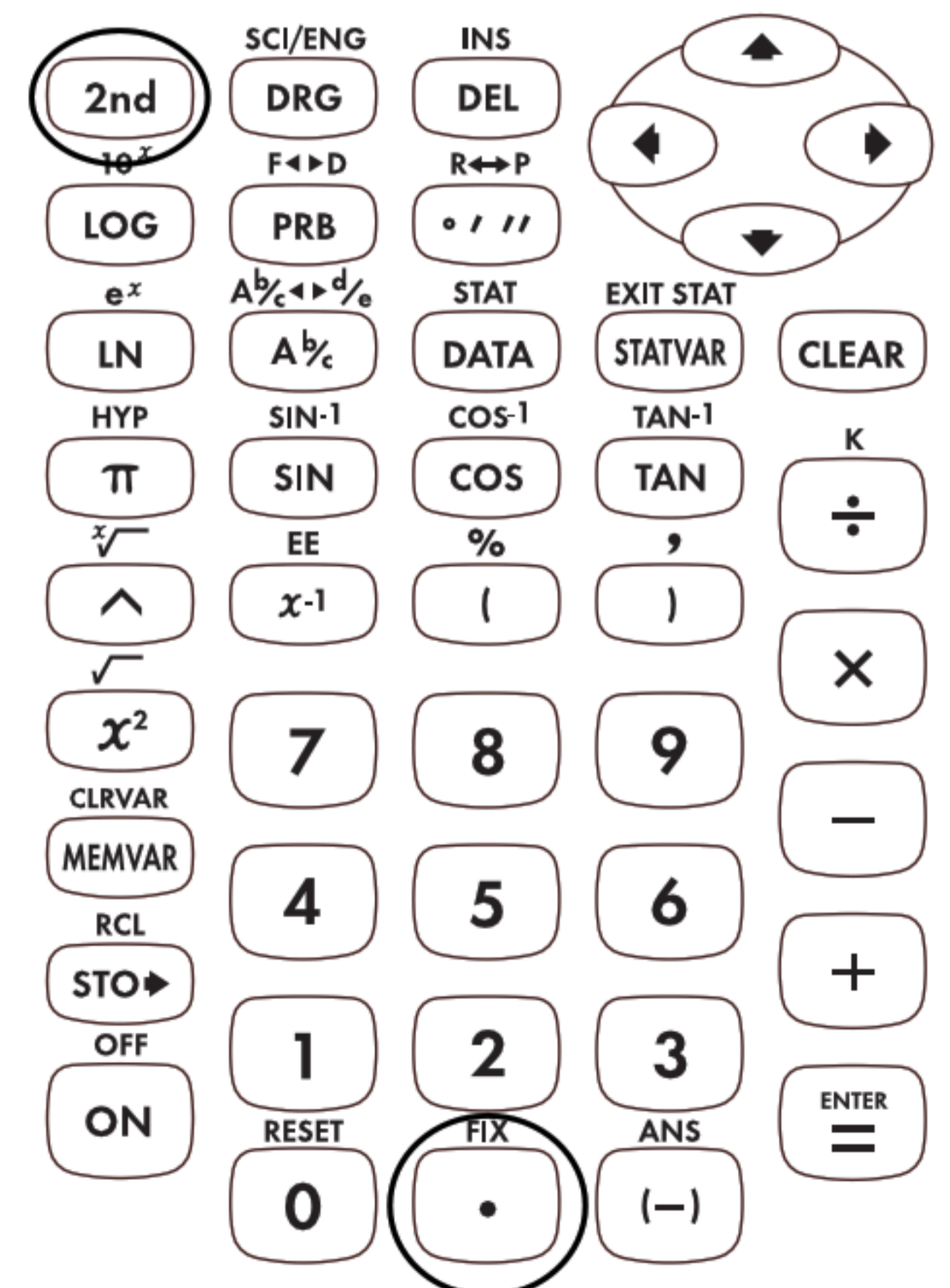

Keys

1. **[STO▶]** displays the following menu of variables.

A B C D E Lets you select a variable in which to store the displayed value. The new variable replaces any previously stored value.

rand Lets you set a seed value for random integers.

2. **[MEMVAR]** displays the following menu of variables.

A B C D E Lets you view the stored value before pasting it in variable form to the display.

3. **[2nd] [CLRVAR]** clears all variables.

4. **[2nd] [RCL]** displays the following menu of variables.

A B C D E Lets you view the stored value before pasting it to the display.

Notes

- The examples on the transparency masters assume all default settings.
- You can store a real number or an expression that results in a real number to a memory variable.

- When you select a variable using **[MEMVAR]**, the variable name (**A**, **B**, **C**, **D**, or **E**) is displayed on the entry line.

When you select a variable using **[2nd] [RCL]**, the value of the stored variable is displayed on the entry line.

- Resetting the calculator clears all memory variables.
- For more about **rand**, see Chapter 11, Probability (page 68).

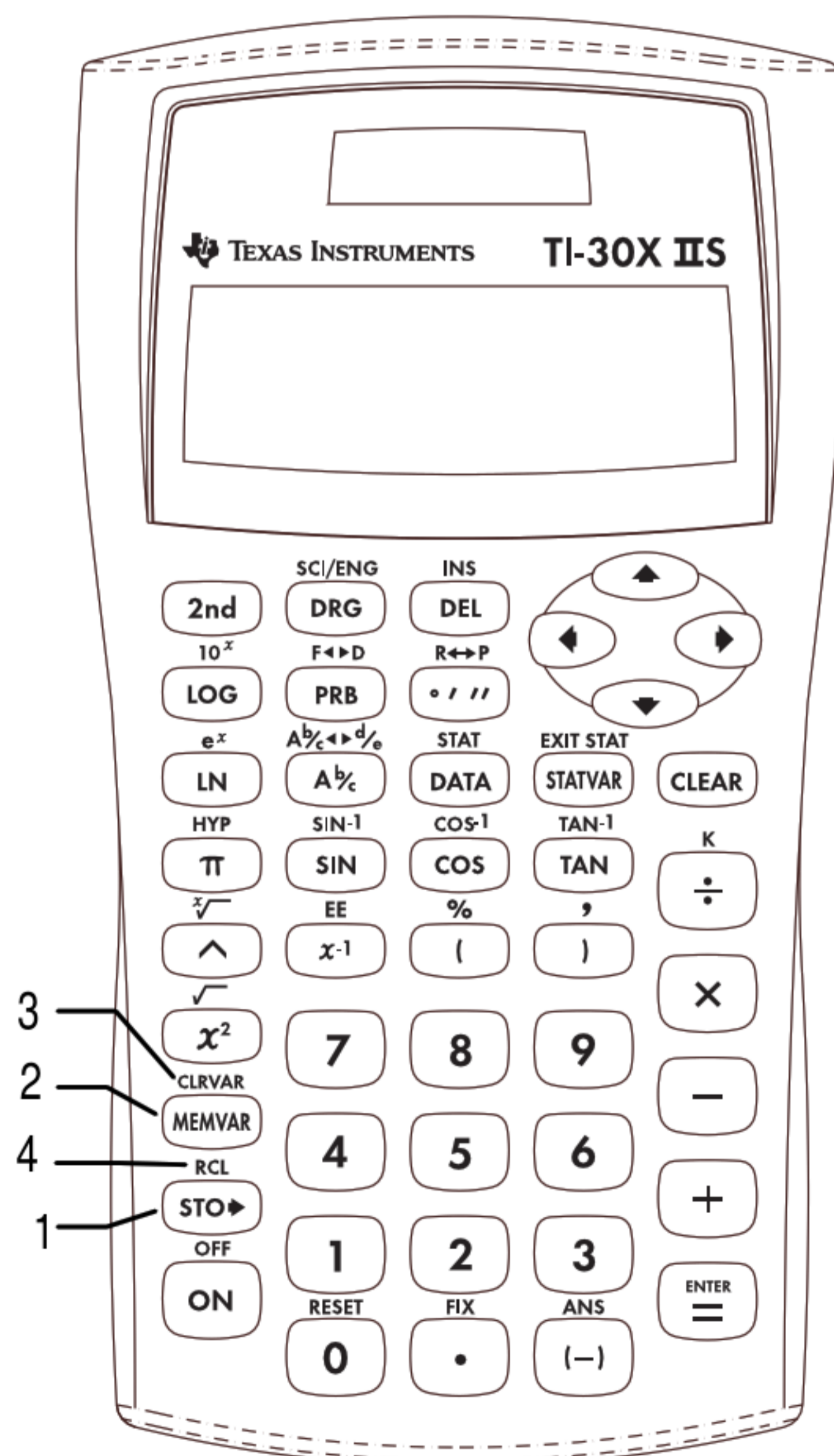

Store, Memory Variable, Clear Variable

Test scores: 96, 76, 85.

Weekly scores: 92, 83, 97, and 86.

Find the average of test and weekly scores. Find the final average.

Press

Display

96 $+$ 76 $+$
85 $\underline{\underline{ENTER}}$

96+76+85 ↑
257.
DEG

\div 3 $\underline{\underline{ENTER}}$

Ans/3 ↑
85.66666667
DEG

$\text{STO} \blacktriangleright$ $\underline{\underline{ENTER}}$

Ans \rightarrow A ↑
85.66666667
DEG

92 $+$ 83 $+$
97 $+$ 86 $\underline{\underline{ENTER}}$

92+83+97+86 ↑
358.
DEG

\div 4 $\underline{\underline{ENTER}}$

Ans/4 ↑
89.5
DEG

$+$ MEMVAR
 $\underline{\underline{ENTER}}$ $\underline{\underline{ENTER}}$

Ans+A ↑
175.16666667
DEG

\div 2 $\underline{\underline{ENTER}}$

Ans/2 ↑
87.58333333
DEG

$\text{STO} \blacktriangleright$ MEMVAR

2nd CLRVAR
 MEMVAR

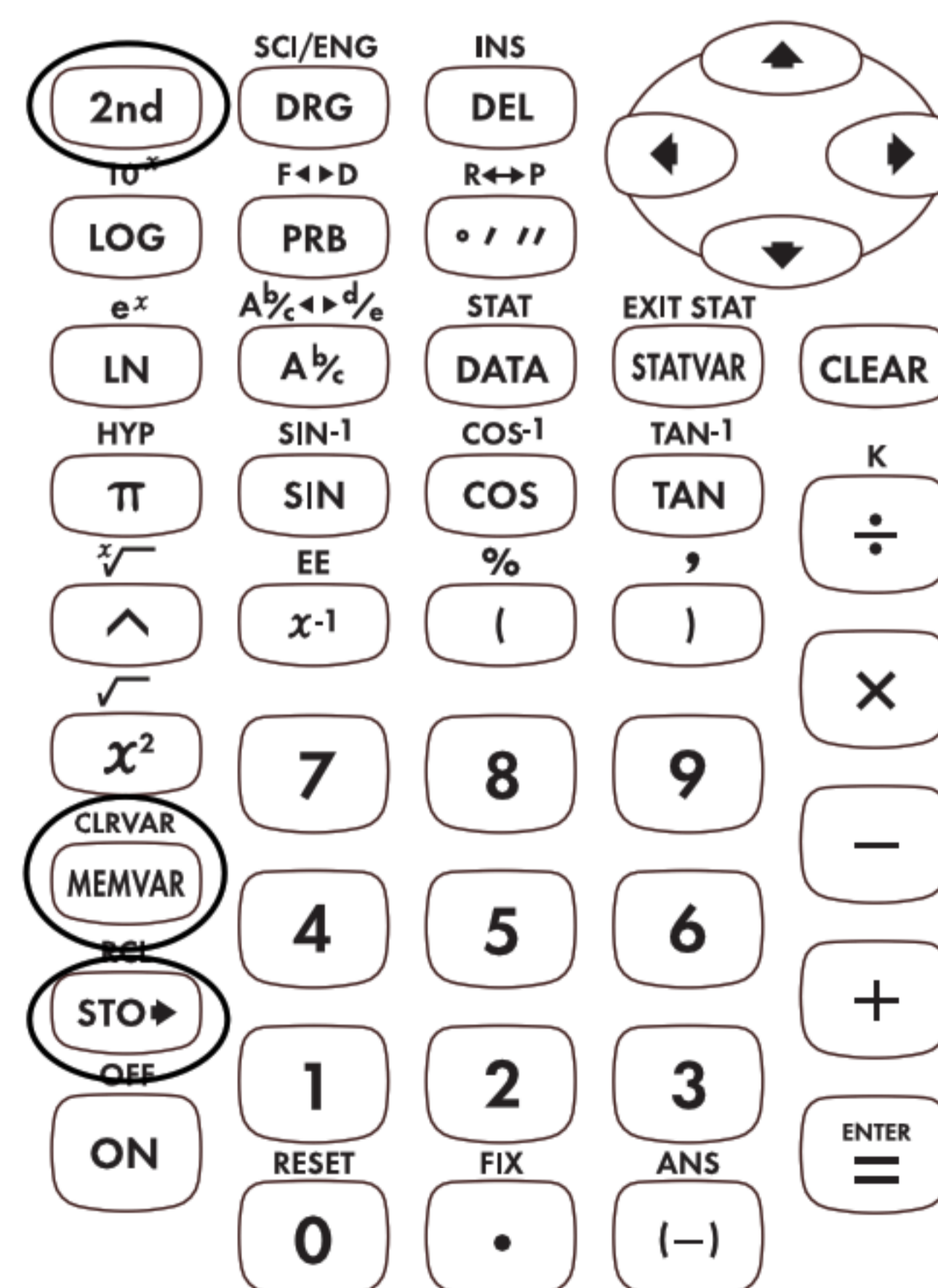

Store, Recall

Which would be the better buy:
3 cassette tapes for \$7.98, or
4 cassette tapes for \$9.48?

Press

Display

7 \square . \square 9 8 \square \div 3

\square ENTER

7.98/3
2.66
DEG

\square STO \square ENTER

Ans \rightarrow A
2.66
DEG

9 \square . \square 4 8 \square \div 4

\square ENTER

9.48 / 4
2.37
DEG

\square STO \square \square ENTER

Ans \rightarrow B
2.37
DEG

View the first price again.

RCL
 \square 2nd \square STO \square

A B C D E
2.66
DEG

View the second price again.

\square

A B C D E
2.37
DEG

STO \square
RCL
 \square 2nd \square STO \square



Store, Recall

Shop	Purchases	Qty	Cost
A	shirts	2	\$13.98 ea.
B	ties	3	\$7.98 ea.
C	belt	1	\$6.98
	suspenders	1	\$9.98

How much did you spend at each shop, and how much did you spend altogether?

Press

Display

2 \times 13 \cdot 98

ENTER

2*13.98 ↑
27.96
DEG

$\text{STO} \blacktriangleright$

→ A B C D E →
DEG

ENTER

Ans → A ↑
27.96
DEG

3 \times 7 \cdot 98

ENTER

3*7.98 ↑
23.94
DEG

Continued

$\text{STO} \blacktriangleright$

RCL
 $\text{2nd} \text{STO} \blacktriangleright$



Store, Recall (Continued)

Press	Display
$\boxed{\text{STO}\blacktriangleright} \blacktriangleright \boxed{\text{ENTER}}$	$\text{Ans}\rightarrow\text{B}$ 23.94 DEG
$6 \boxed{\cdot} 98 \boxed{+}$ $9 \boxed{\cdot} 98 \boxed{\text{ENTER}}$	$6.98+9.98$ 16.96 DEG
$\boxed{\text{STO}\blacktriangleright} \blacktriangleright \blacktriangleright$ $\boxed{\text{ENTER}}$	$\text{Ans}\rightarrow\text{C}$ 16.96 DEG
$\boxed{\text{2nd}} \text{RCL} \boxed{\text{STO}\blacktriangleright}$ $\boxed{\text{ENTER}} \boxed{+}$	$27.96+$ DEG
$\boxed{\text{2nd}} \text{RCL} \boxed{\text{STO}\blacktriangleright} \blacktriangleright$ $\boxed{\text{ENTER}} \boxed{+}$	$\leftarrow .96+23.94+$ DEG
$\boxed{\text{2nd}} \text{RCL} \boxed{\text{STO}\blacktriangleright} \blacktriangleright \blacktriangleright$ $\boxed{\text{ENTER}} \boxed{\text{ENTER}}$	$27.96+23.94 \rightarrow$ 68.86 DEG

$\boxed{\text{STO}\blacktriangleright}$
RCL
 $\boxed{\text{2nd}} \boxed{\text{STO}\blacktriangleright}$



Keys

1. $\boxed{A\frac{b}{c}}$ lets you enter mixed numbers and fractions.
2. $\boxed{2nd} \boxed{A\frac{b}{c} \leftrightarrow d/e}$ converts a simple fraction to a mixed number or a mixed number to a simple fraction.
3. $\boxed{2nd} \boxed{F \leftrightarrow D}$ converts a fraction to its decimal equivalent or changes a decimal to its fractional equivalent, if possible.

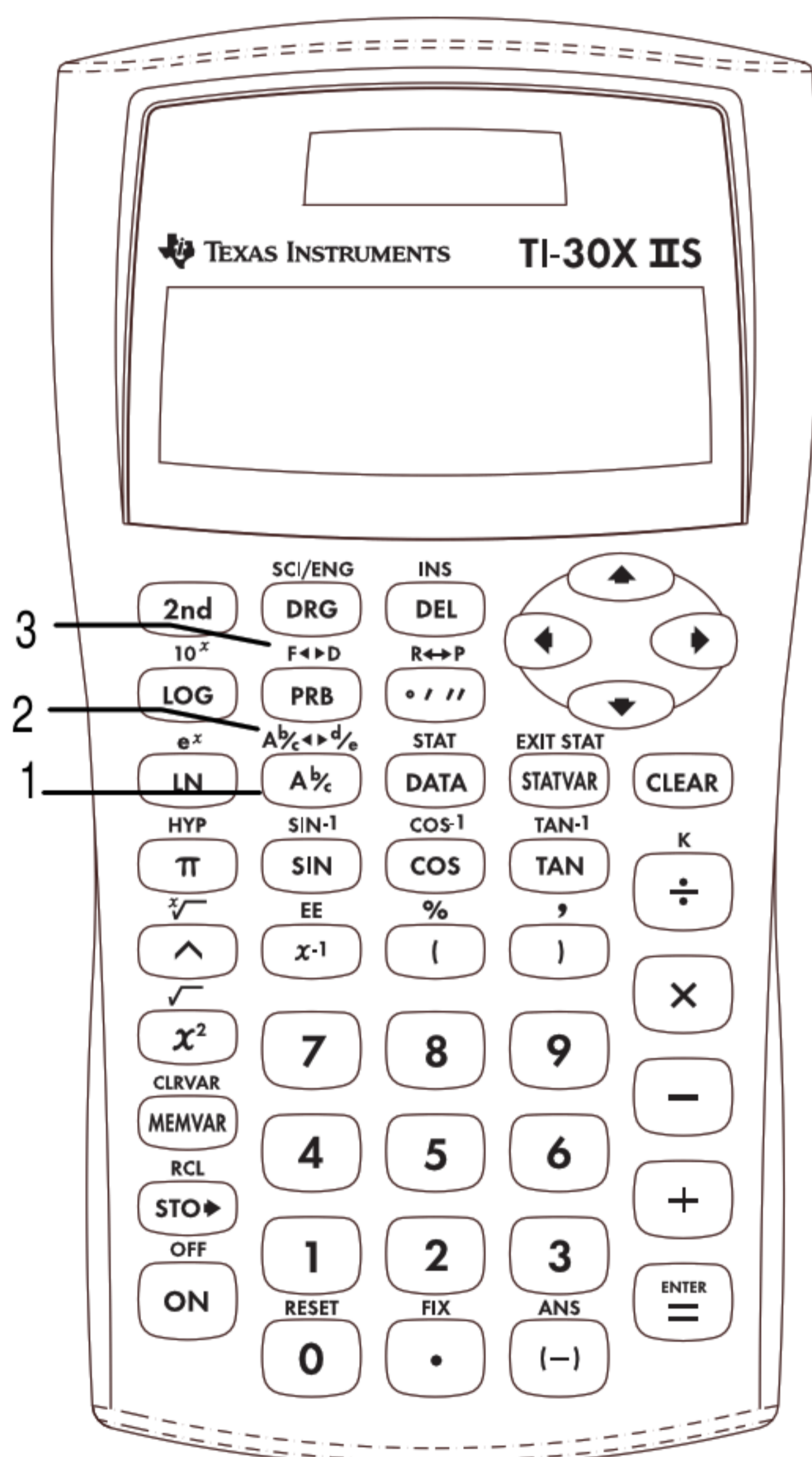

Notes

- The examples on the transparency masters assume all default settings.
- To enter a mixed number or a fraction, press $\boxed{A\frac{b}{c}}$ between the whole number and the numerator and between the numerator and the denominator.
- You can enter a fraction or mixed number anywhere you can enter a decimal value.
- You can use fractions and decimals together in a calculation.
- Fractional results and entries are automatically reduced to their lowest terms.
- Fractional calculations can show fractional or decimal results.
 - When possible, calculations involving 2 fractions or a fraction and any integer will display fractional results.
 - Calculations involving a fraction and a decimal will always display results as decimals.
- For a mixed number, the whole number can be up to 3 digits, the numerator can be up to 3 digits, and the denominator can be any number through 1000.
- For a simple fraction, the numerator can be up to 6 digits and the denominator can be any number through 1000.

Fractions

At the party, you ate $\frac{5}{6}$ of the pepperoni pizza and $\frac{1}{10}$ of the sausage pizza. How much pizza did you eat?

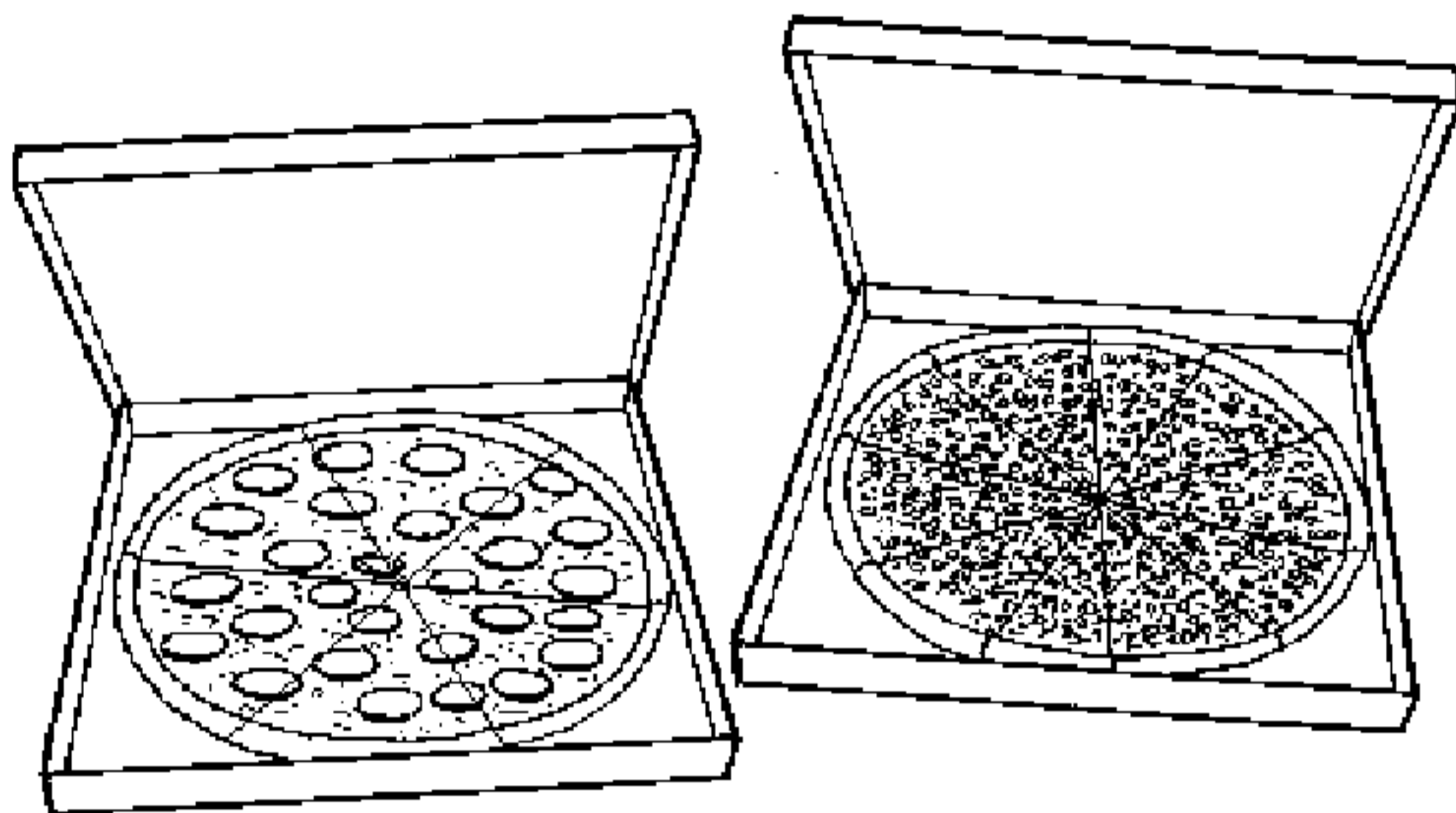

Press

5 $\boxed{\text{Ab/c}}$ 6 $\boxed{+}$ 1
 $\boxed{\text{Ab/c}}$ 10 $\boxed{\text{ENTER}}$

Display

5,6+1,10[†]
 $\frac{14}{15}$
 DEG

$\boxed{\text{Ab/c}}$

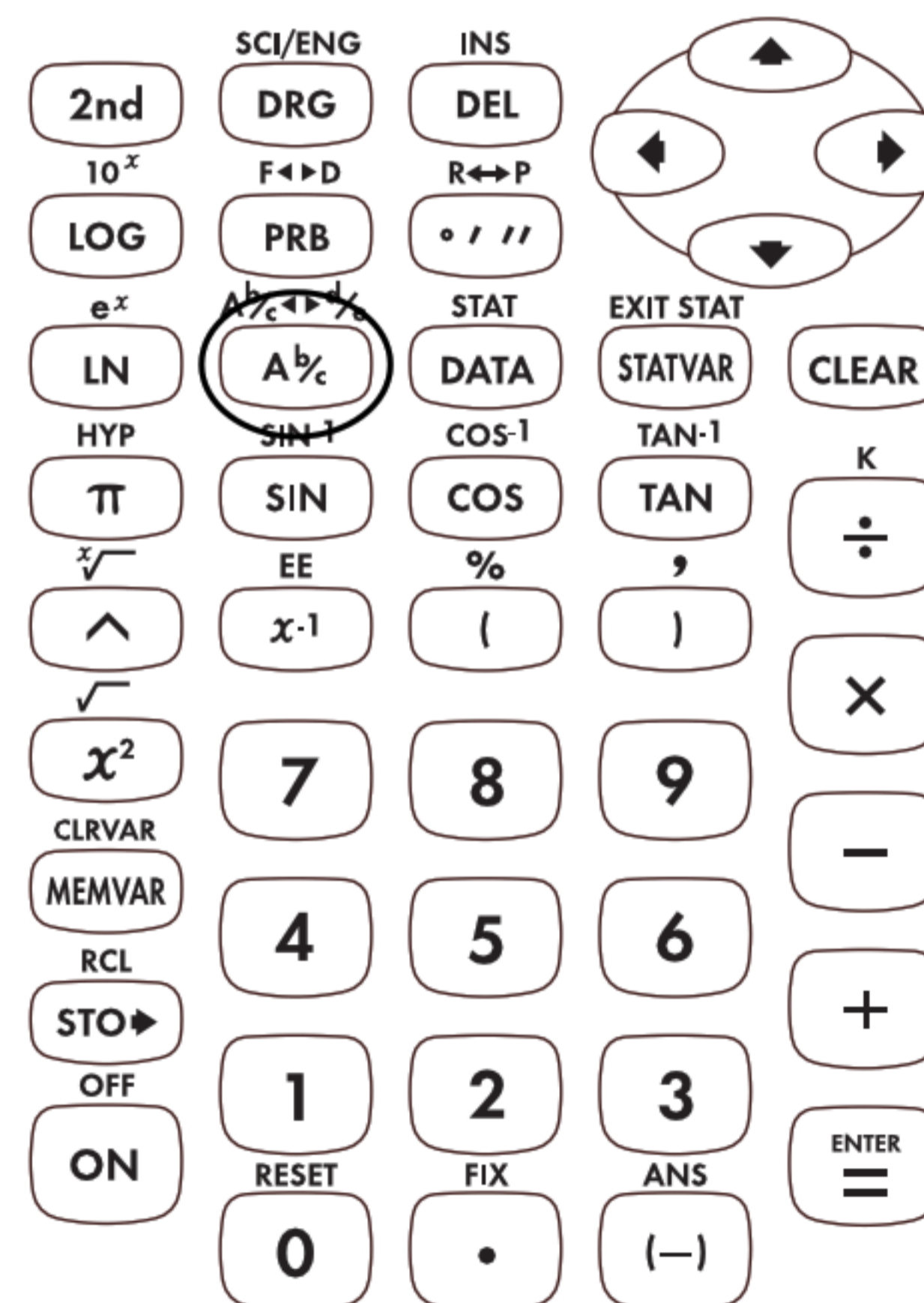

Mixed Numbers

A baby weighed $4 \frac{3}{8}$ pounds at birth. In the next 6 months, she gained $2 \frac{3}{4}$ pounds. How much does she weigh?

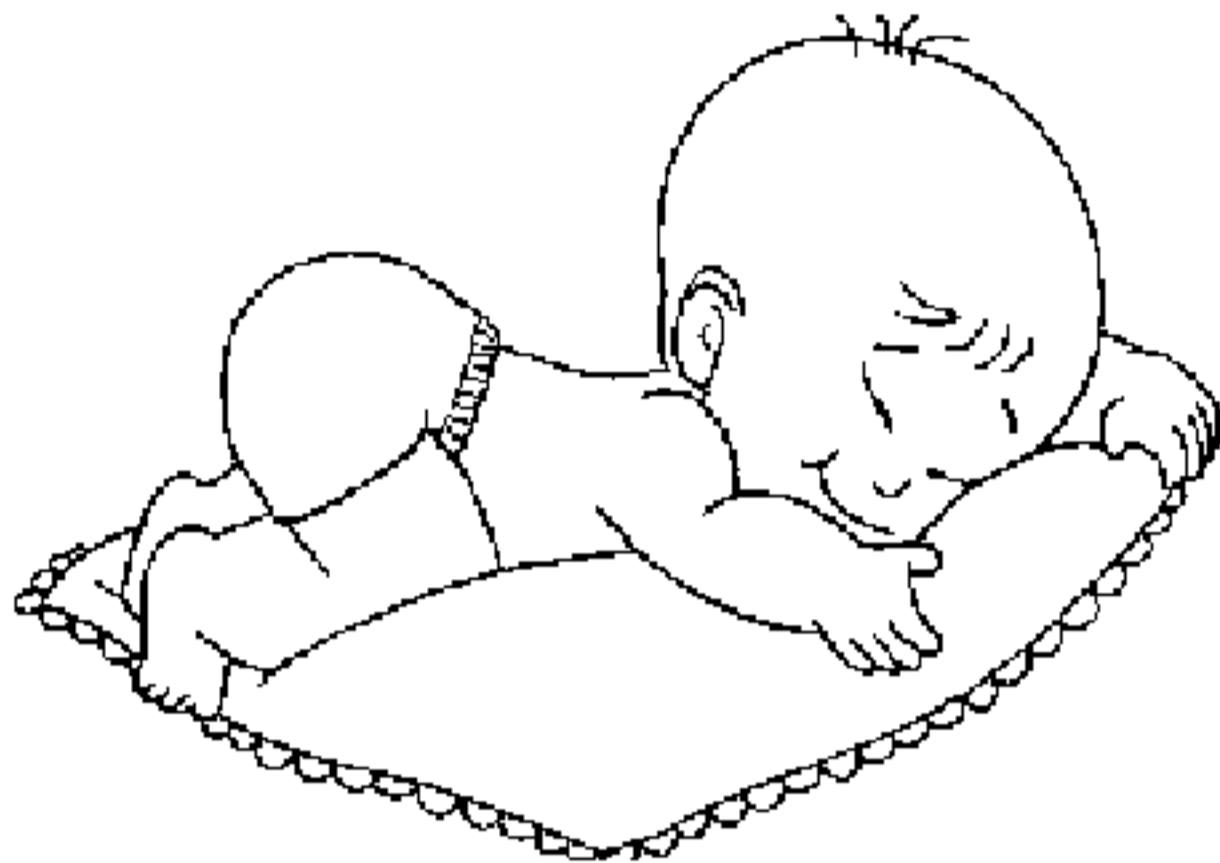

A_b/c

Press

Display

4 **A_b/c** 3 **A_b/c**
 8 **+** 2 **A_b/c** 3
A_b/c 4 **ENTER**

4,3,8+2,3,4[†]
 7 1/8
 DEG

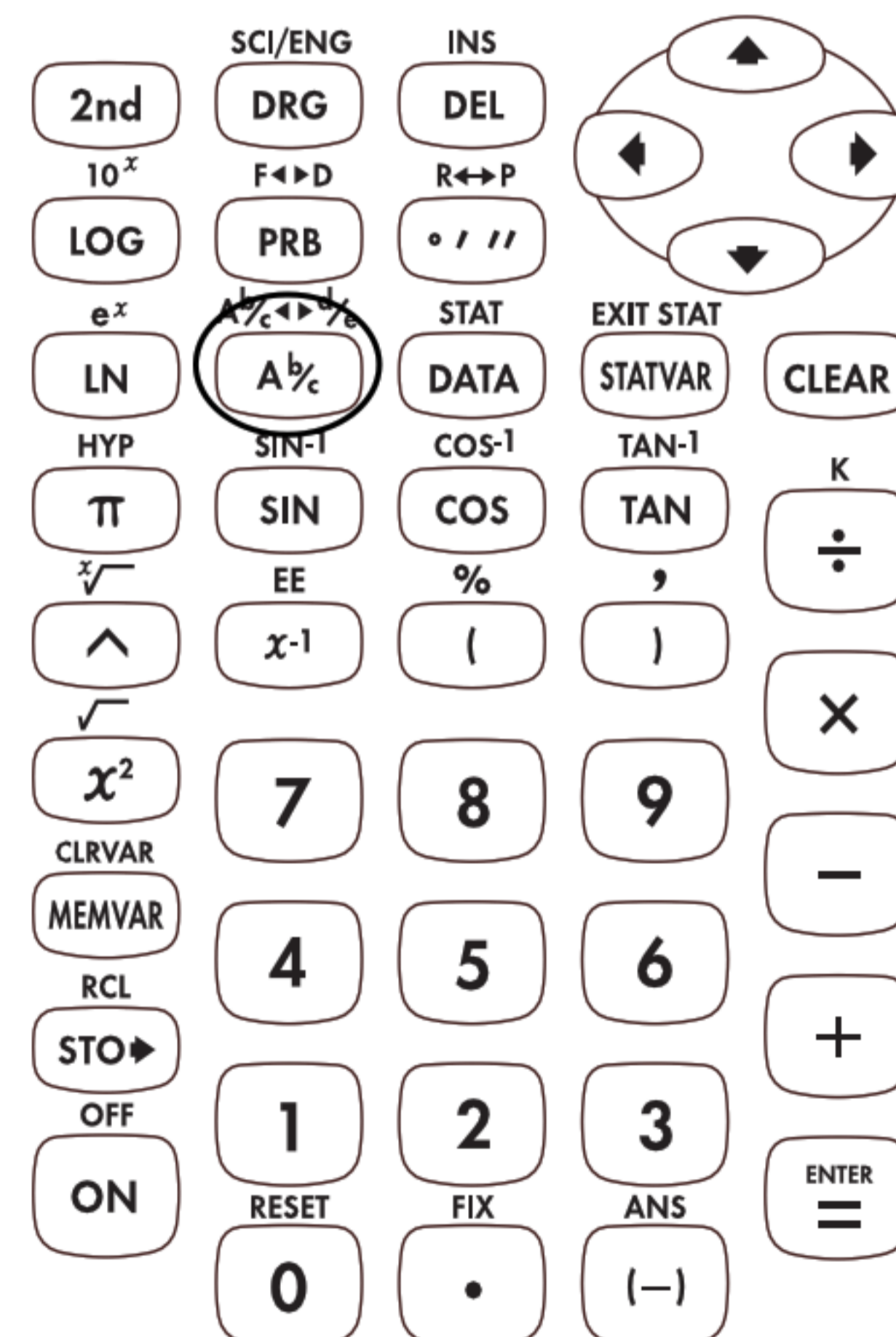

Mixed Number to Fraction, Fraction to Mixed Number

Sam is making his birthday cake. The recipe calls for $3 \frac{1}{2}$ cups of flour. He has only a $\frac{1}{2}$ -cup measuring cup. To find out how many times Sam must use his measuring cup, change the mixed number to a fraction.

$$3 \frac{1}{2} \div \frac{1}{2} = 7$$



Press

Display

3 $\boxed{\text{Ab/c}}$ 1 $\boxed{\text{Ab/c}}$ 2

3 1 2
DEG

$\boxed{\text{2nd}}$ $\boxed{\text{Ab/c}}$

3 1 2 \rightarrow $\boxed{\text{Ab/c}}$
DEG

$\boxed{\text{ENTER}}$

3 1 2 \rightarrow $\boxed{\text{Ab/c}}$
7/2
DEG

Show the mixed number again.

$\boxed{\text{2nd}}$ $\boxed{\text{Ab/c}}$ $\boxed{\text{ENTER}}$

Ans \rightarrow $\boxed{\text{Ab/c}}$
3 1/2
DEG

$\boxed{\text{2nd}}$ $\boxed{\text{Ab/c}}$

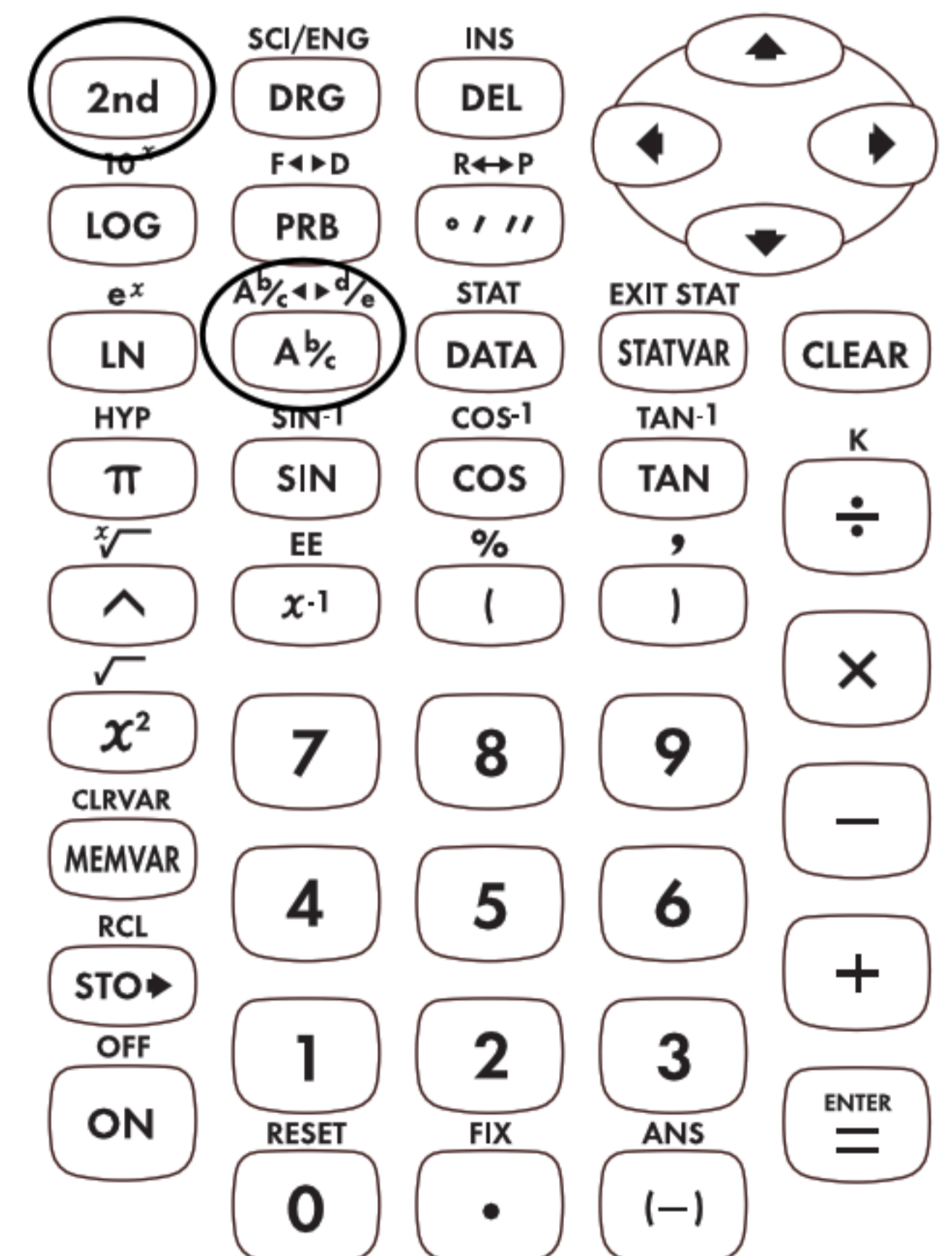

Fraction to Decimal

Juan swims 20 laps in 5.72 minutes. Mary swims 20 laps in $5 \frac{3}{4}$ minutes. Change Mary's time to a decimal to determine who swims faster.

2nd **F \leftrightarrow D**
PRB

Press	Display
5 A$\frac{b}{c}$ 3 A$\frac{b}{c}$	
4 2nd F\leftrightarrowD PRB	
ENTER	



Decimal to Fraction

Change 2.25 to its fractional equivalent.

Press

Display

2 \square 25

\square \square \square
 \square \square \square

2.25 \rightarrow F \leftrightarrow D \uparrow
 2 1/4
 DEG

F \leftrightarrow D
 \square \square



Keys

1. π displays the value of pi rounded to 10 digits (3.141592654).

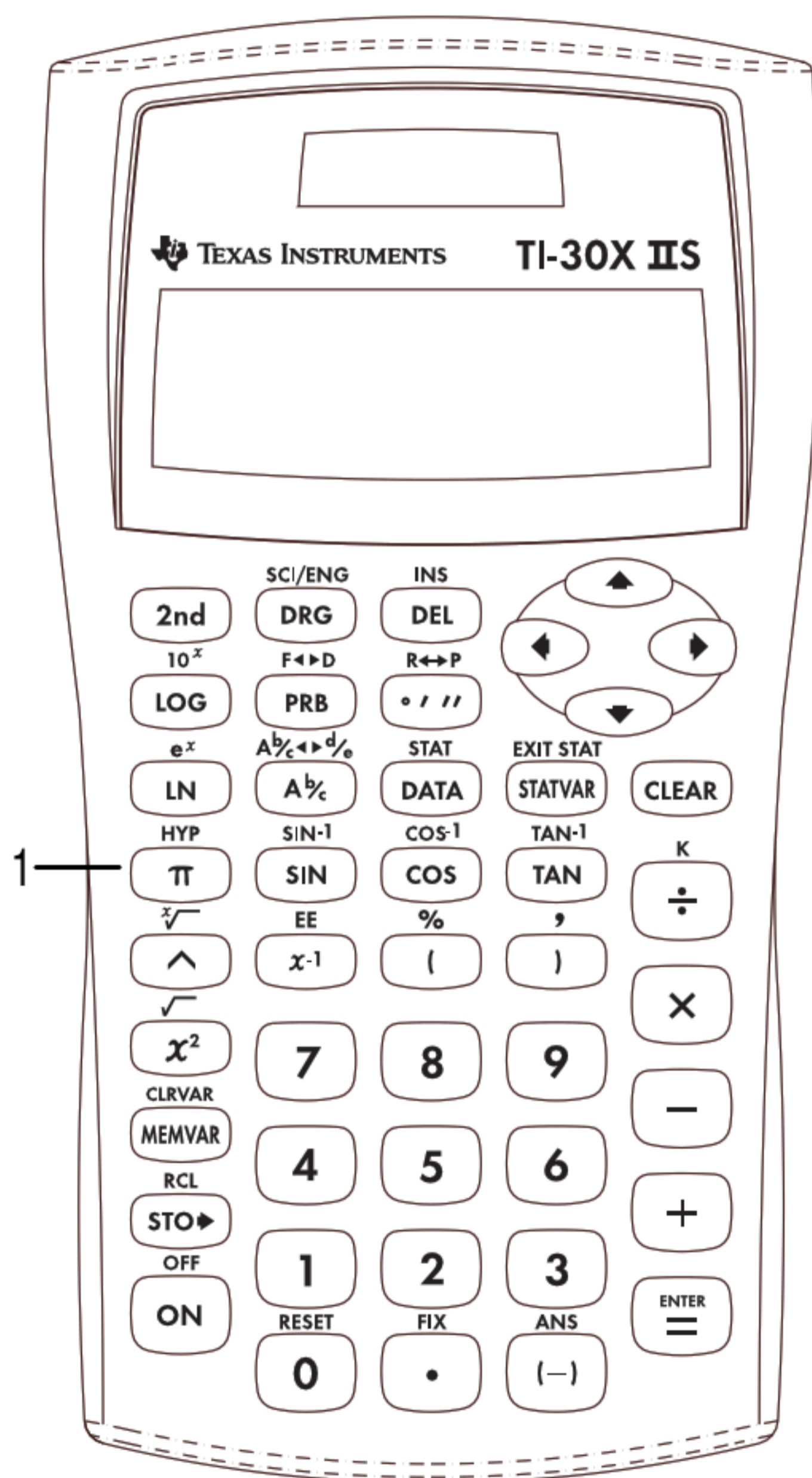

Notes

- The examples on the transparency masters assume all default settings.
- Internally, pi is stored to 13 digits (3.141592653590).
- After pressing 2nd [FIX], you can select the number of decimal places in 2 ways:
 - Press \leftarrow or \rightarrow to move to the number of decimal places you want, and then press ENTER , or
 - Press the number key that corresponds to the number of decimal places you want.

The transparency masters show both ways.

Circumference

Use this formula to find the amount of border you need if you want to put a circular border all the way around the tree.

$$C = 2\pi r = 2 \times \pi \times 1.5 \text{ m}$$

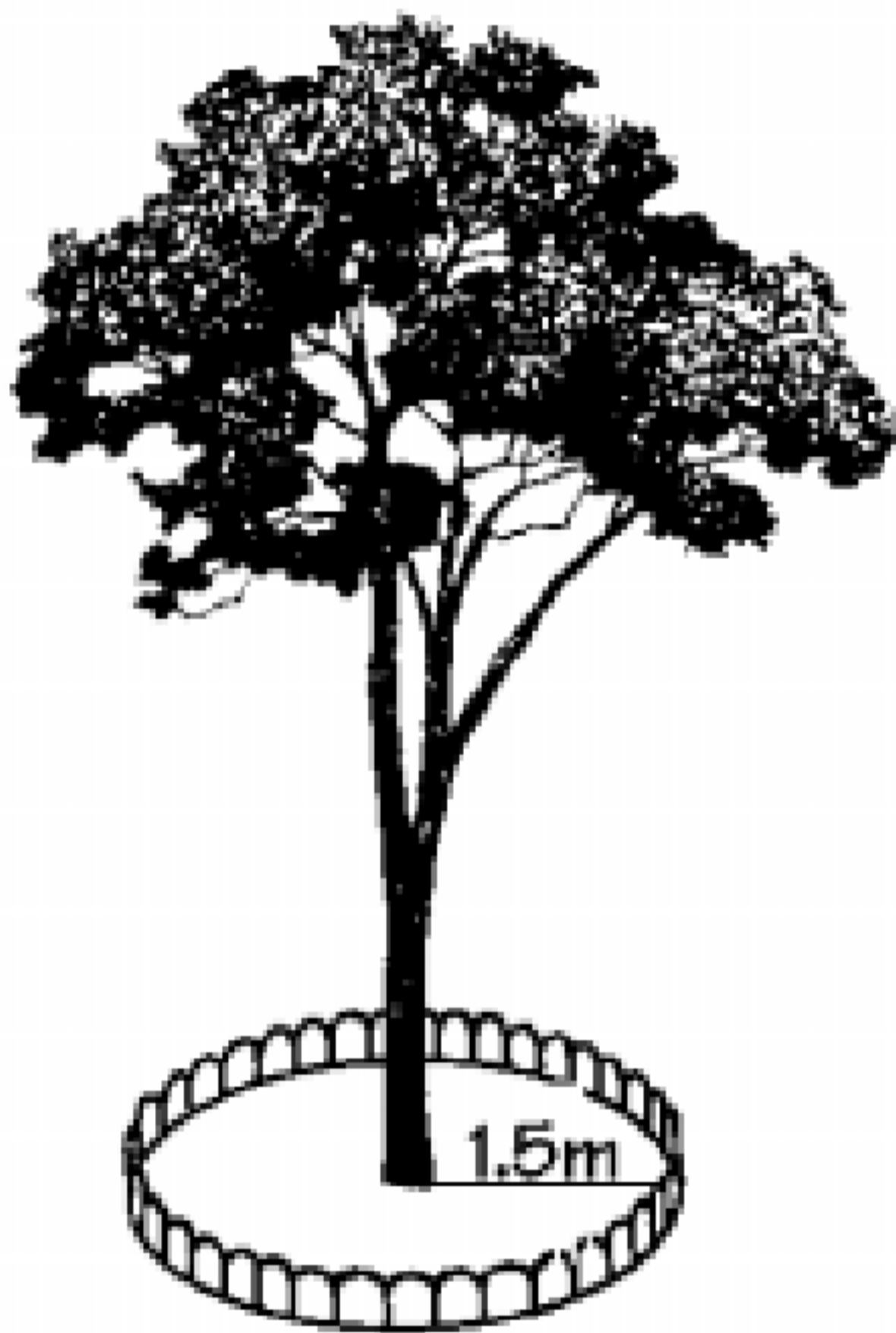

Press

2 \times π \times 1.5
 ENTER

Display

2* π *1.5
 9.424777961
 DEG



Area

Use this formula to find how much of a lawn would be covered by the sprinkler. Round your answer to the nearest whole number, and then return to floating decimal mode.

$$A = \pi r^2 = \pi \times 4^2$$

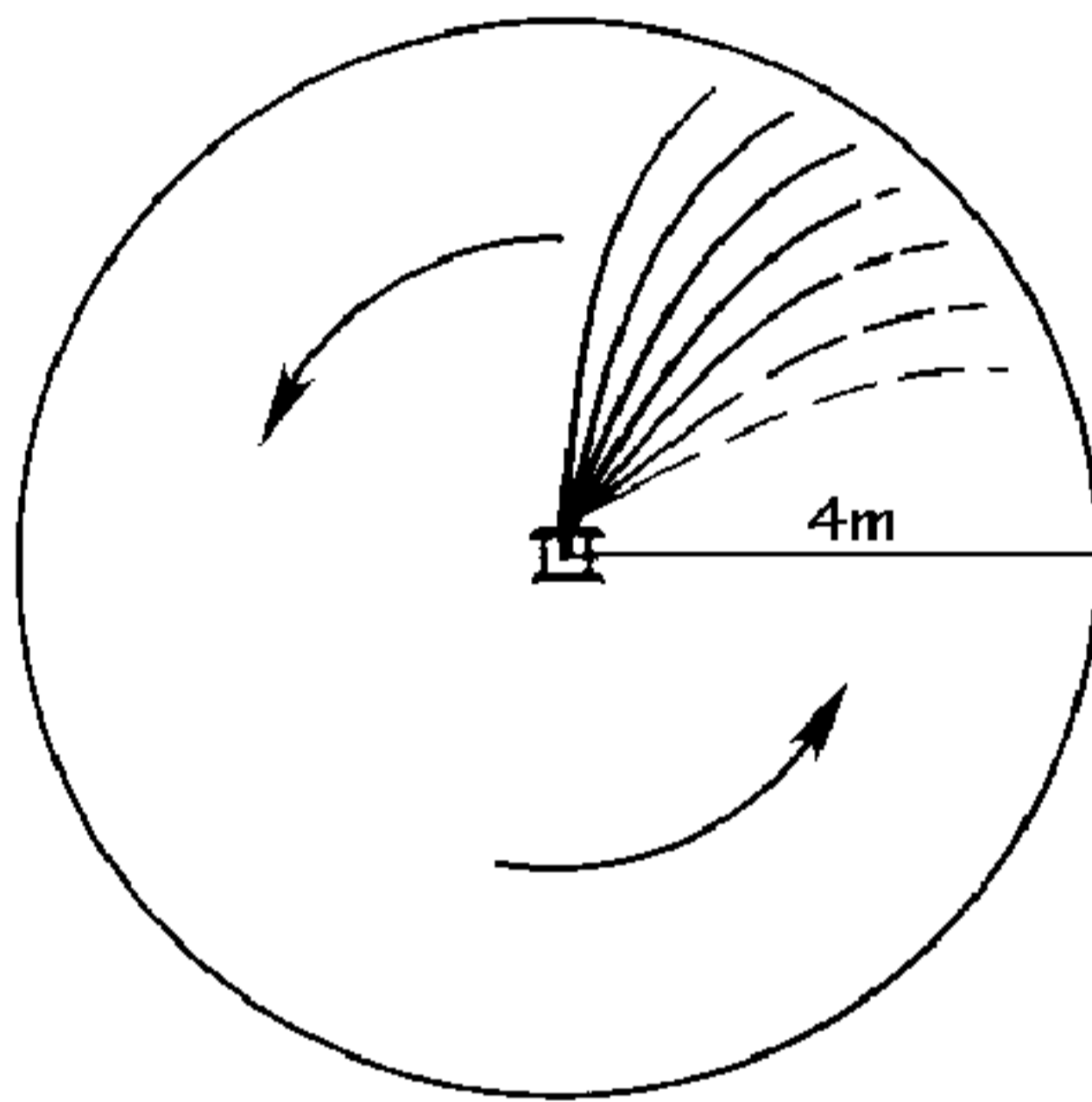

Press

Display

π \times 4 x^2
 $\underline{\text{ENTER}}$

$\pi * 4^2$ ↑
 50.26548246
 DEG

FIX
 2nd \cdot \blacktriangleright

F0 123456789
 DEG

$\underline{\text{ENTER}}$

$\pi * 4^2$ ↑
 50.
 FIX DEG

FIX
 2nd \cdot \cdot

$\pi * 4^2$ ↑
 50.26548246
 DEG

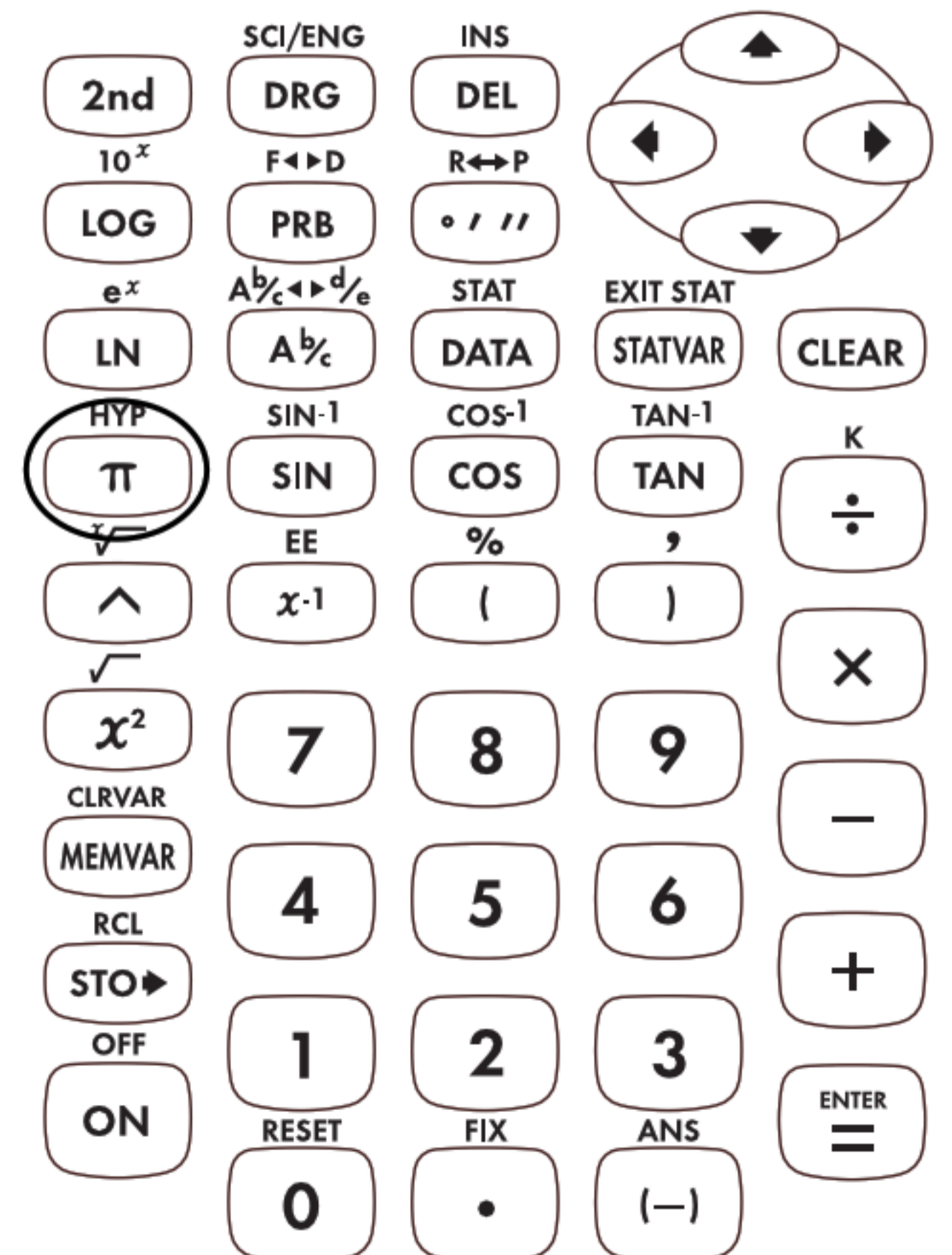

Keys

1. x^2 squares the value.
2. 2^{nd} $\sqrt{}$ calculates the square root.
3. 2^{nd} $\sqrt[x]{}$ calculates the specified root (x) of the value.
4. x^{-1} calculates the reciprocal.
5. \wedge raises a value to a specified power.

Notes

- The examples on the transparency masters assume all default settings.
- To use \wedge , enter the base, press \wedge , and then enter the exponent.
- The base (or mantissa) and the exponent may be either positive or negative. Refer to Domain under Error Messages in Appendix C (page C-1) for restrictions.
- The result of calculations with \wedge must be within the range of the TI-30XIIS.
- A sign change takes precedence over exponents.

Example: $-5^2 = -25$
 $(-5)^2 = 25$

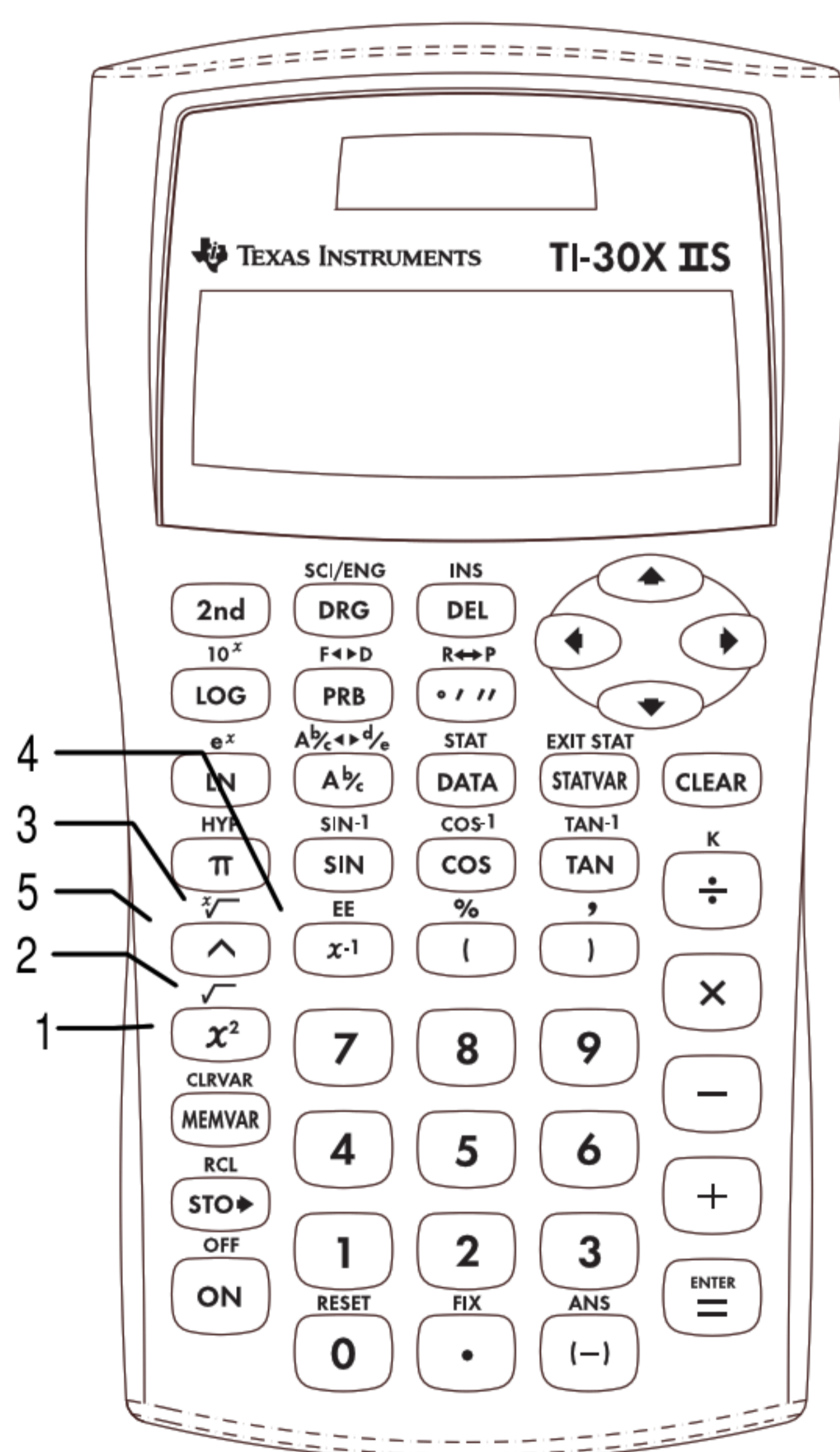

Squares

Use this formula to find the size of the tarpaulin needed to cover the entire baseball infield.

$$A = x^2 = 27.4^2$$

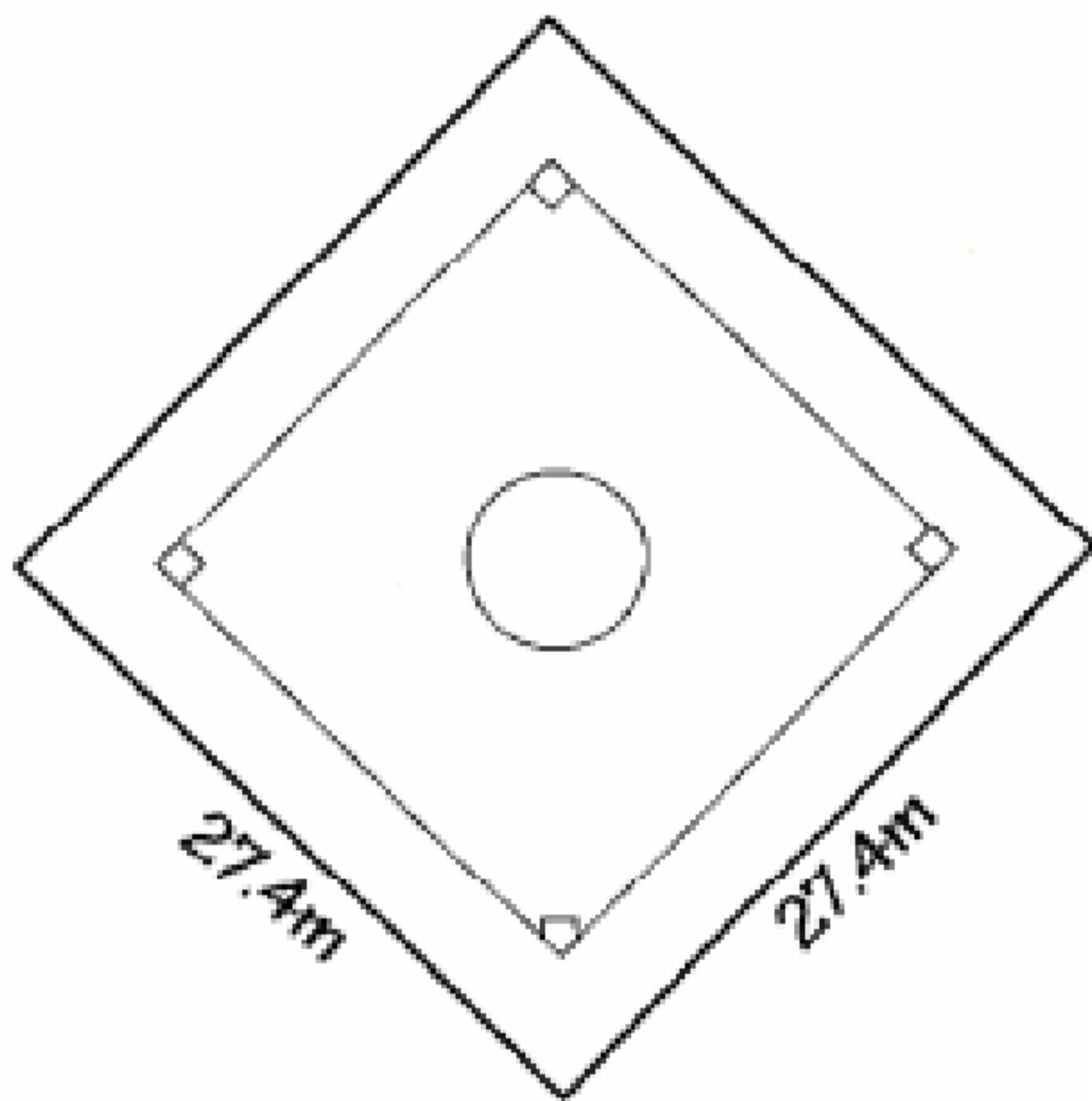

Press

Display

27.4 x^2 $\underline{\underline{\text{ENTER}}}$

or

27.4 \wedge 2

$\underline{\underline{\text{ENTER}}}$

27.4²
750.76
DEG

27.4^{^2}
750.76
DEG

x^2 \wedge



Square Roots

Use this formula to find the length of the side of a square clubhouse if 3 m² of carpet would cover the floor. Round your answer to 0 decimal places.

$$L = \sqrt{x} = \sqrt{3}$$

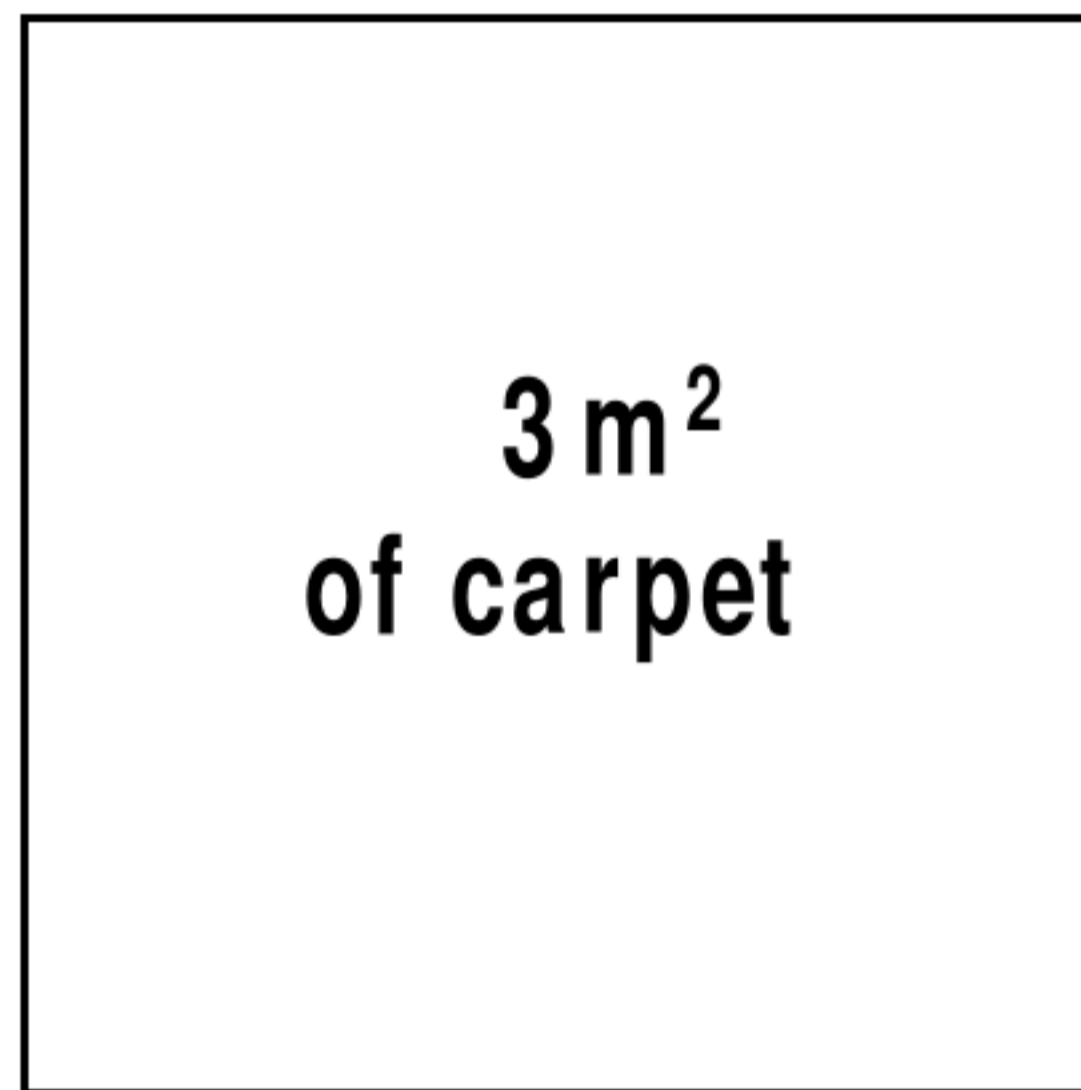

$$\boxed{2\text{nd}} \boxed{x^2}$$

Press

Display

$\boxed{2\text{nd}} \boxed{x^2} 3 \boxed{)}$
 $\boxed{\text{ENTER}}$

$\sqrt{(3)}$ ↑
 1.732050808
 DEG

FIX
 $\boxed{2\text{nd}} \boxed{\cdot} \boxed{\blacktriangleright}$
 $\boxed{\text{ENTER}}$

$\sqrt{(3)}$ ↑
 FIX DEG 2.



Cubes

Use this formula to find the volume of a cube with sides 2.3 meters long. Change your answer to a fraction.

$$V = L^3 = 2.3^3$$

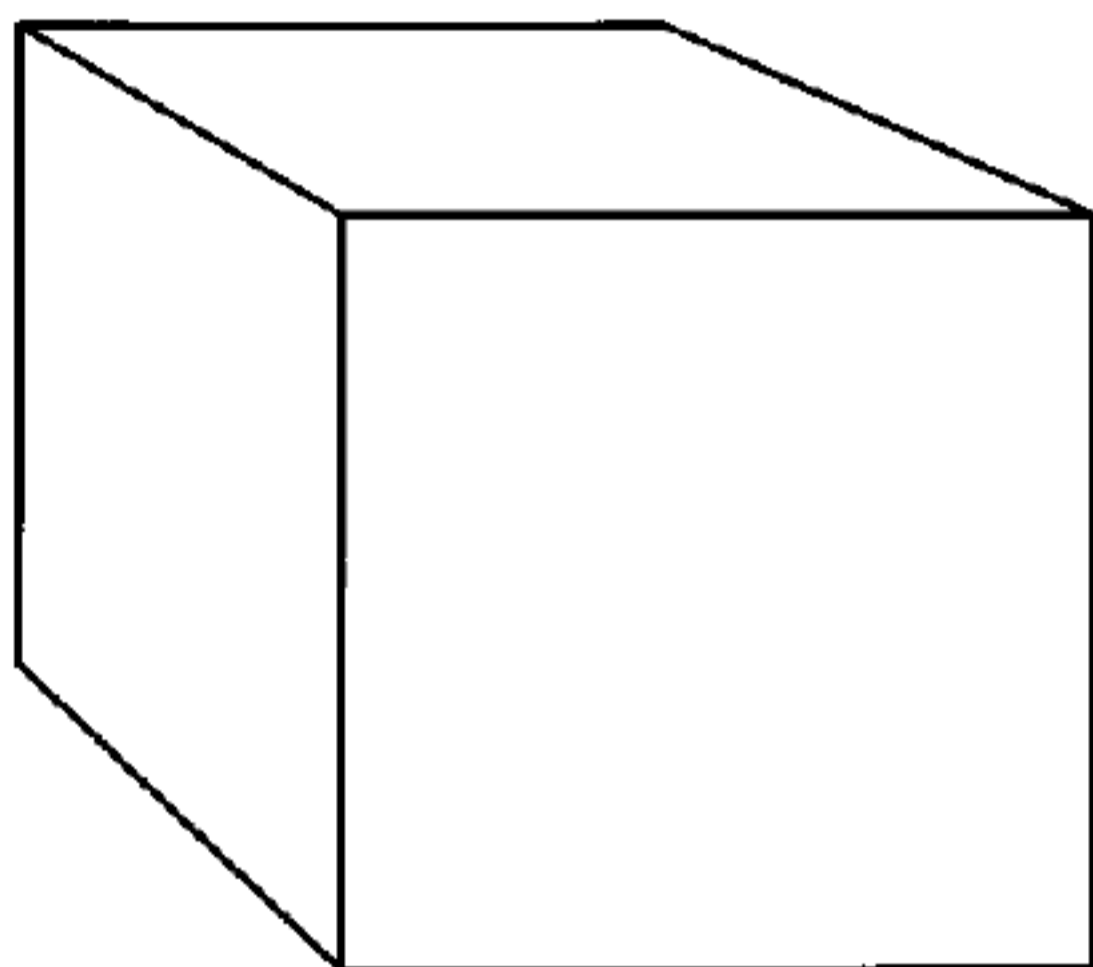

Press

Display

2 \cdot 3 \wedge 3

ENTER

2.3^3
12.167
DEG

$F \leftrightarrow D$
2nd **PRB**

ENTER

Ans $F \leftrightarrow D$
12.167/1000
DEG

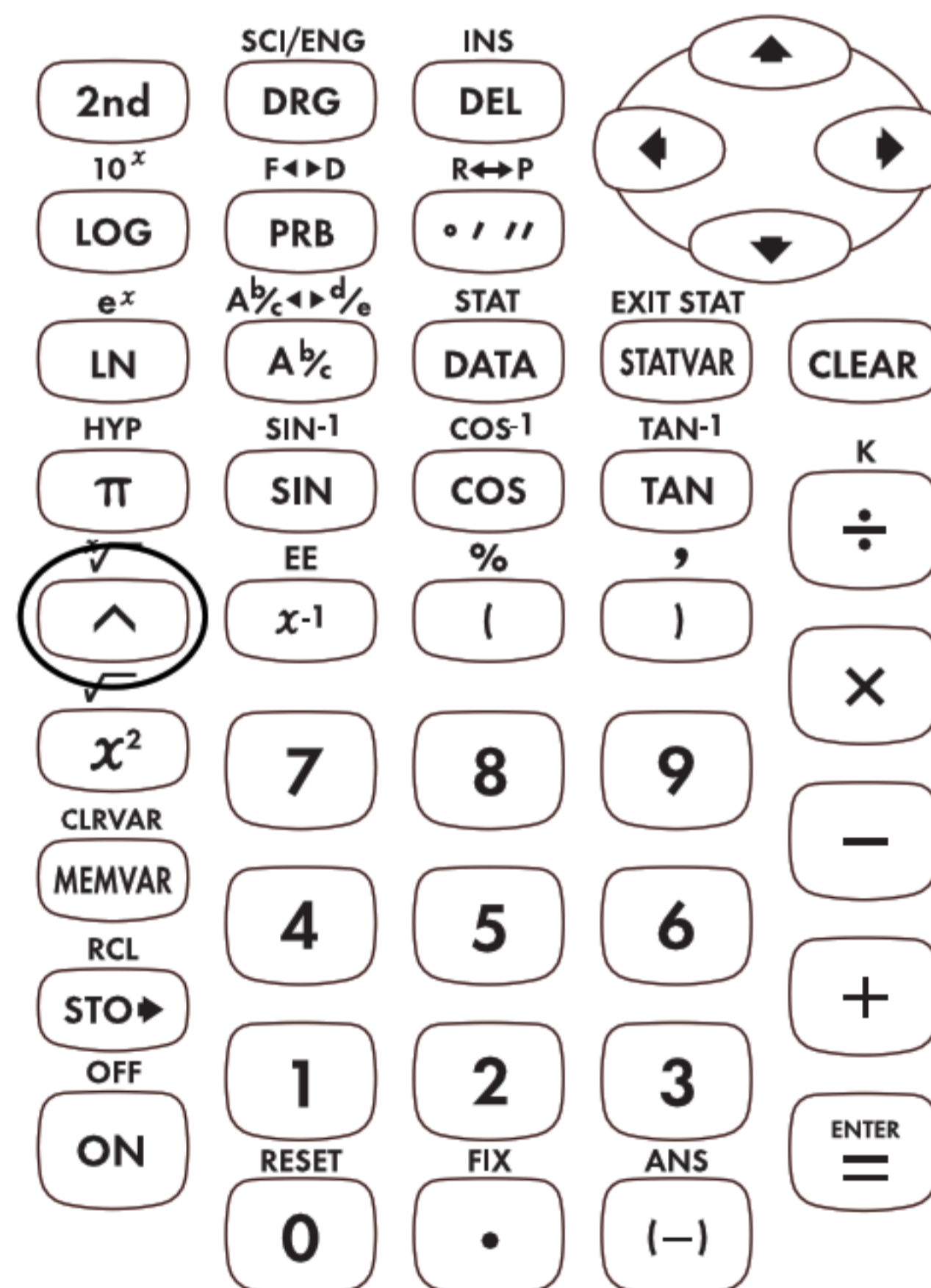

Powers

Fold a piece of paper in half, in half again, and so on until you cannot physically fold it in half again. How many sections would there be after 10 folds? After 15 folds?

Press

Display

2 \square^{\wedge} 10 $\square_{=}$

2^{10} ↑
1024.
DEG

2 \square^{\wedge} 15 $\square_{=}$

2^{15} ↑
32768.
DEG



Roots

If the volume of a cube is 125 cm^3 ,
what is the length of each side?

Press

Display

3 $\boxed{2\text{nd}}$ $\sqrt[3]{}$ 125
 $\boxed{\text{ENTER}}$

$3 \sqrt[3]{125}$
5.
DEG

$\sqrt[3]{}$
 $\boxed{2\text{nd}}$ $\boxed{\wedge}$



Reciprocals

The chart below shows the amount of time spent building model ships.

<u>Ships</u>	<u>Time Spent Building</u>	<u>Port ion Complet ed Per Hour</u>
Sailing	10 hrs.	?
St eam	5 hrs.	?
Luxury	5 $\frac{1}{3}$ hrs.	?

How much of each model was complet ed per hour?

Press Display

Sailing ship:

10 x^{-1} 2nd PRB
ENTER

10⁻¹ F \leftrightarrow D
1 / 10
DEG

St eam ship:

5 x^{-1} 2nd PRB
ENTER

5⁻¹ F \leftrightarrow D
1 / 5
DEG

Luxury liner:

5 $A^{b/c}$ 1 $A^{b/c}$ 3
 x^{-1} ENTER

5 1 3⁻¹
3 / 16
DEG

x^{-1}



Keys

1. **PRB** displays the following menu of functions.

nPr Calculates the number of possible permutations.

nCr Calculates the number of possible combinations.

! Calculates the factorial.

RAND Generates a random 10-digit real number between 0 and 1.

RANDI Generates a random integer between 2 numbers that you specify.

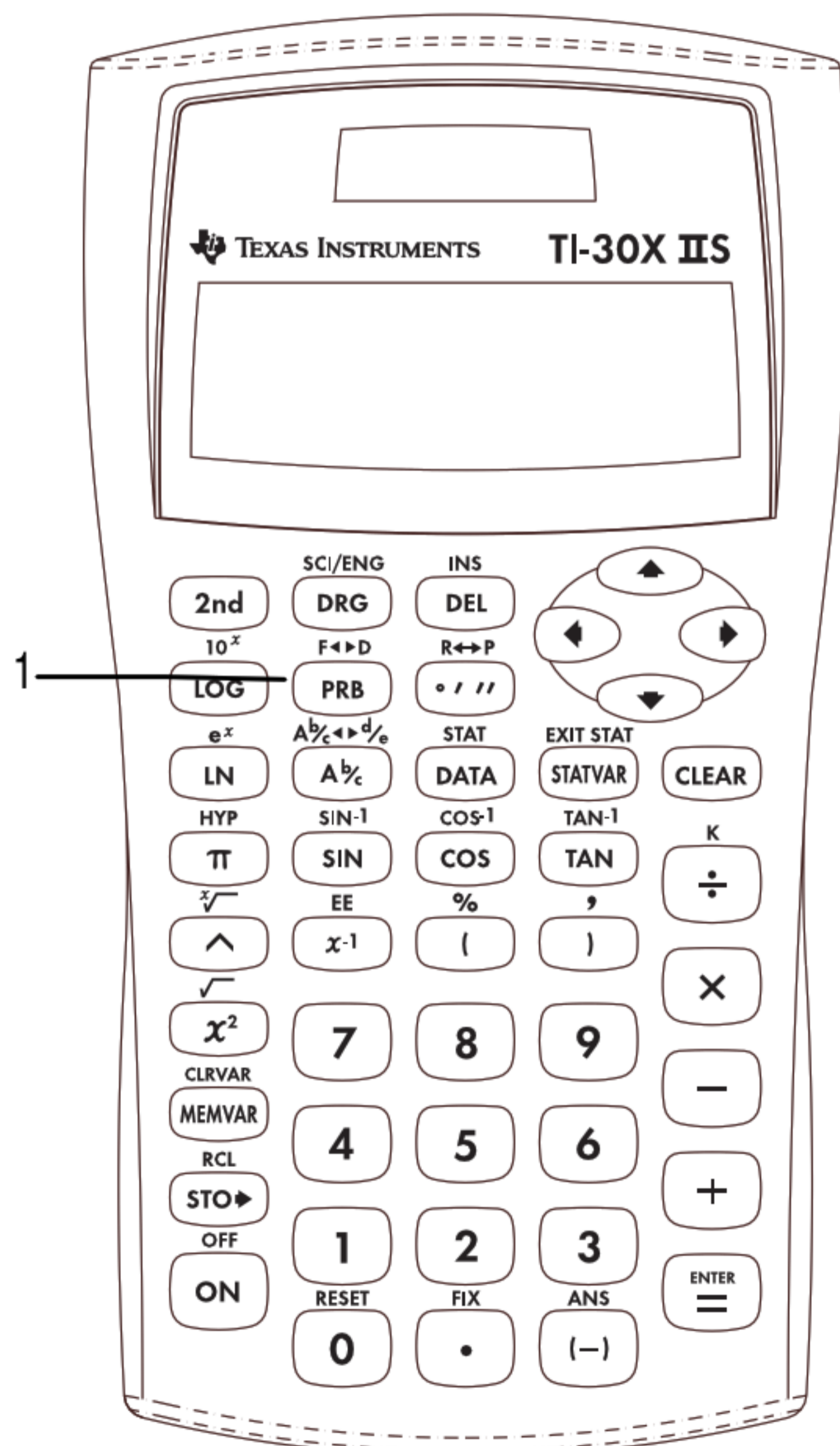

Notes

- The examples on the transparency masters assume all default settings.
- A *combination* is an arrangement of objects in which the order is not important, as in a hand of cards.
- A *permutation* is an arrangement of objects in which the order is important, as in a race.
- A *factorial* is the product of all the positive integers from 1 to n , where n is a positive whole number ≤ 69 .
- To control a sequence of random numbers, you can store (**STO**) an integer to **RAND** just as you would store values to memory variables. The seed value changes randomly when a random number is generated.
- For **RANDI**, use a comma to separate the 2 numbers that you specify.

Combination (nCr)

You have space for 2 books on your bookshelf. You have 4 books to put on the shelf. Use this formula to find how many ways you could place the 4 books in the 2 spaces.

$$4 \text{ nCr } 2 = x$$

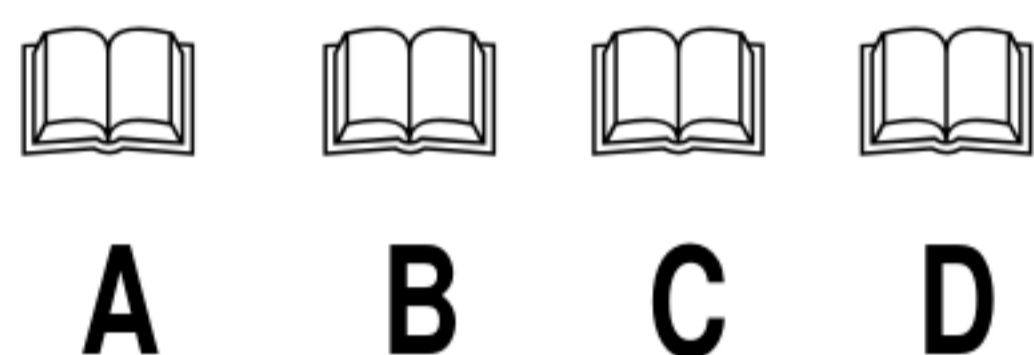

AB and BA	AB	AC	AD
count as only	BA	BC	BD
1 combination.	CA	CB	CD
	DA	DB	DC

Press

Display

4 **PRB**

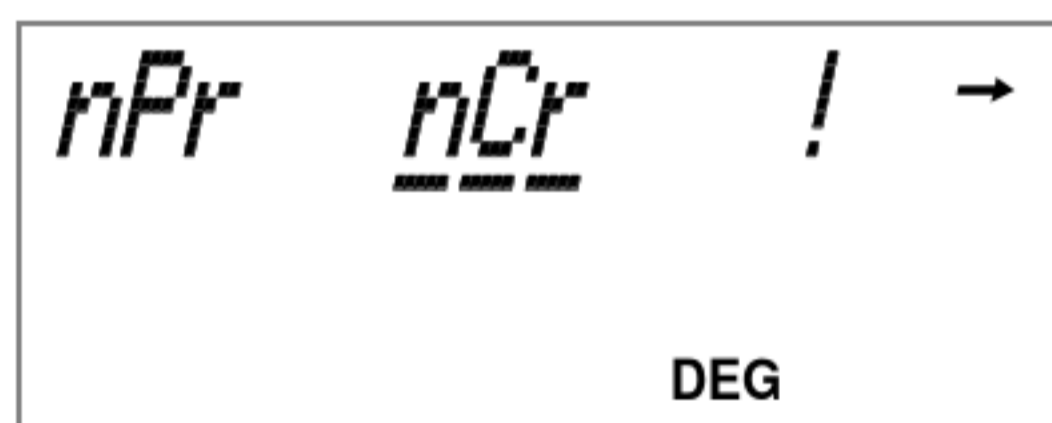

2 **ENTER**

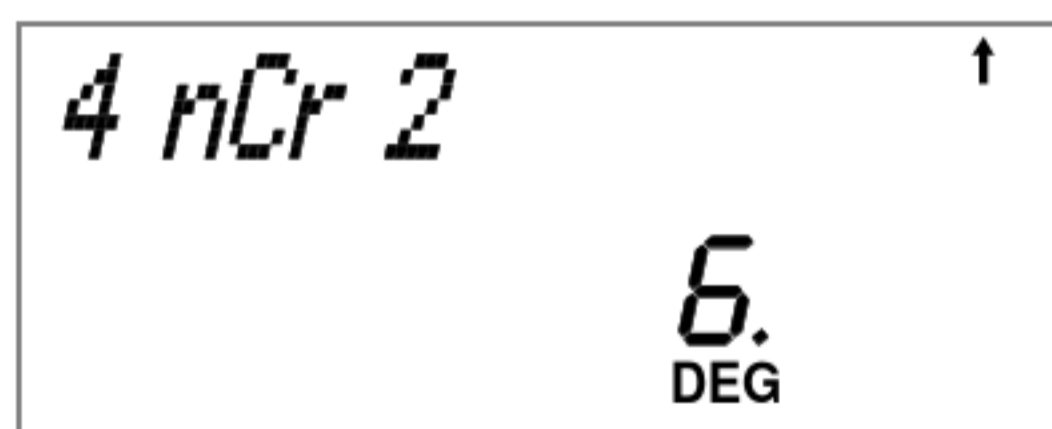

PRB

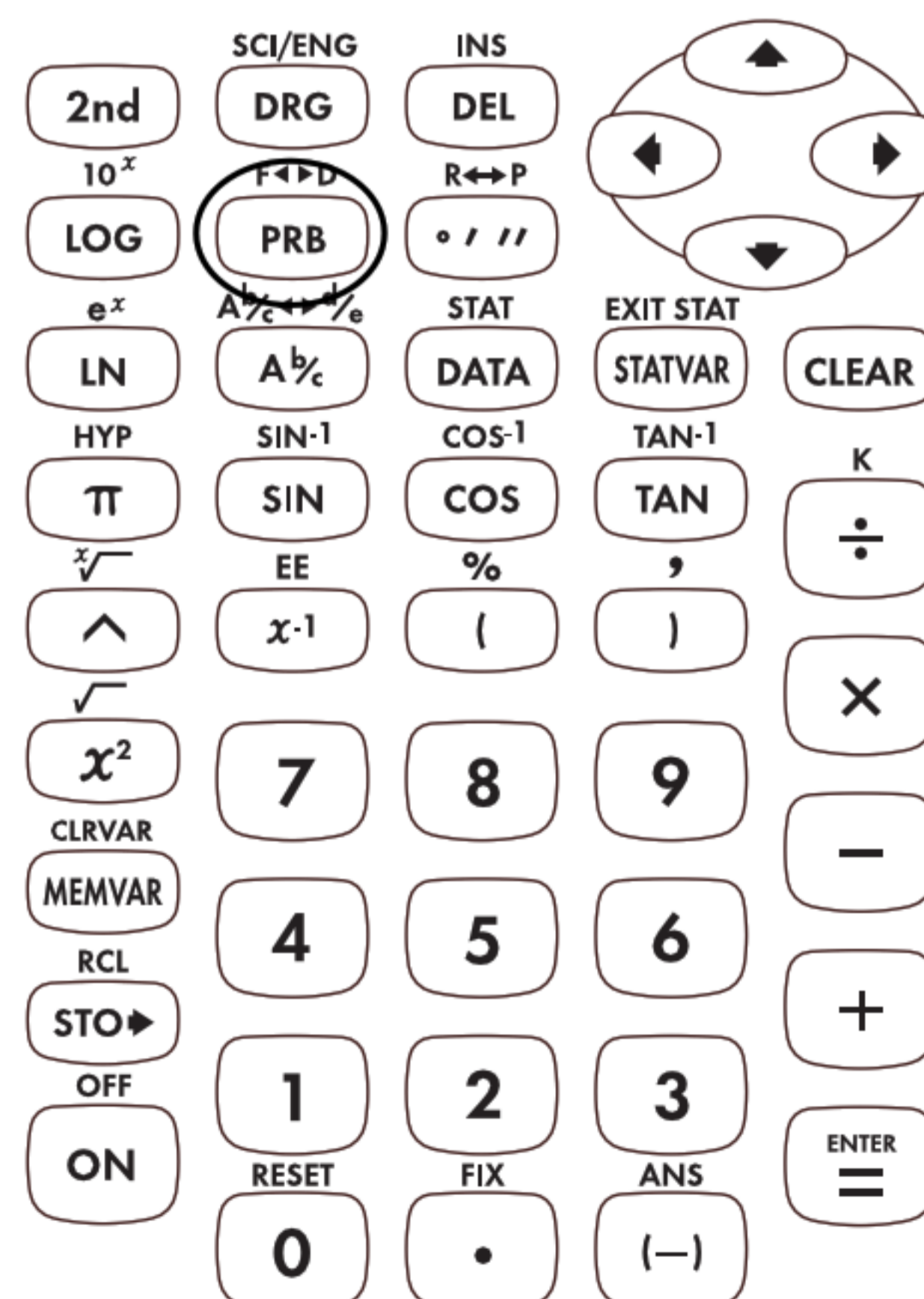

Permutation (nPr)

Four different people are running in a race. Use this formula to find how many different ways they can place 1st and 2nd.

$$4 nPr 2 = x$$

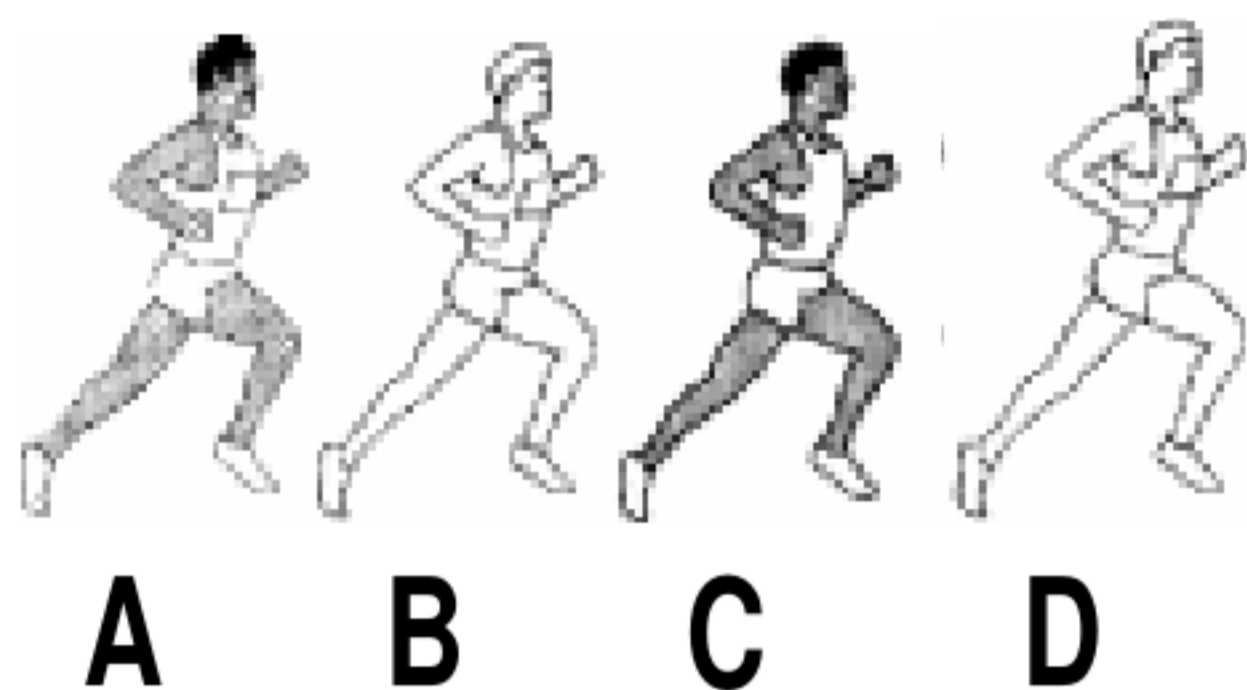

AB and BA
count as 2
permutations.

AB	AC	AD
BA	BC	BD
CA	CB	CD
DA	DB	DC

Press

Display

4 PRB

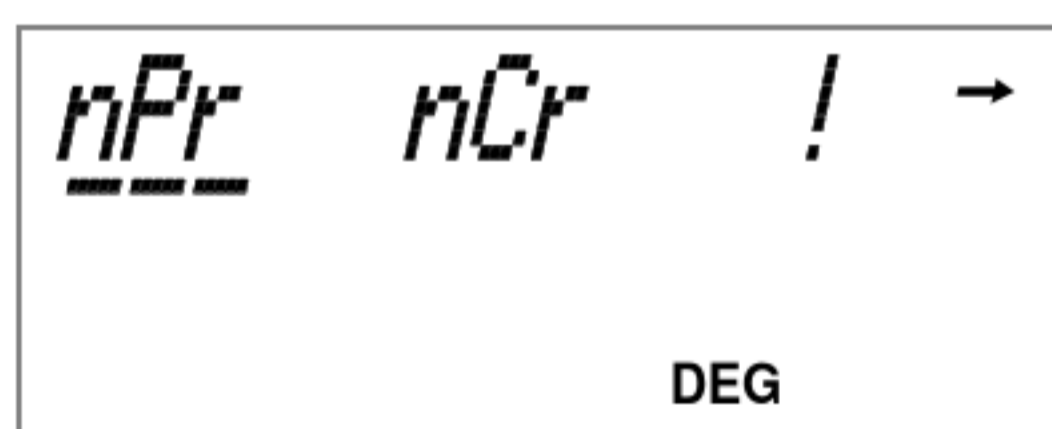

2 ENTER

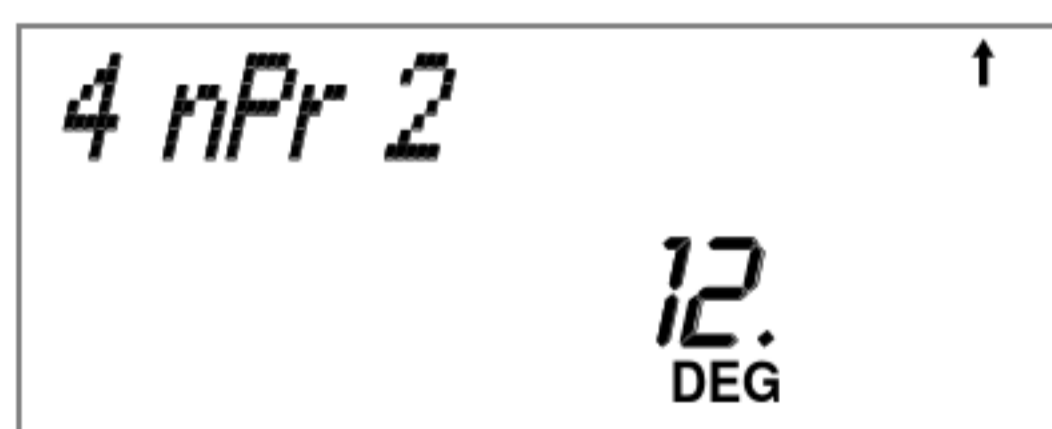

PRB

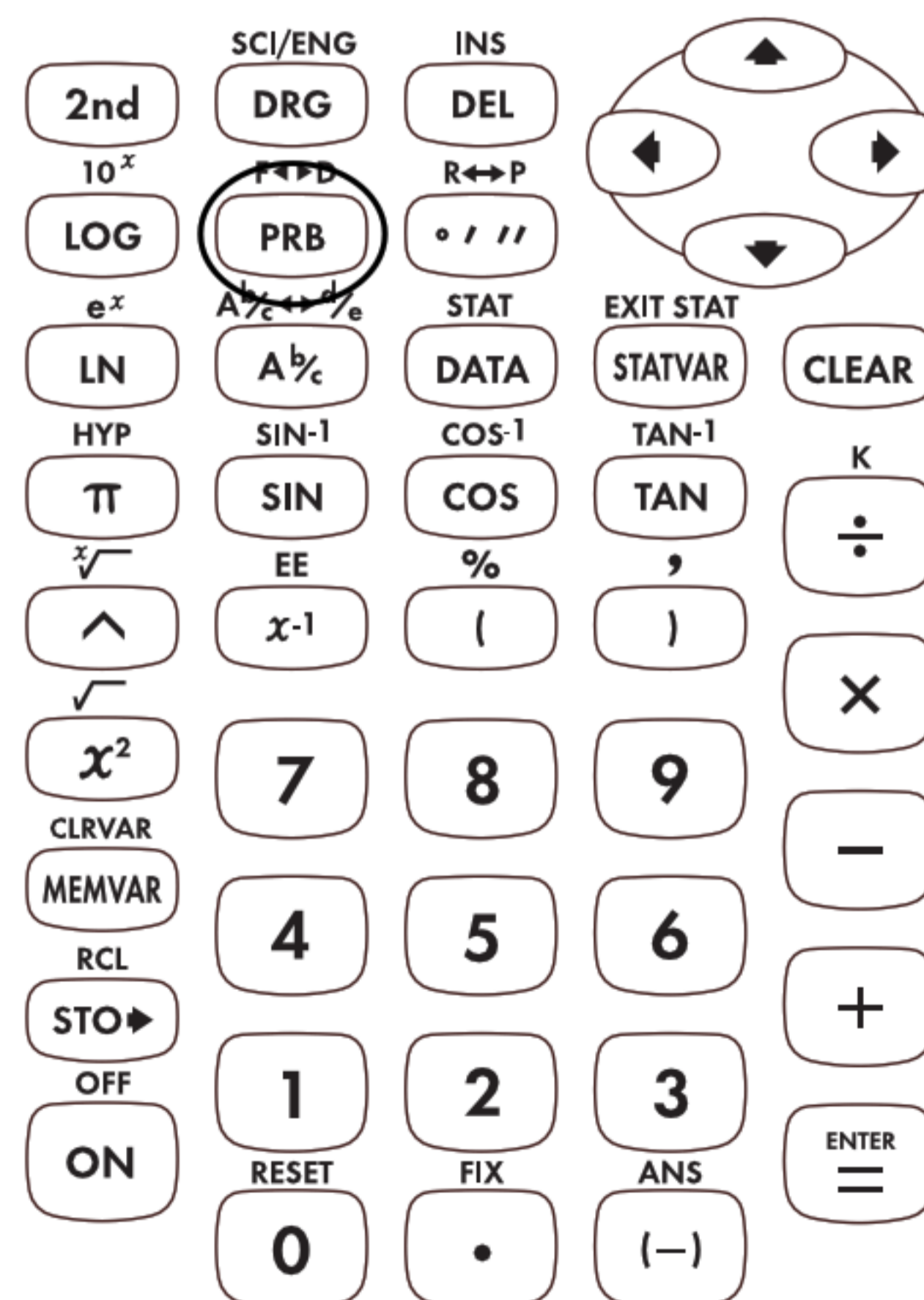

Factorial (!)

Using the digits 1, 3, 7, and 9 only one time each, how many 4-digit numbers can you form?

$$4! = x$$

1	3	7	9
A	B	C	D

ABCD	ABDC	ACBD	ACDB	ADBC	ADCB
BACD	BADC	BCAD	BCDA	BDCA	BDAC
CABD	CADB	CBAD	CBDA	CDAB	CDBA
DABC	DACB	DBAC	DBCA	DCAB	DCBA

Press

Display

4 **PRB** \blacktriangleright \blacktriangleright

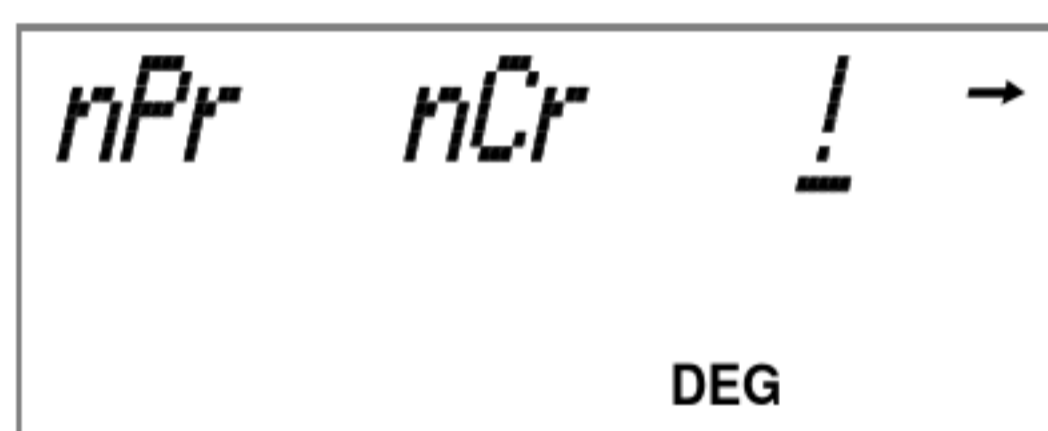

ENTER **ENTER**



PRB



Random (RAND)

Generate a sequence of random numbers.

Press

Display

PRB \blacktriangleright \blacktriangleright \blacktriangleright

\leftarrow RAND RANDI
DEG

ENTER **ENTER**

RAND \uparrow
0.839588694
DEG

ENTER

RAND \uparrow
0.482688185
DEG

Results will vary.

PRB

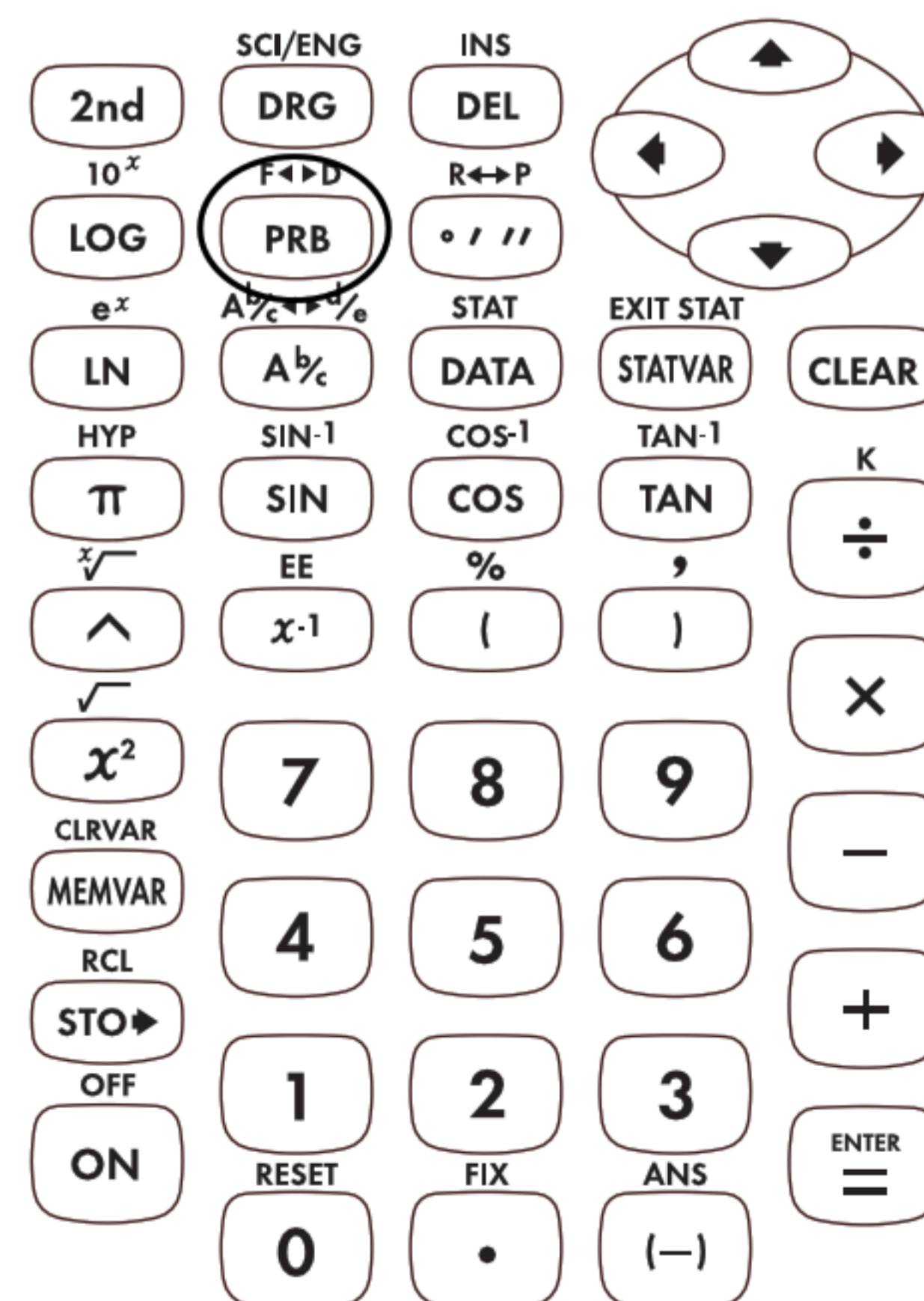

Random (RAND)

Set 1 as the current seed and generate a sequence of random numbers.

Press

Display

1 **STO▶** **◀**

← rand
310000.
DEG

ENTER

1 → rand ↑
1.
DEG

PRB **▶** **▶** **▶**

RAND ↑
0.000018633
DEG

ENTER **ENTER**

ENTER

RAND ↑
0.745579721
DEG

PRB



Random Integer (RAND)

Generate a random integer from 2 through 10.

Press

Display

PRB \blacktriangleleft

\blacktriangleleft *RAND* *RANDI*
DEG

ENTER 2 **2nd** **)**

\blacktriangleleft *RANDI(2, 10)*
DEG

10 **)**

ENTER

RANDI(2, 10) $\rightarrow \uparrow$
3.
DEG

Results will vary.

PRB



Keys

1. **[2nd] [STAT]** displays a menu from which you can select **1-VAR**, **2-VAR** or **CLRDATA**.

1-VAR Analyzes data from 1 set of data with 1 measured variable— x .

2-VAR Analyzes paired data from 2 sets of data with 2 measured variables— x , the independent variable, and y , the dependent variable.

CLRDATA Clears data values without exiting **STAT** mode.

2. **[DATA]** lets you enter data points (x for **1-VAR** stats; x and y for **2-VAR** stats).

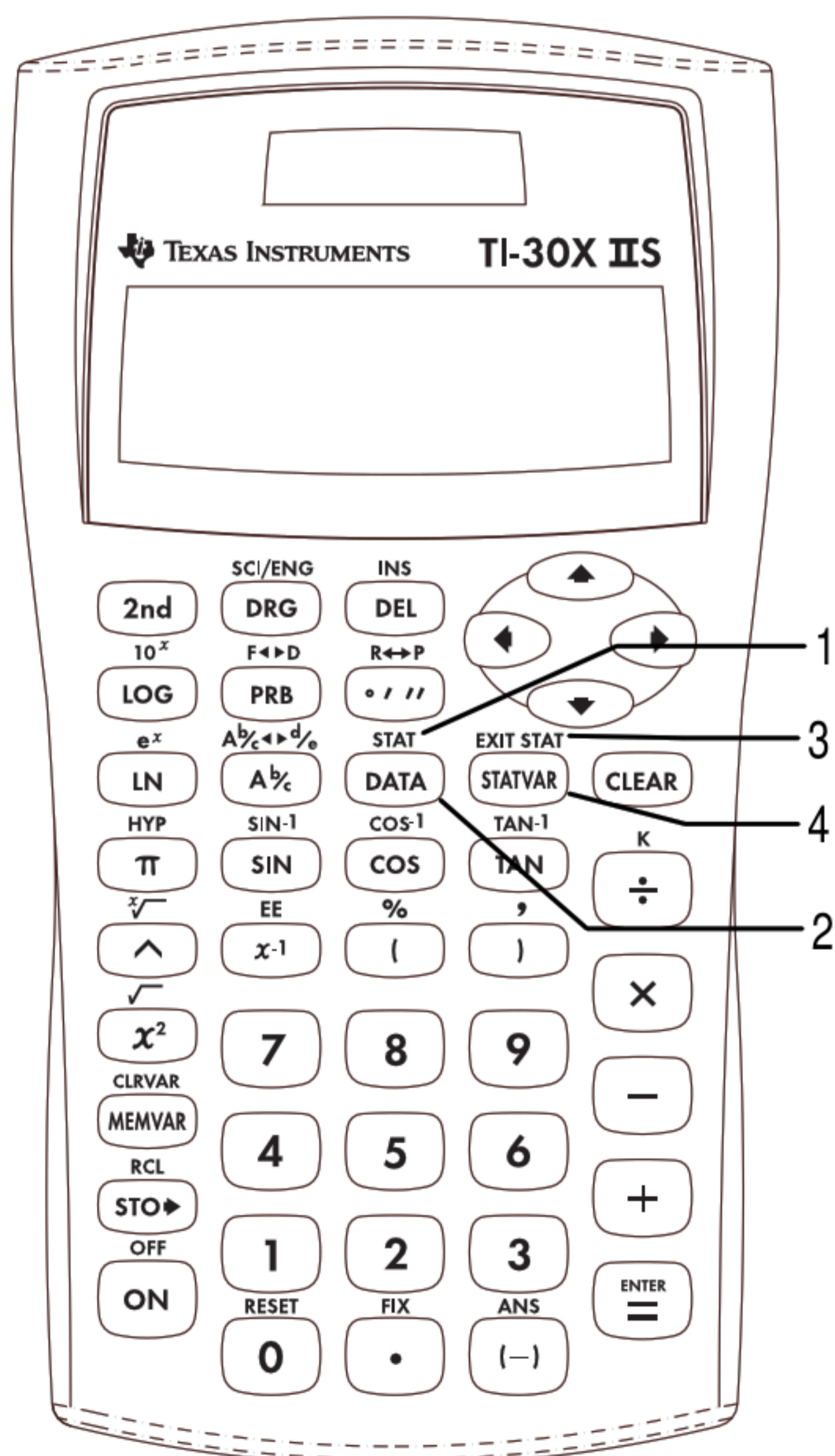

3. **[2nd] [EXIT STAT]** displays the following menu that lets you clear data values and exit **STAT** mode.

EXIT ST: Y N

- Press **[ENTER]** when **Y** (yes) is underlined to clear data values and exit **STAT** mode.
- Press **[ENTER]** when **N** (no) is underlined to return to the previous screen without exiting **STAT** mode.

4. **[STATVAR]** displays the menu of variables with their current values.

n	Number of x (or x,y) data points.
\bar{x} or \bar{y}	Mean of all x or y values.
S_x or S_y	Sample standard deviation of x or y .
σ_x or σ_y	Population standard deviation of x or y .
Σx or Σy	Sum of all x values or y values.
Σx^2 or Σy^2	Sum of all x^2 values or y^2 values.
Σxy	Sum of $(x \times y)$ for all xy pairs in 2 lists.
a	Linear regression slope.
b	Linear regression y -intercept.
r	Correlation coefficient.

Notes

- The examples on the transparency masters assume all default settings.
- To save the last data point or frequency value entered, you must press **[ENTER]** or **[\blacktriangleright]**.
- You can change data points once they are entered.

Entering 1-VAR Stat Data

Five students took a math test. Using their scores, enter the data points—85, 85, 97, 53, 77.

Press

Display

$\boxed{2^{nd}}$ $\overset{\text{STAT}}{\boxed{\text{DATA}}}$

1-VAR 2-VAR →
DEG

$\boxed{\text{ENTER}}$ $\boxed{\text{DATA}}$

$X_1=$ ↑
STAT DEG

85

$X_1=85$ ↑
STAT DEG

⏴

$FRQ=1$ ↑
STAT DEG

2

$FRQ=2$ ↑
STAT DEG

⏴ 97

$X_2=97$ ↑
STAT DEG

⏴ ⏴ 53

$X_3=53$ ↑
STAT DEG

⏴ ⏴ 77 $\boxed{\text{ENTER}}$

$X_4=77$ ↑
STAT 77.
DEG

Continued

$\boxed{2^{nd}}$ $\overset{\text{STAT}}{\boxed{\text{DATA}}}$ $\boxed{\text{DATA}}$



Viewing the Data (Continued)

Find the number of data points (n), the mean (\bar{x}), the sample standard deviation (Sx), the population standard deviation (σx), the sum of the scores (Σx), and the sum of the squares (Σx^2).

Press

Display

STATVAR

\underline{n} \bar{x} Sx σx →
STAT 5.
DEG



n $\underline{\bar{x}}$ Sx σx →
STAT 79.4
DEG



n \bar{x} \underline{Sx} σx →
16.39512123
STAT DEG



n \bar{x} Sx $\underline{\sigma x}$ →
14.66424222
STAT DEG



$\leftarrow \underline{\Sigma x}$ Σx^2
STAT 397.
DEG



$\leftarrow \Sigma x$ $\underline{\Sigma x^2}$
STAT 32597.
DEG

Continued

STATVAR

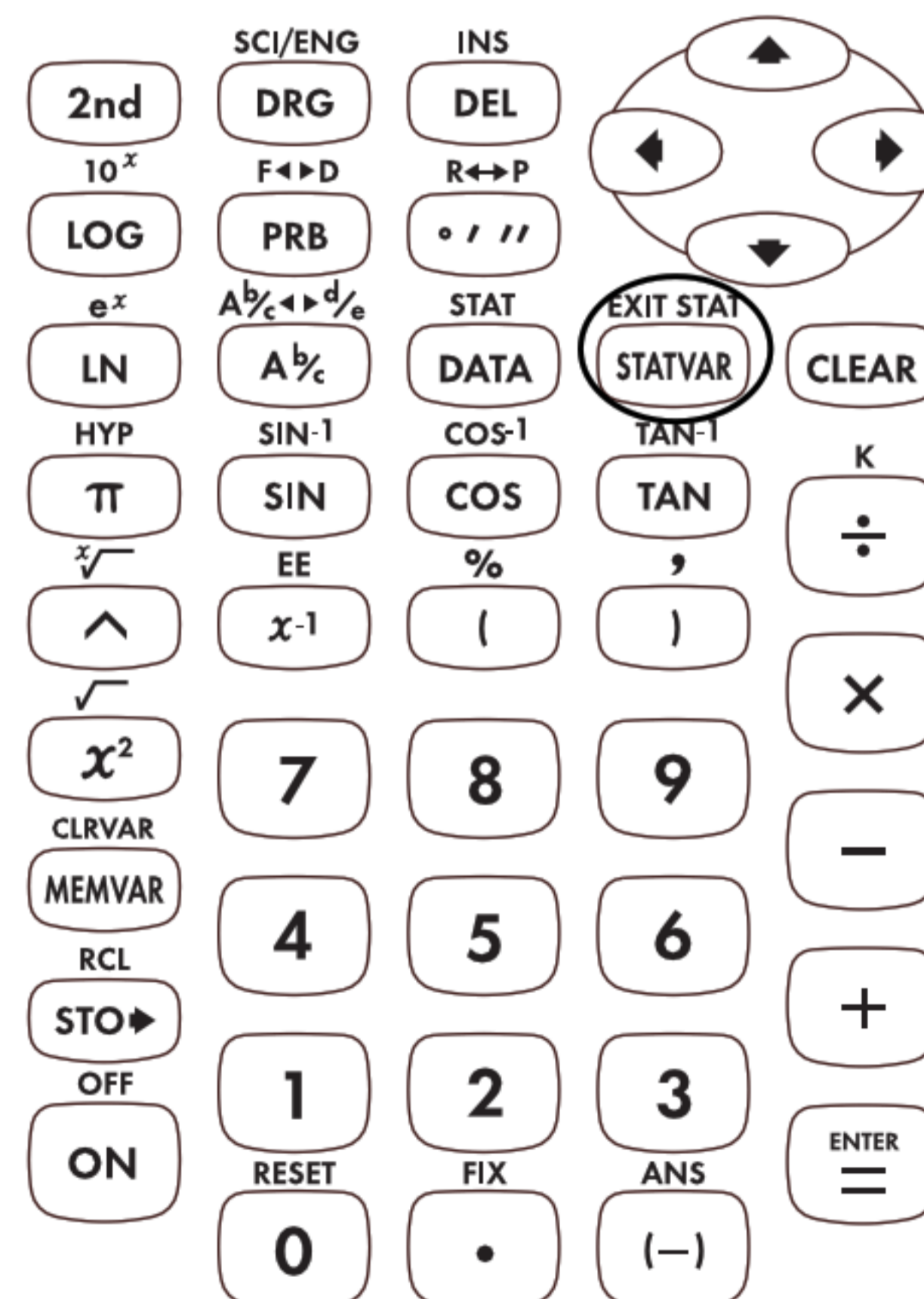

Removing Data Points (Continued)

Return to the first data point.
 Display the lowest score, drop it,
 and then find the new mean (\bar{x}).
 Clear all data by exiting **STAT** mode.

Press	Display
DATA	$X_1=85$ STAT DEG
\downarrow \downarrow \downarrow \downarrow	$X_3=53$ STAT DEG
\downarrow 0 ENTER	$FRQ=0$ STAT DEG 0.
STATVAR \rightarrow	n \bar{x} Sx σX STAT DEG 86.
2nd EXIT STAT STATVAR	EXIT ST: Y N STAT DEG
ENTER	 DEG

2nd **EXIT STAT**
STATVAR



Entering 2-VAR Stat Data

The table below shows the number of pairs of athletic shoes sold by a small shoe store. Enter this data as the data points.

Month	Total No.(x)	Brand A (y)
April	58 (x1)	35 (y1)
May	47 (x2)	28 (y2)

Press Display

$\boxed{2^{nd}}$ $\overset{\text{STAT}}{\boxed{\text{DATA}}}$ \blacktriangleright	<i>1-VAR</i> <i>2-VAR</i> \rightarrow DEG
$\boxed{\text{ENTER}}$ $\boxed{\text{DATA}}$	<i>X1=</i> \updownarrow STAT DEG
58	<i>X1=58</i> \updownarrow STAT DEG
\blacktriangledown 35	<i>Y1=35</i> \updownarrow STAT DEG
\blacktriangledown 47	<i>X2=47</i> \updownarrow STAT DEG
\blacktriangledown 28	<i>Y2=28</i> \updownarrow STAT DEG
$\boxed{\text{ENTER}}$	<i>Y2=28</i> \updownarrow STAT DEG 28.

Continued

$\boxed{2^{nd}}$ $\overset{\text{STAT}}{\boxed{\text{DATA}}}$ $\boxed{\text{DATA}}$



Viewing the Data (Continued)

If the store sells 32 pairs of shoes in June, predict the June sales of Brand A. When finished, exit **STAT** mode and clear all data points.

Press

Display

STATVAR 

$\leftarrow X' \quad \underline{Y'}$
STAT DEG

ENTER 32 **)**

$Y' (32)$
18.45454545
STAT DEG

ENTER

EXIT STAT
2nd **STATVAR**

EXIT ST: \underline{Y} N
STAT DEG

ENTER

DEG

STATVAR

EXIT STAT
2nd **STATVAR**



Keys

1. $\boxed{\text{TAN}}$ calculates the tangent.
2. $\boxed{2\text{nd}} \boxed{[\text{TAN}^{-1}]}$ calculates the inverse tangent.
3. $\boxed{\text{COS}}$ calculates the cosine.
4. $\boxed{2\text{nd}} \boxed{[\text{COS}^{-1}]}$ calculates the inverse cosine.
5. $\boxed{\text{SIN}}$ calculates the sine.
6. $\boxed{2\text{nd}} \boxed{[\text{SIN}^{-1}]}$ calculates the inverse sine.

Notes

- The examples on the transparency masters assume all default settings.
- Before starting a trigonometric calculation, be sure to select the appropriate angle mode setting (**degree**, **radian**, or **gradient**— See Chapter 16, Angle Settings and Conversions). The calculator interprets values according to the current angle-unit mode setting.
- $\boxed{)}$ ends a trig function.

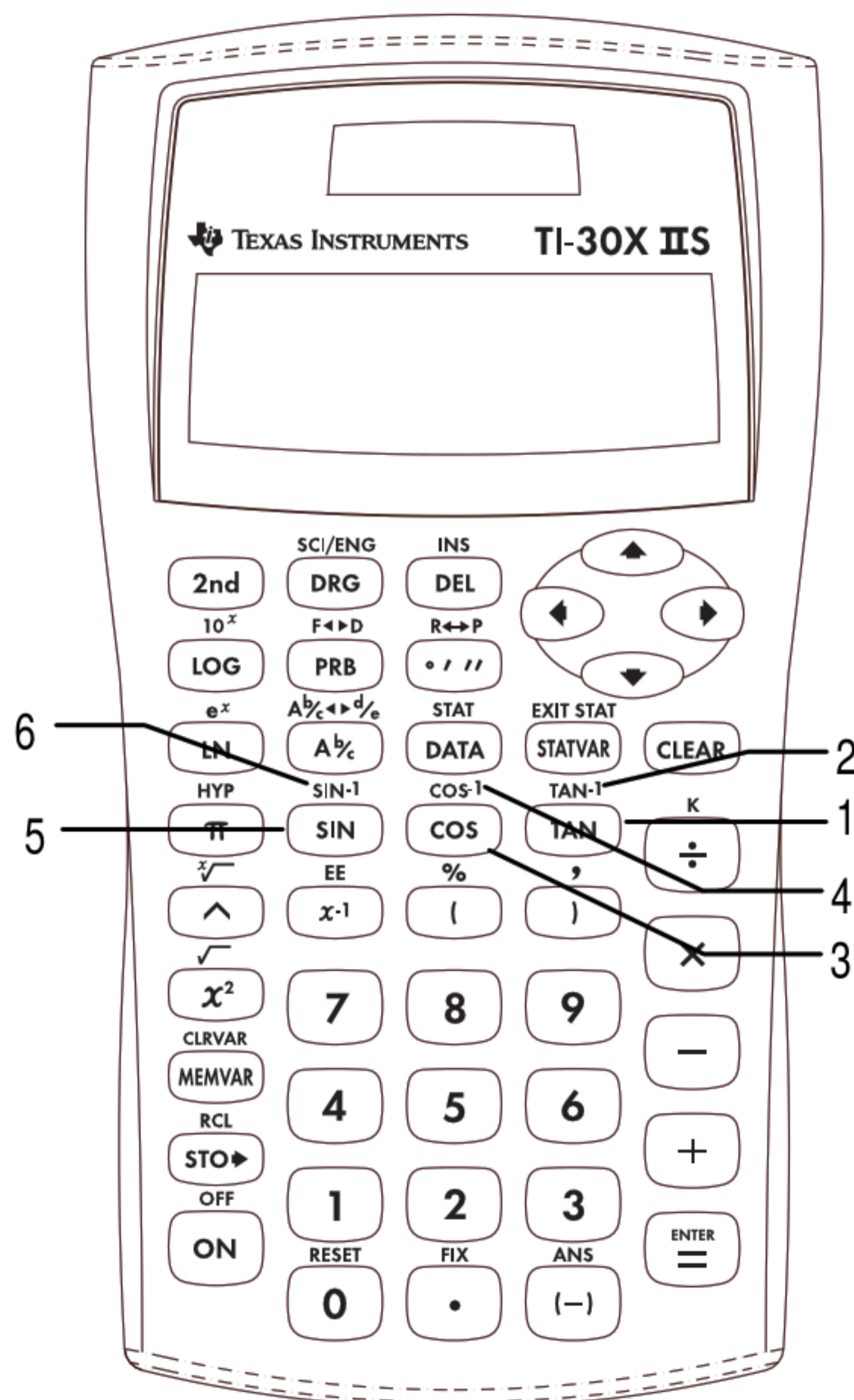

Tangent

Use this formula to find the distance from the lighthouse to the boat. Round your answer to the nearest whole number, and then return to floating decimal mode.

$$D = 78 / \text{TAN } 27$$

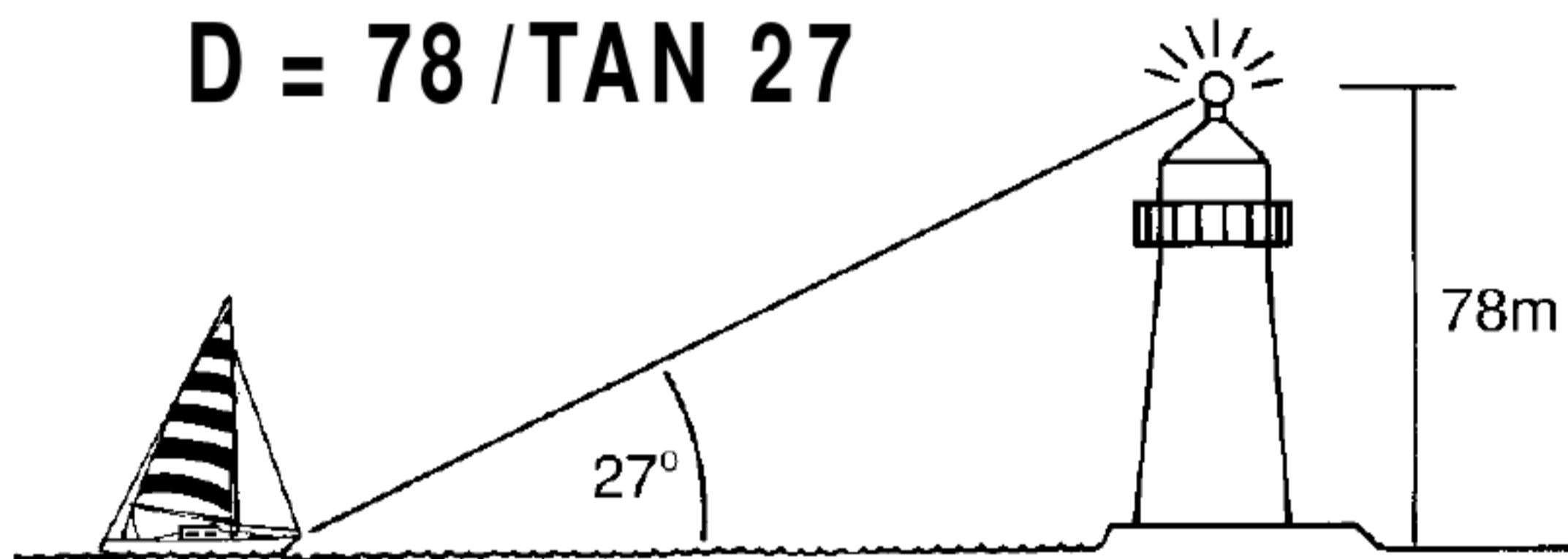

Press

Display

78 \div TAN
27 $)$ ENTER

78/tan (27) ↑
153.0836194
DEG

2nd $\overset{\text{FIX}}{\cdot}$ \blacktriangleright

F0123456789
DEG

ENTER

78/tan (27) ↑
FIX 153.
DEG

2nd $\overset{\text{FIX}}{\cdot}$ \cdot

78/tan (27) ↑
153.0836194
DEG

TAN



Inverse Tangent

Use this formula to find the angle of depression. Round your answer to the nearest tenth, and then return to floating decimal mode.

$$\text{TAN } x = 600 / 2500$$

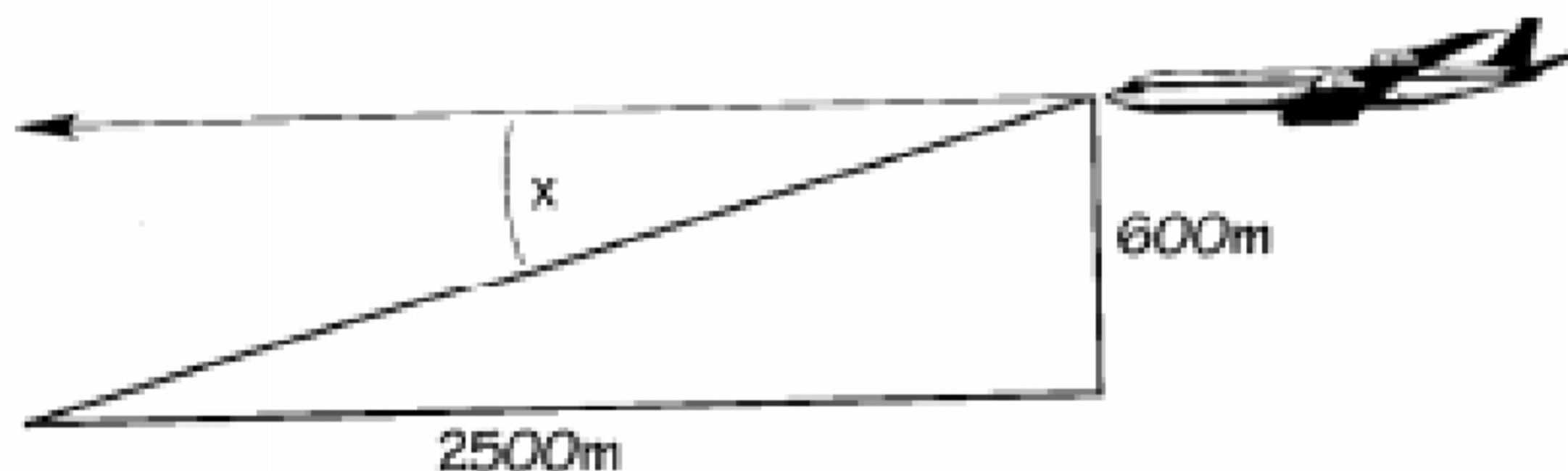

Press

Display

$\boxed{2\text{nd}} \overset{\text{TAN}^{-1}}{\boxed{\text{TAN}}} 600 \boxed{\div}$
 $2500 \boxed{)} \boxed{\text{ENTER}}$

$\text{tan}^{-1}(600/25) \rightarrow \uparrow$
 13.49573328
 DEG

$\boxed{2\text{nd}} \overset{\text{FIX}}{\boxed{\cdot}} \rightarrow \rightarrow$

$F0123456789$
 DEG

$\boxed{\text{ENTER}}$

$\text{tan}^{-1}(600/25) \rightarrow \uparrow$
 13.5
 FIX DEG

$\boxed{2\text{nd}} \overset{\text{FIX}}{\boxed{\cdot}} \boxed{\cdot}$

$\text{tan}^{-1}(600/25) \rightarrow \uparrow$
 13.49573328
 DEG

$\overset{\text{TAN}^{-1}}{\boxed{2\text{nd}}} \boxed{\text{TAN}}$



Cosine

Use this formula to find how far the base of the ladder is from the house. Round your answer to the nearest whole number, and then return to floating decimal mode.

$$D = 5 \times \text{COS } 75$$

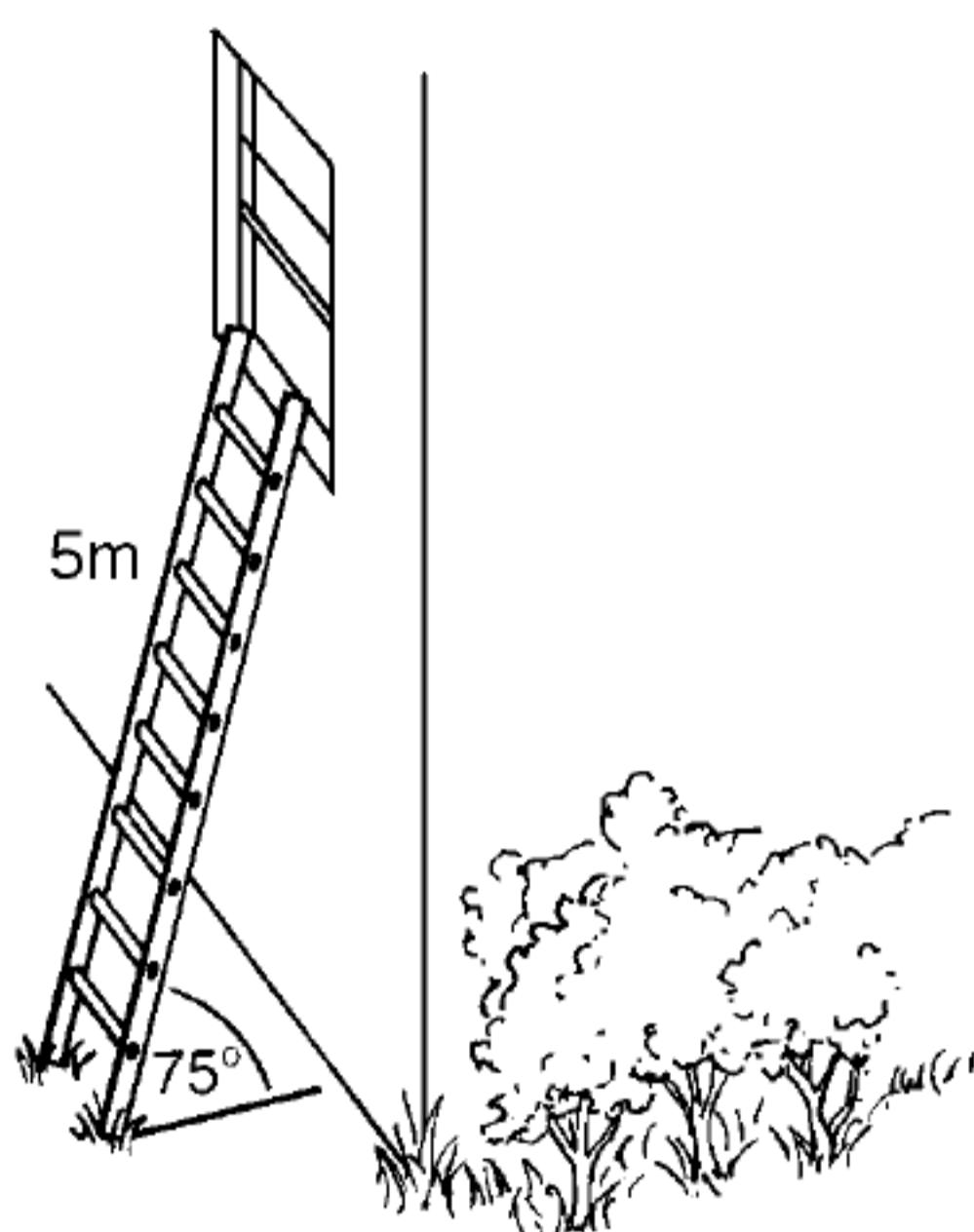

Press

Display

5 \times COS
75) ENTER

5*cos (75)
1.294095226
DEG

2nd ^{FIX} . \blacktriangleright

F0123456789
DEG

ENTER

5*cos (75)
FIX 1.
DEG

2nd ^{FIX} . .

5*cos (75)
1.294095226
DEG

COS



Inverse Cosine

Use this formula to find the angle of the ski jump. Round your answer to the nearest tenth, and then return to floating decimal mode.

$$\cos x = 453/500$$

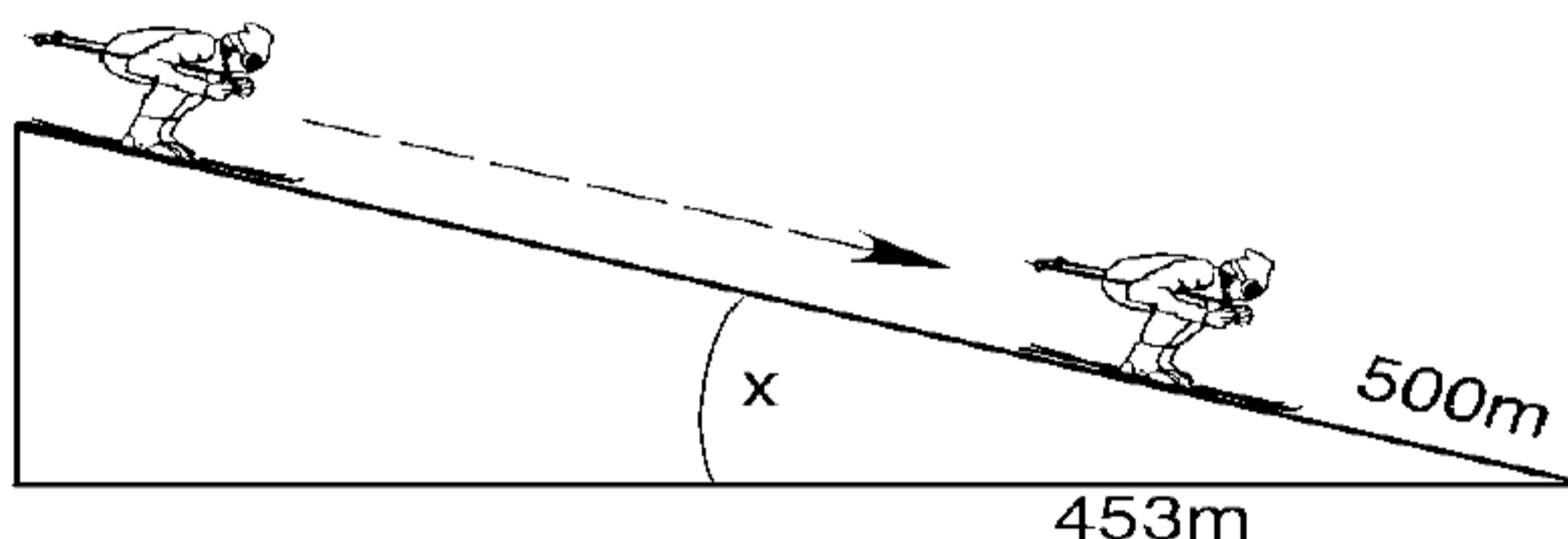

Press

Display

$\boxed{2^{nd}} \overset{\text{COS}^{-1}}{\boxed{\text{COS}}} 453 \boxed{\div}$
 $500 \boxed{)} \boxed{\text{ENTER}}$

cos⁻¹ (453/500 → ↑
 25.04169519
 DEG

$\boxed{2^{nd}} \overset{\text{FIX}}{\boxed{\cdot}} \rightarrow \rightarrow$

F0123456789
 DEG

$\boxed{\text{ENTER}}$

cos⁻¹ (453/500 → ↑
 25.0
 DEG

$\boxed{2^{nd}} \overset{\text{FIX}}{\boxed{\cdot}} \boxed{\cdot}$

cos⁻¹ (453/500 → ↑
 25.04169519
 DEG

$\boxed{2^{nd}} \overset{\text{COS}^{-1}}{\boxed{\text{COS}}}$



Sine

Use this formula to find the length of the ramp. Round your answer to the nearest whole number, and then return to floating decimal mode.

$$D = 1.5 / \sin 12$$

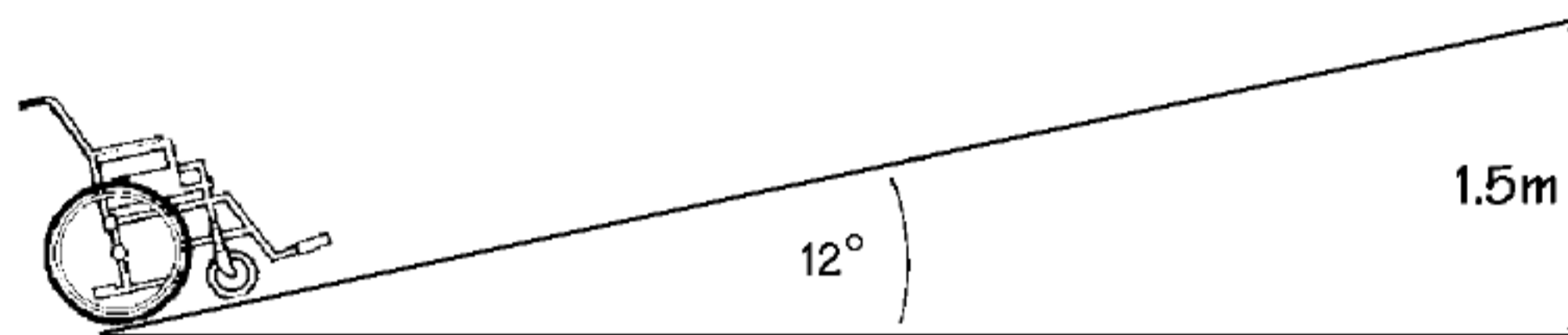

SIN

Press

Display

1 \square . 5 \square \div **SIN**
12 \square) **ENTER**

1.5/sin (12) $\rightarrow \uparrow$
7.214601517
DEG

2nd \square **FIX** \square \rightarrow

F 0 1 2 3 4 5 6 7 8 9
DEG

ENTER

1.5/sin (12) $\rightarrow \uparrow$
FIX 7
DEG

2nd \square **FIX** \square \square

1.5/sin (12) $\rightarrow \uparrow$
7.214601517
DEG



Inverse Sine

Use this formula to find the angle of the conveyor belt. Round your answer to the nearest tenth, and then return to floating decimal mode.

$$\sin x = 13/20$$

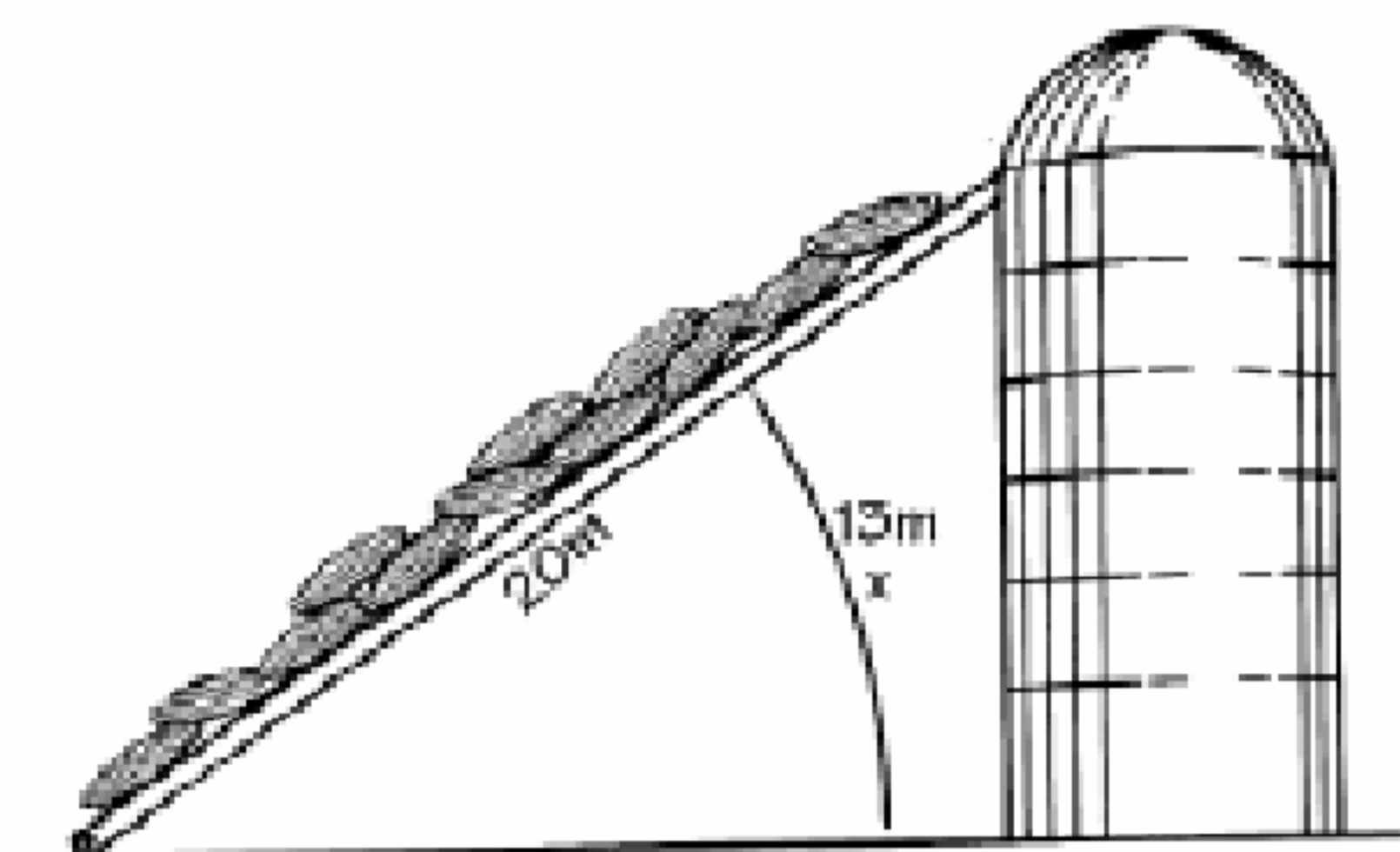

$$\boxed{2\text{nd}} \overset{\text{SIN}^{-1}}{\boxed{\text{SIN}}}$$

Press

Display

$\boxed{2\text{nd}} \overset{\text{SIN}^{-1}}{\boxed{\text{SIN}}} 13 \boxed{\div}$
 $20 \boxed{)} \boxed{\text{ENTER}}$

$\sin^{-1}(13/20) \rightarrow \uparrow$
 40.54160187
 DEG

$\boxed{2\text{nd}} \overset{\text{FIX}}{\boxed{\cdot}} \rightarrow \rightarrow$

$F0123456789$
 DEG

$\boxed{\text{ENTER}}$

$\sin^{-1}(13/20) \rightarrow \uparrow$
 40.5
 FIX DEG

$\boxed{2\text{nd}} \overset{\text{FIX}}{\boxed{\cdot}} \boxed{\cdot}$

$\sin^{-1}(13/20) \rightarrow \uparrow$
 40.54160187
 DEG



Keys

1. $\boxed{2\text{nd}}$ [SCI/ENG] displays the following numeric notation mode menu.

FLO Restores standard mode (floating decimal).

SCI Turns on scientific mode and displays results as a number from 1 to 10 ($1 \leq n < 10$) times 10 to an integer power.

ENG Turns on engineering mode and displays results as a number from 1 to 1000 ($1 \leq n < 1000$) times 10 to an integer power. The integer power is always a multiple of 3.

2. $\boxed{2\text{nd}}$ [EE] lets you enter and calculate the exponent.

Notes

- The examples on the transparency masters assume all default settings.
- You can enter a value in scientific notation regardless of the numeric notation mode setting. For a negative exponent, press $\boxed{(-)}$ before entering it.
- Results requiring more than 10 digits are automatically displayed in scientific notation.
- For the decimal notation mode, refer to $\boxed{2\text{nd}}$ [FIX] in Chapter 6, Decimals and Decimal Places.
- These modes (**FLO**, **SCI**, and **ENG**) affect *only* the display of results.

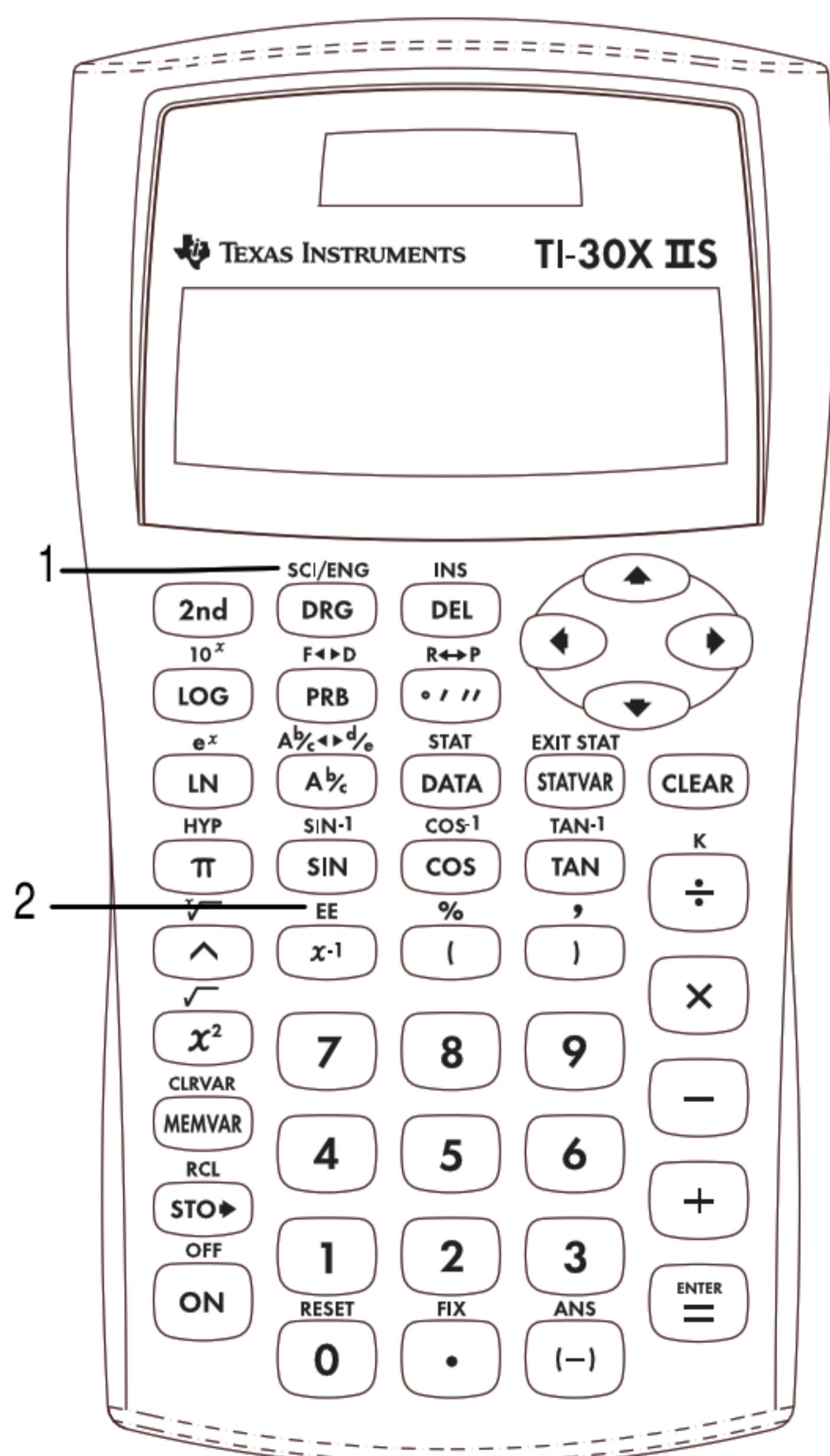

Engineering, Scientific, Floating Decimal

Enter 12543, which will be in floating decimal notation (default), and alternate between scientific and engineering notations.

Press	Display
12543	<i>FLO SCI ENG</i> DEG
2nd SCI/ENG DRG \blacktriangleright	
ENTER ENTER	12543 \uparrow 1.2543 $\times 10^{04}$ SCI DEG
2nd SCI/ENG DRG \blacktriangleright	<i>FLO SCI ENG</i> SCI DEG
ENTER	12543 \uparrow 12.543 $\times 10^{03}$ ENG DEG
2nd SCI/ENG DRG \blacktriangleright	<i>FLO SCI ENG</i> ENG DEG
ENTER	12543 \uparrow 12543. DEG

2nd SCI/ENG DRG



Exponent

The Earth is 1.496×10^8 kilometers from the Sun. Jupiter is 7.783×10^8 kilometers from the Sun. Enter the numbers in scientific notation and determine how far away the Earth is from Jupiter.

Press

Display

7 \square 783

\square $\overset{\text{EE}}{x^{-1}}$ 8

\square 1 \square 496

\square $\overset{\text{EE}}{x^{-1}}$ 8

\square ENTER

7.783E8-1.4 \rightarrow \uparrow
628700000.
DEG

\square $\overset{\text{EE}}{x^{-1}}$



Keys

1. **[LOG]** calculates the common logarithm (base 10).
2. **[LN]** calculates the natural logarithm (base e , where $e = 2.718281828459$).
3. **[2nd] [10^x]** calculates the common antilogarithm (10 raised to the power of the value).
4. **[2nd] [e^x]** calculates the natural antilogarithm (e raised to the power of the value).

Notes

- The examples on the transparency masters assume all default settings.
- **[)]** ends a logarithmic function.

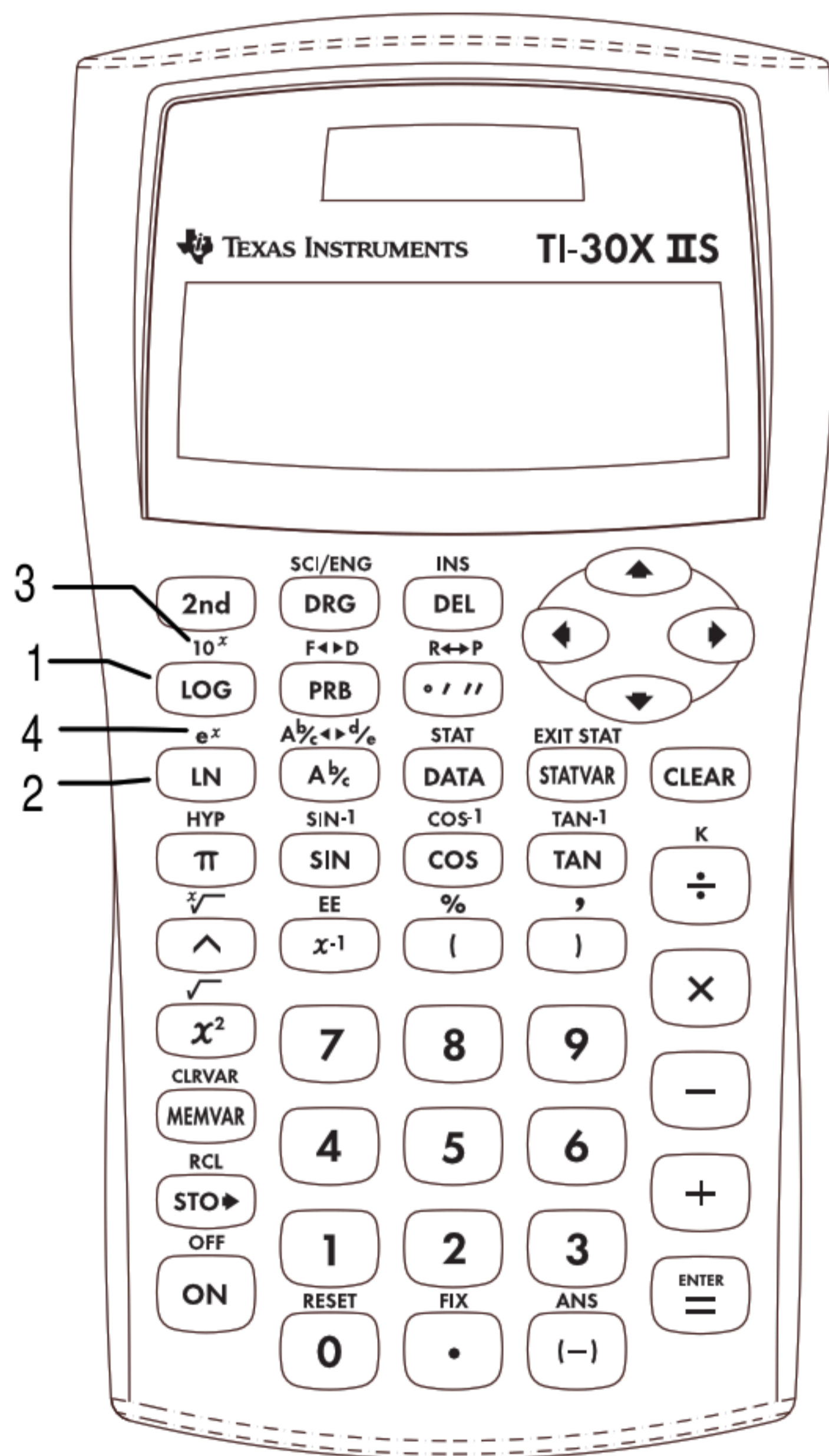

Common Logarithm, Natural Logarithm

Find $\log 23$ rounded to 4 decimal places. Then find $\ln 23$ rounded to 4 decimal places and return to floating decimal notation.

Press

Display

LOG 23 **)**
ENTER

log (23) ↑
1.361727836
DEG

2nd ^{FIX} **.**

E0123456789
DEG

4

log (23) ↑
1.3617
FIX DEG

LN 23 **)**
ENTER

ln (23) ↑
3.1355
FIX DEG

2nd ^{FIX} **.** **.**

ln (23) ↑
3.135494216
DEG

LOG **LN**

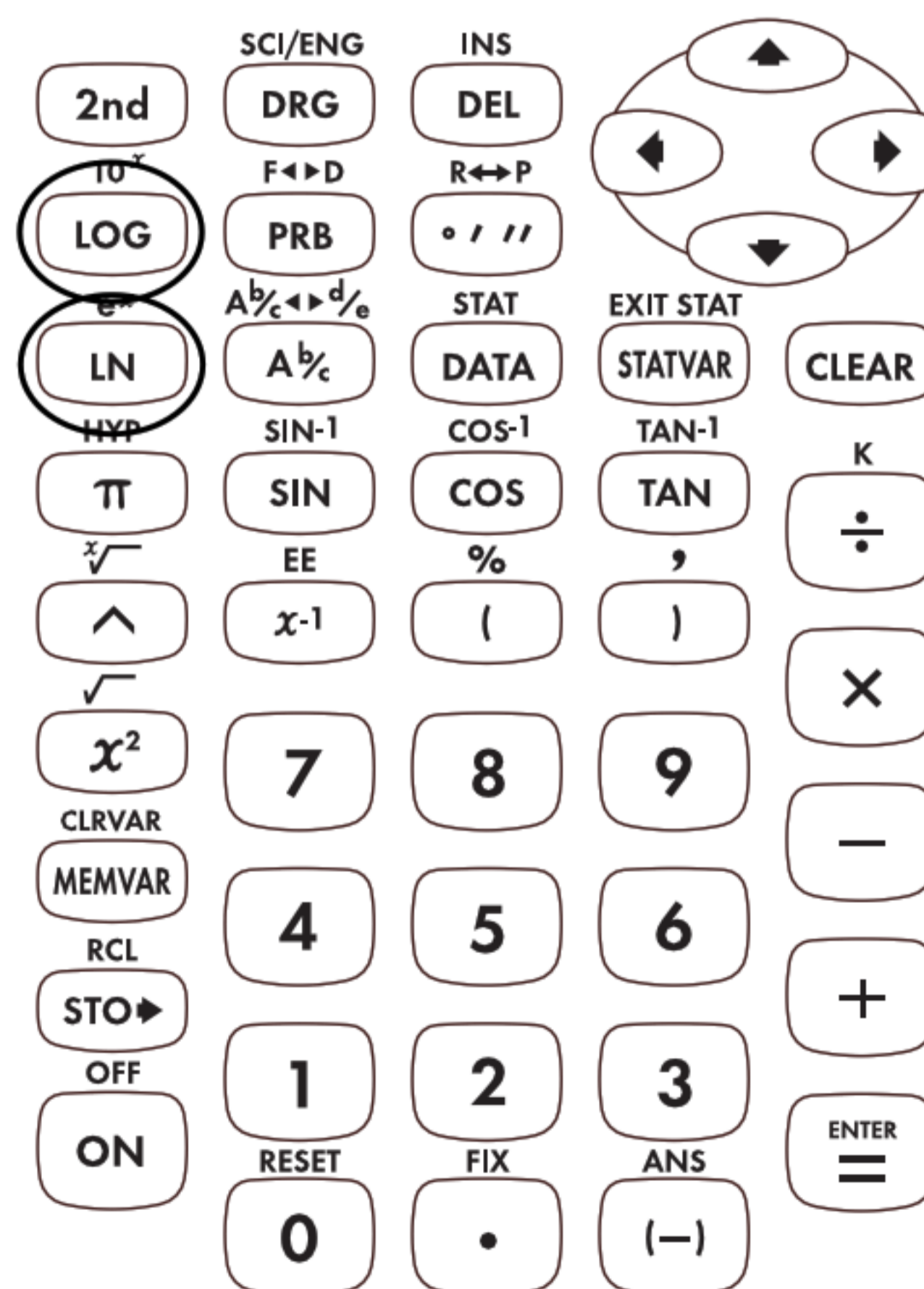

Common Antilogarithm, Natural Antilogarithm

Find antilog 3.9824 rounded to 4 decimal places. Then find antiln 3.9824 rounded to 4 decimal places. When finished, return to floating decimal notation.

Press

Display

10^x
 $\boxed{2nd} \boxed{LOG} 3 \boxed{\cdot}$
 9824 $\boxed{)}$ \boxed{ENTER}

$10^{(3.9824)}$ ↑
 9602.846792
 DEG

FIX
 $\boxed{2nd} \boxed{\cdot}$

$E0123456789$
 DEG

4

$10^{(3.9824)}$ ↑
 9602.8468
 FIX DEG

e^x
 $\boxed{2nd} \boxed{LN} 3 \boxed{\cdot}$
 9824 $\boxed{)}$ \boxed{ENTER}

$e^{(3.9824)}$ ↑
 53.6456
 FIX DEG

FIX
 $\boxed{2nd} \boxed{\cdot} \boxed{\cdot}$

$e^{(3.9824)}$ ↑
 53.64562936
 DEG

10^x
 $\boxed{2nd} \boxed{LOG}$

e^x
 $\boxed{2nd} \boxed{LN}$

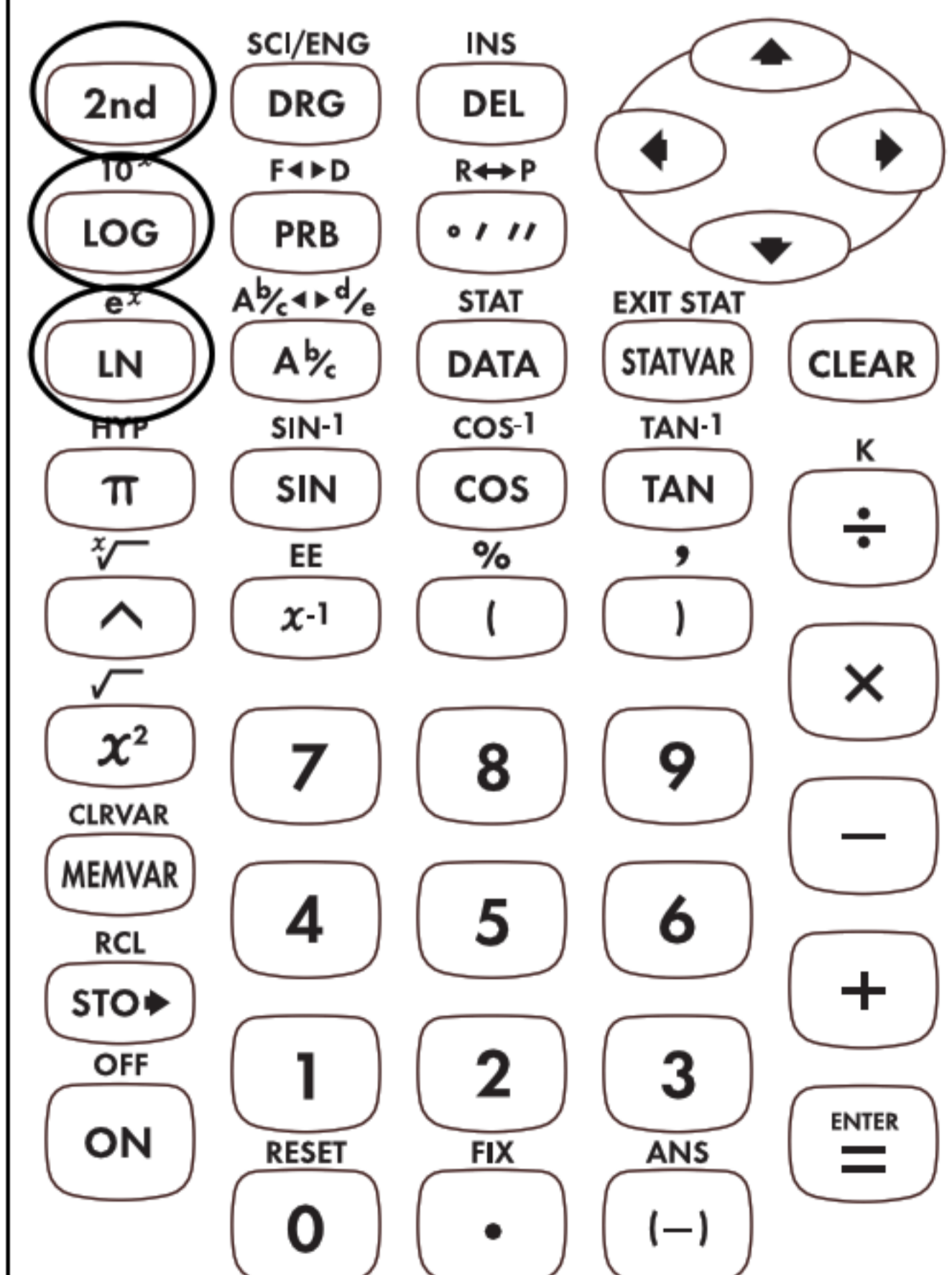

Keys

1. **DRG** displays the following menu that lets you change the angle mode setting to **DEG**, **RAD**, and **GRD** without affecting the value in the display.

DEG Sets degree mode.

RAD Sets radian mode.

GRD Sets gradient mode.

The default setting is **DEG**.

2. **0''** displays a menu that lets you specify the unit of an angle.

$^{\circ}$ Specifies degrees.

' Specifies minutes.

" Specifies seconds.

r Specifies radians.

g Specifies gradients.

DMS Lets you convert an angle from decimal degrees to **DMS** notation.

Notes

- The examples on the transparency masters assume all default settings.
- Angles with a trig function ignore the angle mode setting and display results in the original unit. Otherwise, angles (without a trig function) are converted and displayed according to the angle mode setting.
- You enter decimal-degree angles the same as you would any other number.
- For decimal/**DMS** conversions, the calculator interprets all values as degrees, regardless of the angle-unit setting.
- **DMS** angles are entered as $^{\circ}$ (degrees), ' (minutes), and " (seconds).

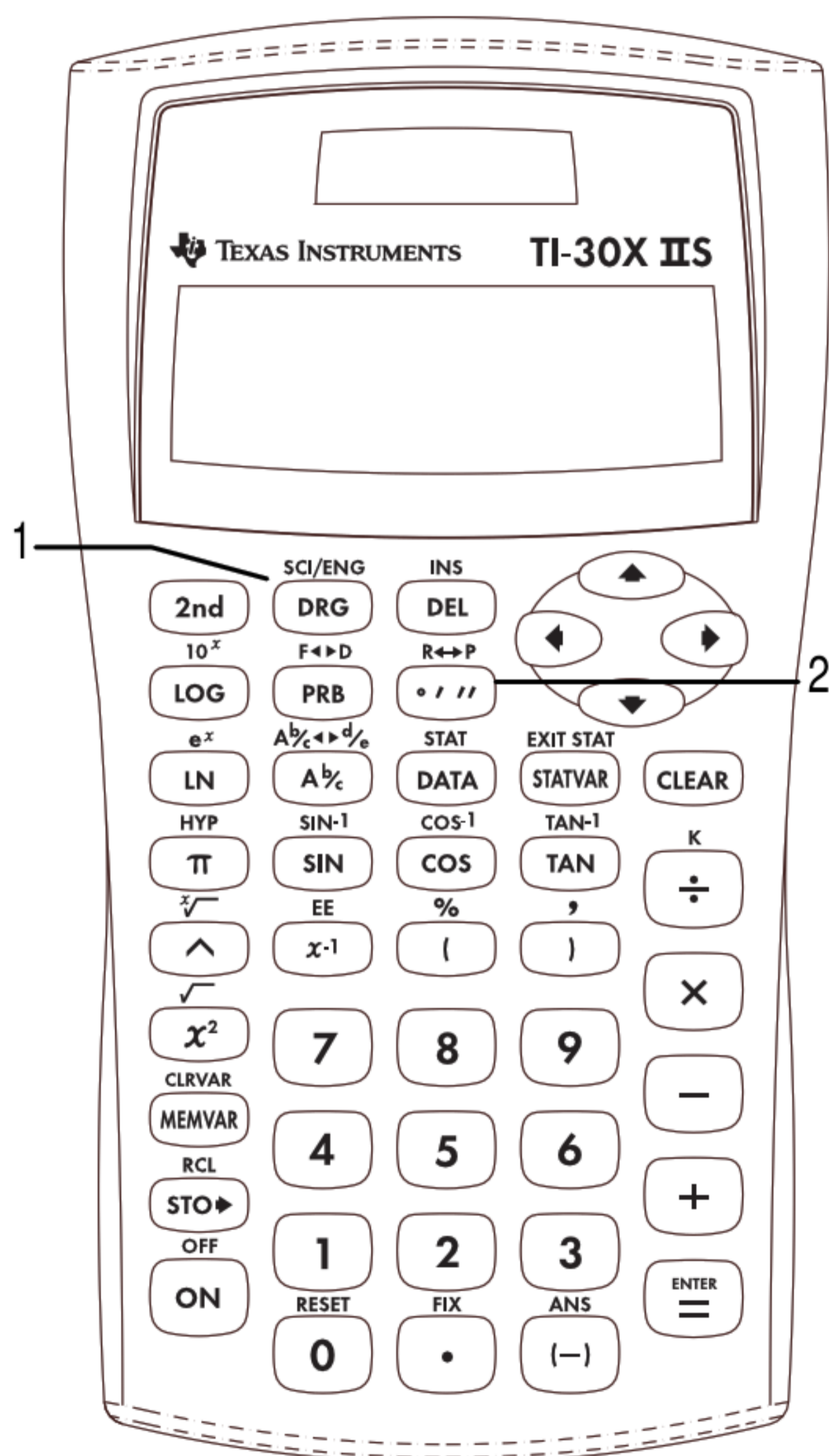

Degrees, Minutes, and Seconds to Decimal

You watched 2 videos that were 2:05 (2 hours and 5 minutes) and 1:46 (1 hour and 46 minutes) in length. How long did you watch videos?

Press

Display

2 

DEG



2°
DEG

5  

0 5' 
DEG

  1 



2° 5' + 1°
DEG



46  

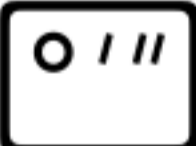

2° 5' + 1° 46' 
3.85
DEG

 ~~DMS~~
DEG

Ans  ~~DMS~~ 
3° 51' 0"
DEG



Fraction to Degrees, Minutes, and Seconds

How much is $\frac{2}{3}$ of an hour in hours, minutes, and seconds?

Press

Display

2 $\boxed{\text{Ab/c}}$ 3

$2\frac{2}{3}$
DEG

$\boxed{\circ//''}$ \leftarrow

\leftarrow DMS
DEG

$\boxed{\text{ENTER}}$ $\boxed{\text{ENTER}}$

$2\frac{2}{3}$ \rightarrow DMS \uparrow
 $0^\circ 40' 0''$
DEG



Degrees, Radians, Gradients

Calculate the sine of 30 in degrees, radians, and gradients.

DRG

Press

Display

SIN 30 **)**

sin(30) ↑
0.5
DEG

ENTER

DRG **▶**

DEG RAD GRD
DEG

ENTER **ENTER**

sin(30) ↑
-0.988031624
RAD

DRG **▶**

DEG RAD GRD
RAD

ENTER **ENTER**

sin(30) ↑
0.4539905
GRAD

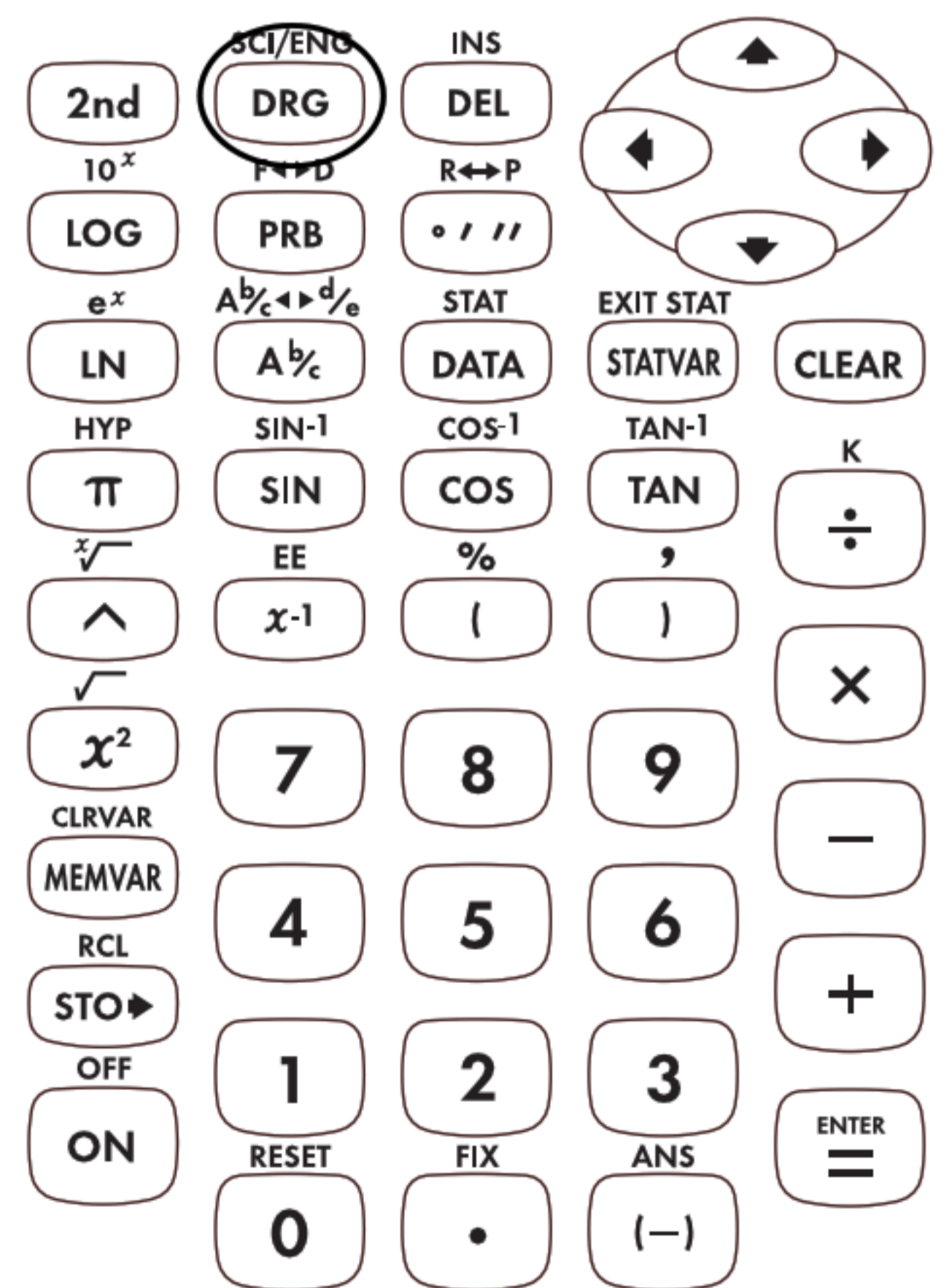

Keys

1. $\boxed{2\text{nd}}$ $\boxed{R\leftrightarrow P}$ displays the following menu that lets you convert rectangular coordinates (x,y) to polar coordinates (r,θ) or vice versa.

R \rightarrow Pr Converts rectangular coordinate to polar coordinate r .

R \rightarrow P θ Converts rectangular coordinate to polar coordinate θ .

P \rightarrow R x Converts polar coordinate to rectangular coordinate x .

P \rightarrow R y Converts polar coordinate to rectangular coordinate y .

2. $\boxed{2\text{nd}}$ $\boxed{,}$ enters a comma.

Notes

- The example on the transparency master assumes all default settings.
- Before starting calculations, set angle mode as necessary.

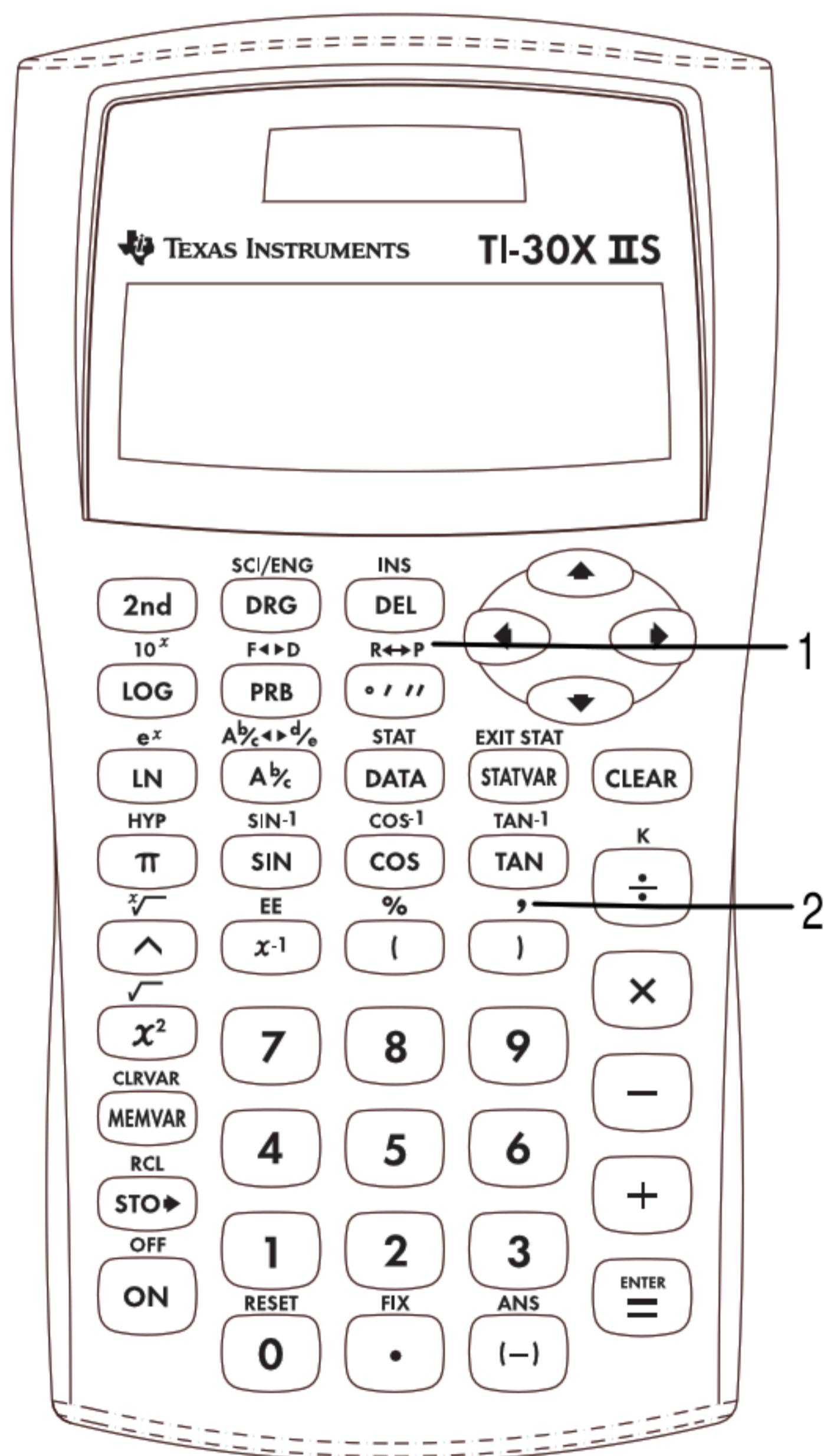

Polar to Rectangular

Convert the polar ordered pair $(7, 30)$ to rectangular using the DEG ($^\circ$) angle unit.

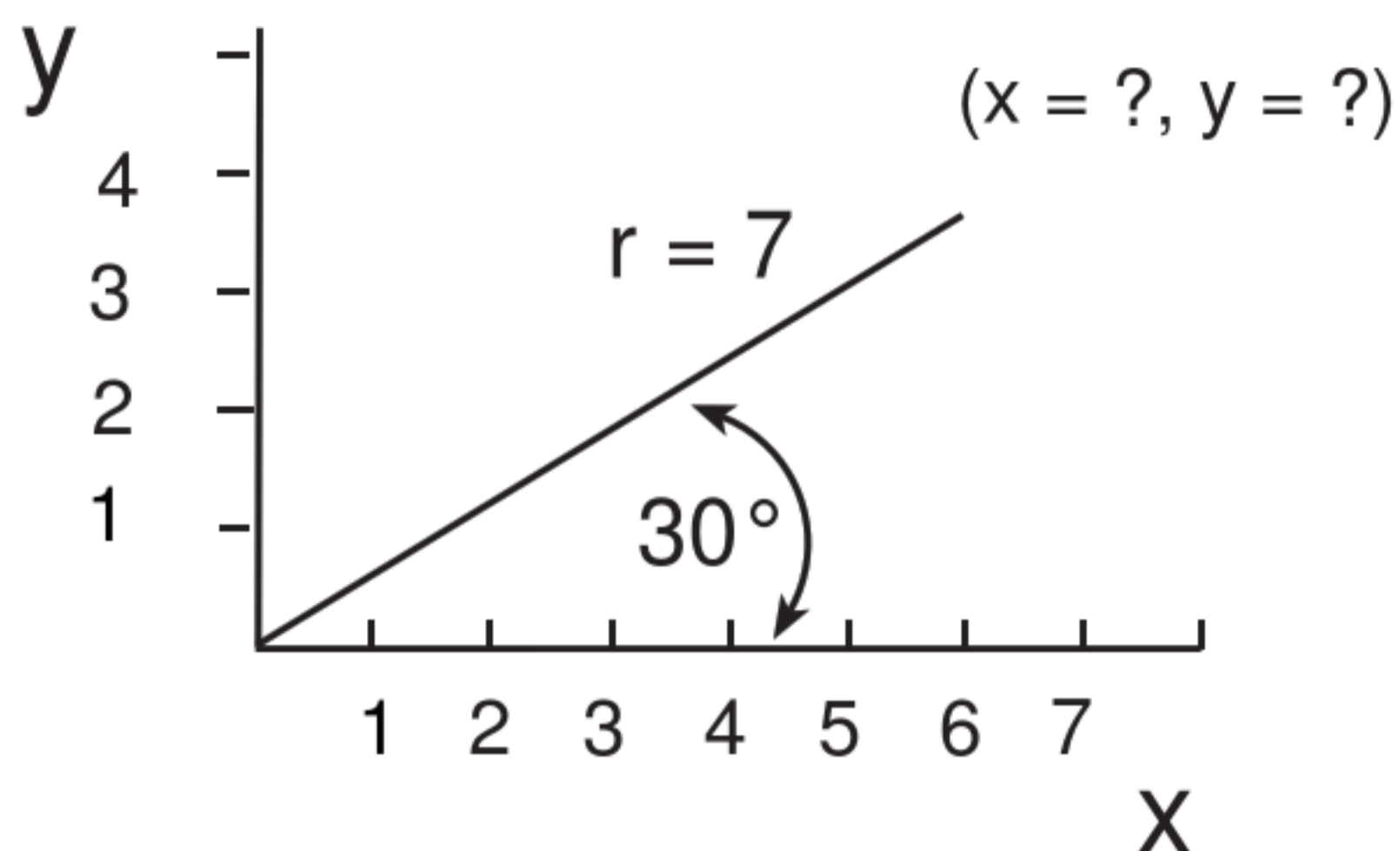

2nd $\overset{R \leftrightarrow P}{\circ / ''}$

Press

Display

2nd $\overset{R \leftrightarrow P}{\circ / ''}$ \rightarrow \rightarrow

\leftarrow P \rightarrow Rx P \rightarrow Ry
DEG

ENTER 7 **2nd** $\overset{'}{)}$
30 $\overset{)}{)$ ENTER

P \rightarrow Rx(7,30) \uparrow
6.062177826
DEG

2nd $\overset{R \leftrightarrow P}{\circ / ''}$ \leftarrow

\leftarrow P \rightarrow Rx P \rightarrow Ry
DEG

ENTER 7 **2nd** $\overset{'}{)}$
30 $\overset{)}{)$ ENTER

P \rightarrow Ry(7,30) \uparrow
3.5
DEG

The rectangular ordered pair is 6.062177826, 3.5.



Keys

1. **[2nd] [HYP]** accesses the hyperbolic (**sinh**, **cosh**, **tanh**) function of the next trig key that you press.

Notes

- The example on the transparency master assumes all default settings.
- Hyperbolic calculations are not affected by the angle mode setting—whether or not the calculator is in **RAD** (radian), **GRD** (gradient), or **DEG** (degree) modes.

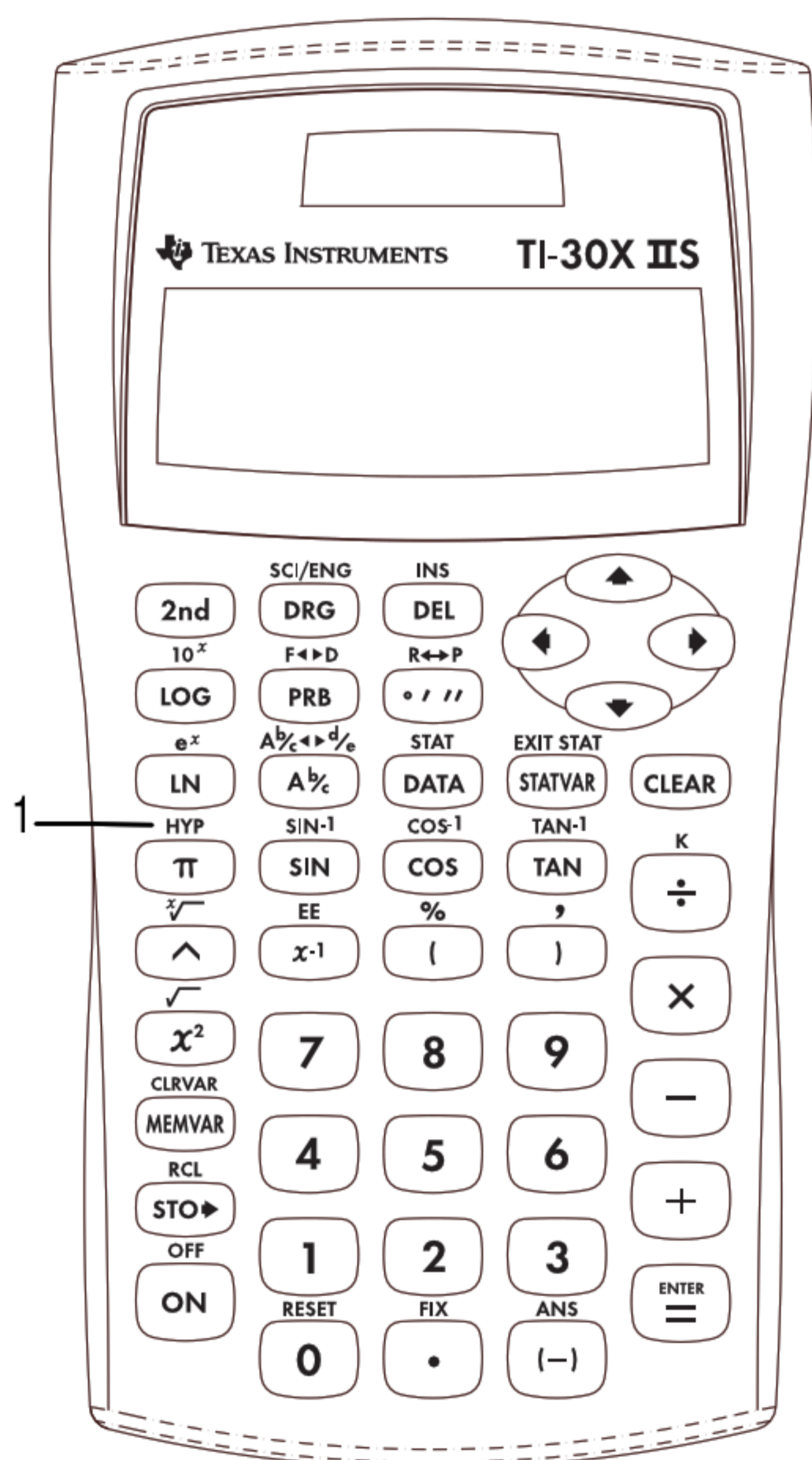

Sine, Cosine, Tangent

Find the hyperbolic sine (sinh), cosine (cosh), and tangent (tanh) of 5.

Press

Display

$\boxed{2^{nd}} \overset{HYP}{\boxed{\pi}} \boxed{SIN} 5$
 $\boxed{)} \boxed{ENTER}$

sinh(5) ↑
 74.20321058
 DEG

$\boxed{2^{nd}} \overset{HYP}{\boxed{\pi}} \boxed{COS} 5$
 $\boxed{)} \boxed{ENTER}$

cosh(5) ↑
 74.20994852
 DEG

$\boxed{2^{nd}} \overset{HYP}{\boxed{\pi}} \boxed{TAN} 5$
 $\boxed{)} \boxed{ENTER}$





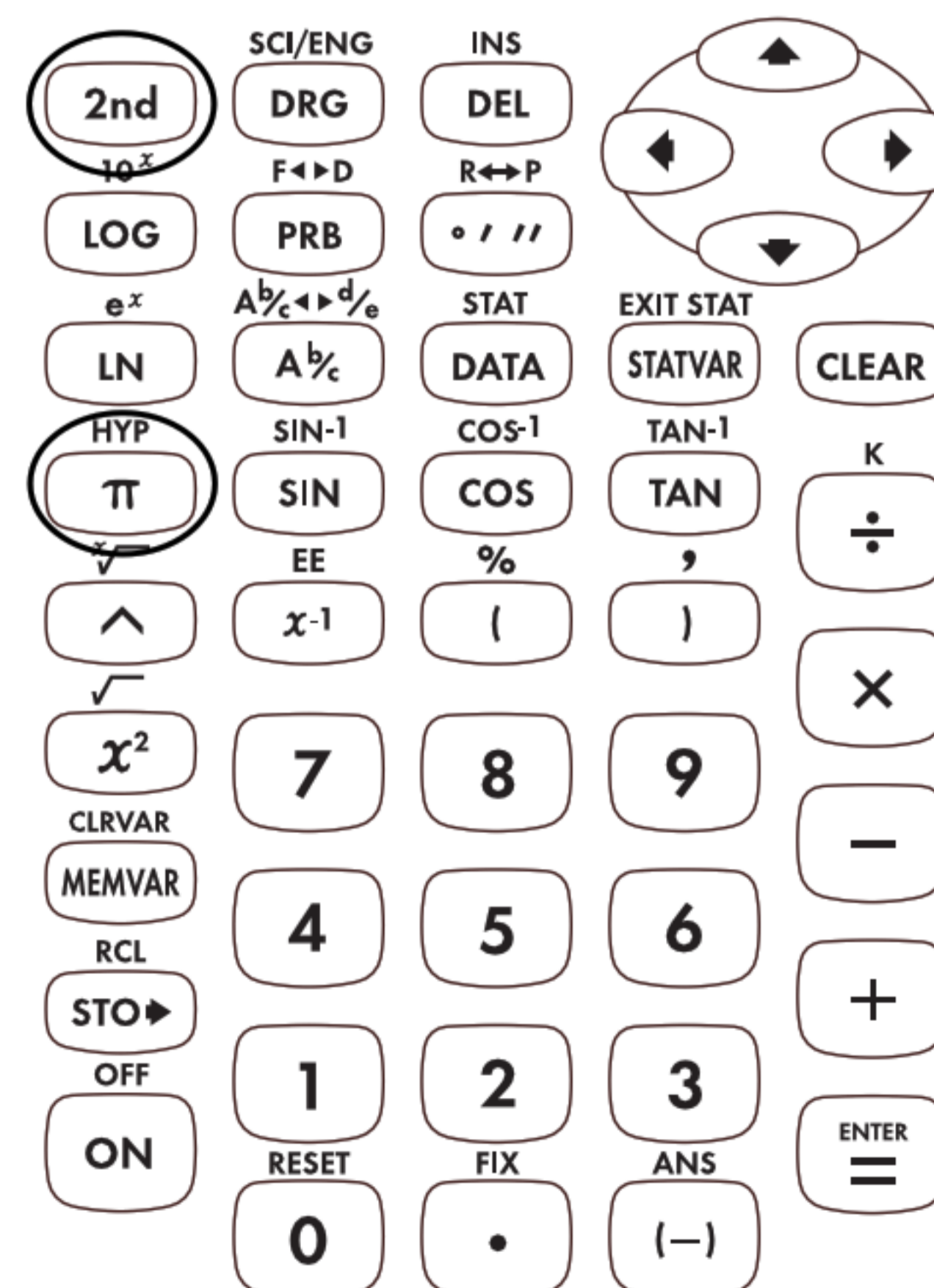















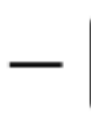

tanh(5) ↑
 0.999909204
 DEG

$\boxed{2^{nd}} \overset{HYP}{\boxed{\pi}}$

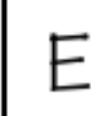

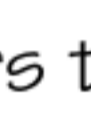
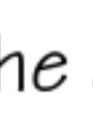
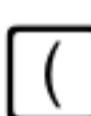
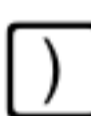
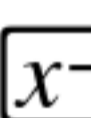
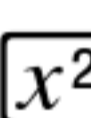
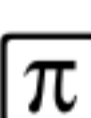
Quick Reference to Keys

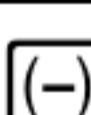
A

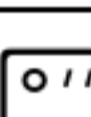
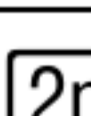
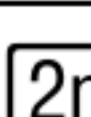
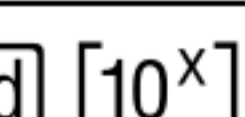
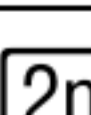
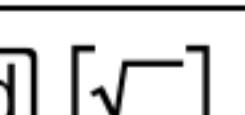
KEY	FUNCTION
   	<p>Moves the cursor left and right so you can scroll the entry line. Press 2nd  or 2nd  to scroll to the beginning or end of the entry line.</p> <p>Moves the cursor up and down so you can see previous entries. Press 2nd  or 2nd  to scroll to the beginning or end of the history.</p>
   	Adds, subtracts, multiplies, and divides.
         	Enters the digits 0 through 9.
	Opens a parenthetical expression.
	Closes a parenthetical expression.
	Calculates the reciprocal.
	Squares the value.
	Enters the value of pi rounded to 10 digits (3.141592654).
	Enters a decimal point.
	Indicates the value is negative.
	Raises a value to a specified power.
	<p>Displays the following menu that lets you specify the unit of an angle.</p> <ul style="list-style-type: none"> ◦ Specifies degrees. ' Specifies minutes. " Specifies seconds. r Specifies radians. g Specifies gradients. <p>► DMS Lets you convert an angle from decimal degrees to DMS notation.</p>
	Turns on the 2nd indicator and accesses the function shown above the next key that you press.
 	Calculates the common antilogarithm (10 raised to the power of the value).
 	Calculates the square root.

Quick Reference to Keys (Continued)

A

KEY	FUNCTION
$\boxed{2\text{nd}}$ [%]	Changes a real number to percent. Results display according to the decimal notation mode setting.
$\boxed{2\text{nd}}$ [,]	Enters a comma.
$\boxed{2\text{nd}}$ [$\sqrt[x]{}$]	Calculates the specified root (x) of the value.
$\boxed{A\frac{b}{c}}$	Lets you enter mixed numbers and fractions.
$\boxed{2\text{nd}}$ [$A\frac{b}{c} \leftrightarrow d/e$]	Converts a simple fraction to a mixed number or a mixed number to a simple fraction.
$\boxed{2\text{nd}}$ [ANS]	Recalls the most recently calculated result, displaying it as Ans .
$\boxed{\text{CLEAR}}$	Clears characters and error messages on the entry line. Once the display is clear, it moves the cursor to the last entry in history.
$\boxed{2\text{nd}}$ [CLRVAR]	Clears all memory variables.
$\boxed{\text{COS}}$	Calculates the cosine.
$\boxed{2\text{nd}}$ [COS ⁻¹]	Calculates the inverse cosine.
$\boxed{\text{DATA}}$	Lets you enter the statistical data points (x for 1-VAR stats; x and y for 2-VAR stats).
$\boxed{\text{DEL}}$	Deletes the character at the cursor. If you hold $\boxed{\text{DEL}}$ down, it deletes all characters to the right. Then each time you press $\boxed{\text{DEL}}$, it deletes 1 character to the left of the cursor.
$\boxed{\text{DRG}}$	<p>Displays the following menu that lets you change the Angle mode to degrees (°), radians (r), or gradients (g), and then back to degrees without affecting the value in the display.</p> <p style="padding-left: 40px;">DEG Sets degree mode.</p> <p style="padding-left: 40px;">RAD Sets radian mode.</p> <p style="padding-left: 40px;">GRD Sets gradient mode.</p> <p>When you turn on the TI-30X IIS, it is always in the DEG mode.</p>
$\boxed{2\text{nd}}$ [e^x]	Calculates the natural antilogarithm (e raised to the power of the value).
$\boxed{2\text{nd}}$ [EE]	Lets you enter and calculate the exponent.
$\boxed{\text{ENTER}}$	Completes the operation or executes the command.

Quick Reference to Keys (Continued)

A

KEY	FUNCTION
2nd [EXIT STAT]	Displays the following menu that lets you clear data values and exit STAT mode. EXIT ST: Y N Press ENTER when Y (yes) is underlined to clear data values and exit STAT mode. Press ENTER when N (no) is underlined to return to the previous screen without exiting STAT mode.
2nd [F \leftrightarrow D]	Converts a fraction to its decimal equivalent or converts a decimal to its fractional equivalent, if possible.
2nd [FIX]	Displays the following menu that lets you set the number of decimal places. F 0 1 2 3 4 5 6 7 8 9 F Sets floating decimal (standard) notation. 0-9 Sets number of decimal places.
2nd [HYP]	Accesses the hyperbolic (sinh , cosh , tanh) function of the next trig key that you press.
2nd [INS]	Lets you insert a character at the cursor.
2nd [K]	Turns on the constant mode and lets you define a constant.
[LN]	Calculates the natural logarithm (base e , where $e = 2.718281828459$).
[LOG]	Calculates the common logarithm (base 10).
[MEMVAR]	Displays the following menu of variables. A B C D E Lets you view the stored value before pasting it to the display.
2nd [OFF]	Turns off the calculator and clears the display.
[ON]	Turns on the calculator.

Quick Reference to Keys (Continued)

A

KEY	FUNCTION
[PRB]	<p>Displays the following menu of functions.</p> <p>nPr Calculates the number of possible permutations.</p> <p>nCr Calculates the number of possible combinations.</p> <p>! Calculates the factorial.</p> <p>RAND Generates a random 10-digit real number between 0 and 1.</p> <p>RANDI Generates a random integer between 2 numbers that you specify. Separate the 2 numbers with a comma.</p>
[2nd] [RCL]	Recalls the stored values to the display.
[2nd] [RESET]	<p>Displays the RESET menu.</p> <p>RESET: N Y</p> <p>Press [ENTER] when N (no) is underlined to return to the previous screen without resetting the calculator.</p> <p>Press [ENTER] when Y (yes) is underlined to reset the calculator. The message MEM CLEARED is displayed.</p> <p>Also, press [ON] and [CLEAR] simultaneously to reset the calculator immediately. No menu or message is displayed.</p>
[2nd] [R↔P]	<p>Displays the following menu that lets you convert rectangular coordinates (x,y) to polar coordinates (r,θ) or vice versa.</p> <p>R►Pr Converts rectangular coordinate to polar coordinate r.</p> <p>R►Pθ Converts rectangular coordinate to polar coordinate θ.</p> <p>P►Rχ Converts polar coordinate to rectangular coordinate x.</p> <p>P►Ry Converts polar coordinate to rectangular coordinate y.</p>
[2nd] [SCI/ENG]	<p>Displays the following numeric notation mode menu.</p> <p>FLO Restores standard mode (floating decimal).</p> <p>SCI Turns on scientific mode and displays results as a number from 1 to 10 ($1 \leq n < 10$) times 10 to an integer power.</p> <p>ENG Turns on engineering mode and displays results as a number from 1 to 1000 ($1 \leq n < 1000$) times 10 to an integer power. The integer power is always a multiple of 3.</p>





Quick Reference to Keys (Continued)

A

KEY	FUNCTION
SIN	Calculates the sine.
2nd [SIN⁻¹]	Calculates the inverse sine.
2nd [STAT]	<p>Displays the following menu from which you can select 1-VAR, 2-VAR, or CLRDATA.</p> <p>1-VAR Analyzes data from 1 set of data with 1 measured variable—x.</p> <p>2-VAR Analyzes paired data from 2 sets of data with 2 measured variables—x, the independent variable, and y, the dependent variable.</p> <p>CLRDATA Clears data values without exiting STAT mode.</p>
[STATVAR]	<p>Displays the following menu of stat variables with their current values.</p> <p>n Number of x (or x,y) data points.</p> <p>\bar{x} or \bar{y} Mean of all x or y values.</p> <p>Sx or Sy Sample standard deviation of x or y.</p> <p>σ_x or σ_y Population standard deviation of x or y.</p> <p>Σx or Σy Sum of all x values or y values.</p> <p>Σx^2 or Σy^2 Sum of all x^2 values or y^2 values.</p> <p>Σxy Sum of $(x \times y)$ for all xy pairs in 2 lists.</p> <p>a Linear regression slope.</p> <p>b Linear regression y-intercept.</p> <p>r Correlation coefficient.</p>
[STO▶]	<p>Displays the following menu of variables.</p> <p>A B C D E Lets you select a variable in which to store the displayed value. The new variable replaces any previously stored value.</p> <p>rand Lets you set a seed value for random integers.</p>
[TAN]	Calculates the tangent.
2nd [TAN⁻¹]	Calculates the inverse tangent.

Display Indicators

B

INDICATOR	MEANING
2nd	2nd function.
HYP	Hyperbolic function.
FIX	Fixed-decimal setting.
SCI, ENG	Scientific or engineering notation.
STAT	Statistical mode.
DEG, RAD, GRAD	Angle mode (degrees, radians, or gradients).
K	Constant mode.
x ¹⁰	Precedes the exponent in scientific or engineering notation.
↑↓	An entry is stored in history before and/or after the active screen. Press  and  to scroll.
←→	An entry or menu displays beyond 11 digits. Press  or  to scroll.

Error Messages

C

MESSAGE	MEANING
ARGUMENT	A function does not have the correct number of arguments.
DIVIDE BY 0	You attempted to divide by 0. In statistics, $n = 1$.
DOMAIN	You specified an argument to a function outside the valid range. For example: For $x\sqrt{\quad}$ — $x = 0$ or $y < 0$ and x is not an odd integer. For y^x — y and $x = 0$; $y < 0$ and x is not an integer. For \sqrt{x} — $x < 0$. For LOG or LN — $x \leq 0$. For TAN — $x = 90^\circ, -90^\circ, 270^\circ, -270^\circ, 450^\circ$, etc. For SIN⁻¹ or COS⁻¹ — $ x > 1$. For nCr or nPr — n or r are not integers ≥ 0 . For $x!$ — x is not an integer between 0 and 69.
EQUATION LENGTH ERROR	An entry exceeds the digit limits (88 for entry line and 47 for statistics or constant entry lines); for example, combining an entry with a constant that exceeds the limit.
FRQ DOMAIN	FRQ value (in 1-variable statistics) < 0 or > 99 , or not an integer.
OVERFLOW	$ \theta \geq 1E10$, where θ is an angle in a trig, hyperbolic, or R►Pr function.
STAT	<ul style="list-style-type: none"> You pressed [STATVAR] with no defined data points. You pressed [DATA], [STATVAR], or [2nd] [EXIT STAT] when not in STAT mode. Statistical analyses do not have at least 2 data points ($n > 1$).
SYNTAX	The command contains a syntax error—entering more than 23 pending operations, 8 pending values, or having misplaced functions, arguments, parentheses, or commas.

Product Support

Customers in the U.S., Canada, Puerto Rico, and the Virgin Islands

For general questions, contact Texas Instruments Customer Support:

phone: **1-80-T-CARES (1-800-842-2737)**

e-mail: **ti-cares@ti.com**

For technical questions, call the Programming Assistance Group of Customer Support:

phone: **1-972-917-8324**

Customers outside the U.S., Canada, Puerto Rico, and the Virgin Islands

Contact TI by e-mail or visit the TI calculator home page on the World Wide Web.

e-mail: **ti-cares@ti.com**

internet: **www.ti.com/calc**

Product Service

Customers in the U.S. and Canada Only

Always contact Texas Instruments Customer Support before returning a product for service.

Customers outside the U.S. and Canada

Refer to the leaflet enclosed with this product or contact your local Texas Instruments retailer/distributor.

Other TI Products and Services

Visit the TI calculator home page on the World Wide Web.

www.ti.com/calc

Customers in the U.S. and Canada Only

One-Year Limited Warranty for Electronic Product

This Texas Instruments ("TI") electronic product warranty extends only to the original purchaser and user of the product.

Warranty Duration. This TI electronic product is warranted to the original purchaser for a period of one (1) year from the original purchase date.

This TI electronic product is warranted against defective materials and construction. **THIS WARRANTY IS VOID IF THE PRODUCT HAS BEEN DAMAGED BY ACCIDENT OR UNREASONABLE USE, NEGLIGENCE, IMPROPER SERVICE, OR OTHER CAUSES NOT ARISING OUT OF DEFECTS IN MATERIALS OR CONSTRUCTION.**

Warranty Disclaimers. ANY IMPLIED WARRANTIES ARISING OUT OF THIS SALE, INCLUDING BUT NOT LIMITED TO THE IMPLIED WARRANTIES OF MERCHANTABILITY AND FITNESS FOR A PARTICULAR PURPOSE, ARE LIMITED IN DURATION TO THE ABOVE ONE-YEAR PERIOD. TEXAS INSTRUMENTS SHALL NOT BE LIABLE FOR LOSS OF USE OF THE PRODUCT OR OTHER INCIDENTAL OR CONSEQUENTIAL COSTS, EXPENSES, OR DAMAGES INCURRED BY THE CONSUMER OR ANY OTHER USER.

Some states/provinces do not allow the exclusion or limitation of implied warranties or consequential damages, so the above limitations or exclusions may not apply to you.

Legal Remedies. This warranty gives you specific legal rights, and you may also have other rights that vary from state to state or province to province.

Warranty Performance. During the above one (1) year warranty period, your defective product will be either repaired or replaced with a reconditioned model of an equivalent quality (at TI's option) when the product is returned, postage prepaid, to Texas Instruments Service Facility. The warranty of the repaired or replacement unit will continue for the warranty of the original unit or six (6) months, whichever is longer. Other than the postage requirement, no charge will be made for such repair and/or replacement. TI strongly recommends that you insure the product for value prior to mailing.

Software. Software is licensed, not sold. TI and its licensors do not warrant that the software will be free from errors or meet your specific requirements. **All software is provided "AS IS."**

Copyright. The software and any documentation supplied with this product are protected by copyright.

All Customers outside the U.S. and Canada

For information about the length and terms of the warranty, refer to your package and/or to the warranty statement enclosed with this product, or contact your local Texas Instruments retailer/distributor.



Texas Instruments U.S.A.
7800 Banner Dr.
Dallas, Texas 75251

Texas Instruments Holland B.V.
Rutherfordweg 102
3542 CG Utrecht - The Netherlands



Printed By: