



TIMEX[®]

Model T131
**Nature Sounds
Alarm Clock**



For additional information, online
registration, and exclusive special
offers please visit our website:

www.sdirect.com

	CAUTION RISK OF ELECTRIC SHOCK DO NOT OPEN	
<p>CAUTION: TO REDUCE THE RISK OF ELECTRIC SHOCK, DO NOT REMOVE COVER OR BACK OF UNIT. NO USER-SERVICEABLE PARTS INSIDE. REFER SERVICING TO QUALIFIED SERVICE PERSONNEL.</p> <p>WARNING: TO REDUCE THE RISK OF FIRE OR ELECTRIC SHOCK, DO NOT EXPOSE THIS APPLIANCE TO RAIN OR MOISTURE.</p>		

	<p><i>The lightning flash with arrowhead in an equilateral triangle is intended to alert the user of the presence of uninsulated "dangerous voltage" within the product's enclosure that may be of sufficient magnitude to constitute a risk of electric shock.</i></p>
---	---

	<p><i>The exclamation point within an equilateral triangle is intended to alert the user of the presence of important operating and maintenance (servicing) instructions in the literature accompanying the appliance.</i></p>
---	--

The symbols above are located at the bottom of the cabinet.

<p>CAUTION: To prevent electric shock, do not use this polarized plug with an extension cord receptacle or other outlets unless the blades can be fully inserted to prevent blade exposure.</p> <p>ATTENTION: Pour prévenir les chocs électriques ne pas utiliser cette fiche polarisée avec un prolongateur. Une prise de courant, ou une autre sortie de courant sauf si les lames peuvent être insérées à fond sans en laisser aucune partie à découvert.</p>
--

This device complies with part 15 of the Federal Communications Commission Rules. Operation is subject to the condition that this device does not cause harmful interference.

A Consumer Guide to Product Safety

When used in the directed manner, this unit has been designed and manufactured to ensure your personal safety. However, improper use can result in potential electrical shock or fire hazards. Please read all safety and operating instructions carefully before installation and use, and keep these instructions handy for future reference. Take special note of all warnings listed in these instructions and on the unit.

1. **Water and Moisture** – The unit should not be used near water. For example: near a bathtub, washbowl, kitchen sink, laundry tub, swimming pool or in a wet basement.
2. **Ventilation** – The unit should be situated so that its location or position does not interfere with its proper ventilation. For example, it should not be situated on a bed, sofa, rug or similar surface that may block ventilation openings. Also, it should not be placed in a built-in installation, such as a bookcase or cabinet, that may impede the flow of air through the ventilation openings.
3. **Heat** – The unit should be situated away from heat sources such as radiators, heat registers, stoves or other appliances (including amplifiers) that produce heat.
4. **Power Sources** – The unit should be connected to a power supply only of the type described in the operating instructions or as marked on the appliance itself.
5. **Grounding or Polarization** – This product is equipped with a polarized alternating-current line plug (a plug having one blade wider than the other). As a safety feature this plug will fit into the power outlet only one way. If you are unable to fit the plug into the outlet, try reversing the plug. If the plug still fails to fit, contact your electrician to replace your obsolete outlet. Do not defeat the safety purpose of your polarized plug by forcing the plug into the outlet.
6. **Power-Cord Protection** – Power supply cords should be routed so that they are not likely to be walked on or pinched by items placed upon or against them. It is always best to have a clear area from where the cord exits the unit to where it is plugged into an AC outlet.
7. **Cleaning** – The unit should be cleaned only as recommended. See the Maintenance section of this manual for cleaning instructions.
8. **Objects and Liquid Entry** – Care should be taken so that objects do not fall and liquids are not spilled into any openings or vents located on the product.
9. **Attachments** – Do not use attachments not recommended by the product manufacturer.
10. **Lightning and Power Surge Protection** – Unplug the unit from the wall outlet during a lightning storm or when it is left unattended and unused for long periods of time. This will prevent damage to the product due to lightning and power-line surges.
11. **Overloading** – Do not overload wall outlets, extension cords, or integral convenience receptacles as this can result in fire or electric shock.
12. **Damage Requiring Service** – The unit should be serviced by qualified service personnel when:
 - A. the power supply cord or plug has been damaged.
 - B. objects have fallen into or liquid has been spilled into the enclosure.
 - C. the unit has been exposed to rain.
 - D. the unit has been dropped or the enclosure damaged.
 - E. the unit exhibits a marked change in performance or does not operate normally.
13. **Antenna** – Do not connect an external antenna to the unit.
14. **Periods of Nonuse** – If the unit is to be left unused for an extended period of time, such as a month or longer, the power cord should be unplugged from the unit to prevent damage or corrosion.
15. **Servicing** – The user should not attempt to service the unit beyond those methods described in the user's operating instructions. Service methods not covered in the operating instructions should be referred to qualified service personnel.

For questions or comments regarding this or other products, please call our toll-free number: 1-800-888-4491.

Installation and Maintenance

Maintenance and Setup

1. Place the clock on a level surface away from direct sunlight or sources of excessive heat.
2. Protect your furniture when placing the clock on natural wood or wood with a coated finish. A cloth or other protective material should be placed between the unit and the furniture.
3. Clean the casing with a soft cloth moistened only with mild soap and water. Stronger cleaning agents are not recommended, as they may damage the surface of the case.
4. If the clock is not to be used for a prolonged period, such as a month or longer, remove the batteries to prevent possible corrosion. Should the battery compartment become corroded or dirty, clean the compartment thoroughly and replace all the batteries.

Battery Backup Installation

It is recommended that a "9-Volt" battery be installed in order to activate the Battery Backup. In the event that the AC power cord is disconnected or a power failure or other interruption occurs, the Battery Backup will maintain clock and alarm settings for the life of the battery, ensuring that the alarm will sound when power is restored. During interruptions the settings will be saved and automatically restored when power is again active.

1. Gently turn the unit over and remove the battery compartment door.
2. Install a "9-Volt" battery (alkaline is recommended for longer life), matching the terminal ends with the same-sized connectors of the terminal harness.
3. Slide the compartment door back on, making sure the door locks into place, and gently turn the unit over.
4. The display's **Battery Low Indicator** will flash when no battery is installed, or when the battery is weak or installed incorrectly.

For the Best Battery Performance

- We recommend using alkaline batteries.
- Non-rechargeable batteries are not to be recharged.
- Remove rechargeable batteries (if removable) from the clock before charging.
- Rechargeable batteries are only to be recharged under adult supervision.
- Do not mix different types of batteries, including new and used batteries.
- Only use batteries of the same or equivalent type.
- Remove exhausted batteries from the clock.
- Do not short-circuit the supply terminals.

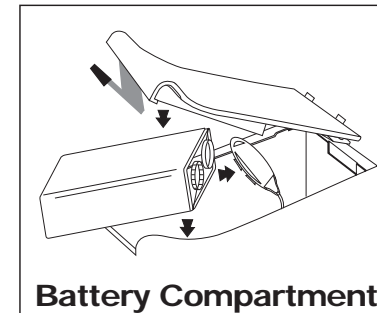

Controls and Indicators

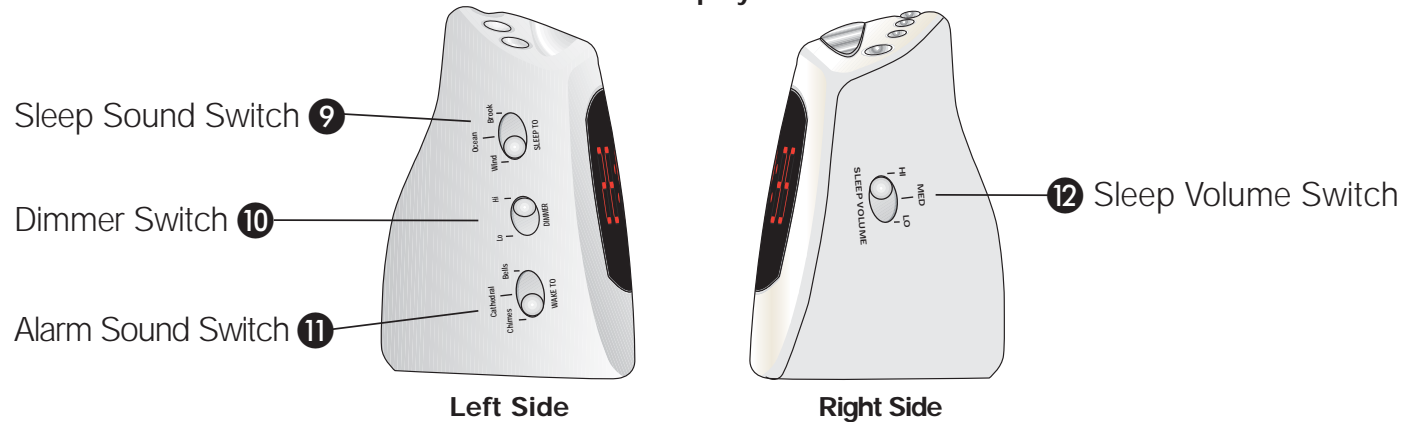
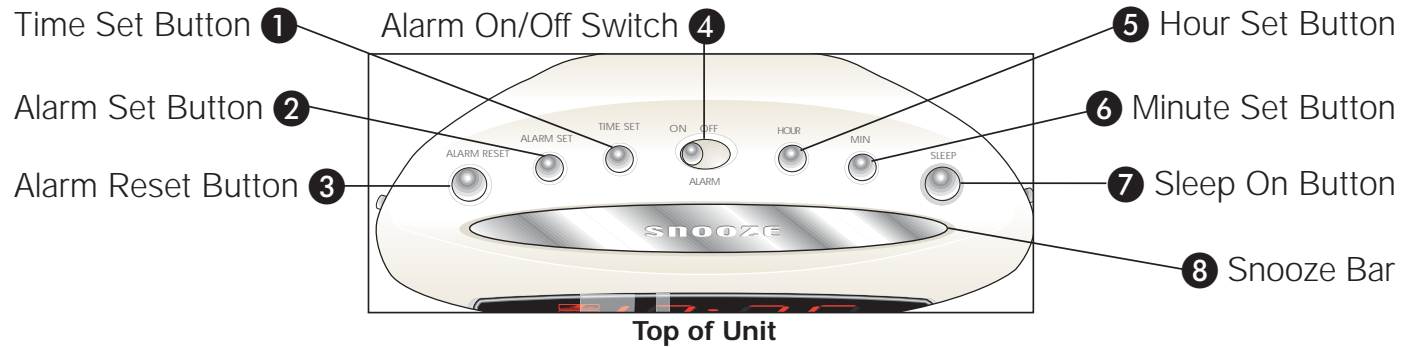

Setting the Clock

1. Press and hold the **① Time Set Button** while pressing the **⑤ Hour Set Button** and the **⑥ Minute Set Button**. Be sure to set the correct AM/PM time, shown by the display's **PM Indicator**.
2. After setting the time, release the **① Time Set Button**.

Operating the Alarm

Setting the Alarm

1. To set the wake time, press and hold the **② Alarm Set Button** while pressing the **⑤ Hour Set Button** and the **⑥ Minute Set Button**. Be sure to set the correct AM/PM wake time, shown by the display's **PM Indicator**. Release the **② Alarm Set Button**.
2. To select the wake sound, slide the **⑪ Alarm Sound Switch** to "Bells," "Cathedral," or "Chimes."
3. To activate the alarm, slide the **④ Alarm On/Off Switch** to the "On" position. The **Alarm Indicator** on the display will light.

Turning off the Alarm

1. When the alarm sounds, press the **③ Alarm Reset Button** to turn the alarm off and reset it for the same time on the following day. To turn the alarm off completely, slide the **④ Alarm On/Off Switch** to the "Off" position, so that the **Alarm Indicator** no longer appears on the display.
2. To activate the snooze feature, press the **⑧ Snooze Bar**. The alarm will shut off for nine minutes before sounding again. This can be repeated several times during the one-hour snooze cycle.
3. If it is not turned off, the alarm will sound for an hour before stopping. As long as the **Alarm Indicator** appears on the display, the alarm will sound at the set time.

NOTE: The bell alarms are "Gentle Wake" alarms, meaning that the volume will rise as time passes.

Sleeping to Nature Sounds Using the Timer

1. Press and hold the **7 Sleep On Button** to turn on the sleep sound and activate the timer.
2. While holding the **7 Sleep On Button**, the sleep timer will count down from 59 minutes. Release the button when the display shows the desired amount of sleep time.
3. To select a nature sleep sound, slide the **9 Sleep Sound Switch** to "Brook," "Ocean," or "Wind."
4. Select the volume by sliding the **12 Sleep Volume Switch** to "Hi," "Med," or "Lo."
5. The sound will play for the set amount of time before shutting off. To shut off the sound before the sleep time has elapsed, press the **8 Snooze Bar**.

Adjusting the Display Backlight

- This alarm clock features an adjustable display brightness, with dim and bright settings. To select a setting, slide the **10 Dimmer Switch** to the "Hi" or "Lo" position.

Limited 90-Day Warranty Information

Timex Audio Products, a division of SDI Technologies Inc. (hereafter referred to as SDI Technologies), warrants this product to be free from defects in workmanship and materials, under normal use and conditions, for a period of 90 days from the date of original purchase.

Should this product fail to function in a satisfactory manner, it is best to first return it to the store where it was originally purchased. Should this fail to resolve the matter and service still be required by reason of any defect or malfunction during the warranty period, SDI Technologies will repair or, at its discretion, replace this product without charge (except for a \$5.00 charge for handling, packing, return UPS/postage, and insurance). This decision is subject to verification of the defect or malfunction upon delivery of this product to the Factory Service Center listed below. The product must include proof of purchase, including date of purchase. The fee for service after the warranty period or without proof of purchase is \$10.00.

Before returning this product for service, please first replace the batteries (if applicable) with fresh ones, as exhausted or defective batteries are the most common cause of problems encountered.

If service is still required:

1. Remove the batteries (if applicable) and pack the unit in a well padded, heavy corrugated box.
2. Enclose a photocopy of your sales receipt, credit card statement, or other proof of the date of purchase, if within the warranty period.
3. Enclose a check or money order payable to the order of SDI Technologies, for the sum of \$5.00 (\$10.00 after warranty period).
4. Send the unit prepaid and insured, to the Factory Service Center listed below.

Consumer Repair Department
SDI Technologies Inc.
Timex Audio Products Division
1401 Pullman Drive, Suite A
El Paso, TX 79936-7726

NOTE: This warranty is valid only if the product is used for the purpose for which it was designed. It does not cover (i) products which have been damaged by negligence, misuse or accident, or which have been modified or repaired by unauthorized persons; (ii) cracked or broken cabinets, or units damaged by excessive heat; (iii) damage to CD's or tape cassettes (if applicable); (iv) the cost of shipping this product to the Factory Service Center and its return to the owner.

This warranty is valid only in the United States of America and does not extend to owners of the product subsequent to the original purchaser. Any applicable implied warranties are also limited to 90 days, and SDI Technologies will not be liable for consequential damages. (Some states do not allow limitations on implied warranties or exclusion of consequential damages, so these restrictions may not apply to you.) This warranty gives you specific legal rights, and you may also have other rights which vary from state to state.

For questions or comments regarding this or other products, please call our toll-free number 1-800-888-4491.

TIMEX is a registered trademark of Timex Corporation in the U.S. and other countries.