

# Toaster Oven Broiler

USE AND CARE GUIDE  
MODEL TOV400



# IMPORTANT SAFEGUARDS

When using electrical appliances, basic safety precautions should always be followed including the following:

- ◆ Read all instructions.
- ◆ Do not touch hot surfaces. Use handles or knobs.
- ◆ To protect against electrical shock do not immerse cord, plugs, or appliance in water or other liquid.
- ◆ Close supervision is necessary when any appliance is used by or near children.
- ◆ Unplug from outlet when not in use and before cleaning. Allow to cool before putting on or taking off parts.
- ◆ Do not operate any appliance with a damaged cord or plug or after the appliance malfunctions or has been damaged in any manner. Contact Consumer Service for examination, repair or adjustment.
- ◆ The use of accessory attachments not recommended by the appliance manufacturer may cause injuries.
- ◆ Do not use outdoors.
- ◆ Do not let cord hang over edge of table or counter, or touch hot surfaces.
- ◆ Do not place on or near a hot gas or electric burner, or in a heated oven.
- ◆ Extreme caution must be used when moving an appliance containing hot oil or other hot liquids.
- ◆ To disconnect, turn the Timer and Temperature Controls to "OFF", then remove plug from wall outlet.
- ◆ Do not use appliance for other than intended use.
- ◆ Oversize foods or metal utensils must not be inserted in a toaster-oven as they may create a fire or risk of electric shock.
- ◆ A fire may occur if the toaster-oven is covered or touching flammable material, including curtains, draperies, walls, and the like, when in operation. Do not store any item on top of the appliance when in operation.
- ◆ Do not clean with metal scouring pads. Pieces can break off the pad and touch electrical parts involving a risk of electric shock.



- ◆ Extreme caution should be exercised when using containers constructed of other than metal or glass.
- ◆ Do not store any materials, other than manufacturers recommended accessories, in this oven when not in use.
- ◆ Do not place any of the following materials in the oven: paper, cardboard, plastic, and the like.
- ◆ Do not cover crumb tray or any part of the oven with metal foil. This will cause overheating of the oven.
- ◆ Use extreme caution when removing tray or disposing of hot grease.
- ◆ To turn oven off during use, turn the Timer Control to “OFF”.

## SAVE THESE INSTRUCTIONS

### For Household Use Only

## ADDITIONAL IMPORTANT SAFEGUARDS

**CAUTION HOT SURFACES:** This appliance generates heat and escaping steam during use. Proper precautions must be taken to prevent the risk of burns, fires, or other injury to persons or damage to property.

- ◆ A person who has not read and understood all operating and safety instructions is not qualified to operate this appliance. All users of this appliance must read and understand this Use and Care Guide before operating or cleaning this appliance.
- ◆ If this appliance falls or accidentally becomes immersed in water, unplug it from the wall outlet immediately. **Do not reach into the water!**
- ◆ When using this appliance, provide adequate air space above and on all sides for air circulation. Do not operate this appliance while it is touching or near curtains, wall coverings, clothing, dishtowels or other flammable materials.
- ◆ To reduce the risk of fire, do not leave this appliance unattended during use.
- ◆ If this appliance begins to malfunction during use, immediately unplug the cord. Do not use or attempt to repair a malfunctioning appliance!
- ◆ The cord to this appliance should only be plugged into a 120V AC electrical wall outlet.
- ◆ Do not use this appliance in an unstable position.

# Polarized Plug

This appliance has a polarized plug (one blade is wider than the other). To reduce the risk of electric shock, this plug is intended to fit into a polarized outlet only one way. If the plug does not fit fully in the outlet, reverse the plug. If it still does not fit, contact a qualified electrician. Do not attempt to modify the plug in any way.

# Short Cord Instructions

A short power-supply cord is provided to reduce the risk resulting from becoming entangled in or tripping over a longer cord.

Do not use an extension cord with this product.

# Electric Power

If the electrical circuit is overloaded with other appliances, your appliance may not operate properly. It should be operated on a separate electrical circuit from other appliances.

# Plasticizer Warning

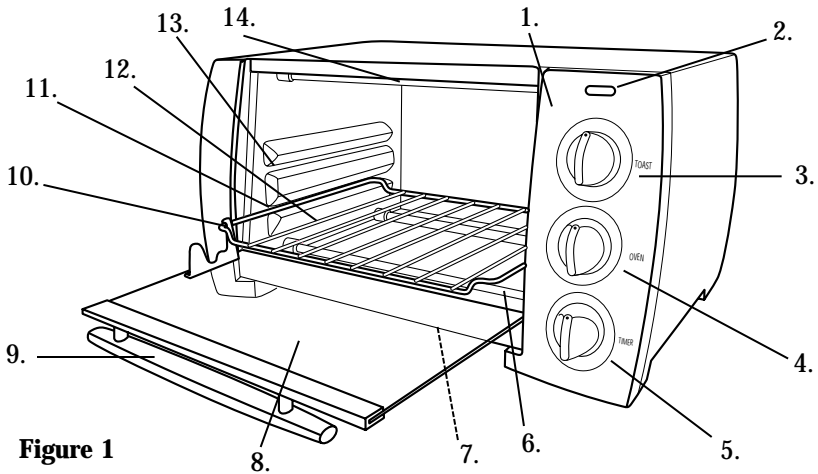
**CAUTION:** To prevent Plasticizers from migrating from the finish of the countertop or tabletop or other furniture, place NON-PLASTIC coasters or placemats between the appliance and the finish of the countertop or tabletop.

**Failure to do so may cause the finish to darken, permanent blemishes may occur or stains can appear.**



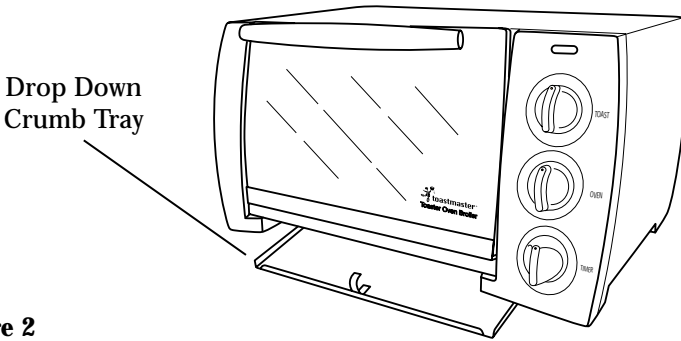
# Getting to Know Your **Toastmaster** Toaster Oven-Broiler

Your product may vary slightly from illustration.

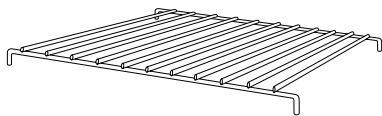


**Figure 1**

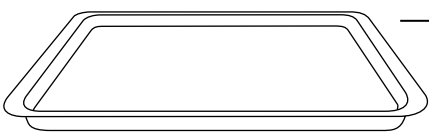
- |  |                             |
|--|-----------------------------|
| 1. Control Panel   | 7. Drop Down Crumb Tray     |
| 2. Power Light   | 8. Glass Door               |
| 3. Function Control  | 9. Handle                   |
| 4. Temperature Control   | 10. Wire Rack Door Guide    |
| 5. Timer Control<br>(with 30 minutes Timer<br>and "Stay On" feature) | 11. Shelf Positions 3 and 4 |
| 6. Lower Heating Elements  | 12. Wire Rack (P/N 21957)   |
|  | 13. Shelf Positions 1 and 2 |
|  | 14. Upper Heating Elements  |



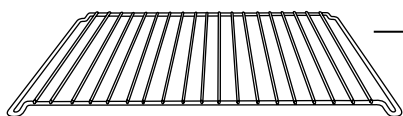
**Figure 2**



Broil Insert  
(P/N 21864TM)

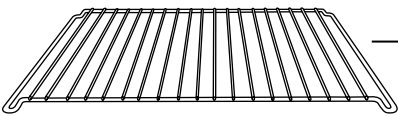


Bake/Broil Pan  
(P/N 21869)

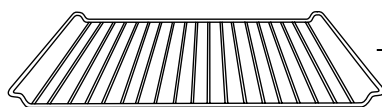


Wire Rack  
(P/N 21957)

**Figure 3**

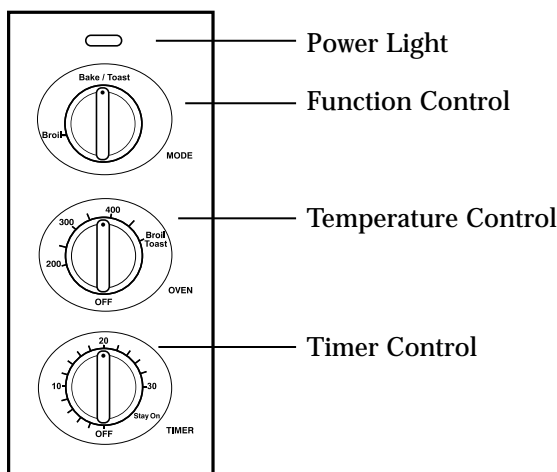


Shelf Positions  
1 and 3



Shelf Positions  
2 and 4

**Figure 4**



**Figure 5**

## Operating Instructions

### BEFORE FIRST USE

1. Carefully unpack your Toaster Oven-Broiler and remove all packaging materials.
2. Place your Toaster Oven-Broiler on a level surface such as a countertop or table. Be sure the sides, back, and top of the Toaster Oven-Broiler are at least four inches away from any walls, cabinets, or objects on the counter or table.
3. Remove all stickers from the Toaster Oven-Broiler except the rating label located on the back.
4. Remove Bake/Broil Pan, Broil Insert and Wire Rack and wash in warm, soapy water. Rinse and dry thoroughly before placing in the Toaster Oven-Broiler.
5. Remove any dust that may have accumulated during packaging, simply wipe the Toaster Oven-Broiler exterior with a clean, damp cloth.
6. To engage the Wire Rack into the Door Guides, slide the Wire Rack into Shelf Position 3 or 4. When you close the Glass Door, the Door Guide will guide the Wire Rack into the oven. When the Glass Door is opened, the Door will pull the Wire Rack partially out of the oven.  
 Note: The Door Guides only pull the Wire Rack out in Shelf Positions 3 and 4.

# Operating Instructions (Cont.)

## BEFORE FIRST USE

7. Do not use abrasive cleansers.
8. Do not put the Toaster Oven-Broiler, cord or plug in water.
9. When you are ready to use the Toaster Oven-Broiler, plug the cord into a 120V AC outlet.
10. To eliminate any protective substance or oil that may have been used for packing and shipping, turn the Function Control to Bake/Toast, turn the Temperature Control to 450° and set the Timer Control for 15 minutes. A small amount of smoke and odor may be detected. This is normal.
11. To avoid scratching, marring, or discoloration, do not store anything on top of the Toaster Oven-Broiler during operation.

**CAUTION: Appliance surfaces are hot during and after use.**

**CAUTION: Always wear protective, insulated oven mitts on hands when touching hot Toaster Oven-Broiler or hot dishes and food or when inserting or removing Wire Racks, baking dish and food.**

## Cooking Containers

- ◆ The Bake/Broil Pan included with the Toaster Oven-Broiler is suitable for items such as cookies, rolls, biscuits, nachos and pork chops.
- ◆ A variety of standard baking dishes, such as an 9" round or square cake pan, a 6-cup muffin pan, and 1 & 2 quart round, square, or rectangular casserole dish may be used for other foods.
- ◆ Choose bakeware made of metal, or glass/ceramic without lids.
- ◆ Dark or dull pans absorb heat faster; foods will bake more rapidly and crust will brown more easily than in shiny bake pans.
- ◆ Check package directions and/or with the ovenware manufacturer to determine if the container is suitable for use in a Toaster Oven-Broiler.
- ◆ Do not use oven roasting bags in this Toaster Oven-Broiler, as they may come in contact with the Heating Elements.

**CAUTION: Allow at least 1" air space between the top of the container and the Upper Heating Elements. Never use glass lids on glass or metal bakeware. If a lid is necessary, cover tightly with heavy-duty aluminum foil.**





# Instructions For Toast

1. Plug into 120V AC 60 Hz outlet. Close the Glass Door.
2. Make sure the Crumb Tray is firmly in place in the bottom of the Toaster Oven-Broiler.
3. Open the Glass Door and place the Wire Rack in Shelf Position # 2. Center bread on the Wire Rack. Close the Glass Door.
4. Set the Function Control to Bake/Toast.
5. Turn the Temperature Control to Broil/Toast.
6. Turn the Timer Control to the desired toast color. Watch bread carefully until the desired toast color is reached. The Power Light will come on.
7. To set the Timer Control for less than 10 minutes, turn to 10 and then turn back to the appropriate amount of time.

CAUTION: As soon as the Timer Control is engaged, the Toaster Oven-Broiler will turn ON. Both the top and the bottom sets of Heating Elements will remain ON for the entire cooking time.

CAUTION: As soon as the Timer Control is engaged both sets of Heating Elements will become hot immediately. Use care not to place anything on top of the Toaster Oven-Broiler. Do not touch the Toaster Oven-Broiler or any part of the Toaster Oven-Broiler without wearing oven mitts.

8. The Toaster Oven-Broiler will shut off automatically when the Toast cycle is complete. If toasting is completed before the Timer Control shuts the Toaster Oven-Broiler OFF, you may shut the Toaster Oven-Broiler OFF manually by turning the Timer Control to the OFF position. The Power Light will go off.
9. When the Toast time is complete, a signal will sound, and the Timer Control will finish in the OFF position. The Power Light will go off. NOTE: Watch toast until desired color is achieved.
10. Open the Glass Door. Wear protective oven mitts to remove toast from Toaster Oven-Broiler. Be careful when removing toast from the back of the Wire Rack. The inside of the Toaster Oven-Broiler is very hot. Close Glass Door.
11. Unplug unit and allow to cool before cleaning.

**DO NOT LEAVE TOASTER OVEN-BROILER UNATTENDED DURING TOASTING.**

**ADDITIONAL TOAST CYCLES REQUIRE LESS TIME SINCE THE OVEN CAVITY IS ALREADY WARM.**

See User Maintenance Instructions. Unplug when not in use.

# Hints For Toast

- ◆ Remove all protective wrappings from food before placing in Toaster Oven-Broiler. Follow toaster food directions.
- ◆ Frozen, thick and heavy bread may require a longer time setting (e.g. bagels and English muffins).  
NOTE: Use extra caution when using this Toaster Oven-Broiler for toasting pastry items with runny-type frosting or fillings.
- ◆ When toasting more than one slice of bread, use slices of similar size, thickness and freshness.
- ◆ One slice of bread requires a lighter setting than several slices of bread.
- ◆ Stale bread, thin bread or sweet bread products, such as tea cakes and fruit loaf, brown much more quickly than ordinary bread, so they should be toasted for less time.
- ◆ Different breads require different toasting times. Turn Timer Control to the OFF position and open the Glass Door to check toast color. Close Glass Door and reset Timer Control if more toasting time is needed.
- ◆ For best results, clean Crumb Tray frequently.

# Instructions For Baking

1. Plug into 120V AC 60 Hz outlet. Close the Glass Door.
2. Make sure the Crumb Tray is firmly in place in the bottom of the Toaster Oven-Broiler.
3. Turn the Function Control to Bake.
4. Set the Temperature Control to the desired temperature.
5. Preheat the Toaster Oven-Broiler for 10 minutes for baking. The Power Light will come on. After 10 minutes, a signal will sound and the Toaster Oven-Broiler will automatically shut OFF. The Power Light will go off.
6. Remove all protective wrappings from food before placing in Toaster Oven-Broiler.
7. Open the Glass Door. Place the Wire Rack in Shelf Position #2, #3, or #4 depending on the height of the pan and food or recipe directions. Use the Baking/Broil Pan or an appropriate baking container for the food, and place it on the Wire Rack. If you would like your food browned top and bottom, place food directly on Wire Rack and close Glass Door. Bake according to package or recipe time.
8. Turn the Timer Control to the desired time or to the Stay On position. The Power Light will come on.



# Instructions For Baking (Cont.)

9. To set the Timer Control for less than 10 minutes, turn to 10 and then turn back to the appropriate amount of time.  
CAUTION: As soon as the Timer Control is engaged, the Toaster Oven-Broiler will turn ON. Both the top and the bottom sets of Heating Elements will come ON and then cycle off and on during cooking time to maintain proper temperature.  
CAUTION: As soon as the Timer Control is engaged both sets of Heating Elements will become hot immediately. Use care not to place anything on top of the Toaster Oven-Broiler. Do not touch the Toaster Oven-Broiler or any part of the Toaster Oven-Broiler without wearing oven mitts.
10. If the Timer Control has been set, the Toaster Oven-Broiler will shut off automatically when Bake is complete. If cooking is completed before the Timer Control shuts the Toaster Oven-Broiler OFF, you may shut the Toaster Oven-Broiler OFF manually by turning the Timer Control to the OFF position. If the Stay On position has been selected, the Toaster Oven-Broiler must be shut off manually by turning the Timer Control to the OFF position. The Power Light will go off.
11. When the Bake time is complete, a signal will sound, and the Timer Control will finish in the OFF position. The Power Light will go off.
12. Open the Glass Door. Wear protective oven mitts to remove food from Toaster Oven-Broiler. The inside of the Toaster Oven is very hot. Close the Glass Door.
13. Unplug the unit and allow to cool completely before cleaning.  
NOTE: Do not use glass covers on baking pans. If using a glass or glass-ceramic baking container, make sure it is at least 1 1/2 inches away from the Top Heating Element.

**DO NOT LEAVE TOASTER OVEN-BROILER UNATTENDED DURING BAKING.**

See User Maintenance Instructions. Unplug when not is use.

# Hints For Bake

- ◆ Heavy-duty aluminum foil may be used to cover top of baking container to reduce over browning. Tuck ends of foil closely against edge of pan.
- ◆ Place food toward the back of the Toaster Oven-Broiler for better browning.
- ◆ Food may cook faster than recipe or package time. Check for doneness prior to end of cook time.
- ◆ Rotate and turn food over for more even browning halfway through the cooking process.
- ◆ To prevent heat loss, avoid opening the Glass Door excessively.
- ◆ For best results, foods that contain a leavening agent should be baked on the lowest Shelf Position of the Toaster Oven-Broiler.

# Instructions For Broiling

Only the Top Heating Elements will heat when this Toaster Oven-Broiler function is used.

1. Plug into 120 V 60 Hz outlet. Close the Glass Door.
2. Make sure the Crumb Tray is firmly in place in the bottom of the Toaster Oven-Broiler.
3. Place food on the Broil Insert in the Bake/Broil Pan.
4. Open the Glass Door. Place the Wire Rack in Shelf Position #2 or #3, leaving approximately 2 to 3 inches between the food and the Upper Heating Elements.
5. Brush food with sauces or oil as desired. Place the Bake/Broil Pan with the Broil Insert and food into the Toaster Oven Broiler and close the Glass Door. The Bake/Broil Pan will catch any juices during broiling.
6. Turn the Function Control to Broil.
7. Set the Temperature Control to Broil/Toast.
8. Turn the Timer Control to the desired time. The Power Light will come on.
9. To set the Timer Control for less than 10 minutes, turn to 10 and then turn back to the appropriate amount of time.



## Instructions For Broiling (Cont.)

**CAUTION:** As soon as the Timer Control is engaged, the Toaster Oven-Broiler will turn ON. Only the top Heating Elements will remain ON for the entire cooking time.

**CAUTION:** As soon as the Timer Control is engaged the Heating Elements will become hot immediately. Use care not to place anything on top of the Toaster Oven-Broiler. Do not touch the Toaster Oven-Broiler or any part of the Toaster Oven-Broiler without wearing oven mitts.

10. Broil according to package or recipe time. When broiling food that needs to be cooked on both sides, set the Timer Control for the time necessary for one side.
11. The Toaster Oven-Broiler will shut off automatically when the broiling is complete. If broiling is completed before the Timer Control shuts the Toaster Oven-Broiler OFF, you may shut the Toaster Oven-Broiler OFF manually by turning the Timer Control to the OFF position. The Power Light will go off.
12. When the Broiling time is complete, a signal will sound, and the Timer Control will finish in the OFF position. The Power Light will go off.
13. Open the Glass Door. Wear protective oven mitts to carefully pull the Wire Rack and Bake/Broil Pan about halfway out of the Toaster Oven-Broiler. Turn the food, slide the Wire Rack and Bake/Broil Pan with Broil Insert into the Toaster Oven-Broiler and close the Toaster Oven-Broiler Glass Door. Turn the Timer Control to the desired time.
14. When the Broiling time is complete, a signal will sound, and the Timer Control will finish in the OFF position. The Power Light will go off.
15. Open the Glass Door. Wear protective oven mitts to remove food from Toaster Oven-Broiler. Be careful when removing food. The inside of the Toaster Oven-Broiler is very hot. Close the Glass Door.
16. Unplug unit and allow to cool completely before cleaning.

**DO NOT LEAVE TOASTER OVEN-BROILER UNATTENDED DURING BROILING.**

See User Maintenance Instructions. Unplug when not in use.

# Instructions For Top Browning

To Top Brown foods, follow the Toast instructions but place the food on the Bake/Broil Pan on the Wire Rack.

## Hints For Top Browning

- ◆ Watch food to avoid over-browning.
- ◆ Top Brown may be used to top brown bagels (cut side up), English muffins or melt cheese on sandwiches or casseroles.

**DO NOT LEAVE TOASTER OVEN-BROILER UNATTENDED DURING TOP BROWNING.**

See User Maintenance Instructions. Unplug when not in use.

## Instructions For Keep Warm

1. Plug into 120V 60 Hz outlet. Close the Glass Door.
2. Make sure the Crumb Tray is firmly in place in the bottom of the Toaster Oven-Broiler.
3. Open the Glass Door. Place Wire Rack in Shelf Position # 3 or 4 of Toaster Oven Broiler. Center a baking container or food on the Wire Rack or use Bake/Broil Pan and close the Glass Door.
4. Turn the Function Control to Bake/Toast.
5. Set the Temperature Control to 200°F.
6. Turn the Timer to the desired time or to the Stay On position. The Power Light will come on.
7. To set the Timer Control for less than 10 minutes, turn to 10 and then turn back to the appropriate amount of time.

**CAUTION:** As soon as the Timer Control is engaged, the Toaster Oven-Broiler will turn ON. Both the top and the bottom sets of Heating Elements will come ON and then cycle off and on during cooking time to maintain proper temperature.

**CAUTION:** As soon as the Timer Control is engaged both Heating Elements will become hot immediately. Use care not to place anything on top of the Toaster Oven-Broiler.

Do not touch the Toaster Oven-Broiler or any part of the Toaster Oven-Broiler without wearing oven mitts.



## Instructions For Keep Warm (Cont.)

8. If the Timer Control has been set, the Toaster Oven-Broiler will shut off automatically when Keep Warm is complete. If Keep Warm is completed before the Timer Control shuts the Toaster Oven-Broiler OFF, you may shut the Toaster Oven-Broiler OFF manually by turning the Timer Control to the OFF position. If the Stay On position has been selected, the Toaster Oven-Broiler must be shut off manually by turning the Timer Control to the OFF position. The Power Light will go off.
9. When the Keep Warm time is complete, a signal will sound, and the Timer Control will finish in the OFF position. The Power Light will go off.
10. Open the Glass Door. Wear protective oven mitts to remove food from Toaster Oven-Broiler. Be careful when removing food. The inside of the Toaster Oven-Broiler is very hot. Close the Glass Door.
11. Unplug unit and allow to cool completely before cleaning.

**DO NOT LEAVE TOASTER OVEN-BROILER UNATTENDED DURING KEEP WARM.**

See User Maintenance Instructions. Unplug when not in use.

## Hints For Keep Warm

- ◆ Use for short periods of time after food is cooked.

## Instructions For Defrost

1. Plug into 120 V 60 Hz outlet. Close the Glass Door.
2. Make sure the Crumb Tray is firmly in place in the bottom of the Toaster Oven-Broiler.
3. Open the Glass Door. Place Wire Rack in Shelf Position # 3 or # 4 of Toaster Oven-Broiler.
4. Center a baking container or food on Wire Rack or use Bake/Broil Pan and close the Glass Door.
5. Turn the Function Control to Bake/Toast.
6. Set the Temperature Control to 200°F.
7. Turn the Timer to the desired time or to the Stay On position. The Power Light will come on.

## Instructions For Defrost (Cont.)

8. To set the Timer Control for less than 10 minutes, turn to 10 and then turn back to the appropriate amount of time.

CAUTION: As soon as the Timer Control is engaged, the Toaster Oven-Broiler will turn ON. Both the top and the bottom sets of Heating Elements will come ON and then cycle off and on during cooking time to maintain proper temperature.

CAUTION: As soon as the Timer Control is engaged both Heating Elements will become hot immediately. Use care not to place anything on top of the Toaster Oven-Broiler.

Do not touch the Toaster Oven-Broiler or any part of the Toaster Oven-Broiler without wearing oven mitts.

9. If the Timer Control has been set, the Toaster Oven-Broiler will shut off automatically when Defrost is complete. If Defrost is completed before the Timer Control shuts the Toaster Oven Broiler OFF, you may shut the Toaster Oven Broiler OFF manually by turning the Timer Control to the OFF position. If the Stay On position has been selected, the Toaster Oven-Broiler must be shut off manually by turning the Timer Control to the OFF position. The Power Light will go off.
10. When the Defrost time is completed, a signal will sound, and the Timer Control will finish in the OFF position. The Power Light will go off.
11. Open the Glass Door. Wear protective oven mitts to remove food from Toaster Oven-Broiler. Be careful when removing food. The inside of the Toaster Oven-Broiler is very hot. Close the Glass Door.
12. Unplug unit and allow to cool completely before cleaning.

**DO NOT LEAVE TOASTER OVEN-BROILER UNATTENDED DURING DEFROST.**

See User Maintenance Instructions. Unplug when not in use.

## Hints For Defrost

- ◆ Do not use this method for meat, poultry or fish.
- ◆ Do not cover food.
- ◆ Brush frozen dough with vegetable oil to prevent drying out and remove to preheat Toaster Oven-Broiler before baking.





# Special Features

## TIMER CONTROL WITH STAY ON

The Timer Control Dial also acts as the Toaster Oven-Broiler's ON/OFF switch. Turn the Timer Control clockwise to select the appropriate cooking time or to the "Stay On" position. If cooking less than 10 minutes, turn the Timer Control to 10 minutes and then turn back to desired cooking time.

When the cooking cycle is completed, a signal will sound and the unit will turn OFF automatically. If you wish to turn the Toaster Oven-Broiler OFF at any time, manually turn the Timer Control to the OFF position. Unplug Toaster Oven-Broiler when not in use.

## REMOVABLE WIRE RACK

The Wire Rack must be used for all cooking and toasting functions. The Rack is removable for easy cleaning and must be properly re-inserted before use.

## DROP-DOWN CRUMB TRAY

The Crumb Tray may be dropped down for easy cleaning.

## POWER LIGHT

When you turn the Timer Control to the desired time, the Power Light will be on.

The unit will shut OFF automatically when using the Timer Function. When the cooking cycle is complete the Power Light will go off.

## BAKE/BROIL PAN, BROIL INSERT

For best results use Bake/Broil Pan to Bake, Broil, Defrost, Top Brown, Keep Warm and to minimize clean-up due to spills. When broiling, both the Bake Pan and the Broil Insert must be used.

# User Maintenance Instructions

This appliance requires little maintenance. It contains no user serviceable parts. Do not try to repair it yourself. Contact a qualified appliance repair technician if the product requires servicing.

# General Care and Cleaning

1. Make sure the Function and Timer Controls are in the OFF position and unplug the Toaster Oven-Broiler before cleaning.
2. Allow Toaster Oven-Broiler and accessories to cool completely before cleaning.
3. Clean the outside of the Toaster Oven-Broiler with a damp cloth and dry thoroughly. A non-abrasive liquid cleaner may be used for stubborn stains. Rinse and dry thoroughly. Do not use metal scouring pads or abrasive cleaners that will scratch the surface.
4. Clean the Glass Door with a cloth or sponge dampened with warm, sudsy water. Dry thoroughly.
5. Remove Bake/Broil Pan, Broil Insert and Wire Rack. Wash in soapy water and dry thoroughly.
6. Tilt oven back and press tab located on the bottom of the oven. While continuing to hold the tab, slide tray down and pull tray towards you. Wipe with a damp cloth to remove crumbs and spills. Always dry the Crumb Tray thoroughly before closing.
7. DO NOT use abrasive cleaners or metal scouring pads to clean Bake/Broil Pan, Broil Insert or Wire Rack. For stubborn stains, clean with a nylon or polyester mesh pad and a mild, non-abrasive cleaner. Rinse and dry thoroughly.

**CAUTION: DO NOT use spray-on or other oven cleaners. Using these types of cleaners may cause electrical damage.**

## Interior Cleaning

1. Always unplug unit and allow to cool completely before cleaning or moving.
2. Remove Bake/Broil Pan, Broil Insert and Wire Rack.
3. Clean the non-stick interior with a mild or non-abrasive cleaner and plastic scouring pad after each use to avoid build-up. Do not rub too hard as surface can be scratched.
4. To remove baked on food, pour a small amount of cooking oil onto the food and allow to stand for 5 to 10 minutes. Remove the softened food with a soft cloth. Do not use steel wool, scouring pads or abrasive cleaners.
5. Rinse and dry thoroughly before closing the Glass Door.



# Exterior Cleaning

Wipe surfaces with a clean, damp cloth. Do not use abrasive cleaners, as they may scratch the surface.

# To Store

Unplug unit, allow to cool, and clean before storing. Store in its box in a clean, dry place. Never store it while it is hot or still plugged in. Never wrap cord tightly around the appliance. Do not put any stress on the cord where it enters the unit, as it could cause the cord to fray and break.

## LIMITED ONE YEAR WARRANTY

**Warranty:** This Toastmaster® product is warranted to be free from defects in materials or workmanship for a period of (1) year from the original purchase date. This product warranty covers only the original consumer purchaser of the product.

**Warranty Coverage:** This warranty is void if the product has been damaged by accident in shipment, unreasonable use, misuse, neglect, improper service, commercial use, repairs by unauthorized personnel, normal wear and tear, improper assembly, installation or maintenance abuse or other causes not arising out of defects in materials or workmanship. This warranty is effective only if the product is purchased and operated in the USA, and does not extend to any units which have been used in violation of written instructions furnished with the product or to units which have been altered or modified or to damage to products or parts thereof which have had the serial number removed, altered, defaced or rendered illegible.

**Implied Warranties:** ANY IMPLIED WARRANTIES WHICH THE PURCHASER MAY HAVE ARE LIMITED IN DURATION TO ONE (1) YEAR FROM THE DATE OF PURCHASE. Some states do not allow limitations on how long an implied warranty lasts, so the above limitation may not apply to you.

**Warranty Performance:** During the above one-year warranty period, a product with a defect will be either repaired or replaced with a reconditioned comparable model (at our option) when the product is returned to the Repair Center, or the purchase price refunded. The repaired or replacement product will be in warranty for the balance of the one-year warranty period and an additional one-month period. No charge will be made for such repair or replacement.

**Service and Repair:** Should the appliance malfunction, you should first call toll-free 1 (800) 947-3744 between the hours of 9:00 am and 5:00 pm Central Standard Time and ask for CONSUMER SERVICE stating that you are a consumer with a problem. Please refer to model number TOV400 when you call.

**In-Warranty Service (USA):** For an appliance covered under the warranty period, no charge is made for service or postage. Call for return authorization (1 800 947-3744).

**Out-of Warranty Service:** A flat rate charge by model is made for out-of-warranty service. Include \$ 10.00 (U.S.) for return shipping and handling. We will notify you by mail of the amount of the charge for service and require you to pay in advance for the repair or replacement.

**For Products Purchased in the USA, but Used in Canada:** You may return the product insured, packaged with sufficient protection, and postage and insurance prepaid to the USA address listed below. Please note that all customs duty / brokerage fees, if any, must be paid by you and we will require you to pay the cost of customs duty / brokerage fees to us in advance of our performing any service.

**Risk During Shipment:** We cannot assume responsibility for loss or damage during incoming shipment. For your protection, carefully package the product for shipment and insure it with the carrier. Be sure to enclose the following items with your appliance: any accessories related to your problem, your full return address and daytime phone number, a note describing the problem you experienced, a copy of your sales receipt or other proof of purchase to determine warranty status. C.O.D. shipments cannot be accepted.

**To return the appliance, ship to:**

Attn: Repair Center  
Toastmaster Inc.  
708 South Missouri Street  
Macon, MO 63552  
Email: [consumer\\_relations@toastmaster.com](mailto:consumer_relations@toastmaster.com)  
[www.toastmaster.com](http://www.toastmaster.com)

**To contact us, please write to or call:**

Toastmaster Inc.  
P.O. Box 6916  
Columbia, MO 65205-6916  
1 (800) 947-3744

**Limitation of Remedies:** No representative or person is authorized to assume for us any other liability in connection with the sale of our products. There shall be no claims for defects or failure of performance or product failure under any theory of tort, contract or commercial law including, but not limited to negligence, gross negligence, strict liability, breach of warranty and breach of contract. Repair, replacement or refund shall be the sole remedy of the purchaser under this warranty, and in no event shall we be liable for any incidental or consequential damages, losses or expenses. Some states do not allow the exclusion or limitation of incidental or consequential damages, so the above limitation or exclusion may not apply to you.

**Legal Rights:** This warranty gives you specific legal rights, and you may also have other rights which vary from state to state.



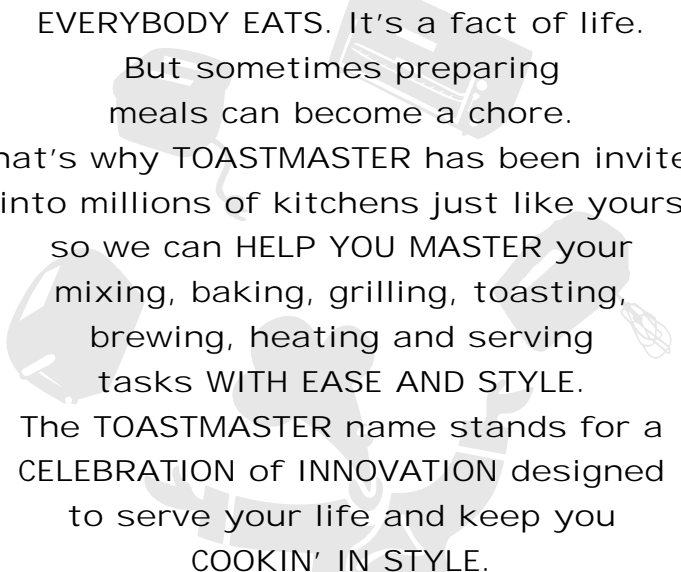
## Keep Dated Sales Receipt for Warranty Service.

Keep this booklet. Record the following for reference:

Date purchased \_\_\_\_\_

Model number \_\_\_\_\_

Date code (stamped on bottom) \_\_\_\_\_



EVERYBODY EATS. It's a fact of life.  
But sometimes preparing meals can become a chore.  
That's why TOASTMASTER has been invited into millions of kitchens just like yours so we can HELP YOU MASTER your mixing, baking, grilling, toasting, brewing, heating and serving tasks WITH EASE AND STYLE.  
The TOASTMASTER name stands for a CELEBRATION of INNOVATION designed to serve your life and keep you COOKIN' IN STYLE.

# Contact Information

## Coordonnées :

## Contacte a:

### **Toastmaster Inc.**

National Service Center  
708 South Missouri Street  
Macon, Mo 63552

In USA and Canada call:

**Consumer Service: 1-800-947-3744**

**Consumer Parts: 1-800-947-3745**

**consumer\_relations@toastmaster.com**

**Hours: 8:00 A.M. - 5:30 P.M. CST**

Aux USA et au Canada, appeler les numéros suivants :

**Service Consommateurs : 1-800-947-3744**

**Pièces Consommateurs : 1-800-947-3745**

**consumer\_relations@toastmaster.com**

**Horaires : De 8h00 à 17h30, heure GMT - 6**

En México:

Toastmaster de México, S.A. de C.V.

Cerrada de Recursos

Hidráulicos Número 6

La Loma Industrial

Tlalnepantla de Baz, C.P. 54060

Estado de México

**52-5-397-2848**

**Horario: 8:00 a.m. hasta 5:30 p.m., hora del Centro**

## CONTACT US/APPELEZ



**1-800-947-3744**



**www.toastmaster.com**



**consumer\_relations@toastmaster.com**

©2003 Toastmaster Inc.

A Subsidiary of Salton, Inc.

Subsidiaria de Salton, Inc.

A una Subsidiaria de Salton, Inc.



**toastmaster®**

**21.**





toastmaster®

- Glass Door for easy viewing
- Timer Control (with 30-minute Timer and “Stay On” feature)
- Fully adjustable thermostat
- 4 rack positions
- Drop-Down Crumb Tray



## Questions

Call toll free 1-800-947-3744

Monday – Friday, 8:00 a.m. - 5:30 p.m. CST

[www.toastmaster.com](http://www.toastmaster.com)