

Puru Puru Signals Message by Vibration and Characters

Instruction Manual for SILWATCH

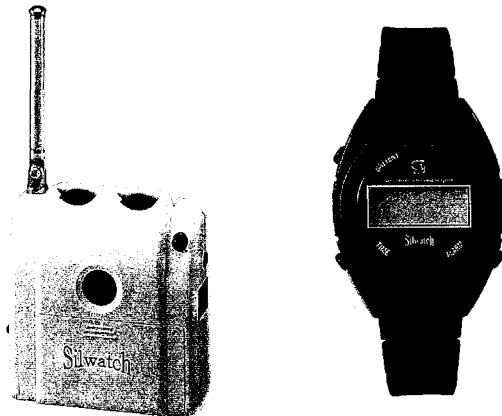

Thank you for purchasing "SILWATCH".
Before use, please read this instruction manual
well. Make sure you are familiar with it, and
then keep it at hand.

[contents]

ページ

1.Names of each part	1
2.SYSTEM FEATURE	2
[How to replace the transmitter batteries].....	3
3. How to Use the Watch	4
■Normal mode.....	4
■When wishing to see the time.....	4
■When wishing to adjust the time.....	4
■How to change over from intermittent to continuous time display	5
■How to turn on the back light.....	5
■When wishing to set the alarm function	5
■When wishing to release the alarm function.....	6
4. On Receiver batteries:	7
■How to confirm the residual power of batteries	7
■Duration of batteries:.....	7
■How to Replace Batteries.....	8
5. Notes on Use	9
■Requests and Notes on Batteries.....	11
■Daily Maintenance.....	12
■Trouble-shooting.....	12
Specifications	13

1. Names of each part

(A) Receiver

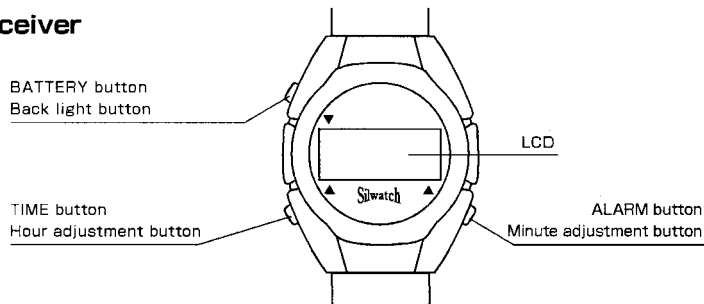

(B) Transmitter

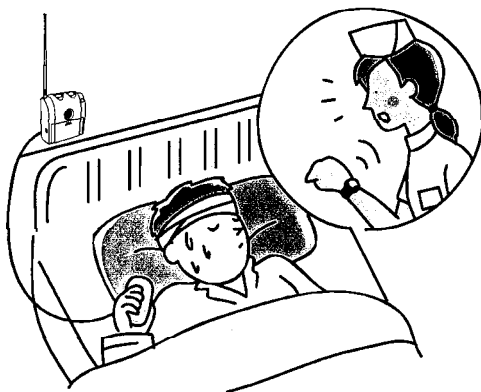
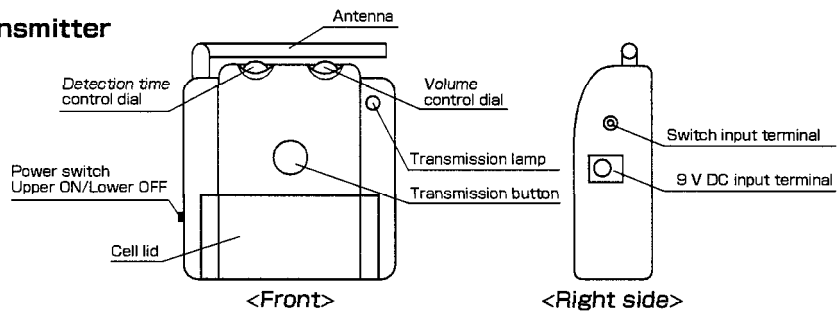

2.SYSTEM FEATURE

(A) Receiver

- When the wristwatch-type receiver captures signals transmitted from the transmitter or repeater, it tells you that a message has been received, by giving 3 vibrations at an interval of 1 second each, which you will feel as a "Puru Puru" vibration on your wrist produced by the built-in vibrator.
- Simultaneously it signals which transmitter sent the message, by showing characters for 10 seconds on the liquid crystal display (LCD), for example DOOR. Then it goes back automatically to its original state. While the characters are being displayed new incoming signals cannot be received.
- When the ALARM transmitter functions, both alarm vibrations and character display are continuously repeated. To avoid using up the battery too fast, press the TIME button of the receiver for a few seconds. This will return the LCD to the initial state.

※Normally the liquid crystal displays nothing. If the TIME button or ALARM button is pressed, the time is displayed for 10 seconds.

(B) Transmitter

- Captures signals from the doorbell or interphone found at the entrance, or fax, etc., and transmits signals by radio to the wristwatch-type receiver.

[Or by using the transmission button of the transmitter itself]

- The receiving party can be called from any transmitter by pressing the transmission button of the transmitter. When the transmission button is pressed, the transmission lamp is lit, and the receiver displays CALL.
- The transmitter can be used with batteries. You can therefore carry the CALL transmitter about.

Battery cells to use: 2 UM-4 cells. They should last approximately 1.5 months if used continuously with the power switch set to ON, and for approximately 1 year if the power is set to ON for 3 hours a day. When it is not going to be used for a long period of time, remove the dry cells.

[How to replace the transmitter batteries]

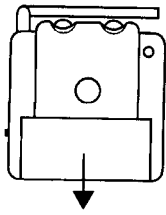

Pressing the battery cover, move it downwards and remove the batteries.

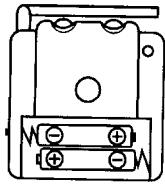

Pay attention to the position of + and -, and insert 2 UM-4 batteries.

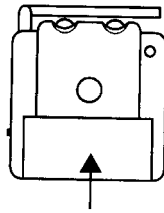

Replace the cell cover as it was, and press it in until there is a click.

The system is covered by Annex 11 of the R&TTE directive 99/5/EC. It has been tested for compliance with the standards EN300220, EN300683 and EN60950, with test reports from RFI and BSI, valid for all EU countries. Spectrum management authorities have been informed in the UK, Germany and other EU countries. The system can therefore be placed on the EU market. However, the following procedures must be strictly followed:

- The label stuck to the product is a proof of compliance certification for the relevant technical standards. Never peel off this label.
- The product bearing with the display label cannot be legally used if it has been disassembled or modified.
- Use after unauthorised modification could be subject to legal penalties.

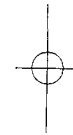

NOTE: This equipment has been tested and found to comply with the limits for a Class B digital device, pursuant to Part 15 of the FCC Rules.

These limits are designed to provide reasonable protection against harmful interference in a residential installation. This equipment generates use and can radiate radio frequency energy and, if not installed and used in accordance with instructions, may cause harmful interference to radio communications. However, there is no guarantee that interference will not occur in a particular installation. If this equipment does cause harmful interference to radio or television reception, which can be determined by turning the equipment off and on, the user is encouraged to try to correct the interference by one or more of the following measures.

- Reorient or re locate the receiving antenna.
- Increase the separation between the equipment and receiver.
- Connect the equipment into an outlet on a circuit different from that to which the receiver is connected.
- Consult the dealer or an experienced radio/TV technician for help.

This device complies with Part 15 of the FCC Rules. Operation is subject to the following two conditions: (1) This device may not cause harmful interference, and (2) this device must accept any interference received, including interference that may cause undesired operation.

Changes or modifications not expressly approved by the manufacturer for compliance could void the user's authority to operate the equipment.

3. How to Use the Watch

■ Normal mode

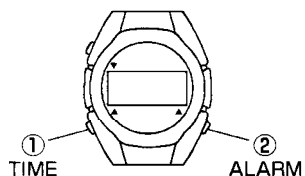

Normally there is no display on the liquid crystal. This is called normal mode.

All the operations are carried out by the two buttons, button ① (TIME) on the left side and button ② (ALARM) on the right side. If nothing further is for 10 seconds, it returns to the normal mode.

■ When wishing to see the time



Press either of them once.

The present time is displayed, and after being displayed for 10 seconds it automatically disappears, returning to the normal mode.

■ When wishing to adjust the time

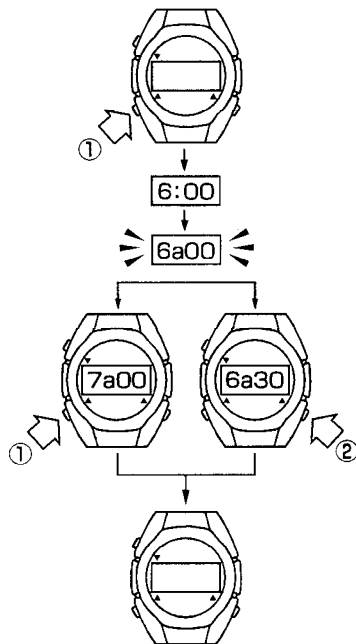

Press ① continuously.

The spacing between the hour and the minute becomes **a** (in the morning) or **P** (in the evening) from **:** and the hour and the minute flicker.

If ① is pressed, the hour gains, and if ② is pressed, the minute gains.

After adjusting the time, do not do anything further for the moment.

After the display disappears and it returns to the normal mode, the watch adjustment is completed.

■How to change over from intermittent to continuous time display -

By continuing to press the TIME button and ALARM button simultaneously for more than 2 seconds, the time display can be changed to continuous. Note however that this will shorten the life of the battery. To return to intermittent display, press both buttons again, for more than 2 seconds. When the display disappears, the change has been completed.

■How to turn on the back light

When the BATTERY button is pressed, the back lights at both ends of the LCD are lit and the LCD itself can be seen in the dark.

■When wishing to set the alarm function -

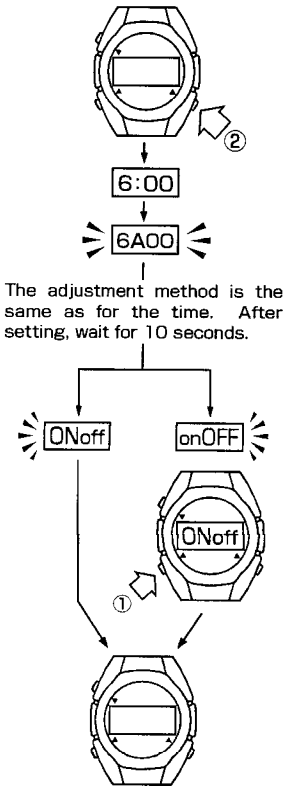

Press ② continuously.

The spacing between the hour and the minute changes from [] to [A] (in the morning) or [P] (in the afternoon).

The display comes out as [ONoff] or [onOFF].

If it comes out [onOFF] press ① to set it to [ONoff]

Do nothing further. After the display disappears, the alarm function setting is completed.

※ Once it has been set the alarm function works at the same time every day.

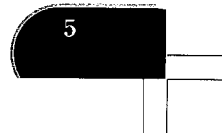

■ When wishing to release the alarm function

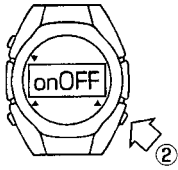

Press ② continuously.

The spacing between the hour and the minute becomes **A** (in the morning) or **P** (in the afternoon) instead of **:**.

Do nothing for 10 seconds.

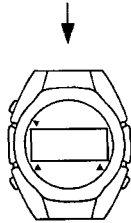

After the display comes out as **ONoff**, press ② and set it to **onOFF**. Do nothing for the moment.

After the display disappears, the alarm function release is completed.

If you get into difficulty during the changeover, wait until the display disappears and start again from the beginning.



4. On Receiver batteries:

■ How to confirm the residual power of batteries -

Press the BATTERY button of the receiver, and if the back light does not light up, it is time to replace the batteries. Replace with the designated batteries a little earlier.

■ Duration of batteries:

Battery used	Time (liquid crystal) display	Normal usage (5 to 6 times a day)	The longest day
CR2450 (600mA)	Normally none	168 days	241 days
	Regular display	49 days	70 days
CR2032 (210mA)	Normally none	58 days	84 days
	Regular display	16 days	24 days

The life of batteries changes according to the frequency of use and working conditions. Please bear this in mind.

In this connection, note that when using an alarm function and when receiving an alarm signal, vibrations will continue until the signal is switched off by pressing the TIME button for a while.

Leaving the alarm signal on will shorten the life of the batteries - so please treat this with caution.

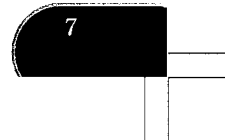
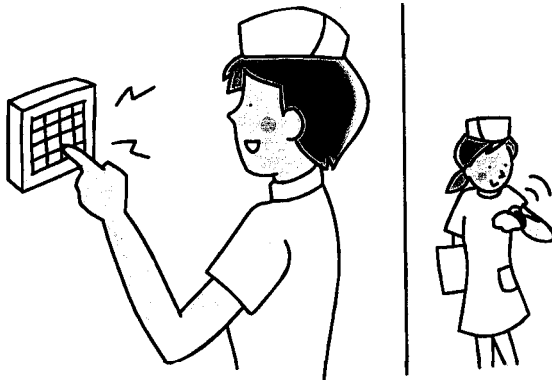

■ How to Replace Batteries

(Batteries Used: CR2450 or CR2032)

[Back of receiver]

Be sure to adjust ▲ as illustrated.

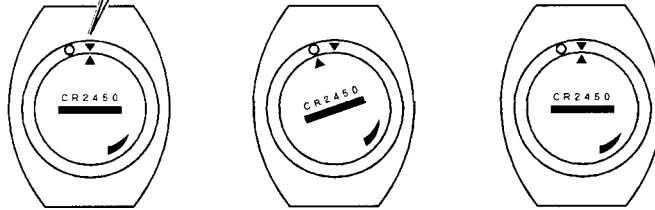

To open: Turn to the left with a suitable coin, pressing in the lid firmly

Open the lid, and replace the battery.

To close: Turn to the right, pressing in the lid firmly, and close - there should be a click.

FINISH

In the case of CR2450

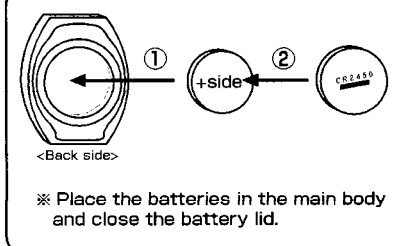

In the case of CR2032

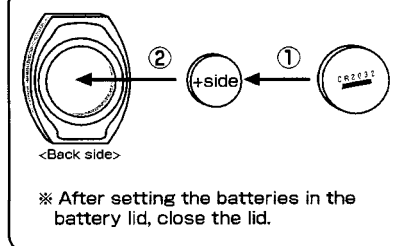

■ When Replacing Batteries

- For the receiver 2 kinds of batteries, CR2450 and CR2032, can be used. Since they have a battery lid, use the lids exclusively.
 - Transmission of electricity may be affected if fingerprints, stains, etc. are stuck to the surface and back of the battery.
- If necessary, wipe the battery clean with a soft cloth.

5. Notes on Use

1. **Waterproofing:** Sufficient for everyday waterproofing, with minor temporary splashing like washing one's face, being in the rain, etc.
But it cannot be left immersed in water. If it does get soaked with water or perspiration, wipe away the moisture as soon as possible with a good absorbent cloth.
 2. **Shock:** Light sporting activity, such as golfing, catch ball, etc., should have no effect. However, do not drop or bang it.
 3. **Static electricity:** Do not leave it in a place where there is likely to be static electricity. In particular, since the television screen can discharge strong static electricity, keep Silwatch away from TV screens.
 4. **Magnetism:** Do not leave it close to any instruments that generate a strong magnetic field, such as health devices using magnets, etc.
 5. The receiver has been adjusted for wearing on the arm at normal temperatures (5°C to 35°C). Avoid using under extreme temperature conditions.
 6. **Chemicals:** Avoid exposure to chemicals or gases. If solvents like thinner or benzine, etc. and those containing solvents (gasoline, manicure, toilet detergents, adhesive, etc.) get into the receiver and/or the wristband, they could cause discoloration, deterioration and/or breakage. Avoid such materials.
 7. **On skin eruption and allergy:** Use a wristband with some allowance for movement and fresh air to get between the band and the skin. If people with a sensitive constitution, according to their physical condition, suffer skin eruptions or other abnormality on the skin, they should immediately stop using the instrument and consult a doctor.
8. **Other notes**
- ⚠ When handling the system please be careful not to injure yourself accidentally, for example when installing the receiver. In the case of contact with infants, in particular, be very careful about possible injury or allergic reaction.
 - ⚠ Firmly insert the AC adapter connected to the transmitter so that there is no looseness in the insertion to the input terminal side and the insertion to the source of power. If the insertion is insufficient, there could be a short-circuit,

with the danger of breakdown, heat generation, luminescence, etc., So please be careful about this. In case there is a malfunction causing smoke to come out, with a strange odour and so on, pull out the AC adapter from the outlet and after confirming that the smoke has stopped, request investigation and/or repair through our company or distributor.

- ⚠ In case the product is not used for a long period of time due to travel, etc., pull out the AC adapter from the outlet of the transmitter for safety's sake. Also, when batteries are not being used, remove them. If they are left installed for a long period of time they may cause trouble, such as liquid leaking out.
- ⚠ Since the transmitter is not of rainproof and drip-proof construction, do not mount it in a place where water is splashed about, in the open air for example, or in a bathroom. Also avoid mounting it in a place where vibrations are generated, such as a door or sliding door. Dropping the transmitter could cause injury to a person or damage to the product.
- ⚠ Do not leave either the transmitter or the receiver in places where there may be a high temperature, for example in a vehicle, for a long period of time. That could cause a fire and/or electrification. Also, avoid if possible using the system outdoors, particularly where there may be salt damage, or in a very dusty place. The system might not stand up to such conditions for a long period of time.
- Avoid using the transmitter and receiver near to domestic electrical apparatus such as a personal computer, printer, word processor, television set, microwave oven or refrigerator. Also be careful about connecting the AC adapter for the transmitter of our product to a multiple-plug electricity connector, which can put many loads on one electrical outlet for the extension cord. This could result in shortening the reach distance of the radio wave, or cause malfunctioning.
- If the system has been working normally, but then slows down, and then becomes normal again a time lapse, it may be suffering from disturbance from other radio waves, or noise. Install it in a place that does not suffer from such disturbance. It may also be that the receiver batteries are nearly exhausted and need replacing.
- ⚠ Firmly fix the wiring cord and make sure it cannot get twisted around the neck and/or hands and feet. In particular, firmly fix the microphone cord for baby sensor a bit on the short side, so that the baby cannot get entangled in it or put the microphone in its mouth.
- ⚠ Do not take either the transmitter or the receiver to pieces by yourself, nor

put your fingers inside them. There may be a risk of short-circuited and/or electric shock.

■ Requests and Notes on Batteries

1. Battery life: With new and normal batteries fitted the battery life of the receiver can be approximately 5,784 hours (about 241 days) at the longest.
2. Battery replacement: If the residual power of batteries becomes low it may cause malfunctioning, therefore carry out replacement a little earlier. Since dead batteries which are left inside the receiver or transmitter for a long period of time can cause problems like leaking liquid, etc., replace them a little earlier. Since electricity may not be conducted properly if fingerprints or stains are stuck on the surface and back of button batteries, replace them after wiping off cleanly with a soft cloth.
3. Notes:
 - Discard used batteries immediately in a place where children cannot reach them. In case of any swellings after contact with batteries, contact a doctor immediately.
 - To avoid the danger of breakdown, heat generation, luminescence, etc., absolutely do not short-circuit, take to pieces, or expose the batteries to heat or fire.
 - As this battery is not of the rechargeable type, absolutely do not attempt to recharge it.

⚠ Note

The product is an information transfer system and not a preventive device to prevent crimes, fires, etc. from happening. In the case of sneak-thievery, robbery, intrusion by perverts, accidental damage or disaster or accident resulting in injury or death which may occur while this product is in use, our company is not in a position to bear any kind of responsibility. Please understand this in advance.

■ Range Distance of Radio Waves

The range or reach distance of radio waves is affected according to the conditions of use, such as the presence of reinforcing bars, concrete, heat insulating material, fireproofing glass, etc., which can disturb the transmission of radio waves. In a house where the above-mentioned materials are extensively used, the range may become extremely short.

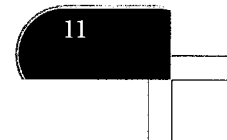

■Daily Maintenance

- The case and the wristband are directly in contact with the skin, similarly to underwear. If they are neglected and become stained this could result a cause of skin eruption, so always keep them clean when using.
- Stains on the receiver should only be removed by wiping off perspiration and/or moisture with a soft cloth, or the life of the case and wristband could be affected.
- A wristband of soft plastic like urethane is a chemical product, which may be changed in quality by a solvent. Also, as the material comes to be hardened by normal use after a few years, it should then be replaced with a new wristband.

■Trouble-shooting

If it does not seem to be functioning normally, first try replace the battery cells of the receiver (wrist watch). In normal function is not restored, check whether the power supply (AC adapter) of each transmitter is set to ON or whether the wiring or the connection is out of order. Also, where the transmitter is used with batteries, check in case they have become run-down and make sure they are firmly inserted. If problem persist, inform your supplier.

⚠Notes and Warnings.

Specifications

Specification	Receiver	Transmitter	Repeater
Type Number	WC-0111	WC-0113	WC-0114
Radio wave used	426 MHz band		
Power supply used	CR2450 cell 3 V CR2032 cell 3 V	100 V AC - 9 V DC adapter or UM-4 cells (2 pieces)	
Rated current	35mA MAX	15mA MAX	
Transmitting output	-	1mW+20%/-50%	
Identification code	7 kinds + 1 (Alarm)	2 kinds (Switch and sensor)	
Overall size (mm)	52x41 x 14 (16)	65 x 62 x 23 (Except antenna and projection part)	
Weight (g)	48	140	180g
Storage temperature	-10 degrees to + 80 degrees	-10 degrees to + 126 degrees	-10 degrees to + 80 degrees
Operating temperature	0 degree to + 50 degrees	-5 degrees to + 80 degrees	0 degree to + 50 degrees
Signaling speed	512bps		
Data bit	21bits		
Waterproofing performance	Normal exposure to slight splashing in everyday life		
Cell life*1	CR2450 168days CR2032 58days	1.5 months (When the power switch is kept ON)	1 year
Standard	Specific small power ARIB STD.T67		
Accessories	Lithium cell CR2450 Lithium cell CR2032	100 V AC- 9 V DC adapter	

*1 The indicated battery cell life for the receiver is in the case of normal use (Used 5 to 6 times a day, without watch display)

- Since this product is a radio wave communication system, there may sometimes - though rarely - be defective functioning caused by the surrounding radio wave conditions.
- These specifications may be changed without notice improvements are introduced.



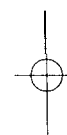
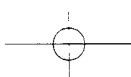

Manufactured and sold by
Tokyo Shinyu Co., Ltd.,

Shinjuku KM Bldg., 14-5, Shinjuku 1-chome, Shinjuku-ku,
Tokyo 160-0022

FAX +81-3-3358-6330 TEL +81-3-3358-8000
<http://www.shinyu.co.jp/> e-mail:info@shinyu.co.jp

Distributed by

