



# Tata Indica - V2

## XETA LPG

### Owner's Manual & Service Book

**TATA MOTORS**  
Passenger Car Business Unit  
• Mumbai • Pune •

( This owner's manual is advised to be kept in the vehicle at all times )

- 
- Should any question or query exist regarding any aspect of your car, please contact the nearest **TATA MOTORS** dealers, who will be pleased to assist wherever possible.
  - The recommended routine maintenance servicing along with any running repairs that may be required, should be entrusted to **TATA MOTORS** dealerships or to **TATA MOTORS Authorised Service Centres (TASCs)** or **TATA MOTORS Authorised Service Points (TASPs)** to ensure that only latest methods and genuine **TATA MOTORS** replacement parts are used for the continued reliability, safety and performance of the vehicle.
  - In the event of the vehicle being sold, please ensure that this manual is left in the vehicle for the reference of the new owner.
  - This Owner's manual and service book includes information of the operation and maintenance of various equipment installed on the different versions of Tata Indica V2 car. Please note that this manual applies to all the models and explains all equipment including options not installed on your car.

© Copyright 2004 **TATA MOTORS**

All rights reserved. The material in this manual may not be reproduced or copied, in whole or in part, in any form without written permission from **TATA MOTORS**.



***Dear Customer,***

*Thank you for selecting **Tata Indica V2 XETA LPG** - an Eco Friendly car of your choice*

*We welcome you to the world of advanced automotive engineering in a form especially suited to your operating conditions. Tata Indica LPG incorporates the latest generation LPG Injection Technology.*

*This Supplement gives you all the information necessary for making your ownership of this car a thoroughly satisfying and enjoyable experience.*

*To assist you in maintaining your car as per recommended schedule, we have a widespread network of dealers and service centres. The list is included in this book for your convenience.*

*If you need any special assistance, please call on our Regional / Zonal level offices which are also listed in this book.*

*Please note that by adhering to the correct operating procedures and by availing the scheduled maintenance services at our authorised service centres, you can obtain the maximum performance from your car.*

*We request you to go through the book and derive many miles of motoring pleasure.*

***We wish you Safe and Happy Driving***

**TATA MOTORS LIMITED**





# CONTENTS

<b>INTRODUCTION</b>	<b>7</b>	
<b>VALUE ADDED SERVICE</b>	<b>9</b>	
<b>TAKING CARE OF THE ENVIRONMENT</b>	<b>17</b>	
		We request you to spend a few minutes in going through our environmental concern
<b>WARRANTY</b>	<b>19</b>	
<b>INFORMATION AT A GLANCE</b>	<b>21</b>	
		• Filling Station Information • Car Dimensions
<b>INTRODUCTION - LPG</b>	<b>23</b>	
		• Know your Indica LPG • Safety • Compliance to Motor Vehicle rules • Location of LPG system • Location of fuses
<b>BEFORE DRIVING</b>	<b>33</b>	
		• Controls • Instrument Panel • Heating, Ventilation & Air Conditioning • Interiors and Accessories
<b>STARTING &amp; DRIVING THE CAR</b>	<b>75</b>	
		• Check List • Starting & Stopping • Preparing to Drive • Fuel Economy • Driving in adverse conditions • Driving Petrol cars • Driving safety
<b>MAINTENANCE &amp; CAR CARE</b>	<b>91</b>	
		• Engine Compartment Lamp • Windshield Washer • Air Filter • Engine Cooling System • Engine Belt Tension • Oil & Oil Filter • Fuel Filter • Transaxle • Fuel Filling Cap • Clutch & Brakes • Power Steering • Battery • Catalytic Converter • Spark Plug • EGR System (Diesel Engine) • Fuses & Relays • Wheels & Tyres
<b>EMERGENCY SERVICE TIPS</b>	<b>129</b>	
		• Engine • Clutch • Transaxle • Brakes • Steering System • Electrical • Suspension
<b>IMPORTANT INFORMATION</b>	<b>137</b>	
		• Location of Aggregate Numbers • Fuel, Coolants & Lubricants • Technical Specifications • Service Schedule • Car Record Sheet
<b>LIST OF LPG FILLING STATIONS</b>	<b>155</b>	
<b>CUSTOMER SUPPORT NETWORK</b>	<b>175</b>	
		• Tata Motors Offices & Network • Names & Address of Tata Motors Main Dealers (MDs), Tata Motors Authorised Service Centres (TASCs), Tata Motors Authorised Service Points (TASPs)



**CUSTOMER CARE  
CENTRE  
TOLL FREE NO.  
1-800-209-6688**



## INTRODUCTION

Congratulations on acquiring the **Tata Indica V2 XETA LPG** and welcome to the family of **Tata Indica car** owners.

This owner's manual has been prepared to acquaint you with the operation and maintenance of your new **Tata Indica V2 XETA LPG** and to provide you with important safety information and tips for effective driving. Please refer to it from time to time for enjoyable, safe and troublefree driving pleasure.

This manual is an essential part of your car and should always be kept in the car.

Regular servicing of your car ensures its road worthiness and troublefree operation.

To assist you in maintaining your **Tata Indica V2 XETA LPG** we have a network of dealers and Service Centres throughout the country. The list is included in this manual for your convenience.

*Happy motoring*

**TATA MOTORS**

**Tata Indica V2 XETA LPG** is a safe car designed for quality performance. In order to maintain the level of performance and reliability, it is important that only Tata Motors genuine accessories are to be fitted. Any accessory that is fitted or modification that is carried out without authorisation can hamper the safety & performance of the car besides depriving you of your warranty benefits.

Use of genuine parts, designed and manufactured to our exacting standards, is the best way to maintain your **Tata Indica V2 XETA LPG** in peak operating condition. Please do not use substitutes. They always prove costlier in the long run.

**Failure to use genuine parts can invalidate warranty claims.**

The information and specifications given in this book are valid as on the date of printing. Tata Motors reserves the right to make changes in design and specifications and/or to make additions to or improvements in this product without obligation to install them on products previously sold.



Indicates "CAUTION"





## VALUE ADDED SERVICE

**Dear Customer,**

*It is our never ending responsibility and endeavor to ensure that our customer's expectations are fulfilled comprehensively. To fulfill your vehicle service needs, we recommend the following :*

- 1) Extended Warranty*
- 2) Anti Rust / Sound Deadening / Engine waxing treatment*
- 3) Iftex Fuel Additive : System D (For diesel) and System G (For Petrol)*
- 4) Car detailing programming : Exterior Enrichment and Interior Enrichment Program*

*These products shall help maintain optimum vehicle performance and shall enhance vehicle life.*

*We have tied up with best in the Class companies, who would bring you the above world class products at affordable prices. The above products are available with all our Dealers, TASCs and TASP.*

*Our Dealer Service marketing executive shall explain to you the benefits of the above mentioned products.*



## EXTENDED WARRANTY

---

Tata Motors recommends the purchase of Extended Warranty, a product of **M/s Global Administration Services and United India Insurance.**

**Coverage :** Mechanical + Electrical + Emission

**Benifits :**

- Insures you against unforeseen break down repair bills.
- Documentation is simple and hassle free.
- Near cashless & speedy claim settlement.

**Term :**

- 18 + 18 or 150000 kms whichever occurs first (For Indica, Indigo & Sumo).
- 18 + 30 or 150000 kms whichever occurs first (For Indica, Indigo, Sumo and Safari Dicor).
- 50000 kms + 50000 kms or 36 months whichever occurs first (For Taxis).
- 50000 kms + 100000 kms or 36 months whichever occurs earlier (for Taxis-Indica, Indigo, Marina).

**EMISSION WARRANTY :** Emission warranty is limited to the period of the Extended Warranty or 80,000 kms whichever is earlier.

**Extended Warranty** available in the dealership from where you have purchased your vehicle. We strongly recommend purchase of Extended Warranty at time of purchase of your vehicle. Surcharge applicable on purchase of Extended Warranty after 30 days of purchase of vehicle. The **Dealer Service Marketing Executive** shall explain to you the Terms and conditions, Coverage and Owner's responsibility.

**Extended Warranty Booklet & Cover Note :**

The Extended Warranty booklet and cover note is the basis of the contract between United India Insurance Co. and the Owner of the vehicle shown on the Extended Warranty Cover note. The Customer to retain this booklet and the same to be produced to the dealer while claiming benefits under Extended Warranty.



## EXTENDED WARRANTY

### Note :

- The 18 / 30 month extended warranty does not follow the 18 month Manufacturer's warranty.
- The extended warranty comes into force once the manufacturer's warranty expires e.g. after 18 Months.
- It is more restrictive as by the time it comes into force the vehicle is already 18 months old.

### What is covered ?

- Mechanical / Emission / Electrical break down as defined in this warranty and confirmed by the dealer within the stipulated terms and conditions.
- Tata Motors dealer shall either repair or replace any part found to be defective with a new part or an equivalent at no cost to the owner for parts or labour.
- Such defective parts which have been replaced will become property of United India Insurance Company.
- Comprehensive list of parts covered is mentioned in the page 9-12 of the Extended Warranty Booklet.

### What is not covered ?

Pages 6 – 7 of the Extended Warranty Booklet provided details of the exclusion list.

### Owner's Responsibility :

- Proper use, maintenance and care of the vehicle in accordance with the instructions contained in the Owner's Manual and Service Booklet. The records of the same to be ensured in Owner's Manual.
- Retention of maintenance service bills.
- Always produce extended warranty booklet while servicing & claim in a warranty..

---

I / We have been explained the Terms and conditions, Coverage and Owner's responsibility by the Dealer Service Marketing Executive.

I wish to avail /  Do not wish to avail extended warranty

---

**Customer's Sign**

---

**Dealer's Sign**

## FUEL ADDITIVES

---

**IFTEX: Triple action diesel additive :**

***One Additive, multiple benefits***

- For diesel cars: Iftex System D
- For Petrol cars: Iftex System G

***Benefits:***

- Cleans injector and fuel system.
- Maintains peak engine performance.
- Saves diesel / petrol and maintenance cost.
- Reduces smoke and harmful emission.
- Helps Smooth running of the engine
- Reduces deposit on intake manifold and combustion chamber.
- Reduces deposit on injector tips.



**Approved for use in TATA INDICA, INDIGO, SUMO & SAFARI**

**TREAT YOUR CAR TO EXPERIENCE, THE ULTIMATE PERFORMANCE**

**Directions of use :**

- Remove cap, squeeze lightly till dispenser fills to 10 ml mark. Add before filling up the tank.
- Use at the rate of 1 ml per litre of fuel. For best results, regular use is recommended.

---

I / We have been explained the Terms and conditions, Coverage and Owner's responsibility by the Dealer Service Marketing Executive.

I wish to use /  Do not wish to use this treatment

---

**Customer's Sign**

---

**Dealer's Sign**

## ANTI RUST, SOUND DEADENING & ENGINE WAXING

### **Why are Corrosion Protection Waxes necessary?**

#### ***Corrosion is caused by:***

Water / salt water acid rain & atmospheric fallouts.

#### ***Critical areas are:***

Cavities: joints, crevices, spot welds, underbody

- Corrosion is the most important factor when we talk about the vehicle life. If you treat your car you can prolong the life.
- It is very dangerous to drive around in a corroded car.
- The corrosion creeps onto the car from the inside and from the outside. The most dangerous kind of corrosion is often not discovered until it is too late.

#### ***Benefits of Anti-Rust treatment :***

- A professionally applied range of world class products offering real value to the new and used car customer.
- The treatment has been developed to withstand the harshest environmental and climatic conditions (rst. Pollutants, stone and gravel impact, etc)
- Insulate cabin space from external noises.
- Expensive tin work and Denting / Painting avoided.
- Higher resale value for the car.
- Higher safety – uncorroded vehicle
- Upto 60 months warranty & 10 free checkups available



## ANTI RUST, SOUND DEADENING & ENGINE WAXING

---

### Engine Wax Treatment :

Engine Wax is a beige coloured transparent lacquer coating on the engine compartment.

- Corrosion Prevention for the Engine compartment
- Neat, clean and New Look to Engine compartment
- No effect on MPFI vehicles
- Engine wax can withstand upto 200 degrees temp
- No need of cleaning the engine compartment with diesel once engine wax is sprayed
- Life of over a year

### Sound Deadening System :

Door vibration deadeners - These pads when stuck on the insides of the sheet metal increase sheet metal rigidity, reduce vibrations and increase riding comfort.

- Used for reducing the sheet metal vibration in a vehicle.
- Product to be used once in the life of the vehicle - Life Time Warranty
- Effect is Life long i.e. until & unless pads are physically removed.
- Negligible increase in Weight & hence no effect on fuel consumption.
- Areas covered - four doors, rear quarter panels & dicky. In case of diesel vehicles, can be used in the bonnet.

**Tata Motors** has tied up with **M/s Wuerth and M/s STS Chemicals (Dinitrol)** for this world class treatment at affordable prices. This treatment is available in all authorized workshops. The Dealer Service Marketing Executive will explain to you the benefits and terms and conditions of this treatment.

---

I / We have been explained the Terms and conditions, Coverage and Owner's responsibility by the Dealer Service Marketing Executive.

I wish to avail /  Do not wish to avail these treatment

\_\_\_\_\_  
**Customer's Sign**

\_\_\_\_\_  
**Dealer's Sign**

## EXTERIOR AND INTERIOR ENRICHMENT PROGRAM

### Vehicle Exterior Enrichment :

#### *Why vehicles are painted?*

- For Corrosion protection of the metal surfaces.
- Ease of application from other corrosion protection treatments.
- Cheaper than other corrosion protection methods eg.galvanizing, anodizing.
- For decoration and identification.

#### **Various Environmental Hazards affecting paints :**

- Environmental hazards: destroy your vehicle's finish.
- Even as your new vehicle rolls off the assembly line, the paint is not protected.

#### **The enemy :**

Ultraviolet Rays, Pollution, Tree Sap, Bird Droppings, Car Wash Chemicals, Road Salt, Acid Rain.

#### **Benefits:** Vehicle Exterior Enrichment

- Removal of medium scratches, orange peel, oxidation , dust nibs etc & swirl marks from painted surface.
- Restoration of original gloss levels UV protection after gloss is restored.
- Cleaning & dressing of tyres, Bumpers & all exterior plastic moldings/trims.

**Tata Motors** has tied up with **M/s Opulent (Waxoyl brand)** and **M/s 3M** for this world class treatment at affordable prices. This treatment is available in all authorized workshops. The Dealer Service Marketing Executive will explain to you the benefits and terms and conditions of this treatment.



## EXTERIOR AND INTERIOR ENRICHMENT PROGRAM

---

### Vehicle Interior Enrichment

#### *Why protect your new car's fabric interior ?*

- Someone will soil your vehicle's fabric carpet or seats.
- A significant detractor from your vehicle's resale value.
- A permanent stain on your vehicle's interior fabric.

#### **The enemy :**

Drink Spills - Food Stains - Mud - Ultraviolet Rays Pets - Traffic

#### **Benefits:** Vehicle Interior Enrichment

- Removal of medium stains and dirt from all interior parts of the car i.e carpet, upholstery and roof lining.
- Cleaning of windshield and all windows (inside and outside)
- Dressing of all internal plastics (eg: door pad trims )and rubber parts.
- The treatment involves cleaning and dressing of All parts of the exposed interiors.
- Specialised protection for seat fabric from liquid spills.

**Tata Motors** has tied up with **M/s Opulent (Waxoyl brand and M/s 3M** for this world class treatment at affordable prices. This treatment is available in all authorized workshops. The Dealer Service Marketing Executive will explain to you the benefits and terms and conditions of this treatment.

---

I / We have been explained the Terms and conditions, Coverage and Owner's responsibility by the Dealer Service Marketing Executive.

I wish to avail /  Do not wish to avail these treatment

\_\_\_\_\_  
**Customer's Sign**

\_\_\_\_\_  
**Dealer's Sign**



## ENVIRONMENTAL PROTECTION

### Taking care of the Environment

**Tata Motors** is committed to producing cars using environmental friendly technology. A number of features have been incorporated in our passenger cars which are specifically designed to ensure environmental compatibility throughout the life cycle of the car. We would like to inform you that your car meets Emission norms and is being regularly validated at the manufacturing stages to keep up with the stringent emission norms.

As a user you too can protect the environment by operating your car in a proactive manner. A lot depends on your driving style and the way you maintain your car. Listed below are few tips that will help you do so.

#### WHILE DRIVING :

- Avoid frequent and violent acceleration.
- Do not carry any unnecessary weight on the vehicle as it overloads the engine.
- Avoid using devices requiring high power consumption during slow traffic condition.
- It is not advisable to warm up the engine during the first start of the day by idling, as cold temperatures

## Taking Care of the Environment

within the engine could cause rise in the emission such as CO & HC particulate.

- Monitor the car's fuel consumption regularly. If it shows a rising trend get the car immediately attended to at the TATA MOTORS Authorised Service Centre.
- Switch off the engine during long stops at traffic jams or signals. If you need to keep the engine running, avoid unnecessarily revving or stopping and starting.
- Use only **unleaded fuel** in petrol cars.
- It is not necessary to rev up the engine before turning it off as it unnecessarily burns the fuel.
- For petrol cars switch off the ignition only when engine is at idling and when the vehicle is stationary, not when the vehicle is running.
- Shift to higher gears as soon as it is possible. Use each gear upto 2/3<sup>rd</sup> of it's maximum engine speed. A chart indicating gear shifting speeds is given in this book.

#### MAINTENANCE OF THE CAR :

- Ensure that recommended maintenance is carried out on the car regularly at the TATA MOTORS Authorised Service Outlets.

## **ENVIRONMENTAL PROTECTION**

- As soon as you notice any leakage of oil or fuel in the car we recommend that you get it attended immediately.
- Use only recommended brands and grades of lubricants & coolants and clean/uncontaminated fuels.
- Get your vehicle checked for emission periodically by our authorised dealer and regularly renew the P.U.C. Certificate.
- Ensure that fuel filter, oil filter, breathers are periodically checked and if required, replace the same using only genuine recommended brands.
- Do not pour used oils or coolants into sewage drains, garden soil or open streams. Dispose of the used filters and batteries in compliance with the current legislation.
- Do not allow any unauthorised person to tamper with the engine settings or to carry out modifications on the car.
- Never allow the vehicle to run out of fuel. This will result in misfiring of the engine and could cause harm to the catalytic converter.

## **Taking Care of the Environment**

- Parts like brake liners and clutch disc should be vacuum cleaned. Do not use compressed air for cleaning these parts which may spread the dust in the atmosphere.

While carrying out the servicing or repairs of your car, you should pay keen attention to some of the important engine aggregates which greatly affect emission. These components are :-

- 1. Fuel pump, Injectors / LPG Fuel System**
- 2. Air intake & Exhaust system especially for leakages**
- 3. Cylinder head for valve leakage**
- 4. All filters such as air, oil & fuel filters (check periodically)**
- 5. Catalytic converter**
- 6. Ignition system - Spark plug gap**

This Owner's Manual & Service Book contains further information on driving precautions and maintenance care leading to environment protection. Please familiarise yourself with these aspects before driving.

## WARRANTY

We WARRANT each **Tata Indica Xeta LPG** car and parts thereof manufactured by us to be free from defect in material and workmanship subject to the following conditions -

1. This warranty shall be for 18 months from the date of sale of the car irrespective of the distance covered. However, for the cars used for commercial applications (used for hire or reward viz those operating with a yellow number plate), the warranty shall be limited to 18 months or 50,000 kms, whichever occurs earlier.
2. Our obligation under this warranty shall be limited to repairing or replacing, free of charge, such parts of the car which, in our opinion, are defective, on the car being brought to us or to our dealers within the warranty period. The parts so repaired or replaced shall also be warranted for quality and workmanship but such warranty shall be co-terminus with this original warranty.
3. Any part which is found to be defective and is replaced by us under the warranty shall be our property.
4. As for such parts as tyres, batteries, electrical equipment, fuel injection equipment, etc. not manufactured by us but supplied by other parties, this warranty shall not apply, but buyers of the car shall be entitled to, so far as permissible by law, all such rights as we may have against such parties under their warranties in respect of such parts.
5. This warranty shall not apply if the car or any part thereof is repaired or altered otherwise than in accordance with our standard repair procedure or by any person other than from our sales or service establishments, our authorised dealers, service centres or service points in any way so as, in our judgement which shall be final and binding, to affect

## Terms and Conditions

- its reliability, nor shall it apply if, in our opinion which shall be final and binding, the car is subjected to misuse, negligence, improper or inadequate maintenance or accident or loading in excess of such carrying capacity as certified by us, or such services as prescribed in our Owner's Manual and Service Book are not carried out by the buyer through our sales or service establishments, our authorised dealers, service centres or service points.
6. This warranty shall not cover normal wear and tear or any inherent normal deterioration of the car or any of its parts arising from the actual use of the car or any damage due to negligent or improper operation or storage of the car. This warranty shall not apply to normal maintenance services like oils & fluid changes,

## WARRANTY

head lamps focussing, fastener retightening, wheel balancing, tyre rotation, adjustment of valve clearance, fuel timing, ignition timing and consumables like bulbs, fuel filters & oil filters, etc. This warranty shall not apply to any damage or deterioration caused by environmental pollution or bird droppings. This warranty shall not apply to V-belts, hoses and gas leaks in case of air conditioned cars. Slight irregularities not recognised as affecting the function or quality of the vehicle or parts, such as slight noise or vibration, defects appearing only under particular or irregular operations are items considered characteristic of the vehicle.

7. This warranty shall be null and void if the car is subjected to abnormal use such as rallying, racing or participation in any other competitive sport. This warranty

shall not apply to any repair or replacements as a result of accident or collision.

8. This warranty is expressly in lieu of all warranties, whether by law or otherwise, expressed or implied, and all other obligations or liabilities on our part and we neither assume, nor authorise any person to assume on our behalf, any other liability arising from the sale of the car or any agreement in relation thereto.
9. The buyer shall have no other rights except those set out above and have, in particular, no right to repudiate the sale, or any agreement or to claim any reduction in the purchase price of the car, or to demand any damages or compensation for losses, incidental or indirect, or inconvenience or consequential damages, loss of car, or loss of time, or otherwise, incurred or accrued.

## Terms and Conditions

10. Any claim arising from this warranty shall be recognised only if it is notified in writing to us or to our authorised dealer without any delay soon after such defects as covered and ascertained under this warranty.
11. This warranty shall stand terminated if the car is transferred or otherwise alienated by the buyer without our prior written consent.
12. We reserve our rights to make any change or modification in design of the car or its parts or to introduce any improvement therein or to incorporate in the car any additional part or accessory at any time without incurring any obligation to incorporate the same in the cars previously sold.

 **TATA MOTORS**

## INFORMATION AT A GLANCE

## Filling Station Information

ENGINE OIL UPTO DIPSTICK MAX.MARK ~ 4.0 Ltrs.

FUEL TANK CAPACITY

PETROL 37 Ltrs.  
LPG 31 Ltrs.

\* Premixed ready  
to use Engine  
Coolant = 6 Litres

Windshield Washer  
reservior Capacity= 3.5  
Litres (for GLX) and 1.5 Litre  
(for GL/GLE/GLS/GLG)

Brake fluid = 0.265 Lires

TRANSAXLE OIL 3.3 Ltrs.

TYRE PRESSURE 33 PSI (2.3 bar) / 30 PSI (2.1 bar)  
FRONT / REAR

**IMPORTANT :** For petrol cars fitted with catalytic converter always use only unleaded petrol with an octane rating not less than RON 87.

For recommended oil grades and change intervals, refer lubricants chart and service schedule

## INFORMATION AT A GLANCE

## Dimensions

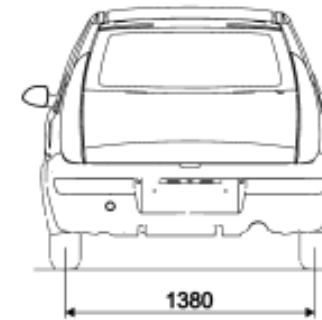
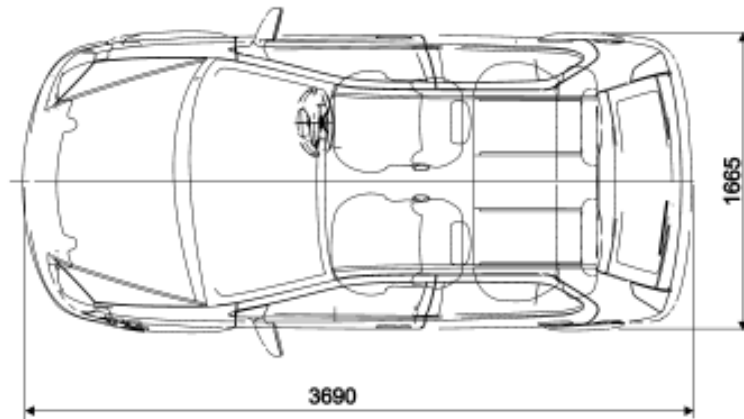
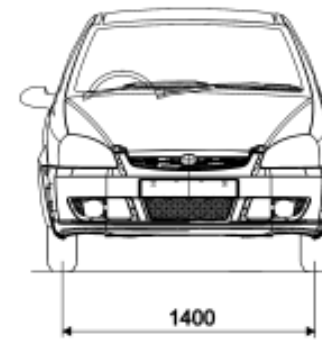
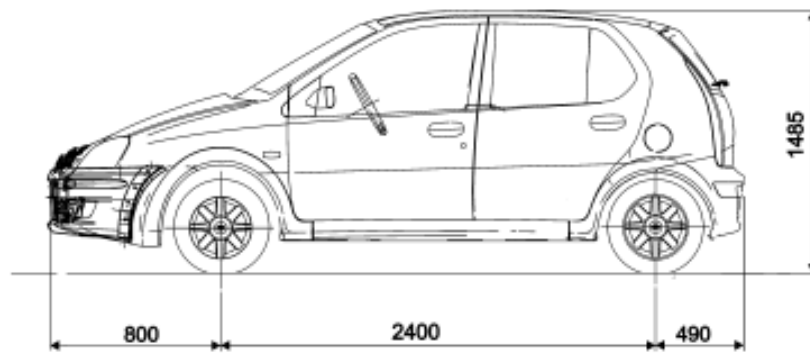

**Note :** Co-driver's side rear view mirrors for Deluxe version only.



## INTRODUCTION - LPG

- **INTRODUCTION - LPG**
- **KNOW YOUR INDICA LPG**
  - Starting the engine
  - Fuel (LPG) filling
  - Running on LPG
  - Fuel Selector Switch
  - Shifting the fuel mode
  - Do's and Dont's
- **SAFETY**
  - In case of gas leakage
  - Fire Extinguisher
  - Manual shut off knob / lever
  - Level Indicator
- **COMPLIANCE TO MOTOR VEHICLE RULES**
- **LOCATION OF LPG SYSTEM COMPONENTS**
- **LOCATION OF FUSES**

## INTRODUCTION

In addition to the full capacity of petrol the Indica Xeta now comes with LPG as additional fuel choice.

### WHAT IS LPG?

LPG or Liquefied Petroleum Gas is a safe and environment friendly fuel. It is a liquid under pressure and turns into gaseous state when exposed to the atmospheric pressure.

LPG is a non-toxic, non-corrosive; lead-free gas and is produced by refinery fractionation of oil or is stripped from naturally occurring Natural Gas.

LPG fuel system and the components are as safe as those in other fuel systems.

For LPG operation, press the Fuel Selector Switch provided on the dashboard, for approximately 3 seconds. The fuel change over happens automatically.

The switching between fuels (Petrol-LPG-Petrol) can be done at any time, even on the move.

Your car always starts in petrol / auto mode only. Hence it is a must to have petrol at all times during running.

## WARNING

**DO NOT USE DOMESTIC GAS CYLINDERS IN CAR** because...

- Domestic cylinders are **NOT** designed for Car application and this makes them vulnerable in a crash situation.
- The chemical composition of domestic LPG is different from that of Auto LPG, which may lead to premature failure of engine and its related components
- The gas outlet 'valve' arrangement on the domestic cylinder doesn't meet the car fuel supply standards and hence makes them more dangerous in the car. For example the valve is not provided with excess flow protection. This means that if the valve or supply line gets disconnected in a crash situation, there will be an uncontrolled flow of LPG into the car interior.
- When using domestic gas cylinder, your car's engine gets less supply of fuel when load on engine is increased (e.g. while climbing a ghat). This is because the cylinder cannot supply adequate LPG from the tank to the engine.



## KNOW YOUR INDICA LPG

### STARTING THE ENGINE

Irrespective of the position of the Selector switch (Petrol or LPG), your car's engine will always start using petrol by default and switch over to LPG later in case of LPG mode.

To start, turn the ignition "ON" and crank without pressing accelerator pedal.

### LPG FILLING

LPG filler valve is located at the rear on the right hand body side of your car. LPG filling will stop automatically once the LPG tank is filled to 80% of its capacity.

### LPG TANK CAPACITY

The LPG cylinder capacity of your car is 31 litres. If the LPG is filled after service / repairs of the LPG system, please check all joints for leakage by applying soap solution or by using an electronic instrument, (Example: Leakator - 10').

### NOTICE

Keep the Ignition switch in "OFF" condition during LPG refilling

### PETROL TANK CAPACITY

Your car has a petrol tank having a capacity of 37 litres



LPG Fuel Filling Cap

## KNOW YOUR INDICA LPG

## Running on LPG

### RUNNING ON LPG

A **Fuel Selector Switch** is provided on the dashboard. By operating this switch you can choose your fuel option for running.

**The Fuel Selector Switch has following functions :**

1. Fuel mode request (Petrol, LPG).
2. LPG level indication
3. Fuel mode indication
4. LPG System fault indication

**The Fuel Selector Switch has two modes :**

1. Petrol Mode : The Red LED comes ON
2. LPG Mode: The Amber LED comes ON

In Petrol Mode Engine starts and runs by using petrol as the fuel.

In LPG Mode, the engine starts by using Petrol and switches to LPG automatically.

### IMPORTANT

Ensure that your car has sufficient Petrol in the tank as petrol is used for starting always



Fuel Selector Switch

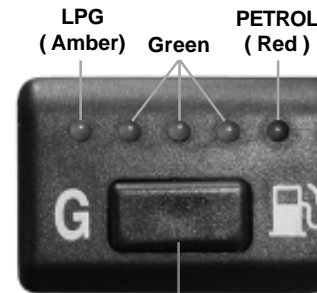

Fuel Selector Switch

**Petrol Mode :** Only Red light is ON

**LPG Mode :** Amber light is ON

## KNOW YOUR INDICA LPG

## Fuelling Modes

### HOW TO SHIFT THE FUELLING MODES :

#### Petrol to LPG Mode :

You can switch to LPG fuel mode by pressing and holding the Fuel Selector Switch at least for 3 seconds till the LED on the Switch starts toggling between two LEDs. On completion of the successful transition to the LPG mode, the Amber (LPG) LED glows permanently, indicating that the car is now in LPG mode

#### LPG to Petrol Mode:

Similarly you can switch from LPG to petrol mode by pressing the Fuel Selector Switch until the red light (Petrol) on the Fuel Selector Switch starts glowing permanently. This indicates that car is now running in petrol mode

### NOTICE

1. In case of fuel mode switching from Petrol to LPG mode during normal running, initially the LEDs toggle indicating the transition and when the LED glows permanently, this indicates the completion of the transition to the required fuel mode.
2. Fast toggling of the LEDs (amber to red) indicates fault in the LPG system. Car will automatically switch to Petrol mode. Please get car checked/repared at the nearest Authorised TATA service center.
3. Very slow toggling of the LEDs (amber to red) indicates the empty tank / no LPG supply (loss of pressure). Get the LPG tank re-filled.

Sr.No.	Approximate LPG Volume (Litres)	LED indication on Change Over Switch (COS)	Equivalent quantity of LPG in tank (%)
1	Up to 11 Litres	Amber	Below 25%
2	12 - 15 Litres	Amber + 1 Green LED	25%
3	16 - 20 Litres	Amber + 2 Green LED	50%
4	20+ Litres	Amber + 3 Green LED	80%

## KNOW YOUR INDICA LPG

## Do's & Dont's

### DO'S

- Always get the car repaired/serviced at the **Authorised TATA Service center** only.
- Never carry out any repair work on your own or from any other personnel other than from **Authorised TATA Service center**.
- Check LPG fuel system periodically for leakages  
Even though the Safety Solenoid valve (on tank & pressure regulator) closes automatically when you switch off Ignition, it is recommended to close the manual service valves during any service/repair activity on the car.
- Ensure adequate ventilation around the car during repair works.
- Ensure the LPG in the pipe lines is consumed by running the engine with closed manual service valves before any repair work on the gas lines/joints.
- Remove the LPG tank during the welding/brazing work on the Car.
- Fast toggling of fuel mode LED's on the Fuel Selector Switch means fault in the LPG system, please get the car repaired at the nearest **Authorised TATA Service center**.
- Immediately repair/replace any damaged fuel or system component.

- Use the fire extinguishers provided with the car in case of unlikely event of fire. These are provided, one near driver seat and the other one in the boot. Read instructions on Fire extinguisher to know how to use it.

### DON'TS

- Over filling the LPG Tank can cause safety issues like gas leakage . Please DONOT over fill the tank beyond its capacity of 31 litres.
- Keep the car away from any Fire source.
- **Never use naked flame/fire to check gas leakages.**
- Never carry out any welding/brazing on the LPG tanks.
- Avoid direct contact with LPG as it may cause frost burns.
- **Wash instructions** - Do not direct high pressure washer fluid/water jets at electrical devices & their connectors during washing. This is to prevent malfunction / failure of electrical system due to water ingress.
- Do not tamper any electrical or mechanical settings.
- Do not scrap / gas cut the LPG cylinder as it contains pressurised gas which is flammable.
- Do not leave the LPG tank cover open.  
For any clarifications please contact the **Authorised TATA Service center**

## KNOW YOUR INDICA LPG

## Safety

### IN CASE OF GAS LEAKAGE :

- Do not panic.
- The ECU automatically switches-off the LPG supply from the tank.
- As a safety precaution, close the manual shut - off valves provided on the 'Multifunction valve' located on the LPG tank. Ensure that the tank cover is properly fitted.
- Roll down all the windows and keep the doors fully open.
- The ECU will automatically switch the fuel mode to Petrol.
- The ECU will not allow you to switch to LPG mode until the leakage is rectified.
- Contact the nearest Tata Authorised service station and get car repaired.

### FIRE EXTINGUISHER :

Two fire extinguishers are provided on the car, one near driver seat and another in the luggage compartment.

Method of operation:

1. Check if the pressure gauge needle in green zone.
2. Hold upright and pull the pin.
3. Press the lever.
4. Direct discharge at base of flame with rapid sweeping motion.
5. Recharge the fire extinguisher after use.

### Maintenance :

Check pressure on the gauge every week, needle should remain in green region. If it comes to red region, please send for recharging. **The Fire Extinguisher is to be refilled every three years even if it is not used.**



Fire extinguisher near Driver's Seat



Fire extinguisher behind Rear Seat

## KNOW YOUR INDICA LPG

**Safety**

### MANUAL SHUT OFF KNOB / LEVER

This knob is used to shut OFF LPG flow & is located on the Multifunction valve, on the Auto LPG Tank. This valve should always be in open position (as per figure), so that there is unrestricted flow of LPG to the engine. When the valve is in the closed position, LPG flow to the engine is stopped.

This shut off valve must be closed in case some repairs need to be carried out on the LPG Tank. Ensure that the tank's cover is tightened /closed properly.

### LEVEL INDICATOR

A multivalve is mounted on the LPG tank that also has a gauge that shows LPG level in the tank. LPG level can also be known by the three green coloured lights on the Fuel Selector Switch. When the LPG tank is full, all three green lights will glow. As the level of LPG goes down, the green lights will also go off one by one.

**NOTE :** The LED indication is an additional indication of LPG quantity in tank.

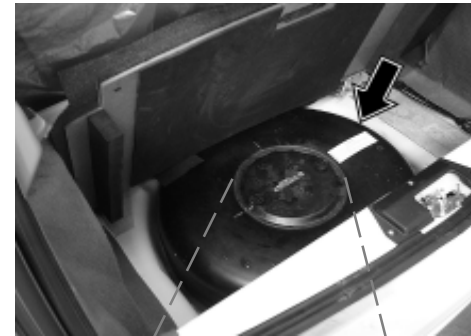

LPG Tank

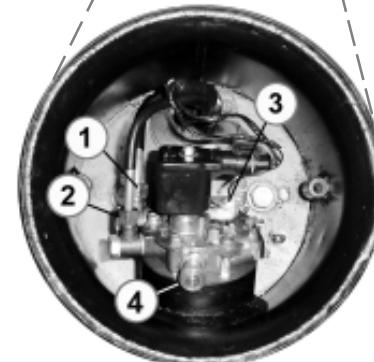

1. Inlet
2. Outlet
3. Level Indicator (Dial type)
4. Manual Shut Off Valve

## KNOW YOUR INDICA LPG

Your car's LPG tank needs to be recertified every five years as per CMVR (AIS 24, 25 and 26)

**Please ensure that it is done by a TATA Authorised Service Outlet and the new date is engraved on the plate.**



## Compliance to Motor Vehicle rules

A black rectangular form with the TATA logo at the top left. It contains a list of fields for recording vehicle and tank information, each followed by a white horizontal line for text entry. The fields are: VEHICLE CHASSIS NO., AUTO LPG TANK ID. NO., DATE OF INSTALLATION, WATER CAPACITY (LITRES), DATE OF LAST RETEST, 1st RECERTIFICATION \*, 2nd RECERTIFICATION \*, EXPIRY DATE OF TANK, and INSTALLED BY. A note at the bottom states: \* THIS INFORMATION TO BE ENGRAVED IN THE FIELD THIS INSTALLATION COMPLIES WITH SAFETY REQUIREMENTS OF AIS 026.

VEHICLE CHASSIS NO.	_____
AUTO LPG TANK ID. NO.	_____
DATE OF INSTALLATION	_____
WATER CAPACITY (LITRES)	_____
DATE OF LAST RETEST	_____
1st RECERTIFICATION *	_____
2nd RECERTIFICATION *	_____
EXPIRY DATE OF TANK	_____
* THIS INFORMATION TO BE ENGRAVED IN THE FIELD THIS INSTALLATION COMPLIES WITH SAFETY REQUIREMENTS OF AIS 026	
INSTALLED BY	_____

## KNOW YOUR INDICA LPG

## Location of LPG system components

01. LPG FILLER VALVE
02. VENT TUBE
03. COUPLING JOINT
04. HIGH PRESSURE TUBE (8mm)
05. LPG TOROIDAL TANK
06. MULTIFUNCTION VALVE
07. UNDERBODY JOINT
08. HIGH PRESSURE TUBE (6mm)
09. FILTER - LPG
10. LOW PRESSURE LINE
11. PRESSURE REGULATOR
12. HEAT SHIELD.
13. INJECTOR
14. INJECTOR LINES
15. FUEL RAIL (LPG)

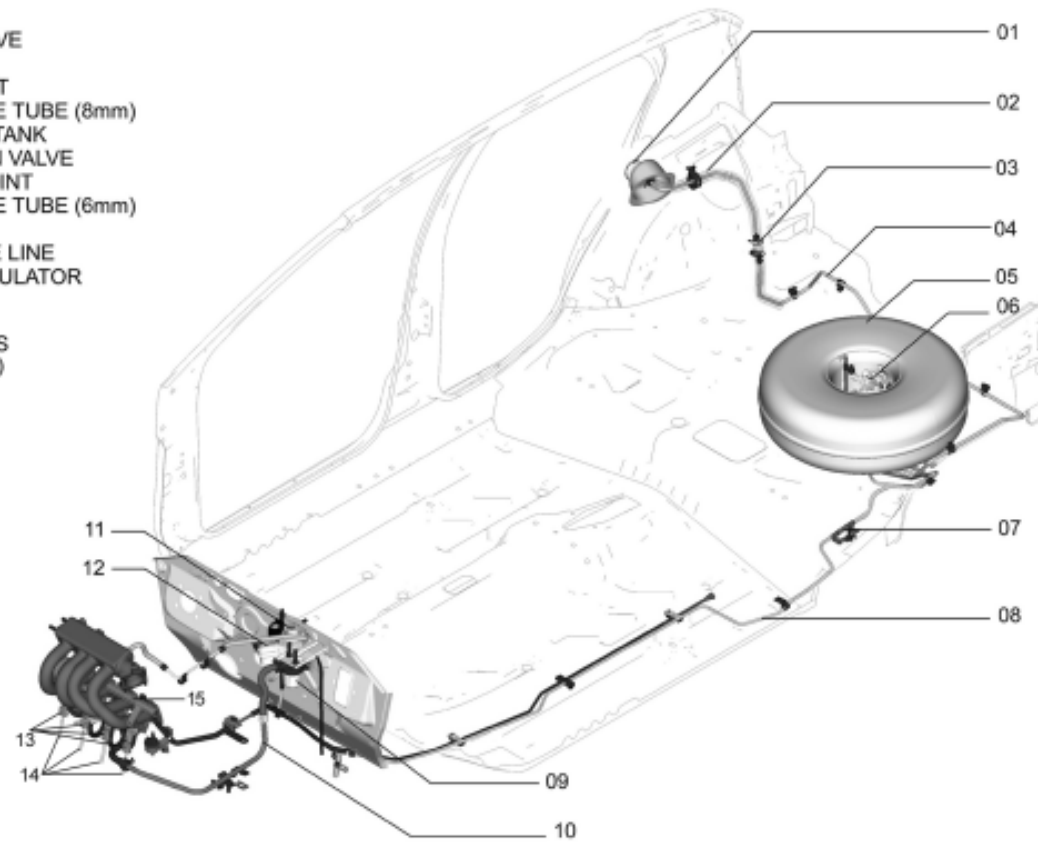





## BEFORE DRIVING

- **CONTROLS**
- **INSTRUMENT PANEL**
- **HEATING, VENTILATION & AIR CONDITIONING**
- **INTERIORS & ACCESSORIES**
  - Rear View Mirrors
  - Sunvisors
  - Glove Box
  - Window Winding
  - Power Windows
  - Tray Cover with Coin Holder
  - Plug Socket
  - Rear Ashtray
  - Digital Clock
  - Roof Mounted Interior Lights
  - Front Seat & Seat Adjustments
  - Head Rest
  - Rear Seat
  - Seat Belt Adjustment
  - Tailgate Opening
  - Fuel Flap Opening
  - Music System
  - Electrical Accessories
  - Fitment
  - Load Area Lamp
  - Front Fog Lamps
  - Head Lamp Leveling Switch

## BEFORE DRIVING

## Controls

### DRIVING CONTROLS



(\* In some versions, the power socket is located on the floor console behind gear shift lever.)

## BEFORE DRIVING

### Keys :

Your car comes with two identical keys.

With this key, you can operate

1. Door Locks
2. Steering Lock cum ignition switch
3. Tail gate Lock
4. Glove box

It is advisable to keep one of the keys in a safe place for use in case of an emergency.



Do not use a locally made key, but obtain a duplicate through your Tata Motors dealer.  
Do not leave the key inside the car.

### Door Locks :

The front doors can be locked and unlocked from outside with the key or from inside using the door lock lever. In your car, the driver's door & co-driver's door have separate locking facilities. To lock from inside turn the lever towards the inner hinged handle.

Where the central locking system is provided, if you lock/unlock the driver door with the key, the remaining three doors get locked/unlocked at a time. The tail gate door is not a part of the central locking provision.

To open the door from outside use the swing handle. After unlocking the door with the key, pull the swing handle upward. The swing handles are provided on each door.

To open the door from inside pull the hinged handle outward.

## Controls

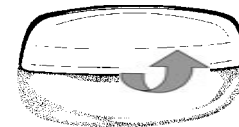
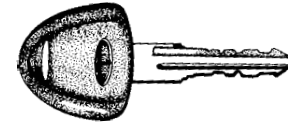

To open

Outside swing handle

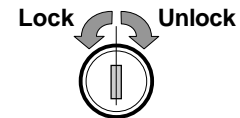

Lock      Unlock

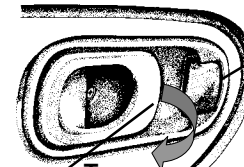

Locking /  
Unlocking  
lever

To open

Hinged handle

Inside door handle

## BEFORE DRIVING

## Controls

### IN CASE OF EMERGENCY

- 1) The electrically operated devices (like central locking, power window) may malfunction in the event of flood/fire, due to temporary or permanent damage to the device. Exercise appropriate precautions for safety of yourself and other occupants.
- 2) If the central locking system malfunctions and is unable to unlock doors electrically, the door can still be opened by manually unlocking knob '1' and opening the door using lever '2'. The mechanical system overrides the electrically operated system.

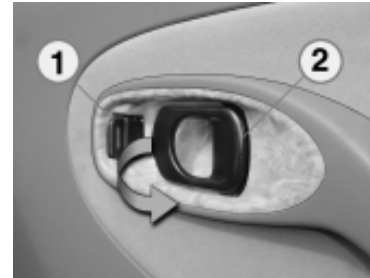

### Childproof Lock :

Both the rear doors of the car are provided with childproof locks. Push the lock lever located on the vertical face near the rear lock downward before closing the door. The door which has been locked can no longer be opened from inside.

***When child lock on rear door is 'LOCKED', the door can only be opened from outside. Use front doors to exit or take help of front occupants***

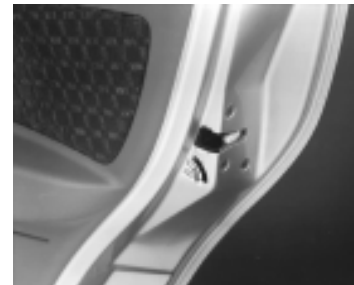

Deactivate the childproof lock when not required.

## BEFORE DRIVING

## Controls

### Steering lock cum ignition switch :

The steering column lock cum ignition switch has the following four positions and is operated with the key.

1. **LOCK POSITION** - The key can be inserted or taken out only in this position. When the key is removed from the switch, the steering is locked. To unlock the steering, insert the key and also turn it to the 'OFF' (Steering unlock) position.
2. **'OFF' POSITION** - In this position, the steering lock opens and the music system is powered.



Ignition Switch

3. **'IGN' POSITION** - This is for switching 'ON' the power supply to the following items :

- Blower & A/C (if fitted)
- Engine cooling fan
- Horn
- Power Socket
- Power window (if provided)
- Head Lamp Leveling Switch
- Head lamps
- Front fog lamps (if provided)
- Load Area Lamp
- Music system (if provided)
- Digital clock
- Engine ignition & fuel supply
- Turn signal lamps
- Wash and wiper system
- Reverse light
- Instruments and gauges and tell tale warning lamps
- Audio warning unit
- Fog Lamps

4. **'START' POSITION** - In this position, which is momentary, the switch cranks the engine. When the switch is in this position momentarily, the devices listed under "Accessories supply" above, are switched 'OFF'.

## BEFORE DRIVING

## Controls

**The following items are operated/powered without the key in the ignition switch :**

Hazard warning system, Stop lamps, Position lamps, Registration plate lamps, Illumination of A.C. control panel, Odometer display (LCD) of Instrument Panel, Roof lamp, Reading lamps, Engine lamp, Load Area Lamp, Central door locking, Audio warning unit, Memory of digital clock and Music System, Rear Windshield Demister.

The switch symbol lamps may come 'ON' without the key in the 'IGN' position on ignition switch.

**Note :** When the key is returned from 'OFF' position to LOCK position, the music system continues to be powered until the key is removed from the switch. This also helps to remind the driver if the key is inadvertently left in the vehicle when alighting from the vehicle, where this is provided.

-  I) Do not remove the key, while the car is in motion, as the steering will get locked and the car cannot be steered.
- II) While turning the key from 'LOCK' position to 'OFF' position slightly rotate steering wheel to relieve pressure on steering spindle for easy operation of the key. Also ensure the key is inserted fully before turning the key.
- iii) Do not operate to START position when the engine is running. This may damage the ring gear of the starter motor.

Combi-switch

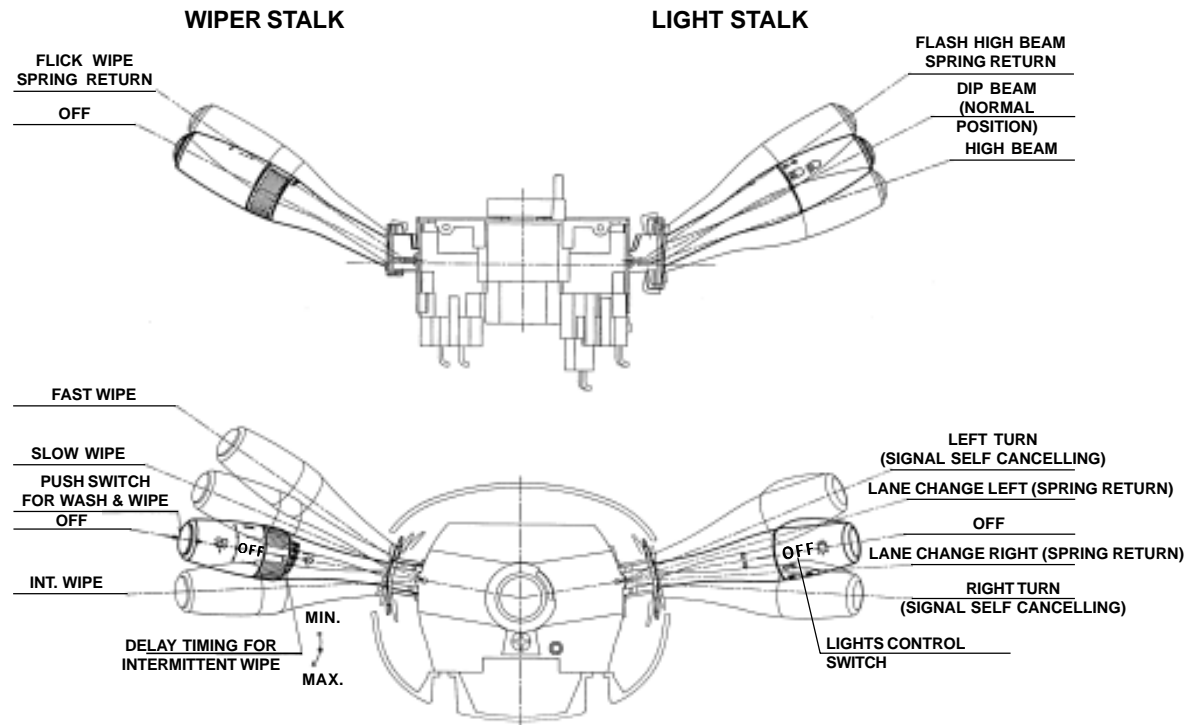

## BEFORE DRIVING

## Controls

### WIPER CONTROL COMBI-SWITCH LEVER - LEFT

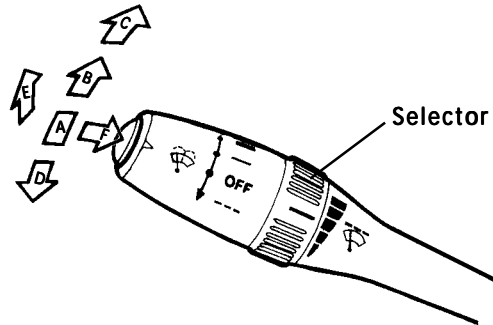

#### Wiper Control Combi-switch Lever - Left

- A. Wiper 'OFF' position
- B. Slow Wipe
- C. Fast Wipe
- D. Intermittent wipe \*
- E. Pull up for windshield wipe (Flick Wipe Spring Return)
- F. Press side knob for wash

\* Rotate selector to set delay timing for intermittent wipe

### LIGHTS CONTROL COMBI-SWITCH LEVER - RIGHT

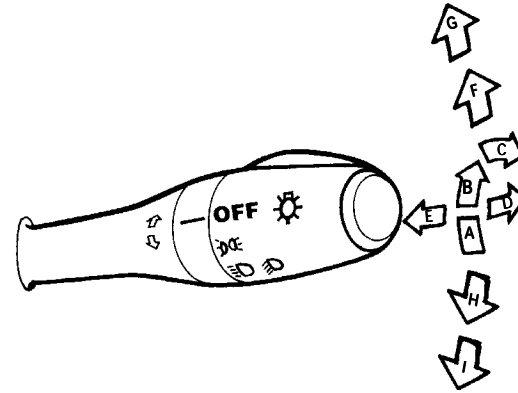

#### Lights Control Combi-switch Lever - Right

- A. Head lamp 'OFF' position
- B. Position lamp 'ON'
- C. Position lamp & head lamp 'ON'
- D. Push down the lever for high beam
- E. Pull up the lever (spring return) for high beam flash
- F. Lane change left (spring return)
- G. Side Indicator - LH
- H. Lane change right (spring return)
- I. Side Indicator - RH



## BEFORE DRIVING

## Controls

### Fog lamps : (if fitted)

Front and Rear fog lamps can be switched ON/OFF by operating the switch on the Combi-Switch.

**Front fog lamp :** Rotate the switch clockwise to switch 'ON' the front fog lamp. Front fog lamps are operative only when the position lamps are switched 'ON'. Rotate the switch to same direction to switch 'OFF' the front fog lamp.

The indicator on the instrument cluster comes 'ON' when the front fog lamps are switched 'ON'.

**Rear fog lamp :** Rotate the switch anticlockwise to switch 'ON' the rear fog lamp. Rear fog lamps are operative only when the head lights are switched 'ON' or front fog lamps are switched 'ON'. Rotate the switch to same direction to switch 'OFF' the rear fog lamp.

The indicator on the instrument cluster comes 'ON' when the rear fog lamps are switched 'ON'.

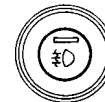
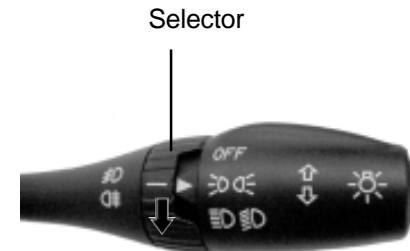
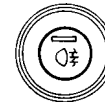

## BEFORE DRIVING

### Accessory Switches : (if installed)

Accessory switches have been provided on the dash board near the steering column on the right hand side.

#### 1. Rear windshield demister (unlatched switch)

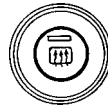

The switch is pushed and released to switch 'ON' and the knob returns to the normal position. The function indicator lights up in amber indicating that the demister heater is 'ON'. The function is controlled through a timer and operates for 15 minutes (approximately) and goes 'OFF' automatically at the end of the duration. The heater can be switched 'OFF' anytime by once again pushing and releasing the switch knob.

**Note :** Switching 'ON' and 'OFF' can be done only with key in 'IGN' position. The demister heater remains 'ON' even after removal of ignition switch key and goes 'OFF' at the end of 15 minutes period, In case you are missed to switched 'OFF'.

#### 2. Rear windshield wiper (latched switch)

Push to switch 'ON' - Push to switch 'OFF'

The function indicator on the knob lights up in green when the wiper function is 'ON'.



## Controls

#### 3. Rear windshield wash & wipe (unlatched switch):

Push and hold the switch knob for the operation of the wash function on the rear windshield glass for rear visibility through glass. The function indicator lights up in green when wash function in 'ON'. Along with the wash fluid getting sprayed, the wiper also operate with a delay to wipe the glass surface, through timer control unit.



Accessory Switches

## BEFORE DRIVING

## Controls

### Gearshift lever & Shifting pattern :

The gearshift lever is mounted on the central console between the two front seats. The gearshift pattern is shown on the gear lever knob.



The reverse gear should be engaged only when the car is stationary. Wait for 5 seconds after declutching to ensure smooth engagement of the reverse gear.

### Parking brake :

A mechanical parking brake acting only on the rear wheel is provided on your car. The parking brake lever is located behind the gearshift lever. To apply the parking brake, pull the lever up fully . The indicator light (P) on the instrument panel will come 'ON'. To release it, **pull the lever up slightly**, press the release button and push the lever down.

The parking brake indicator (P) on the instrument panel will go 'OFF' when the parking brake lever is fully released.

When parking on level ground, place the gear lever in the 'Neutral' position. When parking on a downhill gradient, place the gear lever in 'Reverse' position. When parking on uphill gradient, place the gear lever in the '1st' position



Apply the parking brake properly before leaving the car & release it before moving. Use the parking brake for holding the car on a gradient.

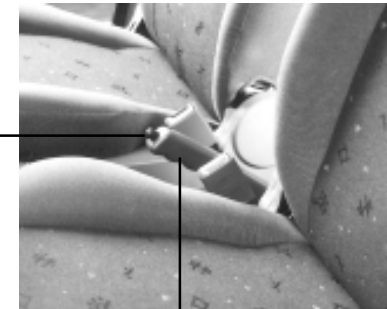
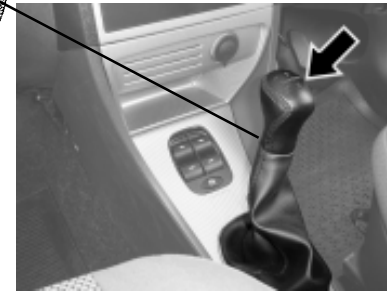
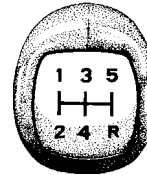

Release Button

Parking Brake Lever

**INSTRUMENT PANEL**

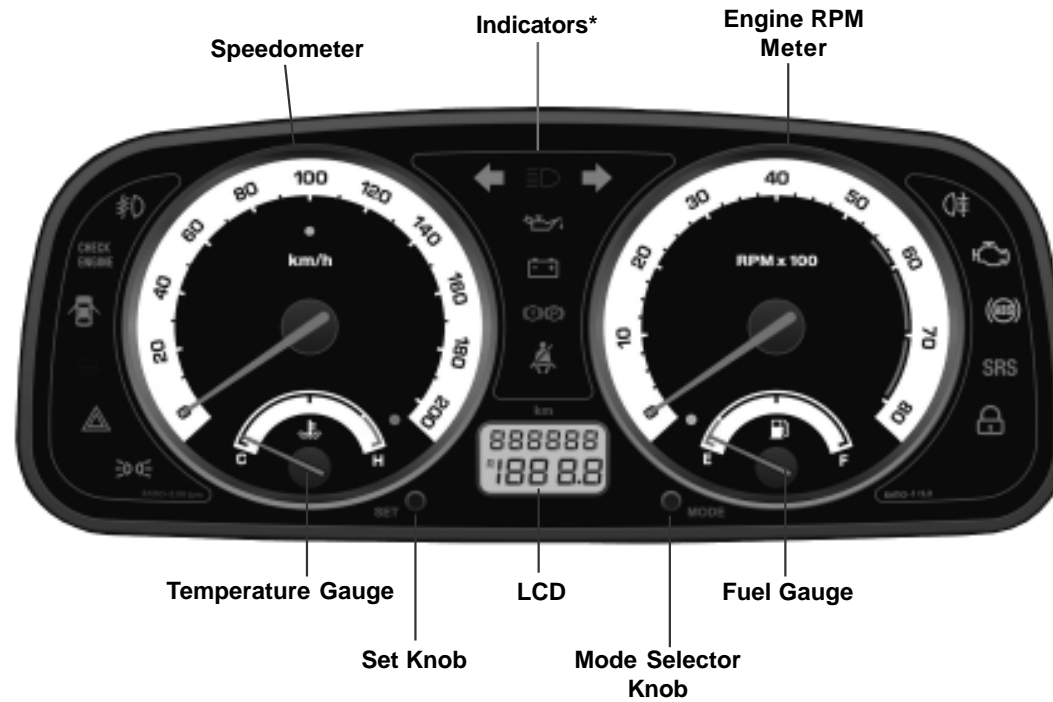

## BEFORE DRIVING

## Instrument Panel

### Turn Signal and Hazard Warning

#### I) Turn Signal :

Turn signal lamps can be operated only when the ignition supply is 'ON' by using the turn indicator switch on the combiswitch.

The direction indicator ◀ (LHS) and ▶ (RHS) on the instrument cluster flashes along with external indicator lights as selected.

#### II) Hazard Warning :

This can be operated without ignition 'ON'. Press the hazard warning switch (red knob) on the centre of the dash board, all side indicator lights and indicator ▲, LHS and RHS turn indicators on the instrument cluster will flash simultaneously to warn the other road users about any hazardous condition of the car. Depress the knob again to switch 'OFF' the hazard function.

**Note :** If light does not blink or blinks rapidly, it is an indication of fault in the blinker electrical system or the indicator bulb at front or rear has fused. Get it rectified immediately.



Hazard Warning Switch

## BEFORE DRIVING

## Indicators

### Parking Brake Indicator cum Low Brake Fluid Warning Light

When the ignition key is turned to the 'IGN' position, the symbols light up for the following :

- i) when the parking brake is applied, and/or
- ii) when the brake fluid level in the container is low.

Else the indication goes 'OFF' after few seconds.

If the lamp glows while engine is running, then check the parking brake or brake fluid oil level.

 Do not drive the car if this indicator remains 'ON'. Get the problem attended to immediately at an Authorised Service outlet.

### High Beam Indicator :

Symbol lights up when the headlamp high beam is 'ON'.

### Engine Check Indicator :

This lamp indicates engine condition. When a malfunctioning occurs in Engine or EMS, this lamp indicates as below :

1. Remains "OFF" in "IGN" position.  
OR
2. Remains "ON" in running position.



## BEFORE DRIVING

## Indicators

### Position Lamp Indicator :

Symbol lights up when the position lamps are switched 'ON'. Illumination lamps for AC, HVAC or ventilation panel and switch illumination lamps comes 'ON', when the position lamps are 'ON'. Position lamps can be used as parking lamps. Instrument cluster illumination turns 'ON' with key in 'IGN' position and position lamps 'ON'.

**Note :** Position lamps also remain 'ON' while head lamps are 'ON' and in this condition instrument cluster illumination lamp will not be 'ON'.

### Low Oil Pressure Indicator :

When the ignition key is turned to the 'IGN' position, symbol lights up and goes off as soon as the required engine oil pressure is developed after starting the engine.



If the low oil pressure indicator does not glow or remains 'ON' with the 'IGN' on and engine is running, it indicates a fault in the electrical circuit/lubrication system. Check & get the problem attended to at an Authorised Service outlet.



## BEFORE DRIVING

## Indicators

### Battery Charging Indicator :

Symbol lights up when the 'IGN' is turned 'ON' and should go 'OFF' after the engine starts.



If it remains 'ON' while the engine is running, it indicates that the battery is not being charged. Switch off all unnecessary electrical equipment and get the problem attended to at an Authorised Service outlet.



### Front Fog Lamp Indicator (if provided) :

This symbol lights up when the front fog lamps are switched 'ON'



### Rear Fog Lamp Indicator (if provided) :

This symbol lights up when the rear fog lamps are switched 'ON'





## BEFORE DRIVING

### Speedometer, Main Odometer and Tripmeter (on LCD) :

The speedometer indicates the car speed in km/hr. The odometer records the total distance the car has been driven. The tripmeter can be used to measure the distance travelled on each trip or between fuel fillings.

 Keep track of the odometer reading & follow the maintenance schedule regularly for meeting service requirements.

### Odometer, Tripmeter and Illumination intensity control on instrument panel (LCD) :

The instrument panel has an LCD to display the following :

- Main Odometer (Non- resettable) - Counts upto 999999 kms
- Tripmeter A (Resettable) - Counts upto 1999.9 kms
- Tripmeter B (Resettable) - Counts upto 1999.9 kms

Intensity level of instrument panel illumination - selection among preset levels.

LCD has two line display. The first line displays the Odometer count. The second line displays either of Tripmeter A, Tripmeter B, Intensity level of panel illumination.

The selection and control of functions are done through 'MODE' and 'SET' push buttons (knobs) provided on either side of the LCD.

The 'MODE' knob is used to select one of Tripmeter A, Tripmeter B or Intensity level of panel illumination. Switching among the above three functions can be done by pressing the knob.

## Gauges

### Over speed warning indicator



Speedometer



Display for Trip - A

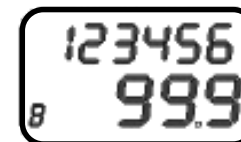

Display for Trip - B

## BEFORE DRIVING

The 'SET' knob is used to control the chosen function. Pressing the knob for a few seconds resets the chosen tripmeter and varies the intensity level of instrument panel illumination.

The panel illumination intensity varies among preset levels as follows :

=           Min  
= = = =   Max

This display returns to Trip A after a few seconds of intensity level selection, if left in this mode.

### NOTICE

Main odometer and tripmeter A indication will remain on display even if the ignition key is removed.

Reduced contrast in display may occur at low and high temperature.

### Over speed warning indicator (if provided) :

When the vehicle speed reaches more than 120 kmph, over speed warning indicator will come 'ON'.

## Gauges

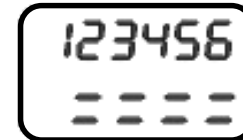

Intensity Level Indicator

### Over Speed Warning Indicator



## BEFORE DRIVING

### RPM meter :

The meter indicates engine speed in revolutions per minute (rpm)  
Change gears at appropriate engine rpm and car speed to get optimum fuel economy.

The permitted engine rpm upper limit is the start of Red Zone on the dial.

If RPM meter does not indicate during initial cold starting, gently raise the engine rpm till the battery charge lamp goes 'OFF'.

### Temperature gauge :

The gauges indicates the temperature level of the engine coolant. The red zone at 'H' indicates temperatures higher than normal. A visual warning indication (Red coloured) comes 'ON' indicating that when the coolant temperature is higher than normal.

Avoid driving, when the pointer is in the red zone. It indicates engine overheating, which may be due to insufficient coolant in the radiator or due to any other defect. Take the car to the nearest Authorised Service outlet for necessary attention.



Never remove the cap from the coolant reservoir when the engine is hot. Do not restart the engine until the problem has been duly attended.

## Gauges



RPM Meter



Temperature Gauge High Temperature Warning

## BEFORE DRIVING

### Fuel Gauge :

The fuel gauge indicates the approximate fuel level in the tank. Refill the fuel tank at the earliest, when the needle touches the red band (indicating reserve capacity has been reached.), a visual warning indication (Amber coloured) comes 'ON' indicating the fuel level is low.

### Audio Warning Unit

#### Seat Belt Reminder (Beeper) : (If installed)

When the key is in the 'IGN' position and the driver's seat belt has not been fastened, an audio warning comes 'ON'. Please fasten the seat belt. The warning goes 'OFF' automatically after a few seconds, even if the seat belt is not fastened.

#### 'Key in' Warning Beeper : (if installed)

When the ignition is turned to 'OFF' position and the key is not removed from the switch, an audio beep comes on if driver door is open. The beeper will go 'OFF' after a few seconds automatically if warning is ignored or if the key is removed/door is closed.

## Audio Warning

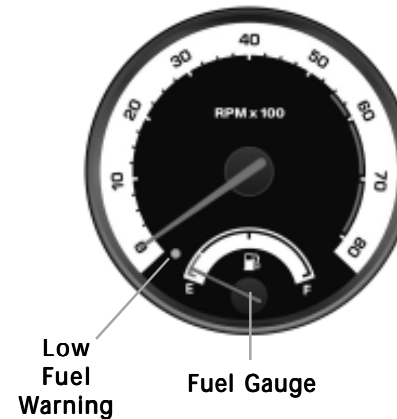

## **BEFORE DRIVING**

### **Lamps 'ON' Reminder (if installed)**

An audio warning (beeper) is provided to inform the driver that the headlamps/position lamps are left 'ON'. This comes 'ON' when the driver removes the key and opens the door. Switch 'OFF' the lamps, before leaving the car. However the lamps can be kept 'ON' ignoring the warning, if desired.

### **Tail Lamp : The tail lamp assembly incorporates the following-**

1. Stop cum position lamp
2. Turn Indicator
3. Reverse Lamp
4. Fog lamp (provided in Deluxe version only)
5. Reflex reflector

### **Registration Plate Lamps :**

Two concealed lamps are provided for illumination of the rear registration number plate.

### **High Mounted Stop Lamp :**

High mounted stop lamp is provided at the rear of vehicle and it glows whenever the service brake is applied.

## **Audio Warning / Tail Lamps**



**High Mounted Stop Lamp**

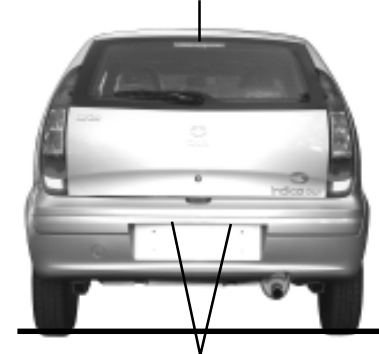

**Registration Plate Lamps**

**Air Flow Pattern**

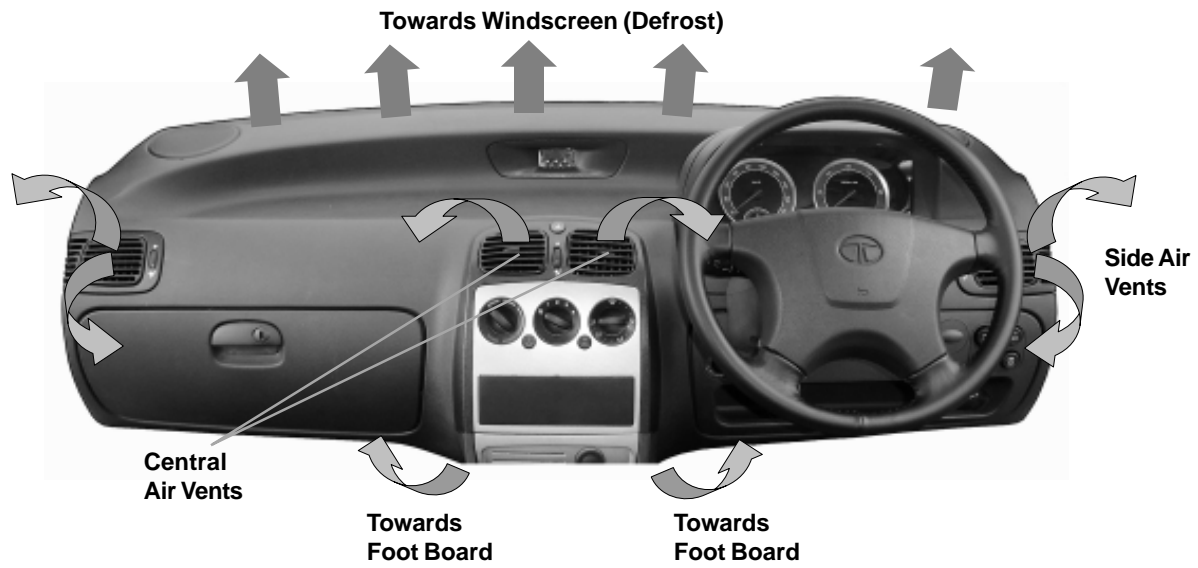

## BEFORE DRIVING

## Heating, Ventilation & Air Conditioning

### HEATING, VENTILATION & AIR CONDITIONING (if installed)

#### A. Temperature Control Knob :

The air temperature in the car can be controlled by operating the temperature control knob **(A)** at the left hand side of the control panel. The temperature can be increased by rotating the knob towards the red segment and decreased by rotating it towards the blue segment.

#### B. Blower Speed Regulation Knob :

The ventilation system has a three/four speed blower. The blower speeds can be regulated to any one of the following speeds by operating the knob **(B)** at the centre of the control panel.

**LOW • MEDIUM • HIGH • VERY HIGH**

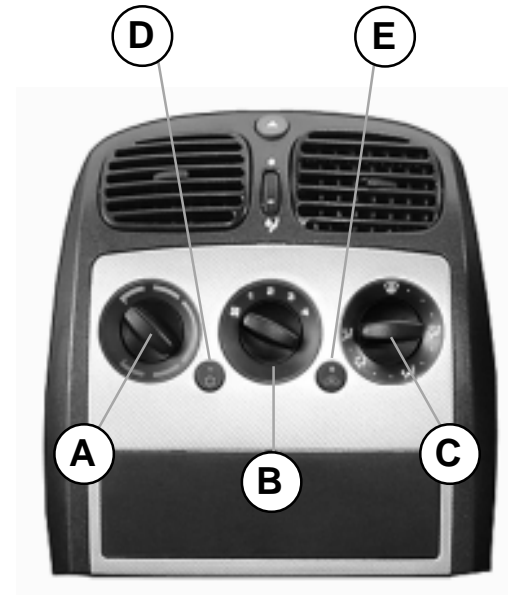



HVAC CONTROLS

## BEFORE DRIVING

### C. Air Direction Control Knob :

The air flow can be changed by turning the switch (C) to the desired direction.

→  Towards face

↘  Towards face and feet

↓  Towards feet

 Towards feet and windshield  
(Recommended for clearing fogging on windshield)

 Air demist / defrost windshield  
(Recommended for clearing heavy fog and snow)

### D. A.C. ON/OFF Switch :

The A.C. can be switched 'ON' by pressing the switch (D) on the A.C. control panel provided the blower is 'ON' and the engine is running. The indicator lamp will show that the A.C. is 'ON'.

## Heating, Ventilation & Air Conditioning

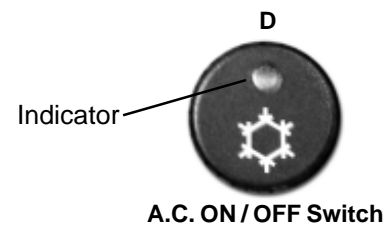
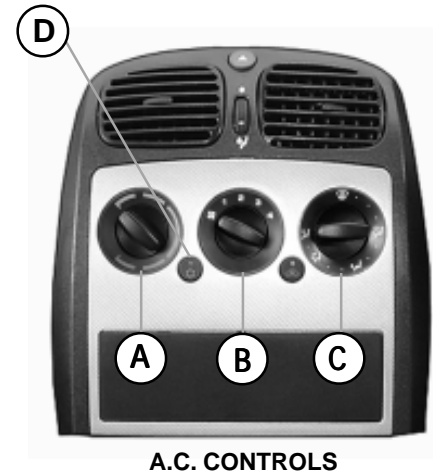



## BEFORE DRIVING

### E. Air Circulation Switch :

- In HVAC version to put air circulation mode in recirculation, press switch 'E'. The indicator lamp will show air circulation is in recirculation.  
To put vehicle in Fresh mode release switch 'E'. Indicator lamp will be 'OFF'.
- In A.C. version, air circulation mode can be selected by rotating knob 'E'.

Fresh  Recirculation 

- In recirculation mode, air inside the vehicle is circulated again and again. In Fresh mode, air is taken from atmosphere and circulated in the vehicle.  
Recirculation mode can be used
  - While driving in dusty condition
  - To avoid traffic pollution
  - To get quick cooling/heating as required.

Whenever discomfort is felt switch air circulation mode to fresh.

**Notice :** The A.C. can be switched 'ON' only if the blower is 'ON' and engine is running. When A.C. is switched 'ON' engine idling RPM increases marginally, to adjust to the A.C. compressor load. When desired temperature is achieved A.C. trips 'OFF' automatically.

## Heating, Ventilation & Air Conditioning

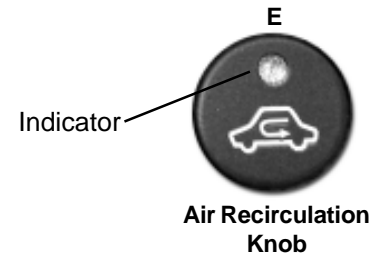

**Notice :** The A.C. compressor gets switched 'OFF' automatically when engine gets overheated. The A.C. is automatically switched 'ON' when the engine cools down.

### Normal Cooling :

A.C. - ON

Knob 'B' - Desired speed position

Knob 'C' - Towards face 

Switch 'E' - Suitably as explained

### Quick Cooling :

If your car is left in the sun with window closed inside temperature increases.

## BEFORE DRIVING

To achieve quick cooling effect, open the windows briefly while you operate the air conditioner, with air circulation switch is in Fresh mode, fan at higher speed and air direction towards 'FACE'. All vents to be opened completely.

Once temperature inside has come down sufficiently, close the windows and change air circulation suitably to fresh/recirculation.

### Demisting :

In rainy season or in areas of high humidity, mist formation inside windshield glass is observed. To clear mist dehumidified air is passed on the windshield glass.

The position of control knobs should be adjusted as follows:

A.C. - ON

Knob 'B' - Desired speed position

Knob 'C' - Towards windshield 

Knob 'A' (for vehicles fitted with HVAC) - at suitable temperature

Air circulation - at suitable position

**Notice :** When mist gets cleared switch the knob "C" position to Face mode.

In high humidity areas, if cold air continues to flow over windshield, it may cause sudden fogging on outside surface of windshield.

## Heating, Ventilation & Air Conditioning

### Defrosting :

(For vehicles fitted with HVAC unit)

In low temperature areas, to clear frost formation outside the windshield glass, this setting is used.

First start the engine and accelerate to warm up.

Knob 'A' - Maximum hot position

Knob 'B' - Very High

Knob 'C' - Towards windshield 

Switch 'E' - Fresh air mode condition

Once the windscreen has become clear, move the fan switch to desired speed.

**Notice :** Electric heater coil is provided for demisting of tail gate glass for deluxe versions.

### Normal Heating :

( For vehicles fitted with HVAC )

Knob 'A' - Suitable temperature position

Knob 'B' - Suitable blower speed

Knob 'C' - Towards face & feet 

A.C. - OFF

Air Circulation- Fresh switch

## BEFORE DRIVING

### Quick Heating :

All settings as explained before except air circulation switch to recirculation.

Once vehicle is heated, switch back to fresh mode.

### Ventilator :

The air flow can be adjusted continuously with the rotary control knob at the vents on the dash board. The air vents can be adjusted upward and downward. This is common for HVAC, AC and ventilation.

**Notice :** Refrigerant charged in the air conditioning circuit has been identified on the label over front body member. Use only refrigerant as given in the label for topping up or recharge, i.e. do not charge R12 (CFC) in the vehicle earlier charged with R134a (Non CFC) or vice versa.

**Notice :** Fresh air is taken from the grill opening provided at base of windshield glass outside the vehicle. Keep these openings clear and free from fallen leaves etc.

## Heating, Ventilation & Air Conditioning



## BEFORE DRIVING

### REAR VIEW MIRRORS

**Door mirrors :** Driver side only (alternate) Both sides (if fitted)

The rear view mirror is fitted on the door from the outside and can be adjusted by the lever provided inside the door. In some versions the mirrors are provided on both the doors.

#### Inner Rear View Mirror :

Plain mirror (Alternate)

Antiglare mirror (if fitted)

If an antiglare mirror has been fitted inside the cab. Provision has been made for two positions :

1. Normal position
2. Antiglare position

Use antiglare position only when necessary, as it reduces rear view clarity.

#### Normal Mirror (if fitted)

In some versions, a normal mirror has been fitted inside the cab.

#### Sunvisors :

Two adjustable sunvisors are provided inside the cab above the windshield to prevent sun glare.

Lower the sunvisors to protect the eyes from bright sunlight. The sunvisor also moves sideways towards the door.

A vanity mirror has been provided on the back of the co-driver's sunvisor.

## Interiors and Accessories



**ANTIGLARE MIRROR**  
(Only on deluxe version)

**Operating Knob**

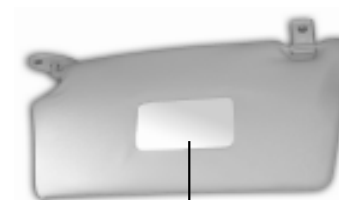

**Vanity Mirror**

## BEFORE DRIVING

 When not in use keep the sunvisors in their stowed position otherwise they may block the driver's vision.

### Glove Box :

The glove box is located on the dash board in front of the co-driver's seat. The glove box can be locked with the ignition key.

Cup holders are provided on the inner face of glove box flap.

 Do not use the cup holder while the car is in motion.

### Window Winding :

#### Manually Operated Window Winding :

Window winding in the standard version is manually operated. Rotate the handle on the door pad to raise or lower the window glass.

## Interiors and Accessories

Cup Holders

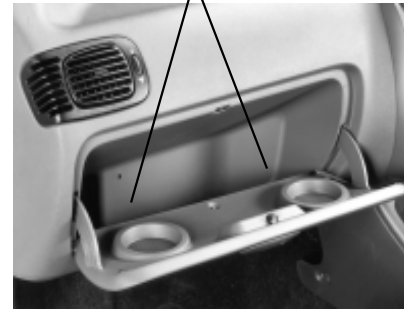

Glove Box



Window Winding Lever

## BEFORE DRIVING

### Power Windows : (if installed)

Four separate knobs are provided on the switch to operate the four door window glasses individually and electrically.

To open the door window glass, push the respective knob down.

To close the door window glass, pull the respective knob up.

In the locked position, the rear window switches on rear doors become inoperative. However the rear windows can be operated by the switches on the floor console. Illumination on rear window switches goes 'OFF' in locked position. Press down the lock button to unlock.

Individual window winding switches have been provided only on the rear doors.

 While raising the glass take care to avoid fingers/hands getting trapped between the glass and the frame.

## Interiors and Accessories

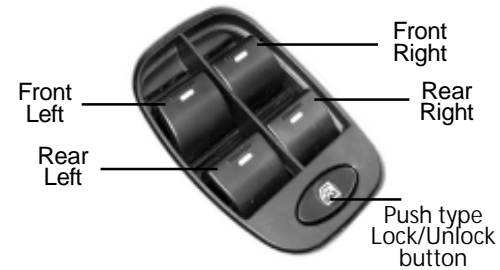

**Window Winding Switch  
On floor Console**



**Window Winding Switch On Rear Door**

## BEFORE DRIVING

### **Power Socket :** (if provided)

Power socket is provided on the floor console behind the gear shift lever (for standard versions). A Plug socket is provided on central fascia (for Deluxe versions). This can be used for connecting loads upto 10A maximum like the mobile charger, cigarette lighter etc. To use this socket, remove the cap first.



Always keep this socket covered with the cap when not in use.

## Interiors and Accessories



**Power Socket (Deluxe version)**

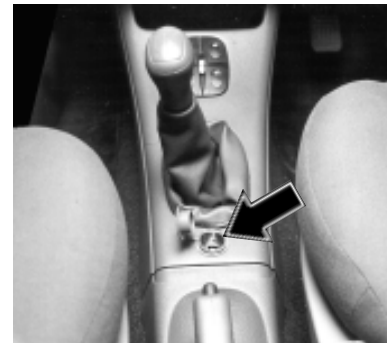

**Power Socket (Standard version)**

## BEFORE DRIVING

### Rear Ash Tray : (if fitted)

Ash trays are provided on both rear doors for the occupants at the rear.

To open the rear ash tray press the lid, it will rotate outward.

To remove the ashtray open fully and press down to disengage the top pivot pin.

To refit the ashtray, locate the bottom pivot pin and push the top pivot pin in to place.



Do not forget to extinguish the cigarette butts, before putting them in the ash tray.  
Do not put paper or other flammable material in the ash trays.

### Digital Clock :

A digital clock is provided in the middle of the dash board. It displays the time when the steering lock cum ignition switch is in 'IGN' position.

Three push knobs 'H', 'M' and 'Z' are provided for setting the time and for resetting the display to zero - 'H' for hours setting, 'M' for minute setting and 'Z' for setting minutes to zero.

## Interiors and Accessories





## BEFORE DRIVING

### Roof Mounted Interior Light & Reading Lamps :

Interior roof light and reading lamps with inbuilt switches are provided on the roof near the rear view mirror.

The central rectangular toggle switch (1) has three positions :

- When the central rectangular toggle switch is in the MIDDLE position, the light will come 'ON' only when any of the doors are opened.
- When this switch is in the RIGHT position, the light will remain 'OFF' in all conditions.
- When this switch is in the LEFT position, the light will be continuously 'ON' irrespective of whether any of the doors are open.

Two more triangular push type switches (2) are provided to operate the individual reading lamps.

## Interiors and Accessories

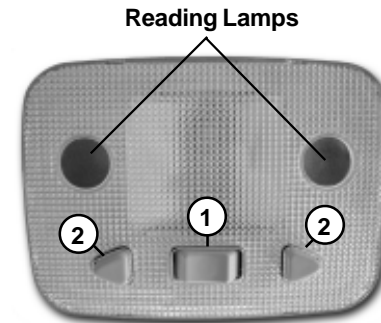

Roof Mounted Interior Lamp and Reading Lamps

## BEFORE DRIVING

### Front Seats and Seat Adjustments :

**Front Seats :** Both the driver and co-driver seats are of bucket type to provide maximum riding comfort.

### Moving the seats forward and backward :

To adjust the seat position, lift the lever under the seat cushion front, then move the seat to the desired position and release the lever.

Make sure the seat is locked in position.

### Adjusting the angle of the seat back :

To adjust the angle of the seat back, a lever has been provided on the sides of the front seats. By lifting the lever, you can adjust the angle of the backrest.



Do not adjust the seat when the car is in motion.

Always adjust the seat back to an upright position and sit well back in the seat.

## Interiors and Accessories



**Front Seat Adjustment Levers**

1. Lever for backward & forward movement
2. Lever for Seat Backrest angle

## BEFORE DRIVING

**Head-rest :** (Adjustable on the front seat & fixed on the rear seat)

Head-rests are designed to help reduce the risk of neck injuries in case of accidents. For best protection, adjust the top of the headrest, so that it is in level with one's ears. To adjust the head-rest pull / push it to the desired position until it clicks. The head-rest can be adjusted up to 64 mm in steps of 16 mm.

If headrest is required to be removed (for cleaning fabric etc.) pull the headrest fully up, then push notch button with a thin punch while pulling the headrest up. To install proceed in reverse.



Avoid driving the car with the head-rest removed as it is a safety item. Do not attempt to adjust the head-rest while driving the car.

**Rear Seat : (Split 60 : 40)**

A cushion bench 60 : 40 split seat has been provided for the rear passengers. Any one of the split seat back can be folded by releasing the latch, on both the 'C' pillars simultaneously. For making more luggage space, the folded rear seat can be somersaulted further. Before summersaulting ensure that the front seats are at 3/4 the full travel towards rear.

For fixing the seat back upright, just push back the seat in position. It will get locked by itself.

## Interiors and Accessories

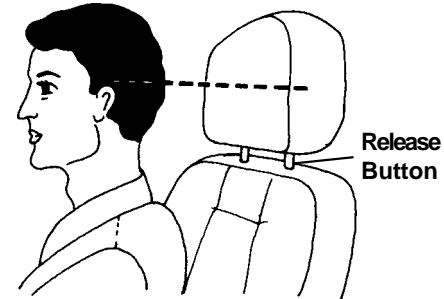

Seat Release Latch on 'C' pillar



**BEFORE DRIVING**

**Interiors and Accessories**

**SOMERSAULTED POSITION**

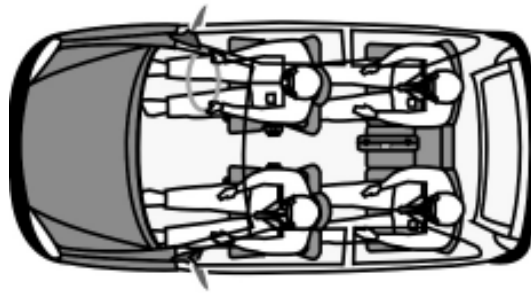

**Luggage space before somersault operation**

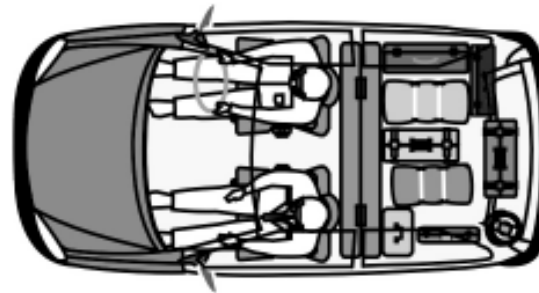

**Luggage space after somersault operation**

## BEFORE DRIVING

### Seat Belt

Seat belts have been provided on the front seats (with micro switch on driver's side for the deluxe model)



Always wear seat belts, while driving.

### Seat belt adjustment :

1. Pull the tongue across your body and insert it into the buckle.
2. Check and ensure that the belt is not twisted.
3. Position the lap portion of the belt as low as possible across your hip bone.
4. Pull up the shoulder part of the belt to remove the slack.
5. Make sure that the belt goes over your collar bone and across the chest.
6. To unlatch the belt, press the red button on the buckle. Guide the belt to the pillar as it retracts.
7. Each belt should be used by one occupant only (such as front LH/RH, Rear outboard passenger LH/RH & Rear lap belt-location as per sketch). The belt must not be put round a child, seated on passenger's lap.
8. When the belt has been use in a serious accident or shows signs of severe fraying or of having been cut, replace the belt kit.
9. The belt must not be altered or modified during use.
10. The belts are meant (intended) for adult occupants only.

## Interiors and Accessories

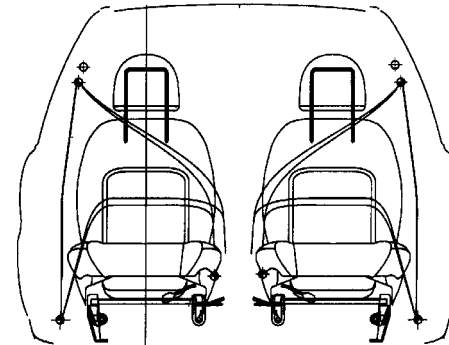

Front seat seat-belts arrangement

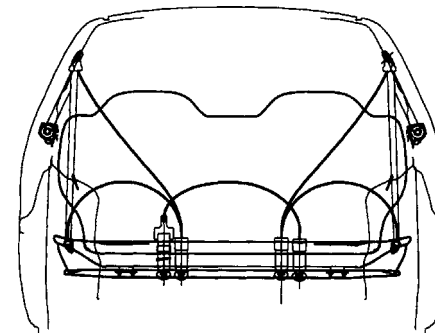

Rear seat seat-belts arrangement  
viewed from rear

## BEFORE DRIVING

11. The belts if required should be repaired, by authorised personnel only.
12. The belts should not be disassembled, if required, authorised personnel only should carry out disassembly and assembly.

 Do not wear your seat belt over hard or breakable objects in pockets or on your clothing. If an accident occurs, objects such as glasses, pens, etc. under the seat belt can cause injury.

### Tailgate opening :

A tailgate opening lever is provided on the floor between the driver's seat and door.

Pull the lever up to unlock the tailgate.

Lift the tail gate by hand using the recess in the centre, near the bumper. The two telescopic balancers will open the door automatically.

To close and lock the tailgate push it down.

The tailgate can also be opened with the key.

While tailgate opening the parcel shelf also gets lifted up by the lifting cords and parcel shelf closes back while closing the tailgate.

 Ensure proper closing of parcel shelf while closing the tailgate.

## Interiors and Accessories

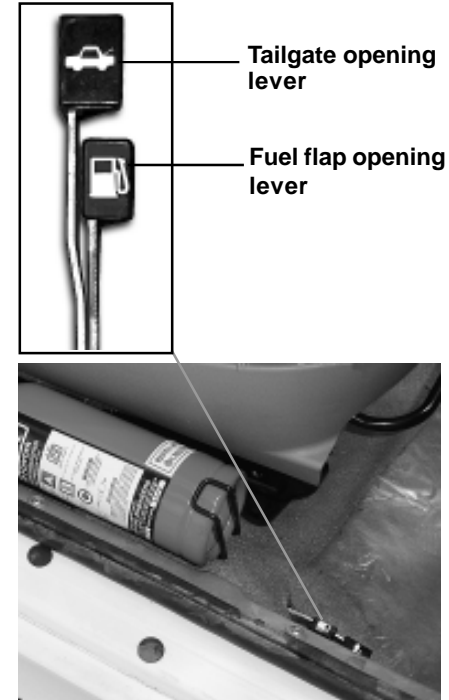

## BEFORE DRIVING

### Fuel flap opening :

The fuel flap is located on the left rear side of the car. The fuel flap can be opened by pulling the opening lever located near the tailgate opening lever and can be locked by simply closing the flap.

### Music System :

A provision has been made for fitment of music system.

An internal antenna comes fitted on the front windshield glass on the inner side near the rear view mirror. Provision for the installation of speakers is made on the dash board on both the sides and on each of the front doors.

If the music system is originally provided in your vehicle, please refer manufacturer's manual for operation of the music system.

### Electrical Accessory fitment :

Provision has been made in your car wiring to fit the following electrical accessories :

1. Engine Compartment Lamp
2. Front Fog lamp
3. Additional Horn (on LH side)
4. Reversing buzzer
5. Music System
6. Speakers
7. Immobilizer for vehicle security

For details of fitment please contact our nearest authorised service outlet.

## Interiors and Accessories



Antenna



Provision for Music System

## BEFORE DRIVING

### Load Area Lamp (if installed)

A lamp is fitted in the luggage compartment to illuminate the luggage area, when required. To operate this lamp, a simple ON/OFF switch is provided along with this lamp. For the lamp to come 'ON' with the opening of tailgate, the switch should be in 'ON' position.

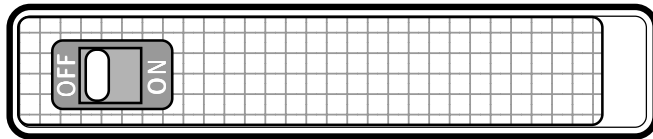

Load Area Lamp

### Front Fog Lamps (if installed)

The Front fog lamps are provided with halogen lamps of H11 type to provide adequate light in the vehicle front. This enables to drive the vehicle during rains, fog, etc.



Fog Lamp

## Interiors and Accessories



## BEFORE DRIVING

### Headlamp leveling switch (if installed) :

A motorised headlamp leveling arrangement with the setting knob at the dash board is provided on the LH side of steering column. As and when required, head lamp leveling, setting is done by rotating the knob to select one of the 3 levels marked in the switch depending upon the loading of the vehicle.

Sl. No.	Loading condition	Sw. position/ Marks assigned*
1	One person in Driver seat	0
2	Driver + One passenger in front	1
3	Driver + One passenger in front + All the seats at rear occupied	2
4	All the seats occupied	2
5	All the seats at rear occupied + Luggage in boot space to achieve permissible load on the rear axle**	3
6	Driver + Luggage in boot space to achieve permissible load on the corresponding axle**	3

\* Switch position / Marks assigned is for highest ULW.

\*\* If the maximum permissible laden mass is obtained before the permissible load on the axle, the loading of the boot shall be limited to the figure, which enables that mass to be reached.

## Interiors and Accessories

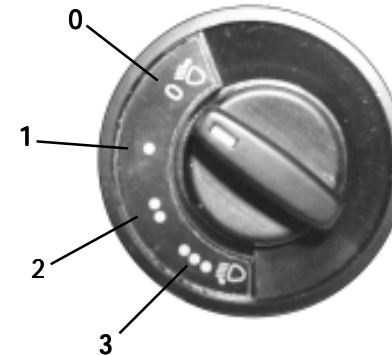
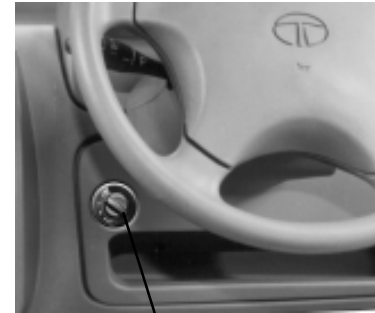





## STARTING AND DRIVING THE CAR

### ■ STARTING & DRIVING

- Opening & closing the bonnet
- Check list
- Fuel level
- Engine oil level
- Engine coolant level
- Brake fluid level

### ■ STARTING & STOPPING

- Starting the engine
- Stopping the engine

### ■ PREPARING TO DRIVE

- Preparing to drive
- Running in instructions
- Gear shifting

### ■ FUEL ECONOMY

- Instructions to improve fuel economy

### ■ DRIVING IN ADVERSE CONDITIONS

- Driving through water
- Driving on a rainy day
- Night driving
- Towing the vehicle

### ■ DRIVING A DIESEL / PETROL CAR

### ■ DRIVING SAFETY

### ■ CAR SAFETY CHECKS

## STARTING & DRIVING

### OPENING & CLOSING THE BONNET

#### Opening :

1. Ensure that the car is in neutral gear with the parking brake applied.
2. Pull the bonnet release lever located under the right hand corner of the dash board. The bonnet will pop up slightly.
3. Raise the bonnet slightly and with your finger lift the secondary lock lever located under the bonnet centre.
4. Lift the bonnet up. Pull the bonnet stay rod from its clip and insert the free end into the slot in the bonnet, slide stay rod outward to secure.

#### Closing :

1. To close the bonnet disengage the stay rod & clamp it properly.
2. Lower the bonnet and drop it from a short height to shut.

 Ensure that the bonnet is properly locked before driving.  
Do not press the bonnet onto the bonnet lock.

 Do not leave the engine running in a closed garage.

### Opening & Closing the Bonnet

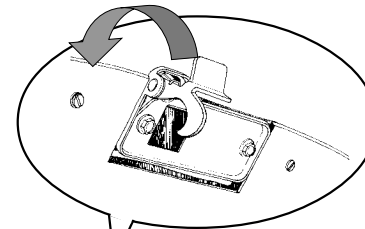
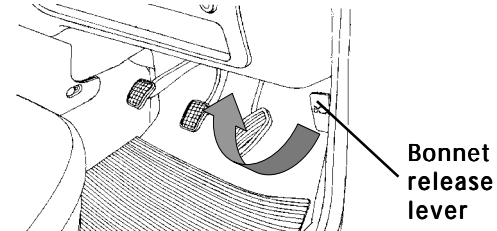

## STARTING & DRIVING

## Check List

Check	Adjust	Ensure
1. Tyre pressure	1. Front seat	1. Bonnet is fully closed
2. Coolant level	2. Rear view mirrors	2. All doors are properly closed
3. Engine oil level		3. Seat belts are fastened
4. Brake fluid level		4. All switches & lamps are working
5. Water in windshield washer reservoir		5. Gear shift lever is in neutral position
6. Power steering oil level (if installed)		6. Parking brake is released
7. Battery electrolyte level		
8. Fuel level		

## STARTING & DRIVING

### Fuel Level :

Check fuel level on the gauge in the instrument panel. If the pointer is in the red zone and/or visual low fuel level warning indicator (Amber colour LED) glows, please ensure fuel filling at the earliest. Avoid driving with fuel at minimum level.

### Engine Oil Level :

1. Open the bonnet. Pull out the dipstick and wipe it with a clean cloth or a paper napkin.
2. Insert it again to its original position.
3. Pull out the dipstick again and observe the oil level on the dipstick.
4. Top up oil if the oil level is below the mid point of min. and max. marks.

**Note :** Oil level should not exceed the max. mark. Always check the oil level when the car is on level ground and the engine is cold.

 Check the engine oil level if low oil pressure warning comes 'ON' while driving.

## Fuel Level & Engine Oil Level



1. Engine oil filling cap 2. Dip stick

## STARTING & DRIVING

### Engine Coolant Level :

The coolant level is visible through the translucent reservoir. It should be between max. & min. marks. If it seems less, add premixed coolant into the auxiliary tank upto the max. mark. Put the cap back properly.



Never remove the filler cap when the engine is hot. Use only branded premixed ready to use coolant.

In case of an emergency, normal water can be used, but the system should be flushed & filled with proper coolant mixture at the earliest.

### Brake Fluid Level :

The level of the brake fluid must be between the min. & max. marks on the side of the brake fluid container. If the level falls below the min. mark, add recommended brake fluid. (Refer chapter - Fuels, coolants & lubricants)

In case of spongy or hard pedal or low brake efficiency, please contact the nearest Authorised Service outlet.



1. Do not allow brake fluid to make contact with the skin or eyes.
2. Do not allow brake fluid to splash or spill on the paint surface as it will damage the paint. In case of spillage, wipe it off immediately.

## Engine Coolant & Brake Fluid Level

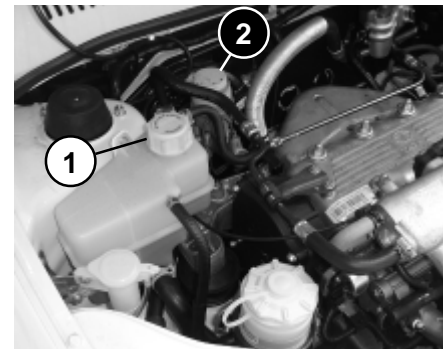

1. Engine Coolant filling cap
2. Brake Fluid filling cap

## STARTING & DRIVING

### STARTING THE ENGINE

#### Before starting the engine :

- Apply the parking brake fully.
- Ensure that the gear lever is in neutral position.

#### Starting the engine :

- Press the clutch pedal & turn the ignition key to 'IGN' position. Ensure the "Check Engine" lamp is "ON".
- Do not press the accelerator.
- Crank the engine, if the engine starts but fails to run then repeat the above procedure. Release the key as soon as the engine starts to return to IGN position. Ensure the "Check Engine" lamp is "OFF". This is a normal phenomenon of "Check Engine" lamp.

 Do not crank the engine for more than 10 sec. continuously. If the engine does not start, wait for 30 sec. before cranking it again. Release the key immediately after starting the engine, otherwise the starter motor/flywheel ring may get damaged.

#### Starting the engine with a malfunction :

- Press the clutch pedal and turn the ignition key to 'IGN' position.
- Press the accelerator pedal by 1/4th of full travel. Do not depress the accelerator pedal fully down.

## Starting & Stopping

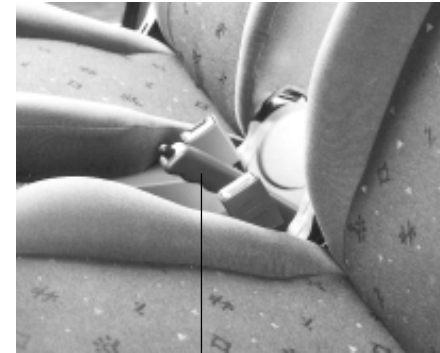

Parking Brake

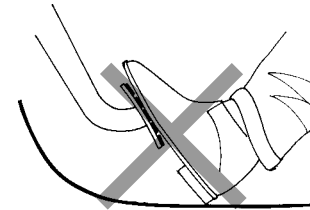



## **STARTING & DRIVING**

- Crank the engine. If the engine starts, car may be driven to nearest authorised service outlet, even though "Check Engine" lamp is indicating a malfunction.
- In the above condition engine may stall if the accelerator pedal is released back to idle position.
- If engine stalls, repeat the above procedure from beginning & drive the car without releasing the accelerator pedal to "Idle" position.

## **Brake Fluid Level & Stopping the engine**

### **Stopping the Engine :**

- Let the car come to a stop and engine to idle.
- Turn the key to 'OFF' position.

### **Parking :**

- Park the car in a safe place. Switch on the indicator signal before turning to park.
- Apply the parking brake.
- Ensure that all window glasses are closed and all lamps are turned 'OFF'.
- At night, put on the parking lights if required.
- Remove the key from the ignition switch.
- Place wheel chokes at the wheels if parked on a slope.



Do not leave the key inside the car.

Do not leave children unsupervised in the car.

Avoid parking the car over inflammable materials, such as dry leaves, grass etc., as the exhaust system is hot enough to initiate "FIRE".

## STARTING & DRIVING

## Preparing To Drive

### Preparing to Drive :

The following checks and adjustments should be carried out before you start driving the car.

- Ensure that the windshield, all mirrors, windows and outside lights are clean. Check & adjust rear view mirrors.
- Ensure that the windshield washer reservoir is full.
- Ensure that the bonnet is properly closed.



Do not put excessive pressure on top of bonnet to avoid damage.

- Release the parking brake.
- Check that any items that you may be carrying inside, are fully secured.
- Check & adjust seat.
- Ensure that all doors are locked properly.
- Fasten seat belt properly.
- Ensure that all gauges and indicator lights are working.
- Check for blind areas being unobstructed in front and rear of the car.
- Before driving off check in the rear view mirror, for oncoming traffic. Switch on side indicator signal when getting into main stream of traffic.

### Running-in instructions :

During running-in period i.e. first 1000 km. follow the running-in instructions given below :

- A. 1. After starting the engine do not rev it up. Warm up gradually at idling speed.
2. Avoid sudden acceleration and full throttle.
3. It is always preferred not to rev up a cold engine lest engine bearings get affected.

B. Recommended car speeds during running-in period :

<b>Gear</b>	<b>Speed (kmph)</b>
1st	20
2nd	40
3rd	60
4th	80
5th	90

## STARTING & DRIVING

### Gear Shifting :

All forward gears being synchronised, provide for easy and effortless gear shifting. Always remember to press the clutch pedal fully while shifting the gears and also to release the clutch pedal gently.

Avoid sudden clutching i.e. abrupt release of depressed clutch pedal.

Do not shift into reverse gear when the car is moving forward or when the engine is not at idling r.p.m. A 5 second pause after declutching will ensure smooth engagement of the reverse gear. Change gears at appropriate gear change speeds.

**Note :** There is an interlock provided between fifth and reverse gear to prevent accidental shift from 5th gear to reverse gear. (Shifting from reverse gear to 5th gear is

### Appropriate gear change speeds for good pick-up :

Speed (kmph) Upshift		Speed (kmph) Downshift	
1st to 2nd	- 25	2nd to 1st	- 15
2nd to 3rd	- 50	3rd to 2nd	- 40
3rd to 4th	- 70	4th to 3rd	- 70
4th to 5th	- 85	5th to 4th	- 80

## Preparing To Drive

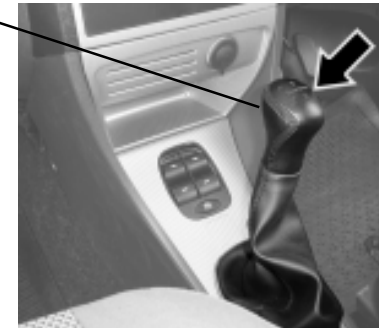
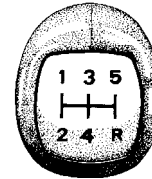

### Recommended maximum speed, during normal operation.

Gear	Speed (kmph)
1	35
2	60
3	85
4	120
5	125

## STARTING & DRIVING

### INSTRUCTIONS TO IMPROVE FUEL ECONOMY :

Your car's fuel economy is mainly dependent on your style of driving.

To operate your car as economically as possible, use the following driving suggestions.

#### **Avoid Excessive Idling :**

Stop the engine and start it again, if you have to wait for more than a minute while you are stopped.

#### **Avoid fast starts & unnecessary stops :**

Start off slowly from traffic lights or stop signs to prevent increased fuel consumption and shortening of engine life. Avoid unnecessary deceleration (stopping or slowing down) and then acceleration which uses more fuel.

#### **Always maintain clean air-cleaner :**

The amount of air supplied will reduce due to clogged air-cleaner, resulting in waste of fuel due to incomplete combustion.

#### **Avoid incorrect tyre pressures :**

Under-inflated tyres result in increased running resistance of the tyres, leading to wastage of fuel.

## Fuel Economy

**Always have the engine tuned correctly through recommended maintenance at an Authorised Service outlet.**

#### **Proper Driving Practices :**

Keep a safe distance from other vehicles to avoid braking suddenly.

Do not rest your foot on the clutch pedal. It does not allow full engine power to be transmitted to the vehicle and reduces clutch life.

#### **Fuel economy speeds :**

<b>Gear</b>	<b>Speed (kmph)</b>
1st	10
2nd	25
3rd	35
4th	50
5th	60

#### **MPFI System**



The multi point fuel injection system has been designed to meet various load and speed conditions of the engine and doesn't require any regular maintenance. MPFI system should be serviced by authorised service personnel only, if required.

### TIPS RELATED TO FUEL SYSTEM MAINTENANCE :

Basically, the fuel system of the vehicle consists of the following main components :

1. Fuel tank
2. Fuel Filter
3. Fuel Pump
4. Fuel Rail
5. Fuel pressure regulator and
6. Fuel injector.

The following instructions are to be followed for reducing problems related to the fuel system.

- a) Avoid keeping the fuel tank empty and preferably keep it topped up as frequently as possible.



Empty fuel tank may lead to inner corrosion of the tank. The rust particles thus formed may result in frequent clogging of fuel filters. The rust particles enter the system, resulting in malfunctioning of the MPFI system.

- b) Replace clogged fuel filters to prevent inconsistent fuel delivery from the fuel pump.

## STARTING & DRIVING

## Driving In Adverse Conditions

### Driving Through Water :



- Never venture to drive through water when it flows above the stone guard or above the tyre centre line.
- The engine may get seriously damaged if attempts are made to cross through deep water.
- If at all the situation demands that you have to drive through water even at great risk then,
- Keep the engine in fast idling and 'crawl' in low gear.
- After driving through water apply the brakes several times to dry the liners and to regain original braking.
- Check the engine and transaxle for any water ingress.



**Do not attempt to start the engine if the car gets flooded due to water.**

- Tow the car to a safe place.
- Take the car to the nearest Authorised Service outlet to check for entry of water in the engine.
- Lubricants in the engine and transaxle need to be changed in case of water entry.



## STARTING & DRIVING

### Driving on a Rainy Day :

- ⚠️ • Check wiper blades for proper functioning.
- Check brakes, steering and windows.
- Check tyres for wear and tyre pressure. Worn out tyres are unsafe on wet roads.
- Avoid harsh braking and sharp turns. It may cause loss of steering control and lead to the car skidding.
- For slowing down, shift to lower gears and apply brakes gently.
- Keep lights on if visibility is poor.
- Use heater and demister if required to clear off mist on the windshield.

### Night Driving :

- ⚠️ • Dip the head lamp for oncoming traffic during night driving.
- Maintain a speed such that you can stop within illuminated distance of the head lamps.
- Use head lamp main/dip beam to alert other users on turns/cross roads, etc.
- Use side indicators to indicate lane change or turning.
- Put on the hazard warning switch in case of hazardous parking or if your car is disabled to warn passing traffic. Put on the fog lamps (for Deluxe version) if required.

## Driving In Adverse Conditions

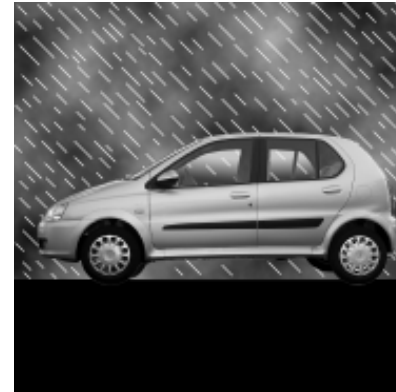

## STARTING & DRIVING

### Towing the Vehicle :



- For towing a car, the best way is to use a wrecker.
- Alternatively use a rigid tow bar.
- Avoid using a flexible cable or rope as your car may crash into the car towing your car when it stops suddenly.
- Switch 'ON' the hazard warning signals of both the cars to warn other road users.
- Where possible, keep the engine idling so that power steering assistance and brake vacuum are available.
- Limit the speed to 20-30 kmph.
- In case of brake failure, use the parking brake to control the car.

## Driving In Adverse Conditions



Front Towing Hook



Rear Towing Hook



## STARTING & DRIVING

## Driving Safety

### DRIVING SAFETY

#### Seat-Belt

Seat-belts are life saving equipment and their use reduces the chance of injury and severity of injury in case of an accident. It is strongly recommended that all the car occupants should always wear the seat-belt, while car is in motion.

#### Influence of Alcohol

Avoid driving under the influence of alcohol or drugs. Alcohol and drugs will severely impair your control on the vehicle and increase the risk of injury to yourself and others.

#### Mobile phones

Avoid using mobile phones while driving. This could divert your attention from the road and result in an accident.



#### Fatigue 'Rest Revive Survive'

Do not attempt driving when you feel tired or sleepy. Long distance driving can tire you very much and fatigue can dull your reflexes and judgment. Take a break and get refreshed at intervals.

### CAR SAFETY CHECKS

#### Windshield/wiper/windshield washer

Always keep windshield glass clean to avoid any distraction in visibility. Ensure proper working of wipers and condition of wiper blade. Ensure that windshield washer reservoir is full. Do not operate wiper alone when the windshield glass is dry, which would damage the windshield.

#### Headlights

Keep headlight lenses clean. Check for operation of headlamp in both high/low beam conditions. Check for correct focusing of headlamps. Use only recommended type of bulbs. Do not use the high beam unless it is inevitable. Its dazzle may glare the driver of the oncoming car thus causing an accident.

## STARTING & DRIVING

### Side indicators / Hazard warning

Ensure that all side indicators/hazard warning lights are always in working condition and they are used when required.

### Horn

Ensure the horn is working properly. Horn provides safety to other road users by alerting your presence.

### Brakes

Ensure the brakes are in working condition. Check brake fluid level in reservoir. Do not drive the car when brake warning lamp is 'ON'.

### Tyres

Check the condition of tyres for any abnormalities. Maintain correct tyre pressure, it is very important particularly when subjected to extreme

conditions, such as high speed, high load and high outside temperature. Do not use worn or bald tyres on the front wheels.

### First Aid Kit :

First aid kit is provided in your car. This is for use in case of minor injuries. It is to be regularly checked for any disintegration and should be updated regularly.



### Advance Warning Triangle :

There is an advance warning triangle provided along with your vehicle. In case there is a breakdown and the vehicle is parked at the side of road,

## Driving Safety

then the triangle is to be kept as per instructions given below :

Remove advance warning triangle from case and assemble.

Place the triangle on the road behind the vehicle when it stranded on the road. The triangle must be at least 50 meters behind the vehicle in the same lane of traffic.

Increase the distance to 150 meters on a highway or if a bad/hill top obscures the view.





## MAINTENANCE & CAR CARE

### ■ MAINTENANCE POINTS

- Engine compartment
- Engine compartment lamp
- Windshield washer
- Air Filter
- Engine cooling system
- Engine oil and oil filter
- Belt tension
- Fuel system
- Transaxle oil
- Cluth & clutch adjustment
- Brake & brake adjustment
- Power steering
- Battery
- Catalytic Converter
- Spark plug
- Carbon canister
- LPG filter
- LPG pressure regulator diaphragm

- Starting the engine with jump leads
- Wheel change
- Wheel alignment
- Wheel balancing
- Tyres & tyre rotation
- Spare wheel
- Repairing a tyre / tube
- Fuses & Relays
- Head lamp and head lamp adjustment

### ■ CAR CARE

- Washing
- Polishing
- Cleaning of carpets
- Cleaning of glass
- Wiper care
- Paint care

## MAINTENANCE POINTS

## Engine Compartment

### ENGINE COMPARTMENT - INDICA LPG



- |                                 |                       |                                   |
|---------------------------------|-----------------------|-----------------------------------|
| 1 Window Washer Fluid container | 2 Engine Coolant Tank | 3 Brake Fluid Container           |
| 4 Engine Oil Filling Cap        | 5 LPG Regulator       | 6 LPG Fuel Filter                 |
| 7 LPG - ECU                     | 8 Main ECU            | 9 Battery                         |
| 10 Air Filter                   | 11 Dip Stick          | 12 Power Steering Fluid Container |

## MAINTENANCE & CAR CARE

## Engine Compartment Lamp & Windshield Washer

### ENGINE COMPARTMENT LAMP : (if fitted)

Engine compartment lamp is provided to illuminate the engine compartment.

A push - pull type switch is provided to operate the lamp.

 Do not forget to switch 'OFF' the engine compartment lamp before closing the bonnet.

A provision has been made for installation of engine compartment lamp in standard version.

### WINDSHIELD WASHER :

Windshield washer fluid container is located behind the front right hand side panel and its filler neck is provided near auxiliary tank in the engine compartment.

 Do not add detergent or any solvent in the windshield washing water.



Engine Compartment Lamp



Windshield Washer Fluid Container

## MAINTENANCE & CAR CARE

## Air Filter

### AIR FILTER :

The air filter element should be periodically cleaned. Replace the air filter element with a new one, if necessary.

Always use a genuine air filter element.

The air filter is located on the LH side of the engine compartment.

### Replacement of Air Filter Element :

- a) Remove the cover of the air filter, by loosening the screws.
- b) Remove the air filter element.
- c) Clean it gently by tapping. Clean air filter cover and air ducting.
- d) Check the element for puncture or pin holes by holding against a bright light source.
- e) If found to be OK, reinstall the filter element. Fit the cover with screws.



- a) When a car is driven under dusty conditions, frequent replacement of the air-cleaner element is necessitated.
- b) Clogged air-cleaners lead to greater intake resistance and result in increased fuel consumption. Using low pressure compressed air, blow off dust on the air cleaner element. If the air cleaner element appears to be choked, replace it with a new one.

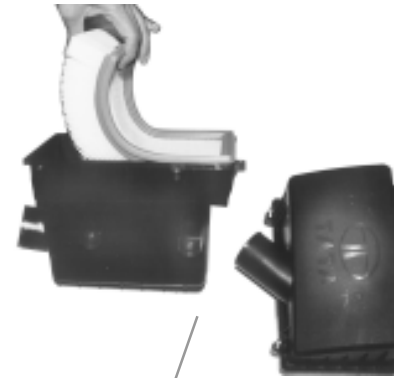

Air Filter

## **MAINTENANCE & CAR CARE**

### **ENGINE COOLING SYSTEM :**

If engine overheating occurs, there could be a fault in the cooling system which may be due to :

1. Insufficient coolant in the cooling system or dirt/scales having accumulated inside the cooling water passages especially in the radiator core.
2. Choking or damage of radiator passages.
3. Defective thermostat.
4. Non operation of electrically operated fan. (40 Amp. fuse blown)
5. Coolant leakage.
6. Auxiliary tank cap not sealing properly.
7. A.C. condenser fan not working.
8. Excessive refrigerant charging in the A.C. system.
9. Improper bleeding of the cooling system.

### **Prevention of Rust Formation :**

To prevent rust formation use the branded premixed engine coolant in the radiator.

This is sufficient to operate the car upto -40°C.

## **Engine Cooling System**

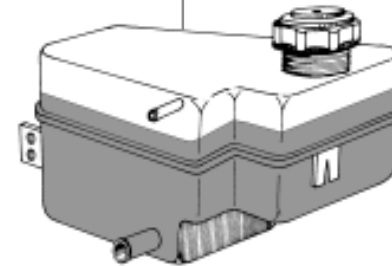

**Engine Coolant Tank**

### Replacing Engine Coolant :

The cooling system should be completely drained and refilled with new coolant at specified intervals

1. Touch the engine and radiator only after ensuring that they are cold.
2. Remove the auxiliary tank cap.
3. Loosen the drain plug at the bottom of the radiator.
4. Remove the auxiliary tank from its holder, drain the coolant and refit it.
5. Flush the radiator by using reverse flow i.e. radiator drain plug to auxiliary tank with clean water and close the drain plugs.
6. Pour the premixed ready to use engine coolant into the radiator until it is full.
7. Fill the auxiliary tank upto the 'MAX' mark and fit the cap.
8. Ensure that there is no leakage in the system.



Do not touch the engine and radiator when hot.



## MAINTENANCE & CAR CARE

### Changing of Engine Oil and Oil Filter :

Change the oil and oil filter cartridge at specified intervals (Engine oil and oil filter cartridge may be changed earlier if the car is operating in sandy/dusty conditions). Changing of oil and oil filter requires access from underneath the body. The car should be raised on a hoist at a service station or should be parked on a service pit.

1. Run the engine until it reaches normal operating temperature. Then shut it off.
2. Open the bonnet and remove the engine oil filler cap. Remove the drain plug of the oil sump from the bottom of the engine. Drain the oil into an appropriate container. Take proper care as the engine oil will be hot.
3. Remove the oil filter with the help of a special wrench. Destroy the filter to avoid reusage of the same.
4. Smear a little fresh engine oil on the rubber gasket of the new engine oil filter. Hand tighten the engine oil filter and give a further three fourth turn with the special tool.

**Do not over tighten engine oil filter as this may damage oil filter and oil may leak out.**

5. Before filling in fresh oil in the engine, clean the drain plug and threads on the sump. Apply Maxifix sealant on the threads.
6. Refit the drain plug using a new sealing washer. Tighten the drain plug to 3.5 mkg. torque.

## Engine Oil & Oil Filter

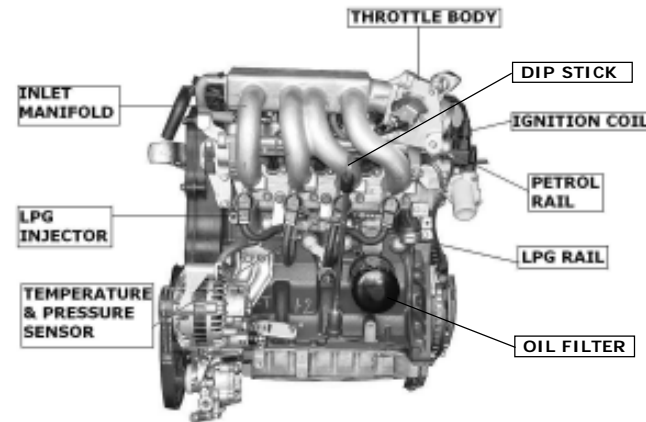

7. Fill recommended quantity of fresh engine oil in the crank case and secure the oil filler cap in its place.
8. Start the engine and run for a few minutes. Do not heat up the engine. The engine oil pressure lamp should go 'OFF'. after starting the engine.
9. Check for engine oil leakages, rectify if any.
10. Stop the engine and recheck the engine oil level after a few minutes. If necessary add oil to bring the level to the upper mark on the dip stick.

**Note :** Use of reclaimed oil is not recommended.

## MAINTENANCE & CAR CARE

### Belt Tension :

Check the condition of belts on the engine. Examine the edges of the belt for cracks or fraying.

Check the tension of the belt by pushing on it with your thumb midway between the pulleys for the alternator belt, power steering pump belt and A.C. compressor belt. If the belt tension is not proper i.e. it gets deflected more than specified, get it attended to at the nearest Authorised Service outlet.

### Belt tension adjustment :

- a. Loosen bottom mounting bolt of the alternator.
- b. Loosen bolt holding upper mounting of alternator to the clamping piece.
- c. Loosen the lock nut.
- d. Adjust belt tension by turning the adjusting nut i.e. by turning the alternator away from the engine.
- e. Tighten lock nut and the bolt holding the clamping piece to alternator.
- f. Tighten bottom mounting bolt.
- g. Recheck belt tension.

1. Alternator mounting bottom bolt
2. Alternator mounting upper bolt
3. Clamping piece
4. Clamping bolt
5. Adjusting nut
6. Lock nut

## Engine Belt Tension

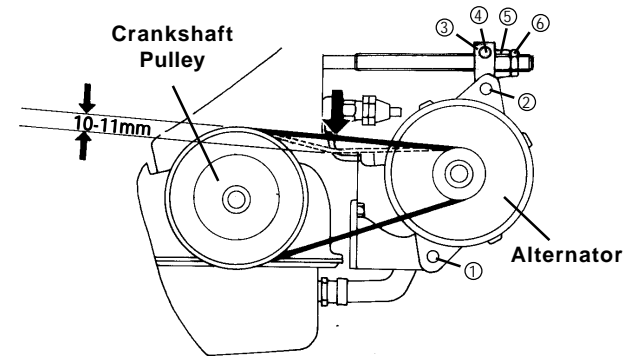

Engine with Alternator

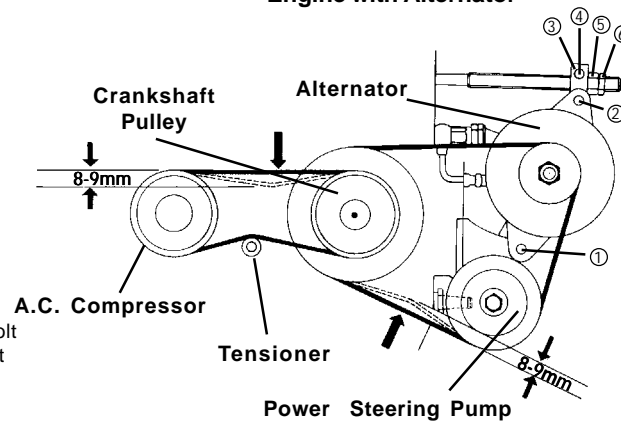

Engine with A.C., Alternator and Power Steering

## MAINTENANCE & CAR CARE

## Fuel Filter

### Changing Fuel Filter Element :

The fuel filter is transparent and located near the fuel tank (under the body). Inspect and replace the fuel filter at specified intervals. Replace the fuel filter if dirt is observed in it.



The fuel filter should be replaced at any Authorised Service outlet as the fuel system is under pressure and petrol can spurt out from fuel line connections.

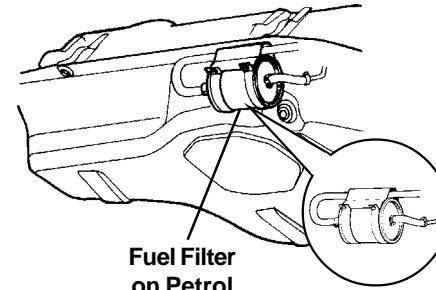

Fuel Filter  
on Petrol  
System





Fuel Filter on LPG System

## MAINTENANCE & CAR CARE

### PETROL FUEL FILLING :

The fuel filler cap is located on the left rear side of the car. The fuel filler lid can be unlocked by pulling the opening lever located on the out-board side of the driver's seat and locked by simply closing the lid.

 Remove the fuel filler cap slowly. The fuel may be under pressure & may spray out, causing injury if the cap is opened suddenly.

 The fuel cap is of the non vented type. Use correct genuine cap for replacement.

- To remove the fuel filler cap turn the cap anti-clockwise. Turn the cap slowly to allow any residual pressure to escape.
- To install turn the cap clockwise till a click sound is heard.

Petrol is extremely flammable. Do not smoke when refuelling and make sure there are no open flames or sparks nearby.

If you need to replace the fuel cap, use only a cap specified for your car. Using an improper fuel cap can cause a serious malfunctioning of the fuel system. You can get the correct replacement from an Authorised Service outlet.

## Petrol Fuel Filling Cap

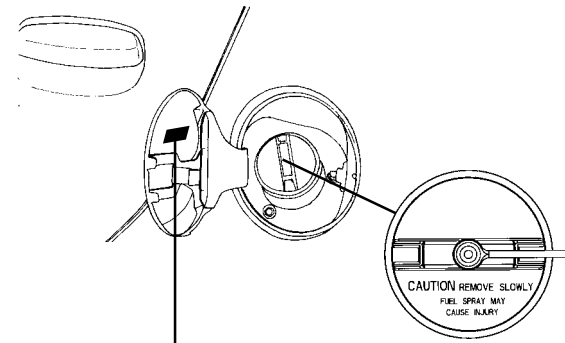

**STICKER**  
**UNLEADED PETROL ONLY** - FOR PETROL  
VERSION WITH CATALYTIC CONVERTER

## MAINTENANCE & CAR CARE

### LPG FILLING :

LPG filler valve is located at the rear on the right hand body side of your car. LPG filling will stop automatically once the LPG tank is filled to 80% of its capacity.

The LPG cylinder capacity of your car is 31 litres. If the LPG is filled after service / repairs of the LPG system, please check all joints for leakage by applying soap solution or by using an electronic instrument. Example -'Leakator - 10'. or equivalent.

#### NOTICE

Keep the Ignition switch in "OFF" condition during LPG refilling

### FUEL TANK CAPACITY :

Petrol tank capacity = 37 Litres

## LPG Fuel Filling

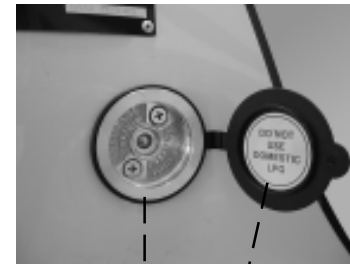

STICKER :  
DO NOT USE DOMESTIC LPG



LPG Fuel Filling Cap

## MAINTENANCE & CAR CARE

## Transaxle

### Transaxle Oil :

#### Checking of Oil Level :

1. Clean the oil level plug and the surrounding area.
2. Remove the oil level plug and check whether oil is dripping out. The oil level must not be below the filler plug. Add oil to bring it to the required level.
3. Tighten the oil level plug to 3 - 4 mkg. torque.

#### Changing Oil in Transaxle :

1. Let the engine idle for about 5 min. in neutral gear, so that the Transaxle is warmed up.
2. Clean the oil level plug, drain plug and surrounding area.
3. Place a container under the transaxle to collect the oil.
4. Remove the oil level plug.
5. Remove the drain plug and let the oil drain out fully.
6. Refit the drain plug with a new sealing washer. Tighten the oil drain plug and fill new recommended oil through the oil level plug. Tighten both the oil drain plug and oil level plug (with new sealing washer) to 3 - 4 mkg. torque.

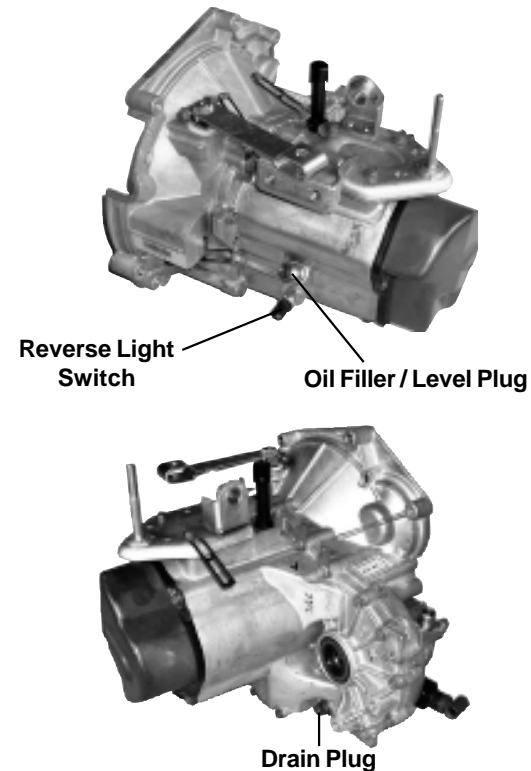

## MAINTENANCE & CAR CARE

## Clutch & Brakes

### CLUTCH :

Your car is provided with a single plate dry friction diaphragm type, pre-loaded release bearing clutch which is mechanically actuated by a cable connecting the clutch pedal & the clutch release lever. There is no free play in the system and hence no clutch pedal free play adjustment is required although the clutch pedal height from the floor has to be adjusted as clutch lining wears. The clutch pedal height from the floor keeps on increasing as the clutch lining wears. However, ensure that clutch pedal has free movement when lifted upward



Do not ride the clutch. It will cause premature clutch wear.  
Do not release the clutch suddenly.

### BRAKES :

Dual circuit, diagonal split hydraulic brakes through tandem master cylinder have been provided. The front brakes are disc brakes with floating type calipers while the rear brakes are drum brakes with automatic adjustment.

No adjustments are required for front & rear brakes.

The parking brake is a mechanical lever type, console mounted, cable operated, acting on rear wheels.

To operate, pull up.

To release pull up, press the button, lower handle then release the button & handle.

Pressure reducing valves are provided on both circuits for the rear brakes to avoid locking of wheels & skidding of the car.

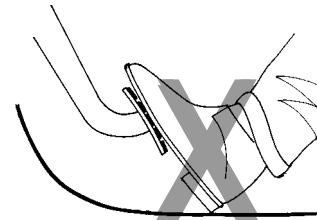

## MAINTENANCE & CAR CARE

## Clutch & Brakes

**NOTE : Vacuum Assistance :** The hydraulic brake system of your car is assisted by a vacuum booster which reduced the effort of driver during braking. In the unlikely event of disruption in supply of vacuum to the booster (e.g. stoppage of engine, or failure of vacuum hose) this assistance will still be available but only for one or two brake applications to bring the vehicle to a stop. Beyond this, vacuum assistance will not be felt by the driver and brakes will appear to be hard/ineffective. In order to stop the vehicle effectively the driver will have to apply a much higher force on the brake pedal (roughly 5 times the normal effort)

 Never drive the vehicle in engine switched "OFF" condition.

### BLEEDING PROCEDURE FOR BRAKE SYSTEM :

1. Clean all dirt from around reservoir filler cap.
2. Fill reservoir with fresh brake fluid to lower edge of filler neck.
3. Attach bleed tube to left front caliper bleed screw and dip the other end in jar of fresh brake fluid.
4. Start engine and open the bleed screw by 1/2 to 3/4 of turn.
5. Depress foot pedal slowly and fully. After tightening the bleed screw, allow it to return slowly.
6. Wait for 3-4 seconds before next stroke.
7. Repeat until bubbles stop emanating from bleed tube.
8. Close bleed screw immediately after the last downward stroke of pedal and hold pedal.

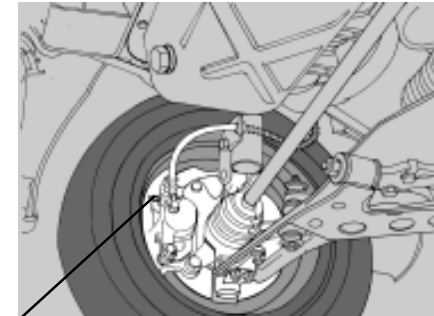

Front wheel

Bleeding Nipple

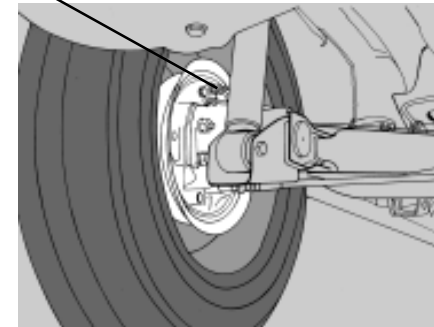

Rear wheel



## MAINTENANCE & CAR CARE

9. Tighten bleed screw and remove tube.
10. Replace dust cap on bleed screw.
11. Repeat same procedure on rear right, front right and then rear left.
12. If bleeding continues without success it means air is being drawn in past the bleed screw threads.
13. Close bleed screw at the end of each downward stroke of pedal.
14. Allow pedal to return fully and slowly.
15. Tighten bleed screw finally after last downward stroke of pedal.
16. Replace the dust cap on the bleed screw.
17. Apply brake pedal hard and check for any leaks.

### Brake and clutch pedal adjustment :

1. Ensure that clutch pedal height is the same as the brake pedal height.
2. Connect the front end of the clutch cable to the clutch release lever and adjust the cable by setting the nut by hand so as to get clutch pedal height same as brake pedal height, and cable is tight.
3. Due to wear of the clutch disc, the pedal lever will lift up. Readjust the pedal height again, using clutch cable.

**NOTE :** Brake pedal height adjustment is required only in case of component removal, etc. Adjustment is not required during normal maintenance.

## Clutch & Brakes

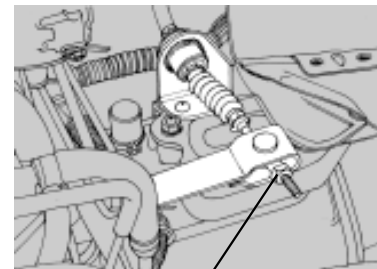
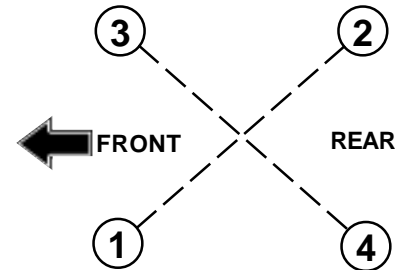

Clutch Adjustment Nut

## MAINTENANCE & CAR CARE

- Adjust brake light switch, gap of 3 mm to be maintained as shown in the fig. after loosening the lock nut on the switch. Tighten the nut after adjustment. This should be done with brake pedal in complete released condition.

**!** Do not apply tightening force over the switch body/terminal block as it may damage the switch. Electrical supply for brake lights is 'ON' without ignition switch. Under normal condition the switch shall be 'OFF' and the lights are not glowing.  
Any improper adjustment may result in either brake grabbing unnecessarily or spongy brakes.

## Clutch & Brakes

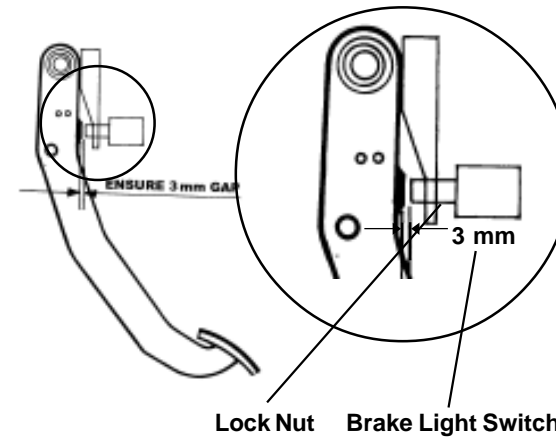

## MAINTENANCE & CAR CARE

### Brake Fluid :

Check the level of brake fluid in the brake fluid container.

It should be between the Min. and Max. marks.

If not, then add brake fluid. Clean the area surrounding the cap before opening the cap. Always use fresh brake fluid and tighten the cap fully, otherwise moisture from the atmosphere will be absorbed by the brake fluid, making it unserviceable.

In case of spongy or hard pedal or low brake efficiency, please contact the nearest Authorised Service outlet and get the defect rectified.

### POWER STEERING (if installed)

Power steering is fitted for lighter steering effort and easy manoeuvrability, during driving and also help absorb the road shocks. The system consists of steering gear box, hydraulic pump and hydraulic tank. Pump drive is through the poly 'V' belt from the engine. Power assistance is available during normal operating conditions. In case of failure in the hydraulic system, the steering can be operated mechanically to bring the car to an Authorised Service outlet.

Drive slowly as vacuum assistance for brake would not be available.



Report any external leakage to the nearest Authorised Service outlet.

## Brake Fluid & Power Steering

Brake Fluid Container



Power Steering Fluid Container

## MAINTENANCE & CAR CARE

## Power Steering

### Procedure for Oil Filling and Bleeding of Power Steering

(Ensure that the Power Steering fluid reservoir is clean before starting any work)

1. Fill the reservoir till it is nearly full, when the system is newly installed otherwise fill up to 'Max' mark on reservoir. Crank the engine for 10 seconds without allowing it to start (if possible). If engine does start, shut the engine immediately.  
Check & refill the reservoir. Repeat at least three times, each time checking & refilling the reservoir.
2. Check for any leakage in the system and if noticed take corrective action.
3. Start the engine & steer the car from full left to full right turn 3-4 times.
4. Add fluid if necessary to maintain the level upto 'Max' mark on reservoir.

 Do not force the wheel in lock position either to the extreme left or right. The power steering pump may get damaged. Hold it gently.

5. When the engine is at steady speed, check for bubbles or foaming in the oil. If present it indicates that air is getting sucked into the system. Check the suction line/fittings and correct if necessary.

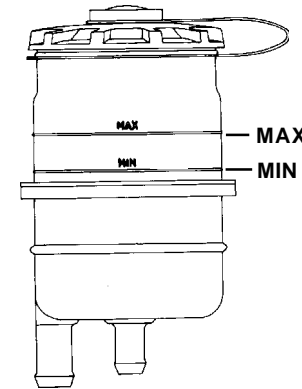
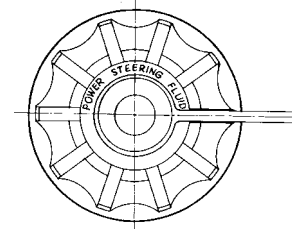

**Power Steering Fluid Container**

## MAINTENANCE & CAR CARE

6. Once the system is bled properly and free from foaming, there should not be any appreciable change in the oil level in the reservoir, when the engine is started or stopped repeatedly.
7. Now the car is ready to be driven.  
Final oil level should be upto 'Max' mark of reservoir.



Do not allow fluid level to drop significantly or run out of the reservoir during the above operation. This may induce air into the system.

Severe damage could occur to the power steering pump due to dry running (Running without sufficient oil and due to severe cavitation on account of air entry due to low oil level). This could lead to loss of power assistance, damage and failure of the power steering system.

Do not start the engine without oil in the power steering system. This will result in serious damage to the pump. In case of an emergency, disconnect the pump drive belt and then start the engine or drive slowly as vacuum assistance for brake would not be available.

Always use recommended oil from sealed containers. Any contaminated oil poured in the system will result in damage to the pump and gear box.

Avoid mixing of different brands of oils.

## Power Steering & Battery

### BATTERY :

Check the battery for proper electrolyte level and corrosion on the terminals.



During normal operation, the battery generates gas which is explosive in nature, a spark or open flame can cause the battery to explode causing very serious injuries.

Keep all sparks & open flames and smoking materials away from the battery.

Getting electrolyte in your eyes or on the skin can cause severe burns. Wear protective clothing and a face shield or have a skilled technician to do the battery maintenance.

The battery contains sulphuric acid (electrolyte) which is poisonous and highly corrosive in nature.

1. Check the battery for electrolyte level against the marking on the battery outer case.
2. Check the battery terminals for corrosion (a white or yellowish powder). To remove it, cover the terminals with a solution of baking soda. It will bubble up and turn brown. When this stops wash it off with plain water. Dry off the battery with a cloth or paper towel.  
Coat the terminal with petroleum jelly to prevent future corrosion.

## MAINTENANCE & CAR CARE

Use a proper wrench to loosen and remove cables from the terminals. **Always disconnect the negative (-ve) cable first and reconnect it last.**

Clean the battery terminals with a terminal cleaning tool or wire brush.

Reconnect and tighten the cables, coat the terminals with petroleum jelly.

If you need to connect the battery to a charger, disconnect both cables to prevent damage to the vehicle's electrical system.

**Note :** Charging the battery with the cables connected can seriously damage your vehicle's electrical/electronic equipment.



Swallowing electrolyte can cause fatal injury if immediate action is not taken.

Do not reverse the battery connection on the vehicle as it may damage the vehicle electricals.

**Note :** -ve terminal is connected to the body/cab.

## Battery



Battery

## MAINTENANCE & CAR CARE

## Battery

### Starting the Engine with Jump Leads :

The engine with a discharged battery may be started by transferring electrical power from a battery in another car.

This may be dangerous as any deviation from the following instructions could lead to personal injury resulting from any battery explosion, as well as damage to the electrical systems in both cars.



Do not allow battery electrolyte to come in contact with eyes, skin, fabrics or painted surfaces. The fluid contains sulphuric acid which can cause injury and severe damage. Wear rubber gloves, to avoid risk of contact.

- To lessen the risk of injury, wear eye protection when working near any battery.
- Make sure that the battery providing the jump start has the same voltage as the battery in your car (12 V). Its capacity must be approximately the same as the original battery capacity. The voltage and capacity are given on the batteries.
- Do not disconnect the discharged battery from the car.
- Switch off all unnecessary electrical loads.
- Do not lean over the battery during jump starting.
- Do not allow the terminals of one lead to touch those of the other lead.
- Apply the hand brake. Keep the gearshift lever in neutral.

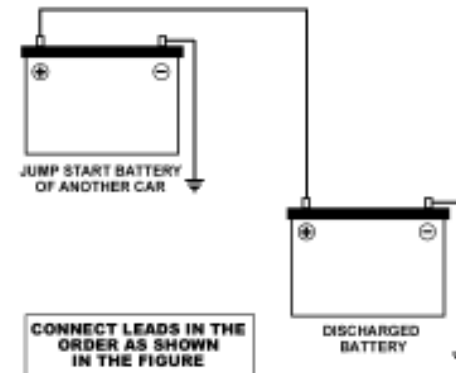

### Connect leads in the order as shown in the sketch :

- Do not connect the lead to the negative terminal of the discharged battery.
- The connection of the -ve lead point should be as far away from the discharged battery as possible and close to the starter motor on engine/transaxle.
- Route the leads so that they cannot get caught by the rotating parts in the engine compartment.
- The engine of the car providing the jump start can be allowed to run during starting.

Attempts to start the engine of the car with the discharged battery should be made at intervals of one minute and should not last more than 15 seconds. After starting, allow both engines to idle for approximately 3 minutes with the leads still connected.

## MAINTENANCE & CAR CARE

## Catalytic Converter

### Catalytic Converter :

The catalytic converter is fitted on your car to reduce exhaust pollution. The catalytic converter will quickly heat up after starting to ensure that it operates correctly during the warm up phase of the engine. **On a car with a catalytic converter, the fuel tank filler neck is of reduced diameter compatible with standard unleaded petrol supply nozzle.**

 Even one time use of leaded petrol may cause permanent damage to the catalytic converter. Hence use unleaded petrol only.

### Care & Maintenance :

- Use Unleaded Petrol only, since use of Leaded Petrol will damage (poison) the Catalytic Converter permanently.
- Consult an Authorised Service Outlet at the earliest when,
  - Engine misfires or runs irregularly, following a cold start,
  - A significant loss of Power is noticed.
- In the event of above symptoms, drive the car at slow speed without rapid acceleration. If the vehicle is continuously run with misfiring, it may cause overheating of shell, carpet etc. resulting into fire.

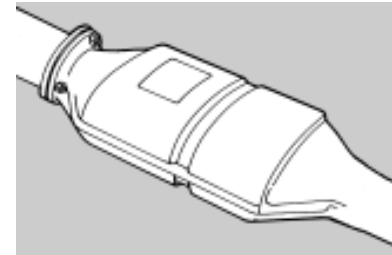

Catalytic Converter

### Avoid

- Push start or tow-starting the vehicle. (Use jump leads).
- Long (not more than 10 sec.) repeat (not more than 3 times) starting of the Vehicle. Investigate the cause for difficulty in starting & rectify the same.
- Long idling (to warm-up). If the engine is running rough, after a cold start.
- Switching "off" the ignition when driving down the hill. (This will not save fuel).
- Fuel tank getting almost empty.
- Idling the engine with any of the Spark Plug Cable disconnected, manually, during diagnostic test. (Use appropriate test equipment).
- Pre-Coating/Painting of Catalytic Converter.



## MAINTENANCE & CAR CARE

## Spark Plug

### Parking Warning :

Avoid parking the vehicle over inflammable materials, such as dry leaves, grass, etc., as the exhaust system is hot enough to initiate "FIRE".

### SPARK PLUG (Petrol Engine) :

<b>Spark Plug</b>	- <b>Champion / MICO*</b>
<b>Spark Plug No.</b>	- <b>C9YC / FR 6 DC 4</b>
<b>Spark Plug Gap</b>	- <b>0.7 mm to 0.8 mm</b>

You should inspect the spark plugs periodically for carbon deposits. When carbon accumulates on the spark plug, a strong spark will not be produced. Remove carbon deposits using a spark plug cleaner.

### Spark Plug Replacement :

1. Clean up any dirt or oil that is collected around the spark plug caps.
2. Pull out the spark plug cables by gripping at the connector.
3. Remove the spark plug with the help of a special socket.
4. Check and adjust the gap, it should be 0.7 mm to 0.8 mm.
5. Replace the spark plug if the gap is more than 1.2 mm.
6. Fix the spark plug and tighten it to the torque of 25 Nm (dry).

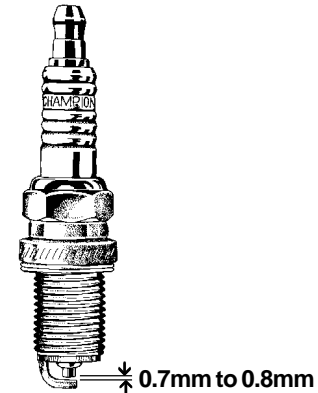

Spark plug

7. Fit the spark plug cable, until a "click" sound is heard. Repeat the procedure for the other spark plugs.



Tighten the spark plug carefully. Overtightening can damage the threads in the cylinder head. A loose spark plug or loose spark plug cable can affect combustion and cause damage to engine and catalytic converter.

## MAINTENANCE & CAR CARE

### CARBON CANISTER

As petrol evaporates in the fuel tank, hydrocarbons are discharged into the atmosphere. The carbon canister stores these hydrocarbons from the fuel tank.

Air drawn through the carbon canister into the engine should be controlled to maintain exhaust emissions within desired limits as well as to ensure good driveability.

The carbon canister should be replaced at an Authorised Service outlet.

Carbon canister is located LH side crash member in the engine compartment **Replace canister with a new one as per recommendation.**

### Carbon Canister

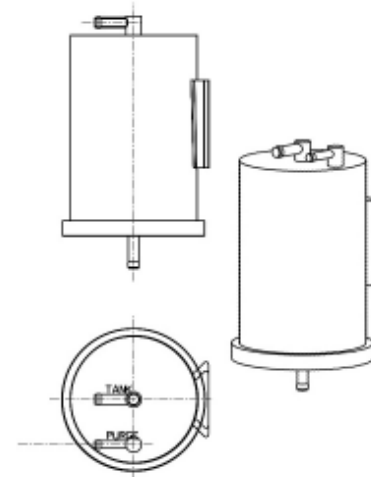

Carbon Canister

## MAINTENANCE & CAR CARE

## Wheels & Tyres

### WHEELS & TYRES :

Always use only the recommended size of wheel rims & tyres. Use of non-recommended rims and tyres may have an adverse effect on car safety and furthermore could infringe on car regulations.

### Spare Wheel Location :

Your car's spare wheel is mounted as shown in figure on a *cross member* that is located just behind the rear seat and has its mounting on the rear suspension towers. It is held in place by a single stud and tightened using a nut. Ensure that the wheel is seated properly on the bracket & is resting on the plyboard floor.

### Spare Wheel removal procedure :

Follow these steps to remove the spare wheel of your car

- a. Remove the nut on plate that holds the spare wheel with the cross member.
- b. Once this nut is removed, the wheel that is resting on the ply board covering the LPG tank is now free.
- c. The wheel can now be lifted and taken out.

**NOTE :** Once the spare wheel is repaired and is ready to be refitted, keep the direction of the air filling nozzle outwards for easy air filling.



1. Spare Wheel  
2. Spare Wheel Mounting Nut

## MAINTENANCE & CAR CARE

## Wheels & Tyres

### Jack removal procedure :

Your car's jack is located behind the spare wheel and is mounted on the floor. You can have access to the jack once the spare wheel is removed. To remove the jack, first unscrew the hook end. While refitting, position the jack below the support rod & screw the jack till it is firmly fitted.

### Wheel Change :

When changing wheels, use the jack provided with the car. The jack with handle is located on tailgate inner sill.

- Park the car on a safe level ground. Engage 1st gear and also apply the parking brake. Place wheel chocks behind the rear wheels and in front of the front wheels.
- Loosen the wheel pins of the wheel to be changed slightly. Keep the spare wheel to be fitted nearby.
- Jack up the car by placing the jack at the appropriate location.
- Remove the wheel pins, the wheel rim cover and the wheel.
- Fit the new wheel, wheel rim cover and tighten the wheel pins.
- Lower the jack and tighten the wheel pins to 8 mkg. torque.



1. Spare Wheel

2. Jack & Handle



A. Front Jacking Point  
B. Rear Jacking Point

## MAINTENANCE & CAR CARE

**NOTE :** The jack should never be supported on any of the body sheet metal components. This can cause damage to the body.

Do not apply oil on the wheel pins. Wipe off the oil if present.

- The jack should be placed below the body sill behind the front wheel tyre for front wheel changing and before the rear wheel tyre for rear wheel changing. Please refer to the sticker (Jack location) fixed on the jack.



Do not work under the jacked up car without proper support.

Correct wheel alignment helps to ensure uniform tyre wear. You should get your car's wheel alignment checked regularly as per recommendation.

In case uneven tyre wear is observed, the vehicle's wheel alignment should be checked as soon as possible.

### **Wheel Balancing :**

Wheels are balanced at the factory. They may need to be rebalanced at some time.

The wheels should be checked for balance if a tyre or tube is repaired.

## Wheels & Tyres

Whenever a tyre or wheel rim is changed, the tyre needs to be balanced.

1. Permissible imbalance for tyre with rim = 125 gm. cm. (max.)
2. Total balance weight should be within 80 gm on each side.
3. Relocate the tyre on the wheel rim if the weight required to balance is more than 80 gm.
4. Balance weights are available from 5 gm to 80 gm, in steps of 5 gm.
5. Do not use more than one balance weight on one side.

## MAINTENANCE & CAR CARE

## Wheels & Tyres

### Tyres :

Check for inflation and condition of your car tyres periodically.

### Inflation :

Check the pressure in the tyres when they are cold.

Refer to the tyre information label fitted on the driver side doorpost for correct cold tyre pressure.

### Recommended Tyre Pressures : (with cold tyres)

Refer page no. 12

You should have your own tyre pressure gauge and use it at all times. This makes it easier for you to tell if pressure loss is caused by a tyre problem and not by variation between gauges.

Keeping the tyres properly inflated gives you the best combination of riding comfort, handling and tyre life.

Over inflation of tyres makes the car ride bumpy and harsh. Tyres are more prone to uneven wear and damage from road hazards.

Under inflated tyres reduce your comfort in car handling and are prone to failures due to high temperature. They also cause uneven wear and more fuel consumption.

### Inspection :



Every time you check inflation pressure, you should also examine tyres for leakage, damage, foreign objects & wear.

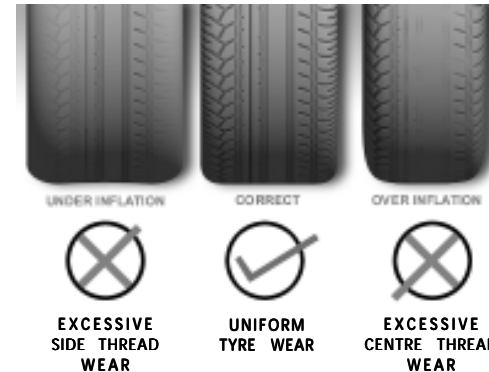

## MAINTENANCE & CAR CARE

## Wheels & Tyres

### You should look for :



- Bumps or bulges in the tread or the side of the tyre. Replace the tyre if you find either of these conditions.
- Cuts, splits or cracks in the side of the tyre. Replace the tyre if you notice this on the fabric or cord.
- Excessive tread wear or non uniform tyre wear.

### Tyre Rotation :

To help increase tyre life and distribute wear more evenly you should have tyres rotated at specified intervals or earlier depending on the operation of car and tyre wear pattern.

The illustration shows how to rotate tyres when a normal spare wheel is included in tyre rotation.

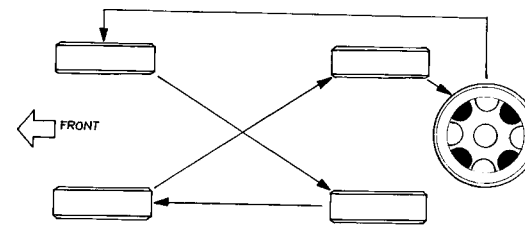

**Tyre Rotation**

## MAINTENANCE & CAR CARE

Your car's LPG system is protected against short circuit / overload by a fuse (15 A) fitted in the fuse box that is located behind the dash board on the right hand side.

To replace a blown fuse :

1. Open fuse box cover.
2. Identify blown fuse from its melted wire.
3. Remove the blown fuse & replace with one of similar amperage.

(For location of the fuse refer next page)

Take your car to a TATA Authorised service centre to find out the reason for the fuse to blow & repair the problem.

fuse replacment should prefreably be done only at TATA Authorised service centre

When the fuse blows OFF, the following may occur

- All LEDs on the switch will go OFF.
- If your car is running in LPG mode when fuse blows OFF, the LPG system will shut down and will automatically shift to Petrol mode.
- In such a case, you can start the car only in Petrol mode
- If your car is running in Petrol mode when fuse blows OFF it will keep running in the Petrol mode

## Fuse & It's Location

### WARNING

Always replace blown fuse with a fuse of correct amperage. Never use a substitute like aliminum coil or wire to replace a blown fuse. When you replace a fuse and the new fuse also blows OFF instantly, have the car inspected at a TATA authorised service centre.





## MAINTENANCE & CAR CARE

### Fuses & Relays :

The electrical circuits in your car have fuses to protect the wiring from accidental short circuit or sustained overload. Fuses and relays are located at 3 locations in your car as shown in the sketch. Circuit connected through fuses and relays and the amperage of the fuse is printed on the fuse box covers.

### Checking and replacing fuses :

If any electrical unit in your car has stopped functioning, the fuses should be checked first.

- Turn the ignition key to 'LOCK' position.
- Remove the fuse box cover, locate the fuse for the function.
- Remove the fuse & look for the fuse element inside the fuse. If it is damaged replace it with a fuse of same rating and type. Push the fuse firmly into the holder.
- Check that all other fuses are firmly in position and fix the cover back in position. Spare fuses are provided in the fuse box in the cabin.

If the replaced fuse of the correct rating burns out in short time, there is probably a serious electrical problem in your car. Get the car attended to at the nearest our Authorised Service outlet.

If any of the function relays is found defective, replace it by a genuine relay.



Never use a fuse of higher rating than specified.

Always ensure that spare fuses are replenished.

## Fuse & It's Location

### LOCATION OF FUSE BOX & RELAYS

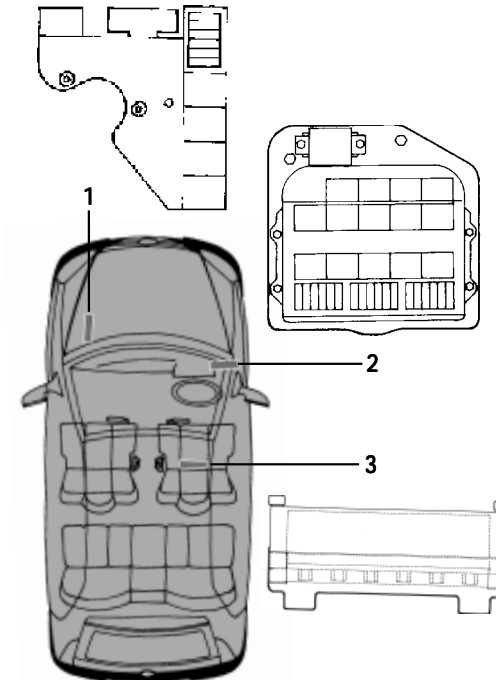

1. Engine compartment.
2. Cabin compartment under dashboard.
3. Cabin compartment under driver's seat (if installed).

## **MAINTENANCE & CAR CARE**

## **Head Lamps**

### **Head Lamps :**

The head lamps are provided with halogen lamps of H4 type with double filament for providing straight ahead illumination of the road for long distance or a dip beam which illuminates the road immediately ahead for short distance visibility. Use dip beam to avoid inconvenience / blinding the drivers of oncoming vehicles.

The head lamps must be properly aligned in order to obtain maximum road illumination and reduced glare for oncoming traffic. It is recommended to check alignment of head lamp beams periodically.

### **Focusing of Head Lamps & Front Fog Lamps :**

Provision is made for focusing of head lamps and front fog lamps. This should be done at the Authorised Service outlets.

### **Head Lamp Bulb Replacement :**

- Switch 'OFF' the head lamps & ensure that the bulb is not hot.
- Open the bonnet and remove the lamp connector from the head lamp bulb.
- Remove rubber cap. Unlock the locking clip and take out the bulb from the holder. This should be done carefully, otherwise it may lead to breakage of the bulb holder / holding clip.
- Note the instructions on the bulb carton.

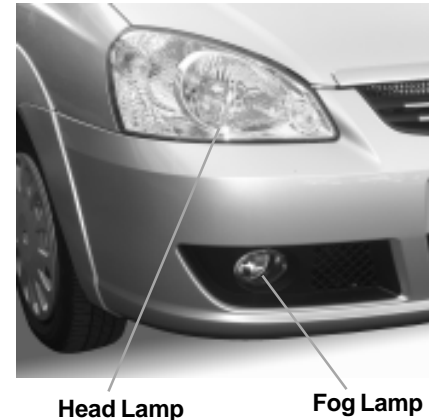

## MAINTENANCE & CAR CARE

Replace the bulb with a new one of the same type with right orientation in the holder.

- Lock the clip, fit the rubber cap and fix the connector.
- Switch 'ON' the head lamps and check the lighting.

**!** Do not clean or touch the head lamp reflector as it will damage the mirror finish of the surface.

The horizontal and vertical adjustment screws are located on the back of the reflector.

Precise adjustment can be carried out only in the authorised workshops.

When replacing the head lamp bulb, handle it by gripping the cap. Protect the glass from contact with your skin or hard object. If you touch the glass, clean it with spirit & a clean cloth. After replacement of the bulb in any emergency get the head lamp adjustment done at an Authorised Service outlet at the earliest.

**!** Halogen head lamp bulbs get very hot when illuminated. Oil, perspiration or a scratch on the glass can cause the bulb to break due to the heat.

## Head Lamps



1. Head lamp bulb
2. Position lamp bulb
3. Rubber cap
4. Cable Assembly
5. Side Indicator bulb

## MAINTENANCE & CAR CARE

## Car Care

### CAR CARE :

The car is subjected to many external influences such as climate, road conditions, industrial pollution and proximity to the sea. These conditions demand regular care of the car body. Dirt, insects, bird droppings, oil, grease, fuel and stone chippings should be removed as soon as possible.

### Washing :

Do not wash the car in direct sunlight, wash in shade. Spray the car thoroughly with a cold water jet (car on a washing pit or hoist). Mix car shampoo in the wash water. No solvent (fuel, thinners) need be used.

### NOTICE

Avoid wiping of painted surface in dry condition as it may leave scratches on the painted surface.

Use a soft bristle brush, sponge or soft cloth and rinse it frequently while washing. When you have washed the whole exterior, dry it with a chamois or soft cloth. After drying the car, inspect it for chips and scratches that could allow corrosion to start. Apply touch up paint where necessary.

### Polishes :

Polishes and cleaners can restore shine to the painted surface that has oxidised and become dull. They normally contain mild abrasives and solvents that remove the top layer



Car on Washing Pit

of the finish coat. Polish your car if the finish does not regain its original shine after using wax.

### Cleaning of Carpets :

Vacuum clean the carpet regularly to remove dirt. Dirt will make the carpet wear out faster. Periodically shampoo the carpet to keep it looking new.

Use carpet cleaners (preferably foam type). Follow the instructions that come with the cleaner, applying it with a sponge or soft brush. Keep the carpeting as dry as possible by not adding water to the foam.

## MAINTENANCE & CAR CARE

### Cleaning of Windows, Front & Rear Glass :

Clean the windows inside and outside with commercially available glass cleaners.

This will remove the haze that builds up on the inside of windows. Use a soft cloth or paper towels to clean all glass and plastic surfaces.

### Maintaining the car when not in extended use :

Park the car in covered, dry and if possible well-ventilated premises.

Engage a gear.

Remove the cables from the battery terminals (first remove the cable from the negative terminal).

Make sure the handbrake is not engaged.

Clean and protect the painted parts using protective wax.

Clean and protect the shiny metal parts using commercially available special compounds.

Sprinkle talcum powder on the rubber windscreen wiper and rear window wiper blades and lift them off the glass.

Slightly open the windows.

Cover the car with a cloth or perforated plastic sheet. Do not use sheets of imperforated plastic as they do not allow moisture on the car body to evaporate.

## Car Care

Inflate the tyres to 0.5 bar above the normal specified pressure and check it at regular intervals.

Check the battery charge every six weeks.

Do not drain the engine cooling system.

### Wiper Care :

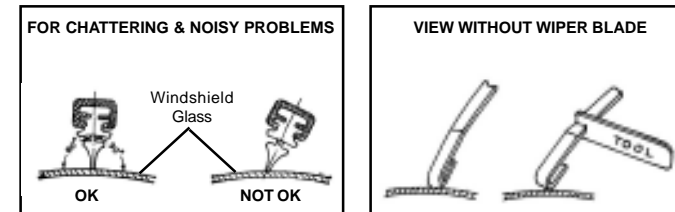

Wiper blade attack angle on windshield glass should be 90° i.e. perpendicular.

Remove wiper blade and root wiper arm on windshield glass in the centre position. Check the gap between arm strip and glass.

Adjust by twisting wiper arm as shown in the figure.

## **MAINTENANCE & CAR CARE**

## **Car Care**

### **FOLLOWING GUIDELINES WILL HELP YOU TO BETTER PROTECT YOUR CAR FROM CORROSION**

#### **PROPER CLEANING :**

In order to protect your car from corrosion it is recommended that you wash your car thoroughly and frequently in case :

1. There is an heavy accumulation of dirt and mud especially on the underbody.
2. It is driven in areas having high atmosphere pollution due to smoke, soot, dust, iron dust & other chemical pollutants.
3. It is driven in coastal areas.
4. The underbody must be thoroughly pressure washed after every three months.

In addition to regularly washing your car, the following precautions need to be taken.

#### **PERIODIC INSPECTION :**

1. Regularly inspect your car for any damage in the paint film such as deep scratches and immediately get them repaired from an Authorised Service Center, as these defects tend to accelerate corrosion.
2. Inspect mud liners for damages.
3. Keep all drain holes clear from clogging.

#### **PROPER PARKING :**

Always park your car in shade to protect it from harsh sunlight or in a well-ventilated garage so that there is no dampness on any part of the car.

#### **WASHING YOUR CAR :**

**Follow these tips while washing your car.**

#### **HAND WASH :**

1. Always wash your car in shade and when the surface is at room temperature.
2. Wash with mild car wash soap like "Car Shampoo" and use a soft 100% cotton cloth to avoid scratches. Please take help of your dealer to buy the right products.
3. Please be sure that you remove your wristwatch and wear soft gloves to avoid scratches due to finger rings or nails.
4. To remove stubborn stains and contaminants like tar, use turpentine or cleaners like "Stain Remover" which is safe for painted surfaces. Again your dealer can help you in selecting the right product.
5. Avoid substances like petrol, diesel, kerosene, benzene or other solvents that cause damage to paint.
6. Dry your vehicle thoroughly to prevent any damp spots.
7. Rinse all surfaces thoroughly to prevent any traces of soap and other cleaners as this may lead to the formation of stains on the painted surface later.

## MAINTENANCE & CAR CARE

## Car Care

### WAXING :

Waxing and polishing is recommended to maintain the gloss and wet-look appearance of your paint finish.

1. Use a good quality polish and wax for your car.
2. Re-wax your car when the water does not slip off the surface and collects over the surface in patches.

### Further tips for the care of your new INDICA finish :

We recommend that you do not use an automatic car wash as the stiff brushes or sponges could mar the finish and damage the surface of your car. Wash the vehicle by hand with cool and clean water using a soft cloth or sponge. Please do not use soap but a car shampoo recommended by your dealer.

### Please take the following precautions :

1. Always wash your car in shade, avoiding direct exposure to sunlight during washing.
2. Dry wiping your car may lead to the formation of scratches and hence always use a soft cloth and clean water while wiping your car.
3. Always keep your car parked in a well ventilated shade. Exposure to heat with entrapped moisture promotes corrosion.

4. Avoid driving on gravel roads, as the possibility of paint chip off due to the impact of stones is high. If you are driving on freshly tarred road, check immediately afterwards for any stains & clean them.
5. External contamination in the form of sap or industrial fall-out may mar or develop spots on a new finish. Hence avoid parking your car near trees, which are known to drop sap, or near factories, which give out heavy smoke.
6. The acid content in bird droppings may damage the newly painted finish and hence any bird dropping must be immediately washed off.
7. The paint finish is susceptible to damage in case petrol, brake fluid, liquid from car battery, oil, antifreeze, transmission fluid or windshield solvent spills onto the painted surface. In case of such a spillage immediately rinse the affected area with water. Avoid wiping the area far as possible, however if wiping is required, ensure that you wipe the area gently with soft cotton cloth.
8. Avoid using sharp objects to scrap off tar or mud from a painted surface as it may develop scratches or may peel off the paint.





## **EMERGENCY SERVICE TIPS**

- **ENGINE**
- **CLUTCH**
- **TRANSAXLE**
- **BRAKES**
- **STEERING SYSTEM**
- **ELECTRICAL**
- **SUSPENSION**

## EMERGENCY SERVICE TIPS

## Engine

These tips are given for your guidance. These preliminary jobs are to be carried out in an emergency. In normal cases the problems should be attended to in an **Authorised Service outlet** by following the repair procedures given in the Workshop Manual.

SR. NO.	PROBLEM OBSERVED	PROBABLE CAUSE	ACTION TO BE TAKEN
<b>ENGINE (LPG)</b>			
1.	Engine not cranking	Dead battery, loose or improper battery/electrical connections	<ul style="list-style-type: none"><li>• Get battery checked and/or changed</li><li>• Jump start using another battery</li><li>• Clean &amp; tighten connections</li></ul>
		Engine stop solenoid fuse blown	<ul style="list-style-type: none"><li>• Replace the fuse</li></ul>
2.	Engine overheats	Coolant level low, coolant leakages	<ul style="list-style-type: none"><li>• Check and correct leakages</li><li>• Top up coolant</li></ul>
		Hose collapsed/torn	<ul style="list-style-type: none"><li>• Get the hose replaced</li></ul>
		Low engine oil level	<ul style="list-style-type: none"><li>• Add oil</li></ul>
		Cap not sealing properly	<ul style="list-style-type: none"><li>• Fit the auxiliary water tank cap correctly</li></ul>
		A.C. condenser fan not working	<ul style="list-style-type: none"><li>• Get defect rectified</li></ul>
		Brakes binding	<ul style="list-style-type: none"><li>• Get defect rectified</li></ul>
		Electric fan not working	<ul style="list-style-type: none"><li>• Get defect rectified</li></ul>
		High delivery pressure in A.C. refrigerant circuit	<ul style="list-style-type: none"><li>• Get defect rectified</li></ul>
		Radiator fins clogged	<ul style="list-style-type: none"><li>• Clean it</li></ul>
		Radiator water passage clogged	<ul style="list-style-type: none"><li>• Get it rectified</li></ul>
		Thermostat defective	<ul style="list-style-type: none"><li>• Get it rectified</li></ul>

## EMERGENCY SERVICE TIPS

## Engine

SR. NO.	PROBLEM OBSERVED	PROBABLE CAUSE	ACTION TO BE TAKEN
3.	Poor pickup	Accelerator cable loose Air in the fuel system Clogged fuel filter Clogged air filter Clutch slipping/out of adjustment Brakes grabbing	<ul style="list-style-type: none"><li>• Get it adjusted correctly</li><li>• Remove the air</li><li>• Clean / Replace the element</li><li>• Clean / Replace the element</li><li>• Get it rectified</li><li>• Get it rectified</li></ul>
4.	Does not accelerate	Accelerator cable broken Fuel filter choked	<ul style="list-style-type: none"><li>• Get cable replaced</li><li>• Replace</li></ul>
5.	Belt squeal	Loose belt Belt glazed	<ul style="list-style-type: none"><li>• Get belt tension adjusted</li><li>• Get belt replaced</li></ul>
6.	Low engine oil pressure indicator 'ON' when engine is running even though engine oil level is within maximum/minimum marking	Pressure transducer faulty, and/or oil pump faulty	<ul style="list-style-type: none"><li>• Do not run the engine extensively. Take the car to the nearest Authorised Service outlet &amp; get the fault rectified</li></ul>
7.	Engine not cranking	Discharged battery, Loose or dirty battery connections.	<ul style="list-style-type: none"><li>• Get battery changed / charged</li><li>• Clean &amp; tighten battery connections</li></ul>
8.	Engine cranks but does not start	No fuel Fuel filter choked  Inertia Switch tripped off	<ul style="list-style-type: none"><li>• Get the unleaded fuel filled</li><li>• Get the fuel filter replaced</li><li>• Check fuse for fuel pump &amp; EMS</li><li>• Reset Inertia switch</li></ul>

## EMERGENCY SERVICE TIPS

## Engine, Clutch & Transaxle

SR. NO.	PROBLEM OBSERVED	PROBABLE CAUSE	ACTION TO BE TAKEN
9.	Check engine lamp continues to glow, even after start	Some faults are detected by the fuel injection & ignition system	<ul style="list-style-type: none"><li>• Get the vehicle checked and rectified at Authorised Workshop</li></ul>
<b>CLUTCH</b>			
1.	Clutch slipping	Improper pedal travel Rusted clutch cable Oil on clutch disc	<ul style="list-style-type: none"><li>• Adjust pedal travel</li><li>• Replace cable</li><li>• Clean or replace disc at Authorised Service outlet</li></ul>
2.	Noisy clutch	Pressure plate & diaphragm spring rattling  Release bearing broken/worn out Broken damper spring of clutch disc	<ul style="list-style-type: none"><li>• Get car attended to by Authorised Service outlet</li><li>• Replace</li><li>• Replace</li></ul>
<b>TRANSAXLE</b>			
1.	Gears slipping out of mesh	Worn/damaged grooves on shifter shaft Worn shift fork or synchroniser sleeve Weak or damaged detent springs Worn bearings on input shaft or layshaft Worn dog teeth on sleeve and gear	<ul style="list-style-type: none"><li>• Replace</li><li>• Replace</li><li>• Replace</li><li>• Replace</li><li>• Replace sleeve and gear</li></ul>
2.	Hard shifting	Inadequate lubricant Inadequate clutch pedal travel Distorted or broken clutch disc	<ul style="list-style-type: none"><li>• Replenish</li><li>• Adjust</li><li>• Replace</li></ul>

**EMERGENCY SERVICE TIPS****Brakes**

SR. NO.	PROBLEM OBSERVED	PROBABLE CAUSE	ACTION TO BE TAKEN
3.	Noise	Damaged clutch pressure plate Worn synchrocones Worn dog teeth on sleeve or gear Distorted shift shaft/Linkages Inadequate or insufficient lubricant Damaged or worn bearing(s) Damaged or worn gear(s) Damaged or worn synchroniser parts	<ul style="list-style-type: none"> <li>• Replace clutch cover/disc</li> <li>• Replace</li> <li>• Replace sleeve or gear</li> <li>• Replace</li> <li>• Replenish</li> <li>• Replace</li> <li>• Replace</li> <li>• Replace</li> </ul>
<b>BRAKES</b>			
1.	Poor brakes	Insufficient brake fluid Air in the system Pedal travel excessive due to excessive shoe gap Vacuum leakage Brake oil (line) leaking Oil on the drum/liners Worn brake lining Defective/worn parts	<ul style="list-style-type: none"> <li>• Get the brake fluid filled</li> <li>• Get the air removed</li> <li>• Rectify automatic adjuster</li> <li>• Rectify the leakage</li> <li>• Replace the leaking line</li> <li>• Get the liners cleaned/ Replace seals if leaking</li> <li>• Get the liners replaced</li> <li>• Get them replaced</li> </ul>
2.	Brake pulling to one side	Oil on the brake lining One side shoe/pad worn Loose brake anchor plate	<ul style="list-style-type: none"> <li>• Clean the brake lining</li> <li>• Get the shoe/pad replaced</li> <li>• Tighten the bolts</li> </ul>

**EMERGENCY SERVICE TIPS****Steering System**

SR. NO.	PROBLEM OBSERVED	PROBABLE CAUSE	ACTION TO BE TAKEN
3.	Brake Squeal	One side brake pipe clogged Defective tandem master cylinder  Defective brake lining Glazed lining Loose rivets. Wrong lining Shoe return spring broken Front pads rubbing on the disc	<ul style="list-style-type: none"><li>• Get the brake line cleaned</li><li>• Rectify/Replace tandem master cylinder</li><li>• Replace</li><li>• Clean or replace lining</li><li>• Install rivets properly</li><li>• Install correct lining</li><li>• Replace</li><li>• Get it corrected</li></ul>
<b>STEERING SYSTEM</b>			
1.	Hard steering (Mechanical)	Wheel alignment disturbed Rack & pinion need adjustment Low tyre pressure Grabbing of linkages	<ul style="list-style-type: none"><li>• Check &amp; adjust</li><li>• Check &amp; replace if necessary</li><li>• Adjust to correct value</li><li>• Check &amp; rectify</li></ul>
2.	Poor Returnability	Grabbing of linkages Steering gear disturbed	<ul style="list-style-type: none"><li>• Check &amp; rectify</li><li>• Check &amp; adjust</li></ul>
3.	Excessive play in steering	Rack & pinion attachment loose	<ul style="list-style-type: none"><li>• Get it tightened</li></ul>
4.	Hard steering (For power steering)	Less fluid in the power steering tank Air in the system  Loose pump belt Low tyre pressure	<ul style="list-style-type: none"><li>• Get the fluid topped up to the correct level</li><li>• Get the air removed by bleeding the system</li><li>• Get the belt correctly adjusted</li><li>• Adjust to correct value</li></ul>

## EMERGENCY SERVICE TIPS

## Electrical/Suspension

SR. NO.	PROBLEM OBSERVED	PROBABLE CAUSE	ACTION TO BE TAKEN
<b>ELECTRICAL</b>			
1.	Battery charge & engine oil pressure lamp in cluster not operating when key is in 'IGN' position	Battery terminal loose or disconnected Battery completely dead  Fuse blown Loose/open connections	<ul style="list-style-type: none"><li>• Check connections</li><li>• Get the battery properly connected</li><li>• Get the battery charged</li><li>• Get the alternator &amp; charging circuit checked</li></ul>
2.	Non functioning electrical accessories such as power windows, head lamps, fuel & temperature gauge, RPM meter, wiper & washer unit and all lamps etc.	Fuse blown in the circuit Loose connectors.  Circuit relay/controllers loose in the base Defective components	<ul style="list-style-type: none"><li>• Replace the fuse if blown</li><li>• Get the connection properly tightened/Fixed</li><li>• Fix the relay firmly</li><li>• Get the defective components replaced at an Authorised Service outlet</li></ul>
<b>SUSPENSION</b>			
1.	Abnormal or excessive tyre wear	Tyre out of balance  Steering geometry disturbed Tyres not adequately inflated	<ul style="list-style-type: none"><li>• Check balance and/or adjust if required</li><li>• Adjust steering geometry</li><li>• Adjust tyre pressure</li></ul>

**EMERGENCY SERVICE TIPS****Suspension**

SR. NO.	PROBLEM OBSERVED	PROBABLE CAUSE	ACTION TO BE TAKEN
		Wobbly wheel or tyre	• Replace wheel or tyre
		Defective tyre	• Replace tyre
		Hub play not proper	• Adjust hub play
		Brake grabbing	• Check and rectify
		Excessive braking	• Modify driving habit
2.	Abnormal noise from front end	Worn, sticky or loose tie rod ends, lower ball joints, tie rod in side ball joints or drive shaft joints	• Replace tie rod end, suspension arm, tie rod or drive shaft joints
		Warning noise for pad wear	• Replace pad
		Damaged struts or mounting	• Repair mounting or replace struts
		Worn suspension arm bushings	• Replace
		Loose wheel nuts	• Tighten wheel nuts
		Loose suspension bolts or nuts	• Tighten suspension bolts or nuts
		Broken or damaged wheel bearing	• Replace
		Poorly lubricated or worn strut bearings	• Lubricate or replace strut bearings
		Excessive hub play	• Adjust
		Loose caliper housing bolts	• Check & tighten
3.	Ride too soft / bumpy	Faulty struts	• Replace strut
4.	Suspension bottoms	Over loaded	• Check loading
		Faulty struts	• Replace struts





## **IMPORTANT INFORMATION**

- **AGGREGATE NUMBERS**
- **FUEL, COOLANTS & LUBRICANTS**
- **TECHNICAL SPECIFICATIONS**
- **SERVICE SCHEDULE**
- **CAR RECORD SHEET**

**LOCATION OF AGGREGATE NUMBERS**



**Chassis Number Plate**

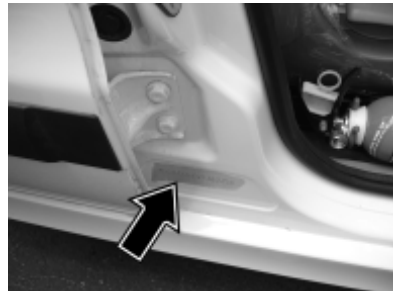

**Chassis Number Plate**

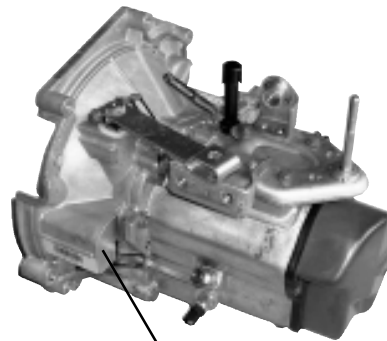

**Transaxle Number**



**Engine Number**

## IMPORTANT INFORMATION

### Vehicles with catalytic converter :

Unleaded regular grade petrol conforming to IS 2796-1994/ DIN 51607 (or equivalent) and RON not less than 87 is recommended to be used as fuel.



Do not use leaded petrol in a car fitted with catalytic converter. Even single fill of leaded petrol will seriously damage the catalytic converter.

### Lubricants : (Petrol)

**Engine oil :** Recommended grade of engine oil conforming to API-SF/CC specification and range of ambient temperature at which these can be used are given in the table below.

Ambient temp. in deg. C	Engine oil grade
-10 deg. & above	SAE 20W/40 or SAE 20W/50
-15 deg. to 40 deg.	SAE 15W/40 or SAE 15W/50
-20 deg. to 40 deg.	SAE 10W/40 or SAE 10W/50
-35 deg. to 40 deg.	SAE 5W/30

## Fuel, Coolants & Lubricants

### Filler Neck

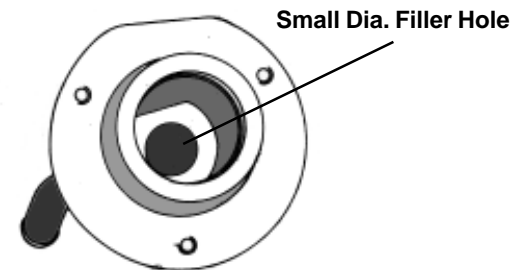

For Unleaded Petrol Version

## IMPORTANT INFORMATION

## Fuel, Coolants & Lubricants

---

**Brand names :**

As per chart given in the manual.

**Transaxle :**

Use recommended brand of EP 80 gear oil.

**Grease for axle bearings :**

Lithium base grease IPOL IPLEX LC Grease 2

**Brake fluid :**

IS 8654/DOT 3

**Power Steering :**

ATF Type A, Suffix A

**Coolants :**

Presence of dirt in the coolant chokes up passages in the radiator, cylinder head and cylinder block, thereby causing insufficient cooling of engine.

To prevent rust formation and freezing of coolant inside the passages of radiator, cylinder block and cylinder head, use branded premixed coolant (ready to use).

**IMPORTANT INFORMATION****Fuel, Lubricants & Coolants**

**PLEASE USE ONLY GENUINE ENGINE OILS, COOLANTS, LUBRICANTS, ANTI RUST & SOUND DEADENING COATS, WINDSCREEN SEALANT, ADHESIVES & FUEL ADDITIVES BRANDED BY TATA MOTORS FOR OPTIMUM PERFORMANCE OF YOUR TATA INDICA LPG...**

<b>ITEM</b>	<b>COMPANY</b>	<b>BRAND</b>	<b>QTY</b>
<b>ENGINE OIL</b>	CASTROL HPCL	Castrol GTX 20 W/40 HP ESMO 20 W/40	4.0 Litres
<b>COOLANT</b>	SUNSTAR HPCL	Golden Cruiser 1400 M HP Thanda Raja P	6 Litres
<b>TRANSMISSION OIL</b>	HPCL CASTROL	Gear Oil EP 80 Castrol Extreme Pressure 80 EP	3.3 Litres
<b>STEERING OIL</b>	HPCL CASTROL	HP ATF Castrol Transpower TQ	1.2 Litres
<b>BRAKE FLUID</b>	HPCL CASTROL	Super Duty Brake Fluid DOT-3 Castrol Universal Brake Fluid DOT-3	0.265 Litres
<b>HUB GREASE</b>	CASTROL	Castrol Grease AP2	
<b>ANTI RUST TREATMENT &amp; SOUND DEADENING</b>	DINITROL WUERTH	Dinitrol Wuerth	— —
<b>WIND SCREEN SEALANT</b>	ANCHEMCO	Terostat 8590 Kit Form	—
<b>METAL &amp; PLASTIC ADHESIVE</b>	ANCHEMCO	Terostat 930	310 ml Cartridge

## IMPORTANT INFORMATION

## Technical Specifications

### 1. ENGINE

<b>Model</b>	: Bi-fuel (MPFI) TATA 475 SI <sup>58</sup>
<b>Type</b>	: Water cooled, Bi-fuel (MPFI) Petrol Engine
<b>No of cylinders</b>	: 4 inline
<b>Bore/Stroke</b>	: 75 mm x 67.5 mm
<b>Capacity</b>	: 1193 cc
<b>Max. engine output</b>	: <b>Petrol</b> : 65 PS at 5000 rpm as per IS - 14599 <b>LPG</b> : 62 PS at 5000 rpm as per IS - 14599
<b>Max. Torque</b>	: <b>Petrol</b> : 102 Nm at 2600 rpm as per IS - 14599 <b>LPG</b> : 100 Nm at 2600 rpm as per IS - 14599
<b>Compression ratio</b>	: 10 : 1
<b>Firing order</b>	: 1-3-4-2

### 2. CLUTCH

<b>Type</b>	: Single plate dry friction diaphragm type
<b>Outside diameter of clutch lining</b>	: 190 mm
<b>Friction area</b>	: 285 sq.cm.

### 3. TRANSAXLE

	: Front wheel drive through constant velocity joints.
<b>Model</b>	: TA65-5 / 4.06 with overdrive
<b>Type</b>	: Synchromesh on all forward gears. Sliding mesh for reverse gear.
<b>No. of gears</b>	: 5 Forward, 1 Reverse
<b>Gear ratios</b>	: 1st - 3.64 2nd - 1.95 3rd - 1.27 4th - 0.88 5th - 0.714 Rev. - 3.58
<b>Final drive ratio</b>	: 4.06

## IMPORTANT INFORMATION

- Gear Shift : Floor mounted with International "H" pattern, with Fifth and Reverse inline. with interlock to prevent accidental engagement from 5th to reverse
- 4. REAR AXLE** : Non driven axle Independently suspended
- 5. SUSPENSION**
- Front : Independent, Lower wishbone, McPherson Strut type.
- Rear : Independent, Semi-trailing arm with coil spring mounted on hydraulic shock absorbers.
- Antiroll bar : At front

## 6. STEERING

- GL / GLE : 1) Manual Rack & Pinion Steering Gear with collapsible steering column
- Version
- GLS / GLG : 2) Hydraulic Power assisted Rack & Pinion Steering Gear with collapsible steering column
- Version
- Steering Wheel : 380 mm dia

## 7. BRAKES

- Service brakes : Dual circuit, diagonal split hydraulic brakes through tandem master cylinder.
- Front : 231 mm dia disc brake
- Rear : 180 mm dia drum brake
- Parking brake : Lever type, Console mounted, Cable operated mechanical linkages acting on rear wheels

## Technical Specifications

## IMPORTANT INFORMATION

## Technical Specifications

### 8. WHEELS & TYRES

Tyres	:	165/65 R13
Wheel rims	:	4.50 J x 13 stylised steel rims
No. of wheels	:	Front - 2 Rear - 2 Spare - 1

### 9. FUEL TANK

Capacity	:	37 litres (PETROL)
	:	31 litres (LPG)

<b>10. BODY</b>	:	Semi-mono Volume, Mini size 5 door hatch-back, steel monocoque body.
-----------------	---	--

### 11. ELECTRICAL SYSTEM

System Voltage	:	12 Volts -ve earth
Battery	:	12V, DIN 44
Alternator	:	12 V 90 Amps

### 12. PERFORMANCE

		(kmph)
Max. speed at rated :		140 (PETROL mode)
GVW		135 (LPG mode)

### 13. MAIN CHASSIS DIMENSIONS AS PER ISO:612 IN MM (Nominal) TOLERANCES AS PER INTEREUROPE STVZO

Wheel base	:	2400
Track front	:	1400
Track rear	:	1380
Front Overhang	:	785
Rear Overhang	:	490
Overall length	:	3675
Max. Width :		
Over body	:	1665
Over outer rear view mirrors in open condition:	:	1915
Overall height - unladen	:	1485
Min. turning circle dia	:	9.8 m
Min. turning clearance circle dia	:	10.2 m
Ground clearance - unladen	:	166



## **IMPORTANT INFORMATION**

## **Technical Specifications**

### **14. WEIGHT (kg) (TOLERANCE AS PER EEC 92/21)**

Complete Vehicle	For GL	1045
kerb weight as per	For GLE	1060
ISO : 1176 (with	For GLS	1065
sparewheel and tools )	For GLG/GLX	1070
Gross vwhicle weight	For GL	1445
	For GLE	1460
	For GLS	1465
	For GLG/GLX	1470
Pay load	For all	400

**15. PASSENGER CAPACITY** : 2 front + 3 rear

### **16. LUGGAGE SPACE**

Net inside loading space : 0.16 cubic metre  
upto rear seat backrest  
0.55 cubic metre  
upto front seat backrest  
when rear seat folded

## IMPORTANT INFORMATION

### Service Instructions

The Tata Indica has been manufactured to give you economical and trouble free performance. To achieve this please follow the instructions as stated.

**Your Car is entitled to four free services (labour only). The free service coupons are attached to the sales invoice. Please present these coupons to the servicing dealer while availing free services.**

- 1st free service** - At 1000-1500 km. OR 1 month whichever is earlier
- 2nd free service** - At 10000-10500 km. OR 12 months whichever is earlier
- 3rd free service** - At 20000-20500 km. OR 24 months whichever is earlier
- 4th free service** - At 30000-30500 km. OR 36 months whichever is earlier

All services other than free services are chargeable.

## Service Schedule

Servicing of the car can be done at any TATA MOTORS Authorised Dealer Workshop, TATA MOTORS Authorised Service Centre (TASC) or TATA MOTORS Authorised Service Point (TASP). The details of their locations are given in this manual.

Warranty claims can be settled by any Tata Motors Authorised Dealer for all failures, while all warranty claims excluding the consideration on the replacement of major aggregates, can be settled by any TASC which is authorised for handling warranty claims. TASPs will not handle warranty repairs.

## IMPORTANT INFORMATION

## Service Schedule

SR. NO.	OPERATION	FREQUENCY IN km	1000-1500	10000-10500	20000-20500	30000-30500	40000-40500	50000-50500	60000-60500	70000-70500	80000-80500	90000-95500	100000-100500
	<b>GENERAL</b>												
1.	Wash the vehicle & clean condenser fins	Every Service	•	•	•	•	•	•	•	•	•	•	•
2.	Check & top up fluids (if required) : Transaxle oil, coolant, Brake fluid, Battery Electolyte, Wind screen washer fluid, Power steering oil (if fitted)	Every Service	•	•	•	•	•	•	•	•	•	•	•
3.	Check fuel lines for leakages	10000		•	•	•	•	•	•	•	•	•	•
4.	Check rubber boots & bushes for damage	30000				•			•			•	
	<b>ENGINE ( LPG SYSTEM )</b>												
1.	LPG lines and joints (LPG leakage)	Every service	•	•	•	•	•	•	•	•	•	•	•
2.	Clean the LPG filter <b>First at 10000 km &amp; thereafter at every 20000 km</b>			•		•		•		•		•	
3.	Replace the LPG filter / Cartridge paper	20000			•		•		•		•		•
4.	Check saftey solenoid valve on vaporiser	10000		•	•	•	•	•	•	•	•	•	•
5.	Check pressure regulator for mountings, leakges,damages, proper functioning, Rectify if any	10000		•	•	•	•	•	•	•	•	•	•
6.	Replace the pressure regulator diaphragm	40000					•				•		
7.	LPG rail - check mountings,leakages -Rectify if any <b>First at 10000 km &amp; thereafter at every 20000 km</b>			•		•		•		•		•	
8.	Drain oil if any from regulator <b>First at 10000 km &amp; thereafter at every 20000 km</b>			•		•		•		•		•	
9.	Multifunction valve - Clean 'O' Ring & core Assy.	20000			•		•		•		•		•
10.	Multifunction valve - Replace	100000											•
11.	Check filler valve seals	100000											•

## IMPORTANT INFORMATION

## Service Schedule

SR. NO.	OPERATION	FREQUENCY IN km	1000-1500	1000-10500	20000-20500	30000-30500	40000-40500	50000-50500	60000-60500	70000-70500	80000-80500	90000-90500	100000-100500
<b>ENGINE ( PETROL SYSTEM)</b>													
1.	Clean air filter element ( more frequently for vehicle operating as TAXI )	10000		•	•	•	•	•	•	•	•	•	•
2.	Change engine oil and oil filter ( 10000 km OR 12 months whichever is earlier)	10000		•	•	•	•	•	•	•	•	•	•
3.	Change fuel filter	10000		•	•	•	•	•	•	•	•	•	•
4.	Check all drive belts for tension, adjust if necessary	10000		•	•	•	•	•	•	•	•	•	•
5.	Check timing belt, adjust tension if necessary, replace if defective	20000			•		•		•		•		•
6.	Replace air filter element ( more frequently for vehicle operating as TAXI )	40000					•				•		
7.	Change coolant ( 40000 km OR two years whichever is earlier)	40000					•				•		
8.	Replace timing belt	100000											•
9.	Replace Spark Plug (MPFI)	30000				•			•			•	
<b>TRANSAXLE</b>													
1.	Change Transaxle oil	20000			•		•		•		•		•
<b>BRAKES</b>													
1.	Check front brake pads and rear brake linings. Replace if necessary	20000			•		•		•		•		•
2.	Replace brake fluid (OR 2 years whichever is earlier) and check brake system components for leakages	40000					•				•		
<b>WHEELS AND TYRES</b>													
1.	Rotate tyres	20000			•		•		•		•		•
<b>FRONT &amp; REAR SUSPENSION</b>													
1.	Check and adjust wheel alignment	20000			•		•		•		•		•
<b>STEERING</b>													
1.	Repalce power steering oil	80000									•		

## IMPORTANT INFORMATION

## Service Schedule

SR. NO.	OPERATION	FREQUENCY IN km	1000-1500	10000-10500	20000-20500	30000-30500	40000-40500	50000-50500	60000-60500	70000-70500	80000-80500	90000-95500	100000-100500
	<b>ELECTRICAL</b>												
1.	Check specific gravity of battery electrolyte (10000 kmOR Every 6 months)	10000		•	•	•	•	•	•	•	•	•	•
2.	Check headlamp focussing	30000				•			•			•	
	<b>A.C. SYSTEM</b>												
1.	Check air-conditioning / HVAC system for satisfactory performance	Every Service	•	•	•	•	•	•	•	•	•	•	•

**IMPORTANT INFORMATION****Service Schedule**

Date	Km. reading	Fuel filled	Fuel consumption	Remarks / Complaints

**IMPORTANT INFORMATION**

**Service Schedule**

Date	Km. reading	Fuel filled	Fuel consumption	Remarks / Complaints

### IMPORTANT INFORMATION

Recommended Service	Date	Odometer reading km.	Repair Order No.	Servicing Dealer's Signature & Stamp
At km.				
PDI Free Labour				
1,000 *				
10,000 *				
20,000 *				
30,000 *				
40,000				
50,000				
60,000				
70,000				
80,000				

### Record of Services Performed

Recommended Service	Date	Odometer reading km.	Repair Order No.	Servicing Dealer's Signature & Stamp
At km.				
90,000				
1,00,000				
1,10,000				
1,20,000				
1,30,000				
1,40,000				
1,50,000				
1,60,000				
1,70,000				
1,80,000				

\* Labour free, material chargeable



**Record of Warranty repairs carried out**

**Chassis No.** \_\_\_\_\_

Date	Odometer reading (km)	Repair Order No.	Particulars of Repair	Servicing Dealer's Signature & Stamp

**Record of Warranty repairs carried out**

**Chassis No.** \_\_\_\_\_

Date	Odometer reading (km)	Repair Order No.	Particulars of Repair	Servicing Dealer's Signature & Stamp



**LIST OF LPG FILLING STATION**



## LIST OF LPG FILLING STATIONS

### ASSAM

#### Guwahati

1. Indian Oil Corporation Ltd. (IOCL) Dealer : Kishore & Co. Adabari, Guwahati-12  
Phone: 0361-2571490 / 98864027833

#### GOA

2. Elf Gas India Ltd. Dealer: West Coast Auto LPG Station NH-4A, By-pass, Bainguinim Village, Tiswadi (Ihas) Taluk, Old Goa.  
Phone: 9326106875

### MAHARASHTRA

#### Ahmednagar

3. Indian Oil Corporation Ltd. (IOCL) Dealer : Om Matoshri Petroleum, Nagar-Pune Road,  
Phone: 0241-2322971

#### Nagpur

4. Reliance Industries Ltd. (RIL) Dealer: Reliance Industries Ltd. (RIL) Survey no. 104/2, Village Bothli, PO Butibori, NH-7, Wardja Road, Nagpur.  
Phone: 07104-329468
5. Company: Vanaz Engineers Limited. Dealer: Maa Sharda Auto LPG Station Plot no. 1, Manewada Square, Ullas Nagar, Ring Road, Nagpur-440 027  
Phone: 712-2731964 / 9823026860 / 9370022110

6. Hindustan Petroleum Corporation Ltd. (HPCL) Dealer: Kamal Lubes MIDC, Butibori, Nagpur
7. Vanaz Engineers Limited. Dealer: Transwell Automall Plot no. 35 A, Babulban, Old Bagadganj Road, Nagpur - 440 008  
Phone: 0712-2708439 / 3268439 / 9823011639
8. Indian Oil Corporation Ltd. (IOCL) Dealer: Gargi Automobiles Yerla Islampur
9. Aegis Logistics Ltd. Dealer: Aegis Logistics Ltd. 920, Peth-Sangli Road, Ashta Naka, Urun, Islampur-415 409, Tal. Walwa, Dist. Sangli

#### Khedshivapur

10. Reliance Industries Ltd. (RIL) Dealer: Reliance Industries Ltd. (RIL) Survey no. 542 & 543, Post -Kelawade Chainage, No. 813/200, At Village, -Kelawade, Taluka-Bhor, Dist-Pune.  
Phone: 02113-284785

#### Bhayander

11. Company: Reliance Industries Ltd. Dealer: Reliance Industries Ltd. Old survey no. 365, New Survey no. 71, H. No. 1,7, 21 , Bhayander-401 101.  
Phone: 022-65143056

#### Amreli

12. Vanaz Engineers Limited Dealer: Shree Ganesh Petroleum 16,17,18, Varsada road, Near Utsav Garden Restaurant, PO Ishvariya, Dist. Amreli.  
Phone: 02792-240888 / 9824055333

#### Mumbai

13. Hindustan Petroleum Corporation Ltd. (HPCL) Dealer: Lachmandas Service Stn. S.V. Road, Irla, Ville Parle (W), Mumbai  
Phone: 022-26713698
14. Hindustan Petroleum Corporation Ltd. (HPCL) Sakinaka Petroleum Services, Kurla Andheri Rd, Next to Bank of Baroda, Sakinaka, Mumbai-400 072  
Phone: 022-28506025
15. Hindustan Petroleum Corporation Ltd. (HPCL) Baxi Singh & Co. Next to Kalpana Cinema, Lal Bahadur Sashtri Margh, Kurla West, Mumbai- 400 070  
Phone: 022-25038468, 25039865
16. Bharat Petroleum Corporation Ltd. (BPCL) Manhas Auto Acharya Done Marg (King Edward Road), Sewree, Mumbai-400 015  
Phone: 022-24131240
17. Bharat Petroleum Corporation Ltd. (BPCL) Chedda Service Station, Shastri Marg, Mulund, Mumbai-400 080  
Phone: 022-25681548

## LIST OF LPG FILLING STATIONS

18. Bharat Petroleum Corporation Ltd. (BPCL) Auro Petroleum 305, Sion Trombay Road, Nr Diamond Garden, Chembur, Mumbai-400 071  
Phone: 022-25575337
19. Bharat Petroleum Corporation Ltd. (BPCL) Famous Auto Swami Vivekanand Road, Kapadia Baug, Plot No.1, Survey No. 7, Borivli (W), Mumbai- 400 092  
Phone: 022-28053849
20. Indian Oil Corporation Ltd. (IOCL) Raj Auto Near Juhu Airport, SV Road, Mumbai  
Phone: 022-26133700
21. Indian Oil Corporation Ltd. (IOCL) Poonam Auto Opp Reliance Park, Nr Suman Nagar, Sion Trombay, Chembur  
Phone: 022-25282052
22. Indian Oil Corporation Ltd. (IOCL) Joquium Petroleum Deonar Mumbai  
Phone: 022-25569948
23. Indian Oil Corporation Ltd. (IOCL) Intel Corporation, Sahar Airport, Andheri (E)  
Phone: 022-26829353 / 26829247 / 26828353
24. Indian Oil Corporation Ltd. (IOCL) Asha Auto Kurla, Mumbai  
Phone: 022-26505338
25. Hindustan Petroleum Corporation Ltd. (HPCL) Hind Automobiles, 29, Sewri Vadala Road, Near Arora Cinema, Kings Circle, Mumbai-400 019  
Phone: 022-24096544
26. Hindustan Petroleum Corporation Ltd. (HPCL) Chaman Automobiles, 277, Reay Road, Opp Dock Yard Road, Railway Station, Mumbai-10  
Phone: 022 - 23717925
27. Hindustan Petroleum Corporation Ltd. (HPCL) Cadel Auto Cadel Auto, Opp. Shivaji Park, Dadar, Mumbai  
Phone: 022 -24453191, 24467829
28. Hindustan Petroleum Corporation Ltd. (HPCL) Automobile Resort, Sion Trombay Road, Deonar, Mumbai - 88  
Phone: 022-25580869 / 25558102
29. Bharat Petroleum Corporation Ltd. (BPCL) Taj Automobiles 96, Lamington Road, Bhadkamkar Road, Mumbai-07  
Phone: 022-23084015
- Dhule**
30. Hindustan Petroleum Corporation Ltd. (HPCL) SSP S. Sethi & Bros. Agra Road, Dhule, Maharashtra
31. Aegis Logistics Ltd. Gat no. 322/2, Opp. Abhay Yuva College, NH 3, Mumbai-Agra Highway, Dhule-424 001
- Ulhasnagar**
32. Reliance Industries Ltd. (RIL), DMK Ent., Plot no. 3, Sheet no. 30, Vithalwadi Station Road, Opp. Ramgirdhar Indl. Estate, Dist. Ulhasnagar  
Phone: 0251-3257934
- Kalyan**
33. Reliance Industries Ltd. (RIL), Kalyan Bhiwandi Road, Village: Kon, Kalyan  
Phone: 025522-2645309
- Khopoli**
34. Reliance Industries Ltd. (RIL), Village Hal Budrak, Taluka Khalapur, Old NH-4, (Mumbai-Pune), Kopholi  
Phone: 01292-320131
- Rahata**
35. Reliance Industries Ltd. (RIL), Survey no. 229 (P), Nagar Manmadd RD Village, Pimplas, Rahata, Dist. Ahmednagar  
Phone: 02423-329500
- Jalgaon**
36. Vanaz Engineers Limited. Shree Auto LPG Pumps Ghat no. 2, NH- no. 6, Nashirabad, Jalgaon-Bhusaval Road, Jalgaon  
Phone: 0257-2232612 / 5623146
37. Aegis Logistics Ltd., Gate no. 88, Chincholi Shivar Ajanta Road, Jalgaon-425 003  
Phone: 9827258690

## LIST OF LPG FILLING STATIONS

### Yavatmal

38. Reliance Industries Ltd. (RIL), 54/1, Pobaru Layout, Pandharawada Road, Yavatmal  
Phone: 07232-329365

### Nasik

39. Bharat Petroleum Corporation Ltd. (BPCL) Cidco Taj  
40. Reliance Industries Ltd. (RIL) Nasik-VI Survey no. 207/6C/7, Plot no. 6+7A, At Village - Mhasrul, Taluka - Nasik  
Phone: 0253-2532408  
41. Reliance Industries Ltd. (RIL), Anandwalli Shah Road, Satpur, Nasik-422 007  
Phone: 0253-2355778  
42. Company: Hindustan Petroleum Corporation Ltd. (HPCL) Dealer: Bela Auto Services Dwarka Circle, Nasik  
Phone: 0253-2591514 / 3092522

### Pune

43. Indian Oil Corporation Ltd (IOCL) Dealer: Indian Oil Tirupati Petroleum, Nasik - Pune Road, Pune.  
44. Hindustan Petroleum Corporation Ltd. (HPCL) Bhosale Petroleum, Chikhali, Near Tata Indica Plant, Pune  
Phone: 9822041392

45. Vanaz Engineers Limited. Choudhari's Auto LPG Gas Station S.No. 130/4/1/1, on Mumbai-Bangalore By-pass service Road, Warje, Pune - 411 058  
Phone: 9371124136  
46. Indian Oil Corporation Ltd. (IOCL) Ganga Auto, Hadapsar  
47. Indian Oil Corporation Ltd. (IOCL) D' Mello S/Stn.46, Nagar Road, Pune-14  
Phone: 020-27031728  
48. Hindustan Petroleum Corporation Ltd. (HPCL) Shivaji Service Station Manjari, Pune  
Phone: 020-26993479  
49. Hindustan Petroleum Corporation Ltd. (HPCL) A.J. Modi & Sons, 206, Wellesly Road, Mangalwar Peth, Pune -11  
Phone: 020-26054020  
50. Bharat Petroleum Corporation Ltd. (BPCL), BP-Pune 1, Near RTO Office, Wellsely Road, Pune-1  
Phone: 020-26059756  
51. Hindustan Petroleum Corporation Ltd. (HPCL) Sangoi Service Station 1, 160, Ganeshkind Road, Opp, Rahul Theatre, Shivaji Nagar, Pune- 411 005  
Phone: 020-25535651 / 25533573  
52. Bharat Petroleum Corporation Ltd. (BPCL) Saraswati Auto, Shankarshet Rd, Pune- 1  
Phone: 020- 24441238 / 5264

53. Hindustan Petroleum Corporation Ltd. (HPCL) Swami Samath Enterprises Pune Nasik Road, Bhosari, Pune

### Ichalkaranji

54. Aegis Logistics Ltd. Plot no. 45, Station Road, Ichalkaranji-416 115

### Chandrapur

55. Hindustan Petroleum Corporation Ltd. (HPCL) OM Traders, Padoli, Chandrapur, Maharashtra

### Aurangabad

56. Vanaz Engineers Limited Shri Ram Auto LPG Pump, Gat No.393, Sundarwadi, Jalna Road, Aurangabad 431001.  
Phone: 0240-2100217/9422202669/09960002255

### Miraj

57. Reliance Industries Ltd. (RIL) Suyash Petroleum, Miraj-Sangli Road, Tal-Miraj, Dist. Sangli  
Phone: 0233-3207172 Navi Mumbai.  
58. Reliance Industries Ltd. (RIL) Plot No. 7, Sector-18, Off Palm Beach Road, Besides Full Stop Mall, Sanpada, Navi-Mumbai  
Phone: 9820008753, 022-65141745  
59. Indian Oil Corporation Ltd. (IOCL) Vashi Petroleum Sector-17, Vashi, Navi Mumbai  
Phone: 022-2767079

## LIST OF LPG FILLING STATIONS

60. Hindustan Petroleum Corporation Ltd. (HPCL)Subham Auto, Plot no. 8, Sector -4A,Koperkhairane, Navi Mumbai  
Phone: 022-27552175 / 56161285

61. Hindustan Petroleum Corporation Ltd. (HPCL)Shree Om Sai Auto Care Station, P/130, TTC, MIDC Village-Digha, Navi Mumbai- 400 708  
Phone: 022-25401998 / 25397618

62. Hindustan Petroleum Corporation Ltd. (HPCL)Gain Auto, PlotPlot No. 15, Sector -25, Nerul, Navi Mumbai  
Phone: 022-27718052

### Thane

63. Indian Oil Corporation Ltd. (IOCL) Royal Auto, Kalyan-Bhiwandi Road, Village Ranjivileegove  
Phone: 9820066866 - Mr. Raju

64. Indian Oil Corporation Ltd. (IOCL) Anjur S/ Stn.Village Dapode, Bombay-Agra, NH-3, Bhiwandi-421 303  
Phone: 022-65850596 / Mr. Shukla

65. Hindustan Petroleum Corporation Ltd. (HPCL)Hind Automobiles, Wada Road, Shellar, Bhiwandi, District Thane  
Phone: 02522-244900

### Vasai

66. Reliance Industries Ltd. (RIL) Survey no. 235 & 241, Village Palhar, NH-8, Tal Vasai, Dist. Thane  
Phone: 9890036371

### Kolhapur

67. Aegis Logistics Ltd. 1/K , NH-4,Sarnobatwadi, Tal. Karveer, Dist. Kolhapur

68. Reliance Industries Ltd. (RIL) Survey no. 335 & 336/1, Kasabe Vadgaon, NH-4, Tal. Hatkangale, Dist. Kolhapur  
Phone: 9422605905 , 0230-6450102

69. Bharat Petroleum Corporation Ltd. (BPCL)Dealer: Konduskar AutoShivaji Vidyapeeth Road, 12th Lane, Rajarampuri, Taluka Karvir

### Satara

70. Vanaz Engineers Limited.Gourav Auto LPG Pump, Gut no. 268/1A/1 of Village, Taluka Karad, Dist. Satara  
Phone: 02162-233957 / 237857 / 9822006474 / 9822755858

71. Vanaz Engineers Limited. Madhavrao Auto LPGS. no. 44/1A, A/P, Govare Village, Taluka Karad, Dist. Satara  
Phone: 02164-271392 / 9890362783

### Ratnagiri

72. Aegis Logistics Ltd. Sr. no. 395, Hissa no. 1/3/3, Opp. Ganesh Colony, MIDC, Sawant Estate, Hatkhamba-Ratnagiri Highway, Ratnagiri- 415 639  
Phone: 9825244070

### Solapur

73. Aegis Logistics Ltd.T.P.N.o. 4, Final Plot no. 56, Plot no. 21 & 22, Budhwar Peth, Near Old Pune Naka, Solapur-413 002  
Phone: 02164-271392/ 9890362783

## GUJARAT

### Gandhinagar

74. Hindustan Petroleum Corporation Ltd. (HPCL)Yogi Petroleum, NH-8C, Sarkhej, Gandhinagar Highway, Gandhinagar  
Phone: 079-23234583

75. Vanaz Engineers Limited.Shreeji Auto LPG, Block no 195/37, Dhanap, Dist. Gandhinagar  
Phone: 9825563816

76. Vanaz Engineers Limited. Riddhi GasE-19/10, Electronic Zone, GIDC Sector 26, Near K7, Gandhinagar,  
Phone: 9825328331/ 079-23244321/ 09925041331

### Baroda

77. Reliance Industries Ltd.(RIL)Baroda Express Way, Survey No. 437,438,439, 431 & 418 at Village Poicha,Taluka Savli, Dist. Baroda, Poicha- 3911780  
Phone: 02692-325502

78. Reliance Industries Ltd.(RIL)Hightension Road, SubhanpuraBaroda- 390023  
Phone: 0265-3255039

## LIST OF LPG FILLING STATIONS

### Ahmedabad

79. Indian Oil Corporation Ltd.(IOCL) Dhanalxmi Petroleum Near Sanghvi High School, Vijaynagar  
Phone: 079-27456878
80. Hindustan Petroleum Corporation Ltd.(HPCL) HP Auto Care Centre, T & E Station, Bodakdev, Near Satyagrah Chhavani, Bodakdev, Ahmedabad
81. Reliance Industries Ltd.(RIL) Sardar Patel Ring Road, Bhopal , Ahmedabad  
Phone: 02717-234303
82. Indian Oil Corporation Ltd.(IOCL) Shreenathji Auto Point, Rakhial, Ahmedabad  
Phone: 079-30980612
83. Reliance Industries Ltd.(RIL) Opp. Old Nirma Bharat Bobbin, Garibnagar Char Rasta, Rakhia, Ahmedabad-380 021  
Phone: 079-32988766
84. Reliance Industries Ltd.(RIL) Near Anand Bus Stand-Satellite, Vejalpur, Ahmedabad  
Phone: 079-26930770
85. Reliance Industries Ltd.(RIL) NH-8 (Narol-Naroda), Isanpur, Ahmedabad  
Phone: 079-25735733
86. Hindustan Petroleum Corporation Ltd.(HPCL) HP COCO Rakhial, Ahmedabad  
Phone: 079-2773072

87. Hindustan Petroleum Corporation Ltd.(HPCL) Jasbhai Patel & Co., Opp. Halim Khadki, Shahpur, Ahmedabad  
Phone: 079-25623246
88. Bharat Petroleum Corporation Ltd.(BPCL) Agarwal Automobiles, Sabarmati-Chandkheda Road, Opp. ONGC, Sabarmati, Ahmedabad-5  
Phone: 079-27501479 / 9879584170
89. Reliance Industries Ltd.(RIL) Naranpura, 132 ft. Road, Ahmedabad- 380 013  
Phone: 079-32985885
90. Indian Oil Corporation Ltd (IOCL) Sharda Petroleum Highway Road, Chandkheda, Ahmedabad - 382 424  
Phone: 079-23298022/ 23296777 / 232913777/ 9824387777
91. Indian Oil Corporation Ltd (IOCL) Sainik Seva Services 132 Ft. Ring Road, Near Ashwamegh Bunglows Satellite, Ahmedabad-380 015  
Phone: 079-26924842 / 9227214842
92. Indian Oil Corporation Ltd (IOCL) Rashtriya Petroleum Behrmpura, Opp.ST Workshop, Ahmedabad-380 022  
Phone: 079-25323576 / 2532357
93. Indian Oil Corporation Ltd (IOCL) Shree Gokulesh Petroleum NH 8 , Opp. Transport Nagar, Near Narol Circle, Ahmedabad-382 405  
Phone: 079-25712370/1922 / 9824021861

94. Bharat Petroleum Corporation Ltd.(BPCL) Neelu Motors, Ashram Road, Nava Wadaj, Ahmedabad- 13  
Phone: 079-27553660 / 9824161069

### Mehsana

95. Reliance Industries Ltd. (RIL) Mehsana-Ahmedabad Highway, Village: Nagalpur, Mehsana  
Phone: 02762-324009
96. Aegis Logistics Ltd. Block no.199/2/P, Village Heduva-Hanumant, Besides Hotel Janpath, Opp. ONGC Palavasna, Dist. Mehsana  
Phone: 0452-3203859

### Navsari

97. Aegis Logistics Ltd..Survey No. 989, Itarawa, Navsari-396 424

### Deesa

98. Reliance Industries Ltd. (RIL) Survey no. 27/A/2, Near Vishwakarma Temple, Deesa - Radhanpur Highway, Deesa - 385 535  
Phone: 02744-645519

### Vadodara

99. Aegis Logistics Ltd. Survey no. 60, Sayajipura, Near Kamla Nagar, Ajwa Road, Vadodara-390 019
100. Indian Oil Corporation Ltd. (IOCL) Omkar Petroleum Subhanpura  
Phone: 0265-2399294



## LIST OF LPG FILLING STATIONS

### Ankleshwar

101. Reliance Industries Ltd. (RIL) Gujarat Cable Company Compound, Old NH 8, Ankleshwar  
Phone: 02646-320777

### Surendranagar

102. Indian Oil Corporation Ltd. (IOCL) Servo Point, 105 A, GIDC, Wadhwan City  
Phone: 02752-241140

### Rajkot

103. Vanaz Engineers Limited. Vachhraj Petroleum, Plot no. 17, 18 & 19, Jamna Nagar Vanari (Virpur) Tal. Ranavav, Dist. Porbandar-Rajkot  
Phone: 2214331 / 98242270000
104. Vanaz Engineers Limited. Laxmi Auto LPG, S.No.151 (part), At Village: Pithadiya, on NH-8B, Opp.GEB Stn, Dhareshwar, Tal:Jetpur, Dist - Rajkot  
Phone: 987981544
105. Vanaz Engineers Limited. Dhaka Enterprises Auto LPG, S.No. 239, P2 Atkot, On Rajkot-Bhavnagar State Highway no. 25, Near Hotel Taj, Tal. Jasdan, Dist. Rajkot  
Phone: 9825244070
106. Reliance Industries Ltd. (RIL) Reliance Petro Marketing Pvt Ltd, NH-8, Ahmedabad- Rajkot Highway, Near Toll Plaza, Moti Moldi, Taluka Chotila  
Phone: 9374119402

107. Reliance Industries Ltd. (RIL), RIL Retail Outlet Near Dhakan Hospital, Kuvadva Road, Rajkot- 360 002  
Phone: 0281-2455780
108. Aegis Logistics Ltd. Patel Estate, Plot no. 24/25, Morbi-Rajkot Highway, At Post Virpar, Tal. Tankara, Dist. Rajkot-363 650  
Phone: 0233-3207172
109. Indian Oil Corporation Ltd. (IOCL) Balahi S/Stn. 80 ft. Ring Road, Sorathiyawadi  
Phone: 0281-2224830

### Junagarh

110. Vanaz Engineers Limited. Reliable Auto Gas Filling Pump, Plot no. 1 & 2 Part, R.S. no. 35/6, Rajkot Highway, Dist. Junagarh  
Phone: 0285-2661316 / 94269157777 / 5541935
111. Vanaz Engineers Limited. Aum Corporation Auto LPG Gas Station, At Plot No. 51, Near By Marketing Yard Junagarh Highway, Keshod Dist - Junagadh 362220  
Phone: 09924496699/09825635241 0287-1233699

### Bavla

112. Aegis Logistics Ltd. Plot no. 819/P, NH-8A, At Rajoda-Bavla, Tal. Bavla, Dist. Ahmedabad-382 220

### Bhavnagar

113. Aegis Logistics Ltd. Plot no. 5, to 10, Opp. Akhlol Octroi Naka, Bhavnagar-Rajkot Road, Bhavnagar-364 002

### Anand

114. Vanaz Engineers Limited, Ganesh Auto LPG, Survey no 502+501/ IP, Baroda Bagodara road, Tarapur chowkdi, Tarapur, Dist Anand  
Phone: 02698- 256807

### Naidad

115. Reliance Industries Ltd. (RIL) Survey no. 515, Near Dabhan Bus Station, National Highway no. 8, Tal. Nadiad, Dist Kheda  
Phone: 0268-3291351

### Dahod

116. Aegis Logistics Ltd. Plot No. 206, Nani Sarsi, Dahod Kasba, NH-59, Near Muvaliya Farm, Dahod- 389151

### Dharmaj

117. Reliance Industries Ltd. (RIL) Survey no. 2405, Straight Highway 8, Milestone 6, Village Dharmaj, Tehsil Petlad, Dist. Anand  
Phone: 0269-7245958

### Vijapur

118. Aegis Logistics Ltd. Survey no. 32/P, Himmatnagar-Vijapur Highway, Opp. Suraj Dairy, At Vijapur, Tal. Vijapur, Dist. Mehsana-382 870

## LIST OF LPG FILLING STATIONS

### Sabarkantha

119. Vanaz Engineers Limited.Tirupati Petroleum, Ambiliyar, Ahemdabad State Highway, Bayad, Dist - Sabarkantha  
Phone: 91-9426013692 / 9825590436
120. Vanaz Engineers Limited. Patang Auto LPG Pump, Plot no. 140/3, Sapawada Tal Idar, Dist. Sabarkantha  
Phone: 02778-253105 / 9427687075
121. Vanaz Engineers Limited.Riddhi Gas Petro Pvt. Ltd., Block no. 862/2/P, Sayra Modasa, Modasa, Dist. Sabarkantha  
Phone: 9898769944
122. Vanaz Engineers Limited. Dhvanish & Devang Petro Pvt. Ltd. Block no. 293/P, Near Sabar Dairy , NH-8, At-Post-Hajipur, Himmatnagar, Dist. Sabarkantha- 383 001  
Phone: 02772-396464 / 9825611308 / 226464

### Surat

123. Aegis Logistics Ltd.Phone: T.P.no.21, F.P.no. 63, Opp. Navin Fluorine Industrial, Surat-Navsari Road, Bhestan
124. Indian Oil Corporation Ltd. (IOCL) Swati Petroleum, FP no. 150 , TP no. 5, (Umra North), Ichchanath, Surat- 395 007  
Phone: 2253748 / 2254282 / 9824151909
125. Vanaz Engineers Limited.Roshni Corporation Plot no. 4, Block no. 160, Mouse Sarthana Village, Taluka Kamerj, Surat , Phone: 0261-2572255

126. Vanaz Engineers Limited. Shri OM Sai Auto LPGAt Post Barasadi, Tal Palsana, NH-6, Kadodara-Bardoli Road, Barasadi, Dist. Surat-394 310  
Phone: 02622-222203 / 9825170775 / 2622-255199
127. Vanaz Engineers Limited. Drasti Group Filling Station, N.H. 6, Near Nandida (namdurbar), Char Rasta, Block no. 56, Tal Bardoli, Dist. Surat  
Phone: 02622-228110 / 9824128639 / 9426746159
128. Reliance Industries Ltd. (RIL)NH-8, RS no. 149-152, Kim Char Rasta, Mangrol  
Phone: 02621-329940
129. Company: Reliance Industries Ltd. (RIL)Dealer: Reliance Industries Ltd. (RIL)Opp. SVR College,Piplod, Surat-395 007Phone: 0261-3204353

### Jamnagar

130. Vanaz Engineers Limited.Radhika Petroleum Agency, Survey no. 48/P, Ambika Bhuvan, Rajkot-Jamnagar Highway, Jamnagar  
Phone: 0288-2550999 / 9824228232 / 2570444
131. Reliance Industries Ltd. (RIL)Plot no. 16 (City survey 6235 & 6236), Jamnagar City- 361 008  
Phone: 0288-2710178 / 9228002414

## KERALA

### Alwaye

132. Auto Gas Energy India Ltd.Dealer: Auto Gas Energy India Ltd., N.H.Road, Alwaye

### Allappuzha

133. Indian Oil Corporation Ltd.(IOCL) Chandra's, Kerala

### Sulthan Bathery

134. Auto Gas Energy India Ltd.Chulliyode Road, Sulthan Bathery

### Changaramkulam

135. Auto Gas Energy India Ltd.N.H.Road, Changaramkulam

### Chenganassery

136. Reliance Industries Ltd. (RIL)Survey no. 32/5 & 32BA, Plot no. 6.7.8, Chenganassery, Dist. Kottayam  
Phone: 0481-3259444

### Kanjirappally

137. Auto Gas Energy India Ltd.K.K.Road, Kanjirappally

### Perumbavoor

138. Indian Oil Corporation Ltd. (IOCL), Baby Verghese Trincole  
Phone: 0484-2523247 / 9847042516
139. Auto Gas Energy India Ltd.M.C. Road, Perumbavoor

## LIST OF LPG FILLING STATIONS

### Nileshwar

140. Indian Oil Corporation Ltd. (IOCL) NGM Prabhu, NH-17, Nileshwar  
Phone: 0467-2280636 / 9447090636

### Perumthuruthy

141. Indian Oil Corporation Ltd. (IOCL) J & J Auto Fuels MC Road, Perumthuruthy, P.O. Thiruvalla, Dist. Pathanmthitta  
Phone: 0469-2645850 / 9847031646

### Harippad

142. Auto Gas Energy India Ltd. Mavelikkara Road, Harippad  
143. Indian Oil Corporation Ltd. (IOCL) Ashoka Fuels Harippad

### Kodimatha

144. Indian Oil Corporation Ltd. (IOCL) Malyalam Fuels, MC Road, Kodimatha, Kottayam-686 039  
Phone: 0481-3090848 / 9447897359

### Challakudy

145. Indian Oil Corporation Ltd. (IOCL), KA Kumaran & Co

### Mannarkad

146. Indian Oil Corporation Ltd. (IOCL) Srikrishna Petroleum

### Muttathara

147. Indian Oil Corporation Ltd. (IOCL) Simi's Fuel, NH Bypass, Trivandrum-8  
Phone: 2456111 / 2317111

### Kottarakara

148. Indian Oil Corporation Ltd. (IOCL) Raddission Fuels MC Road, Pulamon, Kottarakara, Quilon  
Phone: 0474-2652393 / 9447270190

### Palakkad

149. Reliance Industries Ltd. (RIL) Kalamadapm, Kozhikode Bypass Road, Manali, Palakkad-678 001  
Phone: 0491-3251700

### Thodupuzha

150. Auto Gas Energy India Ltd. Muvattupuzha Road, Thodupuzha

### Tripunithra

151. Reliance Industries Ltd. (RIL), EVS Fuels, 30/1084 A, Tripunithra Road, Thykoodam Vytilla, Cochin- 682 019  
Phone: 04822-6462498

### Trivandrum

152. Indian Oil Corporation Ltd. (IOCL) Dealer: Happy Fuels Pallichal  
Phone: 0471-2390232

### Ernakulam

153. Bharat Petroleum Corporation Ltd. (BPCL) Thazhekattu Fuels, Ernakulam  
154. Hindustan Petroleum Corporation Ltd. (HPCL) Kwaliti Auto Service HPC Dealer, Vytilla, Ernakulam-682 019, Kerala  
Phone: 9847054361

155. Hindustan Petroleum Corporation Ltd. (HPCL) PKC Nair & Co. HPC Dealer, Tripunthara, Ernakulam- 682 301  
Phone: 9847477661

### Kottayam

156. Indian Oil Corporation Ltd. (IOCL) Aswathy Fuels NH-47, Kollam  
Phone: 9387319587 / 2533068

### Pala

157. Reliance Industries Ltd. (RIL), Lalam Village, Meenachil Taluk, Palaettumamoor, Pala Municipality, Pala,  
Phone: 04822-2216456

### Piravom

158. Auto Gas Energy India Ltd. Kottayam Road, Piravoam

### Angamaly

159. Reliance Industries Ltd. (RIL) On NH-47, Near Mile Stone 315/0, Karukutty, Aluva, Ernakulam  
Phone: 0484-3226111

160. Auto Gas Energy India Ltd. Bank Junction

### Attingal

161. Aegis Logistics Ltd. Venjaramoodu Road, Attingal

### Calicut

162. Elf Gas India Ltd. Dealer: JK LPG Dispensing Station NH-17, Kolathara, Calicut-673 655  
Phone: 0495-2481766

## LIST OF LPG FILLING STATIONS

### Cherthala

163. Auto Gas Energy India Ltd. Kumaragom Road, Cherthala.

### Thriprayar

164. Auto Gas Energy India Ltd. Thrissur Road, Thriprayar

### Nilambur

165. Auto Gas Energy India Ltd.CNG Road

### Oachira

166. Indian Oil Corporation Ltd. (IOCL) Parandhram Petroleum Oachira  
Phone: 0476-2690757 / 9447206918

### Perumpilavu

167. Indian Oil Corporation Ltd. (IOCL) Khayam Petroleum Thrissur-680 519  
Phone: 04885-289397 / 9895028020

### Kollengode

168. Auto Gas Energy India Ltd. Puthunagaram Road, Kollengode

### Cochin

169. Bharat Petroleum Corporation Ltd. (BPCL) Kerala Oil Co. Pathirapally, Alappuzha-688 521  
Phone: 0477-2258088

170. Indian Oil Corporation Ltd. (IOCL) George FuelsNH-47, Aroor, Ernakulam  
Phone: 9846030477

171. Indian Oil Corporation Ltd. (IOCL), Sree Narayana Sales & Service, Edapally, Kochi-24  
Phone: 0484-2540647

### Malappuram

172. Hindustan Petroleum Corporation Ltd. (HPCL)Kundupuzhakkal Fuels HPC Dealers,PO. Okmuri, Vengara, Malappuram - 676 515 (Kerela)  
Phone: 9947300030

173. Hindustan Petroleum Corporation Ltd. (HPCL) Vee Pee Petroleum HPC Dealers, Chandakunnu, Nilambur, Malappuram - 679 342 (Kerela)  
Phone: 04931-225923 / 9447287283

### Moovattupuzha

174. Indian Oil Corporation Ltd. (IOCL) AMA Transports Neelima Garden, Puthuoppady P.O.  
Phone: 2812328 / 9447315233

### Kolenchery

175. Auto Gas Energy India Ltd.NH Road, Kolenchery

### Pathanamthitta

176. Indian Oil Corporation Ltd. (IOCL) Excel Fuels

### Thiruvalla

177. Auto Gas Energy India Ltd.T.K. Road, Thiruvalla

### Tirur

178. Indian Oil Corporation Ltd. (IOCL) P Hamza Haji Sons, Kuttipuram Rd-1  
Phone: 0494-2424126 / 9447125726

### Thrissur

179. Indian Oil Corporation Ltd. (IOCL) Anidya Petrol Café Kalathode, Ollukara, Thrissur-680 655  
Phone: 0487-2370535 / 9895327706

### Kayakulam

180. Auto Gas Energy India Ltd.K.P.Road, Kayamkulam

### Ettumanoor

181. Auto Gas Energy India Ltd.MC Road, Ettumanoor

### Kotakkal

182. Reliance Industries Ltd. (RIL)Opp. Ayurveda College, Edrai Code, Kottaikal, Malapuram Dist., Kottaikal-676 501  
Phone: 0483-32520062 / 2742479

## TAMIL NADU

### Coimbatore

183. Indian Oil Corporation Ltd. (IOCL) Sri Santhi Social

184. Bharat Petroleum Corporation Ltd. (BPCL) VSMERode

185. Bharat Petroleum Corporation Ltd. (BPCL) Roots Auto Spares, Mettupalaya Road

## LIST OF LPG FILLING STATIONS

### Chennai

186. Bharat Petroleum Corporation Ltd. (BPCL)COCO MKB Nagar Kasturi Agencies Unit II, Plot No.3 74, West Avenue, MKB Nagar, Vyasarpadi, Chennai- 600 039  
Phone: 25517444 / 25513536
187. Bharat Petroleum Corporation Ltd. (BPCL)DS Rajammal Agencies, 10,11, 12 Manall Road, Korukkupet  
Phone: 044-25923700
188. Bharat Petroleum Corporation Ltd. (BPCL)Tamilnadu Lorry Owners Federation, 16, Poonamalle High Road, Koyembedu  
Phone: 044-24752854
187. Bharat Petroleum Corporation Ltd. (BPCL)COCO, Ambattur, 94 B,Ambattur Industrial Estate, Ambattur  
Phone: 044-26358411
188. Bharat Petroleum Corporation Ltd. (BPCL)AG Agency No. 2, Old Mahabalipuram Road, Sholinganallur,  
Phone: 044-28602087
189. Hindustan Petroleum Corporation Ltd. (HPCL)Victory Enterprises, 359/E, C.T.H. Road, Thirumuliavoyal, Chennai-600 062  
Phone: 9884670129
190. Hindustan Petroleum Corporation Ltd.(HPCL)Brindavan Service Station, No. 2, Gauntz Road, Vyasarpadi, Chennai-600 039  
Phone: 044-25517132
191. Hindustan Petroleum Corporation Ltd.(HPCL)Sarath Agency, No. 72/123, Kuntathur Road, Porur, Chennai-600 116  
Phone: 9840331975
192. Hindustan Petroleum Corporation Ltd. (HPCL)Balaji Agencies, New No. 187(R21/2), Ambattur Industrial Estate Road, Anna Nagar West, Mugappair, Chennai - 600 101  
Phone: 9444620838
193. Bharat Petroleum Corporation Ltd.(BPCL) DS Rajammal Agencies, 10,11, 12 Manall Road, Korukkupet  
Phone: 044-25923700
194. Bharat Petroleum Corporation Ltd.(BPCL)Sree Vari Enterprises 1/76, East Coast Road, Kotivakkam  
Phone: 044-65256625
195. Indian Oil Corporation Ltd. (IOCL) Thirumurgan Agencies, 349, Waltax Road, Chennai-600 079  
Phone: 044-25202222 / 25203333
196. Indian Oil Corporation Ltd. (IOCL) Sri Thirumurugan Agencies, Korukkupet Kathivakkam High Road, Korukkupet  
Phone: 044-25921166
197. Indian Oil Corporation Ltd. (IOCL) Sarojini Oil Dealers, 90-C Fishing Harbour Complex, S N Chetty Street, Royapuram, Chennai- 600 013  
Phone: 25951804 / 25978424
198. Indian Oil Corporation Ltd. (IOCL) Pathy Agencies Nerkundram, Chennai - 600107  
Phone : 044-24871706
199. Indian Oil Corporation Ltd. (IOCL) Oviya F/Strn., Koyambedu, Opposite to Flower Market, Koyambedu, Chennai-600 107  
Phone: 24797317 / 24779447
200. Indian Oil Corporation Ltd. (IOCL) COCO Ambattur Sree Sakthi Agencies, S. No.304, MTH Road, Opp. TI Miller, Ambathur, Chennai- 600 053  
Phone: 044-26248567
201. Indian Oil Corporation Ltd. (IOCL) Chennai Autorickshaw Co.Op. Society, 849, Periyar EVR High Road, Kilpauk, Chennai- 600 010  
Phone: 044-26411073
202. Hindustan Petroleum Corporation Ltd. (HPCL)Saran Agencies, No. 120/122, P.H. Road, Opp MGR Engg. College, Maduravoyal, Chennai-600095  
Phone: 9841290439
203. Hindustan Petroleum Corporation Ltd. (HPCL)Anna Auto Co-operative Society, No.242,Ropettah High Road, Royapettah, Chennai-600 014 Phone: 9380643055/ 044-65853081

## LIST OF LPG FILLING STATIONS

204. Bharat Petroleum Corporation Ltd. (BPCL) Sridevi Enterprises, 639, MTH Road, Avadi,  
Phone: 044-26380585

205. Bharat Petroleum Corporation Ltd. (BPCL) MCLOA24 B, Anna Salai, Saidapet  
Phone: 044-22353599

206. Bharat Petroleum Corporation Ltd. (BPCL) Shanmuga Sundaram 219, GST Road, Tambaram Sanitorium, Chrompet  
Phone: 044-22402173

207. Bharat Petroleum Corporation Ltd. (BPCL) Car Care Centre, 97, Anna Salai, Near LIC  
Phone: 044-28602087

### Salem

208. Indian Oil Corporation Ltd. (IOCL) Malur Main Road, Narasothipatti, Salem-636 004  
Phone: 0427-2448409

### Madurai

209. Hindustan Petroleum Corporation Ltd. (HPCL) Madurai Filling Station, 159/2, Kamarajar Salai, Teppakulam, Madurai - 625 009  
Phone: 0452-2311106 / 09843050460

210. Hindustan Petroleum Corporation Ltd. (HPCL) Suganya F/St. RS No. 172/1 BP, Opp. Maduthavanu Bus Stand, Melur Main Road, Madurai - 625 007  
Phone: 0452-2586055 / 4392839/ 09842162308

211. Bharat Petroleum Corporation Ltd. (BPCL) MKT Motors S no. 13/10, Alagarkovil Main Road, Moondrumavady  
Phone: 0452-2560410

212. Indian Oil Corporation Ltd. (IOCL) Sree Harivelmurugam Enterprise 47-C, T B Road, Arasaradi, Madurai-10  
Phone: 0452-2603902 / 2607039 / 9894866663

213. Reliance Industries Ltd. (RIL) 24, TPK Road, Pasumalai, Madurai-625 004  
Phone: 0452-6459094

### Melmaruvathur

214. Indian Oil Corporation Ltd. (IOCL), ACMEC Trust Melmaruvathur- 603 319  
Phone: 044-27529384

### Kancheepuram

215. Bharat Petroleum Corporation Ltd. (BPCL) COCO BPT ambaram, Velachery Road, Gowrivakkam, Post Pallikaranai  
Phone: 044-22462590

### Erode

216. Reliance Industries Ltd. (RIL) Veerapan Chathiram Panchayat, Erode Taluka, Erode  
Phone: 0424-6454639

### Tiruppur

217. Reliance Industries Ltd. (RIL) Bharathi Nagar, Veerapandi, Tirupur-Palladam Road, Tirupur-641 605  
Phone: 0421-6453581

### Chennaryapatana

218. Reliance Industries Ltd. (RIL) Opp. Nisarga Dhaba, BM Road, Chennaryapatana  
Phone: 08176-254234

## KARNATAKA

### Gulbarga

219. Hindustan Petroleum Corporation Ltd. (HPCL) Gulbarga Auto Links, Gulbarga Auto Links HPC Dealers, Station Road, Gulbarga (Karnataka)  
Phone: 08472-222026 / 9844049214

### Mangalore

220. Indian Oil Corporation Ltd. (IOCL) KG Bhat Kankanady, Mangalore - 575 002  
Phone: 0824-2435314 / 667364

230. Indian Oil Corporation Ltd. (IOCL) Vishnu Enterprises. NH-17, Panambur - 575 010  
Phone: 0824-2409868 / 988161619

231. Hindustan Petroleum Corporation Ltd. (HPCL) Maco Co-op Society Lower Bendoorwell Road, Mangalore,  
Phone: 0824 - 2421113

### Davangere

232. Aegis Logistics Ltd. No. 856/81, S.J.M. Nagar, Behind Sitara Hotel, Near P.B. Road, Davangere-577 002

## LIST OF LPG FILLING STATIONS

### Shimoga

233. Indian Oil Corporation Ltd. (IOCL) Bhargavi Motor Fuels Sagar Road, Shimoga-577 204  
Phone: 250888 / 250999 / 9844090888

### Puttur

234. Elf Gas India Ltd. Puttur Petroproducts Nehru Nagar, Puttur - 574 203  
Phone: 08251-236105 / 236106

### Bangalore

235. Elf Gas India Ltd. Dars Automobiles, Venkateshpura, Nagawara Main Road, Bangalore- 560 045  
Phone: 080-25800415 / 25790280
236. Indian Oil Corporation Ltd. (IOCL) Swathi S/Stn.
237. Indian Oil Corporation Ltd. (IOCL) Bowring S/Stn.
238. Indian Oil Corporation Ltd. (IOCL) SP Agencies
239. Indian Oil Corporation Ltd. (IOCL) Jai Hanuman Fuel Station.
240. Hindustan Petroleum Corporation Ltd. (HPCL) Srinivasa Service Station, .59/2, Bansawadi Main Road, Jaibharathinagar, Bangalore- 560 033  
Phone: 080-25474254 / 25479901
241. Elf Gas India Ltd. B M Energy Hosahalli Main Rd, Vijayanagar, Bangalore-560 023  
Phone: 9886179988

242. Elf Gas India Ltd. R K Autogs, Magadi Main Road, Kamakshipalya, Bangalore-560 079
243. Bharat Petroleum Corporation Ltd. (BPCL) P.R.K. AutoPlot no. 2, Mysore Road  
Phone: 9448068599 / 26759499
244. Bharat Petroleum Corporation Ltd. (BPCL) Shrestha Outer Ring Road, HRVR layout  
Phone: 25496688 / 9448084559
245. Bharat Petroleum Corporation Ltd. (BPCL) Udaya Fuel Station. Sirsi circle, Bangalore  
Phone: 9845722337
246. Bharat Petroleum Corporation Ltd. (BPCL) Advaita 4, T Block, Jayanagar, Bangalore  
Phone: 9844013042 / 22443341
247. Bharat Petroleum Corporation Ltd. (BPCL) Chandlers IST Main Road, Gandhinagar  
Phone: 9845013901 / 22263260
248. Bharat Petroleum Corporation Ltd. (BPCL) Gurukrupa Fuel Junction SRI, Gurukrupa Layout, Nagarvahi  
Phone: 9448537366 / 23218570
249. Indian Oil Corporation Ltd. (IOCL) Jalahalli Service Station
250. Reliance Industries Ltd. (RIL) Industrial Suburb, 2nd Stage, Yeshwanthpur, Nandini Layout, Bangalore-560 022  
Phone: 080-64522464

251. Reliance Industries Ltd. (RIL) B.M. Shankarappa Estate, Sunkadakatte, Magadi, Rd. Bangalore  
Phone: 080-64520178
252. Hindustan Petroleum Corporation Ltd. (HPCL) Favourite Auto Service, Madiwala, Koramangala Post, Next to St. John's Hospital, Hosur Road, Bangalore-560 034  
Phone: 080-25530397
253. Bharat Petroleum Corporation Ltd. (BPCL) Federation of Lorry Owners (FLOA) Devraj Urs Truck Terminal, Peenya Industrial Suburb, II Stage, Yeshwantpur, Bangalore  
Phone: 080-23478898
254. Bharat Petroleum Corporation Ltd. (BPCL) Anurag Family Trust Koramangala, Inner Ring Road  
Phone: 2705623 / 9845685897
255. Bharat Petroleum Corporation Ltd. (BPCL) Sri Laxmi Service Station M.s. Ramaiah Road, Gokula, Jalahalli  
Phone: 23452077 / 9 / 886643548
256. Bharat Petroleum Corporation Ltd. (BPCL) Matushree SS Subbanapalaya Main Road, Banaswadi  
Phone: 9845245186 / 25428868
257. Bharat Petroleum Corporation Ltd. (BPCL) Kirti Service Station No. 2, Mission Road, Near J.C. Road, Town Hall Weigh Bridge  
Phone: 9880001926 / 42148803

## LIST OF LPG FILLING STATIONS

258. Bharat Petroleum Corporation Ltd. (BPCL)COCO BP-6, No. 17, Ward no. 76, Richmond Town, Hosur Road  
Phone: 25572499 / 9 / 845542989
259. Bharat Petroleum Corporation Ltd.(BPCL)Gokula Service Station, Old Madras Road, Doorvaninagar  
Phone: 080-28510402 / 28511172
260. Indian Oil Corporation Ltd (IOCL) Venkateshwara Fuel Station.Yelahanka  
Phone: 080-28460616
261. Indian Oil Corporation Ltd (IOCL) Vardharaja Service Sattion,.596, Dr Rajkumar Road, Rajajinagar  
Phone: 080-23320762
262. Indian Oil Corporation Ltd (IOCL) Mobil Service Station, 11 km Kanakapura Road, Konanakunte Cross  
Phone: 080-26664392 / 9845017787
263. Indian Oil Corporation Ltd (IOCL) Lakshamma & SonsNo.1,Narayanappa Garden, HD Deve Gowda Road, RT Nagar-560 032  
Phone: 080-23548511 /23638432 / 9845133943
264. Indian Oil Corporation Ltd (IOCL) Engrads Fuel Station,Opp BHEL, Mysore Road  
Phone: 080-26749652
265. Indian Oil Corporation Ltd (IOCL) Karnataka Food & Civil Supplier Corp.Kamokpura,Main Road,Banasankari  
Phone: 080-26553466 / 9845127075
266. Indian Oil Corporation Ltd (IOCL) Kaveri Fuel Station.Near National Games Village, Koramangla  
Phone: 080-25710236
267. Indian Oil Corporation Ltd (IOCL) Anjandri Service Station, Chamrajpet
267. Hindustan Petroleum Corporation Ltd. (HPCL)Highway Auto Needs, 12th Kilometer, Bellary Road, Allasandra, Opp Jakkur Airodrome,Yelahanka, Bangalore-560 064  
Phone: 080-28462591 / 28460694
268. Hindustan Petroleum Corporation Ltd. (HPCL)Gautam Service StationOpp to MEI, Tumkur Road, Near RNH Motors,Yeshwanthpur, Bangalore-560 022  
Phone: 080-23371331
269. Hindustan Petroleum Corporation Ltd. (HPCL)Bambaramaba Fuel StationC/o. HPCL LPG Bottling Plant, Mahadevapura,White field Road, Bangalore-560 048  
Phone: 080-28511780
270. Bharat Petroleum Corporation Ltd (BPCL)Nagpal's Garage, 22, Residency Road  
Phone: 080-25587715
271. Bharat Petroleum Corporation Ltd.(BPCL)Maruti Service Station Pantarapalaya, Mysore Road, Bangalore  
Phone: 080-28600632
272. Bharat Petroleum Corporation Ltd. (BPCL)Ramchandra Bros.Brian Square, Mysore Road  
Phone: 080-26708980
273. Bharat Petroleum Corporation Ltd.(BPCL) Arunodaya Filling Station69/4, Ring Road, Gangadhar Nagar, J.P. Nagar  
Phone: 080-26717223
274. Elf Gas India Ltd. Dars Automobiles Tumkur Road, Yeswantpur, Bangalore- 022  
Phone: 080-23377743

### Mysore

275. Elf Gas India Ltd.Acme Autogas, Abba Rd, Nazarbad Mohalla, Mysore- 570 010  
Phone: 08212-440508
280. Bharat Petroleum Corporation Ltd. (BPCL)Shree S S Saraswatipuram  
Phone: 09880567272 / 08218940902

### Udupi

281. Aegis Logistics Ltd. Survey no. 31/1, Near Halima S. Auditorium, NH-17, Udyavara, Udupi-576 118



## LIST OF LPG FILLING STATIONS

### DELHI

282. Hindustan Petroleum Corporation Ltd. (HPCL) Anand Service Station, NH-8, Delhi-Gurgaon Road, Rangpuri, New Delhi-110 037  
Phone: 011-25654592
283. Hindustan Petroleum Corporation Ltd. (HPCL) Victory Service Station G.T. Road, Near Julf-E-Bengal, Opp. Sahni Factory Shahdara, UP Border, Delhi-110 095  
Phone: 011-22116868 / 6969
284. Hindustan Petroleum Corporation Ltd. (HPCL) HP Auto Care Centre, Najabgarh road, Adjacent Moti Nagar Police Station, Moti Nagar, New Delhi-110 015  
Phone: 011-25918974
285. Indian Oil Corporation Ltd. (IOCL) Sethi Service Station, Mangolpuri, Outer Ring Road  
Phone: 011-27524639
286. Indian Oil Corporation Ltd. (IOCL) Sabharwal Service Station, Sector 5, RK Puram  
Phone: 011-26175440
287. Indian Oil Corporation Ltd. (IOCL) Rajasthan Highways, NH-8 Kaparshera Border  
Phone: 011-51685238, 9811038654
289. Indian Oil Corporation Ltd. (IOCL) Rajapath Motors, Geeta Colony  
Phone: 011-22049223/ 22457830
290. Indian Oil Corporation Ltd. (IOCL), Queens Road S/Stn. Near Vasant Vihar Bus Depot, Outer Ring Road  
Phone: 011-26146202
291. Indian Oil Corporation Ltd. (IOCL) Khyber Service Station, Opp. Gurudwara, Moti Bagh, Outer Ring Road  
Phone: 011-24677937 / 981152225
292. Indian Oil Corporation Ltd. (IOCL), Jubilee R/O, Near IOC LPG Bottling Plant, Tikrikalan  
Phone: 011-28351456
293. Indian Oil Corporation Ltd. (IOCL) Dalip Service Station, Near Hotel Radisson, NH-8, Mahipalpur  
Phone: 011-25063633
294. Indian Oil Corporation Ltd. (IOCL) CM Enterprises, Janakpuri  
Phone: 011-25618762
295. Indian Oil Corporation Ltd. (IOCL) Auto Yard, Mathura Road, Near Apollo Hospital  
Phone: 011-26945135
296. Indian Oil Corporation Ltd. (IOCL) Ahuwalla Service Station, Near Haldiram Mathura Road  
Phone: 011-26959790
297. Hindustan Petroleum Corporation Ltd. (HPCL) Kundanlal Service Station HPC Petrol Pump, Shahdara-ISBT Road, Shastri Park, Delhi- 110 053  
Phone: 011- 22192100 / 22193100

### ANDHRA PRADESH

#### Nizamabad

298. Hindustan Petroleum Corporation Ltd. (HPCL) P. Laskshmikantha Rao & Sons, Dichapally, Nizamabad, Nizamabad  
Phone: 08462-221264 / 9848244444

#### Hyderabad

299. Indian Oil Corporation Ltd. (IOCL) Sivam Auto
300. Indian Oil Corporation Ltd. (IOCL) Jubilee Auto Services, Miyapur.
301. Indian Oil Corporation Ltd. (IOCL) National Service Station, Opp. Erra Manjil, Panjagutta Road- 500 082  
Phone: 040-23319435 / 23329520
302. Indian Oil Corporation Ltd. (IOCL) Sita Logistics, 82/1, Agriculture Market Yard, Bowenpally  
Phone: 040-64506775 / 9848455575
303. Hindustan Petroleum Corporation Ltd. (HPCL) Surya Service Station, Plot Nos. 60 to 65, S.No. 310, Nagaram Village, Keesara Mandal, Rangareddy Dist
304. Bharat Petroleum Corporation Ltd. (BPCL) Mahendra Fuels, S.Nos. 108 & 109(P), Karmanghat Village, Saidabad Mandal, Ring Road, Hyderabad, Hyderabad Dist. - 500 079.  
Phone: 24077931 / 9848562997

## LIST OF LPG FILLING STATIONS

305. Company: Bharat Petroleum Corporation Ltd. (BPCL) Kishan Service Station, S.No. 385, D.No. 41-1/ABC, Moulali Village, Malkajgiri Mandal, Rangareddy Dist. Phone: 27140570 / 9393033694
306. Bharat Petroleum Corporation Ltd. (BPCL) Vamsi Fuel Point, Near Babu Ghat, Lungar House, Hyderabad Phone: 040-23511332
307. Bharat Petroleum Corporation Ltd. (BPCL)M A Filling Station, 162 / 1 & 2, East Marebali, Near Rail Milayan Road, Secundrabad Phone: 040-23240679
308. Bharat Petroleum Corporation Ltd. (BPCL) GKTC10-1, APIIC Auto Nagar, NH-9, Hyderabad-70 Phone: 040-24025836
309. Bharat Petroleum Corporation Ltd. (BPCL) Pradeep Agencies"NH-9, Miyapur, RR Dist. Hyderabad- 500 050 Phone: 040-23041536 / 23045137
310. Bharat Petroleum Corporation Ltd. (BPCL) S.N.More 19-4-8/1, Dandlaguda, Chandrayanguda, Hyderabad-500 005 Phone: 6594843 / 24455037
311. Indian Oil Corporation Ltd. (IOCL) Charminar Chourasta"Opp. Auto Nagar, S.no. 282, Vanasthlipuram, Hyderabad- 500 070 Phone: 040-24021893 / 9848010026
312. Indian Oil Corporation Ltd. (IOCL) Uppal Industrial Auto Service"Plot no. C-1/1, Sy no. 581/1, Uppal Khalsa Village, Uppal Mandal, RR Dist. , Hyderabad-500 039 Phone: 040-27204455
313. Reliance Industries Ltd. (RIL)Survey no. 6/ 8, Saroornagar (V) & (M), RR District, Hyderabad-500 035 Phone: 040-32001929
314. Reliance Industries Ltd. (RIL)Survey no. 198-204, Ranga Reddy Dist., Nacharam, Hyderabad- 500 076 Phone: 040-32903092
315. Reliance Industries Ltd. (RIL) A-9 & A-10, AIE , Main Road, beside CITD Balanagar, Hyderabad- 500037 Phone: 040-39253352
316. Hindustan Petroleum Corporation Ltd. (HPCL) N.Laxmaiah & Brothers.S.No. 64, Door No. 3-8-173,Road No. 1, Mansoorabad Village, L.B. Nagar Ring Road, Saroornagar Mandal, Hyderabad - 500 074 Phone: 24122292 / 24122074 / 9246539398
317. Bharat Petroleum Corporation Ltd. (BPCL)Mehmood Filling Station, 8-3-235/ 6,Yusufguda, Check-post, Hyderabad-45 Phone: 040-23544562
318. Bharat Petroleum Corporation Ltd. (BPCL)Dayanand Auto Services. NH 7, Shamshabad - 501 218, Dist. Ranga Reddy. Phone: 08413-222035"
319. Indian Oil Corporation Ltd. (IOCL)"Dealer: Venkateshwara Fuel Station.Kompally on Hyderabad -Nizambad Highway
320. Indian Oil Corporation Ltd. (IOCL)"Dealer: Ravi Weighing Service Station Goshamahal. Phone 040-24744670
321. Indian Oil Corporation Ltd. (IOCL) Jubilee R/O Thimapur , Thimapur on Hyderabad-Bangalore Highway Phone: 08548-257960
322. Indian Oil Corporation Ltd. (IOCL) Aruna Fuel Station,Moulali, Hyderabad Phone: 040-27122887 / 4848031096

### Tirupati

323. Indian Oil Corporation Ltd. (IOCL) Korepati Petroleum,Chandragiri Road, Phone: 0877-2249749
324. Elf Gas India Ltd.OM Shakti Auto LPG, Reningunta Road, Near Hotel Bliss, Tirupati- 517 501 Phone: 0877-3206755

## LIST OF LPG FILLING STATIONS

### Vijayanagram

325. Hindustan Petroleum Corporation Ltd. (HPCL) M.Eashwar Rao HPCL Dealer, NH-5, Maharajulapeta, Rajapulova Post, Dist. Vijayanagram  
Phone: 9989922799

### Warangal

326. Vanaz Engineers Limited. Sri Vankata Sai Enterprises, Survey no. 176/1, Hunter Road, Shayampeth, Opp. Citizen Club, Warangal, Andhra Pradesh  
Phone: 0870-3091326 / 9866168665

### Nalgonda

327. Hindustan Petroleum Corporation Ltd. (HPCL) B.S. Filling Station HPC Dealers, S. no. 28, Opp. Textile Park, Malkapur village, Chowtuppall Mandal, Dist. Nalgonda  
Phone: 08694 - 270343/44/45 / 9866233737

### Guntur

328. Hindustan Petroleum Corporation Ltd. (HPCL) Bharat Service Station. HPC Dealer, Near Medical Club, GT Road, Guntur-522 015  
Phone: 0863 - 2230943 / 9885164611
329. Hindustan Petroleum Corporation Ltd. (HPCL) Hima Petrol & Diesel Station, HPC Dealer, Opp. Microwave Tower, NH-5, Bypass Road, Budampadu Junction, Guntur-522 015  
Phone: 0863-232636 / 9885268911

### Anantpur

330. Vanaz Engineers Limited, Yallamma Matha Auto LPG "S. no. 344, Gooty-Anantpur Road, NH no. 7, PO Anantpur,  
Phone: 9848389783

### Visakhapatnam

331. Hindustan Petroleum Corporation Ltd. (HPCL) Bh.S.R. Highway Service Station, HPC Dealer, 28-16-1, Vadalpudi, NH-5, Gajuwaka Mandal, Visakhapatnam, Dist.-530 046  
Phone: 9848779999

## WEST BENGAL

### Kolkata

332. Indian Oil Corporation Ltd. (IOCL) Bye Pass Service Station, 3B Rash Behari Avenue Connector, Rajganga, Nabapalli, Kolkata-700 107  
Phone: 033-24427895/ 24427112
333. Indian Oil Corporation Ltd. (IOCL) Anderson Auto, Belvedere Road, New Alipore, Kolkata-27  
Phone: 033-24499150 / 9830415979 / 9831004444
334. Indian Oil Corporation Ltd. (IOCL) Hirji Auto Centre "120/2, A P C Roy Road  
Phone: 033-23506470
335. Indian Oil Corporation Ltd. (IOCL) Salt Lake Service Stn, Salt Lake, Sector-1  
Phone: 033-23349853 / 23581395

336. Indian Oil Corporation Ltd. (IOCL) Prince Service Station, Anwar Shah Road  
Phone: 033-24731695
337. Hindustan Petroleum Corporation Ltd. (HPCL) Rajrani Service Station, Mahamayatala, P.O. Garia, Kolkata-700 084  
Phone: 033-24358884
338. Hindustan Petroleum Corporation Ltd. (HPCL) ITC Ultadanga, 1, Ultadanga Road, Ultadanga, Kolkata  
Phone: 033-25557933 / 255548489"
339. Hindustan Petroleum Corporation Ltd. (HPCL) Baranagar Service Station, 131, BT Road, Baranagar, Kolkata  
Phone: 033-25773229
340. Bharat Petroleum Corporation Ltd. (BPCL) Superway Service Station, P-527, CIT Road, Kolkata-700 054  
Phone: 033-23528853
341. Bharat Petroleum Corporation Ltd. (BPCL) Sreema Service Station, 11 A, Silpara, D.H. Road, Kolkata - 700 008  
Phone: 033-24533294
342. Bharat Petroleum Corporation Ltd. (BPCL) Raibareilly Service Stn, 33, Tollygunj Circular Rd, Kolkata - 700 053  
Phone: 033-24002651
343. Bharat Petroleum Corporation Ltd. (BPCL) Amar Service Station, 277, B.T. Road, Kolkata-700 036, Phone: 033-25570196

## LIST OF LPG FILLING STATIONS

### MADHYA PRADESH

#### Gwalior

344. Indian Oil Corporation Ltd. (IOCL) Shiv Chand Amol Chand, Jhansi oad, Gwalior. Phone: 0751-2427747,2310972
345. Hindustan Petroleum Corporation Ltd. (HPCL) Sudarshna Motors, Transport Nagar, Gwalior Phone: 0751-2490373

#### Bhopal

346. Reliance Industries Ltd.(RIL), Khasra No. 234/1/2, Near People General Hospital, Berasia Road, Bhopal. Phone: 0755-6456948
347. Indian Oil Corporation Ltd.(IOCL), Auto House, Piplani
348. Indian Oil Corporation Ltd (IOCL) Sawntika, Gautam Nagar, Bhel Bhopal Phone: 0755-2581492
349. Indian Oil Corporation Ltd. (IOCL), Capital Auto Service, Obaidullahganj Road, Ahmedpur, Bhopal-462 026 Phone: 0755-5220632

#### Durg

350. Vanaz Engineers Limited, Banwarilal & Sons"KH no. 29/1 & 31/1, Mauje-Nakikhar, Taluka & District Korba Phone: 9827172151

351. Vanaz Engineers Limited, Agrawal Auto LPG Services, P.H.No.- 8, NH-84 & 85, Mouza Parasada, PO 23, Dist. Bilaspur, Khapari, Durg Phone: 0788-5013261 / 9229522200

#### Jabalpur

352. Vanaz Engineers Limited, Sanmitra Auto LPG Services, Village Khasra no 77/1, Set no 360/230, Tilwara Ghat, Dist Jabalpur Phone: 9827258690

#### Indore

353. Hindustan Petroleum Corporation Ltd. (HPCL) Fazal Khan Peer Khan, Sanyogita Ganj, Indore Phone: 9826210201
354. Indian Oil Corporation Ltd. (IOCL), Police Lines, RAPTC, Airport Road- 452 005 Phone: 0731-2419131
355. Indian Oil Corporation Ltd. (IOCL) Usharaj Fuels, 10-B, Sch no. 31, Loha Mandi, Near Navlakha Complex, Indore- 452 001 Phone: 0731-2364364, 2362888
356. Indian Oil Corporation Ltd. (IOCL) Malaviya Fuel Station, 15-C Scheme 94, Ring Road, Indore Phone: 0731-2552222

#### Burhanpur

357. Vanaz Engineers Ltd. Surya Gas Point, Gram Fattepur, Dist. Burhanpur Phone: 0725-52808 / 9826337408

#### Dewas

358. Indian Oil Corporation Ltd. (IOCL) Swagat RO, Bilawali, NH-3, AB Road. Phone: 07272-256260 / 9425093042

### PUNJAB

#### Ludhiana

359. Hindustan Petroleum Corporation Ltd. (HPCL), Pathak Power Point, M Mundiya Kalan, Ludhiana

#### Jalandhar

360. Indian Oil Corporation Ltd. (IOCL) Amar Highways, G.T.Road, (Ludhiana-Jalandar), Plot no. 225/5, Pin-144 010. Phone: 0181-2260214 / 2413776 / 984300147

### CHANDIGARH

361. Bharat Petroleum Corporation Ltd.(BPCL)EEM PEE Motors, Sector- 22 Chandigarh Phone: 0172-2700386
362. Indian Oil Corporation Ltd (IOCL) M/s. Allied Service Station.Sector 34-B, Chandigarh Phone: 0172-2612728"

## LIST OF LPG FILLING STATIONS

### CHATTISGARH

#### Bilimora

363. Vanaz Engineers Limited. Maa Sharada Auto LPG Pump, 3 Km Stone, Bilaspur-Raipur Road, Mouza Parasada, PH no. 23, Dist. Bilaspur  
Phone: 09425284000 / 9301315181
364. Aegis Logistics Ltd. "Plot no. 374/2, Gandevi Road, Bilimora-396 320

#### Raipur

365. Hindustan Petroleum Corporation Ltd. (HPCL) Jain Auto Petroleum "Amanaka, Raipur, Chattisgarh
366. Vanaz Engineers Limited. OM Auto LPG Fuels, P.H.No.- 104, K.no. 63/11, Mahadev Ghat Road, Village Raipura, Dist. Raipur  
Phone: 0771-6536356 / 09893142114
367. Bharat Petroleum Corporation Ltd. (BPCL) Topup Centre, Amanaka, G.E.Road, Raipur, Chattisgarh  
Phone: 2253078 / 4039682
368. Indian Oil Corporation Ltd. (IOCL) Abhay Fuels, Pandri, Raipur  
Phone: 0771-2283000 / 2282999 / 9425210100

#### Bilaspur

369. Indian Oil Corporation Ltd. (IOCL) Laxmi Service Station, Manla Chowk,  
Phone: 07752-320414

### UTTAR PRADESH

#### Lucknow

370. Indian Oil Corporation Ltd. (IOCL), SSR Filling Station, Ring Road, Jankipuram  
Phone: 23615461730"

#### Kanpur

371. Indian Oil Corporation Ltd. (IOCL) Engineers Service Station, 9/46, Dr. Ambedkar Nagar, Bena Jhabar Road  
Phone: 0512-2291258

#### Agra

372. Indian Oil Corporation Ltd (IOCL) "Shahid Jitendra F/Strn" Kailashpuri  
Phone: 0562-2605576
373. Indian Oil Corporation Ltd (IOCL) National Highway Filling Station, Sikandara  
Phone: 0562-2641228
374. Indian Oil Corporation Ltd (IOCL) M/s Auto Energy, Runkuta, Agra Mathura Road  
Phone: 05613-271283

### RAJASTHAN

#### Jaipur

375. Reliance Industries Ltd. (RIL), NH-11, Opp. New Chungi, Agara Road, Jaipur  
Phone: 9314114913
376. Bharat Petroleum Corporation Ltd. (BPCL) DPS Automotives, 3C, Kamani Road, Industrial Area, Jhotwara, Jaipur-302 012  
Phone: 0141-2340891

377. Indian Oil Corporation Ltd. (IOCL) Shahid J P Yadav, Subhash Nagar  
Phone: 0141-2280971
378. Indian Oil Corporation Ltd (IOCL) Shahid Bhagwan Singh Filling Station, Heera Path, Sector 6, Masarovar, Jaipur  
Phone: 0141-2783754
379. Indian Oil Corporation Ltd. (IOCL) M/s Shahid Basti Ram Filling Station, Baiji Ki Kothi, Jaipur  
Phone: 0141-2706803
380. Indian Oil Corporation Ltd (IOCL) Rajasthan Highways, Transport Nagar  
Phone: 0141-2642683
381. Indian Oil Corporation Ltd (IOCL) IOC Filling Station. Sahakar Marg  
Phone: 0141-5120068"
- #### Ajmer
382. Indian Oil Corporation Ltd. (IOCL) Shyam Balaji Filling Station, Anasagar, Circular Road, Vaishali, Ajmer.  
Phone: 0145-2643388

#### Kishangarh

383. Reliance Industries Ltd. (RIL), NH-8, CH-373, 5, Jaipur-Ajmer Highway, Vill-Madanganj, The- Kishangarh, Dist. Ajmer  
Phone: 01463-325751

## LIST OF LPG FILLING STATIONS

---

### **Kota**

- 384. Reliance Industries Ltd. (RIL), Jhalwar Road, Before Anantpur Circle, Kota - 324 005  
Phone: 0744-6451289
- 385. Indian Oil Corporation Ltd. (IOCL) Modern Auto Traders, Aerodrome Circle.  
Phone: 0744-2361739 / 9829036739