

PACKAGE CONTENTS

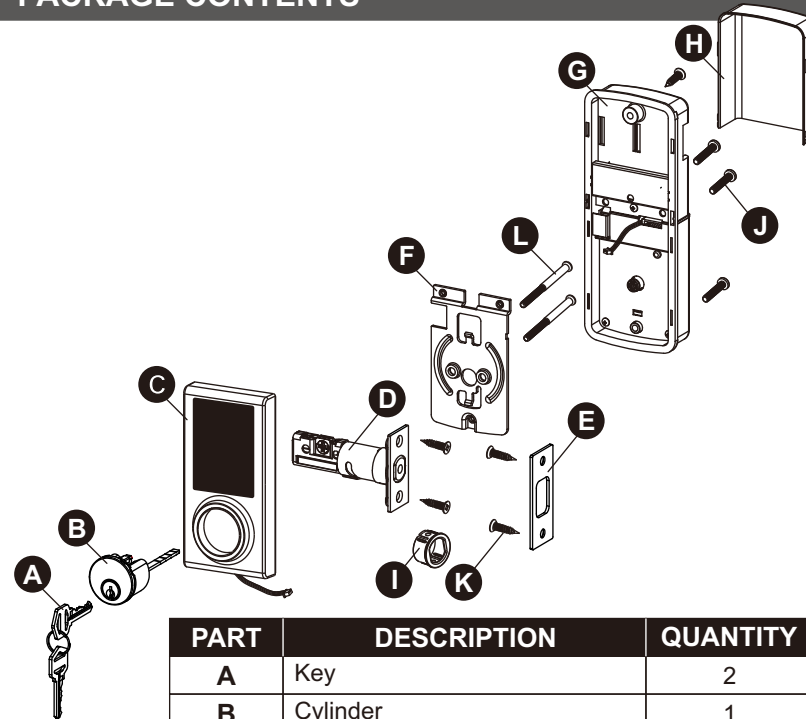

PART	DESCRIPTION	QUANTITY
A	Key	2
B	Cylinder	1
C	Deadbolt Touchpad Assembly	1
D	Deadbolt Latch	1
E	Strike Plate	1
F	Mounting Plate	1
G	Receiver Assembly	1
H	Battery Cover	1
I	Drive-in Sleeve	1
J	Machine Screws	3
K	Wood Screws	5
L	Deadbolt Chassis Screws	2

HARDWARE SCREWS CONTENTS

J

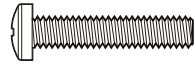

Machine Screws

Qty. 3

K

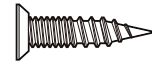

Wood Screws

Qty. 5

L

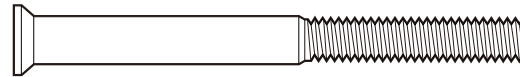

Deadbolt Chassis Screws **Qty. 2**

LATCH BACKSET ADJUSTMENT

Remarks:
Please notice the slight differences in the latch box between two different backsets.

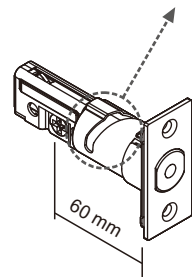

2 3/8" (60 mm)

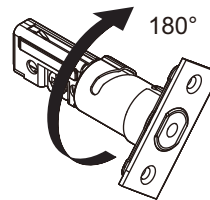

180°

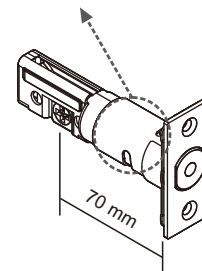

2 3/4" (70 mm)

ASSEMBLY INSTRUCTIONS

1. Backset Determination

Backset is a distance from door edge to centre of hole on door face.
Adjustable latch fits both backset of 2 3/8" (60 mm) and 2 3/4" (70 mm).

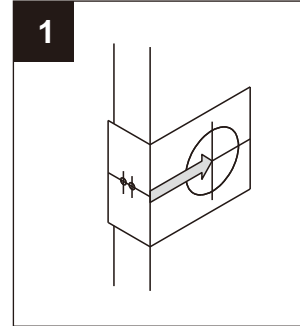

2. Change Latch Face

Determine which latch mounting method will be used and make necessary adjustments.
No adjustment required for square latch face plate.

- Use a flat screwdriver to separate the face plate.
- Snap selected latch face plate onto back plate.

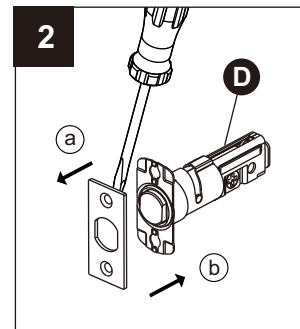

Drive-in Installation

Remove original latch faceplate.
Align the drive-in sleeve (I) as illustrated and snap into the latch case.

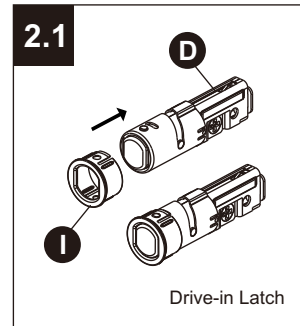

ASSEMBLY INSTRUCTIONS

3. Latch Backset Adjustment

Determine if the latch (D) needs to be adjusted to the 2 3/4" (70 mm) backset.

To adjust, rotate the latch until it stops.

Reverse the direction to return to the 2 3/8" (60 mm) backset.

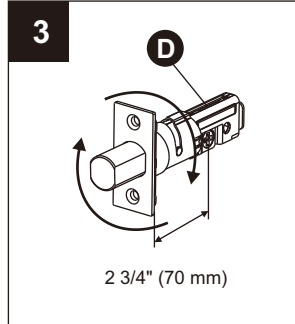

4. Mark the Door with Template

Select the height and backset as desired on the door face; use the TEMPLATE as an indication to mark the centre of the circle on the door face and the centre of the door edge.

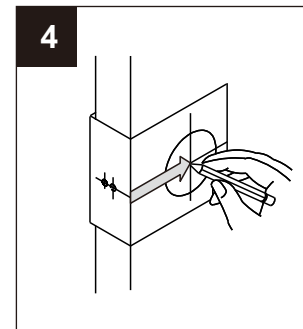

5. Drill Holes

Using the marks as a guide to drill a hole $\text{\O}2 \frac{1}{8}$ " (54 mm) through the door face for the lockset, then a hole of $\text{\O}1$ " (25.4 mm) for latch.

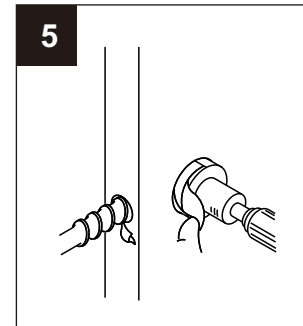

ASSEMBLY INSTRUCTIONS

6. Mark the Outline of Latch Faceplate

Insert the latch (D) and ensure it is parallel to the door face.
Mark the outline of the faceplate, then take out the latch (D).

You need to stay this way up when inserting the latch.

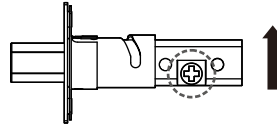

Make sure the cross in the latch is on the bottom.

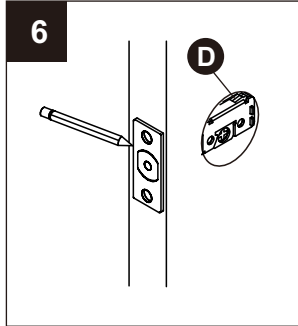

7. Chisel Space for Latch Faceplate

Chisel 5/32" (4 mm) deep along the outline to allow the faceplate to be aligned with the door edge.

Note: It is not necessary to chisel the door edge for the faceplate installation if you use the drive-in latch.

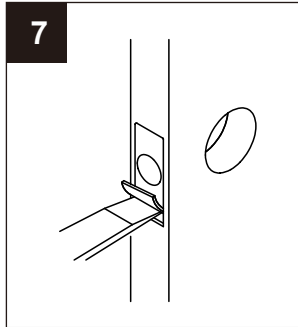

8. Install Latch

Insert the latch (D) into the door.
(Make sure the cross is on the bottom of the latch.) Use 2 wood screws (K) to secure latch.
Please do not fully tighten the screws until lock is completely installed.

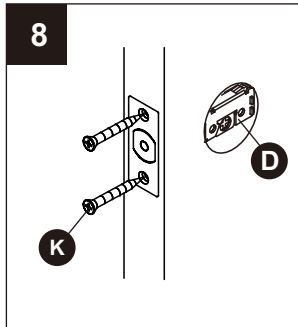

Hardware Used

K Wood screws  x2

ASSEMBLY INSTRUCTIONS

Install Drive-in Latch

Drive the latch (D) into the hole on edge of door.

8.1

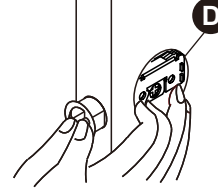

9. Mark the Outline of Strike

To identify the centre of strike: close the door to lay the latchbolt against the door frame. Mark the centre line on the doorframe exactly opposite the latch hole in the door edge.

9

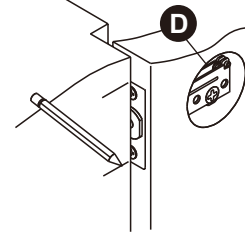

10.1 Drill Hole on Door Frame

Measure one half of door thickness from door stop and vertically mark centre line of strike. Drill 1" (25.4 mm) hole, 1" (25.4 mm) deep at intersection of horizontal and vertical line of strike.

10

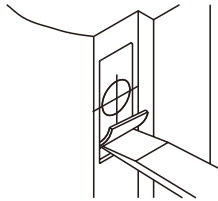

10.2 Chisel Space for Strike

Chisel 5/64" (2 mm) deep along the strike outline to allow the strike to be aligned with the doorframe.

ASSEMBLY INSTRUCTIONS

11. Install Strike on Door Frame

Install the strike plate (E) into your door frame and tighten with wood screws (K).

Hardware Used

K Wood screws  x2

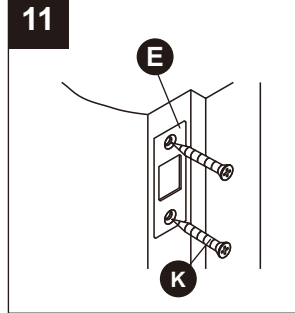

12. Install Touchpad Assembly

Make sure the latch bolt is retracted.

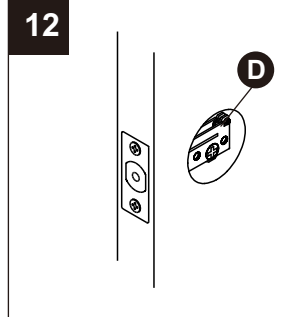

13. Install Touchpad Assembly

Install cylinder (B) into the deadbolt touchpad assembly (C) with tailpiece in horizontal position inserted through hub of the latch.

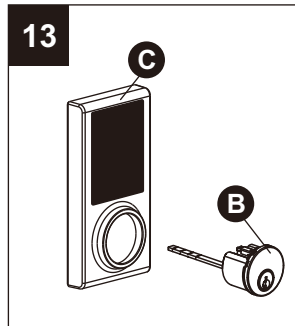
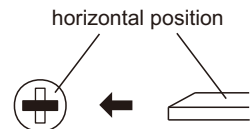

ASSEMBLY INSTRUCTIONS

14. Install Touchpad Assembly

Pass the IC wire under the latch (D) to the interior side of the door, and insert the tailpiece through the cross-shaped crank of the latch.

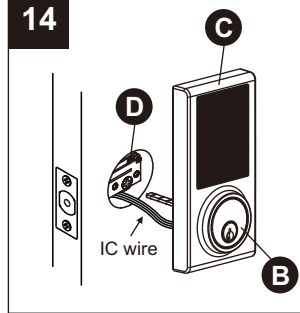
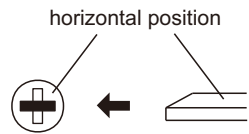

15. Install Inside Mounting Plate

Pass the IC wire through the wire hole of the mounting plate (F). Fix the mounting plate (F) with screws (L). If outside lock assembly is lopsided, please loosen the screws to adjust its position and tighten the screws again.

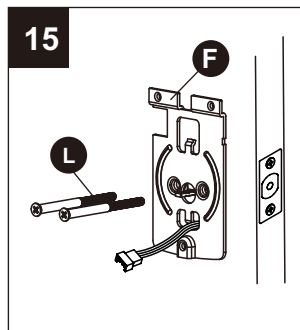

Hardware Used

L Deadbolt chassis screws  x2

16. Identify Door Handing

Face the door from the outside. The door is left-handed if the hinges are on the left side of the door, whereas the door is right-handed if the hinges are on the right side of the door.

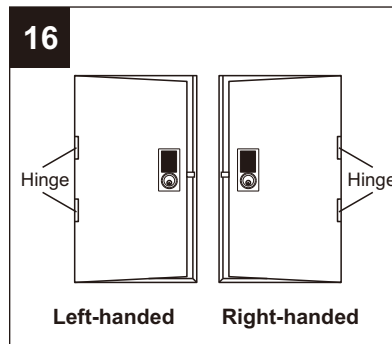

ASSEMBLY INSTRUCTIONS

17. Adjust Thumb Turn Piece

Rotate the thumb turn piece to the LEFT at 45 degrees for right-handed doors.
Rotate the thumb turn piece to the RIGHT at 45 degrees for left-handed doors.

17

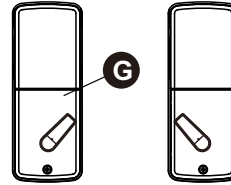

For left-handed door For right-handed door

18. Install Receiver Module

Remove the battery cover (H)
(push it up first then pull it out).

18

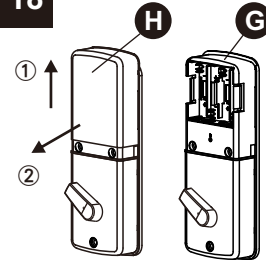

19. Install Receiver Module

Connect the IC wire into the back of the receiver module. Ensure that the deadbolt tailpiece is engaged with turn piece, then attach receiver module (G) to the door with screw (J). Use the optional wood screw (K) to secure the receiver module to wood doors only.

19

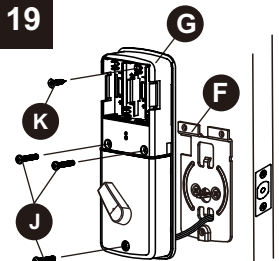

Hardware Used

K Wood screw  x1

This screw is optional. It may not be necessary to use this screw.

J Machine screws  x3

ASSEMBLY INSTRUCTIONS

20. Insert Batteries

Insert 4 (AA) 1.5 V alkaline batteries and slide the battery cover (H) back onto the receiver module (G).

Remarks:

- (1) Alkaline batteries are recommended in order to stabilize the power supply. If you don't use alkaline, battery performance will be reduced greatly.
- (2) All settings will be retained in the memory even if the batteries are completed dead.

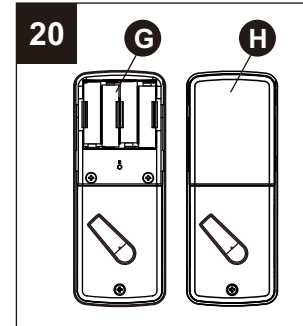

OPERATIONAL INTERFACE

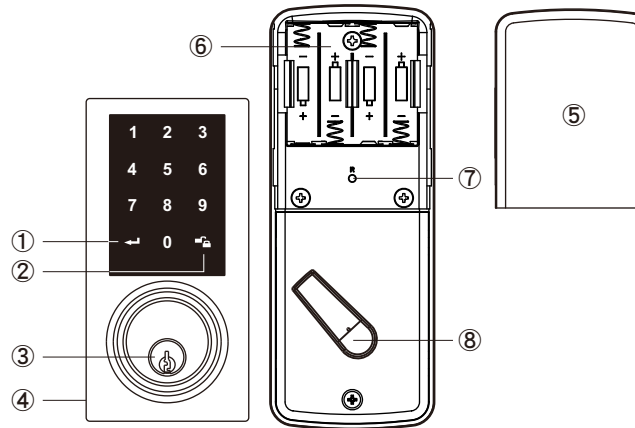

- ① **Programming Button**
Programming button is for setting function.
- ② **Lock Button**
Lock Button is for lock and unlock function.
- ③ **Cylinder**
To lock/unlock the lockset by key from outside.
- ④ **Washer**
Prevents water from permeating into lockset.
- ⑤ **Battery Lid**
Slide the lid to change the batteries.
- ⑥ **Battery Holder**
Four AA (1.5 V) alkaline batteries.
- ⑦ **R Button (Reset)**
Restore default settings.
- ⑧ **Turn-piece**
To lock/unlock the lockset from inside.

OPERATING INSTRUCTIONS

Keep the door open while programming to avoid being locked out accidentally. The lock contains one factory-preset user code but can be programmed to store up to a total of six additional unique user codes. Codes can be added and deleted at any time. For first-time programming, use factory default programming code. It's recommended to change the default programming code and default user code right after you install the lock. Every programming step should be done within 6 seconds.

Operation Indicator Sounds and Lights

Sounds	Lights	Meaning
1 Beep		Successful Operation
2 Long Beeps		Successful Programming
3 Beeps		Operation Error
5 Beeps		Code Input Error; System Shuts Down
10 Rapid Beeps		Low Battery Power
3 Long Beeps		Default Setting Restored
	Lock button flashes slowly	In Programming Mode

OPERATING INSTRUCTIONS

Default programming code (PC): 0000

Default user code (UC): 1234

Your new programming code (PC) _____

Your new user code (UC) _____

The same programming code and user code cannot be accepted.

The lock will cease operation if unauthorized codes are entered over 5 times. The system will unfreeze after 45 seconds.

1. Door Handling Identification Process

The lock needs to learn if your door is a right- or left-handed .



DO THIS FIRST

2. Change Programming Code



3. Add New User Code



Note: Up to 30 sets of user codes can be saved. User codes should be 4–10 digits in length.

4. Delete an Existing User Code



5. Delete All User Codes at Once



Note: Auto-locking and keypad locking functions will be invalid when user codes are deleted.

The lock can only be operated by key during that time.

OPERATING INSTRUCTIONS

6. Toggle Auto-Lock On/Off

Enter PC → [Enter] → 5 → [Enter]

Note: The preset delay-time is 30 seconds, you can change the time by following instructions #7.
Repeat the steps in #6 to cancel the auto-locking function.

7. Set Auto-Lock Time Delay

Enter PC → [Enter] → 6 → [Enter] → Enter Seconds (10~99) → [Enter]

Note: 10–99 seconds delay-time available.

8. Enable/Disable All User Codes

Enter PC → [Enter] → 7 → [Enter]

Note: Auto-locking and keypad locking functions will be invalid when user codes are disabled. The lock can only be operated by key during the time. Repeat the steps to enable the user codes again.

9. Create a One-Time User Code 4–10 Digits Long

Enter PC → [Enter] → 8 → [Enter] → Enter One Time Code → [Enter]

Note: The one-time user code will automatically cancel after it is used one time.

OPERATING INSTRUCTIONS

10. Restore Default Settings

Press 

Note: Press the button for more than 5 seconds; the programming is reset back to the original factory codes once you hear 3 long beeps. After restoring default settings, you must run the door handing identifying process (#1) again before programming any other functions.

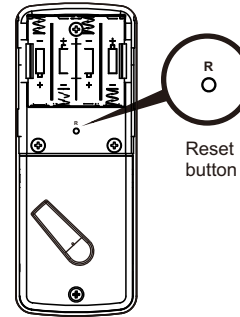

CARE AND MAINTENANCE

Do not use any chemical liquid or lubricating oil with additives to clean the lock body. It will damage the surface or even mainboard.

WARRANTY

The manufacturer warrants the product to be free from defects in material and workmanship for a period of 12 months from the original date of purchase. If you discover a defect in the product covered by this warranty, we will repair or replace the item at our option using new or refurbished components.

EXCLUSIONS

This warranty covers defects in manufacturing discovered while using the products as recommended by the manufacturer rather than occurred by the act of God, and damages caused by misuse, abuse, and unauthorized modification.

LIMITED LIABILITY

The manufacturer will not be held liable for incidental or consequential losses or damages from any act of God.

TROUBLESHOOTING

PROBLEM	POSSIBLE CAUSE	CORRECTIVE ACTION
After installing the lockset and batteries, the door can't be locked and three short beeps are emitted when you press the lock button.	The door-handing identification process isn't yet complete.	Refer to step1, page13.
You've installed the lockset and batteries, but you still get no response when you press any button.	Batteries were installed incorrectly and cable connect incorrectly.	Check to see if the battery polarities have been reversed or if the battery is dead. If so, re-install or change the battery. If not, please check to see if the cable is properly connected.
When you are in the door-handing identifying process, you hear three times, and three short beeps.	Wrong door-handing or change of the door-handing in the memory.	Press the R button to restore the system to factory default setting and re-execute door-handing identifying process (step 1, page 13)
Although you succeeded in the first execution of the door-handing identifying process, the latch still doesn't work. (i.e. You can feel the motor attempting to run.)	Low battery.	Replace with new alkaline batteries.

TROUBLESHOOTING

PROBLEM	POSSIBLE CAUSE	CORRECTIVE ACTION
The door can be locked normally, but when you try to unlock it, you hear three short beeps and the lock won't unlock when you enter the user code and press the lock button.	The functioning of the micro-switch is abnormal.	Call our customer service department.
While the door is locked, you hear the latch bolt coming out when you press the lock button to lock the door; however, three short beeps are emitted. Conversely, while the door is open, no beeps are emitted when locking the latch bolt.	(1) The depth of the latch bolt hole is insufficient. (2) The latch bolt is not aimed at the opening of the strike.	(1) Dig the latch bolt hole for the strike deeper. The minimum depth is 1" (2.5 cm). (2) Adjust the strike to the appropriate position.

Adding/Removing lock

• Adding lock to your Z-Wave gateway

→ Tap add device on your app, then back to lock.

Enter PC → [Left Arrow] → 9 → [Left Arrow]

→ If you hear 2 beeps from your lock the programming was successful. If you hear 5 beeps from your lock you must start over again (the programming failed).

• Removing lock from your Z-Wave gateway

→ Tap add device on your app, then back to lock.

Enter PC → [Left Arrow] → 9 → [Left Arrow]

→ If you hear 5 beeps from your lock you must start over again (the programming failed).

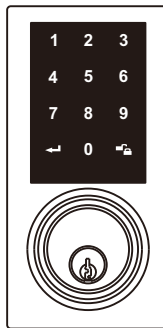

REGULATORY COMPLIANCE

This product complies with standards established by the following regulatory bodies:

- Federal Communications Commission (FCC)
- Industry Canada

FCC

This device complies with Part 15 of the FCC Rules. Operation is subject to the following two conditions:
(1) this device may not cause harmful interference, and (2) this device must accept any interference received, including interference that may cause undesired operation.

This equipment has been tested and found to comply with the limits for a Class B digital device, pursuant to Part 15 of the FCC Rules. These limits are designed to provide reasonable protection against harmful interference in a residential installation.

This equipment generates, uses, and can radiate radio frequency energy and, if not installed and used in accordance with the instructions, may cause harmful interference to radio communications.

However, there is no guarantee that interference will not occur in a particular installation.

If this equipment does cause harmful interference to radio or television reception, which can be determined by turning the equipment off and on, the user is encouraged to try to correct the interference by one or more of the following measures:

- Reorient or relocate the receiving antenna.
- Increase the separation between the equipment and receiver.
- Connect the equipment into an outlet on a circuit different from that to which the receiver is connected.
- Consult the dealer or an experienced radio/TV technician for help.

IMPORTANT !

Changes or modifications not expressly approved by the manufacturer could void the user's authority to operate the equipment.

Añadir/Eliminar cerradura

• Añadir la cerradura a su pasarela Z-Wave

→ Presione añadir dispositivo en su aplicación, luego siga estos pasos en su cerradura.

Ingresar código de programación → [Left Arrow] → 9 → [Left Arrow]

→ Si escucha 2 pitidos la programación de su cerradura fue exitosa. Si escucha 5 pitidos debe iniciar el proceso nuevamente ya que la programación no se completó adecuadamente.

• Eliminar la cerradura de su pasarela Z-Wave

→ Presione eliminar dispositivo en su aplicación, luego siga estos pasos en su cerradura.

Ingresar código de programación → [Left Arrow] → 9 → [Left Arrow]

→ Si escucha 5 pitidos debe iniciar el proceso nuevamente ya que la eliminación no fue exitosa.

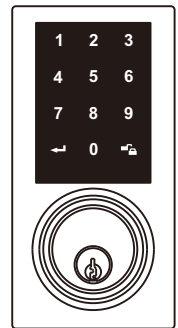

Cumplimiento de normas

Este producto cumple con los estándares establecidos por los siguientes entes reguladores:

- Federal Communications Commission (FCC)
- Industry Canada

FCC

Este dispositivo cumple con la sección 15 de las reglas de la FCC. La operación está sujeta a las siguientes dos condiciones:

(1) Este dispositivo no ha de causar interferencias dañinas, y (2) este dispositivo debe aceptar cualquier interferencia recibida, incluyendo una interferencia que podría causar una operación no deseada.

Este equipo se ha sometido a pruebas y cumplió con los estándares de un dispositivo digital Clase B, en referencia a la sección 15 de las reglas de la FCC.

Estos estándares están diseñados de tal forma que provean una protección razonable en contra de interferencia dañina en una instalación residencial. Este equipo genera, utiliza y podría irradiar energía de frecuencia de radio y, de no instalarse y utilizarse según las instrucciones, podría causar interferencia dañina a sus comunicaciones de radio.

Sin embargo, no hay garantía de que la interferencia no ocurrirá en una instalación en particular.

Si este equipo llegara a causar interferencia dañina a su recepción de radio o televisión, lo cual se podría determinar al encender o apagar todo el equipo, se aconseja que corrija la interferencia tomando una o más de las siguientes medidas:

- Traslade a un Nuevo lugar su antena.
- Aumente la separación entre su equipo y el receptor.
- Conecte el equipo a un enchufe con un circuito distinto al cual está conectado actualmente.
- Consulte a su vendedor o a un técnico con experiencia de radio/televisión para ayuda adicional.

Importante

Cambios o modificaciones hechas al equipo sin autorización escrita por el fabricante podrían invalidar la autoridad del usuario a operarlo.