

Before operating the monitor please read this manual thoroughly. This manual should be retained for future reference.

## **FCC Class B Radio Frequency Interference Statement WARNING: (FOR FCC CERTIFIED MODELS)**

**NOTE:** This equipment has been tested and found to comply with the limits for a Class B digital device, pursuant to Part 15 of the FCC Rules. These limits are designed to provide reasonable protection against harmful interference in a residential installation. This equipment generates, uses and can radiate radio frequency energy, and if not installed and used in accordance with the instructions, may cause harmful interference to radio communications. However, there is no guarantee that interference will not occur in a particular installation. If this equipment does cause harmful interference to radio or television reception, which can be determined by turning the equipment off and on, the user is encouraged to try to correct the interference by one or more of the following measures:

1. Reorient or relocate the receiving antenna.
2. Increase the separation between the equipment and receiver.
3. Connect the equipment into an outlet on a circuit different from that to which the receiver is connected.
4. Consult the dealer or an experienced radio/TV technician for help.

### **NOTICE**

1. The changes or modifications not expressly approved by the party responsible for compliance could void the user's authority to operate the equipment.
2. Shielded interface cables and AC power cord, if any, must be used in order to comply with the emission limits.
3. The manufacturer is not responsible for any radio or TV interference caused by unauthorized modification to this equipment. It is the responsibilities of the user to correct such interference.

As an ENERGY STAR® Partner our company has determined that this product meets the ENERGY STAR® guidelines for energy efficiency.

### **WARNING :**

To prevent fire or shock hazard, do not expose the monitor to rain or moisture. Dangerously high voltages are present inside the monitor. Do not open the cabinet. Refer servicing to qualified personnel only.

# Contents

<b>Packing list</b> .....	2
<b>Precautions</b> .....	3
<b>Installation Instructions</b> .....	3
<b>Swivel Base</b> .....	4
<b>Power cord</b> .....	4
<b>Video cable</b> .....	5
<b>Operating Instructions</b> .....	6
<b>General Instructions</b> .....	6
<b>Front panel control</b> .....	7
<b>How to adjust a setting</b> .....	7
<b>Adjusting the picture</b> .....	8
<b>Plug and play</b> .....	10
<b>Technical Support (FAQ)</b> .....	11
<b>Appendix A – Specifications</b> .....	12-13
<b>Appendix B – Factory Preset Timing Table</b> .....	14

## PACKING LIST

The product package should include the following items:

1. Pure Flat Color Monitor
2. Owner's Manual
3. Power Cord
4. Swivel Base

## PRECAUTIONS

- Do not use the monitor near water, e.g. near a bathtub, washbowl, kitchen sink, laundry tub, swimming pool or in a wet basement.
- Do not place the monitor on an unstable cart, stand, or table. If the monitor falls, it can injure a person and cause serious damage to the appliance. Use only a cart or stand recommended by the manufacturer or sold with the monitor. If you mount the monitor on a wall or shelf, use a mounting kit approved by the manufacturer and follow the kit instructions.
- Slots and openings in the back and bottom of the cabinet are provided for ventilation. To ensure reliable operation of the monitor and to protect it from overheating, be sure these openings are not blocked or covered. Do not place the monitor on a bed, sofa, rug, or similar surface. Do not place the monitor near or over a radiator or heat register. Do not place the monitor in a bookcase or cabinet unless proper ventilation is provided.
- The monitor should be operated only from the type of power source indicated on the label. If you are not sure of the type of power supplied to your home, consult your dealer or local power company.
- The monitor is equipped with a three-pronged grounded plug, a plug with a third (grounding) pin. This plug will fit only into a grounded power outlet as a safety feature. If your outlet does not accommodate the three-wire plug, have an electrician install the correct outlet, or use an adapter to ground the appliance safely. Do not defeat the safety purpose of the grounded plug.
- Unplug the unit during a lightning storm or when it will not be used for long periods of time. This will protect the monitor from damage due to power surges.
- Do not overload power strips and extension cords. Overloading can result in fire or electric shock.
- Never push any object into the slot on the monitor cabinet. It could short circuit parts causing a fire or electric shock. Never spill liquids on the monitor.
- Do not attempt to service the monitor yourself; opening or removing covers can expose you to dangerous voltages and other hazards. Please refer all servicing to qualified service personnel.
- To ensure satisfactory operation, use the monitor only with UL listed computers which have appropriate configured receptacles marked between 100 - 240 VAC, Min. 2.5A.
- The wall socket shall be installed near the equipment and shall be easily accessible.

# INSTALLATION INSTRUCTIONS

## Swivel Base

**To attach the swivel base to the monitor, do the following:**

- ? Carefully turn the monitor on its side or upside down. ( see figure 1 )
- ? Locate the cavities at the bottom front of the monitor.
- ? Insert the pegs on the swivel base into these cavities. Push the swivel base forward until the swivel base locks in place.
- ? To remove the swivel base, hold the bottom of the swivel base, then push it out.

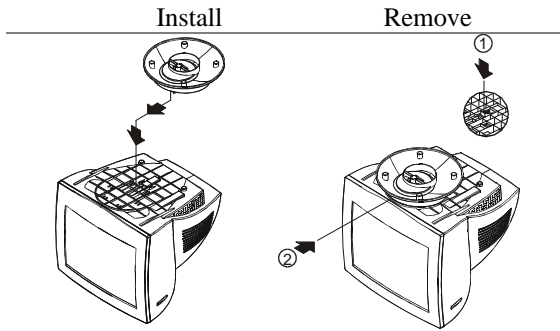

Figure 1 Installing and Removing the Swivel Base

## Power Cord

### Power Source:

1. Make sure the power cord is the correct type that required in your area.
2. This monitor has a universal power supply that allows operation in either 100/120V AC or 220/240V AC voltage area ( No user adjustment is required. )
3. Connect the power cord into your monitor's power input socket, and then plug the other end into a 3-pin AC power outlet. The power cord may be connected to either a wall power outlet or the power outlet socket on your PC, depending on the type of power cord supplied with your monitor.

## Video cable

**Connecting the Video Cable:** The monitor comes with a built-in video cable. Plug the signal cable's 15-pin connector into the computer's video port and tighten the two screws on the cable connector.

**Caution:** *Don't bend the signal cable, otherwise it will break the inner wire.*

**Connecting the Power Cord:** Plug the power cord into the monitor's AC power socket. Then plug the power cord into a grounded AC outlet or UL-approved power strip or the power output socket on your PC.

**Caution:** *If the AC outlet is not grounded, install the proper grounding adapter (not supplied).*

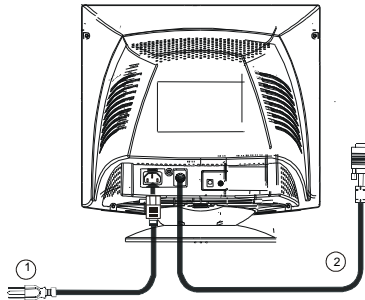

Figure 2 Connecting Cables

1.	Power Cord	2.	Signal Cable
----	------------	----	--------------

# OPERATING INSTRUCTIONS

## General Instructions

The other control knobs are located at the base of the monitor (See Figure 3). By changing these settings, the picture can be adjusted to your personal preferences.

- ? The power cord should be connected.
- ? Connect the video cable from the monitor to the video card.
- ? To turn the monitor on, press the POWER switch to ON position. The power indicator will light up.
- ? Your monitor features a unique quick switch system which provides a picture within seconds after the monitor is switched on.

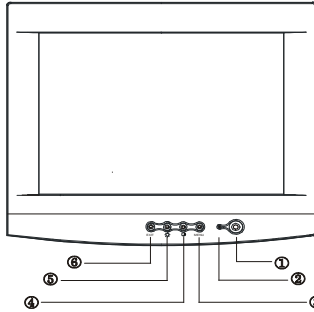

Figure 3 External Control Knob

## EXTERNAL CONTROLS





1.	POWER
2.	POWER INDICATOR
3.	MENU
4.	CONTRAST/ ►
5.	BRIGHTNESS/ ◀
6.	EXIT

## Notes

- ? Do not install the monitor in a location near heat sources such as radiators or air ducts, or in a place subject to direct sunlight, or excessive dust or mechanical vibration or shock.
- ? Save the original shipping carton and packing materials, as they will come in handy if you ever have to ship your monitor.
- ? For maximum protection, repackage your monitor as it was originally packed at the factory.
- ? To keep the monitor looking new, periodically clean it with a soft cloth. Stubborn stains may be removed with a cloth lightly dampened with a mild detergent solution. Never use strong solvents such as thinner,

benzene, or abrasive cleaners, since these will damage the cabinet. As a safety precaution, always unplug the monitor before cleaning it.

## Front Panel Control

- ?  : Press this knob to switch ON/OFF of monitor's power.
- ? **MENU** : Active OSD menu or function adjust confirm.
- ?  /  : Adjust contrast or function adjust.
- ?  /  : Adjust brightness or function adjust.
- ? **EXIT** : Exit a function or inactive OSD menu.
- ? **Power Indicator** :
  - Green — Power On mode.
  - Orange — Off mode.

## How to adjust a setting

The monitor controls are accessed by pressing button MENU to enable OSD (On-Screen-Display). The main menu will be displayed as follows.

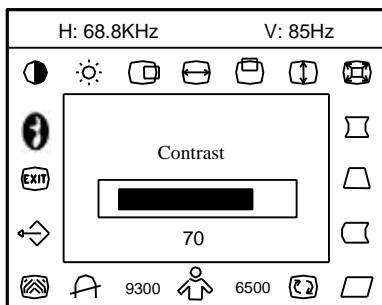















Figure 4 The OSD Message

**Note:** If adjustment or selection of any OSD menu is not made for more than 10 seconds, the current setup will be saved and the OSD will disappear automatically.

## Adjusting the picture

The description for functional control icons

1. CONTRAST  :  
Adjust the picture contrast.
2. BRIGHTNESS  :  
Adjust the picture brightness.
3. H-CENTER  :  
Adjust the horizontal position of the picture.
4. H-SIZE  :  
Adjust the picture's horizontal size.
5. V-CENTER  :  
Adjust the vertical position of the picture.
6. V-SIZE  :  
Adjust the picture's vertical size.
7. ZOOM  :  
Adjust the picture's horizontal and vertical size simultaneously.
8. PINCUSHION  :  
Adjust the pincushion and barrel .
9. TRAPEZOID  :  
Adjust the picture's trapezoid distortion.
10. PIN-BALANCE  :  
Adjust to compensate the pincushion unbalance.
11. PARALLELOGRAM  :  
Adjust the picture to be a rectangle.
12. ROTATION  :  
Adjust the picture tilt to horizontal position.
13. 6500°K/9300°K ( COLOR TEMPERATURE ) :  
The color temperature for 6500°K is  $x=0.313$ ,  $y=0.329$  and 9300°K is  $x=0.283$ ,  $y=0.297$ . It presents two different color sets on the screen.  
You can select 9300°K or 6500°K by pressing MENU Key.
14. USER COLOR ( Red / Blue )  :  
If the 9300°K normal white or 6500°K warmer white do not satisfy your desire, properly adjust R . B GAIN controls to obtain your optimum whiteness level.
15. DEGAUSS  :  
If color impurity occurs when moving or swiveling the monitor, press MENU Key and degauss to fix the picture condition.



16. MOIRE REDUCE



Moire is the result of interference between the phosphor layout and the video signal. In some cases, you may find the moire very noticeable. Press the MENU to enter in the moire reduce setting. Please adjust the level to the optimum condition. Note: Too high of a setting will cause the picture to shake.

17. RECALL



Press RECALL to restore the monitor to factory settings.

18. EXIT



Close OSD window.

19. SELECT LANGUAGE



Select the language as you like.

**THIS MONITOR WILL APPEAR TO BE NON-FUNCTIONAL IF THERE IS NO VIDEO INPUT SIGNAL. IN ORDER FOR THIS MONITOR TO OPERATE PROPERLY, THERE MUST BE A VIDEO INPUT SIGNAL.**

This monitor meets the Green Monitor standards as set by the Video Electronics Standards Association (VESA) and/or the United States Environmental Protection Agency (EPA) and The Swedish Confederation Employees ( NUTEK ). This feature is designed to conserve electrical energy by reducing power consumption when there is no video input signal present. When there is no video input signal this monitor, following a time-out period, will automatically switch to an OFF mode. This reduces the monitor's internal power supply consumption. After the video input signal is restored, full power is restored and the display is automatically redrawn. The appearance is similar to a "Screen Saver" feature except the display is completely off. The display is restored by pressing a key on the keyboard, or clicking the mouse.

## **Plug and play**

### **Plug & Play DDC1/2B Feature**

This monitor is equipped with VESA DDC1/2B capabilities according to the VESA DDC STANDARD. It allows the monitor to inform the host system of its identity and, depending on the level of DDC used, communicate additional information about its display capabilities. The communication channel is defined in two levels, DDC1 and DDC2B.

The DDC1 is a unidirectional data channel from the display to the host that continuously transmits EDID information. The DDC2B is a bidirectional data channel based on the I<sup>2</sup>C protocol. The host can request EDID information over the DDC2B channel.

### **Video Cable Pin Assignments:**

1. Red	5. Ground	9. NC	13. H-sync
2. Green	6. R-Ground	10. Ground	14. V- sync / * VCLK
3. Blue	7. G-Ground	11. Monitor Ground	15. DDC-Serial Clock
4. Ground	8. B-Ground	12. DDC-Serial Data	* FOR DDC

## TECHNICAL SUPPORT (FAQ)

Problem & Question	Possible Solution
Power LED is not on	<ul style="list-style-type: none"> <li>*Check if the Power Switch is in the ON position</li> <li>*Power Cord should be connected</li> </ul>
No Plug & Play	<ul style="list-style-type: none"> <li>*Check if the PC system is Plug &amp; Play compatible</li> <li>*Check if the Video Card is Plug &amp; Play compatible</li> <li>*Check if the D-15 plug pin of Video Cable is bent</li> <li>*Make sure the Monitor Drivers are installed</li> </ul>
Picture is fuzzy	<ul style="list-style-type: none"> <li>*Adjust the Contrast and Brightness Controls.</li> </ul>
Picture bounces or a wave pattern is present in the picture	<ul style="list-style-type: none"> <li>*Move electrical devices that may cause electrical interference.</li> </ul>
The power LED is ON (orange) but there's no video or no picture.	<ul style="list-style-type: none"> <li>*Computer Power Switch should be in the ON position</li> <li>*Computer Video Card should be snugly seated in its slot</li> <li>*Make sure monitor's video cable is properly connected to the computer.</li> <li>*Inspect monitor's video cable and make sure none of the pins are bent.</li> <li>*Make sure computer is operational by hitting the CAPS LOCK key on the keyboard while observing the CAPS LOCK LED. The LED should either turn ON or OFF after hitting the CAPS LOCK key.</li> </ul>
Missing one of the primary colors (RED, GREEN, or BLUE)	<ul style="list-style-type: none"> <li>*Inspect the monitor's video cable and make sure that none of the pins are bent.</li> </ul>

## APPENDIX A - SPECIFICATIONS

CRT	48.3cm(19"), 90° deflection, 29mm neck, 0.25mm dot pitch non-glare screen.
Viewable Image Size	45.7cm (18"), diagonal
Display Color	Unlimited colors
Input Signal	Analog input All timing that meets scanning frequencies
? Video	? Analog R, G, B 0.7Vpp positive/75 ohm
? Sync.	? Horizontal sync. : Positive/Negative ? Vertical sync. : Positive/Negative
Synchronization	
? Horizontal	30kHz to 95kHz automatically
? Vertical	50Hz to 160Hz automatically
Max. Resolution	1600 × 1200
Video Dot Rate	200MHz
Factory Preset Timings :	8
User mode Timings :	20
Misconvergence	
? Center	0.3mm Max.
? Corner	0.4mm Max.
Power Source	Switching mode power supply AC 100-240V, 50Hz/60Hz full range
Operating Humidity	0°C to 40°C ambient 10% to 85% relative, non-condensing
Weight	20.0kg(Net)
Dimensions	
• Monitor	446(W) × 436(H) × 455(D)mm
Signal Cable	15 pin mini D-Sub
External Controls:	
Switch	? Power On/Off Switch ? MENU Key ? Contrast/▶UP Key ? Brightness/◀Down Key ? EXIT Key

Functions ( OSD )	? Contrast ? Brightness ? H-Center ? H-Size ? V-Center ? V-Size ? Zoom ? Pincushion ? Trapezoid ? Pin-Balance ? Parallelogram ? Rotation ? 6500°K ? User color ? 9300°K ? Degauss ? Moire Reduce ? Recall ? Exit ? Select language	
Plug & Play	DDC1/2B	
EPA ENERGY STAR®	On Mode	= 130W
	Off Mode	= 5W
Power consumption	130W Max.	
Preset display area	346mm × 260 mm	
Regulations	UL, CSA, TÜV / GS, FCC, FDA, MPR II	

## APPENDIX B – FACTORY PRESET TIMING TABLE

STANDARD	RESOLUTION	HORIZONTAL FREQUENCY	VERTICAL FREQUENCY
VGA	720 × 400	31.5kHz	70Hz
VGA	640 × 480	31.5kHz	60Hz
VESA/85	640 × 480	43.3kHz	85Hz
VESA/85	800 × 600	53.7kHz	85Hz
VESA/85	1024 × 768	68.7kHz	85Hz
VESA/85	1280 × 960	85.9kHz	85Hz
VESA/85	1280 × 1024	91.1kHz	85Hz
VESA/75	1600 × 1200	93.8kHz	75Hz