

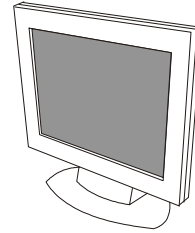

Your Work Never Looked Better

Spectrum Series



LM-700

## USER MANUAL

### TABLE OF CONTENTS

FOR YOUR SAFETY -----	1
SAFETY PRECAUTIONS -----	2
SPECIAL NOTES ON LCD MONITORS -----	3
BEFORE YOU OPERATE THE MONITOR -----	3
FEATURES -----	3
PACKING LIST -----	3
INSTALLATION INSTRUCTIONS -----	4
CONTROLS AND CONNECTORS -----	5
ADJUSTING THE VIEWING ANGLE -----	6
OPERATING INSTRUCTIONS -----	7
GENERAL INSTRUCTIONS -----	7
HOW TO ADJUST A SETTING -----	9
ADJUSTING THE PICTURE -----	9-10
POWER MANAGEMENT FEATURE -----	10
PLUG AND PLAY -----	12
TECHNICAL SUPPORT(FAQ) -----	14-15
ERROR MESSAGE & POSSIBLE SOLUTION -----	16
HOW TO INSTALL INF & ICM FILE -----	17
APPENDIX -----	18
SPECIFICATIONS -----	18-19
FACTORY PRESET TIMING TABLE -----	20
CONNECTOR PIN ASSIGNMENT -----	21
LIMITED THREE-YEAR WARRANTY -----	22-23

English



Thank you very much for choosing AOC LM-700 LCD Monitor.

We recommend that you take a few minutes to read carefully through this manual before installing and switching on the monitor. Please keep this manual in a safe place for your future reference.

Note : The Audio port is not available till now. Top Victory doesn't provide this port before Submitted to FCC.

Plug & Play Drivers for the AOC Spectrum Series Monitors are available at AOC's Web Site: [www.aoc-europe.com](http://www.aoc-europe.com)

Before operating the monitor, please read this manual thoroughly. This manual should be retained for future reference.

**FCC Class B Radio Frequency Interference Statement**  
**WARNING: (FOR FCC CERTIFIED MODELS)**

**NOTE:** This equipment has been tested and found to comply with the limits for a Class B digital device, pursuant to Part 15 of the FCC Rules. These limits are designed to provide reasonable protection against harmful interference in a residential installation. This equipment generates, uses and can radiate radio frequency energy, and if not installed and used in accordance with the instructions, may cause harmful interference to radio communications. However, there is no guarantee that interference will not occur in a particular installation. If this equipment does cause harmful interference to radio or television reception, which can be determined by turning the equipment off and on, the user is encouraged to try to correct the interference by one or more of the following measures:

1. Reorient or relocate the receiving antenna.
2. Increase the separation between the equipment and receiver.
3. Connect the equipment into an outlet on a circuit different from that to which the receiver is connected.
4. Consult the dealer or an experienced radio/TV technician for help.

**NOTICE**

1. The changes or modifications not expressly approved by the party responsible for compliance could void the user's authority to operate the equipment.
2. Shielded interface cables and AC power cord, if any, must be used in order to comply with the emission limits.
3. The manufacturer is not responsible for any radio or TV interference caused by unauthorized modification to this equipment. It is the responsibilities of the user to correct such interference.

As an ENERGY STAR® Partner AOC International has determined that this product meets the ENERGY STAR® guidelines for energy efficiency.

**WARNING:**

To prevent fire or shock hazard, do not expose the monitor to rain or moisture. Dangerously high voltages are present inside the monitor. Do not open the cabinet. Refer servicing to qualified personnel only.

## PRECAUTIONS

- Do not use the monitor near water, e.g. near a bathtub, washbowl, kitchen sink, laundry tub, swimming pool or in a wet basement.
- Do not place the monitor on an unstable cart, stand, or table. If the monitor falls, it can injure a person and cause serious damage to the appliance. Use only a cart or stand recommended by the manufacturer or sold with the monitor. If you mount the monitor on a wall or shelf, use a mounting kit approved by the manufacturer and follow the kit instructions.
- Slots and openings in the back and bottom of the cabinet are provided for ventilation. To ensure reliable operation of the monitor and to protect it from overheating, be sure these openings are not blocked or covered. Do not place the monitor on a bed, sofa, rug, or similar surface. Do not place the monitor near or over a radiator or heat register. Do not place the monitor in a bookcase or cabinet unless proper ventilation is provided.
- The monitor should be operated only from the type of power source indicated on the label. If you are not sure of the type of power supplied to your home, consult your dealer or local power company.
- The monitor is equipped with a three-pronged grounded plug, a plug with a third (grounding) pin. This plug will fit only into a grounded power outlet as a safety feature. If your outlet does not accommodate the three-wire plug, have an electrician install the correct outlet, or use an adapter to ground the appliance safely. Do not defeat the safety purpose of the grounded plug.
- Unplug the unit during a lightening storm or when it will not be used for long period of time. This will protect the monitor from damage due to power surges.
- Do not overload power strips and extension cords. Overloading can result in fire or electric shock.
- Never push any object into the slot on the monitor cabinet. It could short circuit parts causing a fire or electric shock. Never spill liquids on the monitor.
- Do not attempt to service the monitor by yourself; opening or removing covers can expose you to dangerous voltages and other hazards. Please refer all servicing to qualified service personnel.
- To ensure satisfactory operation, use the monitor only with UL listed computers which have appropriate configured receptacles marked between 100 - 240V AC, Min. 3.5A.
- The wall socket shall be installed near the equipment and shall be easily accessible.
- For use only with power adaptor manufacturer by **CHI SAM ELECTRONIC** , model **CH-1205**

## SPECIAL NOTES ON LCD MONITORS

The following symptoms are normal with LCD monitor and do not indicate a problem.

### NOTES

- Due to the nature of the fluorescent light, the screen may flicker during initial use. Turn off the Power Switch and then turn it on again to make sure the flicker disappears.
- You may find slightly uneven brightness on the screen depending on the desktop pattern you use.
- The LCD screen has effective pixels of 99.99% or more. It may include blemishes of 0.01% or less such as a missing pixel or a pixel lit all of the time.
- Due to the nature of the LCD screen, an afterimage of the previous screen may remain after switching the image, when the same image is displayed for hours. In this case, the screen is recovered slowly by changing the image or turning off the Power Switch for hours.
- The life of the fluorescent light used in the LCD monitor is approximately 10,000 hours. Contact your dealer or EPI service center for replacement when the screen is dark, flickering or not lighting up. Never attempt to replace it by yourself.

## BEFORE YOU OPERATE THE MONITOR

### FEATURES

- 43.7cm(17") TFT Color LCD Monitor
- Crisp, Clear Display for Windows
- Supports Resolutions up to 1280 X 1024@75Hz
- Power Management
- Ergonomic Design (MPRII Approved)
- Space Saving, Compact Case Design

### CHECKING THE CONTENTS OF THE LM-700 PACKAGE

The product package should include the following items:

1. LCD Monitor
2. Owner's Manual
3. Power Cord
4. External Adapter
5. Driver-Disk

## INSTALLATION INSTRUCTIONS

### SWIVEL BASE

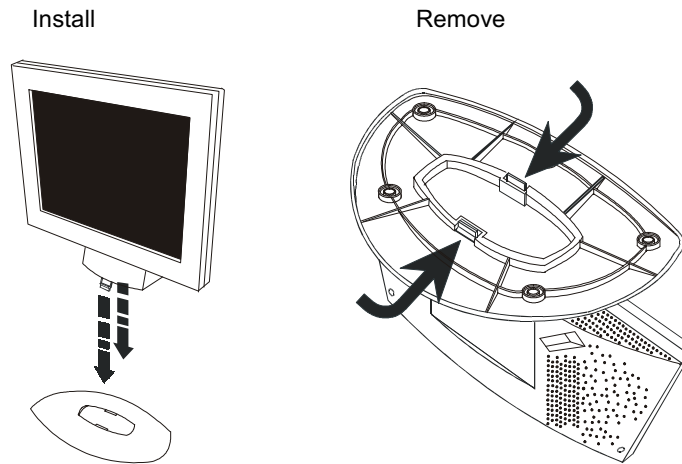

Figure 1 Installing and Removing the Swivel Base

### POWERCORD

#### Power Source:

1. Make sure that the power cord is the correct type required in your area.
2. This LCD monitor has an External universal power supply that allows operation in either 100/120V AC or 220/240V AC voltage area (No user adjustment is required.)
3. Connect the AC-power cord into your LCD monitor's External Adapter input socket, and then plug the other end of External adapter to LCD monitor's DC-power-input. The AC-power cord may be connected to either a wall power outlet or the power outlet socket on your PC, depending on the type of power cord supplied with your LCD monitor.

## CONTROLS AND CONNECTORS

### SIGNAL CABLE

**Connecting the Signal Cable:** the LCD monitor comes with a built-in signal cable. Plug the signal cable's 15-pin connector into the computer's VGA port and tighten the two screws on the cable connector.

**Connecting the Power Cord:** Plug the AC-power cord into the External Adapter. Then plug the DC-jack power cable into DC-IN Inlet .

**Caution:** *If the AC outlet is not grounded (with three holes), install the proper grounding adapter (not supplied).*

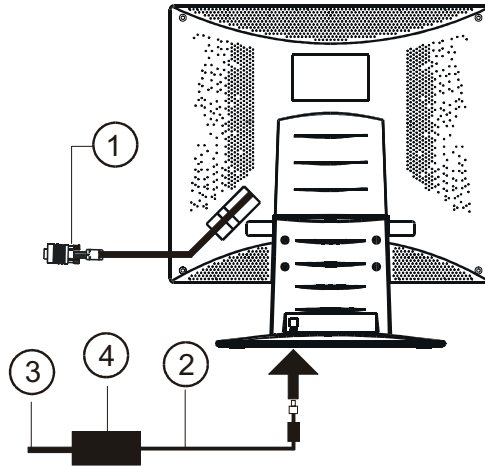

Figure 2 Connecting Cables

1.	Signal Cable	3.	AC Power Cord
2.	DC-Jack Power Cable	4.	External Adapter

## ADJUSTING THE VIEWING ANGLE

- For optimal viewing it is recommended to look at the full face of the monitor, then adjust the monitor's angle to your own preference.
- Hold the stand so you do not topple the monitor when you change the monitor's angle.
- You are able to adjust the monitor's angle from  $-5^{\circ}$  to  $30^{\circ}$ .

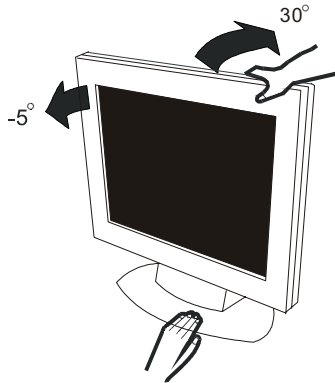

Figure 3

## NOTES

- Do not touch the LCD screen when you change the angle. It may cause damage or break the LCD screen.
- Careful attention is required not to catch your fingers or hands when you change the angle.

# OPERATING INSTRUCTIONS

## GENERAL INSTRUCTIONS

Press the power button to turn the monitor on or off. The other control buttons are located at front panel of the monitor (See Figure 4). By changing these settings, the picture can be adjusted to your personal preferences.

- The power cord should be connected.
- Connect the video cable from the monitor to the video card.
- Press the power button to turn on the monitor position. The power indicator will light up.

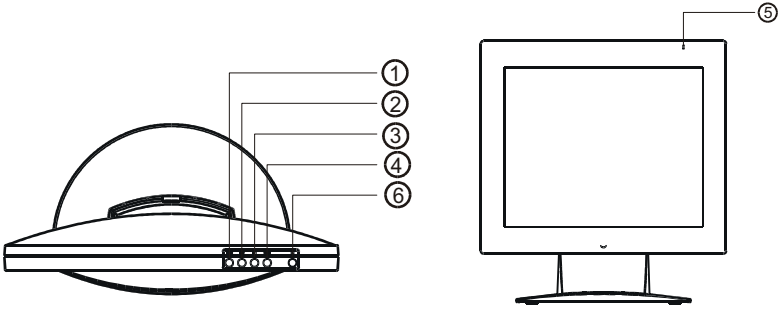





Figure 4 External Control Button

## EXTERNAL CONTROLS

1. Auto Config / Exit	2. ◀ / Brightness
3. ▶ / Contrast	4. MENU / ENTER
5. LED	6. Power Button



## FRONT PANEL CONTROL

- **Power:**  
Press this button to switch ON/OFF of monitor's power.
- **MENU / ENTER :**  
Active OSD menu or function adjust confirm or Exit OSD menu when in Brightness/Contrast OSD status.
- **Contrast**  /  :  
Adjust contrast or function adjust.
- **Brightness**  /  :  
Adjust brightness or function adjust.
- **Auto Adjust button / Exit:**
  1. When OSD menu is in active status, this button will act as EXIT-KEY (EXIT OSD menu)
  2. When OSD menu is in off status, press this button over 2 seconds to activate the Auto Adjustment function.The Auto Adjustment function is used to set the HPos, VPos, Clock and Focus
- **Power Indicator:**

Green	—	Power On mode.
Orange	—	Stand-by mode, Suspend mode, or Off mode.

## NOTES

- Do not install the monitor in a location near heat sources such as radiators or air ducts, or in a place subject to direct sunlight, or excessive dust or mechanical vibration or shock.
- Save the original shipping carton and packing materials, as they will come in handy if you ever have to ship your monitor.
- For maximum protection, repackage your monitor as it was originally packed at the factory.
- To keep the monitor looking new, periodically clean it with a soft cloth. Stubborn stains may be removed with a cloth lightly dampened with a mild detergent solution. Never use strong solvents such as thinner, benzene, or abrasive cleaners, since these will damage the cabinet. As a safety precaution, always unplug the monitor before cleaning it.

## HOW TO ADJUST A SETTING

1. Press the MENU-button to activate the OSD window. See figure 5.
2. Press ◀ or ▶ to select the desired function. See figure 5.
3. Press the MENU-button to select the function that you want to adjust.
4. Press ◀ or ▶ to change the settings of the current function.
5. When the OSD window is active, it shows the input signal timing. The "H" stands for the horizontal frequency and "V" for the vertical frequency.
6. To exit and save, select the exit function, or leave the monitor alone for 10 seconds. If you want to adjust any other function, repeat steps 2-4.

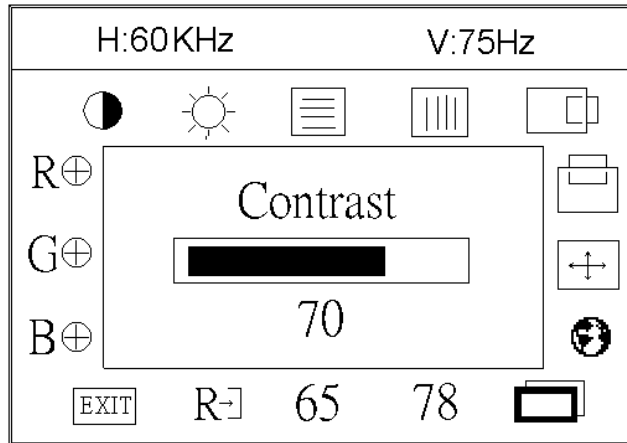













Figure 5 The OSD Message

## ADJUSTING THE PICTURE

The descriptions for function control LEDs

1.		CONTRAST	Adjust the picture contrast.
2.		BRIGHTNESS	Adjust the picture brightness.
3.		FOCUS	Adjust picture Focus.
4.		CLOCK	Adjust picture Clock.

5.		H- Position	Adjust the horizontal position of the picture.
6.		V- Position	Adjust the vertical position of the picture.
7.		Auto Center	Used to center the picture automatically.
8.		Language	Multi-Language selection
		Dos-mode selected	Dos-mode resolution selection for 720x400 @70Hz and 640x400 @70Hz
10.		Color Temperature	Adjusts Red intensity.
11.		Color Temperature	Adjusts Green intensity.
12.		Color Temperature	Adjusts Blue intensity.
13.	<b>65</b>	Color Temperature	The color temperature for 6500°K is x=0.313, y=0.329.
14.	<b>78</b>	Color Temperature	The color temperature for 7800°K is x=0.296, y=0.311.
15.		RECALL	Clear each old status of Auto-configuration and re-do auto-configuration and set the color temperature to 7800°K.
16.		EXIT	Save user adjustment and OSD disappear.

**Notice:** for “**Dos-mode selected**” function ,after selected the icon  press MENU to confirm the selection , press ◀ or ▶ to change to 720x400 or 640x400 , press MENU again to confirm and then **press POWER button off then on for activate the setup** (for general, most of the Dos mode was set in 720x400@70Hz)

### HOW TO OPTIMIZE THE DOS-MODE

1. Use the full-screen pattern which is attached in your driver-disk to start the adjustment ( press twice at **Dos1.exe** , and expand the picture to full screen with pressing the icon  on the top of window, but there is nothing to press if the picture is already full screen )

If you don't have monitor driver disk, you can try the following way to get the full screen pattern at MS-DOS mode , type in C:\> **EDIT** [press enter]  
You will in the Dos-Editor screen

2. Press “AUTO” button( at front bezel) during 2 seconds , the monitors will do all the adjustment automatically

If the DOS-MODE character still have distortion ( ex : the picture can't go to full screen, the background of white pattern has vertical stripe noise, the character twisted) , that means your monitor parameter was in wrong resolution, please change the resolution to 640x400 as following process:

- A). Press MENU to activate the OSD windows
- B). Press ◀ or ▶ to selected the icon 
- C). Press MENU to confirm
- D). Press ◀ or ▶ to change to 640x400
- E). Press MENU to confirm, then press POWER button off then on to activate the setup

Finally press “ **AUTO** ” button again to make sure your performance (notice : above procedure must process in full-screen pattern)

3.Press “ **ESC** ” to quit the pattern file ,or press **ALT-F**, and then **X** to exit from the Dos-Editor screen

## POWER MANAGEMENT FEATURE

The power management feature of this product complies with every power saving requirements of ENERGY STAR® and VESA DPMS when activated, it automatically reduces unnecessary power consumption of the monitor when your computer is not in use.

To use the feature, the monitor needs to be connected to a VESA DPMS computer. There are three power management modes available, these are described below. The required settings, including the timer setting, should be made by the computer.

- **Stand-by Mode**

When the H-sync signal from the computer is off, the monitor enters into Stand-by Mode, which reduces the power consumption to less than 3W. The screen becomes dark, and the power indicator turns to orange. From Stand-by Mode, the screen reappears instantaneously when the keyboard or the mouse is touched again.

- **Suspend Mode**

When the V-sync signal from the computer is off, the monitor enters into Suspend Mode which reduces the power consumption to less than 3W. The screen becomes dark, and the power indicator turns to orange. From Suspend Mode, the screen reappears instantaneously when the keyboard or the mouse is touched again.

- **Active-off Mode**

When both the H and V sync signals from the computer are off, the monitor enters into Active-off Mode which reduces the power consumption to less than 3W. The screen becomes dark, and the power indicator turns to orange. From Active-off Mode, the screen reappears instantaneously when the keyboard or the mouse is touched again.

- The power-saving mode can be indicated by the light-emitting diode (LED) on the front panel:

Mode	Signal				Power	
	Cable	H-Sync	V-Sync	Video	Indicator	Consumption
On*	Attached	Yes	Yes	Active	Green	≤ 55 W
Stand-by	Attached	No	Yes	Blank	Orange	≤ 3 W
Suspend	Attached	Yes	No	Blank	Orange	≤ 3 W
Off	Attached	No	No	Blank	Orange	≤ 3 W

**Note:** The power consumption is calculated without audio power consumption at power saving status.

## FEATURES

### Green monitor

- The monitor has a power saving function that conforms to the VESA DPMS standard. This feature will only work if your PC is a green PC. This feature is similar to a screen saver, except that your monitor will turn it off instead of activating the screen saver.

To activate this feature in Windows® 98:

In Windows® 98, this feature can be activated and customized under the screen saver setting of the display properties.

1. Right click on the desktop and choose Properties.
2. Click on the tab that says Screen Saver. If your system supports Green PC, there will be a section entitled "Energy Saving Features of Monitor." If there isn't a section like that, then your PC does not support Green Monitor. The monitor will behave just like a normal monitor, so you will have to turn it off manually to save energy.
3. In the "Energy Saving Features of Monitor" sections are two boxes, Standby and Shut off. To activate either one, click the box next to each one.
4. You can specify the amount of inactive time before your monitor enters standby mode or shuts off.

## PLUG AND PLAY

### Plug & Play DDC1/2B Feature

This monitor is equipped with VESA DDC1/2B capabilities according to the VESA DDC STANDARD. It allows the monitor to inform the host system of its identity and, depending on the level of DDC used, communicate additional information about its display capabilities. The communication channel is defined in two levels, DDC1 and DDC2B.

The DDC1 is a unidirectional data channel from the display to the host that continuously transmits EDID information. The DDC2B is a bidirectional data channel based on the I<sup>2</sup>C protocol. The host can request EDID information over the DDC2B channel.

**THIS MONITOR WILL APPEAR TO BE NON-FUNCTIONAL IF THERE IS NO VIDEO INPUT SIGNAL. IN ORDER FOR THIS MONITOR TO OPERATE PROPERLY, THERE MUST BE A VIDEO INPUT SIGNAL.**

This monitor meets the Power Management standards as set by the Video Electronics Standards Association (VESA) and/or the United States Environmental Protection Agency (EPA) and The Swedish Confederation Employees (NUTEK). This feature is designed to conserve electrical energy by reducing power consumption when there is no video-input signal present. When there is no video input signal this monitor, following a time-out period, will automatically switch to an OFF mode. This reduces the monitor's internal power supply consumption. After the video input signal is restored, full power is restored and the display is automatically redrawn. The appearance is similar to a "Screen Saver" feature except the display is completely off. The display is restored by pressing a key on the keyboard, or clicking the mouse.

**USING THE RIGHT POWER CORD :**

The accessory power cord for the Northern American region is the wallet plug with NEMA 5-15 style and is UL listed and CSA labeled. The voltage rating for the power cord shall be 125 volts AC.

Supplied with units intended for connection to power outlet of personal computer: Please use a cord set consisting of a minimum No. 18 AWG, type SJT or SVT three conductors flexible cord. One end terminates with a grounding type attachment plug, rated 10A, 250V, CEE-22 male configuration. The other end terminates with a molded-on type connector body, rated 10A, 250V, having standard CEE-22 female configuration.

## TECHNICAL SUPPORT (FAQ)

Problem & Question	Possible Solution
Power LED is not on	<ul style="list-style-type: none"> <li>*Check if the Power Switch is in the ON position</li> <li>*Power Cord should be connected</li> </ul>
No Plug & Play	<ul style="list-style-type: none"> <li>*Check if the PC system is Plug &amp; Play compatible</li> <li>*Check if the Video Card is Plug &amp; Play compatible</li> <li>*Check if the D-15 plug pin of Video Cable is bent</li> <li>*Make sure the AOC Monitor Drivers are installed (AOC Monitor Drivers are available at: <a href="http://www.aoc-europe.com">www.aoc-europe.com</a>)</li> </ul>
No picture	<ul style="list-style-type: none"> <li>*Computer Power Switch should be in the ON position</li> <li>*Computer Video Card should be snugly seated in its slot</li> <li>*The Signal Cable should be completely connected to the computer</li> <li>*Check the color of the Power LED indicator. If it is orange, then the monitor and the PC system are in power-saving mode. You need press your keyboard or move the mouse to reactivate the system.</li> </ul>
Picture is fuzzy	*Adjust the Contrast and Brightness Controls.
Picture bounces or a wave pattern is present in the picture	*Move electrical devices that may cause electrical interference.
Monitor is stuck in "Power Saving Mode"	<ul style="list-style-type: none"> <li>*Make sure monitor's video cable is properly connected to the computer.</li> <li>*Inspect monitor's video cable and make sure none of the pins are bent.</li> <li>*Make sure computer is operational by hitting the CAPS LOCK key on the keyboard while observing the CAPS LOCK LED. The LED should either turn ON or OFF after hitting the CAPS LOCK key.</li> </ul>
Missing one of the primary colors (RED, GREEN, or BLUE)	*Inspect the monitor's video cable and make sure that none of the pins are bent.

Screen image is not centered or sized properly.	*Adjust pixel frequency (CLOCK) and FOCUS or press hot-key (AUTO)
Picture has color defects (white does not look white)	*Adjust RGB color or select color temperature
Poor brightness or contrast	*The life time of the back-light is limited. In 20000 Hours the luminance of the light has been reduced to half of its original value. Please send the monitor to an authorized service Agent for service.
Horizontal or vertical disturbances on the screen	*Use win 95/98 shut-down mode Adjust CLOCK and FOCUS or perform hot- key (AUTO-key).

CLOCK (pixel frequency) controls the number of pixels scanned by one horizontal sweep. If the frequency is not correct, the screen shows vertical stripes and the picture has not correct width.

FOCUS adjusts the phase of the pixel clock signal. With a wrong phase adjustment the picture has horizontal disturbances in light picture.

For FOCUS and CLOCK adjustment use “dot-pattern” or win 95/98 shut-down mode pattern .



## ERROR MESSAGE & POSSIBLE SOLUTION

### CABLE NOT CONNECTED :

1. Check that the signal-cable is properly connected , If the connector is loose, tighten the connector's screws.
2. Check the signal-cable's connection pins for damage.

### INPUT NOT SUPPORT :

Your computer has been set to unsuitable display mode ,set the computer to display mode given in the following table.

### UNSUPPORTED MODE TRY DIFFERENT VIDEO CARD SETTING:

Your computer resolution is out of VESA-SPEC

#### If the monitor is stuck in "Power Saving mode:

1. Make sure monitor's signal-cable is properly connected to the computer.
2. The computer has switched the monitor into power save mode. Press any key in the computer keyboard to wake up the monitor.
3. Check that the computer is switched on
6. Check the computer resolution/ rate may be too high, out of LCD-MONITOR display mode range

### RESOLUTION :

RESOLUTION	VERTICAL FREQUENCY	RESOLUTION	VERTICAL FREQUENCY
640 × 480	60Hz	800 × 600	72.2Hz
640 × 400	70Hz	800 × 600	75Hz
640 × 350	70Hz	832 × 624	74.5Hz
720 × 400	70Hz	1024 × 768	60Hz
640 × 480	72.8Hz	1024 × 768	70Hz
640 × 480	75Hz	1024 × 768	75Hz
640 × 480	66.67Hz	1024 × 768	74.92Hz
800 × 600	56.3Hz	1280 x 1024	60Hz
800 × 600	60.3Hz	1280 x 1024	75Hz

## HOW TO INSTALL THE DRIVER-DISK (INF & ICM FILE)

### FOR FIRST TIME INSTALL :

Your system may not recognize your flat-panel monitor, and as a result, you may need to complete the following steps for optimum performance of your monitor.

1. Check this LCD MONITOR LM700 is properly connected to your computer.
2. Restart the computer , when win95/98 detects the presence of a Plug and Play Monitor ,its device driver can be loaded and configured dynamically, insert LM700 install disk to DISK A after the Win95/98 setup wizard is appeared. This setup wizard will lead you through the steps for configuring the system.  
(Select " NEXT " for next steps and select driver A for LM700 install file, if not select driver A ,the configuration system will automatically select the standard Plug and Play driver)

3. After the installation complete you can find the monitor complete name by following steps :

Click "**START**" , select "**SETTINGS**", select "**CONTROL PANEL**" Select "**SYSTEM**", select "**DEVICE MANAGEMENT**" , select "**MONITOR**" icon and click twice ,you can see the description as follow :

"**AOC LCD MONITOR LM-700** "

if this description doesn't exist, or the "**MONITOR**" icon doesn't exist too,that means your installation is not successful.

Please delete the description with click the right button of mouse, and select The "remove or erase" to delete the description, if your step is successful, the "**MONITOR**" icon will disappear.

[Please repeat this 2nd, 3rd steps if not success](#)

4. After you complete above setup, please follow the steps below to operate your monitor at maximum performance :
  - A). Double click on the **My Computer** icon
  - B). Double click on the **Control Panel** icon
  - C). Double click on the **Display** icon, click on the **Settings** tab
  - D). In the **Desktop Area** drag the slider to resolution 1280x1024, and set the **Color palette** for 16-bit color
  - E). Click on the **Advanced Properties**
  - F). Select the **add-on card** tab , set the refresh rate to 60 Hz, click the **OK** button, and click on the **CLOSE** button

## APPENDIX

### SPECIFICATIONS

LCD Panel	Driving system	TFT Color LCD
	Size	43.7cm(17.0")
	Pixel pitch	0.264mm( H )x 0.264mm( V )
	Viewable angle	120° (H) 100° (V)
	Response time	50 ms
Input	Video	R,G,B Analog Interface
	Separate Sync.	H/V TTL
	H-Frequency	30KHz – 80KHz
	V-Frequency	55-75Hz
Display Colors		16.7M Colors
Dot Clock		135MHz
Max. Resolution		1280 x 1024
Plug & Play		VESA DDC1/2B™
Input Connector		D-Sub 15pin
Input Video Signal		Analog:0.7Vp-p(standard), 75 OHM, Positive
Maximum Screen Size		Horizontal : 337.92mm Vertical : 270.34mm
Power Source		100~264VAC,47~63HZ
Environmental Considerations		Operating Temp: 0° to 40°C Storage Temp.: -10° to 50°C Operating Humidity : 20% to 90%
Weight (N. W.)		5.5Kgs

External Controls:	Switch	<ul style="list-style-type: none"> <li>• Auto Adjust Key</li> <li>• ◀ / Brightness</li> <li>• ▶ / Contrast</li> <li>• Power Switch</li> <li>• MENU/ Exit</li> </ul>
	Functions	<ul style="list-style-type: none"> <li>• Contrast</li> <li>• Brightness</li> <li>• Focus</li> <li>• Clock</li> <li>• H-Position</li> <li>• V-Position</li> <li>• Auto-center</li> <li>• Language</li> <li>• Dos-mode resolution selected</li> <li>• 6500°K</li> <li>• 7800°K</li> <li>• RGB Color temperature</li> <li>• Recall</li> <li>• Exit</li> </ul>
Power Management		VESA DPMS
Power Consumption ( Maximum )		55 Watts
Regulatory Compliance		UL, CSA, FCC, TÜV, CE, MPR II, TCO'92

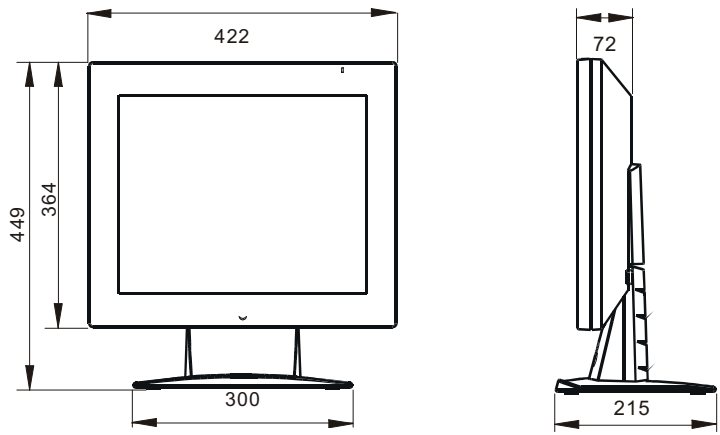

## FACTORY PRESET TIMING TABLE

STANDARD	RESOLUTION	HORIZONTAL FREQUENCY	VERTICAL FREQUENCY
Dos-mode	640 × 400	31.47kHz	70Hz
Dos-mode	720 × 400	31.47kHz	70Hz
VGA	640 × 480	31.47kHz	60Hz
	640 × 480	35.00kHz	66.6Hz
	640 × 480	37.50kHz	75Hz
SVGA	800 × 600	37.879kHz	60Hz
	800 × 600	46.875kHz	75Hz
	832 × 624	49.725kHz	75Hz
XGA	1024 × 768	48.363kHz	60Hz
	1024 × 768	56.476kHz	70Hz
	1024 × 768	60.02kHz	75Hz
	1024 × 768	60.241kHz	74.9Hz
SXGA	1280 × 1024	64.000kHz	60Hz
	1280 × 1024	80.000kHz	75Hz

Note: The factory preset mode for DOS was 720x400 @70Hz, user can change to Dos 640x400 @70Hz by selected OSD- ICON .

( reference to page 10,11)

## CONNECTOR PIN ASSIGNMENT

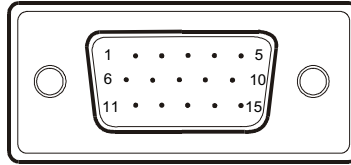

15 - Pin Color Display Signal Cable

PIN NO.	DESCRIPTION	PIN NO.	DESCRIPTION
1.	Red	9.	+5V
2.	Green	10.	Detect Cable
3.	Blue	11.	NC
4.	Ground	12.	DDC-Serial Data
5.	Ground	13.	H-Sync
6.	R-Ground	14.	V-Sync
7.	G-Ground	15.	DDC-Serial Clock
8.	B-Ground		

**LIMITED THREE-YEAR WARRANTY\***  
**for**  
**AOC Spectrum Color Monitors sold within Europe**

AOC International (Europe) GmbH warrants this product to be free from defects in materials and workmanship for a period of Three (3) years after the original date of consumer purchase. During this period, AOC International (Europe) GmbH will, at its option, either repair the defective product with new or rebuilt parts, or replace it with a new or rebuilt product at no charge except these conditions as \*stated below. The defective products that are replaced become the property of AOC International (Europe) GmbH.

If the product appears to be defective, please contact your local dealer or refer to the warranty card attached to the product.

Deliver the product on freight pre-paid, along with the dated proof of purchase, to the AOC Authorized Service Center. If you cannot deliver the product in person:

- Pack it in its original shipping container (or equivalent)
- Put the RMA number on the address label
- Put the RMA number on the shipping carton
- Insure it (or assume the risk of loss/damage during shipment)
- Pay all shipping charges

AOC International (Europe) GmbH is responsible neither for any damage or loss during inbound transport damage nor to inbound product that was not properly packaged.

AOC International (Europe) GmbH will pay the return shipping charges within one of the countries specified within this warranty statement.

AOC International (Europe) GmbH is not responsible for any costs associated with the transportation of product across international borders which the borders within the European Union are included as well.

\* This limited warranty does not cover any losses or damages that occur as a result of

- Shipping or improper installation or maintenance
- Misuse
- Neglect
- Any cause other than ordinary commercial or industrial application
- Adjustment by non-authorized source
- Repair, modification, or installation of options or parts by anyone other than an AOC Authorized Service Center
- Improper environment
- Excessive or inadequate heating or air conditioning or electrical powers failures, surges, or other irregularities

This limited warranty does not cover any of the product firmware or hardware that you or any third party have modified or altered; you bear the sole responsibility and liability for any such modification or alteration.

ALL EXPRESS AND IMPLIED WARRANTIES FOR THIS PRODUCT (INCLUDING THE WARRANTIES OF MERCHANTABILITY AND FITNESS FOR A PARTICULAR PURPOSE) ARE LIMITED IN DURATION TO A PERIOD OF THREE (3) YEARS FOR PARTS AND LABOR FROM THE ORIGINAL DATE OF CONSUMER PURCHASE. NO WARRANTIES (EITHER EXPRESSED OR IMPLIED) APPLY AFTER THIS PERIOD. HEREUNDER AOC INTERNATIONAL (EUROPE) GMBH OBLIGATIONS AND YOUR REMEDIES ARE SOLELY AND EXCLUSIVELY STATED. AOC INTERNATIONAL (EUROPE) GMBH LIABILITY, WHETHER BASED ON CONTRACT, TORT, WARRANTY, STRICT LIABILITY, OR OTHER THEORY, SHALL NOT EXCEED THE PRICE OF THE INDIVIDUAL UNIT WHOSE DEFECT OR DAMAGE IS THE BASIS OF THE CLAIM. IN NO EVENT SHALL AOC INTERNATIONAL (EUROPE) GMBH BE LIABLE FOR ANY LOSS OF PROFITS, LOSS OF USE OR FACILITIES OR EQUIPMENT, OR OTHER INDIRECT, INCIDENTAL, OR CONSEQUENTIAL DAMAGE. SOME STATES DO NOT ALLOW THE EXCLUSION OR LIMITATION OF INCIDENTAL OR CONSEQUENTIAL DAMAGES, SO THE ABOVE LIMITATION MAY NOT APPLY TO YOU. ALTHOUGH THIS LIMITED WARRANTY GIVES YOU SPECIFIC LEGAL RIGHTS, YOU MAY HAVE OTHER RIGHTS, WHICH MAY VARY FROM COUNTRY TO COUNTRY. THIS LIMITED WARRANTY IS ONLY VALID FOR PRODUCTS PURCHASED IN THE MEMBER COUNTRIES OF THE EUROPEAN UNION.