

Norcent

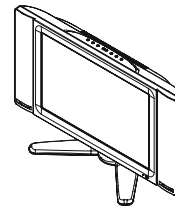

LT1720WS

USER'S MANUAL

TABLE OF CONTENTS

INSTALLATION	1
For Your Safety	1
IMPORTANT SAFETY INSTRUCTUONS	2
PREPARATION	4
OPERATING INSTRUCTIONS	6
Use of the remote control	6
To use the menus	7
Main menu	7
CONNECT PERIPHERAL EQUIPMENT	14
Front Panel Control Knobs	14
Preparation	14
Video recorder	15
Camera, camcorder, Video Game set	16
DVD player	16
Digital Set TOP box	17
Headphone	18
Tips	18
PRODUCT SPECIFICATION	20
BEFORE CALLING SERVICE	22
Glossary	23

Thank you very much for choosing the Norcent LCD TV.
We recommend that you take a few minutes to read carefully through this manual before installing and switching on the TV. Please keep this manual in a safe place for your future reference.

FOR YOUR SAFETY

Before operating the TV please read this manual thoroughly. This manual should be retained for future reference.

FCC Class B Radio Frequency Interference Statement WARNING: (FOR FCC CERTIFIED MODELS)

NOTE: This equipment has been tested and found to comply with the limits for a Class B digital device, pursuant to Part 15 of the FCC Rules. These limits are designed to provide reasonable protection against harmful interference in a residential installation. This equipment generates, uses and can radiate radio frequency energy, and if not installed and used in accordance with the instructions, may cause harmful interference to radio communications. However, there is no guarantee that interference will not occur in a particular installation. If this equipment does cause harmful interference to radio or television reception, which can be determined by turning the equipment off and on, the user is encouraged to try to correct the interference by one or more of the following measures:

1. Reorient or relocate the receiving antenna.
2. Increase the separation between the equipment and receiver.
3. Connect the equipment into an outlet on a circuit different from that to which the receiver is connected.
4. Consult the dealer or an experienced radio/TV technician for help.

NOTICE

1. The changes or modifications not expressly approved by the party responsible for compliance could void the user's authority to operate the equipment.
2. Shielded interface cables and AC power cord, if any, must be used in order to comply with the emission limits.
3. The manufacturer is not responsible for any radio or TV interference caused by unauthorized modification to this equipment. It is the responsibilities of the user to correct such interference.

As an ENERGY STAR® Partner Envision Peripherals, Inc. has determined that this product meets the ENERGY STAR® guidelines for energy efficiency.

WARNING:

To prevent fire or shock hazard, do not expose the TV to rain or moisture. Dangerously high voltages are present inside the TV. Do not open the cabinet. Refer servicing to qualified personnel only.

IMPORTANT SAFETY INSTRUCTIONS

Read before operating equipment

1. Read these instructions.
2. Keep these instructions.
3. Heed all warnings.
4. Follow all instructions.
5. Do not use this apparatus near water.
6. Clean only with a dry cloth.
7. Do not block any of the ventilation openings. Install in accordance with the manufacturer's instructions.
8. Do not install near any heat sources such as radiators, heat registers, stoves, or other apparatus (including amplifiers) that produce heat.
9. Do not defeat the safety purpose of the polarized or grounding type plug. A polarized plug has two blades with one wider than the other. A grounding type plug has two blades and third grounding prong. The wide blade or third prong is provided for your safety. When the provided plug does not fit into your outlet, consult an electrician for replacement of the obsolete outlet.
10. Protect the power cord from being walked on or pinched particularly at plugs, convenience receptacles, and the point where they exit from the apparatus.
11. Only use attachments/accessories specified by the manufacturer.
12. Use only with a cart, stand, tripod, bracket, or table specified by the manufacturer, or sold with the apparatus. When a cart is used, use caution when moving the cart/apparatus combination to avoid injury from tip-over.
13. The TV should be operated only from the type of power source indicated on the label. If you are not sure of the type of power supplied to your home, consult your dealer or local power company.
14. Unplug this apparatus during lightning storms or when unused for long periods of time.
15. Refer all servicing to qualified service personnel. Servicing is required when the apparatus has been damaged in any way, such as power-supply cord or plug is damaged, liquid has been spilled or objects have fallen into apparatus, the apparatus has been exposed to rain or moisture, does not operate normally, or has been dropped.
16. This product may contain lead or mercury. Disposal of these materials may be regulated due to environmental considerations. For disposal or recycling information, please contact your local authorities or the Electronic Industries Alliance: www.eiae.org
17. **Damage Requiring Service** – The appliance should be serviced by qualified service personnel when:
 - A. The power supply cord or the plug has been damaged; or
 - B. Objects have fallen, or liquid has been spilled into the appliance; or
 - C. The appliance has been exposed to rain; or
 - D. The appliance does not appear to operate normally or exhibits a marked change in performance; or

- E. The appliance has been dropped, or the enclosure damaged.
18. **Tilt/Stability** – All televisions must comply with recommended international global safety standards for tilt and stability properties of its cabinets design.
 - Do not compromise these design standards by applying excessive pull force to the front, or top, of the cabinet, which could ultimately overturn the product.
 - Also, do not endanger yourself, or children, by placing electronic equipment/toys on the top of the cabinet. Such items could unsuspectingly fall from the top of the set and cause product damage and/or personal injury.
 19. **Wall or Ceiling Mounting** – The appliance should be mounted to a wall or ceiling only as recommended by the manufacturer.
 20. **Power Lines** – An outdoor antenna should be located away from power lines.
 21. **Outdoor Antenna Grounding** – If an outside antenna is connected to the receiver, be sure the antenna system is grounded so as to provide some protection against voltage surges and built up static charges. Section 810 of the National Electric Code, ANSI/NFPA No. 70-1984, provides information with respect to proper grounding of the mats and supporting structure grounding of the lead-in wire to an antenna-discharge unit, size of grounding connectors, location of antenna-discharge unit, connection to grounding electrodes and requirements for the grounding electrode. See Figure below.
 22. **Objects and Liquid Entry** – Care should be taken so that objects do not fall and liquids are not spilled into the enclosure through openings.



EXAMPLE OF ANTENNA GROUNDING AS PER NATIONAL ELECTRICAL CODE

Note to the CATV system installer: This reminder is provided to call the CATV system installer's attention to Article 820-40 of the NEC that provides guidelines for proper grounding and, in particular, specifies that the cable ground shall be connected to the grounding system of the building, as close to the point of cable entry as practical.

PREPARATION

Please, make sure to connect the power plug to the wall outlet socket after connecting the TV to the adapter!

1. **Place the TV on a solid surface.**

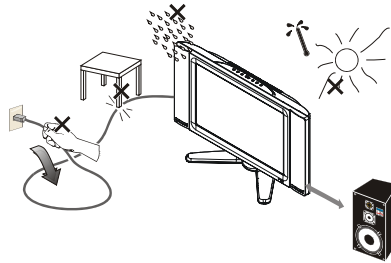

Ensure that the TV is placed in a position to allow free flow of air. Do not cover the ventilation openings on the back cover. To prevent any unsafe situations, no naked flame sources, such as lighted candles, should be placed on or in the vicinity. Avoid heat, direct sunlight and exposure to rain or water. The equipment shall not be exposed to dripping or splashing.

2. **Insert the aerial plug** firmly into the aerial socket **ANT IN 75Ω** at the back of the TV.

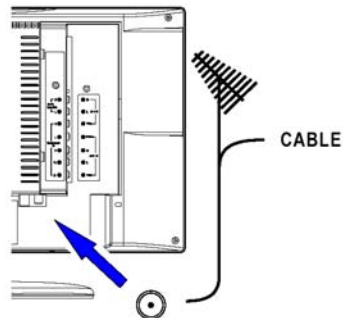

3. **Remote control:**

Remove the cover of the battery compartment. Insert the 2 batteries supplied (Type AAA 1.5V).

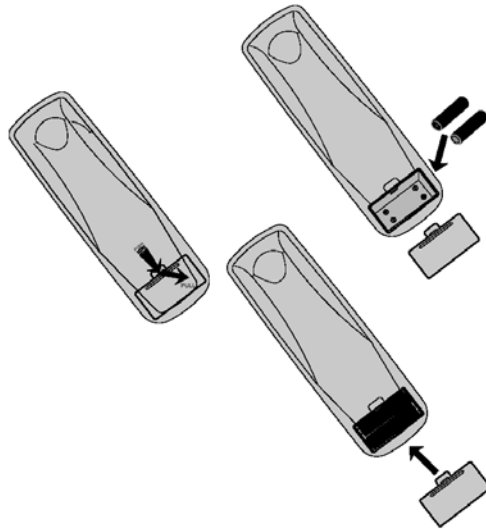

4. **Power:**

Insert the power cord in the wall socket having an AC power supply.

5. **Turn the TV on:**

Press the power button at the topside of the TV to turn it on.

If the TV is in power off, the indicator in front of the TV illuminates amber.

OPERATING INSTRUCTIONS

USE OF THE REMOTE CONTROL

POWER:

Press to turn on/off the TV. The TV is never completely powered off unless it is physically unplugged.

0~9/100 Digit buttons

To select a TV channel.

CH

Press ▲ or ▼ to brows through the TV channels which are not erased. To view a blocked channel, use the digit buttons to access the channel and enter your access code.

VOL

Press + or – to adjust the volume.

PC

select your input source to PC

SLEEP

With this key you can set a time period after which the TV should switch itself to standby. Press the key repeatedly to select the number of minutes. The counter runs from 0,30,60,90,120 minutes. The timer begins to count down from the number of minutes selected after the display has disappeared.

PIP

Press this button to display PC input and other input on the screen at same time.

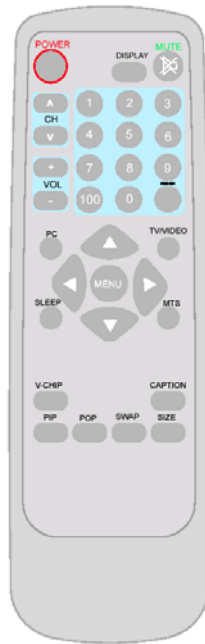

MENU

Press repeatedly to display OSD menu.

V-CHIP

Press this button to setup parental control.

SWAP

Not Supported. (for the model with this function only)

SIZE

Not Supported. (for the model with this function only)

POP

Not Supported. (for the model with this function only)

MUTE

Temporarily interrupt the sound or restore it.

DISPLAY

Press this button to Display Channel number on the right-top corner.

MTS /SAP

press this key to activate Multichannel Television Sound, Stereo or Mono

PRE-CH

To display the previously selected TV channel.

TV/VIDEO

Select your input source: press repeatedly to select **TV, AV1, AV2, S-VIDEO** or **COMPONENT** mode, according to where you connected your external source.

- **AV1/AV2** for a VCR connected to the AV connectors of the TV.
- **S-VIDEO** for a S-Video VCR connected to the S-VIDEO connector of the TV.
- **COMPONENT** for a DVD/DTV Set Top Box or another component video device connected to **Y, Pb, Pr** and to the **AV AUDIO** inputs **L** and **R**.

CAPTION

Press this button to turn **Closed Caption** on. Be sure you have selected Caption On in the Setup menu.

TO USE THE MENUS

1. Press the **MENU** button to display each menu
2. Use the cursor up/down to select a menu item.
3. Use the cursor left/right to enter a submenu or enable/disable the function.
4. Press the **MENU** button to exit the menu.

MAIN MENU

Press the **MENU** button into the main OSD (On Screen Display). Adjust item include **VIDEO ADJUST**, **AUDIO ADJUST**, **CLOSED CAPTION**, **V CHIP**, **SLEEP TIMER**, **SET UP** and **PC ADJUST**.



Video Adjust

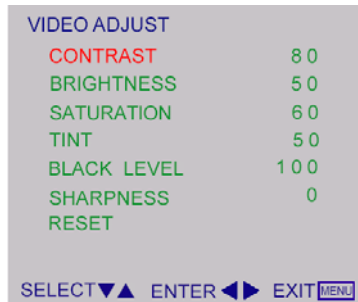

1. **Contrast**, **Brightness** and **Saturation** are adjusted from 0 to 100.
2. **Tint** is adjusted from 0 to 100.
3. **Black Level** is adjusted from 0 to 100.
4. **Sharpness** is adjusted from 0 to 10.
You can adjust picture contrast, brightness, color, tint and sharpness to the levels you prefer.
5. **Reset** is set up to default value.



When adjust any item sub-OSD will show up like this.

Audio Adjust

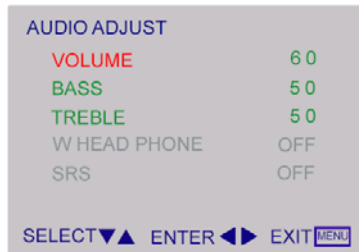

1. **Volume** is adjusted from 0 to 100.
2. **Bass** and **Treble** are adjusted from 0 to 100.
3. **W-Head Phone** (optional) is the function for wireless headphone enable or disable.
You can adjust audio Volume, Balance, Bass and Treble to the levels you prefer.



When adjust any item sub-OSD will show up like this.

CLOSED CAPTION

It's allows you to read the dialog of television programs on the TV screen. Designed to help the hearing impaired, this feature uses on screen "text boxes" to show dialogue and conversations while the TV program is in progress. Captions will appear on the screen only during captioned broadcasts. Remark: the captions do not always use correct spelling and grammar.

Not all TV programs and product commercials are made for broadcast with Closed Caption information included. Refer to your area's TV program listings for the TV channels and times of closed Caption shows. The captioned programs are usually noted in the TV listings with service Marks such as "CC".

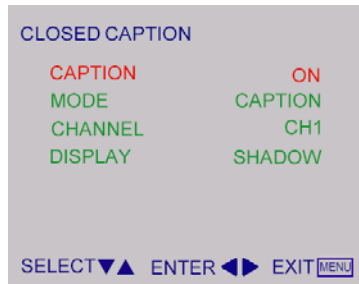

- **Caption Mode:**
Dialogue (and descriptions) for the action on the captioned TV program shows on screen. Usually CH1 is the most used channel. CH2 may be used for alternate languages if they are being transmitted.
- **Text Mode:**
Often used for channel guide, schedules, bulletin board information for Closed Caption programs, news, weather information or stock marker reports.
Not all Closed Caption modes are necessarily being use by a TV channel during the transmission of a Closed Caption program.

V-CHIP SETUP

Select V-Chip on OSD then enter 4 digits of pin number.

- Initial pin number is "0000".
- If you enter an incorrect pin number "Incorrect" message will be displayed.



It is the parental control function (V-chip). It is used to block program viewing based on the ratings by the broadcaster. The default setting is to allow all programs to be viewed. Viewing can be blocked by the type of program and by the categories chosen be blocked. It is also possible to block all program viewing for a time period.

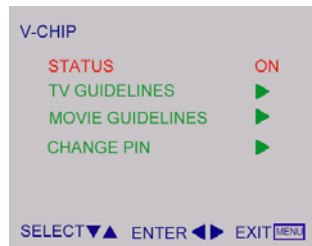

- A. There are two item could be defined. One is **TV Guidelines** another one is **Movie Guidelines**.
- B. Setting up **TV Guidelines**
 - Use Up/Down arrow buttons to move around the matrix and press **Right arrow** button to change the value form "U" to "B" or "B" to "U"
 - **U**: Unblock
 - **B**: Block

	ALL	FV	V	S	L	D
TV-Y	U					
TV-Y7	U	U				
TV-G	U					
TV-PG	U		U	U	U	U
TV-14	U		U	U	U	U
TV-MA	U		U	U	U	

C. Setting up **Movie Guidelines**

- Use Up/Down arrow buttons to move around the matrix and press **Right arrow** button to change the value from "U" to 'B" or "B" to "U"

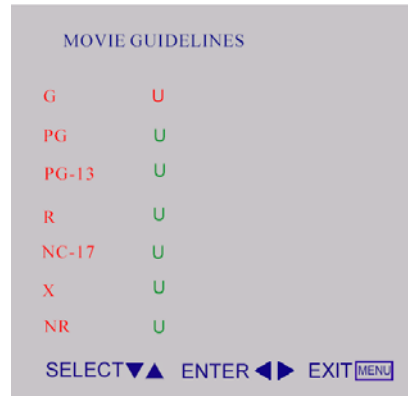

- D. **CHANGE PIN** Personal Identification Number is for change password to control the V-chip setup; it's included three step. ENTER PIN to enable this function, then ENTER NEW PIN to change a new one. After that COMFIRM NEW PIN.



Sleep Timer

It is for set a time period after which the TV should switch itself to standby.

The counter runs from 0 > 30 > 60 > 90 > 120 minutes.

The timer begins to count down from the number of minutes selected after the display has disappeared.

Note: To view the remaining time, press the **SLEEP** button once. To cancel the sleep time, repeatedly press the **SLEEP** button until... appears. If you turn the TV off after setting the sleep time, the setting will be erased. Set it again.

Set up

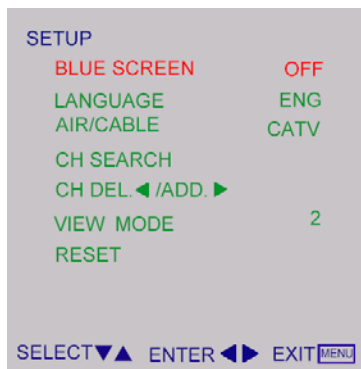

1. **Blue screen** for when no video input screen will be blue or blank. If it's ON, the screen will be in blue. If it's OFF, the screen will be blank. Pre-set is ON.
2. **Language** for different language OSD MENU includes English / French / Spanish. Pre-set is English.
3. **AIR/CATV** for different TV input solution, RF and cable.
4. **CH Search** is for auto memorizes all receiving channels of air TV or CATV programs.
5. **CH ADD/DEL** is for add ">" or delete "<" the current channel for memorizes.
6. **RESET** is set up to default value.

PC Adjust

1. **Auto Adjust** is the function auto-sizing for VGA input.
2. **Contrast, Brightness, Focus, Clock, H-Position, V-Position and Color Temp** are the functions for PC adjustment.

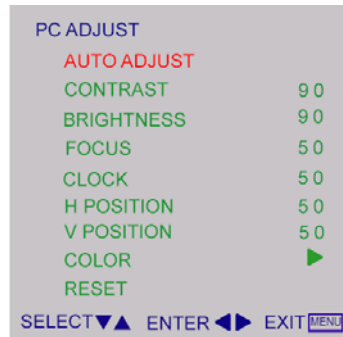

Color Temp for you can adjust the color temperature you prefer.

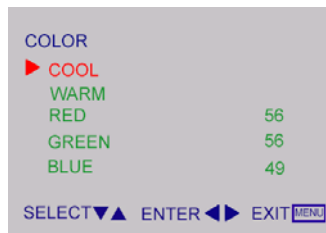

Connect Peripheral Equipment

FRONT PANEL CONTROL KNOBS



- Power Key:** Press to turn on or off the TV.
MENU Key: Press to show the OSD menu and exit OSD menu at the TV.
Down / Up Key: Press to perform select function and channel.
- / + Key: Press to confirm your function selection and adjustment.
Source Key: Press to select your input source.

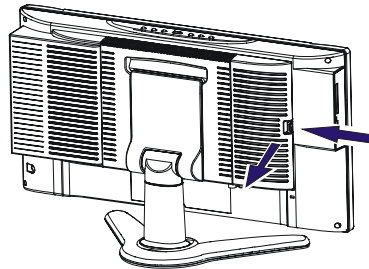

There is a wide range of video and audio equipment that can be connected to your TV. The following connection diagrams show you how to connect them.

PREPARATION

Remove the back plate at the back of the TV as shown on the illustration opposite.
Lay the LCD TV with the screen down on a table, as it will be easier to connect your peripheral equipment. Please take your precautions not to damage the screen.

VIDEO RECORDER

How to connect

1. Connect the antenna cable ① to the **RF IN** port of your VCR.

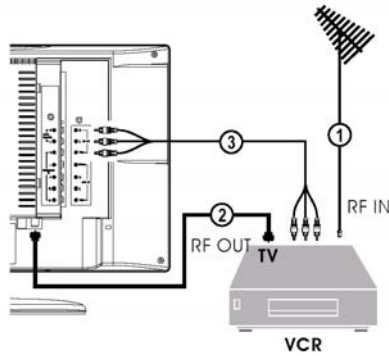

2. Connect another RF cable ② from the output **RF** of your VCR to the Antenna input of your TV. Better quality when playing from your **VCR** can be obtained if you also connect the Video, Audio LEFT AND right (only for stereo equipment) cables ③ to the **VIDEO, AUDIO L** and **R** inputs **AV**.

If you are using only mono equipment, connect only the **VIDEO** and the **AUDIO L (Mono)** ports.

If your VCR has an S-VHS video jack:

For improved picture quality, connect a **S-Video** cable with the S-VIDEO input on the TV instead of connecting the VCR to the **VIDEO** port of **AV2**.

S-Video does not provide audio, audio cables must still be connected to provide sound. (S-Video and AV2 has the same audio input port)

Watching VCR

1. If you use connection ②, select the TV channel 3 or 4.
2. If you use connection ③, select **VIDEO** or **S-VIDEO**, (see P6 TV/ VIDEO)
3. Insert videotape in the VCR and press the **PLAY** button.

CAMERA, CAMCORDER, VIDEO GAME SET, ...

How to connect

1. Composite Video:
Connect your camera, camcorder, videogame set,... to **Audio port** ② (Audio L for mono) and **Video port** ③.

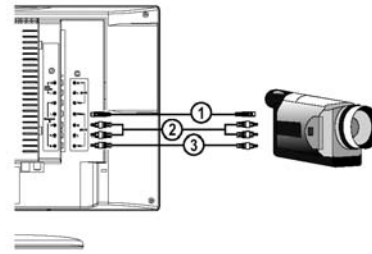

2. S-Video Connection
S-VHS quality with an S-VHS camcorder is obtained by connecting the S-VHS cable with the S-VIDEO input ① and **AUDIO** input ②.

How to use

1. Select **VIDEO** or **S-VIDEO** input source (see P6 TV/ VIDEO)
2. Turn on the external AV equipment.

DVD PLAYER

How to connect

1. Connect the three separate component video cables ① to the DVD player's **Y, Pb and Pr** ports and to the **Y, Pb and Pr** ports on the TV.

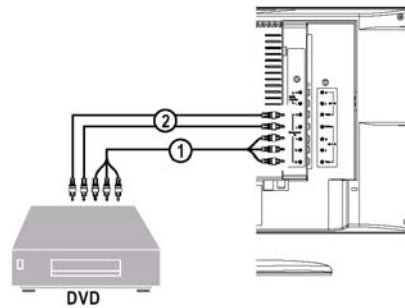

2. Connect the audio cables ② to the DVD player's **AUDIO L** and **R** ports and to the **L** and **R AUDIO** AV ports on the TV.

How to use

1. Select **COMPONENT**, (see P6 TV/ VIDEO)
2. Turn on the DVD set.

DIGITAL SET TOP BOX

Connect DTV set top box RF output to TV Antenna input (TV channel set to CH3 or CH4). If your DTV set top box has component (Y, Pb, Pr) video ports, use them for better picture.

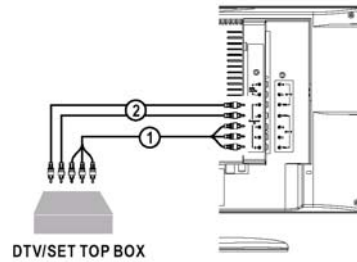

How to connect component video:

1. Connect the three separate component video cables ① to the DTV set top box **Y, Pb** and **Pr** ports and to the **Y, Pb** and **Pr** ports on the TV.
2. Connect the audio cables ② to the DTV player's **AUDIO L** and **R** ports and to the **L** and **R AUDIO** AV ports on the TV.

How to use

1. Select **COMPONENT**, (see P6 TV/ VIDEO)
2. Turn on the DTV set Top box set.

Warning: In case you notice scrolling images, wrong colors or no color, no picture or even combinations of these, on your screen, check if the connections are done in the right way. Check if the cable colors match with the Input connector colors.

HEADPHONE

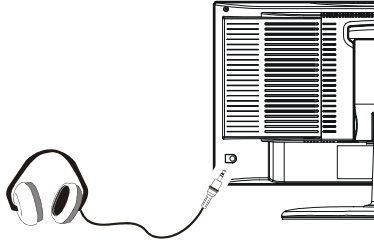

1. The earphone jack is located at the rear corner of the TV.
2. The ~~M~~ MUTE key on the remote control works on both internal speaker and the earphone.
3. Use volume key to adjust the volume.

Note: When a TV channel or external AV source is blocked because of a rating set via the Parental control menu, also the headphone is muted.

TIPS

Care of the screen

Do not rub or strike the screen with anything hard as this may scratch, mar, or damage the screen permanently.

Unplug the screen before cleaning the screen. Dust the TV by wiping the screen and the cabinet with a soft, clean cloth. If the screen requires additional cleaning, use a clean, damp cloth. Do not use liquid cleaners or aerosol cleaners.

Mobile telephone warning

To avoid disturbances in picture and sound, malfunctioning of your TV or even damage to the TV, keep away your mobile telephone from the TV.

End of life directives

We are paying a lot of attention to produce environmentally friendly in green focal areas. Your new receiver contains materials which can be recycled and reused.

At the end of its life specialized companies can dismantle the discarded receiver to concentrate the reusable materials and to minimize the amount of materials to be disposed of.

Please ensure you dispose of your old receiver according to local regulations.

Regulatory Notices – Federal Communications Commission Notice

This equipment has been tested and found to comply with the limits for a Class B digital device, pursuant to part 15 of the FCC Rules. These limits are designed to provide reasonable protection against harmful interference in a residential installation. This equipment generates, uses, and can radiate radio frequency energy and, if not installed and used in accordance with the instructions, may cause harmful interference to radio communications. However, there is no guarantee that interference will not occur in a particular installation. If this equipment does cause harmful interference to radio or television reception, which can be determined by turning the equipment off and on, the user is encouraged to try to correct the interference by one or more of the following measures:

- Reorient or relocate the receiving antenna.
- Increase the separation between the equipment and the TV.
- Connect the equipment into wall power outlet on a circuit different from that to which the receiver is connected.
- Consult the dealer or an experienced radio or television technician for help.

Modifications –

The FCC requires the user to be notified that any changes or modifications made to this device that are not expressly approved by AOC consumer Electronics may void the user's authority to operate the equipment.

Cables –

Connections to this device must be made with shielded cables with metallic RF/EMI connector hoods to maintain compliance with FCC Rules and Regulations.

Canadian notice –

This Class B digital apparatus meets all requirements of the Canadian Interference-Causing Equipment Regulations.

Avis Canadian –

Cet appareil numérique de la classe B respecte toutes les exigences du règlement sur le matériel brouilleur du Canada.

Product Specification

Feature	17" screen WXGA (1280 x 768) Resolution High Brightness (450 cd/m ²) High Contrast Ration (600:1) Wide Viewing Angle (170° H / 170° V) Built-in 181 channel Tuner with MTS, SAP, Closed Caption & V-chip PC Input
----------------	---

Items	Specification	
LCD Panel	Screen Size	17" TFT-LCD Panel
	Aspect Ratio	15:9
	Resolution	1280 × 768 (WXGA)
	Display Area (opening) H x V	369mm × 221mm
	Pixel Pitch	0.288mm × 0.288mm
	Display colors	16.7 million
	Contrast Ratio	600:1
	Brightness	450cd / m ²
	Viewing Angle	170° (Horizontal) / 170° (Vertical)
	Response Time	25ms
	Lamp Type/Life	60000 hr
	Color Temperature	Cool / Warm
TV Function	TV Tuning System	NTSC 181 Channel with Electronic PLL Tuner
	Sound System	MTS / SAP
	Closed Caption, V-chip	Yes
	Color Systems	NTSC
Video Inputs	AV1	RCA x 1 RCA x 1
	AV2	RCA x 1 RCA x 1
		S-Video x 1 S-Video x 1
Component	YPbPr x 1 YPbPr x 1	

PC Input	Signal Input	Analog: D-Sub 15 pin (detachable cable)
	PnP compatibility	DDC / 2B
	Input frequency	Analog: FH: 31.5KHz to 49KHz FV: 56Hz to 75Hz
	Recommended	Analog: 1024 x 768 (60Hz)
	Input Audio	Headphone Mini-jack for stereo (3.5ø)
Audio Output	Audio Output: L / R	Speaker (built-in): Two 5 watt speakers
		Headphone Mini-jack for stereo (3.5ø)
		Line Output (RCA L/R)
OSD language	English	
Table Stand	Included	
Wall Mount	VESA 100 x 100 mm	
Power	Power Supply	AC100V~120V, 60Hz
	Power Consumption	<70W
Environment	Operating Temp.	+ 0°C ~ + 40°C
	Storage Temp.	- 25°C ~ + 60°C
	Operating Humidity.	10 % ~ 85 %
Panel Tilt	Forwards/Backwards/Rotation	-5° / +20° / ±30°
Dimension	W x H x D (with stand)	560 x 338 x 184 (mm)
Weight (net)	Kg (w/o Accessories)	6 Kg
Accessories	Remote Controller, Batteries (x2), AC Power Cord, D-sub Signal Cable, Audio line, User's Manual	

Before Calling Service

Please make these simple checks before calling service. These tips may save you time and money since charges for receiver installation and adjustments of customer controls are not covered under your warranty.

Symptoms	Items to Check and Actions to follow
"Ghost" or double image	*This may be caused by obstruction to the antenna due to high rise buildings or hills. Using a highly directional antenna may improve the picture.
No power	*Check that the TV's AC power cord is plugged into the mains socket. *Unplug the TV, wait for 60 seconds. Then re-insert plug into the mains socket and turn on the TV again.
No picture	*Check antenna connections at the rear of the TV to see if it is properly connected to the TV. *possible broadcast station trouble. Try another channel. *Adjust the contrast and brightness settings. *Check the Closed Captions control. Some TEXT modes could block the screen,
Good picture but no sound	*Increase the VOLUME. *Check that the TV is not muted; press the button on the remote control.
Good sound but poor color	*Adjust the contrast, color and brightness settings.
Poor picture	*Sometimes, poor picture quality occurs when having activated an A-VHS camera or camcorder connected and having connected another peripheral at the same time. In this case switch off one of the other peripherals
Snowy picture and noise	*Check the antenna connection
Horizontal dotted line	*This may be caused by electrical interference (e.g. hairdryer, nearby neon lights, etc.) *Turn off the equipment.
Television not responding to remote control	*Check whether the batteries are working. Replace if necessary *Clean the remote control sensor lens on the TV. *You can still use the buttons at the front of your TV. *Select the TV mode to be sure your remote control is in the TV mode.

GLOSSARY

Audio / Video Inputs

Located on the rear and the front of the receiver these connectors (RCA phono type plug) are used for the input of audio and video signals. Designed for use with VCRs (or other accessories) in order to receive higher picture resolution and offer sound connection options.

Menu

An on-screen listing of feature controls shown on the TV screen that are made available for user adjustments.

MPAA

Motion Picture Association of America

Multichannel Television sound (MTS)

The broadcast standard that allows for stereo sound to be transmitted with the TV picture.

Programming

The procedure of adding or deleting channel numbers into the TV's memory. In this way the TV remembers only the locally available or desired channel numbers and skips over any unwanted channel numbers.

RF

Radio Frequency or modulated signal design used as the carrier for television broadcasts.

Second Audio Program (SAP)

Another or additional audio channel provided for in the Multichannel Television Sound (MTS) broadcast standard. A monaural soundtrack included within the recorded or video signal (usually containing a second language translation for the displayed program).

Sleep Timer

Function with which you can set a time period after which the TV should turn itself off.

S-Video Input

Allows direct connection of high-resolution video sources, such as a Super VHS videocassette recorder, Laser Disc player, etc. Provides improved picture resolution, sharpness, and clarity.

Norcent Technology Inc.,
550 Cliffside Drive,
San Dimas, CA91773
www.norcent.net
info@norcent.net
support@norcent.net
Customer support 909-305-2121

P/N : 41L1701-815-1A