

LASER SENSOR LS-B110/LS-B110W

Thank you for purchasing the TOPCON LS-B110/LS-B110W. For the best performance of the instruments, please read these instructions carefully and keep them in a convenient location for future reference.

GENERAL HANDLING PRECAUTIONS

Before starting work or operation, be sure to check that the system is functioning properly. Remove the batteries from the instrument when you will not be using it for long period. When washing the instrument, avoid spraying it with a high pressure stream of water from a water hose. The inside of the instrument will be damaged by the water. This instrument is designed based on the International Standard IPX 6, but it is not protected from a high pressure water stream or submergence.



Affection of the radio waves

When using the instrument in the following place, the strong radio wave may cause faulty operation.

- Near the instrument occurring strong radio waves. (e.g. Transceiver)
- Near the radio wave towers such as television or radio.

DISPLAY FOR SAFE USE

In order to encourage the safe use of products and prevent any danger to the operator and others or damage to properties, important warnings are put on the products and inserted in the instruction manuals. We suggest that everyone understand the meaning of the following displays and icons before reading the "Safety Cautions" and text.

Display	Meaning
 WARNING	Ignoring or disregard of this display may lead to death or serious injury.
 CAUTION	Ignoring or disregard of this display may lead to personal injury or physical damage to the instrument.

- Injury refers to hurt, burn, electric shock, etc.
- Physical damage refers to extensive damage to buildings or equipment and furniture.

HANDLING PRECAUTIONS

Guarding the instrument against shock

When transporting the instrument, provide some protection to minimize risk of shock. Heavy shock may affect beam accuracy.

SAFETY CAUTIONS

 WARNING
<ul style="list-style-type: none"> • There is a risk of fire, electric shock or physical harm if you attempt to disassemble or repair the instrument yourself. This is only to be carried out by TOPCON or an authorized dealer, only!
<ul style="list-style-type: none"> • Risk of fire or electric shock. Do not use damaged power cable, plug and socket.
<ul style="list-style-type: none"> • Risk of fire or electric shock. Do not use a wet battery.
<ul style="list-style-type: none"> • May ignite explosively. Never use an instrument near flammable gas, liquid matter, and do not use in a coal mine.
<ul style="list-style-type: none"> • Battery can cause explosion or injury. Do not dispose in fire or heat.
<ul style="list-style-type: none"> • The short circuit of a battery can cause a fire. Do not short circuit battery when storing it.
<ul style="list-style-type: none"> • Battery can cause explosion or injury. Remove battery when using the connector for external communication.

 CAUTION
Do not allow skin or clothing to come into contact with acid from the batteries, if this does occur then wash off with copious amounts of water and seek medical advice.

EXCEPTIONS FROM RESPONSIBILITY

- 1) The user of this product is expected to follow all operating instructions and make periodic checks of the product's performance.
- 2) The manufacturer, or its representatives, assumes no responsibility for results of a faulty or intentional usage or misuse including any direct, indirect, consequential damage, and loss of profits.
- 3) The manufacturer, or its representatives, assumes no responsibility for consequential damage, and loss of profits by any disaster, (an earthquake, storms, floods etc.).
A fire, accident, or an act of a third party and/or a usage any other usual conditions.
- 4) The manufacturer, or its representatives, assumes no responsibility for any damage, and loss of profits due to a change of data, loss of data, an interruption of business etc., caused by using the product or an unusable product.
- 5) The manufacturer, or its representatives, assumes no responsibility for any damage, and loss of profits caused by usage except for explained in the user manual.
- 6) The manufacturer, or its representatives, assumes no responsibility for damage caused by wrong movement, or action due to connecting with other products.

Standard Set Composition

- 1 LS-B110/LS-B110W Instrument 1pc.
- 2 C-size dry cells 4pcs.
- 3 Carrying case 1pc.
- 4 Instruction manual 1pc.

Nomenclature and Functions

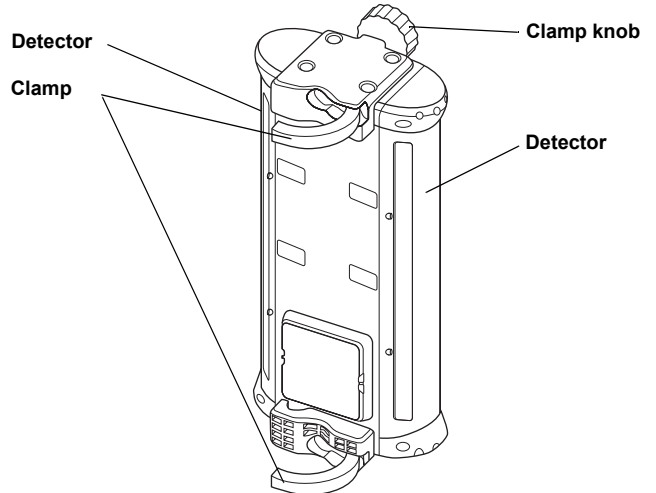
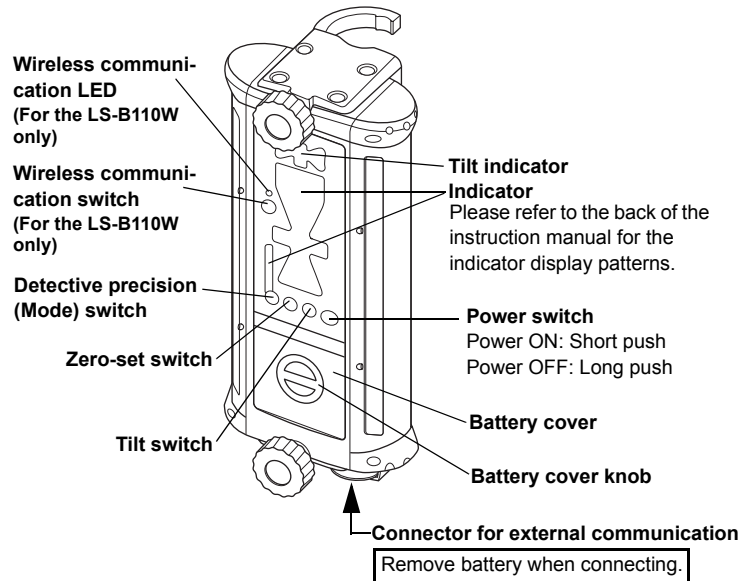

Pipes that can be installed onto the LS-B110/LS-B110W are as described below.

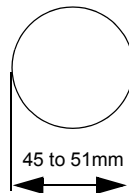

Shape: Cylindrical
Dimension: 45 to 51mm in diameter

Please refer to the instruction manual for the machine or contact the machine manufacturer for instructions on installing the mast onto the machine (by welding, etc.).

Operation

- 1 Position a rotating laser and turn on the laser.
- 2 Raise or lower the machine blade or arm to position the cutting edge or bucket at the desired grade elevation.
- 3 Mount the LS-B110/LS-B110W onto the mast near the path of the laser beam and turn on the LS-B110/LS-B110W.
- 4 Keep the machine blade or arm motionless and raise or lower the LS-B110/LS-B110W and adjust until ON-GRADE position are flashing. This is the ON GRADE position.
- 5 Securely clamp the LS-B110/LS-B110W in place. The reference position has been set.
- 6 While operating, use the LED display to continually check grade, moving the blade or cutting / filling according to the direction of the LS-B110/LS-B110W display.

Indicator

Precision mode

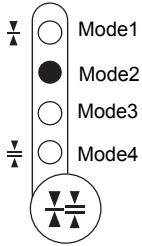

It is possible to change the detective precision of the instrument.
 Please select Mode 1 to 4 according to the objective of the operation.
 Pressing the detective precision (Mode) switch will change the mode and the corresponding LED lamp will light up.
 (During battery remaining display shown below, the lamp will flash.)

LS-B110/LS-B110W Battery remaining display

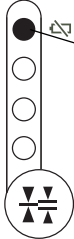

Battery remaining display LED

Battery remaining for the LS-B110/LS-B110W will be displayed at 3 levels.

Goes out:

Battery is sufficient. (When Mode 1 is selected, the lamp will light up.)

Flashes slowly:

The power is low, but sensor is still usable.

Flashes quickly:

Dead battery. Replace the dry battery with new one.

Rotating laser battery warning display

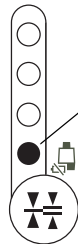

Rotating laser battery remaining warning LED

A flash shows that the rotating laser power is low.
 (This function is not usable to the rotating laser which does not have the function to output alarm signal.)

Height alert warning of rotating laser

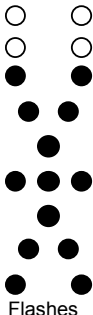

A flash signifies that the height alert function of rotating laser is operating.
 (This function is not usable to the rotating laser which does not have the height alert and the function to output alarm signal.)

Flashes

Power-save function

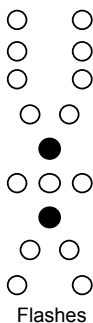

The instrument turns the power-save mode after detecting no laser beam for more than approx. five minutes.
 During the power-save mode, LED (1 yellow, 1 red) will flash.

(The mode is canceled automatically when the instrument detects a laser beam again. The mode can also be canceled by pressing the power switch again.)

Flashes

Auto-cut off function

The power will be turned off automatically after detecting no laser beam for more than approx. 60 minutes.

(To turn on the laser sensor, press the power switch again.)

* When turning the power on by pressing the power switch for more than 5 seconds, the power-save and the auto-cut off functions may be invalidated.

Connector for external communication

The LS-B110/LS-B110W can be used as the laser detecting sensor for any TOP-CON machine control system by connecting the communication cable to the connector for external communication. (Please contact your sales agent for details.)

Connecting the connector cable PC-18 (sold separately) to the connector for external communication will enable the use of the LS-B110/LS-B110W from an external power supply. When the instrument is operated with the external power supply, the power-save and the auto-cut off functions will be invalidated. The LS-B110/LS-B110W will turn on when connection is made to external power supply. The power switch of the instrument will not function when an external power supply is used. Wireless communication will not function when using external communication or an external power supply.

Laser beam positions and display patterns

Indicator (LED)	Detective precision
	Mode1: $\pm 3\text{mm}$ (0.009ft) Mode2: $\pm 6\text{mm}$ (0.019ft) Mode3: $\pm 15\text{mm}$ (0.049ft) Mode4: $\pm 30\text{mm}$ (0.098ft)
	$\pm 15\text{mm}/\pm 0.05\text{ft}$ (30mm/0.1ft width)
	$\pm 30\text{mm}/\pm 0.1\text{ft}$ (60mm/0.2ft width)
	$\pm 50\text{mm}/\pm 0.16\text{ft}$ (100mm/0.33ft width)
	$\pm 70\text{mm}/\pm 0.23\text{ft}$ (140mm/0.46ft width)
	$\pm 125\text{mm}/\pm 0.41\text{ft}$ (250mm/0.82ft width)
	When the laser beam is off to the top or to the bottom

Tilt detection function

Switching the tilt direction

The tilt direction can be changed.

- 1 Long-push the detective precision switch and the tilt switch at the same time. The tilt direction mode setting changes in the following order: "Back and Forth," "OFF" and "Right and Left." At this time, the LED at the side of the mark indicating the tilt direction will flash. The LED will not flash when the tilt detection function is switched OFF.

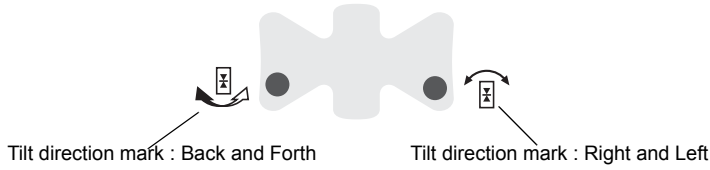

Switching the tilt precision

- 1 Short-push the tilt switch. The tilt precision will change. At this time, the LED at the side of the mark indicating the tilt precision will light up.

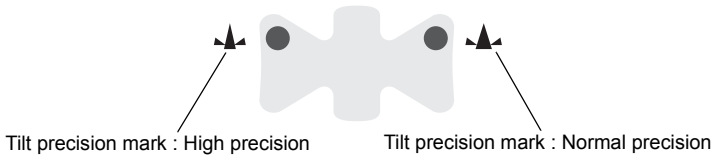

Zero position setting for the tilt sensor

Before using the tilt detection function, set the zero position of the tilt sensor according to the directions below. The tilt direction must be set before setting the zero position.

- 1 Raise or lower the machine blade or arm where the LS-B110/LS-B110W is installed to position the cutting edge or bucket at the desired slope.
- 2 Long-push the tilt switch. The tilt angle for the LS-B110/LS-B110W will set to 0°.

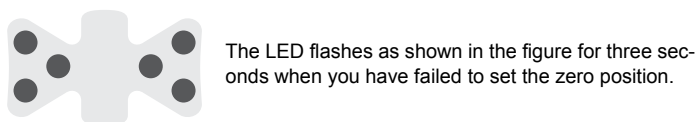
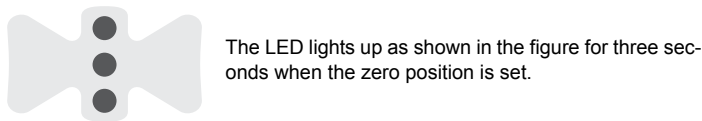

To set the vertical zero position of tilt sensor to perpendicular.

- 1 Vertically position the machine blade or arm where the LS-B110/LS-B110 is installed.
- 2 Rotate the LS-B110/LS-B110W on the pole each by 90°, and confirm that the green LED in the tilt indicator is flashing in all directions.
- 3 Set the zero position.

Tilt angles and display patterns

Tilt directions : Right and Left

	High precision : $\pm 1^\circ$ Normal precision : $\pm 2.5^\circ$
	$\pm 5^\circ$
	More than $\pm 5^\circ$

Tilt directions : Back and Forth

	High precision : $\pm 1^\circ$ Normal precision : $\pm 2.5^\circ$
	High precision : More than $\pm 1^\circ$ Normal precision : More than $\pm 2.5^\circ$

Tilt indication will be displayed during laser detection and for 20 seconds after switch operation.

Changing the ON-GRADE position function

The ON-GRADE position can be changed to the position where laser beam is detected. Using this function when installing the LS-B110/LS-B110W on the pole of the machine allows easy setting of the height at which the ON-GRADE will be displayed on the LS-B110/LS-B110W. The range in which the ON-GRADE position can be changed is $\pm 75\text{mm}$ (total of 150mm) from the center of the detective range.

- 1 Long-push the zero-set switch while detecting the laser beam.

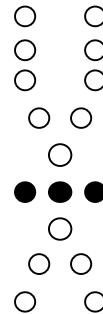

When changing the ON-GRADE position, the LED lights up for three seconds, as shown in the figure. The position where the laser beam is being detected will be the ON-GRADE position.

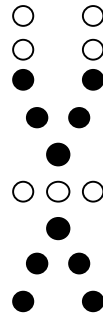

The LED lights up as shown in the figure for three seconds when you have failed to change the ON-GRADE position. Be careful not to change the position at which the laser beam is detected and try setting once again.

The LED display while changing the ON-GRADE position

The LED display indicating beam position and the LED (1 green) in the center will flash.

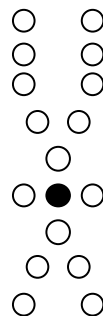

Canceling the ON-GRADE position change

- 1 Long-push the zero-set switch when not detecting the laser beam. The ON-GRADE position will be reset.

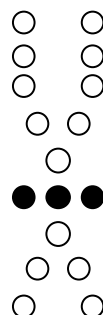

When the ON-GRADE position change is cancelled, the LED (3 green) will flash for three seconds.

How to set up the wireless communication default setting (Only LS-B110W)

This instrument is able to perform wireless communication with the RD-100W, sold separately.
See the RD-100W instruction manual for details on the RD-100W.

Place the LS-B110W and RD-100W in close position, so that they will not be affected by other wireless communications.

- 1 Turn on the power for both the LS-B110W and RD-100W.
- 2 Long-push the wireless communication switch for the LS-B110W and RD-100W. While setting up, the wireless communication LED (yellow light) will turn on.
- 3 When the instrument is ready to be used, the communication will begin.



- If the communication fails, the wireless communication LED will flash slowly. Eliminate any influence from other wireless instrument and redo the communication default setting.
- While setting up the default, only the default OFF (short-push of the wireless communication switch) is operable.

How to use wireless communication (Only LS-B110W)

When power for both the LS-B110W and RD-100W are turned ON, communication will automatically begin.

During communication, the wireless communication LED will flash quickly. During communication preparation, the wireless communication LED will flash slowly.



- When the detective precision, tilt direction, tilt precision or ON-GRADE position settings are changed, the setting for the RD-100W will also change in conjunction with the LS-B110W.
- If you wish to change the RD-100W to communicate, redo the communication default setting.

Lighting/Flashing pattern of wireless communication LED

Lights	While setting up the default
Flashes quickly	While LS-B110W is communicating
Flashes slowly	Communication is in preparation

Specifications

Detective range	: 250mm (6.8inches)
Detective angle	: 360°
Detective precision	: Mode1: ±3mm (0.009ft)
	: Mode2: ±6mm (0.019ft)
	: Mode3: ±15mm (0.049ft)
	: Mode4: ±30mm (0.098ft)
Detectable laser wave length	: 633 to 785nm
Laser detecting range (diameter)	: 800m (2625ft) (Using the RL-100 1S/2S)
Wireless communication range	: 20m (May vary depending on obstacles between the two instruments as well as other conditions)
Internal battery	: C-size dry cells 4pcs. : Battery pack BT-68Q (sold separately)
External power supply	: DC 10V to 30V
Continuous operating time* (+20°C/+68°F)	: (Using alkaline manganese dry cells) LS-B110 : Approximately 80 hours LS-B110W : Approximately 40 hours : (Using Battery pack BT-68Q) LS-B110 : Approximately 40 hours LS-B110W : Approximately 18 hours
Operating temperature	: -20°C to +50°C (-4°F to +122°F)
Water proof	: IP66 (Based on the standard IEC60529)
Dimensions (W/D/H)	: 158x166x357 (mm) (6.2"x6.5"x14.0") (With Mechanical Clamp)
Weight (Without cells)	: 2.0kg (4.4lbs)

* When the LS-B110W is performing wireless communication. Detective angle, Detective precision and Laser detecting range may vary depending on rotating laser being used or atmospheric conditions. Battery using time will vary depending on environmental conditions and operations done with LS-B110/LS-B110W.

FCC WARNING

Changes or modifications not expressly approved by the manufacturer for compliance could void the user's authority to operate the equipment.

In order to comply with FCC radio-frequency radiation exposure guidelines for an uncontrolled exposure, this device and its antenna must not be co-located or operating in conjunction with any other antenna or transmitter.

This equipment complies with FCC/IC radiation exposure limits set forth for uncontrolled equipment and meets the FCC radio frequency (RF) Exposure Guidelines in Supplement C to OET65 and RSS-102 of the IC radio frequency (RF) Exposure rules. This equipment has very low levels of RF energy that it is deemed to comply without testing of specific absorption ratio (SAR).

This device complies with Part 15 of FCC Rules and RSS-Gen of IC Rules. Operation is subject to the following two conditions : (1) this device may not cause interference, and (2) this device must accept any interference, including interference that may cause undesired operation of this device.

Declaration of Conformity R&TTE Directive 1995/5/EC

WE: TOPCON CORPORATION
75-1 Hasunuma-cho Itabashi-ku Tokyo Japan

declare on our own responsibility, that the product;
Kind of Product: Laser Sensor
Type designation: LS-B110W
is in compliance with the following norm(s) or documents;
Radio :EN 300 328
EMC :EN 301 489-1/17
safety :EN 60950



EMC NOTICE

In industrial locations or in proximity to industrial power installations, this instrument might be affected by electromagnetic noise. Under such conditions, please test the instrument performance before use.



TOPCON POSITIONING SYSTEMS, INC.
7400 National Drive, Livermore, CA 94551, U.S.A.
Phone: 925-245-8300 Fax: 925-245-8599 www.Topconpositioning.com
TOPCON CALIFORNIA
3380 Industrial Blvd, Suite 105, West Sacramento, CA 95691, U.S.A.
Phone: 916-374-8575 Fax: 916-374-8329
TOPCON EUROPE POSITIONING B.V.
Essebaan 11, 2908 LJ Capelle a/d IJssel, The Netherlands
Phone: 010-458-5077 Fax: 010-284-4941 www.topcon-europe.com
IRELAND OFFICE
Unit 09 Western Parkway Business Center
Lower Ballymount Road, Dublin 12, Ireland
Phone: 01460-0021 Fax: 01460-0129
TOPCON DEUTSCHLAND G.m.b.H.
Giesserallee 31, 47877 Willich, GERMANY
Phone: 02154-885-100 Fax: 02154-885-1111 info@topcon.de www.topcon.de
TOPCON S.A.R.L.
89, Rue de Paris, 92585 Clichy, Cedex, France.
Phone: 33-1-41069490 Fax: 33-1-47395251 topcon@topcon.fr
TOPCON SCANDINAVIA A. B.
Neengatan 2 S-43151 Mölndal, SWEDEN
Phone: 031-7109200 Fax: 031-7109249

TOPCON (GREAT BRITAIN) LTD.
Topcon House, Kimmet Side, Bone Lane, Newbury, Berkshire RG14 5PX U.K.
Phone: 44-1635-551120 Fax: 44-1635-551170 survey.sales@topcon.co.uk laser.sales@topcon.co.uk
TOPCON SOUTH ASIA PTE. LTD.
Blk 192 Pandan Loop, #07-01 Paritech Industrial Complex, Singapore 128381
Phone: 65-6778-3456 Fax: 65-6773-6550 www.topcon.com.sg
TOPCON INSTRUMENTS (THAILAND) CO., LTD.
77/162 Siam Sathorn Tower, 37th Fl.
Krungthongburi Rd., Klongtoey, Klongsarn, Bangkok 10600 Thailand.
Phone: 66-2-4401152-7 Fax: 66-2-4401158
TOPCON INSTRUMENTS (MALAYSIA) SDN. BHD.
No. D1, (Ground, Lower Ground & 1st Floor), Jalan Excelle 2, Off Jalan Ampang
Putra, Taman Ampang Hill, 55100 Kuala Lumpur, Malaysia
Phone: 60-3-42709866 Fax: 60-3-42709766
TOPCON KOREA CORPORATION
2F Yooeoung Bldg., 1595-3, Seocho-Dong, Seocho-gu, Seoul, 137-876, Korea.
Phone: 82-2-2055-0321 Fax: 82-2-2055-0319 www.topcon.co.kr
TOPCON CORPORATION BEIJING OFFICE
Block No.9, Kangding Street
Beijing Economic-Technological Development Area, Beijing, 100176, China
Phone: 86-10-6780-2799 Fax: 86-10-6780-2790
TOPCON CORPORATION DUBAI OFFICE
P. O. Box 293705, Office C-250 (row C-2), Dubai Airport Free Zone, Dubai, UAE
Phone: 971-4-2995900 Fax: 971-4-2995901 marketing@Topcon.ae