

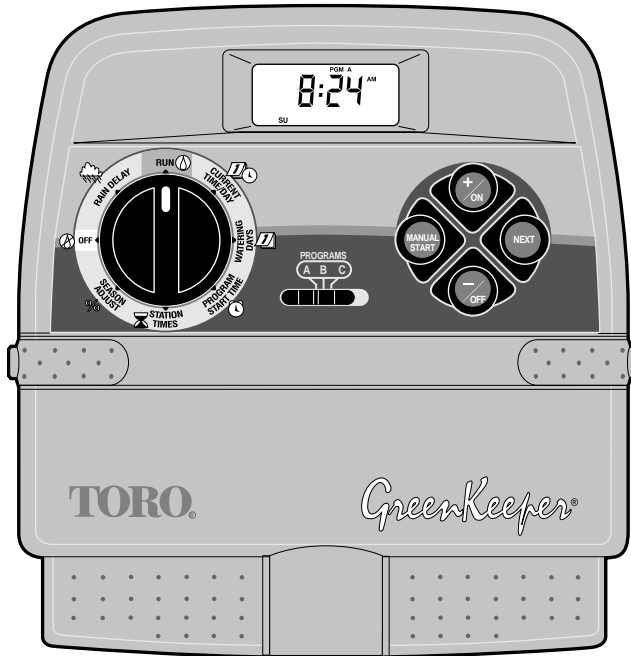

# GreenKeeper® 212

Automatic Sprinkler System Controller

## User's Guide



### GreenKeeper 212 Features:

- Easily Expandable Up To 12 Stations With 2-Station Plug-In Modules
- 3 Watering Programs With:
  - Calendar, Interval and Odd/ Even Days
  - 1 Min. to 4 Hrs. Zone Run Time
  - 4 Start Times Per Program
- Battery Back-Up
- Automatic Pump Start
- Seasonal Run Time Adjust
- Rain Delay
- Rain Sensor Ready
- Remote Control Ready
- Snap-In Wire Connectors



# Table of Contents

## Introduction and Set Up

■ GreenKeeper 212 Components.....	2-5
■ Sprinkler System Basics .....	6
■ Watering Program Basics .....	7
■ Watering Program Details .....	8-9
■ Planning Your Watering Schedule.....	10
■ Filling Out The Watering Schedule Form ...	10-11
■ Watering Schedule Form .....	12
■ Programming Before Installation .....	13
■ Installing The Battery .....	13
■ Selecting Optional Features .....	14
■ 24-Hour Clock Mode .....	14
■ 15-Second Run Delay .....	14
■ Odd/Even Watering Days.....	14
■ About The Controller Memory.....	14
■ Resetting The Controller Memory .....	15
■ To Reset The Permanent Memory.....	15
■ To Clear The Memory .....	15

## Programming The Controller

■ Setting The Current Time And Day or Date.....	16
■ Setting The Watering Day Schedule .....	17-19
■ Setting A Calendar Schedule.....	17
■ Setting An Interval Schedule.....	18
■ Setting An Odd or Even Schedule .....	19
■ Turning Off A Program .....	19
■ Setting Program Start Times .....	20
■ Setting Station Run Times .....	21

## Installation

■ Mounting The Controller .....	22
■ Connecting The Valves.....	23
■ Connecting A Pump Start Relay .....	24
■ Connecting The Transformer.....	24
■ Connecting A Toro Rain Switch.....	25

## Controller Operation

■ Automatic Operation .....	26
■ Manual Operations .....	27
■ Starting Programs Or Stations Manually.....	27
■ Watering Control Features .....	28
■ To Pause Watering .....	28
■ To Resume Watering.....	28
■ To Cancel Watering .....	28
■ To Skip Zones.....	28
■ To Adjust The Station Run Time .....	29
■ Turning Off The GreenKeeper 212 .....	29
■ Using The Rain Delay Feature .....	29
■ Using The Season Adjust Feature .....	30

## Service and Specifications

■ Replacing The Fuse.....	31
■ Adding A Station Module .....	32
■ Troubleshooting .....	32
■ Specifications.....	33
■ Warranty Information .....	33
■ Electromagnetic Compatibility .....	34



## GreenKeeper 212 Components

---

The following are brief descriptions of the controller components and display elements. Each of these items will be explained in further detail within the appropriate programming, operating and installation sections of this guide.

### 1 - LCD Display

- A** - "Start Time" symbol – Alarm clock is displayed when setting the program start times.
- B** - Program start time identification numbers 1–4.
- C** - Main display of various time values and prompts.
- D** - Program A, B and C identifiers.
- E** - "Watering On" symbol – Water droplet indicates a watering station is running. Droplet flashes if watering is paused.
- F** - "Watering Off" symbol – Water droplet with slash indicates all watering activity is Off.
- G** - "Power Off" symbol – Displayed when 24 V a.c. is disconnected and controller is on battery power only.
- H** - "Low Battery Voltage" symbol – Indicates low battery voltage (when transformer is disconnected).
- I** - Watering Station identification numbers.
- J** - "Percent" symbol – Indicates the Season Adjust feature is in use.
- K** - Day of the week identifiers.
- L** - "Run Time" symbol – Hourglass is displayed when setting the watering station run times.

### 2 - Control Buttons

**+ON** button – Increases the time display, scrolls forward through the program information and selects watering days.

**-OFF** button – Decreases the time display, scrolls backward through the program information and removes watering days.

**NEXT** button – Advances to the next portion of program information. Resumes watering if paused. Advances through stations manually when watering.

**MANUAL START** button – Selects and starts manual watering operations.

**3 - Control Dial** – Selects all controller programming and operation controls (except Manual Start).

#### Control Dial Positions

**RUN**  – The normal dial position for all automatic and manual operations.

**CURRENT TIME/DAY**  – Enables the clock time and day to be set.

**WATERING DAYS**  – Enables the watering day schedules to be set and reviewed.

**PROGRAM START TIME**  – Enables the program start times to be set and reviewed.

**STATION TIMES**  – Enables the station run time to be set and reviewed.

(continued)

## Controller Components

---

### 3 - Control Dial Positions (continued)

**SEASON ADJUST %** – Enables the run time of all zones in a program to be simultaneously increased or decreased in 10% increments.

**OFF**  – Shuts off and prevents all automatic and manual watering activity.

**RAIN DELAY**  – Enables all watering operations to be delayed from 1 to 7 days.

**4 - Program Select Switch** – Three-position slide switch used to select watering program A, B or C during the programming procedures and manual operation.

**5 - 12 or 24-Hour Clock Selector Jumper** – Removing this jumper selects 24-hour (military time) clock mode. Jumper installed selects 12-hour clock mode.

**6 - Run Delay Selector Jumper** – Removing this jumper selects a 15-second delay period before a station begins watering. Jumper installed provides a 2-second delay.

**7 - Odd/Even Day Schedule Selector Jumper** – Removing this jumper enables an Odd/Even watering day schedule to be selected.

**8 - Fuse** – 0.75 Amp, 250V Fast Blow fuse.

**9 - Battery Charger Switch** – Controls the battery charging circuit. Switch positions provided for Alkaline and rechargeable batteries.

**10 - Rain Sensor Control Switch** – Controls the sensor input circuit. Switch positions provided for sensor circuit On and Off.

**11 - Sensor Connection Terminals** – Snap-in connectors for connection of an (optional) Toro Rain Switch.

**12 - Common Connection Terminal** – Snap-in wire connector for the valve common wire.

**13 - Pump/Master Valve Connection Terminal** – Snap-in wire connector for a pump start relay or master valve.

**14 - Transformer Connection Terminals** – Snap-in connectors for the plug-in transformer wires.

**15 - Plug-In Station Control Module** – Each control module provides snap-in connectors for two station control valve power wires. Up to six modules can be installed.

**16 - 9-Volt Battery** – The battery maintains the controller memory if the transformer power is disconnected. Either Alkaline or rechargeable battery types can be installed.

**17 - Power Supply** – A Plug-in transformer supplies 24 V a.c. power to the controller. (Domestic transformer version shown.)

**18 - Remote Control Receiver Jack** – Modular jack provided for connection of the optional Toro Remote Control receiver cable.

(Refer to the instructions provided with the remote control device for installation and operation details.)

# Controller Components

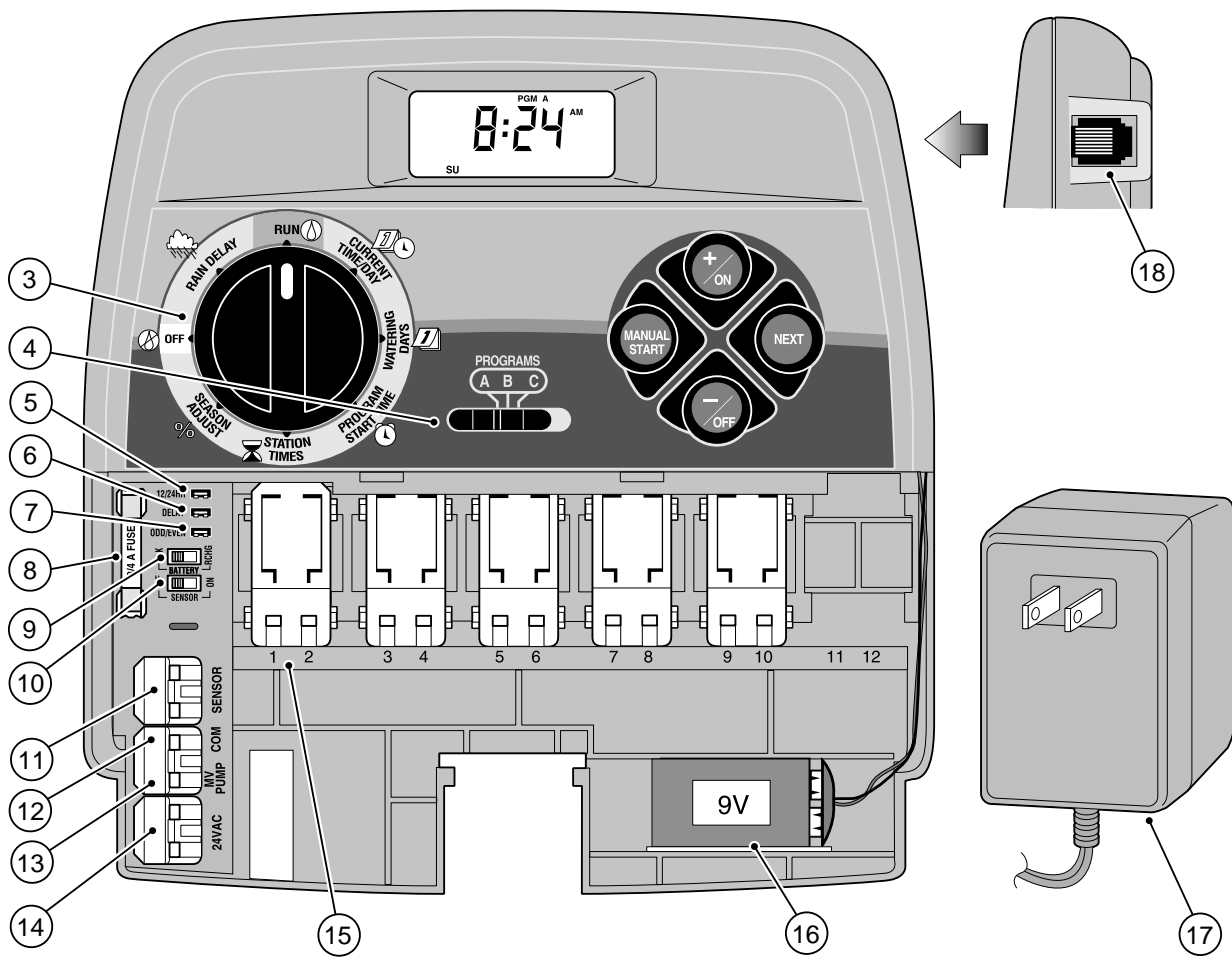

## Sprinkler System Basics

The three main components of every automatic sprinkler system are the controller, station control valves and sprinklers.

The controller is the brain of the system, telling the control valves when and how long to supply water to the sprinklers. The sprinklers direct and control the water applied to the lawn and plants.

Each valve controls a specific group of sprinklers called a watering **station**. The stations are generally laid out and installed according to the type of plant material to be watered, the location of the plant within the landscape and the maximum amount of water which can be supplied. Each valve is connected to a numbered terminal within the controller, identifying it as Station 1, Station 2, etc.

The controller operates the valves in order, one at a time. In other words, one station would water completely before another station would turn on. This is called a watering **cycle**. The information stored in the controller memory which determines when and how long the stations will water is called a **program**.

The next section of this guide is very important. It explains what a program is and how the GreenKeeper 212 controls the operation of the sprinkler system.

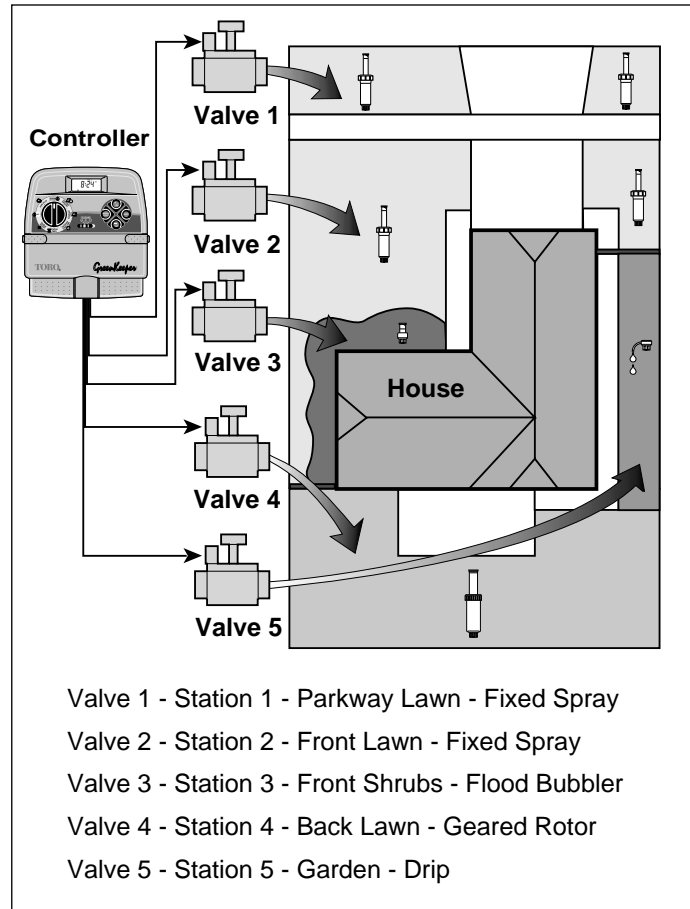



## Watering Program Basics

A watering program requires three basic instructions to operate automatically:

- What days to water –called **watering days**
- When to water – called a **program start time**
- How long to water – called **station run time**

The following example illustrates how a typical watering program could be set for the sprinkler system shown on the previous page.

Example: The program start time is set for 5:00 AM. Lawn stations 1 and 2 each have a run time of 10 minutes and lawn station 4 is set to run for 20 minutes. Note that stations 3 and 5 water shrubs and flowers and have been excluded from this program. (These stations will be set to operate on separate programs).

As shown in the watering program diagram, at 5:00 AM the controller starts the program watering cycle. Station 1 sprinklers run for 10 minutes and shut off. Station 2 sprinklers turn on, run for 10 minutes and shut off. The controller skips station 3 and turns on station 4, which runs for 20 minutes and shuts off. Station 5 is skipped and the watering cycle ends at 5:40 AM.

As you can see from this example, only one program start time was needed to operate three different stations.

Because of variations in plant watering needs, the GreenKeeper 212 provides three separate programs. The programs, called **A**, **B** and **C**, are completely independent of one another – like having three timers in one housing.

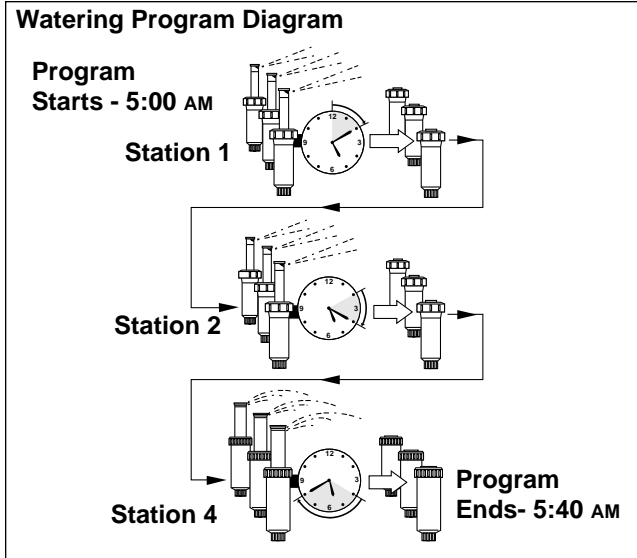

Using more than one program for example, would enable lawn zones to be watered every day on program **A**, shrub zones to run on on Monday, Wednesday and Friday on program **B** and drip irrigation to soak the flower beds every three days on program **C**.

Although the GreenKeeper 212 offers the multiple program feature, you may want to have all zones on one program if it meets your needs. The other programs can remain turned off until you need to use them.

## Watering Program Details

This section covers in detail each of the three parts of a watering program – watering days, program start times and station run times.

### Selecting Watering Days

The GreenKeeper 212 provides four options for scheduling watering days: Calendar, Interval, Odd or Even and Off.

#### Calendar Schedule

A Calendar schedule enables you to select specific days of the week to water, for example, Monday, Wednesday and Friday. This is a seven-day schedule which starts on Sunday and ends on Saturday.

This illustration shows how a Calendar schedule would be displayed when the control dial is in the

**WATERING DAYS**  position.

In this example, program **A** has watering days set for **MO** (Monday), **WE** (Wednesday) and **FR** (Friday).

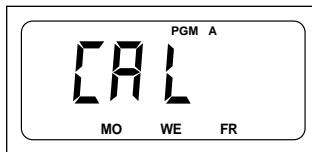

#### Interval Schedule

An Interval schedule enables you to set watering days without regard to the actual days of the week. For example, if you want to water every third day, you would select a 3-day Interval. Interval schedules range from 1-day (watering every day) to 7-day (watering every seventh day). Once you have selected an Interval schedule,

you can choose which day of the week will be the first day of the Interval. The number of days in the Interval determines the available start days. For example, if you have selected a 3-day Interval and today is Sunday, you may choose to start the Interval today, Monday or Tuesday.

This illustration shows how an Interval schedule would be displayed. In this example, program **B** has a 3-day Interval schedule which will start on Monday.

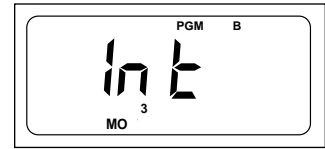

#### Odd/Even Schedule

The Odd/Even schedule enables you to select odd even numbered days of the month as watering days.

This illustration shows how an Odd day schedule would be displayed.

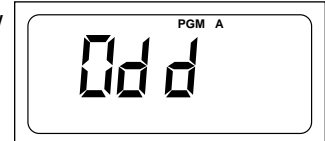

#### Program Off

Selecting OFF suspends the operation of the program when it is not needed. Turning the program off does not alter or erase the watering day schedule of the program, it simply places the program on hold until it is needed.

This illustration shows how a program would be displayed if its watering day schedule is turned off. In this example, program **C** is off.

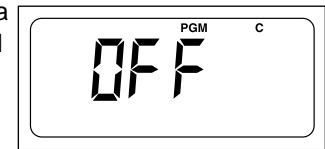



## Selecting Program Start Times

A program start time is the time of day you select to begin an automatic program watering cycle.

**It is important to remember that a program only requires one start time to operate automatically.**

When a program starts, each station assigned to a program will water in numerical order, one at a time for its set run time.

Sometimes it is necessary to run a watering program more than one time per day. For example, when growing a new lawn. The GreenKeeper 212 enables each program to have up to four separate start times per day.

Program start times are numbered 1 through 4. These numbers are shown at the top left of the display next to the start time symbol  when the control dial is in the **PROGRAM START TIME**  position and indicate how many start times are currently set for the program.

This illustration shows how a program start time is displayed. In this example, program **A** has one start time (start time number 1) set for 5:00 AM.

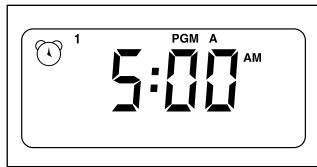

## Setting The Station Run Time

A station run time is the length of time the station (controlled by the valve) will water during the program watering cycle. The run time for each station can be set from Off (no run time) to 4 hours, in one-minute increments.

A station is **assigned** to a program when it is given a run time. If the run time for a station is turned Off in a program, it will not operate during the program watering cycle. This is how the GreenKeeper 212 enables you to assign stations to different programs.

All stations assigned to the program are shown on the lower portion of the display when the control dial is in the **STATION TIMES**  position.

This illustration shows how a station run time is displayed for a program. In this example, zones 1–6 are assigned to program **A**. Station 1 has a 10-minute run time and station 2 is set to run for 25 minutes.

The station run time being displayed is identified by the flashing station number.

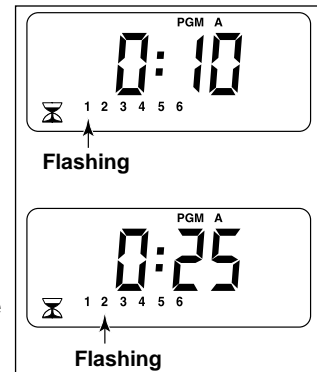

## Planning Your Watering Schedule

It is always helpful to plan your watering schedule on paper before beginning the programming steps. You will have a record of your watering schedule and station locations which can be kept with your GreenKeeper 212 after it is installed. A watering schedule form is provided on page 12 for you to fill out.

### ◆ Guidelines For Watering

There are several factors to be considered when deciding when and how long to water. For example, the soil type (i.e., clay, loam, etc.), the part of the landscape being watered, climate conditions and the type of sprinklers being used. Because of these variables, we cannot provide an exact schedule to follow, but here are some general watering guidelines to help you get started.

- Water early in the morning, one to two hours before sunrise. You will have the best water pressure at this time and the water can soak into the plant root zone while evaporation is minimal. Watering during mid-day or in the evening may cause plant damage or mildew.
- Watch for signs of under- or over-watering and make program adjustments immediately.

## Filling Out The Watering Schedule Form

When filling out this form, use a pencil so changes can be easily made. Carefully remove the page from the booklet to use as a guide during programming. After installing the controller, fold the form in half and store it in the pocket behind the controller.

Refer to the example form shown on the opposite page and fill out your form in a similar manner with the following information:

- **Location** - Identify the location of each watering station and the type of plant being watered.  
**Note:** Enter the following information for each program. If the program is not needed, leave its information column blank.
- **Watering Day Schedule** - For a Calendar schedule, indicate which day(s) of the week watering is desired. For an Interval schedule indicate the desired Interval number. For Odd or Even days, simply mark the appropriate box.
- **Station Run Time** - Indicate the amount of run time (1 minute to 4 hours) for each station. Write "Off" for any station which you do not want to operate in the program.
- **Program Start Times** - Indicate the time of day to start the program. Each program can have 1 to 4 start times per watering day.

(Example)

Watering Schedule Form		PROGRAM A							PROGRAM B							PROGRAM C							
WATERING DAY SCHEDULE	CALENDAR	SU	MO	TU	WE	TH	FR	SA	SU	MO	TU	WE	TH	FR	SA	SU	MO	TU	WE	TH	FR	SA	
	INTERVAL	1	2	3	4	5	6	7	1	2	3	4	5	6	7	1	2	3	4	5	6	7	
	ODD/EVEN	ODD <input type="checkbox"/>			EVEN <input type="checkbox"/>				ODD <input type="checkbox"/>			EVEN <input type="checkbox"/>				ODD <input type="checkbox"/>			EVEN <input type="checkbox"/>				
ZONE	LOCATION	ZONE RUN TIME							ZONE RUN TIME							ZONE RUN TIME							
1	Parkway Lawn	10							Off							Off							
2	Front Lawn	10							Off							Off							
3	Front Shrubs	Off							5							Off							
4	Back lawn	25							Off							Off							
5	Garden	Off							Off							1 hr							
6																							
7																							
8																							
9																							
10																							
11																							
12																							
PROGRAM START TIMES		1	5:00 AM							4:00 AM							6:00 AM						
		2	Off							Off							Off						
		3	Off							Off							Off						
		4	Off							Off							Off						

Watering Schedule Form		PROGRAM A							PROGRAM B							PROGRAM C							
WATERING DAY SCHEDULE		CALENDAR							CALENDAR							CALENDAR							
		SU	MO	TU	WE	TH	FR	SA	SU	MO	TU	WE	TH	FR	SA	SU	MO	TU	WE	TH	FR	SA	
		1	2	3	4	5	6	7	1	2	3	4	5	6	7	1	2	3	4	5	6	7	
ODD/EVEN		ODD <input type="checkbox"/>			EVEN <input type="checkbox"/>				ODD <input type="checkbox"/>			EVEN <input type="checkbox"/>				ODD <input type="checkbox"/>			EVEN <input type="checkbox"/>				
ZONE	LOCATION	ZONE RUN TIME							ZONE RUN TIME							ZONE RUN TIME							
1																							
2																							
3																							
4																							
5																							
6																							
7																							
8																							
9																							
10																							
11																							
12																							
PROGRAM START TIMES		1																					
		2																					
		3																					
		4																					

## Programming Before Installation

The GreenKeeper 212 utilizes a 9-volt battery to retain its watering program information in the event of a main power interruption. This battery backup feature also enables your controller to be fully programmed for operation right out of the box—before installation—in the comfort of your home. Simply attach the battery and begin the programming steps. The program information will be retained for the duration of the battery life – about 72 hours for an Alkaline battery or 24 hours for a rechargeable Nickel-Metal Hydride (Ni-MH) battery.

## Installing The Battery

**Note:** The 9-volt battery does not supply enough voltage to operate the station control valves. Power from the transformer must be supplied.

1. Slide the lower housing cover toward the bottom of the controller to remove. Locate the battery wire clip and attach it to the battery terminals. Place the battery into the cabinet compartment as shown in **Figure 1**.

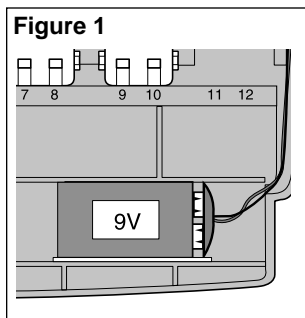

Figure 1

2. The display will begin flashing 12:00 AM. Press the **+|ON** button to stop the display from flashing. The colon (:) will continuously flash while displaying the time and during watering operation. The Power Off symbol (⊘) will be displayed until the main power supply is connected.
3. Locate the battery charger switch (9) as indicated in **Figure 2**. If an Alkaline battery is installed, the switch must be set to the left position to turn the charging circuit off. If a rechargeable Ni-MH battery is used, the switch must be set to the right position to turn the charging circuit on.

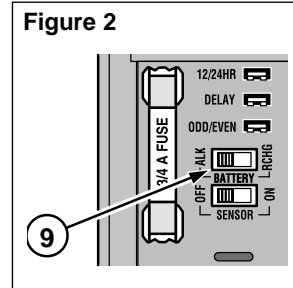

Figure 2

**⚠ Caution:** The battery charger switch must be set correctly. Damage to the controller can result from an Alkaline battery which may fail if charged.

4. Reinstall the lower housing cover.

## Selecting Optional Features

### 24-Hour Clock Mode

The GreenKeeper 212 is set to display time in the 12-hour clock mode. If you prefer to use a 24-hour clock mode (military time), select this option by removing the 12/24 Hour Selector Jumper (5). To store the jumper, install it on one pin as shown. See **Figure 3**.

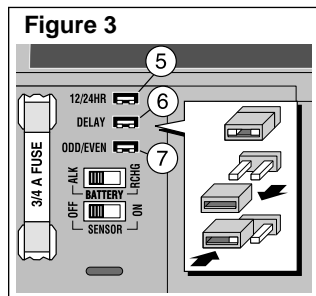

### 15-Second Run Delay

The 15-second run delay feature is useful for sprinkler systems utilizing a pump or master valve. For example, a pump usually requires a few seconds to build pressure after first starting. With the 15-second run delay selected, the pump would be running (or the master valve would open) 15 seconds before the first station begins watering. A 15-second delay would also occur between station operations. This helps ensure that one valve is closed before another valve opens.

**Note:** A 2-second run delay will occur if this option is not selected.

To select the 15-second delay option, remove the Delay Selector Jumper (6). See **Figure 3**.

### Odd/Even Watering Days

If you plan to use an Odd/Even day watering schedule, remove the Odd/Even Selector Jumper (7) for this option.

## About The GreenKeeper 212 Memory

The GreenKeeper 212 has a permanent watering schedule within its memory to assist you in two ways. First, it will restore watering operation in case your watering program is lost due to a power interruption lasting longer than the battery backup reserve. This prevents your landscape from going unwatered if the power outage occurs while you are away.

Secondly, **if you do not want to program your GreenKeeper 212, you can use the permanent watering schedule to operate your sprinklers. Just set the current time and day and your GreenKeeper 212 will be ready to operate automatically.**

The permanent watering schedule operates as follows: When power is applied, the controller clock is set to 12:00 AM Sunday. Program **A** has a Calendar watering schedule set to water every day. One program start time is set for 5:00 AM (5:00) and a run time of 10 minutes is set for each station. Programs **B** and **C** are turned Off and have no program start times or run times.

**Note:** An optional feature is provided which enables the The GreenKeeper 212 memory to be reset to the permanent program or cleared completely if you choose. If you do not want to use this option, skip the next procedure "Resetting The Controller Memory" and continue at page 16 to begin programming.



## Resetting The Controller Memory

The GreenKeeper 212 program memory can be reset to the permanent program values or cleared completely at any time without removing power.

Resetting the permanent program erases all user input and replaces it with the permanent program values.

Clearing the program memory sets all program values to Off (i.e., no active days, program start times or station run times). You may find that this simplifies programming the controller if your watering requirements are quite different than the permanent values.

**Note:** When power is first applied, the GreenKeeper 212 will always reset to the permanent program values.

### To Reset The Permanent Program (Figure 4)

- 1 Turn the control dial to the **OFF** position. **OFF** will be displayed.
- 2 Press the **+ON** and **-OFF** buttons at the same time until **CLR** is displayed.
- 3 Return the control dial to the **RUN** position.

### To Clear The Memory (Figure 5)

- 1 Turn the control dial to the **OFF** position. **OFF** will be displayed.
- 2 Press the **+ON** and **NEXT** buttons at the same time until **CLR 0** is displayed.
- 3 Return the control dial to the **RUN** position.

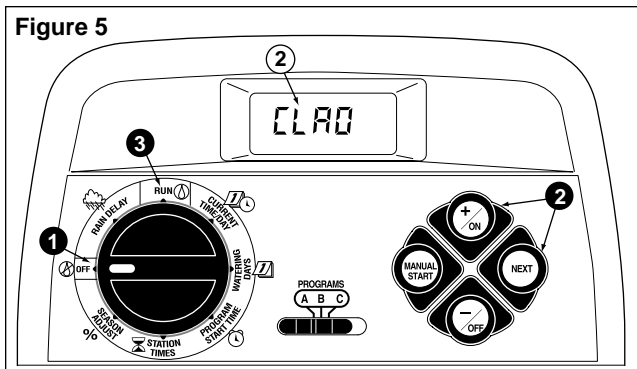
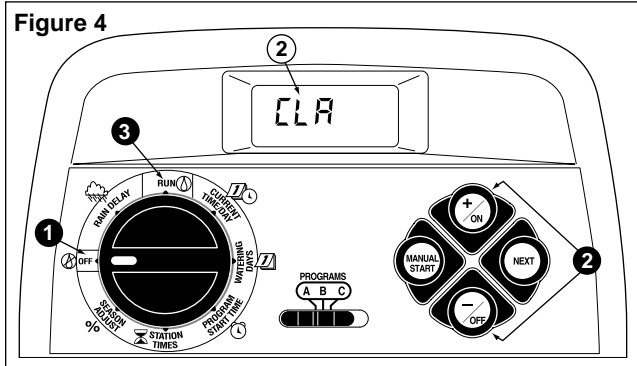

# Programming The Controller

## Setting The Current Time and Day or Date

**Note:** To select the 24-hour clock mode, see page 14.

- 1 Turn the control dial to the **CURRENT TIME/DAY** position (the hour digits will begin flashing).
- 2 To adjust the display, press the **+ON** button to scroll the digits forward or the **-OFF** button to scroll the digits backward.

**Note:** The display will begin to change rapidly if either button is held down for more than two seconds.

- 3 Press the **NEXT** button to select the next portion of the display.
4. Repeat step 2 and 3 to set the current minutes.

**Note:** If the Odd/Even Jumper is removed, the current year, month and day must be set. Continue at step 7 for this procedure. If this option is not selected, set the current day by continuing at step 5. Refer to Example 1.

- 5 To set the current day, press the **+ON** button to scroll forward or the **-OFF** button to scroll backward until the current weekday is displayed.  
The weekday abbreviations are as follows:  
su (Sunday) mo (Monday)  
tu (Tuesday) we (Wednesday)  
th (Thursday) fr (Friday) sa (Saturday)
- 6 When the current time and day are displayed, return the control dial to the **RUN** position.

Example 1

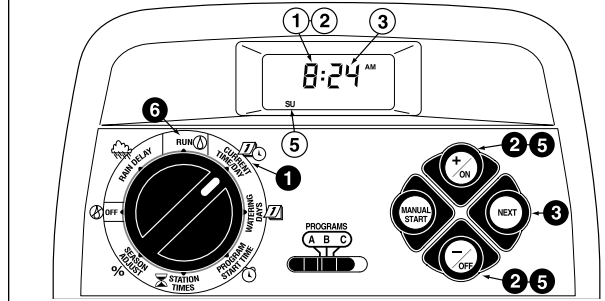

Example 2

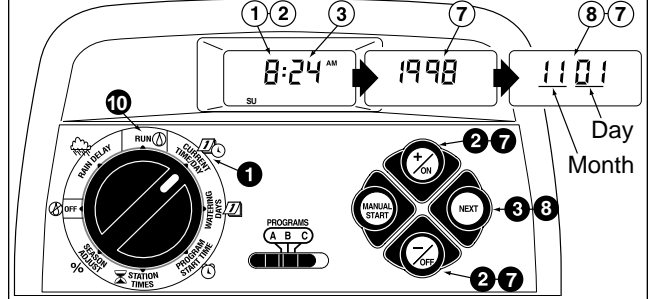

- 7 To adjust the display, press the **+ON** button to scroll the digits forward or the **-OFF** button to scroll the digits backward. Refer to Example 2.
- 8 Press the **NEXT** button to select the next portion of the display.
9. Repeat steps 7 and 8 to set the current month (first two digits) and the day (second two digits).
- 10 When the current time and date are set, return the control dial to the **RUN** position.

## Setting The Watering Day Schedule

For each program, you can select Calendar, Interval Odd, Even or Off. To set a Calendar schedule, continue here. To set an Interval schedule see page 18. To set an Odd or Even schedule see page 19. To turn Off a program, see page 19.

### Setting A Calendar Schedule

- 1 Turn the control dial to the **WATERING DAYS**  position.
- 2 Check the **PROGRAMS** switch setting. If necessary, reposition the switch to select the desired program.
- 3 The current watering schedule will be displayed. If **CAL** (Calendar) is not displayed, press the **+ / ON** or **- / OFF** button as needed to select **CAL**.
- 4 Press the **NEXT** button. The watering days currently set for this program will be displayed. **SU** (Sunday) will begin flashing.
- 5 To select Sunday as a watering day, press the **+ / ON** button. To remove Sunday from the schedule, press the **- / OFF** button. **MO** (Monday) will now begin flashing. Continue to select or remove each day of the week until only the desired watering days are shown.

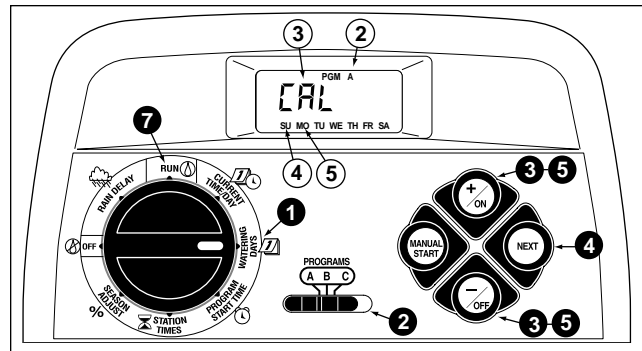

6. To set a Calendar schedule for another program, repeat all of the steps beginning at step 2.
7. When you have completed setting the Calendar schedule for each program (as needed) return the control dial to the **RUN**  position.

**Note:** Each program can have its own Calendar, Interval or Odd/Even schedule, but only one schedule can be active at a time for that program. The watering day schedule or OFF shown in the display when the control dial is in the **WATERING DAYS**  position, will be the current schedule for that program.



## Setting An Odd or Even Schedule

**Note:** The Odd/Even Selector Jumper must be removed this type of watering schedule. See page 14 for details.

- 1 Turn the control dial to the **WATERING DAYS**  position.
- 2 Check the **PROGRAMS** switch setting. If necessary, reposition the switch to select the desired program.
- 3 The current watering schedule will be displayed. If **Odd** or **Even** is not displayed, press the **+ / ON** or **- / OFF** button as needed to select **Odd** or **Even**.

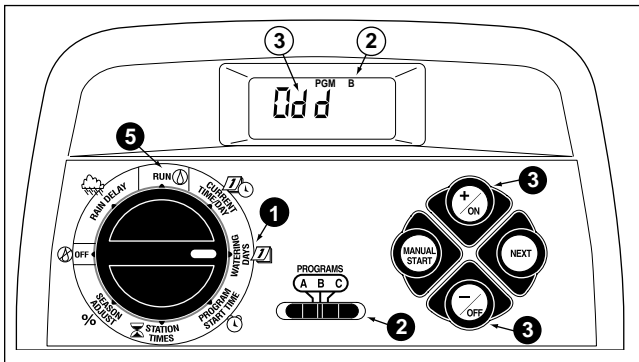

**Note:** When **Odd** is selected, the 31st day of the month and the 29th day of a leap year will not be active watering days.

4. To set an Odd or Even schedule for another program, repeat steps 2 and 3 as needed.
- 5 When you have completed setting the Odd or Even schedule for each program as needed, return the control dial to the **RUN**  position.



## Turning Off A Program

**Note:** Turning off a program does not alter or erase a preset watering day schedule. Selecting Off simply places the program on hold until one of the watering day schedules is selected.

- 1 Turn the control dial to the **WATERING DAYS**  position.
- 2 Check the **PROGRAMS** switch setting. If necessary, reposition the switch to select the desired program.
- 3 Press the **+ / ON** or **- / OFF** button until **OFF** is flashing.
4. To turn another program Off, repeat steps 2 and 3 as needed.
- 5 Return the control dial to the **RUN**  position.

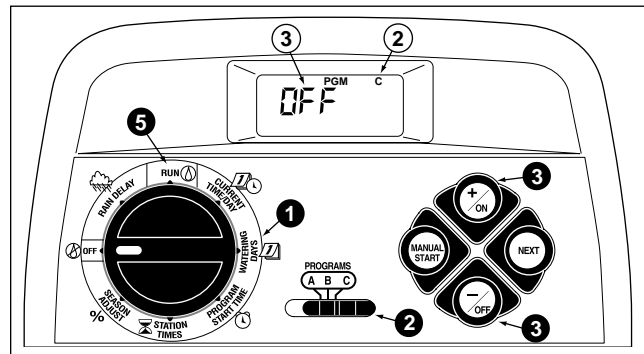

## Setting Program Start Times

- 1 Turn the control dial to the **PROGRAM START TIME** ⌚ position.
- 2 Check the **PROGRAMS** switch setting. If necessary, reposition the switch to select the desired program.
- 3 Program start time number 1 will begin flashing. The current program start time or OFF will be displayed for start time number 1. To select a different program start time number, press the **+ON** or the **-OFF** button until the desired number is flashing.
- 4 Press the **NEXT** button. The hour digit(s) or OFF will begin flashing.
 

**Note:** To remove the start time, select **OFF** by pressing the **+ON and -OFF** buttons at the same time, and continue at step 8.
- 5 To set the hour (and AM/PM), press the **+ON** or the **-OFF** button until the desired hour is flashing.
- 6 Press the **NEXT** button. The minute digits will begin flashing.
- 7 To set the minutes, press the **+ON** or **-OFF** button until the desired minute is flashing.
- 8 Press the **NEXT** button. The next program start time number will begin flashing.

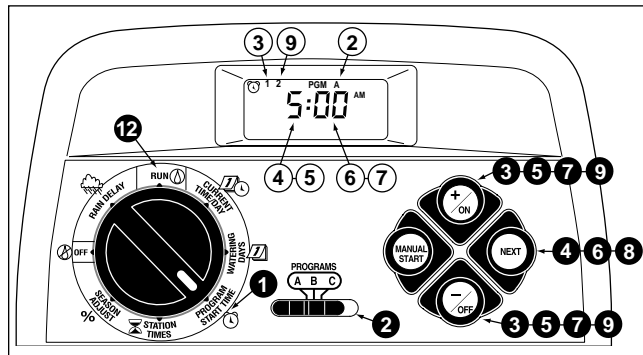

- 9 To select another start time number, press the **+ON** or the **-OFF** button until the desired start time number is flashing.
10. To set, change or remove a program start time for the start time number selected, repeat all of the steps starting at step 4.
11. To set program start times for another program, repeat all of the steps starting at step 2.
- 12 Return the control dial to the **RUN** ⌚ position.

## Setting Station Run Times

- 1 Turn the control dial to the **STATION TIMES** ⌚ position.
  - 2 Check the **PROGRAMS** switch setting. If necessary, reposition the switch to select the desired program.
  - 3 Station number 1 will be flashing and its current run time or OFF will be shown. To select a different station number, press the **+ / ON** or **- / OFF** button until the desired station number is flashing.
  - 4 Press the **NEXT** button. The run time (or OFF) will begin flashing.
  - 5 To set the run time, press the **+ / ON** or **- / OFF** button until the desired run time is shown.
- Note:** To remove the run time, select OFF by pressing the **+ / ON** and **- / OFF** buttons **at the same time**.
- 6 Press the **NEXT** button. The next station number will begin flashing.
  7. Repeat steps 5 and 6 as needed to set, change, or remove the run time for the remaining stations.
  8. To set the station run time for another program, repeat all of the steps starting at step 2.
  - 9 Return the control dial to the **RUN** ⏸ position.

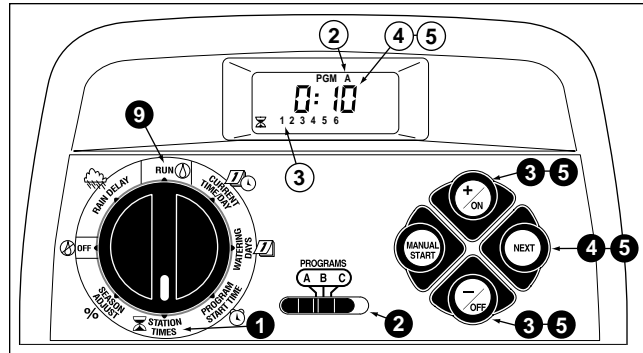

## Installation

**Note:** The GreenKeeper 212 controller is not weather resistant and must be installed indoors or in a protected area.

For outdoor installation, a weather-resistant outdoor cabinet is available. Order model number GK212-CAB-01 for domestic controllers or GK212-CAB-02 for export controllers.

### Mounting The Controller

1. Select a location for the controller within 4' (1.2m) of an electrical outlet to enable the transformer wires to easily reach. Make sure the outlet is not controlled by a light switch.

2. Remove the mounting bracket attached to the back of the controller housing by pulling the lower edge of the bracket away and downward from the controller housing.

3. Place the mounting bracket (A) against the wall aligning the top edge at about eye level. Drive three 1" (25mm) wood screws (B) into the wall through the three holes provided in the bracket.

**Note:** If you are installing the bracket on drywall or masonry, install screw anchors (C) to prevent screws from loosening.

4. **Optional** - Insert 3/4" (19mm) PVC conduit (D) for valve wiring into bracket sleeve (E).

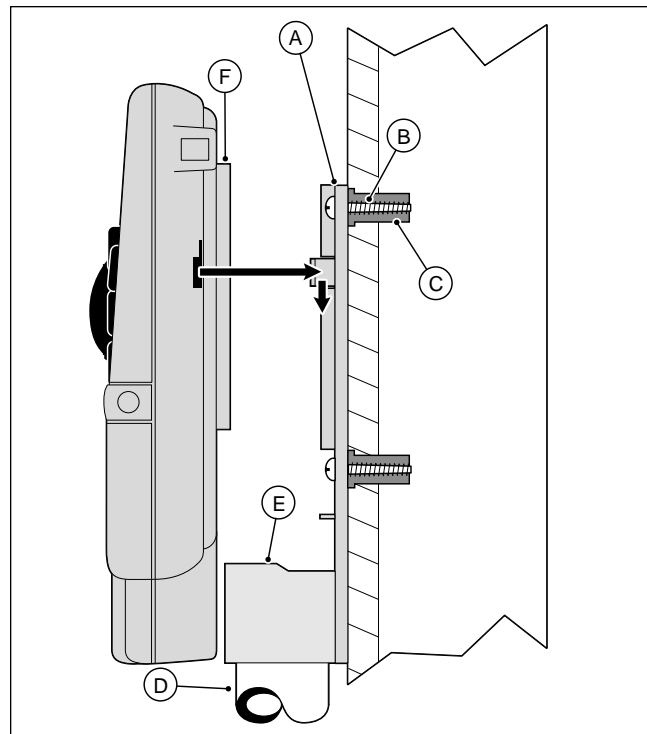

5. Align the slotted openings on the back of controller housing with the mounting bracket tabs. Slide the controller downward to engage the tabs.

**Note:** After installation, store the Quick Reference Guide and the Watering Schedule Form in the pocket (F) behind the controller.





## Connecting A Pump Start Relay

### (Optional)

**CAUTION:** To prevent controller damage, ensure the relay current draw does not exceed 0.35 Amps. Do not connect the controller directly to the pump starter.

1. Route a wire pair from the pump relay into the controller housing.
2. Connect one wire to the terminal labeled COM (12). Connect the remaining wire to the terminal labeled PUMP/MV (13) as shown below.

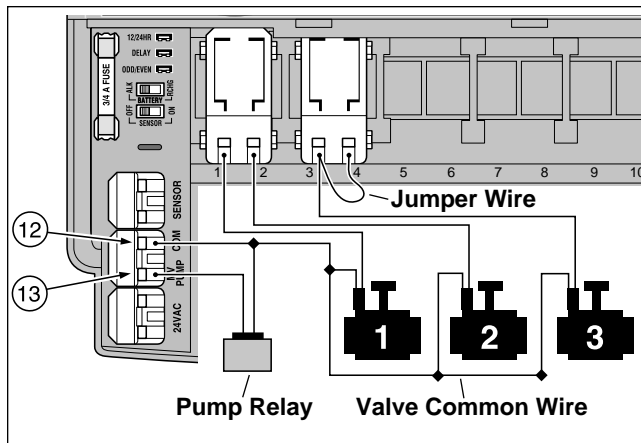

**CAUTION:** To prevent pump damage due to “dead-heading”, connect a jumper wire from any unused station terminal to a station terminal with a valve connected.

## Connecting The Transformer

**Note:** For model GK212-26-04, contact your Toro distributor for the recommended transformer.

**CAUTION:** Do not plug the transformer into an electrical outlet until all of the wiring procedures have been completed.

1. Route the cable from the transformer (17) through the small opening provided in the base of the housing. Wrap the cable around the post as shown below.

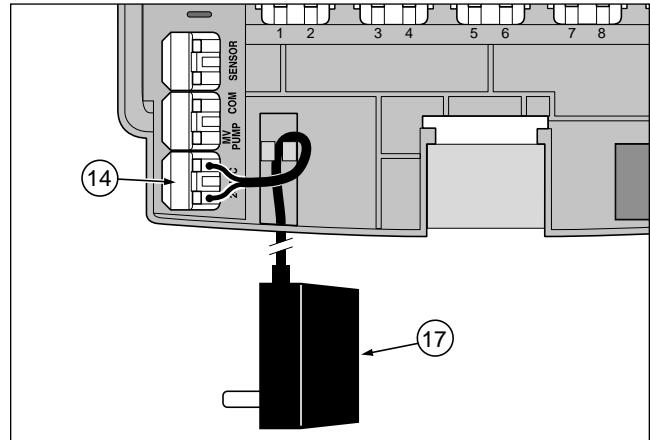

2. Connect one transformer cable wire to each terminal labeled 24 VAC (14). The wires can be connected to either terminal.

## Connecting A Toro Rain Switch

### (Optional)

The Toro Rain Switch is a remote rain sensor which can be connected directly to your GreenKeeper 212 to automatically interrupt watering during rain.

A sensor bypass switch is provided which enables the Rain Switch operation to be turned On and Off.

When the Rain Switch absorbs rain water it automatically signals the GreenKeeper 212 to suspend all watering operations. The “No Watering” symbol  will appear in the upper right corner of the display until the Rain Switch dries out and automatically resets. The “No Watering” symbol will disappear and controller operation will resume as programmed.

1. Route the wire cable from Toro Rain Switch into the controller housing with the valve wires.
2. The Rain Switch cable has four wires: two copper wires and two silver wires. Only two of the wires are used. Connect the heavier 18 AWG (0.75mm<sup>2</sup>) copper wire and the thin 24 AWG (0.50mm<sup>2</sup>) silver wire to the terminals labeled SENSOR (11). Trim off the remaining two cable wires.
3. Set Sensor Switch (10) as required: ON allows the Rain Switch to interrupt watering; OFF bypasses the Rain Switch input.

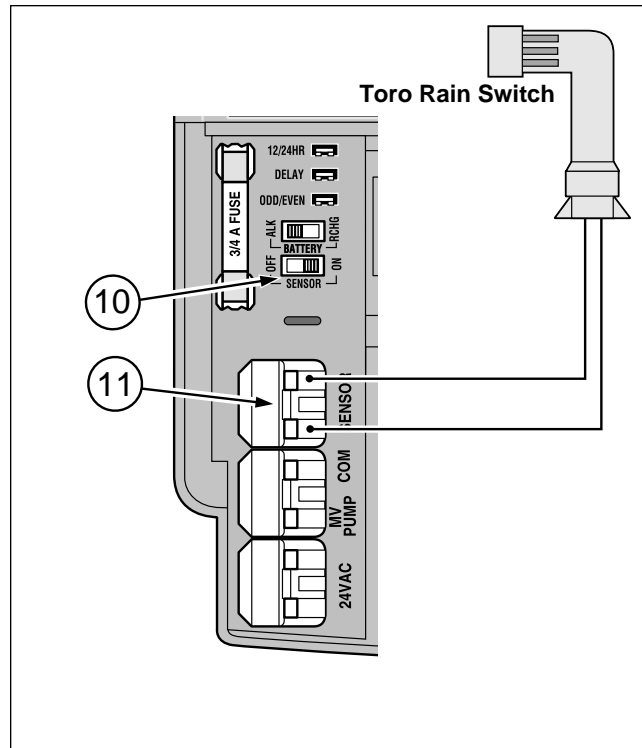

**Note:** The Toro Rain switch is a normally closed device. To install a normally open Rain Switch, refer to the instructions provided with the device and install accordingly.

## Controller Operation

The GreenKeeper 212 controller has three modes of operation: Automatic, Manual and Off. In the Automatic mode the controller tracks the time and day and operates the automatic watering schedules. The Manual mode enables the watering programs to be started and controlled manually at any time. The Off mode shuts off all watering activity and prevents any zones from operating automatically or manually.

The Rain Delay and Season Adjust control features are provided to enable quick, temporary changes in operation to help compensate for variables in weather and season.

Each of the operating modes and control features are explained in this section of the guide and can be found on the following pages:

- Automatic Operation, page 26
- Manual Operations, page 27 & 28
- Turning Off The GreenKeeper 212, page 29
- Using the Rain Delay Feature, page 29
- Using the Season Adjust Feature, page 30

## Automatic Operation

In the Automatic mode, the GreenKeeper 212 keeps track of the current time, day of the week and the automatic watering program schedule. Automatic operation will occur whenever a programmed watering day and start time match the current time and day.

The Automatic mode is selected when the control dial is in the **RUN** Ⓞ position. While in the automatic mode, the display will show two types of information: status and operation.

This illustration shows the status display. In this example the current time is 2:45 PM and the current day is Monday. Programs **A** and **B** are active on Monday.

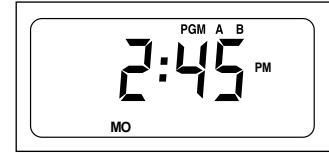

When watering starts, the operating display appears and is shown for the duration of the program.

In this example, program **A** is operating. Station 1 is watering and has 10 minutes of run time remaining. Zones 2, 3 and 4 will operate during this program.

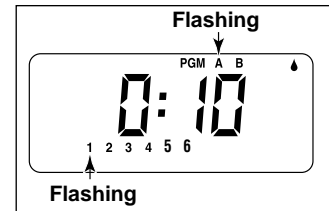

**Note:** If the control dial remains in any other position (except **OFF**) for more than 8 minutes, the controller reverts to the Automatic mode.

The **PROGRAMS** switch is not functional in the Automatic Mode.

## Manual Operation

Manual operation enables the automatic watering programs or selected stations assigned to the program to be started manually. During operation, temporary changes can be made to increase or decrease the station run time, step through the station sequence and pause or stop watering using the “Watering Control Features” described on page 28. Upon completion of the manual watering operation, the controller will return to the Automatic mode.

### Starting Programs and/or Stations Manually

You may choose to operate all stations or selected stations in each program. Watering programs can be started individually or set to start in order. When one program finishes the next selected program will operate.

- 1 Ensure the control dial is in the **RUN**  position.
- 2 Position the **PROGRAMS** switch to select a program you wish to start.
- 3 Press the **MANUAL START** button. The first station number assigned to the program will start flashing.
- 4 • To operate the program with all assigned stations, continue at step 5.  
• To operate only **selected** stations, press the **+ / ON** button to select the flashing station number, or press the **- / OFF** button to skip the station number. Continue selecting stations in this manner. Only the stations remaining on the display will operate.

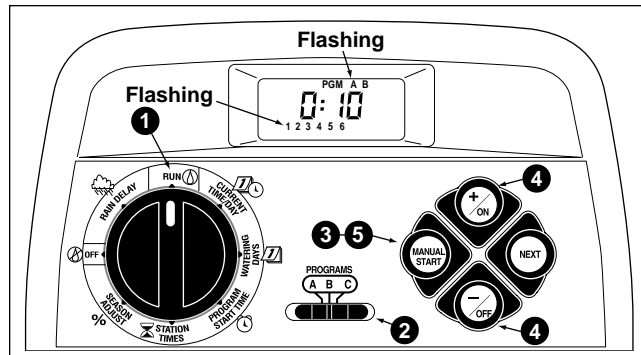

**Example:** Program A is operating. Program B will start when program A is finished.

- 5 Press the **MANUAL START** button.
6. To select additional programs, repeat steps 2 through 5.

**Note:** Additional programs set to start will operate one at a time in alphabetical order regardless of the order they were selected. Each program letter will be displayed as it is selected. The program currently operating is indicated by the flashing letter.

## Watering Control Features

The following watering control features enable you to further control the watering program during operation.

All watering control features apply to watering programs started manually **and** automatically.

### To Pause Watering

---

Press the **+ / ON** and **- / OFF** buttons **at the same time**.

- The station currently watering will shut off.
- The “Watering On” symbol will begin flashing.
- The display will show the amount of run time remaining for the paused station.

**Note:** If watering is not resumed within 8 minutes, all watering operations will be canceled and the controller will return to the automatic mode.

### To Resume Watering (when paused)

---

Press the **NEXT** button.



- Watering activity will resume from the point of interruption.

### To Cancel Watering

---

Press the **+ / ON** and **- / OFF** buttons **at the same time - two times**.

- All watering operations will be canceled and the controller will return to the automatic mode.

**Note:** Placing the control dial in the **OFF**  position for two seconds, then back to **RUN**  will also cancel all watering operations.

### To Skip Stations

---

Press the **NEXT** button one time.

- The station currently watering will shut off and the next station will start.
- If the last station is skipped, the program will end. If additional programs have been set to operate the next program in alphabetical order will start.

### To Adjust The Station Run Time

---

Press the **+ / ON** button to increase run time or the **- / OFF** button to decrease run time.

- If the station run time is decreased to less than 1 minute, the station will shut off. The next station in sequence will start.
- The station run time is changed during this operation only. The program memory will not be changed.

## Turning Off The GreenKeeper 212

When the control dial is turned to the **OFF** ⚙️ position, the controller immediately shuts off any watering operation currently in progress. Leaving the control dial in the **OFF** ⚙️ position will prevent all automatic and manual watering operations. The controller will continue to track the current time and day of the week.

For extended shutdown of the sprinkler system leave the control dial in the **OFF** ⚙️ position.

The word OFF will be displayed for 8 minutes. The automatic status display will then appear shown in this illustration.

Automatic operation is resumed by turning the control dial to the **RUN** ⚙️ position.

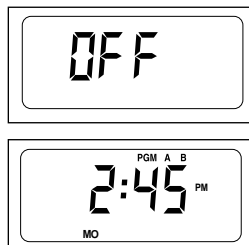

## Using The Rain Delay Feature

This feature enables all watering operations to be delayed from 1 to 7 days. For example, rain is forecast in your area for the next two days. Instead of turning the controller off (and possibly forgetting to turn it back on), a rain delay of 3 days can be easily entered. At the end of 3 days, the controller will resume automatic operation as scheduled.

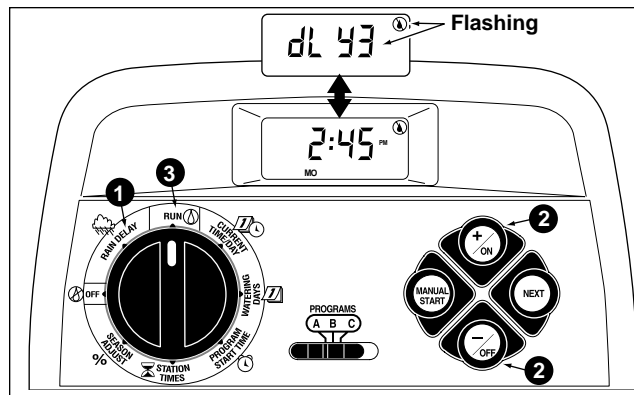

- 1 Turn the control dial to the **RAIN DELAY** ⚙️ position. The rain delay display will begin alternating with the automatic status display.
- 2 To set the number of rain delay days, press the **+ / ON** or **- / OFF** button until the desired number (1–7) is flashing.
- 3 Return the control dial to the **RUN** ⚙️ position.

**Note:** The rain delay number will automatically decrease as each day passes. When the number reaches 0 (zero), automatic operation will resume at the next scheduled start time.

**To cancel the rain delay,** turn the control dial momentarily (3 seconds) to the **OFF** ⚙️ position.

## Using The Season Adjust Feature

Changes in season and temperature generally require a change in station run time to maintain a healthy landscape and conserve water. The season adjust feature enables you to change the run time of all zones assigned to a program, simultaneously up or down, in 10% increments – with just the press of a button. Adjustments can be reduced to 10% or increased to 200% of the programmed run time of each station.

A 50% setting, for example, would decrease a 20-minute station run time to 10 minutes. Increases however, work a little differently. With any adjustment above 100%, the GreenKeeper 212 will first increase the run time by the adjustment percentage, then split the time in half and run the watering program twice. This allows the water to soak in instead of pooling or running off. For example, adjusting to 150% would first increase a 20-minute station run time to 30 minutes, then split the time in half and run two watering cycles back-to-back with 15 minutes in each operation. During operation the % symbol will flash to indicate a multiple watering operation.

**Note:** All station run times are retained in the controller memory and returned to their set value when the season adjust is reset to 100%. The only time a station run time will appear changed is during operation.

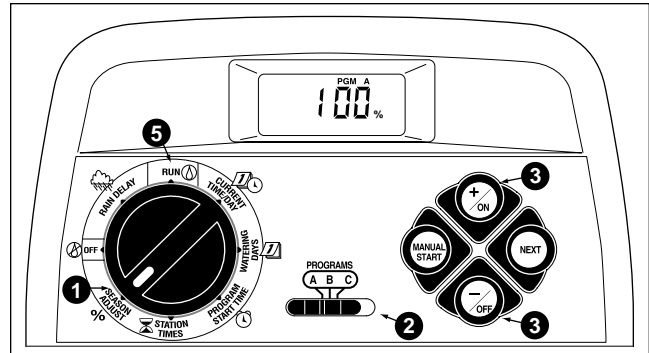

- 1 Turn the control dial to the **SEASON ADJUST %** position. The season adjust display will be shown and 100% will be flashing.
- 2 Check the **PROGRAMS** switch setting. If necessary, reposition the switch to select the desired program.
- 3 Press the **+/ON** or **-/OFF** until the desired adjustment value is flashing.
4. To apply the Season Adjust feature to another program, repeat steps 2 and 3.
- 5 Return the control dial the **RUN**  position.



## Service and Specifications

### Replacing The Fuse

A 0.75 Amp fuse protects the controller from damage due to power surges and excessive current draw through the Station Modules. Before replacing the fuse, check for the probable cause, such as a shorted or improperly connected control valve wire, then replace the fuse as follows:

1. Unplug the transformer from the wall receptacle.

#### WARNING



**REMOVE TRANSFORMER FROM POWER SOURCE PRIOR TO SERVICING THE FUSE. FAILURE TO COMPLY MAY RESULT IN INJURY AND/OR DAMAGE TO CONTROLLER.**

2. Remove the lower front cover from the controller housing by sliding it downward.
3. Carefully remove the blown fuse from the retaining clip.
4. Remove the replacement fuse from the back side of lower cover and install it into fuse retaining clip.

**CAUTION: For continued protection against risk of fire, replace only with the same type and rating of fuse.**

5. Install the lower front cover.
6. Plug the transformer into the wall receptacle.

### Adding A Station Module

1. Turn the control dial to the **OFF** position.
2. Remove the lower front cover from the controller housing by sliding it downward.

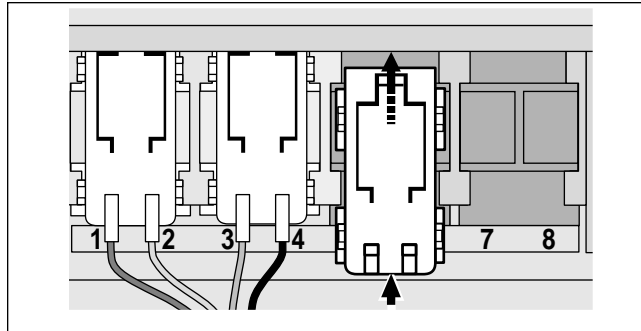

3. Place the back of the station control module (model number MOD 212-02) squarely between the guides of the first open expansion slot (from left to right). Pushing lightly on the bottom of the module, slide it upward until it locks into position.
4. To connect the valve wires, refer to “Connecting The Valves” on page 23.
5. Install the lower front cover.
6. To set the station run time, refer to “Setting Station Run Times” on page 21.
7. To test the operation of the new watering station(s), refer to “Manual Operations” on pages 27 and 28.

## Troubleshooting

If you are having a problem with the controller, check the following symptoms, possible causes and remedies. If the problem cannot be resolved or you would like assistance with any Toro irrigation product, call our toll-free **Toro Help Line**, 1-800-664-4740 Monday through Friday, 7:30 AM – 4:00 PM (Pacific Standard Time)

Symptom	Possible Cause	Remedy
<b>The display is blank and the controller does not operate.</b>	<p>The battery is dead and one or more of the following causes:</p> <p>Blown fuse.</p> <p>Transformer wires disconnected or the transformer is unplugged.</p> <p>Open circuit breaker to wall plug receptacle.</p>	<p>Replace the battery and one or more of the following:</p> <p>Replace the fuse. See page 31.</p> <p>Check the transformer connections.</p> <p>Check circuit breaker at service.</p>
<b>Watering programs start at unscheduled times.</b>	Watering programs have overlapping schedules.	Shorten station run times and/or space start times farther apart.
<b>Watering station does not turn on.</b>	<p>Faulty control valve wire connections.</p> <p>Station run time is turned Off.</p>	<p>Check the wire connections at the control valve and controller.</p> <p>Enter a station run time. See page 21.</p>
<b>Watering station does not turn off.</b>	Control valve problem.	Inspect, clean and/or replace the valve solenoid.
<b>Program restarts unexpectedly after the completion of an automatic operation.</b>	<p>More than one start time on the program.</p> <p>Season Adjust setting greater than 100%.</p>	<p>Remove additional program start times. See page 20.</p> <p>Set <b>SEASON ADJUST %</b> to 100%. See page 30.</p>

## Specifications

**Housing:** Plastic, indoor, wall mount,  
7.5" W x 8.5" H x 2" D (19cm W x 21.6cm H x 5cm D)

### Power Specifications, Domestic Model:

Plug-In Transformer, Class 2, UL Listed, CSA Certified  
(or equivalent)

- **Input:** 120 V a.c. 50/60 Hz, 0.5A
- **Output:** 24 V a.c. 50/60 Hz; 18VA

### Power Specifications, Export Model:

Plug-In Transformer, TUV Approved

- **Input:** 230 V a.c. 50Hz, 0.5A
- **Output:** 24 V a.c. 50 Hz; 18VA

### Power Specifications, Australian Model:

Plug-In Transformer, SAA Approved

- **Input:** 230–240 V a.c. 50Hz, 0.5A
- **Output:** 24 V a.c. 50 Hz; 18VA

### Maximum Load Per Station:

0.35 Amps @ 24 V a.c.

### Maximum Load For Pump/Master Valve:

0.35 Amps @ 24 V a.c.

**Total Maximum Output:** One Station plus Pump,  
not to exceed 0.70 Amps @ 24 V a.c.

**Fuse:** 0.75 Amp, Fast Blow – Protects AC Return

### Battery Type and Back-Up Duration (approximate):

9-Volt Alkaline – 72 hrs. or 9-Volt Ni-MH – 24 hrs.

### Temperature Limit Range:

Operating – 32°F to 140°F (0°C to 60°C)

Storage – -22°F to 149°F (-30°C to 65°C)

## Warranty

### The Toro Promise — Limited Two-Year Warranty

The Toro Company warrants, to the owner, each new piece of equipment (featured in the current catalog at date of installation) against defects in material and workmanship for a period of two years from the date of installation by the owner.

This warranty extends to Toro residential and commercial contractor-installed products. Toro retail (do-it-yourself installation), golf course products and products sold outside of the United States, have a one-year limited warranty from date of installation. Toro is not liable for failure of products not manufactured by Toro, even though such products may be sold or used in conjunction with Toro products.

During such warranty period, Toro will repair or replace, at its option, any part found to be defective.

Return the defective parts to your local Toro distributor, who may be listed in your telephone directory Yellow Pages under "Irrigation Supplies" or "Sprinkler Systems", or contact the Customer Service Department at The Toro Company, P.O. Box 489, Riverside, California, 92502. Within U.S.A., phone 800-664-4740 for the location of your nearest Toro distributor. Outside U.S.A., call 909-688-9221.

Toro's liability is limited solely to the replacement or repair of the defective parts. There are no other express warranties.

This warranty does not apply where equipment is used, or installation is performed, in any manner contrary to Toro's specifications and instructions, nor where equipment is altered or modified.

**Toro is not liable for indirect, incidental or consequential damages in connection with the use of equipment, including but not limited to: vegetation loss, the cost of substitute equipment or services required during periods of malfunction or resulting non-use, property damage or personal injury resulting from installer's actions, whether negligent or otherwise.**

**All implied warranties, including those of merchantability and fitness for use, are limited to the duration of this express warranty.**

This warranty gives you specific legal rights and you may have other rights which vary from state to state.

## Electromagnetic Compatibility

**Domestic:** This equipment has been tested and found to comply with the limits for a Class B digital device, pursuant to Part 15 of the FCC Rules. These limits are designed to provide reasonable protection against harmful interference in a residential installation. This equipment generates, uses and can radiate radio frequency energy and, if not installed and used in accordance with the instructions, may cause harmful interference to radio communications. However, there is no guarantee that interference will not occur in a particular installation. If this equipment does harmful interference to radio or television reception, which can be determined by turning the equipment off and on, the user is encouraged to try to correct the interference by one or more of the following measures:

1. Reorient or relocate the receiving antenna.
2. Increase the separation between the equipment and receiver.
3. Connect the equipment into an outlet on a circuit different from that to which the receiver is connected.
4. Consult the dealer or an experienced radio/TV technician for help.

The user may find the following booklet prepared by the Federal Communications Commission helpful:

"How To Identify and Resolve Radio-TV Interference Problems". This booklet is available from the U.S. Government Printing Office, Washington, DC 20402. Stock No. 004-000-00345-4.

**International:** This is a CSPR 22 Class B product.

