

Annex B

User's Manual

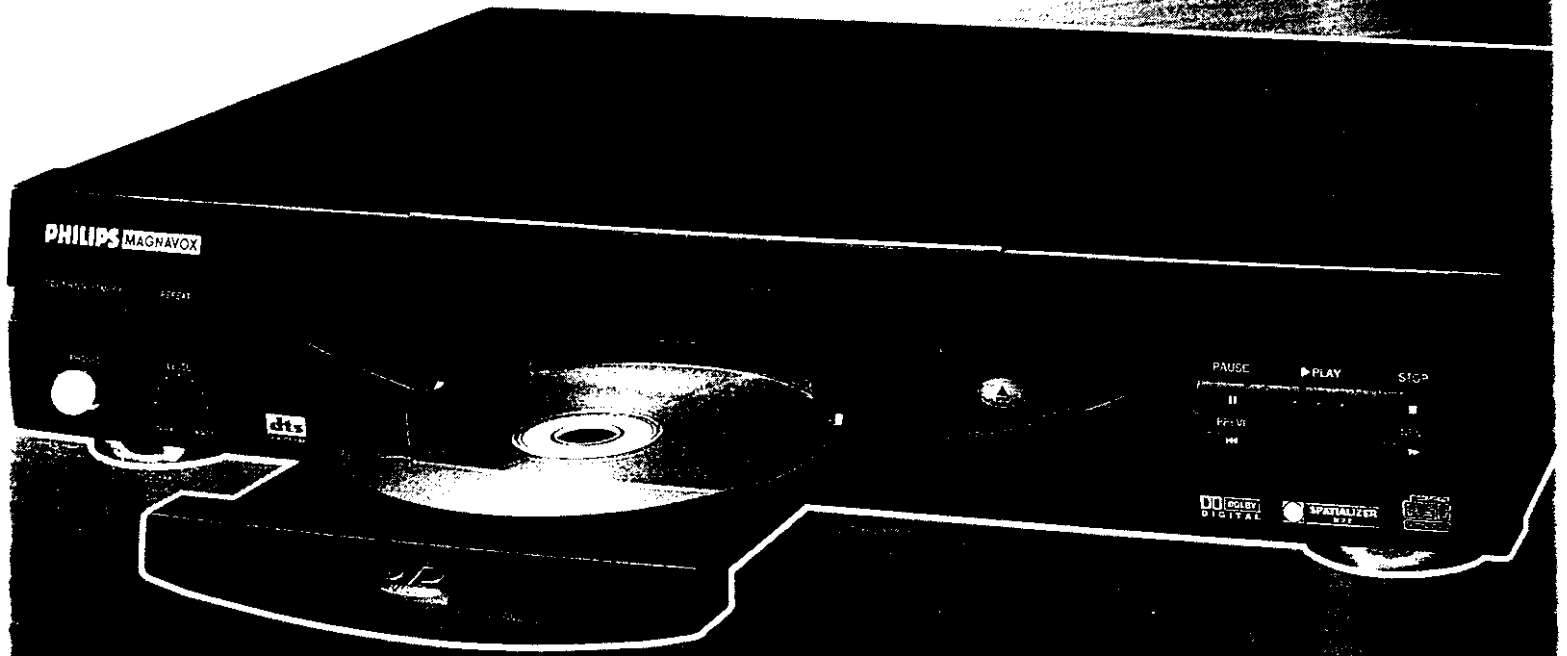

structions for use



Let's make things better.

PHILIPS MAGNAVOX

Return your Warranty Registration card today to ensure you receive all the benefits you're entitled to.

Once your PHILIPS MAGNAVOX purchase is registered, you're eligible to receive all the privileges of owning a PHILIPS MAGNAVOX product. So complete and return the Warranty Registration Card enclosed with your purchase at once. And take advantage of these important benefits.

Warranty Verification

Registering your product within 10 days confirms your right to maximum protection under the terms and conditions of your PHILIPS MAGNAVOX warranty.

Owner Confirmation

Your completed Warranty Registration Card serves as verification of ownership in the event of product theft or loss.

Model Registration

Returning your Warranty Registration Card right away guarantees you'll receive all the information and special offers which you qualify for as the owner of your model.

Congratulations on your purchase, and welcome to the "family!"

PHILIPS MAGNAVOX



Dear PHILIPS MAGNAVOX product owner:

Thank you for your confidence in PHILIPS MAGNAVOX. You've selected one of the best-built, best-backed products available today. And we'll do everything in our power to keep you happy with your purchase for many years to come.

As a member of the PHILIPS MAGNAVOX "family," you're entitled to protection by one of the most comprehensive warranties and outstanding service networks in the industry.

What's more, your purchase guarantees you'll receive all the information and special offers for which you qualify, plus easy access to accessories from our convenient home shopping network.

And most importantly you can count on our uncompromising commitment to your total satisfaction. All of this is our way of saying welcome—and thanks for investing in a PHILIPS MAGNAVOX product.

Sincerely,

Robert Minkhorst
President and Chief Executive Officer

P.S. Remember, to get the most from your PHILIPS MAGNAVOX product, you must return your Warranty Registration Card within 10 days. So please mail it to us right now!

Know these
safety symbols



This "bolt of lightning" indicates uninsulated material within your unit may cause an electrical shock. For the safety of everyone in your household, please do not remove product covering.

The "exclamation point" calls attention to features for which you should read the enclosed literature closely to prevent operating and maintenance problems.

WARNING: TO PREVENT FIRE OR SHOCK HAZARD, DO NOT EXPOSE THIS EQUIPMENT TO RAIN OR MOISTURE.

CAUTION: To prevent electric shock, match wide blade of plug to wide slot, and fully insert.

ATTENTION: Pour éviter les chocs électriques, introduire la lame la plus large de la fiche dans la borne correspondante de la prise et pousser jusqu'au fond.

SAFETY PRECAUTIONS

CAUTION: This Digital Video Disc Player employs a Laser System. To ensure proper use of this product, please read this owner's manual carefully and retain for future reference. Should the unit require maintenance, contact an authorized service location - see service procedure.

Use of controls, adjustments or the performance of procedures other than those specified herein may result in hazardous radiation exposure.

To prevent direct exposure to laser beam, do not try to open the enclosure. Visible laser radiation when open and interlocks defeated.
DO NOT STARE INTO BEAM.

FCC NOTICE: This equipment has been tested and found to comply with the limits for a Class B digital device, pursuant to part 15 of the FCC Rules. These limits are designed to provide reasonable protection against harmful interference in a residential installation. This equipment generates, uses, and can radiate radio frequency energy and, if not installed and used in accordance with the instructions, may cause harmful interference to radio communications. However, there is no guarantee that interference will not occur in a particular installation. If this equipment does cause harmful interference to radio or television reception, which can be determined by turning the equipment off and on, the user is encouraged to try to correct the interference by one or more of the following measures:

- Reorient or relocate the receiving antenna.
- Increase the separation between the equipment and receiver.
- Connect the equipment into an outlet on a circuit different from that to which the receiver is connected.
- Consult the dealer or an experienced radio/TV technician for help.

WARNING: Changes or modifications made to this equipment, not expressly approved by Philips Consumer Electronics Company, or parties authorized by Philips Consumer Electronics Company, could void the user's authority to operate the equipment.

Location of the required label

PRODUCT IS CERTIFIED BY THE MANUFACTURER TO COMPLY WITH DHHS RULES 21 CFR SUBCHAPTER J APPLICABLE AT THE DATE OF MANUFACTURE.

MANUFACTURED

DISTRIBUTED BY:
PHILIPS CONSUMER ELECTRONICS CO.
P. O. BOX 14810 KNOXVILLE, TN 37914 -1810

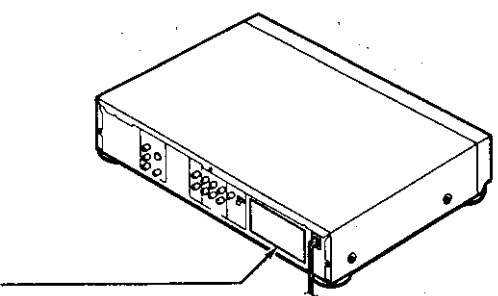

IMPORTANT SAFETY INSTRUCTIONS

CAUTION: PLEASE READ AND OBSERVE ALL WARNINGS AND INSTRUCTIONS GIVEN IN THIS OWNER'S MANUAL AND THOSE MARKED ON THE UNIT. RETAIN THIS BOOKLET FOR FUTURE REFERENCE.

This set has been designed and manufactured to assure personal safety. Improper use can result in electric shock or fire hazard. The safeguards incorporated in this unit will protect you if you observe the following procedures for installation, use and servicing. This unit is fully transistorized and does not contain any parts that can be repaired by the user.

DO NOT REMOVE THE CABINET COVER, OR YOU MAY BE EXPOSED TO DANGEROUS VOLTAGE. REFER SERVICING TO QUALIFIED SERVICE PERSONNEL ONLY.

1. Read owner's manual

After unpacking this product, read the owner's manual carefully, and follow all the operating and other instructions.

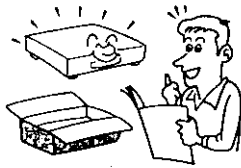

2. Power Sources

This product should be operated only from the type of power source indicated on the marking label. If you are not sure of the type of power supply to your home, consult your product dealer or local power company. For products intended to operate from battery power, or other sources, refer to the operating instructions.



3. Grounding or Polarization

This product may be equipped with a polarized alternating current line plug (a plug having one blade wider than the other). This plug will fit into the power outlet only one way. This is a safety feature. If you are unable to insert the plug fully into the outlet, try reversing the plug. If the plug should still fail to fit, contact your electrician to replace your obsolete outlet. Do not defeat the safety purpose of the polarized plug.

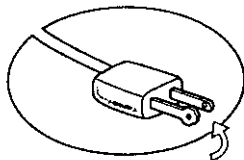

4. Ventilation

Slots and openings in the cabinet are provided for ventilation and to ensure reliable operation of the product and to protect it from overheating. These openings must not be blocked or covered. The openings should never be blocked by placing the product on a bed, sofa, rug or other similar surface. This product should not be placed in a built-in installation such as a bookcase or rack unless proper ventilation is provided or the manufacturer's instructions have been adhered to.

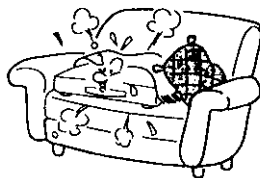

5. Heat

The product should be situated away from heat sources such as radiators, heat registers, stoves, or other products (including amplifiers) that produce heat.

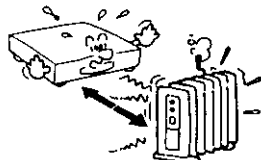

6. Water and Moisture

Do not use this product near water - for example, near a bath tub, wash bowl, kitchen sink, or laundry tub; in a wet basement; or near a swimming pool and the like.

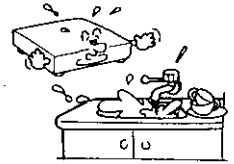

7. Cleaning

Unplug this product from the wall outlet before cleaning. Do not use liquid cleaners or aerosol cleaners. Use a damp cloth for cleaning.



8. Power-Cord Protection

Power-supply cords should be routed so that they are not likely to be walked on or pinched by items placed upon or against them, paying particular attention to cords at plugs, convenience receptacles, and the point where they exit from the product.



9. Overloading

Do not overload wall outlets, extension cords, or integral convenience receptacles as this can result in a risk of fire or electric shock.

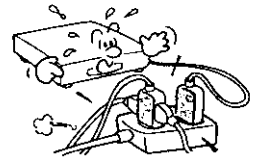

10. Lightning

For added protection for this product during a storm, or when it is left unattended and unused for long periods of time, unplug it from the wall outlet. This will prevent damage to the product due to lightning and power-line surges.

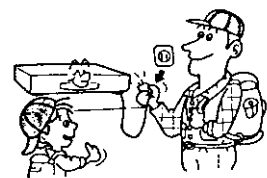

11. Object and Liquid Entry

Never push objects of any kind into this product through openings as they may touch dangerous voltage points or short-out parts that could result in a fire or electric shock. Never



IMPORTANT SAFETY INSTRUCTIONS

2. Attachments

Do not use attachments not recommended by the product manufacturer as they may cause hazards.

3. Accessories

Do not place this product on an unstable cart, stand, tripod, bracket, or table. The product may fall, causing serious injury to a child or adult, and serious damage to the product. Use only with a cart, stand, tripod, bracket, or table recommended by the manufacturer, or sold with the product. Any mounting of the product should follow the manufacturer's instructions, and should use a mounting accessory recommended by the manufacturer.



A product and cart combination should be moved with care. Quick stops, excessive force, and uneven surfaces may cause the product and cart combination to overturn.

14. Disc Tray

Keep your fingers well clear of the disc tray as it is closing. It may cause serious personal injury.

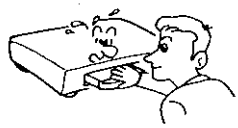

15. Burden

Do not place a heavy object on the product or step on it. The object may fall, causing serious personal injury and serious damage to the product.

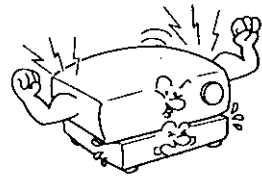

16. Headphones

When you use headphones, keep the volume at a moderate level. If you use the headphones continuously at a high volume, it may cause hearing damage.



17. Disc

Do not use a cracked, deformed, or repaired disc. These discs are easily broken and may cause serious personal injury and product malfunction.

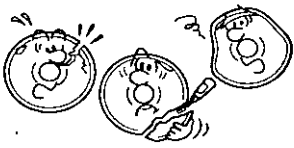

18. Damage Requiring Service

Unplug this product from the wall outlet and refer servicing to qualified service personnel under the following conditions:

- a) When the power-supply cord or plug is damaged.
- b) If liquid has been spilled, or objects have fallen into the product.
- c) If the product has been exposed to rain or water.
- d) If the product does not operate normally by following the operating instructions. Adjust only those controls that are covered by the operating instructions as an improper adjustment of other controls may result in damage and will often require extensive work by a qualified technician to restore the product to its normal operation.
- e) If the product has been dropped or damaged in any way.
- f) When the product exhibits a distinct change in performance - this indicates a need for service.

19. Servicing

Do not attempt to service this product yourself as opening or removing covers may expose you to dangerous voltage or other hazards. Refer all servicing to qualified service personnel.

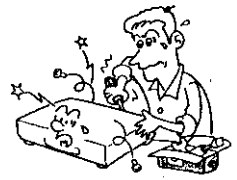

20. Replacement Parts

When replacement parts are required, be sure the service technician has used replacement parts specified by the manufacturer or have the same characteristics as the original part. Unauthorized substitutions may result in fire, electric shock, or other hazards.

21. Safety Check

Upon completion of any service or repairs to this product, ask the service technician to perform safety checks to determine that the product is in proper operating condition.

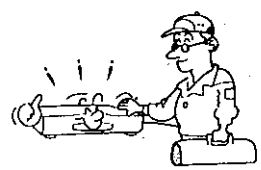

Precautions

Notes on Handling

- When shipping the DVD video player, the original shipping carton and packing materials come in handy. For maximum protection, repack the unit as it was originally packed at the factory.
- Do not use volatile liquids, such as insect spray, near the DVD video player. Do not leave rubber or plastic products in contact with the DVD video player for a long time. They will leave marks on the cabinet.
- The top and rear panels of the DVD video player may become warm after a long period of use. This is not a malfunction.
- When the DVD video player is not in use, be sure to remove the disc and turn off the power.
- If you do not use the DVD video player for a long period, the unit may not function properly in the future. Use the DVD video player occasionally.

Notes on Location

- When you place this DVD video player near a TV, radio, or VCR, the playback picture may become poor and the sound may be distorted. In this case, place the DVD video player away from the TV, radio, or VCR.

Notes on Cleaning

- Use a soft, dry cloth for cleaning.
- For stubborn dirt, soak the cloth in a weak detergent solution, wring the cloth well and wipe the unit. Use a dry cloth to wipe it dry.
Do not use any type of solvent, such as thinner and benzine, as they may damage the surface of the DVD video player.
 - If you use a chemical saturated cloth to clean the unit, follow that product's instructions.

Notes on Moisture Condensation

Moisture condensation damages the DVD video player. Please read the following carefully.

Moisture condensation occurs, for example, when you pour a cold drink into a glass on a warm day. Drops of water form on the outside of the glass. In the same way, moisture may condense on the optical pick-up lens inside this unit, one of the most crucial internal parts of the DVD video player.

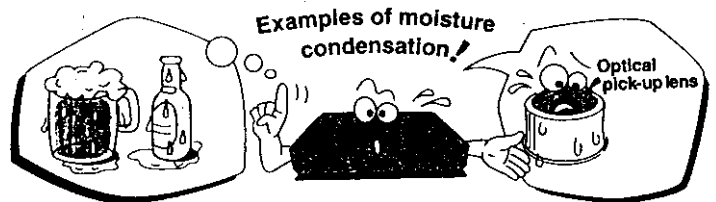

■ **Moisture condensation occurs during the following cases.**

- When you bring the DVD video player directly from a cold place to a warm place.
- When you use the DVD video player in a room where you just turned on the heater, or a place where the cold wind from the air conditioner directly hits the unit.
- In summer, when you use the DVD video player in a hot and humid place just after you move the unit from an air conditioned room.

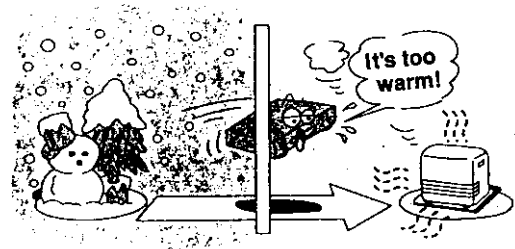

■ **Do not use the DVD video player when moisture condensation may occur.**

If you use the DVD video player in such a situation, it may damage discs and internal parts. Remove the disc, connect the power cord of the DVD video player to the wall outlet, turn on the DVD video player, and leave it for two or three hours. After two or three hours, the DVD video player will have warmed up and evaporated any moisture. Keep the DVD video player connected to the wall outlet and moisture condensation will seldom occur.



Table of Contents

Introduction

- SAFETY PRECAUTIONS 3
- IMPORTANT SAFETY INSTRUCTIONS 4, 5
- Precautions 6
- Identification of Controls 8-11
 - Front Panel / Rear Panel / DVD display
 - Remote Control
 - Preparing the Remote Control
 - Operating with the Remote Control

Introduction

Connections

- Connecting to a TV 12
- Connecting to an Audio System and TV with Color difference Inputs 13
- Connecting to Optional Equipment 14, 15
 - Connecting to an Amplifier Equipped With a Dolby Digital Decoder
 - Connecting to an Amplifier Equipped With 5.1ch Audio Input
 - Connecting to an Amplifier Equipped With a Dolby Pro Logic Surround
 - Connecting to an Amplifier Equipped With a DTS Decoder
 - Connecting to an Amplifier Equipped With an MPEG2 Audio Decoder
 - Connecting to an Amplifier Equipped With a Digital Audio Input

Connections

Basic Playback

- Playing a Disc 16-19
 - Basic Playback
 - Using the Shuttle Ring
 - Using the Jog Dial
 - Resuming Playback from the Same Location
- Locating a Specific Title, Chapter, or Track.. 20, 21
 - Locating a Title Using the Title Menu
 - Locating a Title
 - Locating a Specific Chapter or Track Directly
 - Locating a Specific Chapter or Track

Basic Playback

Advanced Playback

- Playing From the Desired Location 22
 - Locating a Specific Location On the Disc
- Playing Repeatedly 23
 - Repeating a Title, Chapter, or Track
 - Repeating a Specific Segment
- Playing in a Favorite Order 24,25
 - Setting Titles, Chapters, or Tracks in a Favorite Order
- Playing in Random Order 26
 - Playing Titles in Random Order
 - Playing Chapter or Tracks in Random Order
- Zooming a Picture 27
 - Zooming a Picture
- Selecting the Camera Angle 28
 - Changing the Camera Angle
- Selecting a Language 29
 - Selecting a Playback Audio Setting
- Selecting Subtitles 30
 - Turning Subtitles On or Off
 - Selecting a Subtitle Language
- Using the On-Screen Display 31
 - Checking the Operational Status
 - Checking the Remaining Time and Setting Status

Advanced Playback

Function Setup

- Customizing the Settings 32-47
 - Selecting a Setting Category
 - LANGUAGE Setting
 - PICTURE Setting
 - AUDIO Setting
 - DISPLAY Setting
 - OPERATION Setting
- Operating Other Equipment With the Remote Control 48, 49
 - Programming the Remote Control
 - Brand Code Table
 - Buttons to Operate
- Table of Languages 50

Function Setup

Others

- Notes on Discs 51
- Before Calling Service Personnel 52
- Specifications 53
- Factory Service Center Locations 54, 55
- Limited Warranty 56

Others

Identification of Controls

See the page in  for details.

Front Panel / Rear Panel / DVD Display

Front Panel

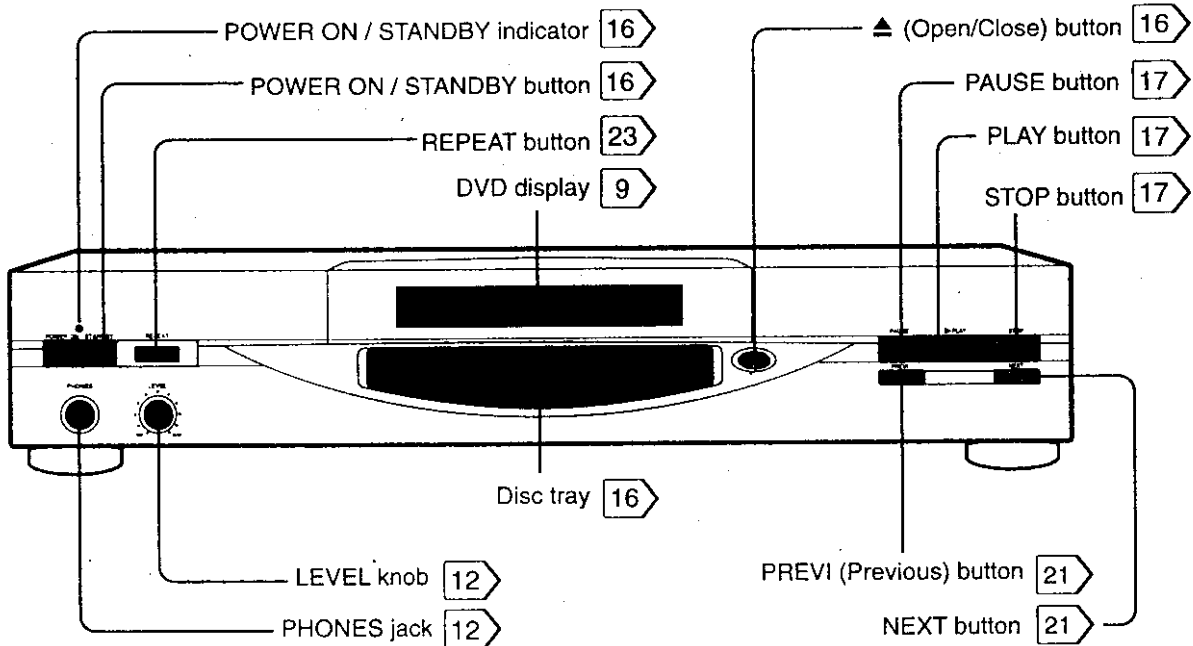

Rear Panel

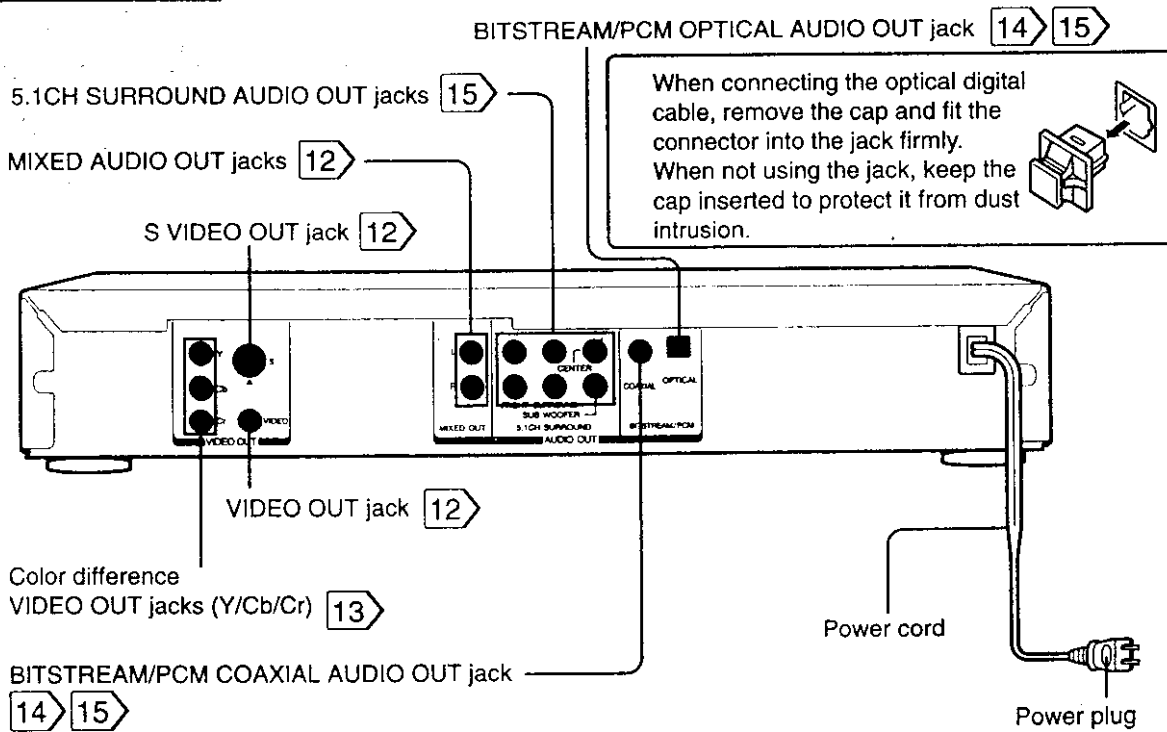

DVD Display

■ Pressing of the FL-DIM button on the remote control changes the brightness of the display.

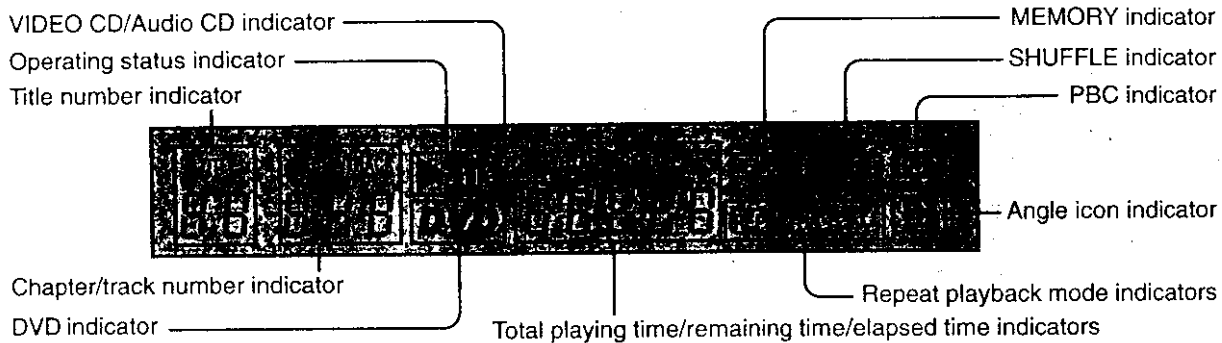
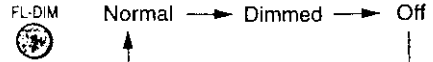

■ The indicators vary depending on the kinds of discs you play.

DVD Video discs

- When closing the disc tray:

Example



Total number of titles

Some DVD video discs may not display the total number of titles.

- During playback:

Example



Playing chapter 3
in title 2
Elapsed time of the current title

Some DVD video discs may not display the chapter numbers or elapsed time.

VIDEO CDs

- When closing the disc tray:

Example



Total number of tracks
Total playing time of the disc
Lights up when using a PBC-controllable VIDEO CD

- During playback:

Example



Playing track 6
Elapsed time of the current track

Some VIDEO CDs may not display the track numbers or elapsed time.

Audio CDs

- When closing the disc tray:

Example



Total number of tracks
Total playing time of the disc

- During playback:

Example



Playing track 6
Elapsed time of the current track

Other indicators

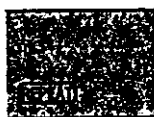

When playing the same title, chapter or track repeatedly. [23]



When playing a specific segment repeatedly. (A-B repeat) [23]



When playing the entire disc repeatedly. [23]

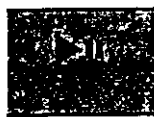

When playback is paused. [17]

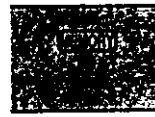

During memory playback. [24]

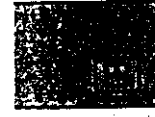

When the camera angle can be changed. [28]



During random playback. [26]

Identification of Controls (continued)

The instructions in this manual describe the functions on the remote control. See the page number inside the  for details.

Remote Control

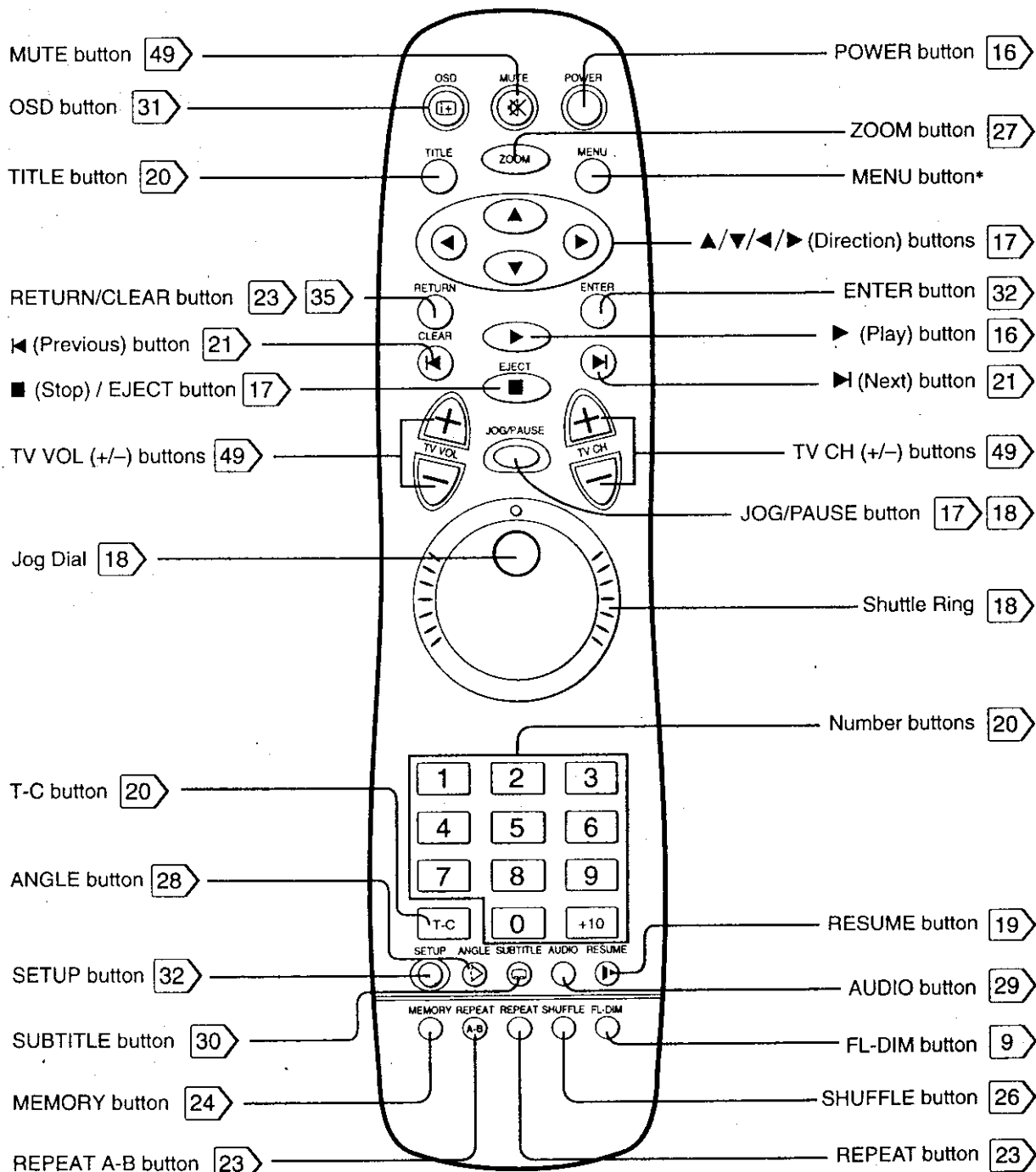

*** MENU button**

Use the MENU button to display the menu screen included on DVD video discs. To operate a menu screen, follow the instructions in "Locating a Title Using the Title Menu."  20

Preparing the Remote Control

Insert the batteries into the remote control so you can use it to operate the DVD video player.

1 Open the cover.

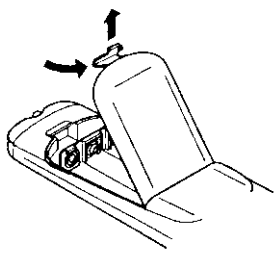

2 Insert batteries (AA size).

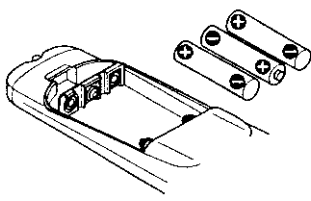

Make sure to match the + and - on the batteries to the marks inside the battery compartment.

3 Close the cover.

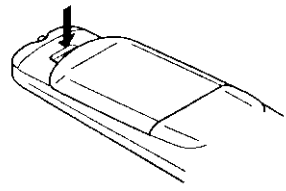

Notes on batteries

Improper use of batteries may cause battery leakage and corrosion. To operate the remote control correctly, follow the instructions below.

- Do not insert batteries into the remote control in the wrong direction.
- Do not charge, heat, open, or short-circuit the batteries. Do not throw batteries into a fire.
- Do not leave dead or exhausted batteries in the remote control.
- Do not use different types of batteries together, or mix old and new batteries.
- If you do not use the remote control for a long period of time, remove the batteries to avoid possible damage from battery corrosion.
- If the remote control does not function correctly or if the operating range becomes reduced, replace all batteries with new ones.
- If battery leakage occurs, wipe the battery liquid from the battery compartment, then insert new batteries.

Operating with the Remote Control

This section shows you how to use the remote control.

Point the remote control at the remote sensor on the DVD video player and press the buttons.

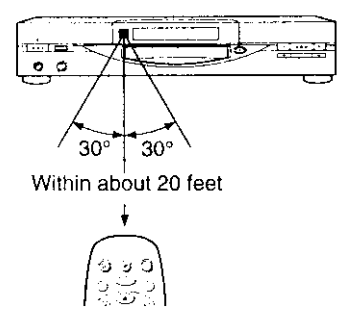

Distance: Within about 20 feet from the front of the remote sensor
 Angle: Within about 30° in each direction of the front of the remote sensor

* Do not expose the remote sensor of the DVD video player to a strong light source such as direct sunlight or illumination. If you do so, you may not be able to operate the DVD video player with the remote control.

Notes on the remote control

- Direct the remote control at the remote sensor of the DVD video player.
- Do not drop or give the remote control a shock.
- Do not leave the remote control near an extremely hot or humid place.
- Do not spill water or put anything wet on the remote control.
- Do not open the remote control.

Built-in Locator of the Remote Control

The remote control lets you know its location by beeping each time the main power is turned on.

- 1 Press the POWER ON / STANDBY button on the front panel of the DVD video player to turn the DVD video player on.
 The remote control beeps so that you can easily locate it. The remote control should be within about 20 feet from the DVD video player, not being obstructed.
- 2 To turn off the beep, press any button on the remote control.
 - Re-execution requires an interval of about thirty seconds.
 - The built-in locator may not work depending on the condition. (ex. obstructions, direction of the remote control,

Connections

For details of output sound, see [29](#).

Connecting to a TV

Connect the DVD video player to your TV.

Connecting to a TV

■ Selecting the output sound

From the on-screen displays, set the "Audio Out Select" to "Analog 2ch." [32](#) [38](#)

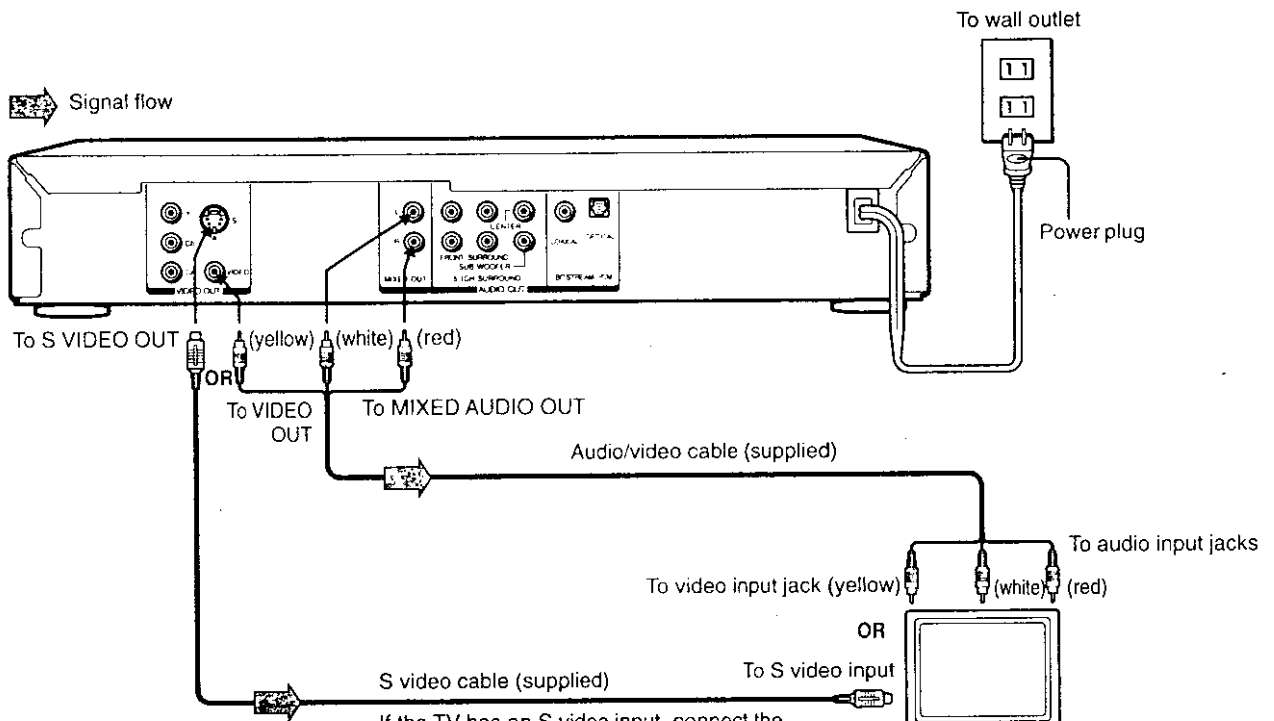

If your TV has an RF (Antenna In) jack only, use an RF modulator (not supplied) to connect the DVD player to your TV.

If the TV has an S video input, connect the DVD video player to the TV using the supplied S video cable. When using the S video cable, there is no need to connect the yellow video cable.

TV or monitor with audio/video input jacks

- Set your TV to accept Auxiliary (Line) input. See your TV owner's manual for details.

Notes

- Refer to the owner's manual of the connected TV as well.
- When you connect the DVD video player to your TV, be sure to turn off the power and unplug both units from the wall outlet before making any connections.
- If your television set has one audio input jack, use a Y cable adapter (not supplied) to connect to your TV.
- Connect the DVD video player directly to your TV. If you connect the DVD video player to a VCR, TV/VCR combination or video selector, the playback picture may be distorted as DVD video discs are copy protected.

Connecting headphones

Connect headphones to the PHONES jack on the front panel using a stereo plug.

Before connecting, temporarily turn down the volume with the LEVEL volume control. Readjust to your preference when playback begins.

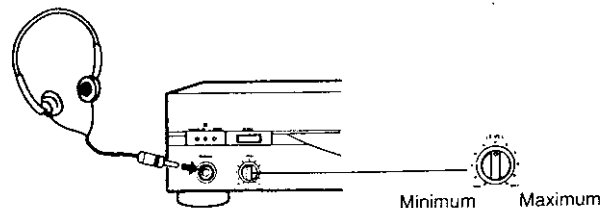

Connecting to an Audio System and TV with Color Difference Inputs

You can listen to the sound of discs in stereo and enjoy the enhanced picture quality of discs on a TV equipped with color difference inputs.

Connecting to an Audio System and TV with Color Difference Inputs

Selecting the output sound

From the on-screen displays, set the "Audio Out Select" to "Analog 2ch." 32 38

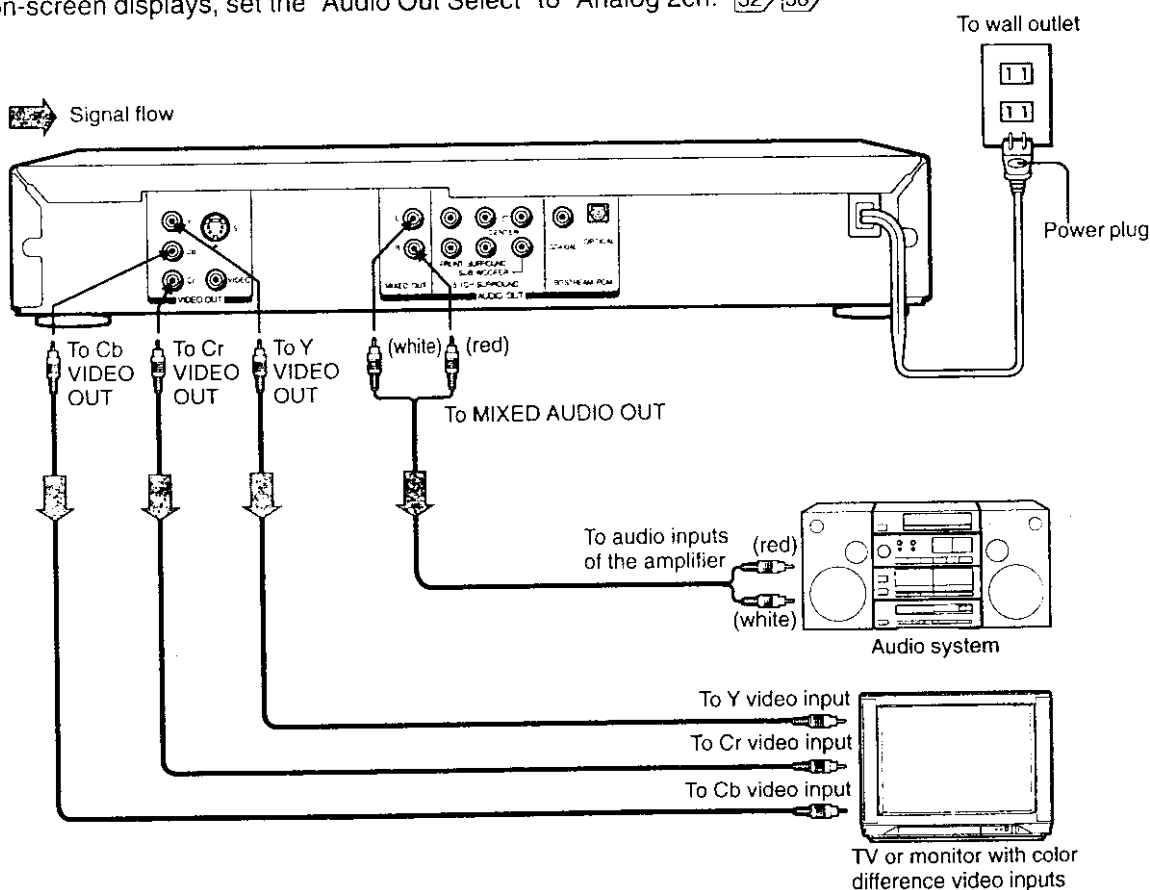

Color difference outputs/inputs

Some TVs or monitors are equipped with color difference inputs. Connecting to these inputs allows you to enjoy higher quality picture playback.

Actual labels for color difference inputs may vary depending on the TV manufacturer. (ex. Y, R-Y, B-Y or "Component video")

In some TVs or monitors, the color levels of the playback picture may be reduced slightly or the tint may change. In such a case, adjust the TV or monitor for optimum performance.

Notes

- Refer to the owner's manual of the connected equipment (TV, audio system) as well.
- When you connect the DVD video player to other equipment, be sure to turn off the power and unplug all of the equipment from the wall outlet before making any connections.
- If you place the DVD video player near a tuner or radio, the radio broadcast sound might be distorted. In this case, place the DVD video player away from the tuner and radio.
- The output sound of the DVD video player has a wide dynamic range. Be sure to adjust the receiver's volume to a moderate listening level. Otherwise, the speakers may be damaged by a sudden high volume sound.
- Turn off the amplifier before you connect or disconnect the DVD video player's power cord. If you leave the amplifier power on, the

Connections

For details of output sound, see [29](#).

Connecting to Optional Equipment

You can enjoy high quality dynamic sounds by connecting the DVD video player to optional audio equipment.

For connection to your TV, see pages 12 and 13.

Select the connection type depending on your audio equipment.

	: Front speaker		: Center speaker
	: Rear speaker		: Signal flow
	: Sub woofer		

Connecting to an Amplifier Equipped With a Dolby Digital Decoder

Dolby Digital

Dolby Digital is the surround sound technology used in theaters showing the latest movies, and is now available to reproduce this realistic effect in the home. You can enjoy motion picture and live concert DVD video discs with this dynamic realistic sound by connecting the DVD video player to a 6 channel amplifier equipped with a Dolby Digital decoder or Dolby Digital processor. If you have a Dolby Pro Logic Surround decoder, you will obtain the full benefit of Pro Logic from the same DVD movies that provide full 5.1-channel Dolby Digital soundtracks, as well as from titles with the Dolby Surround mark.

Manufactured under license from Dolby Laboratories Licensing Corporation. "Dolby," "AC-3," "Pro Logic," and the double-D symbol are trademarks of Dolby Laboratories Licensing Corporation.

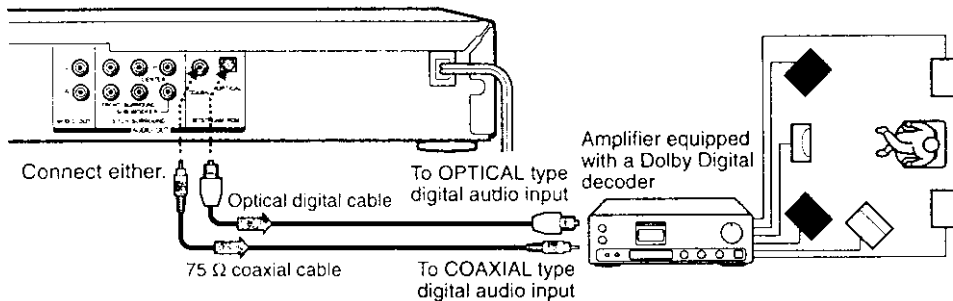

- Use DVD video discs encoded via the Dolby Digital recording system.
- Make the following setting.

Setting	Select:	Page
Audio Out Select	Bitstream	38
Recording system		29

Connecting to an Amplifier Equipped With 5.1ch Audio Inputs

5.1ch surround sound

The Dolby Digital decoder equipped with this DVD video player enables you to obtain the full benefit of 5.1 channel Dolby Digital sound tracks when you connect the DVD video player to a Dolby Digital ready amplifier equipped with 5.1 channel audio inputs. Dolby Pro Logic Surround sound can be obtained also if its recording system is selected.

- Use DVD video discs recorded on the Dolby Digital recording system.
- Make the following setting.

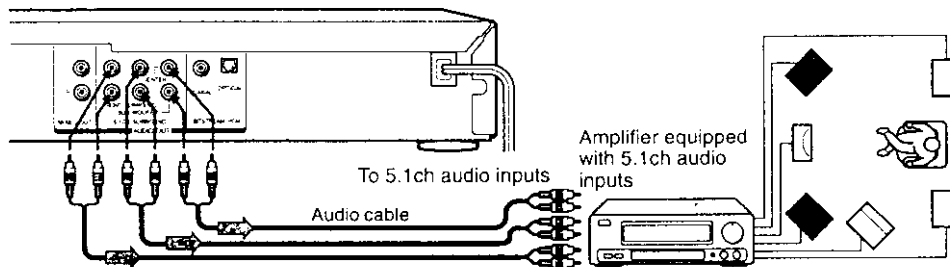

Setting	Select:	Page
Audio Out Select	Analog 6ch	38
Recording system		29

Connecting to an Amplifier Equipped With Dolby Pro Logic Surround

Dolby Pro Logic Surround

You can enjoy Dolby Pro Logic Surround Sound by connecting an amplifier and speaker system (right and left front speakers, a center speaker, and one or two rear speakers).

- **With an amplifier equipped with Dolby Digital,**
Connect the equipment the same way as described in "Connecting to an Amplifier Equipped With a Dolby Digital Decoder." Refer to that amplifier's owner's manual and set the amplifier so you can enjoy Dolby Pro Logic Surround sound.
- **With an amplifier not equipped with Dolby Digital,**
Connect the equipment as follows.

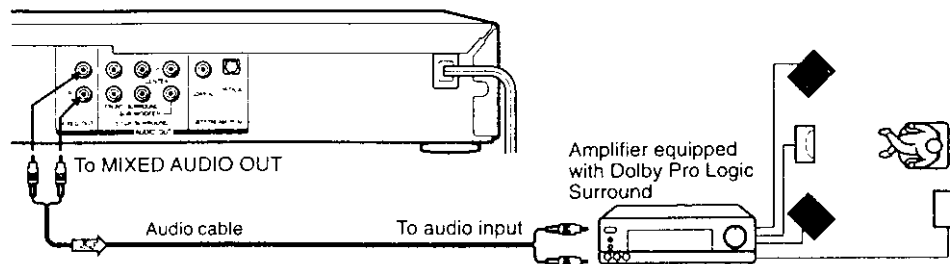

- Make the following setting.

Setting	Select:	Page
Audio Out Select	Analog 2ch	38

Connect one or two rear speakers.
The output sound from the rear speakers will be monaural even if you connect two rear speakers.

Warning

- Do not set "Audio Out Select" to "Bitstream" from the menu **[32]** **[38]** unless you are connecting (via the BITSTREAM/PCM AUDIO OUT jack) an AV decoder that has the Dolby Digital, Digital Theater Systems (DTS) or MPEG2 decoding function. High volume sound may damage your hearing as well as the speakers.
- When playing DTS-encoded discs (DVD video discs and audio CDs), excessive noise may be output from the analog stereo jacks. To avoid possible damage to the audio system, you should take proper precautions when the MIXED AUDIO OUT jacks of the DVD video player is connected to an amplification system. To enjoy DTS Digital Surround™ playback, an external 5.1 channel DTS Digital Surround™ decoder system must be connected to the BITSTREAM/PCM AUDIO OUT jack of the DVD video player.

Connecting to an Amplifier Equipped With a DTS Decoder

Digital Theater Systems (DTS)

DTS is a high quality surround technology used in theaters and now available for home use, on DVD video discs or audio CDs. If you have a DTS decoder or processor, you can obtain the full benefit of 5.1 channel DTS encoded audio tracks on DVD video discs or audio CDs.

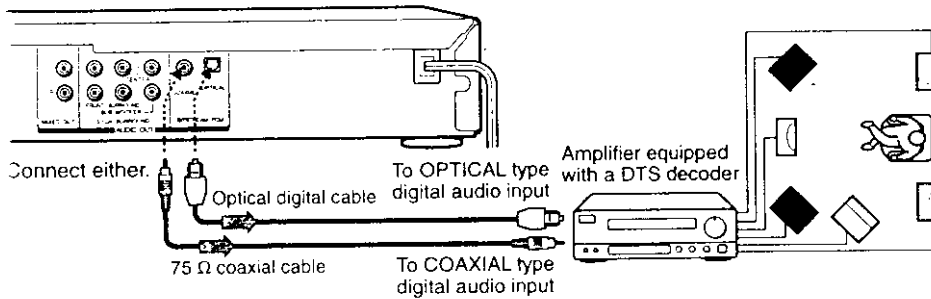

"DTS" and "DTS Digital Surround" are trademarks of Digital Theater Systems, Inc.

- Use DVD video discs or audio CDs encoded via the DTS recording system.
- Make the following setting.

Setting	Select:	Page
Audio Out Select	Bitstream	[38]
Recording system	DTS	[29]

Connecting to an Amplifier Equipped With an MPEG 2 Audio Decoder

MPEG 2 sound

You can enjoy motion picture and live concert DVD video discs with dynamic realistic sound by connecting an amplifier equipped with an MPEG 2 audio decoder or MPEG 2 audio processor.

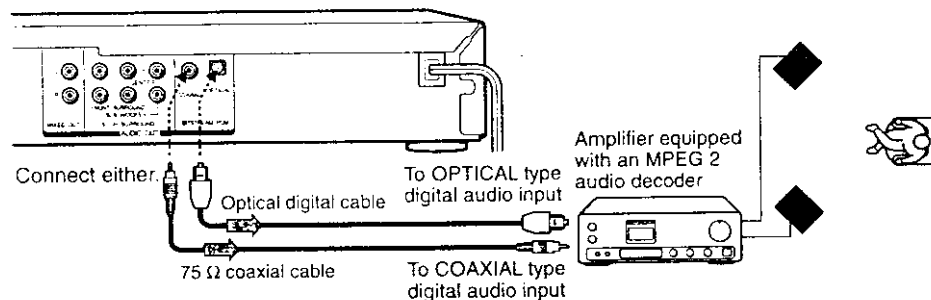

- Make the following setting.

Setting	Select:	Page
Audio Out Select	Bitstream	[38]
Recording system	MPEG	[29]

Connecting to an Amplifier Equipped With a Digital Audio Input

Two-Channel Digital Stereo

You can enjoy Two-Channel Digital Stereo Sound by connecting an amplifier equipped with a digital audio input and speaker system (right and left front speakers).

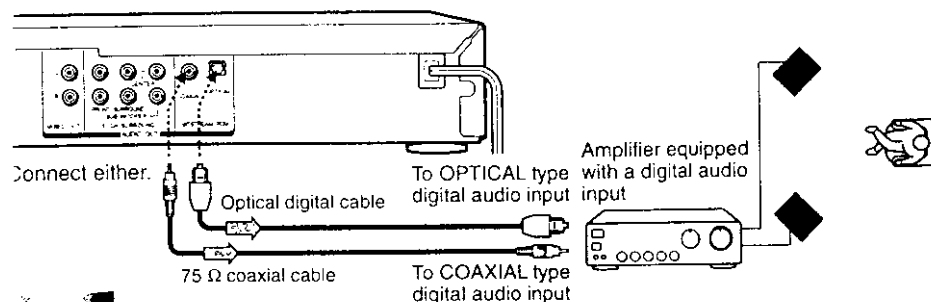

- Make the following setting.

Setting	Select:	Page
Audio Out Select	PCM	[38]

Notes

DO NOT connect the BITSTREAM/PCM AUDIO OUT jack of the DVD video player to the AC-3 RF input of a Dolby Digital Receiver. This input on your A/V Receiver is reserved for Laserdisc use only and is incompatible with the BITSTREAM/PCM AUDIO OUT jack of the DVD video player. Connect the BITSTREAM/PCM AUDIO OUT jack of the DVD video player to the "DIGITAL" or "COAXIAL" input of a Receiver or Processor. Refer to the owner's manual of the connected equipment as well. When you connect the DVD video player to other equipment, be sure to turn off the power and unplug all of the equipment from the wall outlet before making any connections. The output sound of the DVD video player has a wide dynamic range. Be sure to adjust the receiver's volume to a moderate listening level. Otherwise, the speakers may be damaged by a sudden high volume sound. Turn off the amplifier before you connect or disconnect the DVD video player's power cord. If you leave the amplifier power on, the speakers may be damaged.

Basic Playback

Playing a Disc

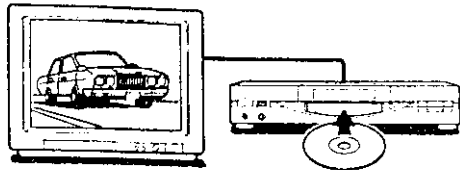

This section shows you how to play a disc.

CAUTION



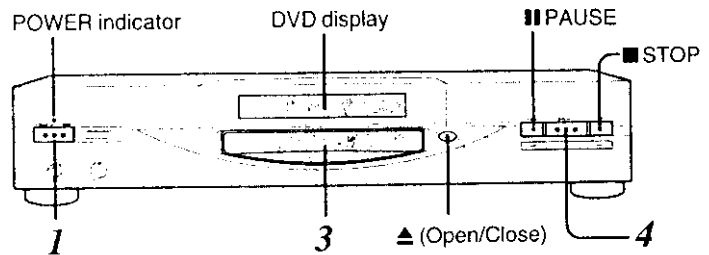

Keep your fingers well clear of the disc tray as it is closing. It may cause serious personal injury.



Basic Playback

Preparations

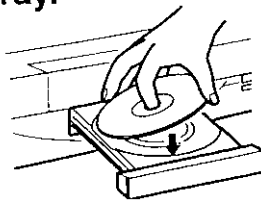
- When you want to view a disc, turn on the TV and put the TV in Auxiliary (Line) input mode.
- When you want to enjoy the sound of discs from the audio system, turn on the audio system and set the amplifier to receive Auxiliary input
- For connection details, see "Connections." [12] - [15]

<p>1</p> 	<p>Press POWER.</p> <p>The DVD video player turns on and the POWER indicator on the player illuminates.</p> <p>When the DVD video player is turned on for the first time, an initial set-up menu screen appears. See below to make the settings before proceeding to step 2.</p>	<p>Note</p> <p>If you hear a beep by the remote control's locator, press any button on the remote control to turn it off. [11]</p>
<p>2</p> 	<p>Press ▲ on the front panel (or hold down ■/EJECT on the remote control for longer than one second).</p> <p>The disc tray opens.</p>	
<p>3</p>	<p>Place the disc on the disc tray.</p>  <p>With the label facing up</p>	<p>Notes</p> <ul style="list-style-type: none"> • There are two different disc sizes. Place the disc in the correct guide on the disc tray. If the disc is out of the guide, it may damage the disc and cause the DVD video player to malfunction. • Do not place anything except DVD video discs, VIDEO CDs, or audio CDs on the disc tray.
<p>4</p> 	<p>Press PLAY (▶).</p> <p>The disc tray closes and playback starts.</p> <p>If you insert a DVD video disc that contains a title menu, or insert a PBC (Playback Control)-equipped VIDEO CD, a menu screen may appear. See "To start playback from the menu screen." [17]</p> <p>To start playback of a PBC-equipped VIDEO CD from the menu screen, set "PBC" to "On" via the on-screen displays. [32] [46]</p>	<p>Notes</p> <ul style="list-style-type: none"> • For PBC (Playback Control) of VIDEO CDs, see "On VIDEO CD." [51] • You may need to press the TITLE or MENU button on the remote control to display the disc menu screen (depending on the actual DVD video discs.)

First Setup screen

From this screen, make the following settings.

On-screen Language: Select the appropriate on-screen language.

TV Shape: Select a picture size according to the aspect ratio of your TV. (See [36] for details.)

Thank you for your purchase of DVD Video Player. Please make a selection for On-Screen Language and your TV shape and press ENTER button on your remote control

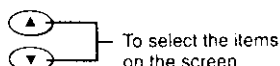

- 1 Press the ▲ / ▼ buttons to select "On-Screen Language," and press the ENTER button.
The languages are listed.
- 2 Select a language using the ▲ / ▼ buttons, and press the ENTER button.
- 3 Press the ▼ button to select "TV Shape," and press the ENTER button.
- 4 Select a picture size (see [36]) using the ▲ / ▼ buttons, and press the ENTER button.
- 5 Finally press the SETUP button.
All your selections are entered and the First Setup screen disappears.

To change your settings, see "Customizing the Function Settings." [32]

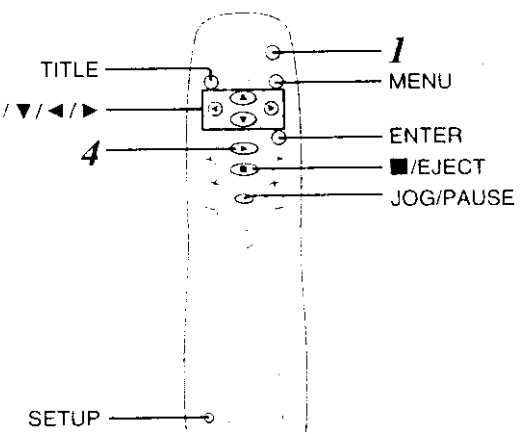

■ **To obtain a higher quality picture**
Occasionally, some picture noise may appear on the TV screen while playing a DVD video disc because the high resolution pictures on these discs include a lot of information. While the amount of noise depends on the TV you use with this DVD video player, you should generally reduce the sharpness adjustment on your TV when viewing DVD video discs.

■ **About**
The icons on the heading bar show the playable discs for the function described under that heading.
 : You can use this function with DVD video discs.
 : You can use this function with VIDEO CDs.
 : You can use this function with audio CDs.

To start playback from the menu screen

1 Press / / / or the number buttons to select the title you want.

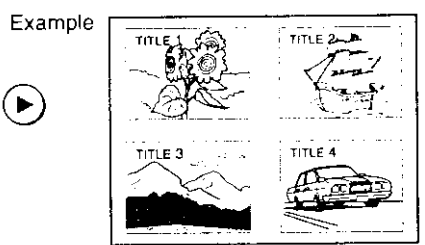

2 Press ENTER.



The DVD video player begins playback from the selected title.

- When not using the menu screen of a PBC-featured VIDEO CD, set "PBC" to "Off" via the on-screen displays.

To pause playback (still playback)



Press **JOG/PAUSE** during playback.
To resume normal playback, press the **PLAY** () button.

- The sound is muted during still playback.

To stop playback



Press **/EJECT**.

To remove the disc



Hold down **/EJECT** (for longer than one second) until the disc tray opens.

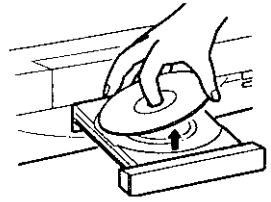

Remove the disc after the disc tray opens completely.

- Be sure to hold down the **/EJECT** button for longer than one second to close the disc tray after you remove the disc.

Notes

- Do not move the DVD video player during playback. Doing so may damage the disc.
- Use the **/EJECT** button on the remote control or DVD video player to open and close the disc tray. Do not push the disc tray while it is moving. Doing so may cause the DVD video player to malfunction.
- Do not push up on the disc tray or put any objects other than discs on the disc tray. Doing so may cause the DVD video player to malfunction.
- In many instances, a menu screen will appear after playback of a movie is completed. Prolonged display of an on-screen menu may damage your television set, permanently etching that image onto its screen. To avoid this, be sure to press the **/EJECT** button on your remote control once the movie is completed.
- If you pause a picture and leave it still for a long while, the screen saver of the DVD video player automatically appears (when "Screen Saver" is set to "On"). To turn off the screen saver, press the **PLAY** button.

About This Owner's Manual

This owner's manual explains the basic instructions of this DVD video player. Some DVD video discs are produced in a manner that allows specific or limited operation during playback. As such, the DVD video player may not respond to all operating commands. This is not a defect in the DVD video player. Refer to the instruction notes of discs.

"" may appear on the TV screen during operation. A "" means that the operation is not permitted by the DVD video player or the disc.

Basic Playback

Basic Playback

Playing a Disc (continued)



You can play discs at various speeds, and resume playback from the location where you stopped playback.

DVD VCD CD

Using the Shuttle Ring

You can play discs at various speeds by turning the shuttle ring.

1



Press and hold **JOG/PAUSE** during playback.

The **JOG/PAUSE** button lights and the playback pauses.

2

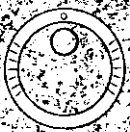

Turn the shuttle ring.

The playback speed can be controlled by the extent of the wheel rotation.

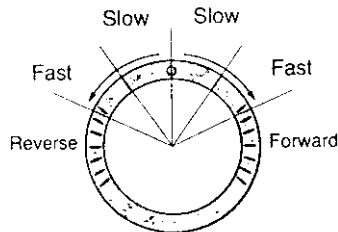

To finish operating the shuttle ring



Press **JOG/PAUSE** again to turn it off.

Notes

- The playback speed may differ depending on the disc.
- If you slow down the playback speed of a DVD video disc by turning the ring leftward, the DVD video player performs reverse frame playback. The reverse frame playback may advance more rapidly than in the forward direction.

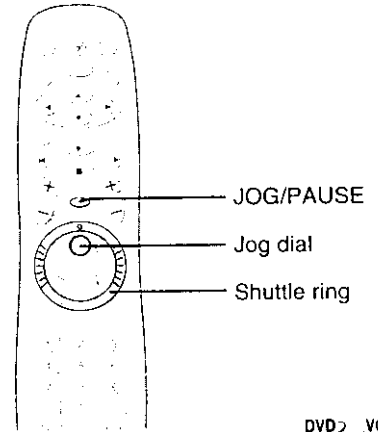

DVD VCD

Using the Jog Dial

You can advance or reverse a picture frame by frame from the jog dial.

1



During playback, press **JOG/PAUSE** on the remote control.

The picture pauses.

2

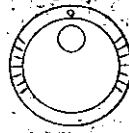

Turn the jog dial.

Prolonged absence of operation may automatically cancel this function. If it occurs, start over again from step 1.

Rightward: To advance the picture frame by frame.

Leftward: To reverse the picture frame by frame. (Only when using a DVD video disc.)

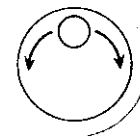

To finish operating the jog dial



Press **JOG/PAUSE** again to turn it off.

Notes

- The sound is muted during frame by frame playback.
- The reverse frame playback may advance more rapidly than in the forward direction.

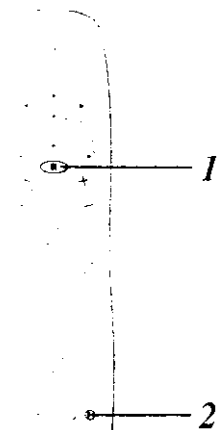

DVD VCD CD

Resuming Playback from the Same Location

You can stop playback and resume playback later from the same location on the disc.

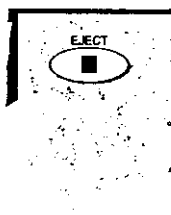

Press **■**/EJECT at the location where you want to interrupt playback.

The DVD video player memorizes the location where playback is stopped.



Press **▶** RESUME.

The DVD video player resumes playback from the location where you stopped playback.

To start playback from the beginning regardless of the location where you stopped playback

1 Press **■**/EJECT twice.



The DVD video player's memory is cleared.

2 Press **▶** RESUME.

RESUME



If you are using a DVD video disc, playback starts from the beginning of the current title.

If you are using a VIDEO CD/audio CD, playback starts from the beginning of the disc.

- If you want to return to the beginning of a DVD video disc, open and close the disc tray once with the **▲** button before pressing the **▶** button.

Notes

The DVD video player's memory is also cleared when:

- you unplug the DVD video player from the wall outlet after you stop playback.
- you open the disc tray.
- you adjust/change parental lock [44] or select a disc menu language setting [34].

There may be a difference in the location where playback resumes depending on the disc.

Settings you changed using the menu screens while the DVD video player keeps a location in the memory may function only after the memory is cleared.

Locating a Specific Title, Chapter, or Track

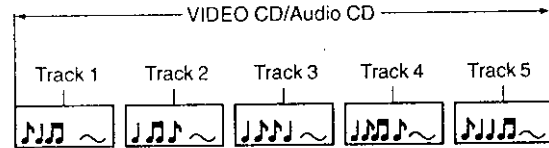
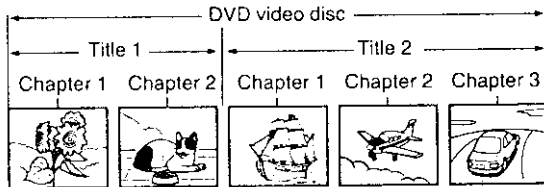

Normally, DVD video discs are divided into titles, and the titles are sub-divided into chapters. VIDEO CDs and audio CDs are divided into tracks. You can quickly locate any specific title, chapter, or track.

Locating a Title Using the Title Menu DVD

If a DVD video disc contains a title menu, you can locate a specific title using the title menu.



Press TITLE.

The title menu appears on the TV screen.

Example of a title menu

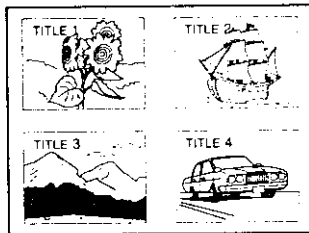

Press ▲/▼/◀/▶ to select the title you want.

If the titles in the title menu are assigned a number, you can directly locate a specific title by choosing its assigned number with the **number buttons**.



Press ENTER.

The DVD video player starts playback from chapter 1 of the selected title.

(You may not need to press ENTER if you use the number buttons at step 2.)

Notes

- The instructions above describe the basic procedure. The procedure varies depending on the contents of the DVD video disc. If different instructions appear on the TV screen, follow those instructions.
- If you display the title menu during playback and press the TITLE button again without selecting any title, the DVD video player may resume playback from the point where you first pressed the TITLE button. If it does not, press ▶ to resume playback.

Locating a Title DVD

You can locate a specific title by entering a title number.

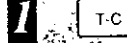

Press T-C.

Make sure that the space next to Title is highlighted.

Example

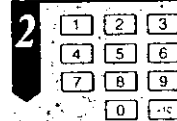
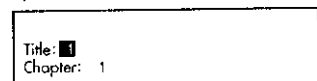

Press the corresponding number buttons for the title you want.

Example: To select title 2, press

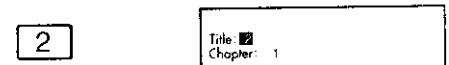

To select title 12, press

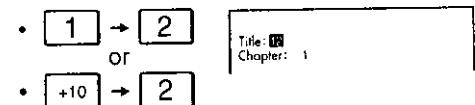

Press ▶.

The DVD video player starts playback from chapter 1 of the selected title.

Notes

- Some DVD video discs may have chapters, but no titles.
- You can shift the highlight between Title and Chapter by pressing the ▲/▼ buttons.
- To clear the "Title" and "Chapter" display, press the T-C button repeatedly.
- You can select a preferred language for on-screen displays. 32 34

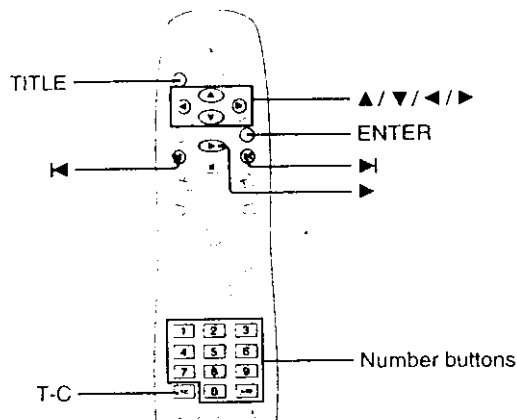

Locating a Specific Chapter or Track Directly

you know the chapter or track number you want to play, you can locate it directly.

- 1 Press T-C.**

Skip steps 1 and 2 if you are using a VIDEO CD/audio CD.

(DVD video disc)

Title: 1
Chapter: 1
- 2 Press ▼ to highlight the space next to Chapter.**

(DVD video disc)

Title: 1
Chapter: █
- 3 Press the corresponding number buttons of the chapter or track you want.**

You can use the **10** button to select numbers from 10 through 99.

Example: To select chapter or track 25

(DVD video disc) (VIDEO CD/ Audio CD)

 - **2** → **5**
 - OR
 - **10** → **10** → **5**

Title: 1
Chapter: █
Track: █
- 4 Press ►.**

The DVD video player starts playback from the selected chapter or track.

Locating a Specific Chapter or Track

You can fast forward or reverse through consecutive chapters or tracks.

Press ◀ or ▶ repeatedly to display the chapter or track number you want.

The DVD video player starts playback from the selected chapter or track.

- ◀: To locate preceding chapters or tracks
When you press the ◀ button, the DVD video player starts playback from the beginning of the current chapter or track.
When you press the ◀ button twice, the DVD video player starts playback from the beginning of the preceding chapter or track.
- ▶: To locate succeeding chapters or tracks

If you press and hold the ◀ or ▶ button during playback, the DVD video player performs fast reverse or fast forward playback. You can select the speed by pressing the button further.

To locate chapters or track during fast reverse or fast forward playback, first press the ▶ button to resume normal playback, and then use the ◀ or ▶ button.

Basic Playback

To select a title and chapter number at the same time

Example: To select chapter 25 in title 2

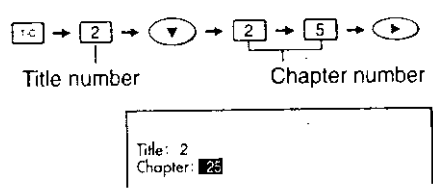

Note

To clear the "Title" and "Chapter" display, press the T-C button

Notes

- Some titles may not display chapter numbers.
- When you set "Title Stop" to "Off" **46**, you can access chapters in another title. If you go back to the preceding title by pressing the ◀ button, the DVD video player locates the first chapter of the title. When "Title Stop" is set to "On," you can access chapters only within the current title.

Advanced Playback

Playing From the Desired Location

You can play a disc from the desired location.

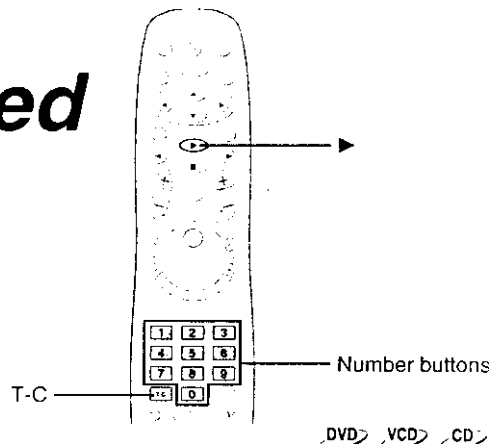

Locating a Specific Location On the Disc

You can locate a specific location by entering its corresponding time (hours, minutes, seconds).

1  **Press T-C twice.**
You may have to press further depending on the disc. Press the button repeatedly until the following indication appears.

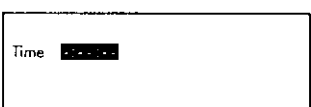

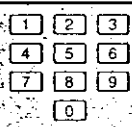
2  **Press the number buttons to enter the time.**
Example
1 → 2 → 5 → 3 → 0
(one hour, 25 minutes, 30 seconds)

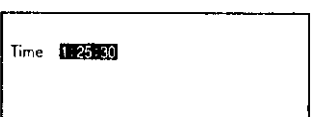

3  **Press ►.**
The DVD video player starts playback from the desired location.

Notes

- Some discs may not respond to this feature.
- Some scenes may not be located precisely as you specified.
- This locating is available only within the current title of the DVD video disc or within the current track of the VIDEO CD/audio CD.

Advanced Playback

Playing Repeatedly

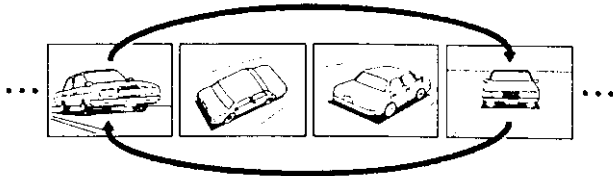

You can play a specific title, chapter, track, or segment repeatedly. (Title repeat, chapter/track repeat, A-B repeat)

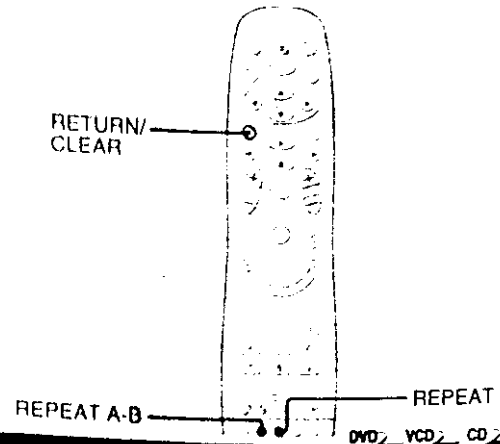

Repeating a Title, Chapter, or Track

You can play the same title, chapter, or track repeatedly. (Title, chapter/track repeat)

Begin playback of the title, chapter, or track you want to repeat. [20] [21]



Press REPEAT.

Each time you press the REPEAT button, the repeat mode changes as follows.

• DVD video disc

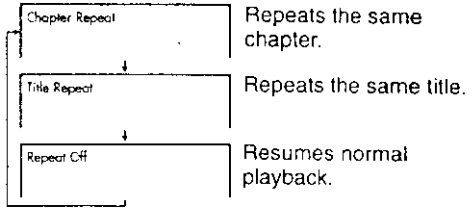

• VIDEO CD/audio CD

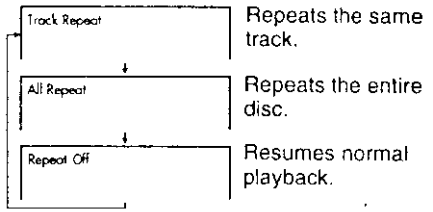

Repeating a Specific Segment

You can play a specific segment repeatedly. (A-B repeat)

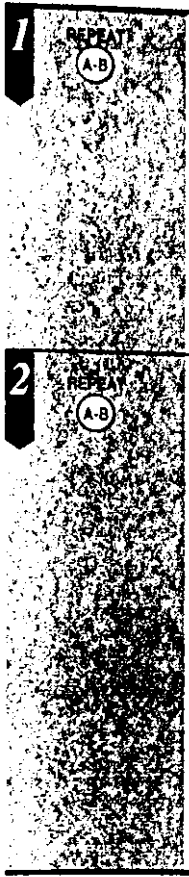

1 During playback, press REPEAT A-B at the beginning of the segment (point A) you want to play repeatedly.

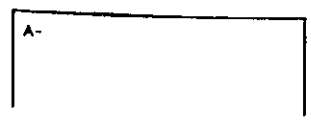

2 Press REPEAT A-B again at the end of the segment (point B).

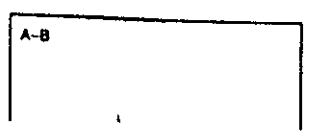

The DVD video player automatically returns to point A and starts repeat playback of the selected segment (A-B).

To resume normal playback



Hold down RETURN/CLEAR for longer than one second.

Note

Some discs may not respond to the repeat function.

To resume normal playback



Hold down RETURN/CLEAR for longer than one second.

Notes

- Some discs may not respond to the A-B repeat function.
- You cannot set the A-B repeat function for a segment that includes multiple camera angles.
- You can specify a segment only within the current title.
- There may be a slight difference between point A and the location

Advanced Playback

Advanced Playback

Playing in a Favorite Order

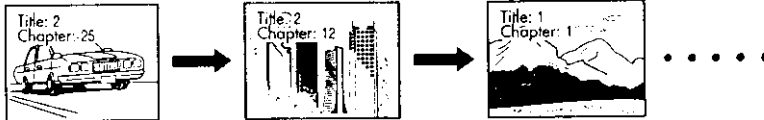

You can combine your favorite titles, chapters, or tracks and play them in any order. You can program up to 28 selections into the memory. (Memory playback)

Setting Titles, Chapters, or Tracks in a Favorite Order

The DVD video player automatically plays titles, chapters, or tracks in the order you program.

1 **MEMORY**

Insert a disc and press **MEMORY** during stop.

The following menu appears.

T	C	T	C	T	C
1	8	9	10	11	12
2	13	14	15	16	17
3	18	19	20	21	22
4	23	24	25	26	27
5	28				

T: Title number C: Chapter number

To select another chapter in the same title, you do not need to select the title number.

2

Select the items in the order you want by pressing the number buttons, then **ENTER** for each item.

Each time you press the ◀/▶ button, the — indication next to T and C is highlighted in turn. Highlight where you want to enter, then press the number buttons.

3 **▶**

Press **▶** while the **MEMORY** menu appears on the TV screen.

The DVD video player starts memory playback.

Example To play chapter 25 in title 2, chapter 12 in title 2, all the chapters in title 1, and chapter 2 in title 4.

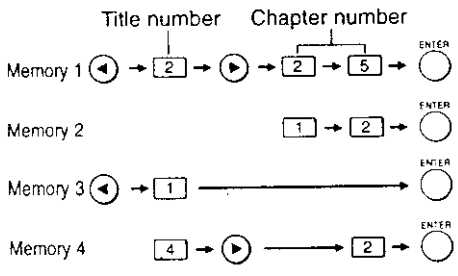

To select tracks from a VIDEO CD/audio CD in order, press the **number buttons** for the track, then press the **ENTER** button for each selection you want.

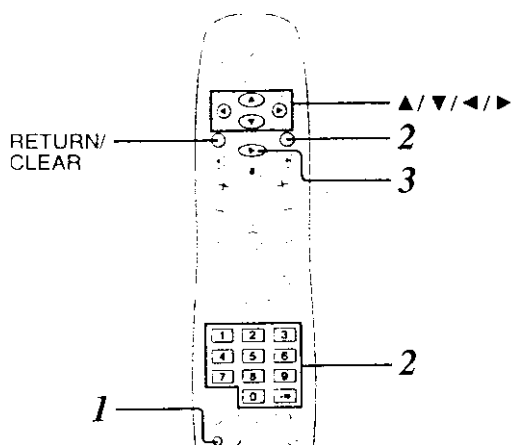

DVD VCD CD

To change the programmed selections

- 1 While the MEMORY menu appears on the TV screen, press ▲ / ▼ to move the highlighted bar to the item you want to change.
- 2 Change the selection following the instructions in step 2.

To cancel the programmed selections

- 1 While the MEMORY menu appears on the TV screen, press ▲ / ▼ to move the highlighted bar to the item you want to cancel.
- 2 Hold down the RETURN/CLEAR button for longer than one second.

To resume normal playback from memory playback



Hold down the RETURN/CLEAR button for longer than one second.

The MEMORY indicator disappears.

To program during playback

If you press the MEMORY button during playback, a menu appears to accept your programming.

If you further press the OSD button, you can display the MEMORY menu also. Follow steps 2 and 3.

Notes

- Some discs may not respond to the memory playback function.
- If you press the REPEAT button during memory playback, the DVD video player repeats the current memory playback.
- You cannot select title, chapter, and track numbers not included on the disc.
- If you press the MEMORY button while the MEMORY menu appears on the TV screen, the MEMORY menu disappears.
- The programmed selections will be cleared when:
 - you turn off the DVD video player, or

Advanced Playback

Playing in Random Order



You can play titles, chapters within a title, or tracks in random order. (Random playback)

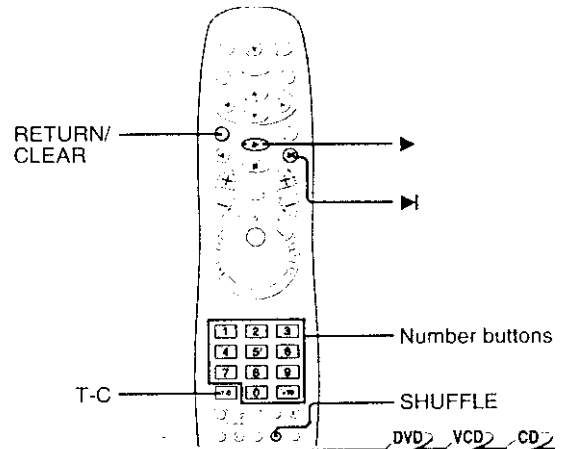

Playing Titles in Random Order

The DVD video player automatically selects the titles in a DVD video disc and plays them randomly.

1 **SHUFFLE**

Press SHUFFLE twice while playback is stopped.

Title Shuffle

If you press the SHUFFLE button during playback, the DVD video player automatically starts random playback after finishing the current title.

2

Press ►.

The DVD video player starts random playback.

Press the ► button within about 5 seconds after you press the SHUFFLE button.

To resume normal playback

Hold down RETURN/CLEAR for longer than one second.

Notes

- Some discs may not respond to the random playback function.
- You cannot use the random playback function in conjunction with the memory playback function.

Playing Chapters or Tracks in Random Order

The DVD video player automatically selects chapters within a title, or tracks in a VIDEO CD/audio CD, and plays them randomly.

1 **T-C**

Press T-C, then press the appropriate number buttons for the title which contains the chapters you want to play in random order.

Skip this step if you are using a VIDEO CD/ audio CD.

Example: To play the chapters in title 2 in random order, press

T-C

→

2

Title: 2
Chapter: 1

2 **SHUFFLE**

Press SHUFFLE while playback is stopped.

(DVD video disc)
Chapter Shuffle
Title: 2
Chapter: 1

(VIDEO CD/audio CD)
Track Shuffle
Track: 1

If you press the SHUFFLE button during playback, the DVD video player automatically starts random playback after finishing the current chapter or track.

3

Press ►.

The DVD video player starts random playback.

Press the ► button within about five seconds after you press the SHUFFLE button.

To resume normal playback

Hold down RETURN/CLEAR for longer than one second.

Notes

- Some discs may not respond to the random playback function.
- You cannot use the random playback function in conjunction with the memory playback function.

Advanced Playback

Zooming a Picture

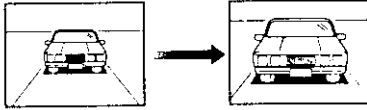

You can magnify areas within a picture.

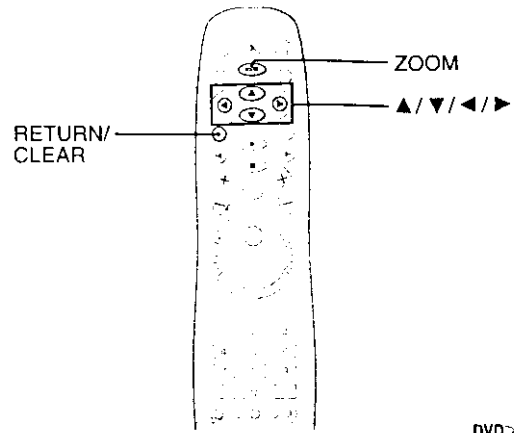

DVD

Zooming a Picture

You can zoom in on a picture and shift the zooming point as well.

Press **ZOOM** during normal, slow or still playback.

If you further press the **ZOOM** button repeatedly, the magnification level increases.

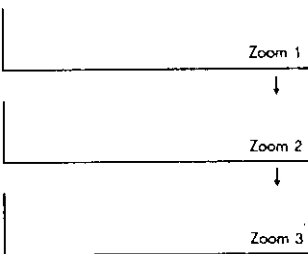

To reduce the magnification level, press the **RETURN/CLEAR** button.

If you press the **▲ / ▼ / ◀ / ▶** buttons, the zoom point shifts. When the zoom point reaches an edge of the picture, the color of "Zoom" changes.

If you hold down the **RETURN/CLEAR** button for longer than one second, the zoom point returns to the center of the picture after reduction of the magnification level.

To resume normal playback

Press **ZOOM** repeatedly so that "Zoom" disappears.

Notes

- Some discs may not respond to zoom function.
- During some scenes, the buttons may not work as described above.
- Zooming does not work on subtitles or menu screens included on DVD video discs.
- During zoom playback, the **▲ / ▼ / ◀ / ▶** buttons cannot work on menu screens included on the DVD video discs. If you want to view the menu screens, cancel the zoom playback.
- The magnification level varies depending on the picture size you select. **32** **36**

Advanced Playback

Selecting the Camera Angle

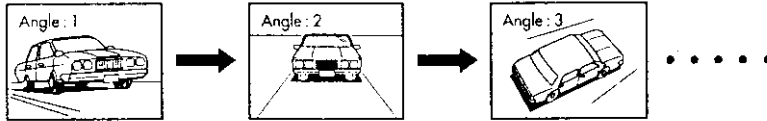

A preferred angle can be selected from several angles.

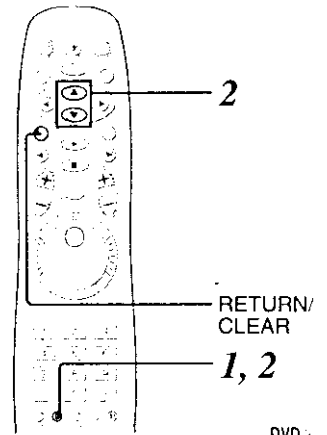

DVD

Changing the Camera Angle

If the scene was recorded from multiple angles, you can easily change the camera angle of the scene you are watching.



Press ANGLE while playing a scene recorded with multiple angles.

While playing a scene recorded with multiple angles, the angle icon (📷) appears in the DVD display and on the TV screen. Press the ANGLE button while the angle icon is displayed.

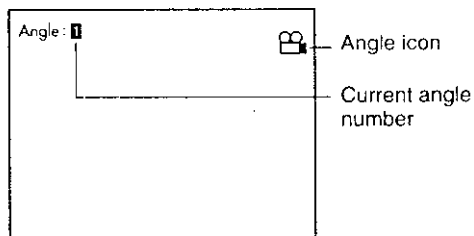

To turn off the angle number indication



Hold down RETURN/CLEAR for longer than one second.

To disable the angle icon display on the TV

From the on-screen displays, set "On-Screen Displays" to "Off." **32** **42**
Monitor the DVD display when you want to change the camera angle.



Press ANGLE or ▲ while the angle number appears on the TV screen.

Each time you press the ANGLE or ▲ button, the camera angle changes.

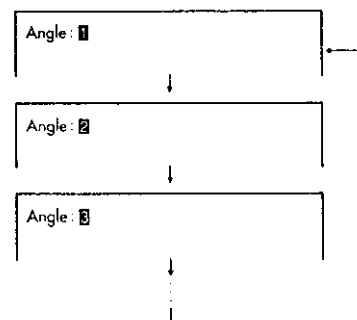

▼ : Cycles backward

You can change the camera angle directly by pressing the number buttons corresponding to its angle number instead of using the ▲ / ▼ buttons.

Notes

- You can change the camera angle during still playback. The camera angle changes to the new setting when you resume normal playback.

Selecting a Language

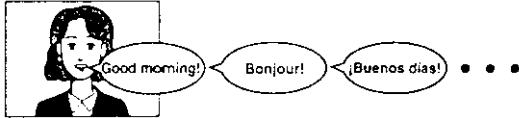

A preferred language can be selected from several languages.

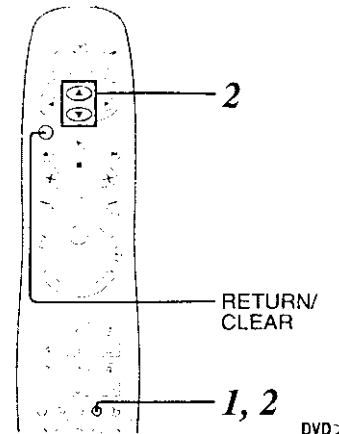

Selecting a Playback Audio Setting

You can select a preferred language and sound recording system from those included on the DVD video disc.

1 Press **AUDIO** during playback.

The current audio setting appears for about 3 seconds.

The abbreviation of the language appears instead of the language name. Refer to the list of languages and their abbreviations. **[50]**

2 Press **AUDIO** or **▲** while the audio setting appears on the TV screen.

Each time you press the **AUDIO** or **▲** button, the audio settings included on the DVD video disc change.

Example

▼ : Cycles backward

To turn off the audio setting display

Hold down **RETURN/CLEAR** for longer than one second.

About recording systems

This DVD video player uses the Dolby Digital, DTS, MPEG2 and PCM recording systems and cannot play DVD video discs recorded in any other recording system.

Dolby Digital 5.1 Channel is displayed as "DD 6CH."

Selecting sound channels of VIDEO CDs

A VIDEO CD may have left and right sound channels and contain sounds or languages on each. You can switch these two channels to hear a preferred sound or language.

During playback, press **AUDIO** repeatedly to select the sound channel.

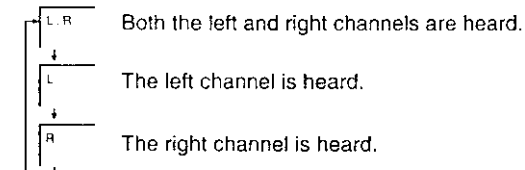

Notes

- Some discs allow you to change audio selections only via the disc menu. If this is the case, press the **MENU** button and choose the appropriate language from the selections on the disc menu.
 - When you turn on the DVD video player or replace a disc, player returns to the initial default setting. **[35]**
- When you select a sound track which is not included on the disc, the DVD video player plays a prior sound track programmed on the disc.

Output sound conversion table (sampling frequency/quantization bit)

Discs	Sound recording system	Audio selection from the menu screen [32] [38] and output jacks on the rear panel							
		Bitstream		Analog 6ch		Analog 2ch		PCM	
		BITSTREAM/PCM jack	MIXED AUDIO OUT jacks	BITSTREAM/PCM jack	5.1CH SURROUND AUDIO OUT jacks	BITSTREAM/PCM jack	MIXED AUDIO OUT jacks	BITSTREAM/PCM jack	MIXED AUDIO OUT jacks
DVD video discs	Dolby Digital	Bitstream	2ch	—	3-6ch	Bitstream	48 kHz/20 bit	48 kHz/16 bit	48 kHz/20 bit
	Linear PCM	48 kHz/16 bit	48 kHz/16 bit	48 kHz/16 bit	—	48 kHz/16 bit	48 kHz/16 bit	48 kHz/16 bit	48 kHz/16 bit
		48 kHz/20 bit	48 kHz/16 bit	48 kHz/20 bit	—	48 kHz/20 bit	48 kHz/16 bit	48 kHz/16 bit	48 kHz/20 bit
		48 kHz/24 bit	48 kHz/16 bit	48 kHz/20 bit	—	48 kHz/20 bit	—	48 kHz/16 bit	48 kHz/20 bit
		96 kHz/16 bit	48 kHz/16 bit	48 kHz/16 bit	—	96 kHz/16 bit	—	48 kHz/16 bit	48 kHz/16 bit
		96 kHz/20 bit	48 kHz/16 bit	48 kHz/20 bit	—	96 kHz/20 bit	—	48 kHz/16 bit	48 kHz/20 bit
	96 kHz/24 bit	48 kHz/16 bit	48 kHz/20 bit	—	96 kHz/20 bit	—	48 kHz/16 bit	48 kHz/20 bit	
DTS	Bitstream	—	Bitstream	—	Bitstream	—	—	—	
VIDEO CDs	MPEG2	Bitstream(2ch)	2ch	—	3-6ch	Bitstream(2ch)	48 kHz/20 bit	48 kHz/16 bit	48 kHz/20 bit
	MPEG1	44.1 kHz/16 bit	44.1 kHz/16 bit	—	44.1 kHz/16 bit	44.1 kHz/16 bit	44.1 kHz/16 bit	44.1 kHz/16 bit	
Audio CDs	Linear PCM	44.1 kHz/16 bit	44.1 kHz/16 bit	44.1 kHz 16 bit	44.1 kHz/16 bit	44.1 kHz/16 bit	44.1 kHz/16 bit	44.1 kHz/16 bit	

Selecting Subtitles

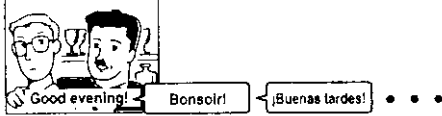

You can display subtitles on the TV screen and select a preferred subtitle language.

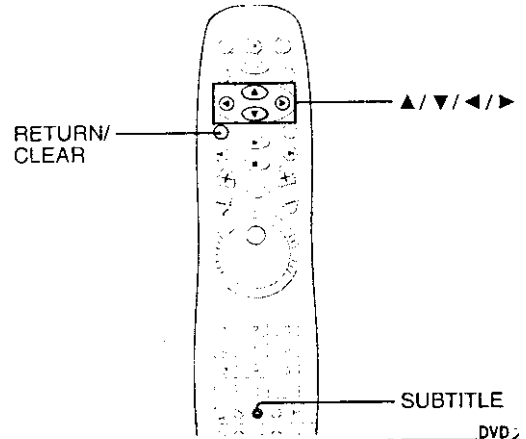

Turning Subtitles On or Off

You can select whether to display subtitles or not.

1 Press **SUBTITLE** during playback.

The current subtitle setting appears for about three seconds.

Subtitle: 1 ENG On

2 Press **◀** or **▶** while the subtitle setting appears on the TV screen, to select "On" or "Off."

On: Subtitles are displayed.

Subtitle: 1 ENG On

 Good evening! Subtitles

Off: Subtitles are not displayed.

Subtitle: 1 ENG Off

Selecting a Subtitle Language

You can select a subtitle language from those included on the DVD video disc.

1 Press **SUBTITLE** during playback.

The current subtitle setting appears for about three seconds.

Subtitle: 1 ENG On
 |
 Language
 Position number

The abbreviation of the language appears instead of the language name. Refer to the list of languages and their abbreviations. [50](#)

2 Press **SUBTITLE** or **▲** while the subtitle setting appears on the TV screen.

Each time you press the SUBTITLE or ▲ button, the subtitle languages included on the DVD video disc change.

Example

Subtitle: 1 ENG On
 ↓
 Subtitle: 2 FRE On
 ↓
 Subtitle: 3 SPA On

▼ : Cycles backward

To turn off the subtitle setting indicator



Hold down RETURN/CLEAR for longer than one second.

Notes

- Some DVD video discs are set to display subtitles automatically, and you cannot turn them off even if you set the subtitle function to off.
- During some scenes, the subtitles may not appear immediately after you select "On."

Notes

- When you turn on the DVD video player or replace a disc, the player returns to the initial default setting. [35](#)
- When you select a subtitle language which is not included on the disc, the DVD video player plays a prior language programmed on the disc.

Using the On-Screen Display

You can view information about a disc and its operational status on the TV screen.

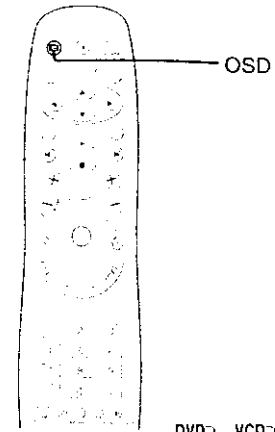

DVD VCD CD

Checking the Operational Status

You can view the current title number, track number, and total playing time of the disc on the TV screen.



Press OSD while playback is stopped.

Each time you press the OSD button, the on-screen display changes as follows.

(DVD video disc)

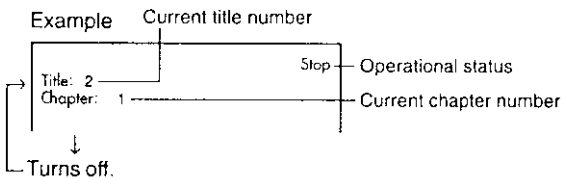

(VIDEO CD/audio CD)

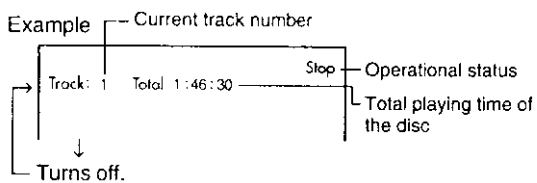

DVD VCD CD

Checking the Remaining Time and Setting Status

You can view the elapsed time, remaining time, and setting status of the disc on the TV screen.



Press OSD during playback.

Each time you press the OSD button, the on-screen display changes as follows.

(DVD video disc)

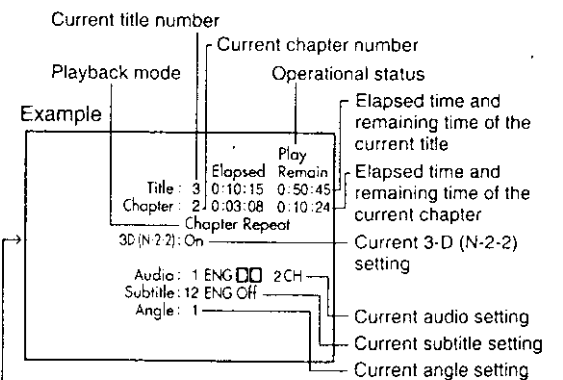

The abbreviation of the language (e.g. ENG) appears instead of the language name. Refer to the list of languages and their abbreviations. **50**



Data transfer rate (Mbit/s)
= Amount of picture, sound and subtitle data in the DVD video disc transferred per second.
The larger the value is, the more data processed, but this does not necessarily insure better picture quality.

Turns off.

(VIDEO CD/audio CD)

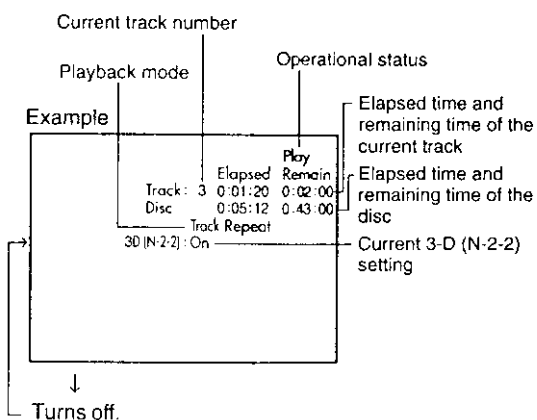

Turns off.

Function Setup

Customizing the Settings



You can change the default settings to customize performance to your preference.

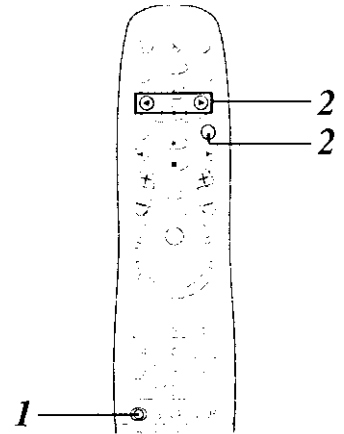

Selecting a Setting Category

The setting menu asks you to select a setting for LANGUAGE, PICTURE, AUDIO, DISPLAY and OPERATION. Each selected category will provide you setting details.

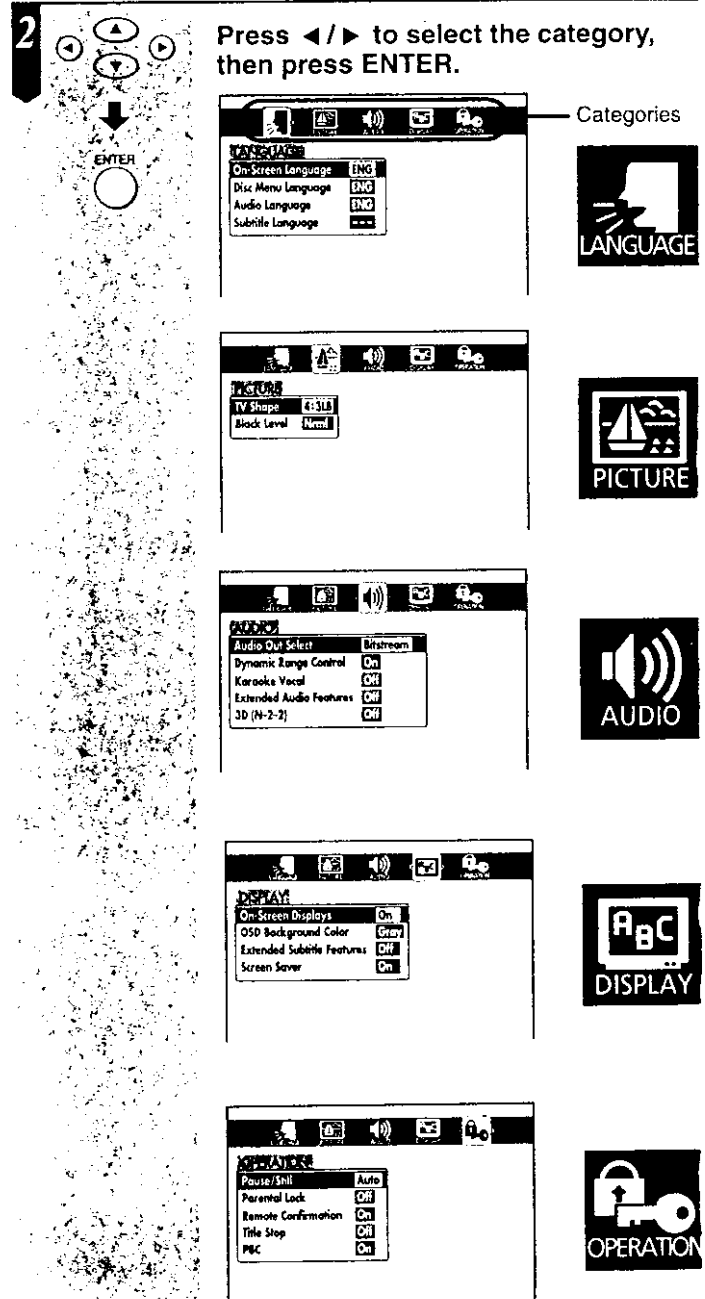
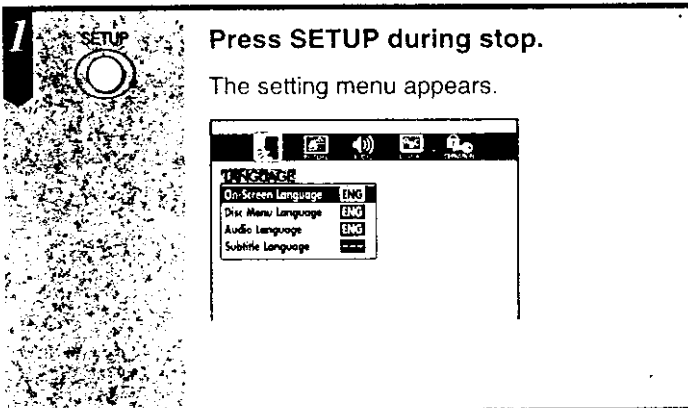

Notes

- The setting menu disappears when you press the SETUP button.
- The SETUP button can function even during normal playback, however some operations may be inaccessible, and a message will appear. In this case, try again after playing is stopped.

Setting		Details	Page
On-Screen Language	DVD VCD CD	To select the display language.	34
Disc Menu Language	DVD	To select a preferred language for disc menus.	34
Audio Language	DVD	To select a preferred language for the sound track.	35
Subtitle Language	DVD	To select a preferred language for subtitles.	35
TV Shape	DVD	To select a picture size according to the aspect ratio of your TV.	36
Black Level	DVD VCD	To select the black level (contrast) of playback pictures.	37
Audio Out Select	DVD VCD CD	To select an output sound type according to your system connection.	38
Dynamic Range Control	DVD	To turn on or off a function that makes faint sounds easier to hear, even if you lower the volume in late hours playback.	40
Karaoke Vocal	DVD	To turn on or off the vocal output in DVD KARAOKE disc playback.	40
Extended Audio Features	DVD	To turn on or off special language for visually impaired persons.	40
3D (N-2-2)	DVD VCD CD	To turn on or off the 3-D (N-2-2) Sound Enhancement.	41
On-Screen Displays	DVD VCD CD	To turn on or off the operational status display (On-screen display) on the TV screen.	42
OSD Background Color	DVD VCD CD	To select the background color for on-screen displays.	42
Extended Subtitle Features	DVD	To turn on or off special subtitles for hearing impaired persons.	42
Screen Saver	DVD VCD	To turn on or off the screen saver.	43
Pause/Still	DVD	To select the resolution of still pictures.	44
Parental Lock	DVD	To turn on or off the parental lock function.	44
Remote Confirmation	DVD VCD CD	To turn on or off the confirmation beeper for each press of a remote control button.	46
Title Stop	DVD	To turn on or off the function that automatically stops playback after playing one title.	46
PBC	VCD	To use the menu screen when playing a PBC-controllable VIDEO CD.	46

Customizing the Settings (continued)



After you select LANGUAGE **32**, adjust the categories to your preference.

LANGUAGE Setting

3

(Continued from page 32.)

Press **▲** / **▼** to select the item, then press ENTER.



On-Screen Language **DVD** **VCD** **CD**

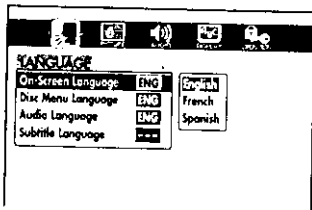

Select a preferred language by pressing **▲** / **▼**, then press ENTER.

→ If you do not adjust any other settings, proceed to step 4.

Disc Menu Language **DVD**

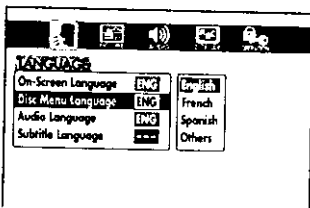

Select a preferred language by pressing **▲** / **▼**, then press ENTER.

→ If you do not adjust any other settings, proceed to step 4.

■ To select other languages:

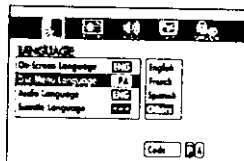

- 1) Select "Others" and press the ENTER button.
- 2) Obtain the abbreviation of the preferred language from the list **50**.
- 3) Select the first character by pressing the **▲** / **▼** buttons.
- 4) Press the **◀** / **▶** buttons to shift and select the second character by pressing the **▲** / **▼** buttons.
- 5) Press the ENTER button.

• Some DVD video discs may not include your pre-selected language. In this case, the DVD video player automatically displays disc menus consistent with the disc's initial language setting.

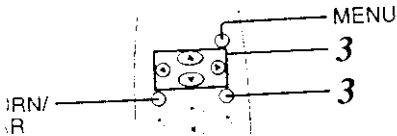

RETURN/CLEAR : If you press the RETURN/CLEAR button while a menu appears on the screen, you will return to the previous menu screen.

4

DVD > VCD > CD >

Audio Language

DVD

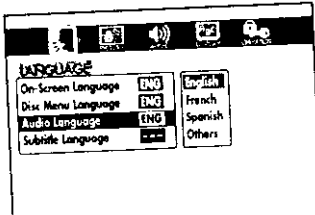

Select a preferred language by pressing ▲ / ▼, then press ENTER.

→ If you do not adjust any other settings, proceed to step 4.

■ To select other languages:

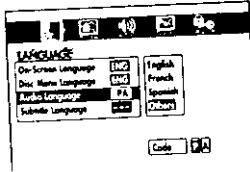

- 1) Select "Others" and press the ENTER button.
- 2) Obtain the abbreviation of the preferred language from the list [50].
- 3) Select the first character by pressing the ▲ / ▼ buttons.
- 4) Press the ◀ / ▶ buttons to shift and select the second character by pressing the ▲ / ▼ buttons.
- 5) Press the ENTER button.

• Some DVD video discs may be played in a different language than you selected. A prior language may be programmed on the disc.

Subtitle Language

DVD

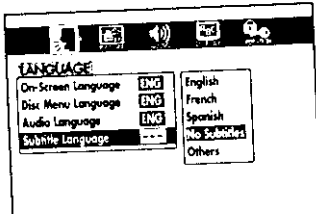

Select a preferred language by pressing ▲ / ▼, then press ENTER.

→ If you do not adjust any other settings, proceed to step 4.

■ To select other languages:

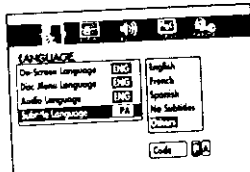

- 1) Select "Others" and press the ENTER button.
- 2) Obtain the abbreviation of the preferred language from the list [50].
- 3) Select the first character by pressing the ▲ / ▼ buttons.
- 4) Press the ◀ / ▶ buttons to shift and select the second character by pressing the ▲ / ▼ buttons.
- 5) Press the ENTER button.

• If you select "No Subtitles," subtitles are not displayed.
 • Some DVD video discs may be set to display subtitles in a different language than you selected. A prior subtitle language may be programmed on the disc.
 • Some DVD video discs allow you to change subtitle selections only via the disc menu. If this is the case, press the MENU button and choose the appropriate subtitle language from the selection on the disc menu.

4

SETUP



Press SETUP.

The setting menu disappears.

Customizing the Settings (continued)



After you select PICTURE [32], adjust the categories to your preference.

PICTURE Setting

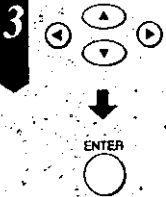

(Continued from page 32.)

Press ▲ / ▼ to select the item, then press ENTER.

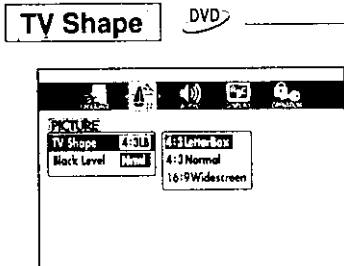

4:3 LetterBox: Select when a 4:3 TV is connected. Displays theatrical images with masking bars above and below the picture.



4:3 Normal: Select when a 4:3 TV is connected. Displays pictures cropped to fill your TV screen. Either or both sides of the picture are cut off.

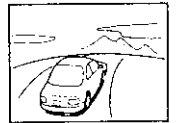

16:9 Widescreen: Select when a 16:9 wide TV is connected.

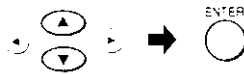

Select your TV type by pressing ▲ / ▼ , and then press ENTER.

→ If you do not adjust any other settings, proceed to step 4.

- The displayable picture size is preset on the DVD video disc. Therefore, the playback picture of some DVD video discs may not conform to the picture size you select.
- When you play DVD video discs recorded in the 4:3 picture size only, the playback picture always appears in the 4:3 picture size regardless of the TV shape setting.
- If you select "16:9 Widescreen" and you own a 4:3 TV set, the DVD playback picture will be horizontally distorted during playback. Images will appear to be horizontally compressed. Always be sure that your TV shape conforms to the actual TV in use.

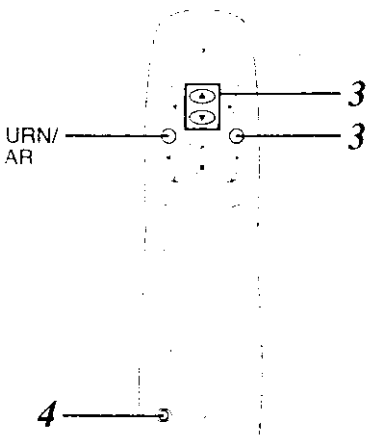

RETURN / CLEAR : If you press the RETURN/CLEAR button while a menu appears on the screen, you will return to the previous menu screen.

DVD VCD

Black Level

DVD VCD

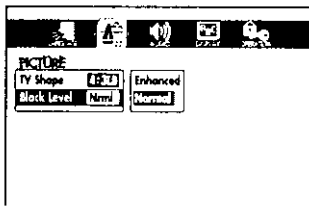

Enhanced: Increased black level (contrast).
Normal: Standard black level (contrast).

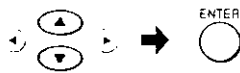

Select the black level by pressing ▲ / ▼, then press ENTER.

→ If you do not adjust any other settings, proceed to step 4.

SETUP



Press SETUP.

The setting menu disappears.

Customizing the Settings (continued)



After you select AUDIO [32], adjust the categories to your preference.

AUDIO Setting

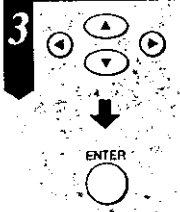

(Continued from page 32.)

Press ▲ / ▼ to select the item, then press ENTER.

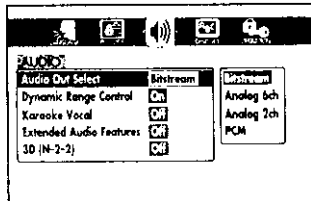

Select the output sound type according to your system connection.

For details of sound recording systems, see [29].

Bitstream:

Select when connected to an amplifier equipped with a Dolby Digital, DTS or MPEG2 decoder. [14] [15]

The DVD video player outputs digital audio information in the bitstream format when you play a DVD video disc recorded on the Dolby Digital, DTS or MPEG2 recording system.

Analog 6ch:

Select when connected to a Dolby Digital ready amplifier equipped with 5.1ch audio inputs. [14]

This DVD video player is equipped with a Dolby Digital decoder.

The next screen will appear for the detailed setting. See [39].

Analog 2ch:

Select when connected to a TV, or Dolby Pro Logic or stereo system via the analog audio jacks. [12] [13]

PCM:

Select when connected to a 2 channel digital stereo amplifier. [15]

The DVD video player outputs sounds in the PCM 2ch (48 kHz/16 bit) format when you play a DVD video disc recorded on the Dolby Digital, DTS or MPEG2 recording system.



Select the output sound type by pressing ▲ / ▼, then press ENTER.

→ If you do not adjust any other settings, proceed to step 4.

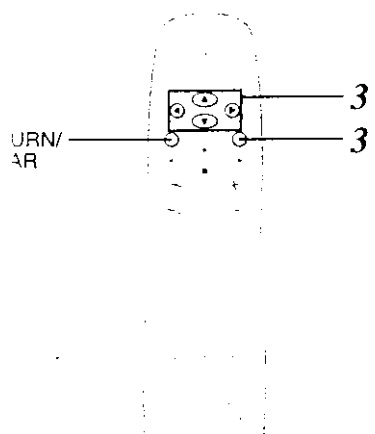

RETURN/CLEAR : If you press the RETURN/CLEAR button while a menu appears on the screen, you will return to the previous menu screen.

DVD VCD CD

■ When you select "Analog 6Ch" [38] :

Make the follow settings for the built-in 5.1ch surround decoder.

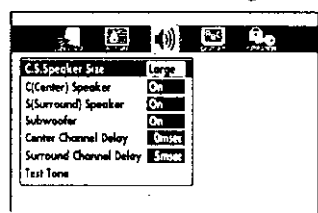

- 1) Select an item by pressing the ▲ / ▼ buttons, and press the ENTER button.
- 2) Make the settings (see below) by pressing the ▲ / ▼ / ◀ / ▶ buttons, and press the ENTER button.

C.S. Speaker Size	Large: When the main speakers can reproduce low frequency signals below 120 Hz. Small: When the main speakers cannot reproduce low frequency signals below 120 Hz.	
C(Center) Speaker	On: When you connect center speakers. Off: When center speakers are not connected.	▲ / ▼
S(Surround) Speaker	On: When you connect surround speakers. Off: When surround speakers are not connected.	
Subwoofer	On: When you connect a sub woofer. Off: When a sub woofer is not connected.	
<p>• Adjusting the delay time: When enjoying 5.1ch surround playback, it is ideal to choose a listening position that is the same distance from each speaker. By adjusting the delay time of the center/surround speakers, you can virtually create an ideal listening environment (as if the center/surround speakers were at their ideal locations respectively as below.)</p>		◀ / ▶
Center Channel Delay	<p>0msec: When Df equals Dc. 1msec: When (A) is approx. 34 cm (13 inch) 2msec: When (A) is approx. 68 cm (27 inch) 3msec: When (A) is approx. 102 cm (40 inch) ...</p> <p>$(A) = Df - Dc$ Get your optimum value (0, 1, 2 ... 5) deviding (A) by 34.</p>	
Surround Channel Delay	<p>0msec: When Df equals Ds. 1msec: When (B) is approx. 34 cm (13 inch) 2msec: When (B) is approx. 68 cm (27 inch) 3msec: When (B) is approx. 102 cm (40 inch) ...</p> <p>$(B) = Df - Ds$ Get your optimum value (0, 1, 2 ... 15) deviding (B) by 34.</p>	

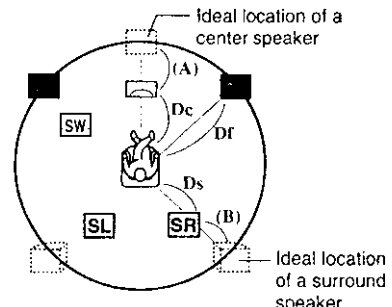

All speakers should be located within a circle with a radius of Df.

- 3) Select "Test Tone" and press the ENTER button.
The DVD video player outputs a test signal to each speaker.
Press the ◀ / ▶ buttons to switch the receiving speakers, and adjust the channel balance on the amplifier so that each signal is heard at its appropriate volume level.

Customizing the Settings (continued)



AUDIO Setting (continued)

(Continued)

Dynamic Range Control

DVD

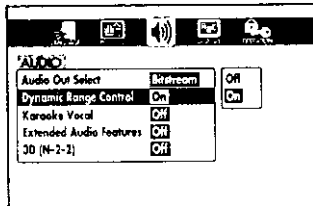

On: Dynamic range is reduced.
Off: Full dynamic range is heard.

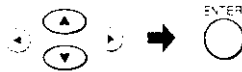

Select "On" or "Off" by pressing **▲ / ▼**, then press **ENTER**.

→ If you do not adjust any other settings, proceed to step 4.

- This function works only during playback of Dolby Digital recorded discs.
- The level of Dynamic Range Reduction may differ depending on the DVD video disc.

Karaoke Vocal

DVD

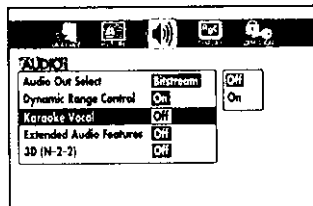

On: The primary vocal is output when it is recorded on the disc.
Off: The primary vocal is not output.



Select "On" or "Off" by pressing **▲ / ▼**, then press **ENTER**.

→ If you do not adjust any other settings, proceed to step 4.

The vocal output feature is used during playback of Dolby Digital (multi-channel) recorded DVD KARAOKE discs. This feature allows you to turn off vocal audio tracks, or restore them for background accompaniment.

Extended Audio Features

DVD

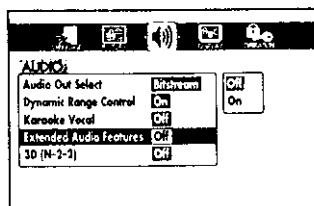

On: Some DVD video discs contain special language track that describes the actions on-screen for visually impaired persons. The DVD video player automatically plays this special feature.
Off: The DVD video player does not play this special feature.



Select "On" or "Off" by pressing **▲ / ▼**, then press **ENTER**.

→ If you do not adjust any other settings, proceed

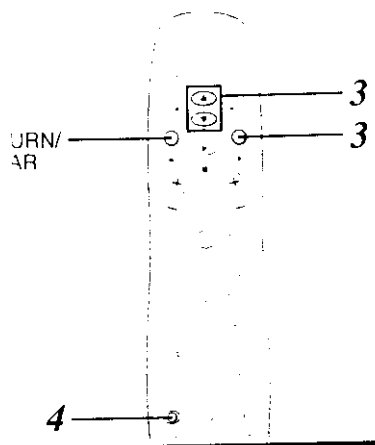

RETURN
CLEAR : If you press the RETURN/CLEAR button while a menu appears on the screen, you will return to the previous menu screen.

DVD

3D (N-2-2) DVD VCD CD

3D (N-2-2) Sound Enhancement

You can enjoy expansive surround type effects from two speakers.

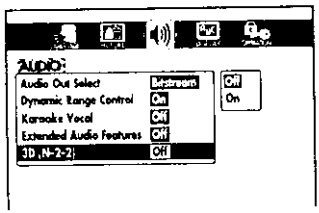

On: The 3D (N-2-2) Sound enhancement functions.
Off: The 3D (N-2-2) Sound enhancement does not function.

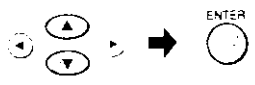

Select "On" or "Off" by pressing ▲ / ▼, then press ENTER.

→ If you do not adjust any other settings, proceed to step 4.

- You may sense a difference in volume between "On" and "Off".
- 3-D (N-2-2) sound enhancement may not function (or may not be realized) depending on the sound output setting or recording system [29].
- If 3-D (N-2-2) sound enhancement is on, Dolby Pro Logic Surround may not function on output sounds at all, or may function differently than usual.

Spatializer® 3-Dimensional Sound Processing provided by Desper Products, Inc. Certain audio features of this product manufactured under a license from Desper Products, Inc., Spatializer® and the circle-in-square device are trademarks owned by Desper Products, Inc.

SETUP



Press SETUP.

The setting menu disappears.

Customizing the Settings (continued)



After you select DISPLAY [32], adjust the categories to your preference.

DISPLAY Setting

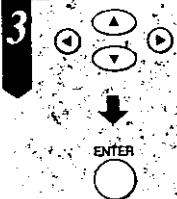



(Continued from page 32.)

Press ▲ / ▼ to select the item, then press ENTER.

On-Screen Displays

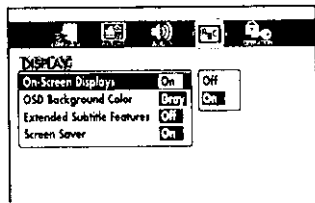
DVD VCD CD



On: Operational modes are displayed on-screen. (e.g. "Play", )
Off: Operational modes are not displayed.



Select "On" or "Off" by pressing ▲ / ▼, then press ENTER.

→ If you do not adjust any other settings, proceed to step 4.

OSD Background Color

DVD VCD CD

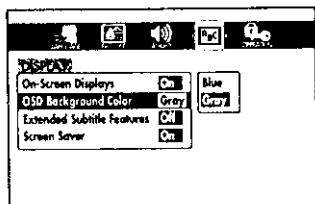

Gray: Gray background.
Blue: Blue background.



Select the background color by pressing ▲ / ▼, then press ENTER.

→ If you do not adjust any other settings, proceed to step 4.

Extended Subtitle Features

DVD

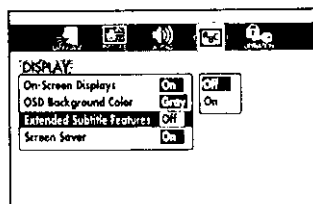

On: Some DVD video discs contain special subtitles, an enhancement of closed captioning for hearing impaired persons. The DVD video player automatically displays these special subtitles.
Off: The DVD video player does not display these special subtitles.



Select "On" or "Off" by pressing ▲ / ▼, then press ENTER.

→ If you do not adjust any other settings, proceed to step 4.

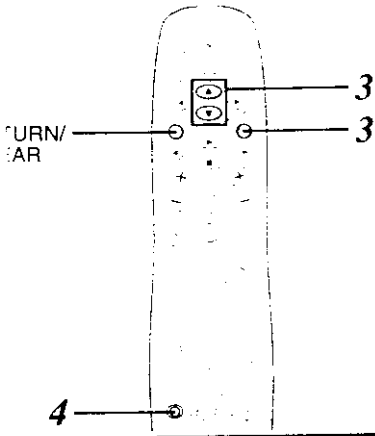

RETURN/CLEAR : If you press the RETURN/CLEAR button while a menu appears on the screen, you will return to the previous menu screen.

DVD > VCD > CD >

Screen Saver

DVD > VCD >

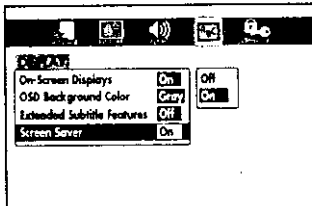

On: The screen saver works.
Off: The screen saver does not work.



Select "On" or "Off" by pressing ▲/▼, then press ENTER.

→ If you do not adjust any other settings, proceed to step 4.

SETUP



Press SETUP.

The setting menu disappears.

Customizing the Settings (continued)



After you select OPERATION [32], adjust the categories to your preference.

OPERATION Setting

3

(Continued from page 32.)

Press ▲ / ▼ to select the item, then press ENTER.



Pause/Still DVD

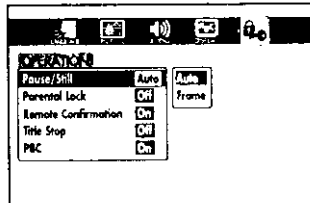

Auto: For normal use. Pictures can pause without shaking.

Frame: The resolution of still pictures is raised, so that you can make especially a motionless picture more clearer when you pause it.



Select "Auto" or "Frame" by pressing ▲ / ▼, then press ENTER.

→ If you do not adjust any other settings, proceed to step 4.

Parental Lock DVD

Parental Lock

DVD video discs equipped with the parental lock function are rated according to their content. The contents allowed by a parental lock level and the way a DVD video disc can be controlled may vary from disc to disc. For example, if the disc allowed you could edit out violent scenes unsuitable for children and replace them with more suitable scenes, or lock out playback of the disc altogether.

- DVD video discs may or may not respond to the parental lock settings. This is not a defect in the DVD video player. Make sure this function works with your DVD video discs.

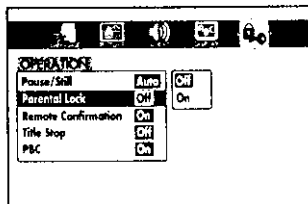

On: Select when you activate the parental lock feature or change the settings.

The next screen will appear for the detailed setting. [45]

Off: The parental lock feature does not function.



Select "On" or "Off" by pressing ▲ / ▼, then press ENTER.

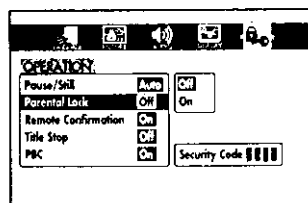

Press the number buttons to create a personal four-digit security code, then press ENTER.

If you make a mistake before pressing the ENTER button, press the CLEAR button and enter your 4-digit security code again.

→ If you do not adjust any other settings, proceed to step 4.

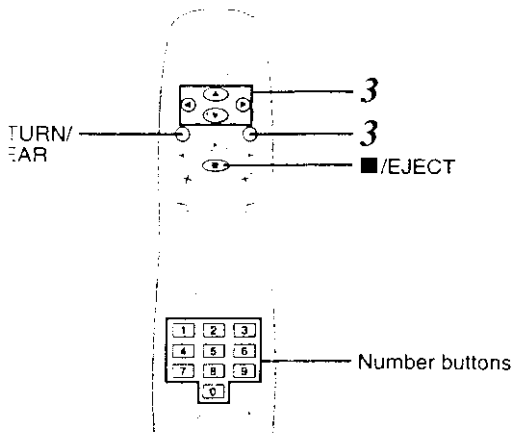

RETURN/CLEAR : If you press the RETURN/CLEAR button while a menu appears on the screen, you will return to the previous menu screen.

DVD

■ When you select "On" [44] :

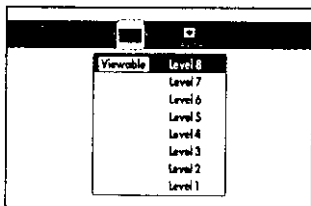

1) Press the ◀/▶ buttons to select the country whose standards were used to rate the DVD video disc, then press the ENTER button.

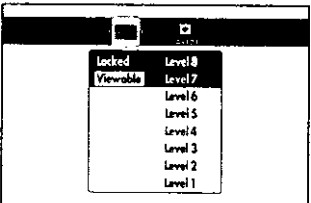

2) Press the ▲/▼ buttons to select the parental lock level, then press the ENTER button.

You cannot play DVD video discs rated higher than the level you selected unless you cancel the parental lock function. For example, when you select level 7, discs rated higher than level 7 are locked out and cannot be played.

The parental lock level is equivalent to the following USA movie ratings.

LEVEL 7: NC-17	LEVEL 3: PG
LEVEL 6: R	LEVEL 1: G
LEVEL 4: PG 13	

The parental lock levels for "CANADA" are included for future use. Check the appropriate parental lock level when you buy a DVD video disc equipped with the parental lock feature in the future.

- To change the parental lock level: Follow the above procedure.
- To change your 4-digit security code: After selecting "On" or "Off" [44] , press the STOP button for times, then press the ENTER button.

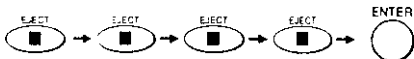

The 4-digit security code is cleared. Press the number buttons to create a new 4-digit security code, then press the ENTER button.

Customizing the Settings (continued)



OPERATION Setting (continued)

(Continued)

Remote Confirmation

DVD VCD CD

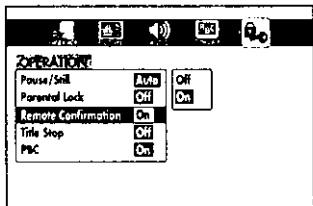

On: Beeper sounds with each press of a remote control button.
Off: The beeper does not sound.



Select "On" or "Off" by pressing **▲ / ▼**, then press **ENTER**.

→ If you do not adjust any other settings, proceed to step 4.

Title Stop

DVD

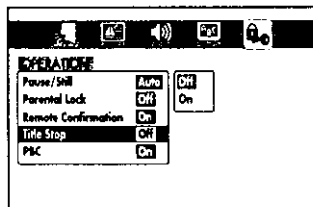

On: Player stops playing the disc after playback of a title is completed.
Off: Player continues playing the disc after playback of a title is completed.



Select "On" or "Off" by pressing **▲ / ▼**, then press **ENTER**.

→ If you do not adjust any other settings, proceed to step 4.

PBC

VCD

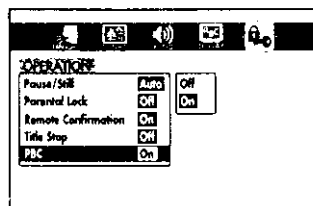

On: To view the menu screen when playing a PBC-featured VIDEO CD.
Off: For playback without using the menu screen.



Select "On" or "Off" by pressing **▲ / ▼**, then press **ENTER**.

→ If you do not adjust any other settings, proceed to step 4.

* PBC is the abbreviation of

Press SETUP.
The setting menu disappears.

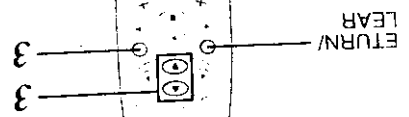

RETURN/CLEAR : If you press the RETURN/CLEAR button while a menu appears on the screen, you will return to the previous menu screen.

DVD, VCD, CD

Function Setup

Operating Other Equipment with the Remote Control

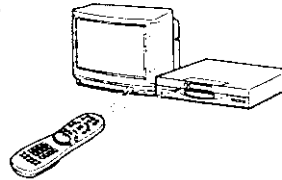

You can operate the basic functions of selected TVs, amplifiers, and receivers using the supplied remote control.

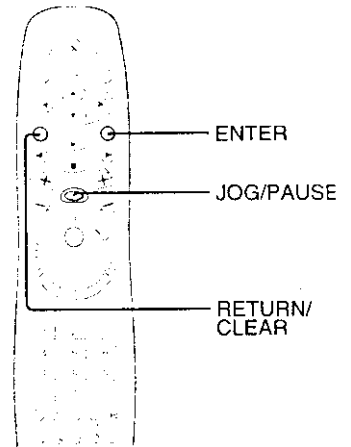

Programming the Remote Control

You can operate other equipment with the DVD video player's remote control.

1 Press and hold RETURN/CLEAR and ENTER simultaneously until JOG/PAUSE lights up.

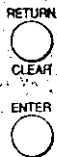

2 Release RETURN/CLEAR and ENTER.

3 Press the number buttons that correspond to your equipment's brand code (listed at right).

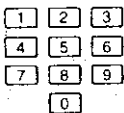

Example: To program brand code 040, press

0 → **4** → **0**

When you press the last digit, the JOG/PAUSE button blinks twice, then turns off.

4 Point the remote control at the equipment you want to operate.

Brand Code Table

TV brand code

Brand name	Brand code
GE	019, 021, 023, 036, 037, 041, 077, 103, 105, 150, 160, 163, 245
Goldstar	002, 003, 017, 024, 026, 032, 042, 072, 105, 227
JVC	029, 039, 047, 092, 098, 109
Magnavox	018, 020, 022, 024, 029, 040, 065, 112, 113, 140, 217
Motorola	041, 062
NEC	017, 024, 029, 042, 099, 246
Panasonic	037, 041, 094, 138, 149, 190, 210
Philips	040
Proscan	036
Proton	004, 025, 038, 105, 249
Quasar	037, 041, 096, 149
RCA	016, 017, 023, 031, 036, 059, 077, 103, 159
Samsung	017, 024, 026, 032, 042, 043, 105, 184, 226, 237, 253
Sanyo	080, 086, 091, 141, 254
Sears	013, 036, 040, 042, 080, 081, 082, 086, 088, 091, 100, 105, 106, 162
Sharp	032, 062, 085, 089, 096, 136, 162, 217, 222, 258
Sony	001, 009, 055, 075
Technics	037, 149
Thomson	127, 128
Toshiba	029, 043, 082, 086, 088
Yamaha	017, 024
Zenith	014, 015

Amplifier brand code

Brand name	Brand code
Denon	411
Harman/Kardon	405
JVC	425
Magnavox	420
Marantz	420, 424
Philips	420
Pioneer	401, 422
Sony	415
Technics	423, 434
Yamaha	408, 410, 427, 433

Receiver brand code

Brand name	Brand code
Carver	505, 512, 557, 605, 714
Denon	502, 704
Harman/Kardon	530, 531
Inkel	517, 519
JVC	521, 630
Kenwood	510, 523, 556, 589, 590
Magnavox	538, 557, 559, 562, 569, 607, 645
Marantz	503, 511, 538, 557, 560, 603, 628
Onkyo	528, 535, 539, 542, 610
Optimus	512, 552, 554, 556, 568, 624, 645, 672, 683, 699, 718
Panasonic	511, 612
Philips	557, 677
Pioneer	544, 582, 645, 674
RCA	516, 600, 605, 644, 645, 679
Sansui	557, 558, 594, 600, 661
Sony	545, 549, 620, 632

Notes

- The same brand may use different codes depending on the model. Enter the correct number, referring to the brand code table.
- For some brands, several codes are provided. Try each of them until the remote control operates your equipment.
- Some equipment may not respond to all of the functions in the table in the next page, or may not be operated at all with this remote control. In this case, operate that equipment with its own remote control.
- If you replace the remote control's batteries, remember to reprogram

Buttons to operate

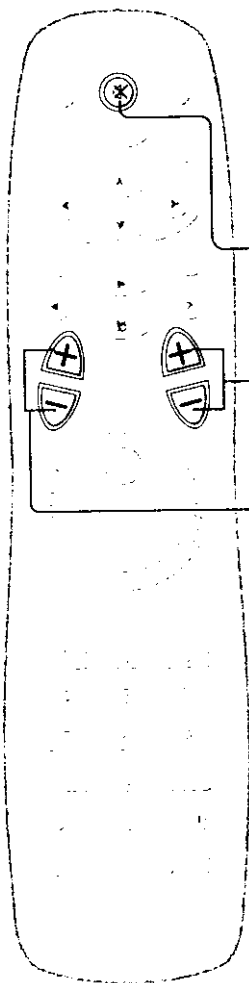

	TV	Amplifier	Receiver
MUTE	To mute the sound.	To mute the sound.	To mute the sound.
TV CH (+/-)	To select channels.		
TV VOL (+/-)	To turn up or down the volume.	To turn up or down the volume.	To turn up or down the volume.

Table of Languages

Table of Languages and Their Abbreviations

Abbreviation of the Language	Language	Abbreviation of the Language	Language	Abbreviation of the Language	Language	Abbreviation of the Language	Language
---	No alternate language	EO	Esperanto	LN	Lingala	SL	Slovenian
CHI (ZH)	Chinese	ET	Estonian	LO	Laotian	SM	Samoaan
DUT (NL)	Dutch	EU	Basque	LT	Lithuanian	SN	Shona
ENG (EN)	English	FA	Persian	LV	Latvian, Lettish	SO	Somali
FRE (FR)	French	FI	Finnish	MG	Malagasy	SQ	Albanian
GER (DE)	German	FJ	Fiji	MI	Maori	SR	Serbian
ITA (IT)	Italian	FO	Faroese	MK	Macedonian	SS	Siswati
JPN (JA)	Japanese	FY	Frisian	ML	Malayalam	ST	Sesotho
KOR (KO)	Korean	GA	Irish	MN	Mongolian	SU	Sundanese
MAY (MS)	Malay	GD	Scottish Gaelic	MO	Moldavian	SV	Swedish
SPA (ES)	Spanish	GL	Galician	MR	Marathi	SW	Swahili
AA	Afar	GN	Guarani	MT	Maltese	TA	Tamil
AB	Abkhazian	GU	Gujarati	MY	Burmese	TE	Telugu
AF	Afrikaans	HA	Hausa	NA	Nauru	TG	Tajik
AM	Amharic	HI	Hindi	NE	Nepali	TH	Thai
AR	Arabic	HR	Croatian	NO	Norwegian	TI	Tigrinya
AS	Assamese	HU	Hungarian	OC	Occitan	TK	Turkmen
AY	Aymara	HY	Armenian	OM	(Afan) Oromo	TL	Tagalog
AZ	Azerbaijani	IA	Interlingua	OR	Oriya	TN	Setswana
BA	Bashkir	IE	Interlingue	PA	Panjabi	TO	Tongan
BE	Belorussian	IK	Inupiak	PL	Polish	TR	Turkish
BG	Bulgarian	IN	Indonesian	PS	Pashto, Pushto	TS	Tsonga
BH	Bihari	IS	Icelandic	PT	Portuguese	TT	Tatar
BI	Bislama	IW	Hebrew	QU	Quechua	TW	Twi
BN	Bengali, Bangla	JI	Yiddish	RM	Rhaeto-Romance	UK	Ukrainian
BO	Tibetan	JW	Javanese	RN	Kirundi	UR	Urdu
BR	Breton	KA	Georgian	RO	Rumanian	UZ	Uzbek
CA	Catalan	KK	Kazakh	RU	Russian	VI	Vietnamese
CO	Corsican	KL	Greenlandic	RW	Kinyarwanda	VO	Volapük
CS	Czech	KM	Cambodian	SA	Sanskrit	WO	Wolof
CY	Welsh	KN	Kannada	SD	Sindhi	XH	Xhosa
DA	Danish	KS	Kashmiri	SG	Sango	YO	Yoruba
DZ	Bhutani	KU	Kurdish	SH	Serbo-Croatian	ZU	Zulu
EL	Greek	KY	Kirghiz	SI	Singhalese		
		LA	Latin	SK	Slovak		

Notes on Discs

Handling Discs

Do not touch the playback side of the disc.



Playback side

Do not attach paper or tape to discs.

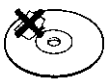

Cleaning Discs

Fingerprints and dust on the disc cause picture and sound deterioration. Wipe the disc from the center outward with a soft cloth. Always keep the disc clean.



You cannot wipe off the dust with a soft cloth, wipe the disc lightly with a slightly moistened soft cloth, then dry the disc with a dry cloth. Do not use any type of solvent such as thinner, benzene, commercially available cleaners, or antistatic spray for vinyl LPs. It may damage the disc.

Storing Discs

Do not store discs in a place subject to direct sunlight or heat. Do not store discs in places subject to moisture and dust, such as in a bathroom or near a humidifier. Store discs vertically in a case. Stacking or placing objects on discs may cause warping.

About This Owner's Manual

This owner's manual explains the basic instructions of this DVD video player. Some DVD video discs are produced in a manner that allows specific or limited operation during playback. As such, the DVD video player may not respond to all operating commands. This is not a defect of the DVD video player. Refer to the instruction notes of discs.

A "⊘" may appear on the TV screen during operation. A "⊘" means the operation is not permitted by the DVD video player or the disc.

Notes on Region Numbers

The region number of this DVD video player is 1. If region numbers, which stand for their playable area, are printed on your DVD video disc you do not find "1" or "ALL", disc playback will not be allowed by the player. (In this case, the DVD video player displays a message.)

Playable Discs

This DVD video player can play the following discs.

	Disc mark	Contents	Disc size	Maximum playback time
DVD video discs		Audio + Video (moving pictures)	12 cm	Approx. 4 hours (single sided disc)
			8 cm	Approx. 8 hours (double sided disc)
VIDEO CDs		Audio+ Video (moving pictures)	12 cm	Approx. 80 minutes (single sided disc)
			8 cm	Approx. 160 minutes (double sided disc)
Audio CDs		Audio	12 cm	Approx. 74 minutes
			8 cm (CD single)	Approx. 20 minutes

You cannot play discs other than those listed above.

This DVD video player uses the NTSC color system and cannot play DVD video discs recorded in any other color system (PAL, SECAM, etc.).

On VIDEO CDs

This DVD video player supports VIDEO CDs equipped with the PBC (Version 2.0) function. (PBC is the abbreviation of Playback Control.) You can enjoy two playback variations depending on types of discs.

- **VIDEO CD not equipped with PBC function (Version 1.1)**
Sound and movie can be played on this DVD video player in the same way as an audio CD.
- **VIDEO CD equipped with PBC function (Version 2.0)**

In addition to operation of a VIDEO CD not equipped with the PBC function, you can enjoy playback of interactive software with search function by using the menu displayed on the TV screen (Menu Playback). Some of the functions described in this owner's manual may not work with some discs.

Notes on Copyright

It is forbidden by law to copy, broadcast, show, broadcast on cable, play in public, and rent copyrighted material without permission.

DVD video discs are copy protected; and any recordings made from these discs will be distorted.

This product incorporates copyright protection technology that is protected by method claims of certain U.S. patents and other intellectual property rights owned by Macrovision Corporation and other rights owners. Use of this copyright protection technology must be authorized by Macrovision Corporation, and is intended for home and other limited viewing uses only unless otherwise authorized by Macrovision Corporation. Reverse engineering or disassembly is prohibited.

Before Calling Service Personnel

Check the following guide for the possible cause of a problem before contacting service.

Symptoms and Correction

Symptom	Cause	Correction	Page
No power	<ul style="list-style-type: none"> The power plug is disconnected. 	<ul style="list-style-type: none"> Connect the power plug securely into the wall outlet. 	12, 13
No picture	<ul style="list-style-type: none"> The TV is not set to receive DVD signal output. 	<ul style="list-style-type: none"> Select the appropriate video input mode on the TV so the picture from the DVD video player appears on the TV screen. 	16
	<ul style="list-style-type: none"> The video cable is not connected securely. 	<ul style="list-style-type: none"> Connect the video cable securely into the jacks. 	12, 13
No sound	<ul style="list-style-type: none"> The equipment connected with the audio cable is not set to receive DVD signal output. 	<ul style="list-style-type: none"> Select the correct input mode of the audio receiver so you can listen to the sound from the DVD video player. 	16
	<ul style="list-style-type: none"> The audio cable is not connected securely. 	<ul style="list-style-type: none"> Connect the audio cable securely into the jacks. 	12, 13, 14, 15
	<ul style="list-style-type: none"> The audio receiver or TV is turned off. 	<ul style="list-style-type: none"> Turn on the equipment connected with the audio cable. 	–
	<ul style="list-style-type: none"> The setting of output sound type is incorrect. 	<ul style="list-style-type: none"> Select the proper audio setting. 	29, 32, 38
The playback picture has occasional distortion.	<ul style="list-style-type: none"> The disc is dirty. 	<ul style="list-style-type: none"> Eject the disc and clean it. 	51
	<ul style="list-style-type: none"> It is in fast forward or fast reverse playback. 	<ul style="list-style-type: none"> Sometimes a small amount of picture distortion may appear. This is not a malfunction. 	–
Brightness is unstable or noise is noticeable in the playback pictures.	<ul style="list-style-type: none"> The copy protection is in effect. 	<ul style="list-style-type: none"> Connect the DVD video player directly to the TV. Avoid connecting the DVD video player to a VCR or TV/VCR combination. 	12
The DVD video player does not start playback.	<ul style="list-style-type: none"> No disc is inserted. 	<ul style="list-style-type: none"> Insert a disc. (Check that the DVD indicator or VIDEO CD/audio CD indicator in the DVD display is lit.) 	9
	<ul style="list-style-type: none"> An unplayable disc is inserted. 	<ul style="list-style-type: none"> Insert a playable disc. (Check the disc type and color system.) 	51
	<ul style="list-style-type: none"> The disc is placed upside down. 	<ul style="list-style-type: none"> Place the disc with the playback side down (label facing up). 	16
	<ul style="list-style-type: none"> The disc is not placed within the guide. 	<ul style="list-style-type: none"> Place the disc correctly inside the guide in the disc tray. 	16
	<ul style="list-style-type: none"> The disc is dirty. 	<ul style="list-style-type: none"> Clean the disc. 	51
	<ul style="list-style-type: none"> The parental lock function is set. 	<ul style="list-style-type: none"> Cancel the parental lock function or change the parental lock level. 	32, 44
A disc is not played according to its program.	<ul style="list-style-type: none"> It is in the repeat, random, or memory playback. 	<ul style="list-style-type: none"> These operations may prevent a proper progressing of the disc's contents. 	–
Buttons do not work.	<ul style="list-style-type: none"> Power supply fluctuations or other abnormalities such as static electricity may interrupt correct operations. 	<ul style="list-style-type: none"> Turn the power on or off with the POWER button. Or, disconnect the power plug and insert it into the wall outlet again. 	–
The remote control does not work properly.	<ul style="list-style-type: none"> The remote control is not pointed at the remote sensor of the DVD video player. 	<ul style="list-style-type: none"> Point the remote control at the remote sensor of the DVD video player. 	11
	<ul style="list-style-type: none"> The remote control is too far from the DVD video player. 	<ul style="list-style-type: none"> Operate the remote control within about 20 feet. 	11
	<ul style="list-style-type: none"> The batteries in the remote control are exhausted. 	<ul style="list-style-type: none"> Replace the batteries with new ones. 	11

Otros

Especificaciones

Reproductor de DVD / Salidas / Accesorios suministrados

[Reproductor de DVD]

Alimentación	120 V CA, 60 Hz
Consumo	19 W
Masa	3,6 kg
Dimensiones externas	430 x 81 x 300 mm (An/Al/Prf)
Sistema de señal	Normas NTSC
Láser	Longitud de onda del semiconductor de láser 650 nm
Gama de frecuencias	Sonido lineal de DVD: Muestreo de 48 kHz, 4 Hz a 22 kHz Muestreo de 96 kHz, 4 Hz a 44 kHz Disco CD de audio: 4 Hz a 20 kHz
Relación señal-ruido	Más de 112 dB
Gama dinámica de audio	Más de 112 dB
Distorsión armónica	Menos de 0,001 %
Fluctuación y trémolo	Inferiores al nivel mensurable (menos de $\pm 0,001$ %, ponderación de pico)
Condiciones de operación	Temperatura: 5 a 35 °C, Estado de operación: Horizontal

[Salidas]

Salida de video	1,0 V (p-p), 75 Ω , sincronismo negativo, toma de pines x 1
Salida de video S	(Y) 1,0 V (p-p), 75 Ω , sincronismo negativo, mini DIN-4-pines x 1 (C) 0,286 V (p-p), 75 Ω
Salida de diferencia de color	(Y) 1,0 V (p-p), 75 Ω , sincronismo negativo, toma de pines x 1 (Cb)/(Cr) 0,7 V (p-p), 75 Ω
Salida de audio (ÓPTICA)	Toma óptica x 1
Salida de audio (COAXIAL)	0,5 V (p-p), 75 Ω , toma de pines x 1
Salida de audio (MIXED OUT)	2,0 V (rms), 220 Ω , tomas de pines (L, R) x 1
Audio Output (5.1 CH SURROUND)	2,0 V (rms), 220 Ω , tomas de pines x 6
Toma para auriculares	32 Ω (10 mW), Impedancia; más de 8 Ω

[Accesorios suministrados]

Cable de video S	1
Cable de audio/video	1
Controlador remoto	1
Pilas (AA)	3

- El diseño y las especificaciones están sujetos a cambio sin previo aviso.

Philips Consumer Electronics Company Factory Service Center Locations

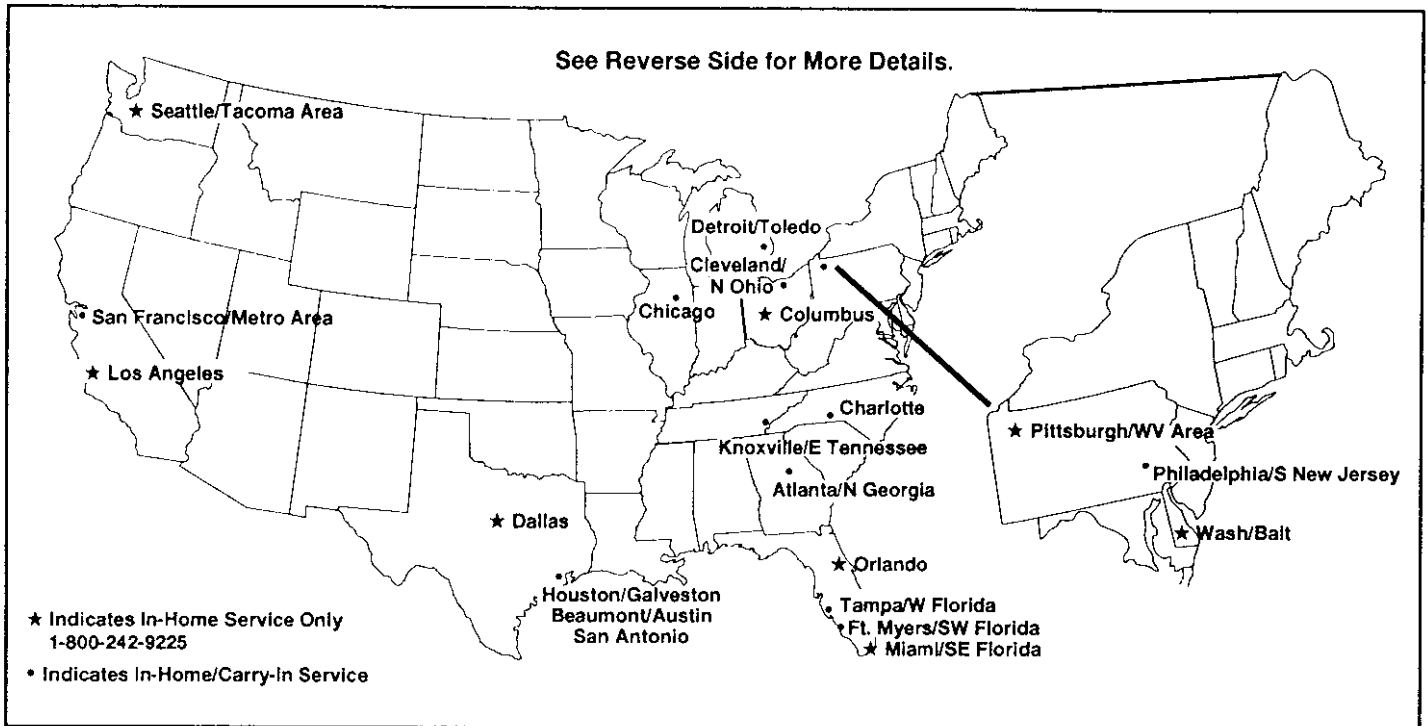

NOTE: If you reside in one of our Philips Factory Service Branch areas (see directory on back), you can contact the nearest Service Branch to obtain efficient and expedient repair for your product. If your product is In-Warranty, you should have proof-of-purchase to ensure No Charge Service. For Out-of-Warranty service, call the location nearest you.

NOTA: Si vous résidez dans une des régions desservies par une succursale de service après vente du fabricant Philips (voir liste ci-dessous), vous pourrez contacter la branche de service après vente la plus près de chez vous pour obtenir un service après vente rapide et efficace. Si le produit est sous garantie, il suffira de présenter une preuve d'achat pour bénéficier d'un service sans frais. Pour les produits non couverts par la garantie, contactez le centre le plus près de chez vous.

NOTA: Si Ud. reside en una de nuestras zonas para sucursales Philips de servicio al de fábrica (ver directorio más abajo), Ud. puede comunicarse con la sucursal de servicio más cercana para obtener una reparación oportuna y eficaz de su producto. Si su producto está todavía bajo garantía, Ud. debe presentar comprobante de compra para no ocasionar ningunos cargos por servicio. Para servicio después del vencimiento de la garantía, llame al lugar más cercano de los abajo indicados.

In Canada

How you can obtain efficient and expedient carry-in, mail-in, or in-home service for your product

Please contact Philips at
1-800-661-6162 (French speaking)
1-800-363-7278 (English speaking)

Au Canada

Comment obtenir le service après-vente pour les produits apportés ou envoyés par la poste à notre centre de service ou le service à domicile

Veillez contacter philips à:
1-800-661-6162 (Francophone)
1-800-363-7278

En el Canadá

Cómo recibir servicio eficiente para su producto, en persona, por correo o a domicilio

Favor de comunicarse con Philips al:
1-800-661-6162 (francófono)
1-800-363-7278 (anglófono)

QUALITY SERVICE IS AS CLOSE AS YOUR TELEPHONE! SIMPLY LOOK OVER THE LIST BELOW FOR THE NUMBER OF A FACTORY SERVICE CENTER NEAR YOU. YOUR PRODUCT WILL RECEIVE EFFICIENT AND EXPEDIENT CARRY-IN, MAIL-IN, OR IN-HOME SERVICE, AND YOU WILL RECEIVE PEACE OF MIND, KNOWING YOUR PRODUCT IS BEING GIVEN THE EXPERT ATTENTION OF PHILIPS' FACTORY SERVICE. AND, IF THE PHONE NUMBER LISTED FOR YOUR AREA IS LONG DISTANCE, CALL 1-800-242-9225 FOR FACTORY SERVICE.

COMMENT OBTENIR NOTRE SERVICE APRÈS VENTE RAPIDE ET EFFICACE SOIT PAR COURRIER, À DOMICILE, OU EN SE PRÉSENTANT À UN CENTRE DE SERVICE PHILIPS. PLUS DE 600 CENTRES DE RÉCEPTION DE PRODUITS À RÉPARER À TRAVERS LE PAYS: CONTACTER LE CENTRE DE SERVICE AUX CONSOMMATEURS LE PLUS PROCHE POUR SAVOIR L'EMPLACEMENT DE CES DÉPÔTS DANS UN RAYON DE 50 À 75 MILES (80 KM À 120 KM) DU CENTRE DE SERVICE LOCAL.

CÓMO OBTENER UN SERVICIO OPORTUNO Y EFICIENTE POR CORREO, EN CASA O EN PERSONA PARA SU PRODUCTO A TRAVÉS DE UN CENTRO PHILIPS DE SERVICIO. MAS DE 600 SITIOS POR TODO EL PAIS PARA LA RECEPCION DE PRODUCTOS NECESITADOS DE REPARACIONES: COMUNICARSE CON EL CENTRO DE SERVICIO DE FABRICA MAS CERCANO PARA ESTOS LUGARES DENTRO DE UN RADIO DE 50 A 75 MILLAS (80 A 75 MILLAS) DEL CENTRO DE SERVICIO LOCAL.

GEORGIA

Philips Factory Service of Georgia
200 N. Cobb Pkwy., Suite 120
Marietta, GA 30062
(770) 795-0085

FT. MYERS, FLORIDA

Philips Factory Service Satellite - Ft. Myers
11601 Cleveland Ave., Suite 15
Ft. Myers, FL 33907
(941) 278-4242

FLORIDA

Philips Factory Service of Florida
1911 US Highway 301 North
Tampa, FL 33619
(813) 621-8181

WESTERN U.S.A.

Philips Factory Service Western Region
681 East Brokaw Rd.
San Jose, CA 95112
(408) 436-8566

NORTH CAROLINA

Philips Factory Service of N. Carolina
520 G Clanton Rd.
Charlotte, NC 28217
(704) 529-6330

TEXAS

Philips Factory Service of Texas
1110 N. Post Oak Rd., Suite 100
Houston, TX 77055
(713) 682-3990

CENTRAL U.S.A.

Philips Factory Service Central US
950 Keynote Circle
Brooklyn Heights, OH 44131
(216) 741-3334

MICHIGAN

Philips Factory Service of Michigan
25173 Dequindre
Madison Heights, MI 48071
(248) 544-2110

ILLINOIS

Philips Factory Service of Illinois
1360 W. Hamilton Pkwy.
Itasca, IL 60143
(630) 775-0990

TENNESSEE

Philips Factory Service of East Tennessee
6700 D Papermill Rd.
Knoxville, TN 37919
(423) 584-6614

MID-ATLANTIC

Philips Factory Service Mid-Atlantic
352 Dunks Ferry Rd.
Bensalem, PA 19020
(215) 638-7500

LIMITED WARRANTY

DVD VIDEO PLAYER

90 Days Free Labor

One Year Exchange Warranty on Parts

This product must be carried in for repair.

WHO IS COVERED?

You must have proof of purchase to receive warranty service. A sales receipt or other document showing that you purchased the product is considered proof of purchase.

WHAT IS COVERED?

Warranty coverage begins the day you buy your product. For 90 days thereafter, all parts will be repaired or replaced, and labor is free. From 90 days to one year from the day of purchase, all parts will be repaired or replaced, but you pay for all labor charges. After one year from the day of purchase, you pay for the replacement or repair of all parts, and for all labor charges.

All parts, including repaired and replaced parts, are covered only for the original warranty period. When the warranty on the product expires, the warranty on all replaced and repaired parts also expires.

WHAT IS EXCLUDED?

Your warranty does not cover:

- labor charges for installation or setup of the product, adjustment of customer controls on the product, and installation or repair of antenna systems outside of the product.
- product repair and/or part replacement because of misuse, accident, unauthorized repair or other cause not within the control of Philips Consumer Electronics Company.
- reception problems caused by signal conditions or cable or antenna systems outside the unit.
- a product that requires modification or adaptation to enable it to operate in any country other than the country for which it was designed, manufactured, approved and/or authorized, or repair of products damaged by these modifications.
- incidental or consequential damages resulting from the product. (Some states do not allow the exclusion of incidental or consequential damages, so the above exclusion may not apply to you. This includes, but is not limited to, prerecorded material, whether copyrighted or not copyrighted.)
- a product that is used for commercial or institutional purposes (including but not limited to rental purposes).

WHERE IS SERVICE AVAILABLE?

Warranty service is available in all countries where the product is officially distributed by Philips Consumer Electronics Company. In countries where Philips Consumer Electronics Company does not distribute the product, the local Philips service organization will attempt to provide service (although there may be a delay if the appropriate spare parts and technical manual(s) are not readily available).

MAKE SURE YOU KEEP...

Please keep your sales receipt or other document showing proof of purchase. Attach it to this owner's manual and keep both nearby. Also keep the original box and packing material in case you need to return your product.

BEFORE REQUESTING SERVICE...

Please check your owner's manual before requesting service. Adjustments of the controls discussed there may save you a service call.

TO GET WARRANTY SERVICE IN U.S.A., PUERTO RICO OR U.S. VIRGIN ISLANDS...

Take the product to a Philips factory service center (see enclosed list) or authorized service center for repair. When the product has been repaired, you must pick up the unit at the center. Centers may keep defective parts.

(In U.S.A., Puerto Rico and U.S. Virgin Islands, all implied warranties, including implied warranties of merchantability and fitness for a particular purpose, are limited in duration to the duration of this express warranty. Because some states do not allow limitations on how long an implied warranty may last, this limitation may not apply to you.)

TO GET WARRANTY SERVICE IN CANADA...

Please contact Philips at:

1-800-661-6162 (French Speaking)

1-800-363-7278 (English Speaking)

(In Canada, this warranty is given in lieu of all other warranties. No other warranties are expressed or implied, including any implied warranties of merchantability or fitness for a particular purpose. Philips is not liable under any circumstances for any direct, indirect, special, incidental or consequential damages, howsoever incurred, even if notified of the possibility of such damages.)

REMEMBER...

Please record the model and serial numbers found on the product below. Also, please fill out and mail your warranty registration card promptly. It will be easier for us to notify you if necessary.

MODEL # _____

SERIAL # _____

This warranty gives you specific legal rights. You may have other rights which vary from state/province to state/province.

Philips Service Company, P.O. Box 555, Jefferson City, Tennessee 37760, (423) 475-8869