

TOSHIBA

Leading Innovation >>>

CAMILEO[®] AIR10

User's Guide

Regulatory Information

FCC Information FCC Information



Product Name: Camcorder

Model number: CAMILEO® AIR10

FCC notice “Declaration of Conformity Information”

This equipment has been tested and found to comply with the limits for a Class B digital device, pursuant to part 15 of the FCC rules. These limits are designed to provide reasonable protection against harmful interference in a residential installation. This equipment generates, uses and can radiate radio frequency energy and, if not installed and used in accordance with the instructions, may cause harmful interference to radio communications. However, there is no guarantee that interference will not occur in a particular installation. If this equipment does cause harmful interference to radio or television reception, which can be determined by turning the equipment OFF and ON, the user is encouraged to try to correct the interference by one or more of the following measures:

- ❖ Reorient or relocate the receiving antenna.
- ❖ Increase the separation between the equipment and receiver.
- ❖ Connect the equipment into an outlet on a circuit different from that to which the receiver is connected.
- ❖ Consult the dealer or an experienced radio/TV technician for help.

⚠ WARNING

Changes or modifications made to this equipment, not expressly approved by TOSHIBA or parties authorized by TOSHIBA could void the user's authority to operate the equipment.

FCC Conditions

This equipment has been tested and found to comply with Part 15 of the FCC Rules. Operation is subject to the following two conditions:

- (1) This device may not cause harmful interference.
- (2) This device must accept any interference received. Including interference that may cause undesired operation.

Contact

Address: TOSHIBA America Information Systems, Inc.
9740 Irvine Boulevard
Irvine, California 92618-1697
Telephone: (949) 583-3000

Safety Instructions

- 1 Do not drop, puncture or disassemble the camcorder; otherwise the warranty will be voided.
- 2 Avoid all contact with water, and dry hands before using.
- 3 Do not expose the camcorder to high temperature or leave it in direct sunlight. Doing so may damage the camcorder.
- 4 Use the camcorder with care. Avoid pressing hard on the camcorder body.
- 5 For your own safety, avoid using the camcorder when there is a storm or lightning.
- 6 Do not use a battery of different specifications. Doing so may lead to the potential for serious damage.
- 7 Remove the battery during long periods between usage, as a deteriorated battery may affect the functionality of the camcorder.
- 8 Remove the battery if it shows signs of leaking or distortion.
- 9 Use only the accessories supplied by the manufacturer.
- 10 Keep the camcorder out of the reach of infants.
- 11 Risk of explosion if battery is replaced by an incorrect type.
- 12 Dispose of used batteries according to the instructions.

About the battery

- ❖ Use only batteries recommended by TOSHIBA as replacements. The battery is a lithium ion battery, which can explode if not replaced, used, handled or disposed of properly. Dispose of the battery as required by local ordinances or regulations.
- ❖ Charge the battery only in an ambient temperature between 14 and 104 degrees Fahrenheit (-10 and 40 degrees Celsius). Otherwise, the electrolyte solution might leak, battery performance might deteriorate and the battery life might be shortened.
- ❖ Never install or remove the battery without first turning OFF the power and disconnecting the AC adaptor (AC adaptor may be sold separately) or mini USB cable (if used for charging).
- ❖ Only use the supplied Mini USB cable or AC adaptor (AC adaptor sold separately). Never attempt to charge the battery with any other charger.

Safety icons

This manual contains safety instructions that must be observed to avoid potential hazards that could result in personal injuries, damage to your equipment, or loss of data. These safety cautions have been classified according to the seriousness of the risk, and icons highlight these instructions as follows:

 DANGER

Indicates an imminently hazardous situation which, if not avoided, will result in death or serious injury.

 WARNING

Indicates a potentially hazardous situation which, if not avoided, could result in death or serious injury.

 CAUTION

Indicates a potentially hazardous situation which, if not avoided, may result in minor or moderate injury.

 CAUTION

Indicates a potentially hazardous situation which, if not avoided, may result in property damage.

NOTE

Provides important information.

Additional Information

© Copyright 2012 TOSHIBA CORPORATION. All rights reserved.

TOSHIBA reserves the right to make technical changes. TOSHIBA assumes no liability for damages incurred directly or indirectly from errors, omissions or discrepancies between this product and the documentation.

Trademarks

CAMILEO is a registered trademark of Toshiba America Information Systems, Inc. and/or Toshiba Corporation.

Adobe is either a registered trademark or trademark of Adobe Systems Incorporated in the United States and/or other countries.

ArcSoft and MediaImpression are registered trademarks of ArcSoft, Inc.

Facebook is a registered trademark of Facebook Inc.

HDMI, the HDMI Logo and High-Definition Multimedia Interface are trademarks or registered trademarks of HDMI Licensing, LLC.

Intel, Intel Core, Celeron, Centrino and Pentium are trademarks or registered trademarks of Intel Corporation or its subsidiaries in the United States and other countries.

Microsoft, Windows, and Windows Vista are either registered trademarks or trademarks of Microsoft Corporation in the United States and/or other countries.

Picasa is a trademark of Google Inc.

Secure Digital and SD are trademarks of SD Card Association.

Wi-Fi is a registered trademark of the Wi-Fi Alliance.

YouTube and the YouTube logo are registered trademarks of Google, Inc.

All other brand and product names are trademarks or registered trademarks of their respective companies.

Contents

Chapter 1: Getting to Know Your Camcorder.....	9
Overview	9
Check the Components	10
System Requirements	11
Front view	12
Underside view	12
Rear view	13
Chapter 2: Getting Started.....	14
Charging the battery	14
Charging the battery	16
Inserting and removing an SD™ Card (optional).....	21
Protecting data on an SD™ Card	22
Turning the camcorder on and getting started	22
Turning off the camcorder	22
Chapter 3: Record Mode.....	23
Button functions	23
LCD screen information	24
Notification icons	25
Video recording	26

Photo recording	27
Using Digital zoom.....	27
Menu options/operations	27
Video Setting options.....	28
Photo setting options.....	31
Effects.....	36
Chapter 4: Playback Mode.....	39
Button functions	39
LCD screen information	40
Notification icons	41
Playback mode operations	42
Video Playback.....	43
Photo Playback	43
Delete a file in Playback mode	44
Chapter 5: Camcorder Settings	45
Setup menu	45
Menu Sound	46
TV	46
Language	47
Time settings	47
Format	48
Default setting.....	49
Chapter 6: CAMILEO® AIR10 Connect.....	50
Advanced operations on your computer (CAMILEO® AIR10 Connect).....	50
Installing CAMILEO® AIR10 Connect	50
Using CAMILEO® AIR10 Connect via Wi-Fi® (Infrastructure mode)	52
Using CAMILEO AIR10 Connect via USB	55
Chapter 7: Wi-Fi® Functions.....	58
Uploading files to social networking sites.....	59
Broadcast live streaming on USTREAM	63

Chapter 8: Viewing Photos and Videos on TV	65
Connecting to a high-definition 16:9 (wide) TV	65
Installing bundled software	66
Chapter 9: Viewing Photos and Videos on a Computer	67
Transferring photos or videos to a computer	67
Chapter 10: Specifications	68
Operating Environment Conditions	69
Chapter 11: Troubleshooting	70
Chapter 12: Other Information	73
Toshiba Support	73
Before you call	73
Contacting Toshiba	74
Toshiba's technical support Web site	74
Toshiba voice contact	74
Warranty	74
Online Warranty Information	74
Warranty Service	74

Chapter 1

Getting to Know Your Camcorder

Overview

Your Toshiba camcorder comes equipped with a 5 Megapixel BSI CMOS sensor that can record H.264 format videos. This format allows for extended video recording with less memory.

Other features of your CAMILEO® AIR10 camcorder are:

- ❖ Built-in CAMILEO® AIR10 Connect application, allowing you to easily upload or stream videos captured by the camcorder to the Internet (for Windows® based systems only)
- ❖ High quality photos up to 16 Megapixels (interpolated)
- ❖ Color LCD screen for easy viewing of photos and videos
- ❖ Video recording at full HD resolution of 1920 x1080p
- ❖ HDTV connectivity via an HDMI® cable (HDMI® cable sold separately)
- ❖ Easy playback of recorded high-definition videos on wide screen HDTV
- ❖ ISO and white balance can be set to automatic or may be manually adjusted
- ❖ 5x digital zoom
- ❖ Webcam for video conferencing

10 Getting to Know Your Camcorder

Overview

- ❖ Limited built-in memory allowing you to take photos and to record videos without a memory card
- ❖ Memory card slot allowing users to increase storage capacity

Check the Components

Unpack the box and make sure all listed items below are included:

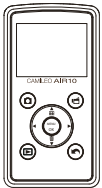

Camcorder

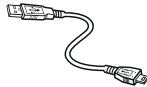

Mini USB cable

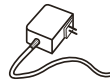

AC adaptor (may be sold separately)

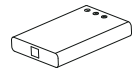

Lithium-ion rechargeable battery*



Quick Start Guide



CD-ROM
Software, User's Guide (this document), and Warranty information



Cleaning cloth



Hand strap

(Sample Illustration) Components

The CD-ROM supplied with the camcorder contains these software applications:

- ❖ CAMILEO® AIR10 Connect is a PC application that provides a simple and friendly platform to manage the files in the camcorder, and control the interaction with your camcorder via either WiFi or USB connection.
- ❖ ArcSoft MediaImpression is a user-friendly application that helps you manage your media, edit and playback video, and upload your files to websites easily.

*Preinstalled in the camcorder

NOTE

A portion of the built-in memory is used for firmware to operate the camcorder and is not available for storage.

System Requirements

- ❖ Microsoft® Windows® XP/Windows Vista®/Windows® 7
- ❖ Intel/AMD Dual-Core CPU or above
- ❖ 1 GB system memory
- ❖ 2 GB free HDD space
- ❖ 4x CD-ROM Drive
- ❖ Available USB 2.0 port
- ❖ 16-bit color display
- ❖ Wi-Fi® capability

NOTE The LCD screen is manufactured using extremely high-precision technology. However, some tiny black and/or bright dots (white, red, blue or green) may appear on the LCD screen. These dots are a normal result of the manufacturing process, and do not affect the recording.

12 Getting to Know Your Camcorder

Overview

Front view

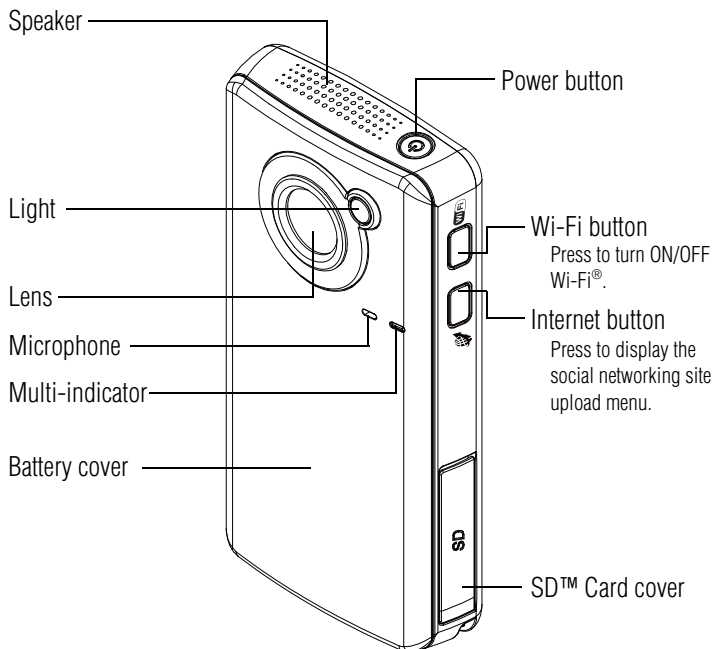

(Sample Illustration) Front view

For more detailed operational instruction, please see “Record Mode” on page 23 and “Playback mode operations” on page 42.

Underside view

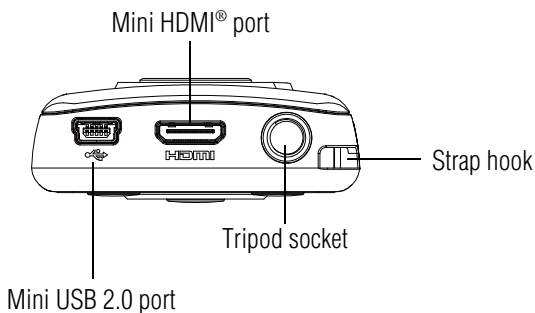

(Sample Illustration) Underside view

Rear view

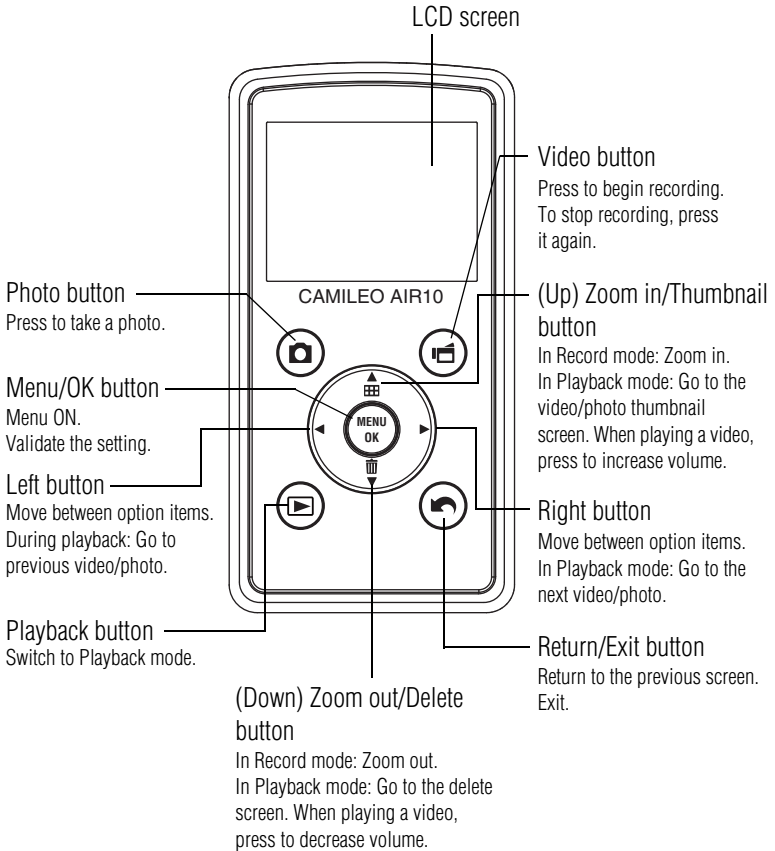

(Sample Illustration) Rear view

Chapter 2

Getting Started

Charging the battery

The battery comes pre-installed in the camcorder, and must be charged before use, however you must remove the protective film on the battery.

- 1 Slide the battery cover off.

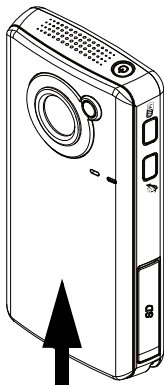

(Sample Illustration) Front view

- 2 Remove the battery.

- 3** Pull the protective film off.

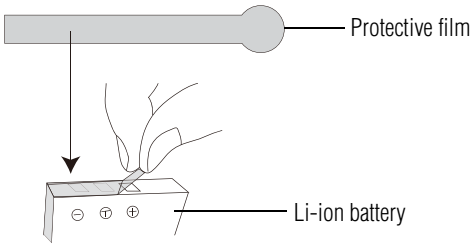

(Sample Illustration) Removing the protective film

- 4** Reinsert the battery face up, making sure it is lined-up with the correct polarity marks.

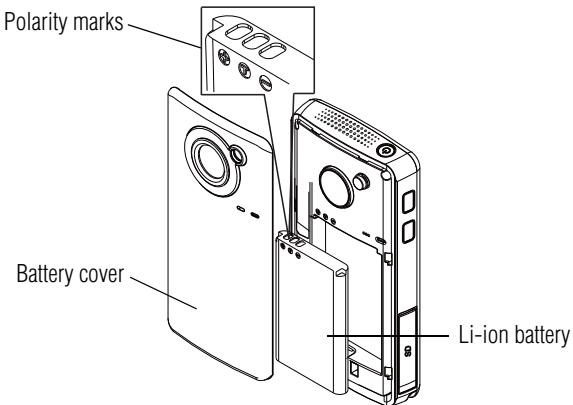

(Sample Illustration) Inserting the battery

- 5** Reinstall the battery cover.

16 Getting Started

Charging the battery

Charging the battery

You must use the supplied Mini USB cable or AC adaptor (AC adaptor may be sold separately) to charge your camcorder before use. Turn OFF the camcorder before connecting the cable. A blinking light indicates active charging and a solid light indicates that charging is complete.

In AC charging mode, the solid light will turn off automatically after a few minutes. It may take up to 8.5 hours to charge the battery via USB and up to 4 hours via AC adaptor. (Actual time may vary.)

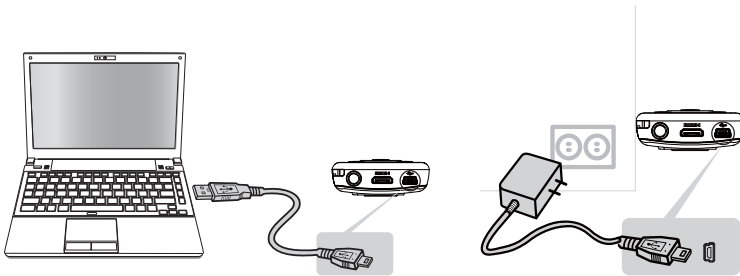

(Sample Illustration) Charging the battery

NOTE Be sure to remove the protective film on the lens before using.

▲ WARNING Handling of the battery

- ❖ Never attempt to dispose of a battery by burning or by throwing it into a fire, and never allow exposure to a heating apparatus (e.g., microwave oven). Heat can cause a battery to explode and/or release caustic liquid, both which may possibly cause serious injury.
 - ❖ Never attempt to disassemble, tamper with or repair a battery. The battery could overheat and ignite. Leakage of the caustic alkaline solution or other electrolytic substances could cause fire, possibly resulting in death or serious injury.
 - ❖ Never short-circuit the battery by either accidentally or intentionally bringing the battery terminals in contact with another conductive object. This could cause serious injury or a fire, and could also damage the battery and product. Always wrap the battery in plastic (or place it in a plastic bag) whenever transporting it, to avoid exposing the terminals to another conductive object which could result in serious injury. Always cover the metal terminals with insulating tape when disposing of the battery, to prevent accidental short-circuiting which could result in serious injury.
 - ❖ Never drive a nail or any other sharp object into the battery, hit battery with a hammer or other object or step on it. Doing so could cause a fire or explosion possibly resulting in serious injury.
 - ❖ Never charge the battery by a method other than as instructed. Doing so could cause a fire or explosion possibly resulting in serious injury.
 - ❖ Never connect the battery to a plug socket or a car cigarette plug socket. The battery could rupture or ignite causing a fire or explosion possibly resulting in serious injury.
 - ❖ Never allow a battery to become wet. A wet battery will overheat or ignite causing rupture or fire, possibly resulting in death or serious injury.
 - ❖ Never store a battery in an area of high humidity. This could cause a fire or explosion possibly resulting in serious injury.
-

18 Getting Started

Charging the battery

▲ WARNING

- ❖ Never expose a battery to abnormal shock, vibration or pressure. Never use a battery which has been exposed to abnormal shock even if the appearance is normal. The battery's internal protective device could fail, causing it to overheat or ignite resulting in caustic liquid leakage, or explosion or fire, possibly resulting in death or serious injury.
- ❖ Never subject a battery to heat, and never store it or use it near a heat source. The battery could ignite or explode when heated or burned, possibly resulting in death or serious injury. Subjecting a battery to heat could also cause caustic liquid to leak. It can also cause failure, malfunction, or loss of stored data.

Use of correct battery

- ❖ Always use the battery supplied. Other batteries have different voltage and terminal polarities. Use of non-conforming batteries could generate smoke or cause fire or rupture, possibly resulting in serious injury.
-

▲ WARNING

Battery safety

- ❖ Never allow caustic electrolyte fluid leaked from the battery to contact your eyes, body or clothing.
Use appropriate protective gloves when handling a damaged battery.
If caustic electrolyte fluid from the battery should contact your eyes, immediately wash your eyes with large amounts of running water and obtain prompt medical attention, to help prevent permanent eye damage.
If electrolyte fluid should contact any part of your body, immediately wash it off under running water to help prevent skin rashes.
If electrolyte fluid should contact your clothes, promptly remove them to help prevent the electrolyte fluid from contacting your body, possibly resulting in serious injury.
-

▲ WARNING **Battery warning indicators**

- ❖ Always immediately turn the power OFF and disconnect the power cable/cord plug from the plug socket and stop using the battery if you observe any of the following conditions:
 - ❖ Offensive or unusual odor
 - ❖ Excessive heat
 - ❖ Discoloration
 - ❖ Deformation, cracks or leaks
 - ❖ Smoke
 - ❖ Other unusual event during use, such as abnormal sound

In such an event, carefully and immediately remove the battery from the product. In some instances, you might have to wait for the product to cool down before removing the battery, in order to avoid any possible minor injury due to heat exposure. Do not turn on the product's power again until an authorized Toshiba service provider has checked it for safety. Continued use could cause a fire or rupture possibly resulting in serious injury or product failure including but not limited to the loss of data.

▲ WARNING **Disposal of used batteries**

- ❖ Always dispose of used batteries in compliance with all applicable laws and regulations. Put insulating tape, such as cellophane tape, on the electrode during transportation to avoid a possible short circuit, fire or electric shock. Failure to do so could possibly result in serious injury.
-

▲ WARNING

- ❖ Make sure the battery is securely installed in the product before attempting to charge the battery.
 - ❖ Improper installation could generate smoke or fire, or cause the battery to rupture.
-

20 Getting Started

Charging the battery

- ▲ CAUTION**
- ❖ The battery is a lithium ion battery, which can explode if not replaced, used, handled or disposed of properly. Dispose of the battery as required by local ordinances or regulations. Use only batteries recommended by TOSHIBA as replacements.
 - ❖ Charge the battery only in an ambient temperature between 14 and 104 degrees Fahrenheit (-10 and 40 degrees Celsius). Otherwise, the electrolyte solution might leak, battery performance might deteriorate and the battery life might be shortened.
 - ❖ Never install or remove the battery without first turning OFF the power and disconnecting the AC adaptor (AC adaptor may be sold separately).
-
-

▲ CAUTION **Inserting the battery**

- ❖ When installing a battery or before moving the product, always make sure the battery is inserted correctly and securely. If the battery falls out, while you are carrying the product, you could be injured or the battery could be damaged.
-
-

CAUTION **Do not use an impaired or exhausted battery**

- ❖ Never continue to use a battery after its recharging capability has become impaired, or after the warning message indicating that the battery power is exhausted has been displayed.
Continued use of an exhausted or impaired battery could result in the loss of data or damage to the product.
-
-

NOTE

Handling of the battery

- ❖ Never attempt to install batteries in reverse polarity.
-
-

Inserting and removing an SD™ Card (optional)

NOTE An SD™ Card must be purchased separately.

Your camcorder comes with internal memory that allows you to store limited photos and videos. You can expand the memory capacity by using an optional SD/SDHC/SDXC memory card.

- 1 Open the SD™ Card cover.
- 2 Insert the SD™ Card into the slot until it locks into place, as shown below.
- 3 Once inserted, close the SD™ Card cover.

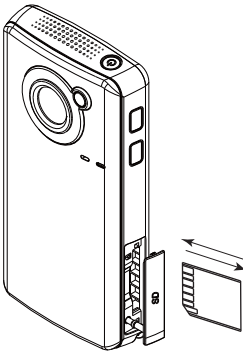

To remove the SD™ Card, press inward to release it. When the card pops out, grasp it and pull it straight out.

(Sample Illustration) Inserting and removing an SD™ Card

NOTE When a memory card is inserted, videos and photos are saved to the card rather than the built-in memory.

Protecting data on an SD™ Card

Photos or videos cannot be recorded on an SD™ Card when the card is locked (read only), however photos and videos can be viewed.

Make sure the lock is in the writeable position before recording photos and videos as shown below.

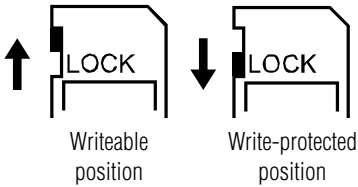

(Sample Illustration) Protecting data on an SD™ Card

Turning the camcorder on and getting started

To turn ON the camcorder, press the Power (⏻) button for approximately one second.

To record videos: In Record mode, press the Video button. Press it again to stop recording.

To take a photo: In Record mode, press the Photo button.

To view recorded videos/photos: Press the Playback button.





Turning off the camcorder

Press the Power (⏻) button for approximately one second to turn the camcorder OFF.

Chapter 3

Record Mode

Button functions

	Video button: 1 Press to begin recording. 2 Press it again to stop recording.
	Photo button: Press to take a photo.
	Playback button: Switch between Record/Playback mode.
	Return/Exit button: 1 Return to the previous screen. 2 Exit.

24 Record Mode

LCD screen information

	<p>Zoom in (Up) button:</p> <ol style="list-style-type: none">1 Zoom in.2 Move between option items. <p>Zoom out (Down) button:</p> <ol style="list-style-type: none">1 Zoom out.2 Move between the option items. <p>Left button: Move between the option items.</p> <p>Right button: Move between the option items.</p> <p>Menu/OK button:</p> <ol style="list-style-type: none">1 Menu ON.2 Validate the setting.
	<p>Power button: Press for approximately one second to turn the camcorder ON/OFF.</p>

















LCD screen information

The indicators shown on the image below may appear on the LCD screen when videos and photos are recorded:







(Sample Image) LCD screen indicators

Notification icons

1		Battery: Full power
		Battery: Medium power
		Battery: Low power
		Battery: No power
		AC power mode
2	Video Resolution	
		Full HD (1080p 30)
		HD60 (720p 60)
		HD30 (720p 30)
		VGA (430p 30)
	Photo resolution	
		High-16MP
		Standard-5MP
		Low-3MP
3		Digital light ON
		Light ON
4	Video Record mode	
		Stabilization ON
	Photo Record mode	
		Self-timer ON
5		Wi-Fi® signal strength

26 Record Mode

Video recording

6	00:03:12	Recording time remaining
	00:00:12 	Pause Recording
	 25	The remaining amount of photos that can be taken at the current resolution settings
	▲ 12	Current number of photos taken
	NOTE: Maximum number of photos shown is 9999; however, more photos may be recorded.	
7		Motion Detection (Video Record mode only)
8		Zoom meter: 1x~5x (5x Digital zoom)

NOTE Filter: Black & White/Classic/Negative can be previewed immediately without the indicator on the LCD screen.

Video recording

In Record mode, press the Video () button to start recording. A time indicator displays on the LCD screen when a video is being recorded. Press the Video button again to stop recording.

Press the Playback button to view a recorded video.

The resolution settings available are:









Video Quality	
	Full HD 1080/30: 1920 x 1080p 30/fps
	HD 720/60: 1280 x 720p 60/fps
	HD 720/30: 1280 x 720p 30/fps
	VGA 480/30: 640 x 480p 30/fps

Photo recording

In Record mode, press the Photo () button to take a photo.

Press the Playback button to view the photo.

The resolution settings available are:





Image Quality	
	High-16 MP: 4608 x 3456
	Standard-5 MP: 2592 x 1944
	Low-3 MP: 2048 x 1536

Using Digital zoom

Digital zoom magnifies images when recording videos or while taking photos.

To zoom in/out, press the (Up) Zoom in/(Down) Zoom out buttons. The digital zoom ranges from 1x to 5x.

Menu options/operations

Video Setting 	Photo Setting 	Effects 	Setup* 	Wi-Fi® 
Light	Light	Scene	Menu Sound	Available Networks (List)
Resolution	Resolution	Filter	TV	
Stabilization	Self-Timer	White Balance	Language	
Motion Detect	Face Tracking		Time Setting	
Continuous Play	Date Printing		Format	
	ISO		Default Setting	
	Slideshow			

*Please see “[Camcorder Settings](#)” on page 45 or “[Wi-Fi® Functions](#)” on page 58 for more information about Setup.

28 Record Mode

Menu options/operations



Operation	Screen
<p>1 In Record mode, Press the MENU/OK button. The Menu screen appears. The options available are: Video Setting, Photo Setting, Effects, Setup, and Wi-Fi.</p>	
<p>2 Use the Directional buttons to select the desired option, and then press the OK button to enter the settings menu.</p> <p>3 Use the Directional buttons to select the specific option you want to change.</p> <p>4 Press the OK button to validate the new setting.</p> <p>5 Select the Return/Exit (⏪) icon, and then press the OK button, or press the Return/Exit button to exit.</p>	

Video Setting options

Operation	Screen
<p>1 In Record mode, Press the MENU/OK button. The Menu screen appears.</p> <p>2 Use the Directional buttons to select the Video Setting icon, and then press the OK button to enter the settings menu.</p> <p>3 The Video Setting menu options are: Light, Resolution, Stabilization, Motion Detect, and Continuous Play.</p>	

Light





In this option select a mode to brighten the shooting area or to extend the brightness of objects. The Light settings available are:

	ON	Turns the light ON, providing illumination when recording.
	OFF	Turns the light OFF.
	Digital Light	Extends the dynamic range of high contrast and backlight, so objects appear brighter and clearer.

Operation	Screen
<ol style="list-style-type: none"> 1 In the Video Setting menu, select the Light icon, and then press the OK button to enter the settings menu. 2 Use the Directional buttons to select the desired option. 3 Press the OK button to validate the new setting. 4 Select the Return/Exit (⏪) icon, and then press the OK button, or press the Return/Exit button to exit. 	

Resolution



The Resolution settings available are:

	Full HD 1080/30	Records videos at 1920 x 1080p 30/fps resolution.
	HD 720/60	Records videos at 1280 x 720p 60/fps resolution.
	HD 720/30	Records videos at 1280 x 720p 30/fps resolution.
	VGA 480/30	Records videos at 640 x 480p 30/fps resolution.

Operation	Screen
<ol style="list-style-type: none"> 1 In the Video Setting menu, select the Resolution icon, and then press the OK button to enter the settings menu. 2 Use the Directional buttons to select the desired option. 3 Press the OK button to validate the new setting. 4 Select the Return/Exit (⏪) icon, and then press the OK button, or press the Return/Exit button to exit. 	



Stabilization

Your camcorder provides a feature that steadies the image to help reduce blurry photos and create clearer videos.

Operation	Screen
<ol style="list-style-type: none">1 In the Video Setting menu, select the Stabilization icon, and then press the OK button to enter the settings menu.2 Use the Directional buttons to select the desired option.3 Press the OK button to validate the new setting.4 Select the Return/Exit () icon, and then press the OK button, or press the Return/Exit button to exit.	

Motion detection

This option allows the camcorder to automatically record videos when the camcorder detects movement.

Operation	Screen
<ol style="list-style-type: none">1 In the Video Setting menu, select the Motion Detect icon, and then press the OK button to enter the settings menu.2 Use the Directional buttons to select the desired option.3 Press the OK button to validate the new setting.4 Select the Return/Exit () icon, and then press the OK button, or press the Return/Exit button to exit. <p>The camcorder will begin recording automatically if movement is detected. It stops recording when movement stops.</p>	

Continuous Play

This option allows you to playback files continuously.





Operation	Screen
<ol style="list-style-type: none"> 1 In the Video Setting menu, select the Continuous Play icon, and then press the OK button to enter the settings menu. 2 Use the Directional buttons to select the desired option. 3 Press the OK button to validate the new setting. 4 Select the Return/Exit () icon, and then press the OK button, or press the Return/Exit button to exit. 	

Photo setting options

Operation	Screen
<ol style="list-style-type: none"> 1 In Record mode, press the MENU/OK button. The Menu screen appears. 2 Use the Directional buttons to select the Photo Setting icon, and then press the OK button to enter the settings menu. The Photo Setting menu appears. 3 The Photo Setting menu options are: Light, Resolution, Self-Timer, Face Tracking, Date Printing, ISO, and Slideshow. 	

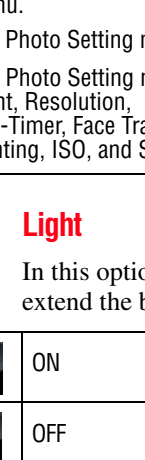
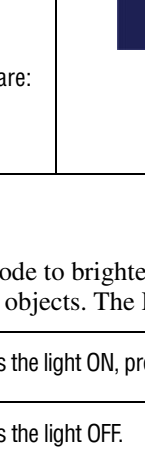
Light

In this option select a mode to brighten the shooting area or to extend the brightness of objects. The Light settings available are:

	ON	Turns the light ON, providing illumination when recording.
	OFF	Turns the light OFF.
	Digital Light	Extends the dynamic range of high contrast and backlight, so objects appear brighter and clearer.



32 Record Mode

Menu options/operations

Operation	Screen
<ol style="list-style-type: none"> 1 In the Photo Setting menu, select the Light icon, and then press the OK button to enter the settings menu. 2 Use the Directional buttons to select the desired option. 3 Press the OK button to validate the new setting. 4 Select the Return/Exit (⏪) icon, and then press the OK button, or press the Return/Exit button to exit. 	

Resolution

The Resolution settings available are:

	High-16M	Takes photos at 4608 x 3456, 16 MP quality.
	Standard-5M	Takes photos at 2592 x 1944, 5 MP quality.
	Low-3M	Takes photos at 2048 x 1536, 3 MP quality.

Operation	Screen
<ol style="list-style-type: none"> 1 In the Photo Setting menu, select the Resolution icon, and then press the OK button to enter the settings menu. 2 Use the Directional buttons to select the desired option. 3 Press the OK button to validate the new setting. 4 Select the Return/Exit (⏪) icon, and then press the OK button, or press the Return/Exit button to exit. 	

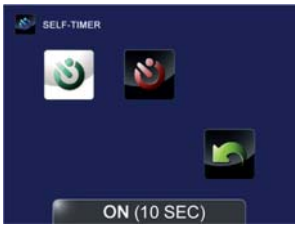

Self timer

The self-timer allows you to take photos with a ten-second time delay. The self-timer light on the front of the camcorder blinks to indicate the feature is activated. The blinking speed increases just before the photo is taken.

Operation	Screen
<ol style="list-style-type: none"> 1 In the Photo Setting menu, select the Self-Timer icon, and then press the OK button to enter the settings menu. 2 Use the Directional buttons to select the desired option. 3 Press the OK button to validate the new setting. 4 Select the Return/Exit () icon, and then press the OK button, or press the Return/Exit button to exit. 	



Face Tracking

The camcorder detects and focuses on face(s) automatically. This function works in Photo mode to capture portraits in backlit conditions.

Operation	Screen
<ol style="list-style-type: none"> 1 In the Photo Setting menu, select the Face Tracking icon, and then press the OK button to enter the settings menu. 2 Use the Directional buttons to select the desired option. 3 Press the OK button to validate the new setting. 4 Select the Return/Exit () icon, and then press the OK, or press the Return/Exit button to exit. 	
<p>In Photo mode, when the camcorder is aimed at face(s), the face frame(s) appear on the screen.</p>	



Date Printing



With this option, you can imprint the date on each photo.

Operation	Screen
<ol style="list-style-type: none"> 1 In the Photo Setting menu, select the Date Printing icon, and then press the OK button to enter the settings menu. 2 Use the Directional buttons to select the desired option. 3 Press the OK button to validate the new setting. 4 Select the Return/Exit () icon, and then press the OK button, or press the Return/Exit button to exit. 	
<p>When this function is activated, the date appears on the corner of each photo.</p>	

ISO

The camcorder automatically adjusts the ISO setting of images. Two manual ISO sensitivity settings are also available (800 and 1600). Use the higher setting to take a photo in the dark or in a poorly lit location, or for a subject moving at a high rate of speed.





	Auto	Sets the ISO setting automatically according to conditions.
	800	ISO 800
	1600	ISO 1600



Operation	Screen
<ol style="list-style-type: none"> 1 In the Photo Setting menu, select the ISO icon, and then press the OK button to enter the settings menu. 2 Use the Directional buttons to select the desired option. 3 Press the OK button to validate the new setting. 4 Select the Return/Exit () icon, and then press the OK button, or press the Return/Exit button to exit. 	

NOTE The image may become grainy with a higher ISO setting.

Slideshow

Photos can be viewed one after another in a slideshow in a chosen interval of time. The Slideshow settings available are:

	2 seconds	Displays one photo every two seconds.
	5 seconds	Displays one photo every five seconds.
	10 seconds	Displays one photo every ten seconds.
	OFF	Disables Slideshow.





Operation	Screen
<ol style="list-style-type: none"> 1 In the Photo Setting menu, select the Slideshow icon, and then press the OK button to enter the settings menu. 2 Use the Directional buttons to select the desired option. 3 Press the OK button to validate the new setting. 4 Select the Return/Exit () icon, and then press the OK button, or press the Return/Exit button to exit. 	



Effects

Operation	Screen
<ol style="list-style-type: none"> 1 In Record mode, Press the MENU/OK button. The Menu screen appears. 2 Use the Directional buttons to select the Effects icon, and then press the OK button to enter the settings menu. The Effects menu appears. 3 The Effects menu options are: Scene, Filter, and White Balance. 	

Scene

You can select a mode according to the scene and conditions. The Scene settings available are:

	Auto	Automatically adjusts to current conditions.
	Skin	Adjusts skin tones to appear more natural.
	Night	Use in low light conditions or at night.
	Backlight	Use when the subject is brightly lit from behind.





Operation	Screen
<ol style="list-style-type: none"> 1 In the Effects Setting menu, select the Scene icon, and then press the OK button to enter the settings menu. 2 Use the Directional buttons to select the desired option. 3 Press the OK button to validate the new setting. 4 Select the Return/Exit () icon, and then press the OK button, or press the Return/Exit button to exit. 	

NOTE

To avoid blurry photos when taking photos in Night mode, place the camcorder on a flat, steady surface, or use a tripod.

Filter

You can select a special filter effect for videos and photos. The Filter settings available are:

	Auto	No filter effects.
	Black & White	The image is converted to black and white.
	Classic	The image is converted to sepia.
	Negative	The image is converted to a negative of the original.





Operation	Screen
<ol style="list-style-type: none"> 1 In the Effects Setting menu, select the Filter icon, and then press the OK button to enter the settings menu. 2 Use the Directional buttons to select the desired option. 3 Press the OK button to validate the new setting. 4 Select the Return/Exit (⏪) icon, and then press the OK button, or press the Return/Exit button to exit. 	



NOTE

Scene/Filter: B/W / Classic / Negative effect can be previewed immediately without icons appearing on the LCD screen.

White Balance

The camcorder adjusts the white balance of images automatically. The White Balance settings available are:

	Auto	Automatically adjusts white balance.
	Daylight	Use in outdoor conditions.
	Fluorescent	Use in Fluorescent lighting.
	Tungsten	Use in tungsten lighting.





Operation	Screen
<ol style="list-style-type: none"> 1 In the Effects Setting menu, select the White Balance icon, and then press the OK button to enter the settings menu. 2 Use the Directional buttons to select the desired option. 3 Press the OK button to validate the new setting. 4 Select the Return/Exit () icon, and then press the OK button, or press the Return/Exit button to exit. 	

Chapter 4

Playback Mode

Button functions

The buttons have the following functions in Playback mode.

	Video button: Press to switch to Video Playback mode.
	Photo Button: Press to switch to Photo Playback mode.
	Playback button: Switch between Record/Playback mode.
	Return/Exit button: 1 Return to the previous screen. 2 Exit.



40 Playback Mode

LCD screen information

	<p>Up button:</p> <ol style="list-style-type: none">1 View the video/photo thumbnail screen.2 Press to increase volume during video playback. <p>Down button:</p> <ol style="list-style-type: none">1 View the Delete screen.2 Press to decrease volume during video playback. <p>Left button:</p> <p>View the previous video/photo.</p> <p>Right button:</p> <p>View the next video/photo.</p> <p>Menu/OK button:</p> <p>Press to play/pause a video.</p>
---	---

LCD screen information















The indicators shown below may appear on the LCD screen while in Playback mode:

Onscreen notification icons	
	

(Sample Image) Video playback

(Sample Image) Photo playback

Notification icons

1		Battery: Full power
		Battery: Medium power
		Battery: Low power
		Battery: No power
		AC power mode.
2	Video Resolution	
		Full HD (1080p 30)
		HD60 (720p 60)
		HD30 (720p 30)
		VGA (430p 30)
	Photo resolution	
		High-16MP
		Standard-5MP
		Low-3MP
3		Wi-Fi® signal strength
4	00:03:12	Playback time counter.
	▲ 12	Current number of photos taken.
	▼ 25	The remaining amount of photos that can be taken at the current resolution settings.
	NOTE: Maximum number of photos shown is 9999; however, more photos may be recorded.	
5		Volume control.
6	2/2	Current number/Total number of videos.

42 Playback Mode

Playback mode operations

Playback mode operations

To view and manage videos and photos in the built-in memory or on an SD™ Card, use the Playback mode.

Operation	Screen
<p>1 In Video/Photo Record mode, press the Playback button to switch to Video/Photo Playback mode.</p>	
<p>2 Press the Up button to view the video/photo thumbnail screen.</p>	
<p>3 Select the video/photo file, and then press the OK button.</p> <p>4 Or press the Playback button to exit.</p>	

Video Playback











Operation	Screen
<ol style="list-style-type: none"> 1 In Video Playback mode, press the OK button to play or pause the video. 2 Use the Right/Left buttons to view the next/previous video. 3 While playing a video, press the Right/Left buttons to fast forward/rewind. 4 Press the OK button to stop. 5 Use the Up/Down buttons to adjust the volume. 6 Press the Internet button to select and tag the current video to upload to the Internet (for Windows® based systems only). 	

Photo Playback

Operation	Screen
<ol style="list-style-type: none"> 1 In Photo Playback mode, use the Right/Left buttons to view the next/previous photo. 2 Press the OK button to pause the slideshow. 3 Press the Internet button to select the current photo to upload to the Internet (for Windows® based systems only). 	

Delete a file in Playback mode

Operation	Screen
<ol style="list-style-type: none">1 In Playback mode, press the Down button to view the delete screen.2 Select the  icon, and then select the  icon to delete the current video/photo.3 Select the Return/Exit  icon, and then press the OK button, or press the Return/Exit button to cancel and exit.	
<ol style="list-style-type: none">4 Select the  icon, and then select the  icon to delete all video/photo files.5 Select the Return/Exit  icon, and then press the OK button, or press the Return/Exit button to cancel and exit.	

NOTE

- ❖ When an SD™ Card is installed, only the videos and photos stored on the card are deleted.
- ❖ Videos or photos cannot be deleted if the card is write-protected.

Chapter 5



Camcorder Settings

Setup menu

Operation	Screen
<ol style="list-style-type: none"><li data-bbox="129 794 512 874">1 In Record mode, press the MENU/OK button. The Menu screen appears.<li data-bbox="129 882 512 978">2 Use the Directional buttons to select the Setup (🔊) icon, and then press the OK button to enter the settings menu.<li data-bbox="129 986 512 1114">3 The Setup Menu options are: Menu Sound (operation sound), TV, Language, Time Setting, Format, Default Setting, and Information (scroll down to view).	

Menu Sound

You can enable or disable tone and operation sounds.



Operation	Screen
<ol style="list-style-type: none"> 1 In the Setup menu, select the Menu Sound icon, and then press the OK button to enter the settings menu. 2 Use the Directional buttons to select the desired option. 3 Press the OK button to validate the new setting. 4 Select the Return/Exit () icon, and then press the OK button, or press the Return/Exit button to exit. 	

TV

Use this function to select the appropriate TV standard for your area, either NTSC or PAL.

An incorrect TV system setting may cause the image to flicker.

	NTSC (60Hz)	USA, Canada, Japan, South Korea, Taiwan, etc.
	PAL (50Hz)	UK, Europe, China, Australia, Singapore, Hong Kong, etc.



Operation	Screen
<ol style="list-style-type: none"> 1 In the Setup menu, select the TV icon, and then press the OK button to enter the settings menu. 2 Use the Directional buttons to select the desired option. 3 Press the OK button to validate the new setting. 4 Select the Return/Exit () icon, and then press the OK button, or press the Return/Exit button to exit. 	

Language

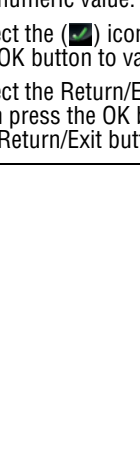
Use this option to select the language of the user interface.

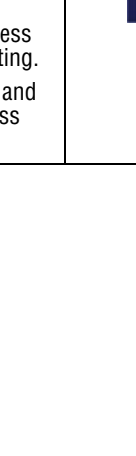

Operation	Screen
<ol style="list-style-type: none"> 1 In the Setup menu, select the Language icon, and then press the OK button to enter the settings menu. 2 Use the Directional buttons to select the desired option. 3 Press the OK button to validate the new setting. 4 Select the Return/Exit () icon, and then press the OK button, or press the Return/Exit button to exit. 	 <p>The screenshot shows a dark blue menu titled 'LANGUAGE'. It contains five square icons with national flags: Philippines, Denmark, Germany, United Kingdom, and the United States. A small white triangle points to the right at the bottom right of the menu.</p>

Time settings

Operation	Screen
<ol style="list-style-type: none"> 1 In the Setup menu, select the Time Setting icon, and then press the OK button to enter the settings menu. 2 Use the Right/Left buttons to select the Year, Month, Day, Hour, or Minute. 3 Use the Up/Down buttons to adjust the numeric value. 4 Select the () icon, and then press the OK button to validate the setting. 5 Select the Return/Exit () icon, and then press the OK button, or press the Return/Exit button to exit. 	 <p>The screenshot shows a dark blue menu titled 'TIME SETTING'. It features a large central display showing the date '19 / 01 / 2011' and the time '07 : 00 pm'. To the right of the display are two square icons: a green checkmark and a green Return/Exit icon.</p>

Format

Use this option to delete all data in the built-in memory or on the SD™ Card.

	Yes	Delete all videos and photos in the built-in memory (when no SD™ Card is installed), or delete all videos and photos on the installed SD™ Card.
	No	Do not delete all videos and photos in the built-in memory (when no SD™ Card is installed), or do not delete all videos and photos on the installed SD™ Card.

Operation	Screen
<ol style="list-style-type: none">1 In the Setup menu, select the Format icon, and then press the OK button to enter the settings menu.2 Use the Directional buttons to select the desired option.3 Press the OK button to validate the new setting.4 Select the Return/Exit (⏪) icon, and then press the OK button, or press the Return/Exit button to exit.	

CAUTION



All data will be erased if the SD™ Card is formatted. Make sure all data is copied to your computer or other media before formatting the SD™ Card.



NOTE

SD™ Card cannot be formatted if the card is write-protected.

Default setting

To restore the default factory setting, select this option.

	Yes	Restore to default factory setting.
	No	Do not restore to default factory setting.

Operation	Screen
<ol style="list-style-type: none"> In the Setup menu, select the Default Setting icon, and then press the OK button to enter the settings menu. Choosing Yes performs the operation, and No cancels the operation. Select the Return/Exit () icon, and then press the OK button, or press the Return/Exit button to exit. 	

The following table lists the camcorder's default settings:

Setting	Default Factory Setting
Resolution	Video: Full HD 1080/30 Photo: Standard-5M
Light	OFF
Stabilization	ON
Motion Detection	OFF
Continuous Play	OFF
Self-Timer	OFF
Face Tracking	OFF
Date Printing	OFF
ISO	Auto
Slideshow	OFF
Scene	Auto
Filter	Auto
White Balance	Auto
Menu Sound	ON
TV	NTSC
Language	English
Volume	Level 3

Chapter 6

CAMILEO® AIR10 Connect

Advanced operations on your computer (CAMILEO® AIR10 Connect)

The camcorder can connect to your computer via Wi-Fi® or USB connection. Once you launch the CAMILEO® AIR10 Connect application (for Windows® based systems only) on your computer, it searches for your camcorder and connects to it. (The camcorder must be turned ON and connected to the same access point ) You can then operate more functions on your computer:

- ❖ Transfer files from the camcorder
- ❖ Watch live streaming video from the camcorder on your computer
- ❖ Use the camcorder as a wireless webcam for online video chatting
- ❖ Configure your account information on social networking sites and save them to the camcorder
- ❖ Synchronize your Wi-Fi® profile with your camcorder and set up a security password to open the CAMILEO® AIR10 Connect application via Wi-Fi® connection

Installing CAMILEO® AIR10 Connect

To connect to the camcorder and launch the CAMILEO® AIR10 Connect application via Wi-Fi® correctly, you will need to first

install this program. It is a perfect platform to watch live streaming video from your camcorder and use the camcorder as a webcam for your online video chatting. The application also facilitates the configuration of the Wi-Fi® profiles and your social networking site account information.

Follow the steps below to install the CAMILEO® AIR10 Connect application on the computer. The program pack is bundled in the camera and on the CD as backup.

To install the bundled software from the camcorder:

- 1** Connect the camcorder to your computer via the included Mini USB cable.

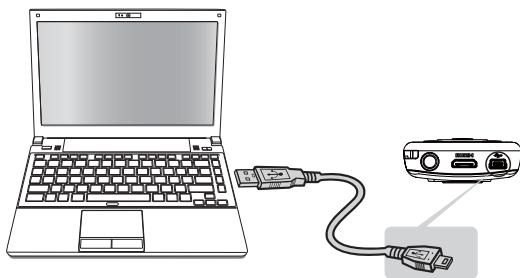

(Sample Illustration) Connecting to your computer

- 2** When the USB connection is made to your computer for the first time, up to three AutoPlay screens will appear on your computer.

CD Drive (x:) AIR10_Connect -- CAMILEO® AIR10 Connect Application

DV (x:) -- Internal memory of the camcorder

Removable Disk (x:) -- Only shows if an SD card is installed in the camcorder

NOTE The AutoPlay screens may load on top of one another. Simply drag them into view. Check your taskbar if you do not see them.

If the CAMILEO® AIR10 Connect application does not start to install automatically, click on the CAMILEO® AIR10 Connect application.

Depending on your computer settings during installation, up to three User Account Control screens (listed below) may pop up during the CAMILEO® AIR10 Connect installation process. Click OK on each one to proceed.

Microsoft Visual C++
Setup.exe
AIR10_Connect.exe

Follow the onscreen instructions to complete the installation.

To Install the bundled software from the included CD:

- 1** Insert the CD into your computer's optical disk drive.
The AutoPlay screen appears.
- 2** Click Install CAMILEO® AIR10 Connect to install the application.

NOTE

- ❖ If ArcSoft MediaImpression® is not installed, the CAMILEO® AIR10 Connect program will install the H.264 Codec (ffdshow-a free software under GPL license) to view videos correctly.
- ❖ In order for video chatting to function properly, you need to log out/quit the Instant Message (IM) application before the installation.
- ❖ During the installation, a warning message may appear. Click Continue Anyway/Yes to go on the installation.
- ❖ CAMILEO® AIR10 Connect is for Windows® based systems only.

Using CAMILEO® AIR10 Connect via Wi-Fi® (Infrastructure mode)

Follow the steps below to successfully connect to an available AP.

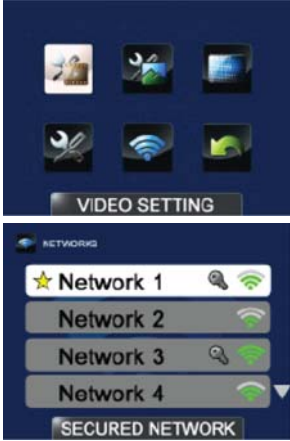
Operation	Screen
<p>On your camcorder:</p> <ol style="list-style-type: none"> 1 In Record mode, press the MENU/OK button. The Menu screen appears. 2 Use the Directional buttons to select the Wi-Fi (📶) icon, and then press the OK button to display the available AP list. 3 Select the available access point (Network), see “Wi-Fi® Functions” on page 58. 	

Operation	Screen
<p>On your computer:</p> <p>NOTE: Make sure your computer is on the same wireless network, and that you have already installed the CAMILEO® AIR10 Connect application on your computer.</p> <p>4 Double-click on the shortcut for CAMILEO® AIR10 Connect on the Windows® desktop.</p> <p>The camcorder connects to your computer and the CAMILEO® AIR10 Connect main screen displays on your computer screen.</p> <p>NOTE: If more than one Wi-Fi® device is connected to your computer, you may be asked to select the camcorder.</p>	

The available options in the CAMILEO® AIR10 Connect application via Wi-Fi® connection are:

Function	Description	Screen
Transfer	<p>You can remote access the videos and photos stored in your camcorder.</p> <p>You can transfer or delete files on your computer.</p>	
Live Video	<p>Watch live streaming from your camcorder on your computer.</p> <p>The video resolution can be selected.</p>	



NOTE

- ❖ ACCOUNT SETUP and Wi-Fi SETUP are not available during Wi-Fi® connection.
 - ❖ For Wi-Fi® connectivity to work correctly, make sure the bundled CAMILEO® AIR10 Connect (for Windows® based systems only) is installed and the wireless LAN module on your computer is activated.
 - ❖ Make sure your computer connects with your access point (AP) correctly and your camcorder is in the same range as the WLAN.
 - ❖ For more stable video streaming when using LIVE VIDEO or VIDEO CHAT, make sure the Wi-Fi® signal strength shows 2 bars () or above on the camcorder.
 - ❖ To improve the Wi-Fi® signal strength, move the camcorder closer to your access point.
 - ❖ If the camcorder is located too far away from your computer or the AP device, it may take longer to connect to the network. (The signal and the radio frequency may have interference.)
 - ❖ The zoom function is not available while on LIVE VIDEO or VIDEO CHAT mode
-

Using CAMILEO AIR10 Connect via USB

- 1 Connect the camcorder to your computer using the supplied Mini USB cable.
- 2 After establishing the USB connection, the main screen appears, see [“Installing CAMILEO® AIR10 Connect”](#) on page 50.

The available options in the CAMILEO® AIR10 Connect application via USB connection are:

Function	Description	Screen
Transfer	<p>You can remote access the videos and photos stored in your camcorder and transfer files to social networking sites.</p> <p>Upload:</p> <ol style="list-style-type: none"> 1 Select the videos/photos tab on the thumbnail screen. 2 Click Upload. <p>The networking site options appear.</p> <ol style="list-style-type: none"> 3 Select the social networking site. 4 Click OK to upload. 	
Account Setup	<p>Set up your social networking site account information and save it to your camcorder.</p> <ol style="list-style-type: none"> 1 Select the social networking site tab you wish to configure. 2 Enter your Username/email and password of the specific social networking site. 3 Click Save to save this account information to your camcorder. 4 Click Remove to delete the account information <p>NOTE: For USTREAM setup, you may choose the channel. You must set up your social networking site account information on the computer using the CAMILEO® AIR10 Connect application and save it to the camcorder before uploading.</p>	

Function	Description	Screen
<p>Wi-Fi® Setup</p>	<p>Wi-Fi® Profile</p> <p>Synchronize the Wi-Fi® profile on your computer with your camcorder.</p> <ol style="list-style-type: none"> 1 Click Add to camcorder to add the Wi-Fi® profile on your computer to your camcorder. 2 Click Up/Down/Remove to sort the priority of the Wi-Fi® profiles on your camcorder. <p>NOTE: Make sure your computer is equipped with a wireless LAN adapter and connects with your access point (AP) correctly, otherwise the SSID field will be blank.</p> <p>Camcorder Setting:</p> <p>Create a name for your camcorder or a security password to open the Wi-Fi® application.</p> <ol style="list-style-type: none"> 1 Create a password in the Password field and type it again to confirm. 2 Check Enable Security to enable it. Otherwise you will be asked to type the password before accessing the CAMILEO® AIR10 Connect application via Wi-Fi® connection the next time. 	

NOTE

- ❖ LIVE VIDEO and VIDEO CHAT are not available during USB connection.
- ❖ Some social networking sites may not allow access in certain regions or networks.
- ❖ Your computer must have Internet access to upload files to a networking site.
- ❖ If you do not have an account, sign up on the networking site first.
- ❖ The social networking site update is subject to change without notice. (e.g., password validation, create a channel), visit the Web site first to update your account setting.

Chapter 7

Wi-Fi[®] Functions

CAMILEO[®] AIR10 allows you to:



- ❖ Upload files to social networking sites
- ❖ Broadcast live streaming on USTREAM Web site

On your computer, with the CAMILEO[®] AIR10 Connect application (Windows[®] based systems only), you can:

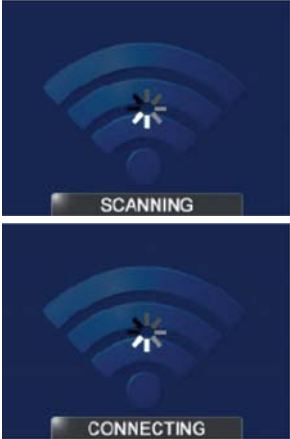

- ❖ Download the files from the camcorder to your computer
- ❖ Watch live streaming video from the camcorder on your computer
- ❖ Use the camcorder as a wireless webcam for online video chatting

Uploading files to social networking sites

Follow the steps below to connect to an available AP (access point).

Operation	Screen
<p>1 Press the Wi-Fi button.</p> <p>The camcorder scans for an available AP device and connects to it automatically. You can also select the available access point manual by selecting Wi-Fi while in Menu mode.</p>	
<p>2 If the available AP requires a password or the profile has not yet been setup, the AP list screen appears.</p> <ul style="list-style-type: none"> ★ Existing profile—An already saved AP profile. 🔑 Secured network—Requires a password to gain access to the AP 📶 Signal strength ▼ Down cursor—Indicates more than four available access points. Press the Down button to advance to the next page. <p>3 Select the desired available AP, and then press the OK button.</p>	
<p>If the selected AP requires password authentication, the Enter Password screen appears.</p> <p>4 Use the directional buttons to select the text and press the OK button to confirm.</p> <p>5 Select the (✔) icon to confirm the password and connect to the AP. Or select the Return/Exit (↩) icon to exit.</p>	

NOTE Closed networks or networks that must be accessed through a webpage login screen are not supported.



Operation	Screen
<p>The Connection OK screen appears and indicates that the connection is established. The signal strength appears at the top of the screen.</p>	
<p>If a connection cannot be established, the Connection Failed screen appears.</p> <p>Please see NOTE section below for possible reasons of connection failure.</p>	

- NOTE**
- ❖ This camcorder only supports the AP (SSID) named in English/number/symbols (ASCII characters).
 - ❖ The possible reasons for “CONNECTION FAILED” could be (1) wrong password; (2) you are not in the wireless network area of the AP; (3) the camcorder does not support the type of encryption used on the AP. This model only supports WEP/WPA/WPA2 personal type of encryption, but not up to enterprise level; (4) your network requires PPPoE account/password information.
 - ❖ You can only enter text in English, regardless of the OSD language.

Uploading files to social networking sites

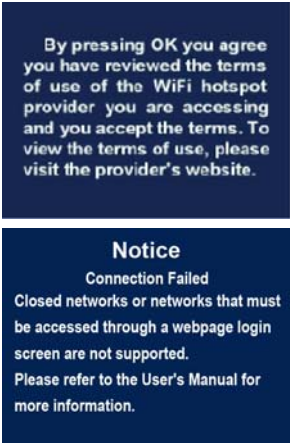

After the connection to the AP is established, follow the steps to upload the video/photo to the social networking sites.

Operation	Screen
<p>1 Press the Internet button. The camcorder automatically connects to the network.</p>	
<p>2 Some networks require authentication from the network's service provider (NSP). Follow the onscreen instructions.</p> <p>3 Select the Return/Exit (⏪) icon, and then press the OK button, or press the Return/Exit button to exit.</p> <p>4 If a successful connection cannot be made, contact the network service provider.</p>	
<p>NOTE The camcorder will try to connect to the Internet for one minute before the Connection Failed notice appears</p>	

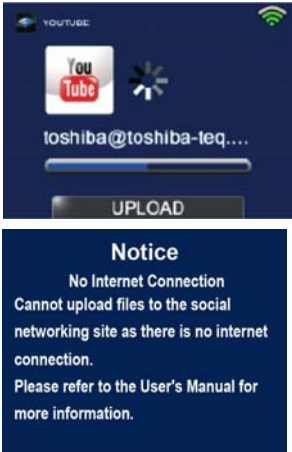
Operation	Screen
<p>The Connection OK screen appears and indicates that the connection is established. The signal strength appears at the top of the screen</p> <p>If a connection cannot be established, the Connection Failed screen appears.</p>	
<p>Once the connection to the network has been established, the camcorder automatically connects to the network and launches the built-in uploading application.</p> <p>5 Select the Web site you wish to upload to.</p> <p>You must first set up your social networking site information with the CAMILEO® AIR10 Connect application and save it to your camcorder. For more information, see “CAMILEO® AIR10 Connect” on page 50.</p>	
<p>6 Select the file you wish to upload, and then press the OK button to confirm.</p>	
<p>NOTE Uploading files may take a few minutes depending on the size of the files and the wireless network signal strength.</p>	

Operation	Screen
<p>The status bar appears during the upload process.</p> <p>7 Select the Return/Exit () icon, and then press the OK button, or press the Return/Exit button to exit.</p> <p>8 There is no Internet connection, please establish an Internet connection and try again.</p>	 <p>The screenshot shows the Ustream upload interface. At the top, it says 'YOUTUBE' and 'toshiba@toshiba-teq...'. There is a progress bar and an 'UPLOAD' button. Below this, a blue box contains the following text:</p> <p>Notice No Internet Connection Cannot upload files to the social networking site as there is no internet connection. Please refer to the User's Manual for more information.</p>
<p>NOTE The camcorder will try to upload files to the Internet for one minute before the No Internet Connection notice appears.</p>	

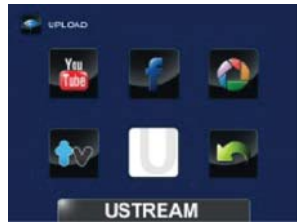
Broadcast live streaming on USTREAM

Operation	Screen
<p>1 Follow steps 1 - 5 in the previous section.</p> <p>2 Use the Directional buttons to select the USTREAM icon on the listed Web site screen.</p>	 <p>The screenshot shows the Ustream upload interface with the USTREAM icon highlighted. The text 'USTREAM' is visible at the bottom of the screen.</p>
<p>3 Select the Return/Exit () icon, and then press the OK button, or press the Return/Exit button to terminate streaming.</p>	 <p>The screenshot shows the Ustream live streaming interface. The text 'USTREAM' is visible in the top left corner. The main content is a video of two young girls sitting at a table with a birthday cake.</p>

Operation	Screen
<p>4 Video streaming is broadcast on the USTREAM Web site.</p> <p>Anyone that possesses your account/channel name can visit the USTREAM Web site and view live streaming broadcast from your camcorder through their various devices.</p> <p>Visit the USTREAM Web site for instructions on how to view live streaming.</p>	

NOTE

- ❖ Some AP routers do not allow you to connect to the network (e.g. firewall).
- ❖ You may be charged by the network service provider.
- ❖ It may take time to scan and connect to the AP/network, or to upload files. The upload speed is affected by the Internet connection speed and/or other factors.
- ❖ Social networking site information is subject to change without notice (e.g. password validation, create a channel). Visit the networking site first to update your account setting.
- ❖ Configuration through the CAMILEO® AIR10 Connect application on your computer may require Wi-Fi® connection to enable the uploading/streaming features, (e.g., select the broadcasting channel in YouTube®/USTREAM).
- ❖ Avoid transferring confidential files and setting your personal account information on an open network or in public areas.
- ❖ Make sure you create the channel on the USTREAM Web site for your broadcast. For detailed setup procedure, refer to the USTREAM Web site.
- ❖ The zoom function is not available while on USTREAM mode.

Chapter 8

Viewing Photos and Videos on TV

Connecting to a high-definition 16:9 (wide) TV

To view images or videos from your camcorder on a TV:

- 1 Connect the mini HDMI® cable (mini HDMI® cable required sold separately) to your camcorder's mini HDMI® out port.
- 2 Connect the other end of the cable to a television.
- 3 Set the video input source of your TV to HDMI®.

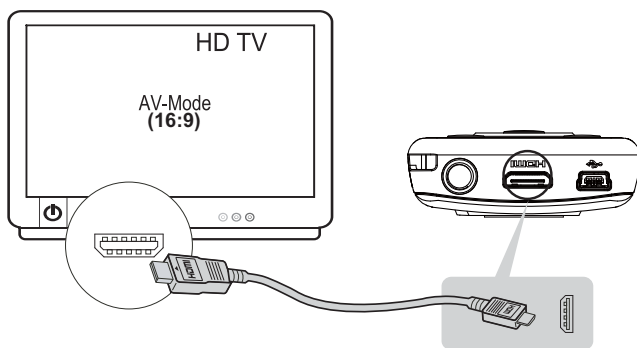

(Sample Image) Connecting a high-definition TV

66 Viewing Photos and Videos on TV

Installing bundled software

- 4 The steps for viewing stored photos and videos on a TV are the same steps used for viewing them on the LCD screen.
-

NOTE The camcorder cannot connect to the network while it is connected to an HDTV via the cable, or vice versa.

NOTE The LCD screen does not display when the camcorder is connected to an HDTV.

NOTE Some functions may not be accessible while the camcorder is connected to an HDTV.

Installing bundled software

The CD-ROM supplied with your camcorder contains two software applications.

To install the bundled software:

- 1 Insert the CD-ROM into your computer's optical disc drive. The autorun screen appears.
 - 2 Click "**Install Application Software**". Follow the onscreen instructions to complete the installation.
-

NOTE Detailed information can be found in the online help of all the bundled software.

Chapter 9

Viewing Photos and Videos on a Computer

NOTE

It may be necessary to install the bundled software application, ArcSoft MediaImpression® to view videos properly on your computer.

Transferring photos or videos to a computer

You can transfer photos or videos stored on your camcorder to a computer and send them via email to friends or post them on the Internet.

To do this:

- 1 Connect the computer and camcorder with the supplied mini USB 2.0 cable.
The multi-indicator light blinks.
- 2 To access photos and videos on your SD™ Card: Videos and photos can be found on your computer at “**My Computer\SD\DCIM\100MEDIA** (path will vary depending on name of SD™ Card).”
- 3 To access photos and videos in the camcorder’s internal memory: Videos and photos can be found on your computer at “**My Computer\DV\DCIM\100MEDIA**”
- 4 In this folder, you can view, delete, move, or copy any video/photo you want.
- 5 Use the bundled ArcSoft MediaImpression® application software to edit the videos or photos.

Chapter 10

Specifications

Image sensor	5 Megapixel BSI CMOS sensor
Operations modes	Video record, Photo record, Video/Photo upload via Wi-Fi®, Live streaming via Wi-Fi®, Wireless Webcam
Lens	Fixed focus lens (F 2.5)
Focus range	HD 720/60/HD 720/30: 29.5 in. (75cm) ~ infinity Photo/Full HD 1080/30: 43.3 in. (110cm) ~ infinity
Zoom	1x~5x (5x Digital zoom)
Shutter	Electronic
LCD screen	2 in. (5.08cm) LCD screen
Storage media	Built-in 128MB memory (partial memory is used for firmware code), SD/SDHC/SDXC card slot support (up to 64GB)
Image resolution	High: 4608 x 3456 (16MP) (Interpolated) Standard: 2592 x 1944 (5MP) Low: 2048 x 1536 (3MP)
Video resolution	Full HD 1080/30: 1920 x 1080 (30fps) HD 720/60: 1280 x 720 (60fps) HD 720/30: 1280 x 720 (30fps) VGA 480/30: 640 x 480 (30fps)

White balance	Auto/Manual (Daylight, Fluorescent, Tungsten)
ISO	Auto/800/1600
Self-timer	10 second delay
Light	Light ON/Light OFF/Digital Light ON
File format	Photo: JPG Video: MP4 (H.264)
Image play	Single image/Slideshow
PC interface	Mini USB 2.0 port
TV out	Mini HDMI®
Wi-Fi®	802.11 a/b/g Wi-Fi® CERTIFIED
Battery	Lithium-ion rechargeable battery
Dimensions	2.2 (W) x 4.3 (H) x 0.75 in. (D) 56 (W) x 108 (H) x 19mm (D)
Weight	3.0 oz. (86g) (without battery), 3.9 oz. (111g) (with battery)

Operating Environment Conditions

Operating temperature: 14° to 104° F (-10° to 40° C)

Operating humidity: 20 to 85% (relative humidity)

Chapter 11

Troubleshooting

If the camcorder fails to function as expected, check the list of common problems/solutions below:

<i>Problem</i>	<i>Solution(s)</i>
The camcorder does not turn on. The power turns off suddenly	Power is OFF. Press the Power button to turn ON. The battery is weak or dead. Recharge the battery.
The files on the memory card do not display smoothly, and the camcorder's LCD screen displays the "!" marking	The "!" means the SD™ Card is low speed or contains corrupted files. To solve this, format the SD™ Card using the camcorder not a computer, " Format " on page 48 . The card has some problems and can not be recognized. Change the card with another one. Change the SD/SDHC/SDXC card to a high speed card.
The camcorder does not take videos/photos	The memory is full. Delete some unnecessary videos/photos or insert a new SD™ Card. The power is OFF. Press the Power Button to turn ON.

Problem	Solution(s)
How do I charge the battery?	<p>You must use the supplied AC adaptor or the mini USB cable, see “Charging the battery” on page 16.</p> <p>The camcorder must be turned OFF.</p> <p>A blinking light indicates active charging and a solid light indicates that charging is complete.</p> <p>In AC charging mode, the full charge time is approximately up to 4 hours and the light will turn Off automatically after approximately 3~5 minutes even though charging continues. (Actual charging time may vary, depending on the battery’s condition.)</p>
The camcorder is freezing up	<p>Try turning OFF the camcorder and removing the battery. Then re-insert the battery and turn the camcorder ON again.</p>
The date imprinted on the photo is incorrect	<p>Set the date and time in the Setup menu, see “Time settings” on page 47.</p>
Why do some of my indoor photos look blurry and dark?	<p>The lighting may be poor. Check your surroundings for a better lit area.</p> <p>The camcorder extends photo exposure time under low light/indoor conditions. Keep the camcorder (and the target subject) steady for several seconds when taking photos, see “Photo setting options” on page 31.</p> <p>Place the camcorder on a flat and steady surface, or use a tripod when taking photos.</p>
The color of the video/photo is not natural	<p>Select the proper white balance option to match the light source, see “White Balance” on page 38.</p>
USB connection to the computer indications:	<p>DV: Indicates the internal memory of the camcorder.</p> <p>Removable Disk: Indicates the external memory (SD/SDHC/SDXC card) installed in the camcorder.</p> <p>AIR10 Connect: Indicates the bundled program. If you want to install this program, double-click on the icon to begin the installation automatically, see “Installing CAMILEO® AIR10 Connect” on page 50.</p>

Problem	Solution(s)
<p>The camcorder's LCD screen displays the message "CONNECTION FAILED" after pressing the Internet/Wi-Fi[®] button</p>	<p>The password configuration does not match the AP you wish to connect to.</p> <p>The AP router or the computer is not turned on. Turn the AP router or your computer on.</p> <p>The camcorder is not in the wireless network service area or has a weak network signal. Make sure the AP router is able to access the Internet. Closed networks or networks that must be accessed through a webpage login screen are not supported.</p> <p>The camcorder does not support the type of encryption used on the AP. This model only supports WEP/WPA/WPA2 personal type of encryption, but not up to enterprise level.</p> <p>Your network requires PPPoE account/password information.</p> <p>Some AP routers do not allow you to connect to the network (e.g. firewall).</p> <p>For more information, see "Wi-Fi[®] Functions" on page 58.</p>
<p>Uploading files takes a long time</p>	<p>Uploading files may take a few minutes depending on the size of the files and the wireless network signal strength. Either reduce the file size, increase the signal strength or try another wireless network.</p>
<p>Cannot upload files to the social networking site</p>	<p>There is no Internet connection. Please check your wireless network connection and try again.</p>
<p>The CAMILEO[®] AIR10 Connect application does not install properly</p>	<p>Make sure that your computer's operation system is compatible with the CAMILEO[®] AIR10 Connect application, see "Advanced operations on your computer (CAMILEO[®] AIR10 Connect)" on page 50.</p>

Chapter 12

Other Information

Toshiba Support

If you require help or are having problems operating your product, you may need to contact Toshiba for additional technical assistance.

Before you call

Since some problems may be related to software, it is important that you investigate other sources of assistance first. Try the following before contacting Toshiba:

- ❖ Review the documentation supplied with your product.
- ❖ If a problem occurs when you are running software applications, consult the software documentation for troubleshooting suggestions. Contact the software company's technical support department for assistance.
- ❖ Consult the reseller or dealer from whom you purchased your product. They are your best resource for current information and support.

Contacting Toshiba

Toshiba's technical support Web site

For technical support, or to stay current on the most recent software options for your CAMILEO® product and for other product information, be sure to regularly check the Toshiba Web site at support.toshiba.com.

Toshiba voice contact

For technical support, call the Toshiba Customer Support Center:

Within the United States at (888) 592-0944

Outside the United States at (949) 583-3305

Warranty

Online Warranty Information

This product is covered by a One (1) Year Standard Limited Warranty.

A copy of the warranty is included on the enclosed CD or can be viewed online at <http://pcsupport.toshiba.com/accessories1yr>.

Warranty Service

Customers located in the fifty (50) United States and District of Columbia may obtain warranty service by visiting the Toshiba Acclaim Web site at acclaim.toshiba.com or by contacting the telephone support center at (888) 592-0944.

Customers located outside the fifty (50) United States and District of Columbia may obtain warranty service by contacting the telephone support center at (949) 583-3305.