

TOSHIBA

Leading Innovation >>>



1000 & 1000+ SERIES

UPS USERS MANUAL



IMPORTANT NOTICE

The instructions contained in this manual are not intended to cover all of the details or variations in equipment, or to provide for every possible contingency concerning installation, operation, or maintenance. Should further information be required or if problems arise which are not covered sufficiently, contact your local Toshiba sales office or (877) 867-8773 or by e-mail at toshibaups@tic.toshiba.com.

The contents of this instruction manual shall not become a part of or modify any prior or existing agreement, commitment, or relationship. The sales contract contains the entire obligation of Toshiba International Corporation (TIC) Uninterruptible Power Systems (UPS) Division. The warranty contained in the contract between the parties is the sole warranty of TIC's UPS Division and any statements contained herein do not create new warranties or modify the existing warranty.

Any electrical or mechanical modifications to this equipment without prior written consent of Toshiba International Corporation will void all warranties and may void the UL/CUL listing. Unauthorized modifications can also result in personal injury, death, or destruction of the equipment.

UNINTERRUPTIBLE POWER SYSTEM

Complete the information below for the UPS received.

Unless otherwise specified on the warranty card, the warranty period for the UPS or UPS part is 36 months from the shipment date (see TIC Bill of Lading).

Unless otherwise specified on the warranty card, the warranty period for a UPS battery is 24 months from the shipment date (see TIC Bill of Lading).

Please complete the following information and retain for your records.

Job Number: _____

Model Number: _____

Serial Number: _____

Application: _____

Shipment Date: _____

Installation Date: _____

Inspected By: _____

January, 2013

Document Number: **57723-010**

Table of Contents

Manual's Purpose and Scope.....	V
Contacting Toshiba International Corporation's Customer Support Center	VII
EMC Statements.....	VIII
General Safety Instructions	X
Important Safety Instructions	XIII
Instructions Importantes Concernant.....	XVII
Inspection/Storage/Disposal	XVIII
Installation Precautions	XX
Operating Precautions	XXII
1. Introduction	1
2. System Description	1
2.1 General Description.....	2
2.2 Efficiency Optimizer Function	3
2.3 Auto-Restart	4
2.4 Free Run Mode	4
2.5 Diagnostic Tests.....	4
2.6 System Configuration.....	5
3. Storage	6
4. Shipping	6
5. Installation.....	8
5.1 Environment	8
5.2 UPS Frequency Converter Option.....	8
5.3 Rear Panel Views.....	9
5.4 Connecting to main supply, loads, and external battery cabinet.....	13
5.5 Front Panel Settings.....	16
6. Computer and Alarm Connections	18

6.1	RS-232 Standard Interface Port	18
6.2	Dry Contact Interface (optional card).....	19
6.3	USB Port	20
6.4	EPO Port (emergency power off)	20
6.5	Network Transient Protector.....	20
6.6	Load Segments	20
7.	User's Guide to Operations	21
7.1	UPS Startup and Shutdown	21
7.2	Button Operation	21
7.3	Control Panel Functions	22
7.4	Normal Display	23
7.5	UPS Meters Display	24
7.6	UPS Configurations.....	24
7.7	UPS Manual Test.....	26
7.8	Interpreting UPS Messages	26
7.9	Audible Alarms.....	26
7.10	Silencing an Alarm	26
7.11	Troubleshooting.....	27
8.	Maintenance	28
8.1	Battery Servicing.....	28
9.	Technical Specifications.....	29
9.1	Power Range 1000-3000 VA (120 V).....	29
9.2	Power Range 2400 VA (208/240 V)	30
9.3	Power Range 1000-3000 VA (230 V).....	31
9.4	Backup Time at Partial Loads.....	34
10.	Warranty Information	35
	LIMITATIONS AND EXCLUSIONS	36

Manual's Purpose and Scope

The purpose of this manual is to provide information on how to safely install, operate, and maintain your TIC power electronics product. This manual includes a section of general safety instructions that describes the warning labels and symbols that are used throughout the manual. Read the manual completely before installing, operating, or performing maintenance on this equipment.

The scope of this manual is to describe the requirements for an On-Line Uninterruptible Power System (UPS). The UPS will supply a computer grade AC output sine wave which is unaffected by the quality of the AC input. The input voltage is single phase and the output voltage is single phase.

This manual and the accompanying drawings should be considered a permanent part of the equipment and should be readily available for reference and review. Dimensions shown in the manual are in metric and/or the English equivalent.

TIC reserves the right, without prior notice, to update information, make product changes, or to discontinue any product or service identified in this publication.

TOSHIBA is a registered trademark of Toshiba Corporation. All other product or trade references appearing in this manual are registered trademarks of their respective owners.

Toshiba International Corporation (TIC) shall not be liable for direct, indirect, special, or consequential damages resulting from the use of the information contained within this manual.

This manual is copyrighted. No part of this manual may be photocopied or reproduced in any form without the prior written consent of Toshiba International Corporation.

© Copyright 2013 Toshiba International Corporation.

All rights reserved.

Printed in the U.S.A.

Contacting Toshiba International Corporation's Customer Support Center

Toshiba International Corporation's Customer Support Center can be contacted to obtain help in resolving any **Uninterruptible Power System** problems that you may experience or to provide application information.

The center is open from 8 a.m. to 5 p.m. (CST), Monday through Friday. The Support Center's toll free number is US (877) 867-8773, Fax (713) 896-5212.

The email address is toshibaups@tic.toshiba.com.

You may also contact Toshiba International Corporation by writing to:

Toshiba International Corporation
13131 West Little York Road
Houston, Texas 77041-9990
Attn: 1000 Series UPS Product Manager.

For further information on Toshiba International Corporation's products and services, please visit our website at www.toshiba.com/ind

EMC Statements

FCC Part 15

NOTICE: Pursuant to section 15 of the FCC rules each capacity unit has been tested and the 1000, 1500, and 2000 VA units comply with the conditions of a Class B digital device. The product has been established as offering sufficient protection against dangerous interference for installations in a residential area. The 2400 and 3000 VA units comply with FCC Section 15 conditions of a Class A digital device. Installation and use of the equipment should comply with the instructions provided in order to avoid interference due to the amount of radio frequency energy that is radiated and generated by the equipment.

TIC cannot assure that no interference will occur. Turn the unit on and off to help determine if the radio or television reception is found to be influenced by harmful interference from the equipment. If required, use one of the following measures to minimize the negative effects of interference:

- Place the receiving antenna in a separate location or orientation.
- Increase the distance between the receiver and the equipment.
- Ensure that your equipment and the receiver are on separate circuits.
- Contact a technician experienced with radio and TV or a dealer for further assistance.

ICES-003

This Class A and B Interference Causing Equipment meets all requirements of the Canadian Interference Causing Equipment Regulations ICES-003. Cet appareil numérique de la classe A et B respecte toutes les exigences du Règlement sur le matériel brouilleur du Canada.

Declaration of Conformity Request

Units labeled with a CE mark comply with the following standards and directives:

Harmonic Standards: EN 62040-1 and EN 62040-2.

EU Directives: 73/23/EEC, Council Directive on equipment designed for use within certain voltage limits.

2006/95/EC, Amending Directive 93/68/EEC and 73/23/EEC.

89/336/EEC, Council Directive relating to electromagnetic compatibility.

2004/108/EC, Amending Directive 92/31/EEC and 89/336/EEC relating to EMC.

The EC Declaration of Conformity is available upon request for products with a CE mark.

General Safety Instructions

DO NOT attempt to install, operate, maintain or dispose of this equipment until you have read and understood all of the product safety information and directions that are contained in this instruction manual.

Safety Alert Symbol / Signal Words

The Safety Alert Symbol indicates that a potential personal injury hazard exists. The symbol is comprised of an equilateral triangle enclosing an exclamation mark.



Signal Words

Listed below are the signal words that are used throughout this manual followed by their descriptions and associated symbols. When the words **DANGER**, **WARNING**, and **CAUTION** are used in this manual they will be followed by important safety information that must be carefully adhered to.

1. **Danger** — The word **DANGER** in capital letters preceded by the safety alert symbol indicates that an imminently hazardous situation exists that, if not avoided, will result in death or serious injury to personnel.



DANGER

2. **Warning** — The word **WARNING** in capital letters preceded by the safety alert symbol indicates that a potentially hazardous situation exists that, if not avoided, could result in death or serious injury to personnel.



3. **Caution/Attention** — The word **CAUTION** or **ATTENTION** in capital letters preceded by the safety alert symbol indicates that a potentially hazardous situation exists that, if not avoided, may result in minor or moderate injury.



4. The word **CAUTION** without the safety alert symbol indicates a potentially hazardous situation exists which, if not avoided, may result in equipment and property damage.

CAUTION

Special Symbols

Other warning symbols may appear in conjunction with the *Danger*, *Warning*, and *Caution* symbol and are used to specify special hazards. These warnings describe particular areas where special care and/or procedures are required in order to prevent serious injury and possible death.

1. **ELECTRICAL HAZARD SYMBOL** – Indicates a hazard that may cause injury from an electrical shock or burn. The symbol is comprised of an equilateral triangle enclosing a lightning bolt.



2. **EXPLOSION HAZARD SYMBOL** – Indicates a hazard that may cause injury from exploding parts. It is comprised of an equilateral triangle enclosing an explosion image.



Important Safety Instructions

This manual contains important instructions that should be followed during the installation, maintenance, and operation of the UPS and its batteries to assure safe and proper operation.

SAVE THESE INSTRUCTIONS

- Disconnect device in the building installation wiring.
- Not for use in a computer room as defined in the Standard for the Protection of Electronic Computer/Data Processing Equipment, ANSI/NFPA 75.
- CAUTION - To reduce the risk of fire, the input of the unit is connected only to a circuit provided with 20 amperes maximum branch circuit overcurrent protection in accordance with the National Electric Code, ANSI/NFPA 70
- CAUTION - Disconnect switch for each ungrounded conductor of ac output shall be provided by others. To reduce the risk of fire, the output of the unit is connected in series with branch circuit overcurrent protection for 20 amperes rating in accordance with the National Electric Code, ANSI/NFPA 70.



- CAUTION - RISK OF EXPLOSION IF BATTERY IS REPLACED BY AN INCORRECT TYPE. DISPOSE OF USED BATTERIES ACCORDING TO THE INSTRUCTIONS.

1. Turn off, lockout, and tagout all power sources before connecting the power wiring to the equipment or when performing maintenance.
2. Hardwire type UPS units are not equipped with an over-current protection device, nor do they have an output disconnect for the ac output. Therefore, a user-installed circuit breaker should be provided between the UPS output and the load input.
3. The maximum ambient operating temperature is 40° C (104° F).
4. Battery servicing should be performed by a qualified Toshiba Representative only.
5. Unauthorized personnel should not service batteries.

6. Contact your nearest Toshiba authorized service center for battery replacement.

Qualified Personnel ONLY!

Qualified Personnel is one that has the skills and knowledge relating to the construction, installation, operation, and maintenance of the electrical equipment and has received safety training on the hazards involved (Refer to the latest edition of NFPA 70E for additional safety requirements).

Qualified Personnel shall:

1. Have read the entire operation manual.
2. Be trained and authorized to safely energize, de-energize, ground, lockout and tag circuits and equipment, and clear faults in accordance with established safety practices.
3. Be trained in the proper care and use of protective equipment such as safety shoes, rubber gloves, hard hats, safety glasses, face shields, flash clothing, etc., in accordance with established safety practices.
4. Be trained in rendering first aid.
5. Be knowledgeable of batteries and the required handling and maintenance precautions.

For further information on workplace safety visit www.osha.gov



Misuse of this equipment could result in injury and equipment damage. In no event will Toshiba Corporation be responsible or liable for either indirect or consequential damage or injury that may result from the misuse of this equipment.



Do not dispose of the batteries in a fire. The batteries may explode.

 **CAUTION**

Do not open or mutilate the batteries. Released electrolyte is harmful to the eyes and skin and could also be toxic.

 **WARNING** 

Disconnect charging source prior to connecting or disconnecting battery terminals.

 **DANGER** 

A battery can present a risk of electrical shock and high short circuit current.

—Strict adherence to the following precautions is a requirement when working with batteries—

Disconnect charging source prior to connecting or disconnecting battery terminals.

To be performed by **Qualified Personnel** only.

1. Verify that the UPS is off and that the power cord is disconnected from the power source.
2. Disconnect charging source prior to connecting or disconnecting battery terminals.
3. Remove watches, rings or other metal objects.
4. Use tools with insulated handles to prevent inadvertent shorts.
5. Wear rubber gloves and boots.
6. Do not place tools or any metal parts on top of batteries.
7. Determine if the battery is inadvertently grounded. If inadvertently grounded, remove source of ground.

Contact with any part of a grounded battery can result in electrical shock.

The likelihood of shock will be reduced if such grounds are removed prior to installation or maintenance.

Instructions Importantes Concernant

LA SÉCURITÉ CONSERVER CES INSTRUCTIONS

Cette notice contient des instructions importantes concernant la sécurité.



Une batterie peut présenter un risque de choc électrique, de brûlure par transfert d'énergie.



L'élimination des batteries est règlementée. Consulter les codes locaux à cet effet.

Inspection/Storage/Disposal



CAUTION

Inspection

Upon receipt of the UPS, an inspection for shipping damage should be performed. Use caution when removing the unit from the pallet. Refer to labels or documentation attached to packing material.

Uncrating

Check the unit for loose, broken, bent or otherwise damaged parts. If damage has occurred during shipping, keep all original crating and packing materials for return to the shipping agent. The warranty does not apply to damage incurred during shipping. Ensure that the rated capacity and the model number specified on the nameplate conform to the order specifications.

Storage

During periods of non-use, the following guidelines are recommended for storage.

Storage Preparation

1. Power up the UPS and allow it to operate with no load for 24 hours to fully charge the batteries.
2. Stop the unit.
3. Disable the COLD START function prior to storing the unit by following the instructions in section 4. Shipping, page 6.
4. Ensure the MCCB switch is in the Off position.

Storing Conditions

- For best results, store the UPS in the original shipping container and place on a wood or metal pallet.
- Storage temperature — -4 – 104 °F (-20 – 40 °C).

- The optimum storage temperature is 70 °F (21° C). A higher ambient temperature will require recharging the batteries more frequently during storage.

Avoid the following storage locations:

- Locations that are subject to extreme temperature changes or high humidity.
- Locations that are subject to high levels of dust or metal particles.
- Locations that are subject to excessive vibration.
- Inclined floor surfaces.

Storage Maintenance

- If stored at an ambient temperature less than 68 °F (20 °C), recharge the batteries every 9 months.
- If stored at an ambient temperature of 68 – 86 °F (20 – 30 °C), recharge the batteries every 6 months.
- If stored at an ambient temperature of 86 – 104 °F (30 – 40 °C), recharge the batteries every 3 months.

Disposal

Please contact your local or state environmental agency for details on disposal of electrical components and packaging in your particular area.

It is illegal to dump lead-acid batteries in landfills or dispose of improperly.

Please help our Earth by contacting the environmental protection agencies in your area, the battery manufacturer, or call Toshiba toll-free at (877) 867-8773 for more information about recycling.

Installation Precautions



1. Install the unit in a well-ventilated location; allow at least 4 inches (10 cm) on all sides for air ventilation and for maintenance.
2. Install the unit in a stable, level and upright position that is free of excessive vibration.
3. Install the unit where the ambient temperature is within the range specified.
4. Do not install the UPS in areas that are subject to high humidity.
5. Do not install the UPS in areas that allow exposure to direct sunlight.
6. Do not install the UPS in areas that allow exposure to high levels of airborne dust, metal particles, or flammable gases.
7. Do not install the UPS in areas near sources of electrical noise. Ensuring a proper earth ground will reduce the effects of electrical noise and will reduce the potential for electrical shock.
8. Do not install the UPS in areas that would allow fluids or any foreign object to get inside the UPS.
9. The UPS generates and can radiate radio-frequency energy during operation. Although RFI noise filters are installed inside of the unit, there is no guarantee that the UPS will not influence some sensitive devices that are operating near by. If such interference is experienced, the UPS should be installed farther away from the affected equipment and/or powered from a different source than that of the affected equipment.
10. The user should provide output over-current protection for hardwired UPS systems.
11. After ensuring that all power sources are turned off and isolated in accordance with established lockout/tagout procedures, connect the power source wiring of the correct voltage to the input terminals of the UPS.

12. Connect the output terminals of the UPS to the load (refer to NEC Article 300 – Wiring Methods and Article 310 – Conductors For General Wiring). Size the branch circuit conductors in accordance with NEC Table 310.16.

Conductor Routing and Grounding

1. Use separate metal conduits for routing the input power, output power, and control circuits.
2. Follow the wire size and tightening torque specifications.
3. Always ground the unit to reduce the potential for electrical shock and to help reduce electrical noise.
4. A separate ground cable should be run inside the conduit with the input power, output power, and control circuits.



CAUTION

THE METAL OF CONDUIT IS NOT AN ACCEPTABLE GROUND.

Operating Precautions



1. The UPS should not be powered up until the entire operation manual has been read.
2. The voltage of the input power source must be within the range of +10% to -30% of the rated input voltage. The input frequency must be within the rated input frequency range. Voltages and frequencies outside of the permissible range may activate the internal protection devices.
3. The UPS should not be used with a load that has a rated input that is greater than the rated output of the UPS.
4. Do not use the UPS to provide power to motors that require high starting current or with motors that require a long starting time, such as vacuum cleaners and machine tools (over sizing the UPS for lock rotor current would be required).
5. Do not insert metal objects or combustible materials in the ventilation slots of the UPS.
6. Do not place, hang, or paste any objects on the exterior surfaces of the UPS.
7. The capacitors of the UPS maintain a residual charge for a while after turning the UPS off. The required discharge time for each UPS typeform is provided via a cabinet label and a CHARGE LED. Wait for at least the minimum time indicated on the label and ensure that the CHARGE LED has gone out before opening the door of the UPS once the UPS power has been turned off.
8. Do not attempt to disassemble, modify, or repair the UPS. Call your Toshiba sales representative for repair information.
9. Turn the power on only after attaching ALL of the covers.
10. Do Not remove any covers of the UPS when the power is on.
11. If the UPS should emit smoke or an unusual odor or sound, turn the power off immediately.

12. The heat sink and other components may become extremely hot to the touch. Allow the unit to cool before coming in contact with these items.
13. Warning signs should be placed on or near the load as a notification that the load is being powered by the UPS.
14. Additional warnings and notifications shall be posted at the equipment installation location as deemed required by Qualified Personnel.



While operating in the inverter mode, placing the breaker in the OFF position will switch the UPS to the battery backup mode. The output of the UPS will continue uninterrupted to the load. The unit must be in the bypass mode at the time that the breaker is placed in the OFF position for the UPS to shutdown power to the load.



After an Emergency Power Off (EPO), do not reset the breaker until the UPS has been fully discharged. The UPS could be damaged if the unit is not fully discharged before the breaker is reset.

MAINTENANCE NOTE

The 1000 Series UPS is not designed for field-level service. All troubleshooting and repairs will be done at the Depot-level.

1. Introduction

The information provided in this manual covers single phase 1000 – 6000 VA uninterruptible power systems (UPS). Included in this manual is information on the installation, operation, safety precautions, shipping, and storage of the equipment.

Installation must be carried out in accordance with this manual. Electrical installations must also follow local legislation and regulations. Only qualified personnel should install this equipment. Failure to comply with the warnings and precautions could prove to be fatal.

2. System Description

The purpose of the UPS is to protect sensitive systems from poor quality utility power, complete loss of power, or other associated problems. System types include computers, workstations, process control systems, telecommunications systems, sales terminals, or other critical instrumentation.

Electrical interference may occur causing problems in AC power. Interference may come from lightning, the power company, radio transmissions, or motors. Normal operation of sensitive electrical equipment requires protection against power outages, low or high voltage levels, frequency variations, differential and common-mode noises, and transients.

In order to prevent power line problems from reaching critical systems and causing damage to software, hardware or causing equipment to malfunction, the UPS helps by maintaining a constant voltage, isolating critical load output, and cleaning the utility AC power.

2.1 General Description

As a double conversion on-line UPS, it is able to supply uninterrupted, clean single-phase power to your critical systems while keeping batteries charged continuously, even if the utility power fails.

Other features of the UPS includes

- Auto-Restart feature (See detailed explanation on page 4)
- Cold Start feature
- Programmable Load Shed Receptacle
- Intelligent Charger with Rapid Charge in only 4 hours to 90%
- Wide Input Voltage Window
- Wide Input Frequency Window for Complete Generator Compatibility
- Input Power Factor greater than 0.97
- Output Power Factor:
 - 1000VA – 0.7
 - 1500VA – 0.7
 - 2000VA – 0.7
 - 2400VA – 0.8
 - 3000VA – 0.7
 - 6000VA – 0.7
- Multiple Languages LCD Display
- Efficiency Optimizer Function – See detail explanation on page 3
- Free Run Mode - See detailed explanation on page 4
- Diagnostic Tests - See detailed explanation on page 4
- Optional Network Interface Card, RemotEye II
- Optional Environmental Monitoring Device
- Auto-Restart in ON-Line mode after UPS shutdown.
- No Cold Starts on first use (*safety purpose*) (See detailed explanation on page 6)

See Figure 1 for systems applicable to the UPS system.

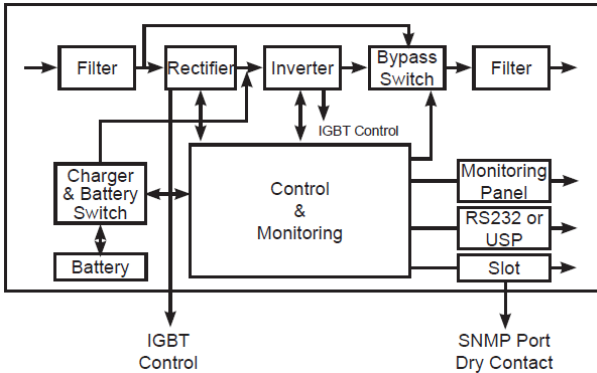

Figure 1. Block diagram

- An input filter reduces transients on the main supply.
- For maintaining full battery charge, AC power is rectified and regulated in the rectifier feeding power to the inverter and battery converter.
- DC power is converted to AC in the inverter and passes it on to the load.
- Power to the load is maintained from the battery during a power failure.
- The converter increases voltage for the inverter as required.

2.2 Efficiency Optimizer Function

The Efficiency Optimizer function is a new feature for the UPS that increases the cost effectiveness of the UPS by minimizing power losses and reduces power consumption. Alternating between bypass and on-line modes is achieved automatically and in accordance with the conditions of the utility power. On-line mode may be used during times of utility power irregularities. The bypass mode should be used when power flows

smoothly in order to obtain the greatest efficiency. Irregularities can be detected in less than a second and the on-line mode can be reactivated immediately. Switching back to online mode occurs when the input voltage exceeds $\pm 10\%$ (or $\pm 15\%$ selectable), when the input frequency exceeds $\pm 3\text{Hz}$, or when no input line is available.

Although high efficiency is standard, the default operation is the on-line mode. From the LCD display panel, Bypass can be activated as required or On-line operation can be run permanently if preferred.

2.3 Auto-Restart

In the event that a power failure lasts longer than the UPS backup time, the UPS will shut down. Upon power restoration, the UPS will restart automatically in On-Line mode, which includes output power being restored to the load and the start of battery recharge.

2.4 Free Run Mode

Free run mode is a mode of operation in which the UPS outputs a pre-set frequency (50 or 60 Hz) regardless of the input frequency. The UPS operates in free run mode when the input frequency is outside of the selected input frequency range. When starting the UPS, the targeted frequency is 50 or 60 Hz ± 0.25 Hz.

2.5 Diagnostic Tests

When the UPS is started, a diagnostic test is executed automatically that checks the electronics and battery, and reports any problems on the LCD display.

The advanced battery management system monitors the performance of the battery and will indicate if battery replacement is required. The battery management system tests the battery every 30 days of normal mode operation. A battery discharge test is performed and reports any problems on the LCD display.

Except during the first 24 hours after startup while the UPS is in charging mode, diagnostic tests can be performed manually from the front panel when required.

2.6 System Configuration

The UPS device and the internal backup battery make up the system. Depending on the site and load requirements of the installation, available options may be utilized to create a tailored solution.

Planning a UPS system should include the following considerations:

- The total demand of the protected system shall dictate the output power rating (VA). Allow a margin for future expansion or calculation inaccuracies from measuring power requirements.
- Backup time required will determine the battery size needed. If the load is less than the UPS nominal power rating then the actual backup time will be longer.

Here are the following backup time for each model that is based in a 100% load.

Model	Backup time Internal batteries	Recharge time to 90% capacity
UPS 1000VA	7 min	4 hours
UPS 1500VA	6 min	4 hours
UPS 2000VA	6 min	4 hours
UPS 2400VA	11 min	4 hours
UPS 3000VA	5 min	4 hours
UPS 6000VA	7 min	4 hours

The following configuration options are available for enhanced UPS performance:

- External Battery Cabinets. (Additional External Battery Cabinets are available if more back-up time is needed.)
- Connectivity options (Remote Contact, SNMP/WEB card).

3. Storage

Please adhere to the following instructions if the UPS is not installed when received:

- Store the equipment in its original packing and shipping carton.
- Store the unit in a temperature of 59 – 77 °F (15 – 25 °C).
- Ensure that the equipment is fully protected from wet or damp areas and from moist air.

In order to maintain the vitality of the batteries, ensure that the UPS is recharged every 6 months for at least 8 hours during storage.

4. Shipping

The cold start function must be disabled before the UPS is shipped. Cold start applies power to the UPS output with no UPS input. This can pose a shock or fire hazard if the output terminals are shorted. Toshiba is not responsible for any resultant fire or damage if the cold start function is not disabled.

Cold Start Disable Procedure (1000/1500/2000/2400/3000/6000 VA):

1. Ensure the UPS is switched OFF.
2. Plug In AC Power.
3. For 1/1.5/2/3/6kVA UPS: Press and hold the Function Key while pressing the “Enter” key 3 times.
For 2.4kVA UPS: Press and hold the Function Key while pressing the “Status” key 3 times.
4. After a beep sounds, unplug the AC power cord and wait for UPS to shutdown automatically.

**** Note:** Cold start will be automatically re-enabled when the UPS is plugged into commercial power and switched ON.

The 1000 Series UPS ships with an adhesive patch that covers the ON/OFF Button to prevent accidentally pressing the On/Off Button during shipping. Follow the above procedure to disable Cold Start and close the cover to prevent a fire hazard.

5. Installation

5.1 Environment

To ensure safe and proper operation, ensure that the installation conforms to the following specifications.

NOTE: Remove the protective plastic adhesive shipping cover over the Off-On button before turning the UPS On.

Ensure that the installation location is consistent with the following:

- Avoid extreme temperature and humidity. Maximal battery life can be attained with a recommended temperature range of 15 °C to 25 °C.
- Protect the equipment from moisture.
- Space and ventilation requirements must be met. Ensure there is at least 100mm (4 inch) behind and 50mm (2 inch) on the sides of the UPS for ventilation.
- Ensure that the front of the UPS remains clear for user access.

The External Battery Cabinets must be installed next to or underneath the UPS.

5.2 UPS Frequency Converter Option

The UPS has an optional software upgrade that allows it to serve as a frequency converter. Installing this software allows the user to set the UPS output to 50 or 60 Hz regardless of the input frequency.

This option can be downloaded from the Toshiba website, www.toshiba.com/ind. Follow the home page menu path to: UPS>> Options/Accessories>> 1000 series>> Software>> Frequency Conversion.

**** Note:** Installing the frequency converter software upgrade will disable the bypass function. (This insures that in the event of power loss you are not trying to, for example, run a 50 Hz load with 60 Hz commercial power.)

5.3 Rear Panel Views

1000VA – 1500VA Tower Rear Panel

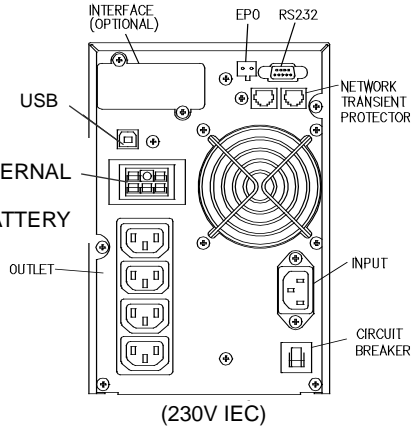
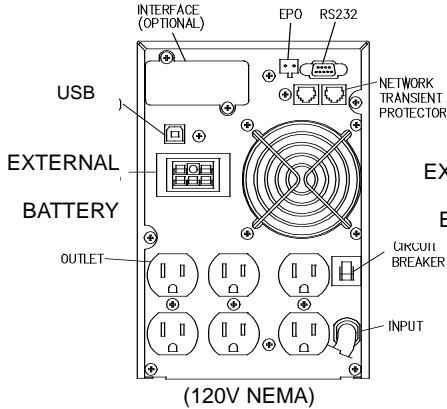

2000VA – 3000VA Tower Rear Panel

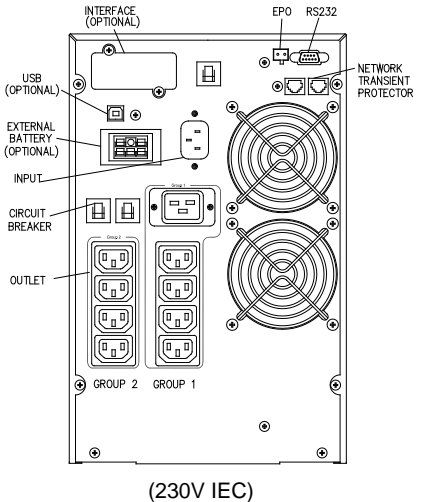
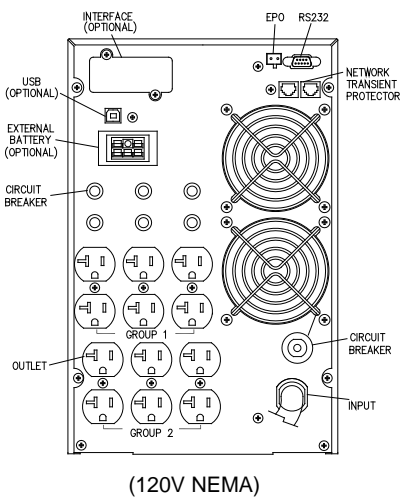

2400VA Tower Rear Panel

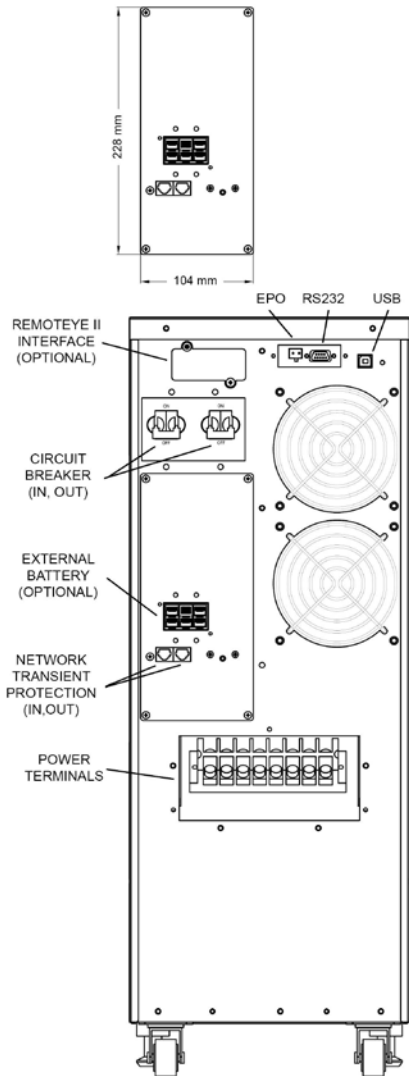

2400VA Power Wiring Options

The 2400VA unit is hardwired Input and Output only. Use the following wiring guidelines.

Note – Use minimum No. 14 AWG or 1.5 mm², 60°C copper wire and 22 Lb-in Torque force when connecting to Input and Output connection.

1. X1-X3 – 240V – FULL LOAD

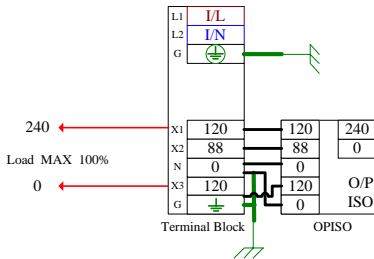

2. X2-X3 – 208V – FULL LOAD

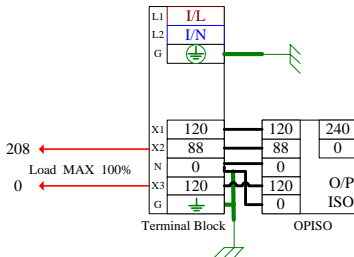

3. X1-N or N-X3 – 120V – HALF LOAD

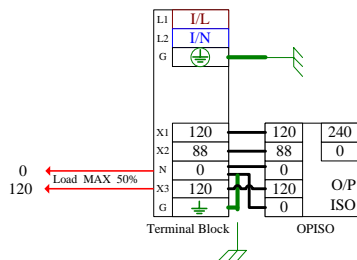
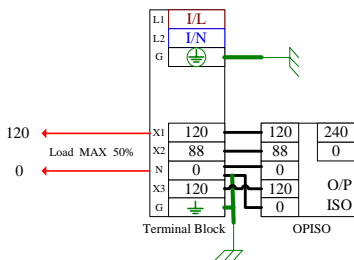

1000 – 1500 VA Rack mount (2U) Rear Panel

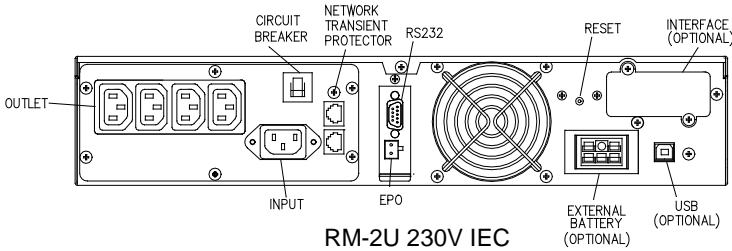
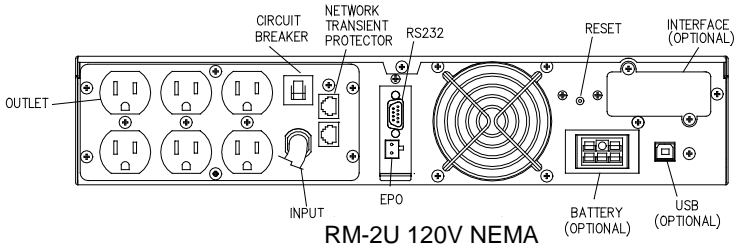

2000 – 3000 VA Rack mount (2U) Rear Panel

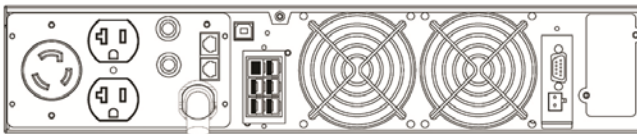
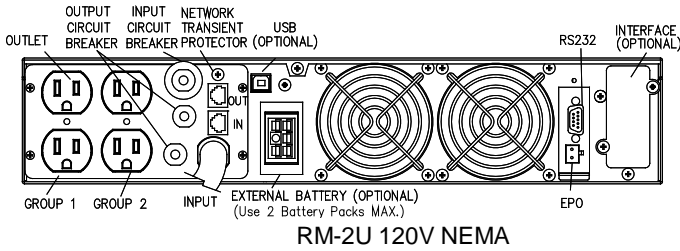

RM-2U 120V NEMA with -P1 Option

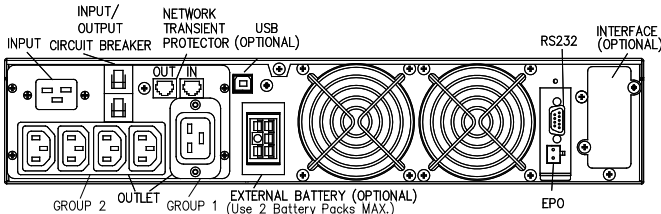

RM-2U 230V IEC

6000 VA Rack mount (UPS – 3U, Battery Pack – 3U) Rear Panel

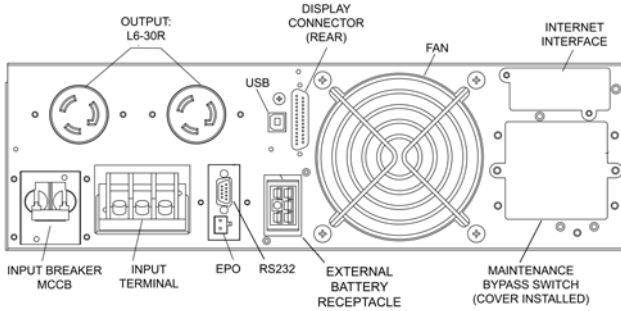

RM-6U 208/240V NEMA

(Includes Battery Pack, not shown)

5.4 Connecting to main supply, loads, and external battery cabinet

1000 – 3000 VA (Except 2400VA and 6000VA)

The AC input cable is supplied with all models except the 2400 VA and 6000 VA.

- Ensure that the UPS is disconnected from the main supply and loads while connecting the External Battery Cabinets.
- Use the battery cable supplied with the External Battery Cabinet to connect the External Battery Cabinet to the UPS. If more than one battery cabinet is required, use the supplied cable.

- A familiarity with the UPS parameter settings is required if changing the Battery pack quantity as when using the External Battery Cabinets.
- Connect the input cable to the UPS and connect the other end to a grounded outlet. The batteries will charge automatically when connected to the main supply. The UPS may be used immediately to power a load. However, the maximum battery back-up time will not be available until the recommended 8-hour minimum charge time has completed.
- If a Site Wiring Fault is displayed, rotate the connector.
- After charging the UPS, connect the load to the UPS.
- Do not connect any devices to the UPS that may cause overloading of the UPS or that draws half-wave rectified current, such as hair dryers or vacuum cleaners.
- See section 6 Computer and Alarm Connections if computer or alarm (rear panel) connections are used.
- The installation is now complete.

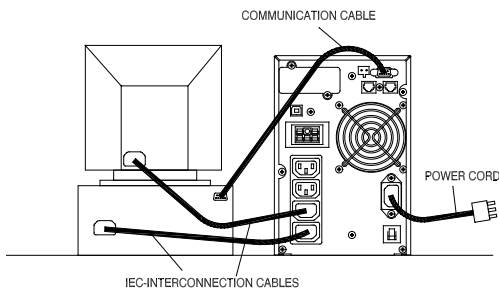

Figure 2 Example of Installation of Plug & Play products.

2400 VA

The 2400 VA UPS input and output power is hardwired to the power terminals. The output of the UPS can be adjusted according to which output terminals are selected. See **2400VA Power Wiring Options**, page 11.

6000 VA

The 6000 VA UPS comes in two sections, a Power Module and the Battery Pack. Each unit is RM-3U tall. The input power is hardwired to the UPS power input terminals. The UPS accepts either 208V or 240V input. The UPS autosenses the input voltage and provides the corresponding output voltage (208V or 240V). The UPS provides two L6-30R receptacles.

- Ensure that the UPS Main Circuit Breaker is open, and the UPS loads are disconnected while connecting the External Battery Cabinet/s.
- Use the battery cable supplied with the External Battery Cabinet to connect the External Battery Cabinet to the UPS. If more than one battery cabinet is required, use the supplied cable. The batteries will charge automatically when connected to the main supply.

NOTE: The UPS may be used immediately to power a load. However, the maximum battery back-up time will not be available until the recommended 8-hour minimum charge time has completed.

- After charging the UPS, connect the load to the UPS.

5.5 Front Panel Settings

Listed below are the default settings of the primary UPS parameters.

Settings	Options	Default	Remarks
1) O/P VOLT SET (output voltage set)	100/110/115/120/127 208/220/230/240 Vac	120 V 230 V	120 V (FOR LV series) 230 V (FOR HV series)
2) I/P FREQ SET (input frequency setting)	+/- 2% +/- 5% +/- 7%	+/- 5%	Input Frequency range in Free Run mode
3) I/P BYPASS SET (input bypass setting)	+/- 10% +10% -15% +15% -20%	+10% -15%	Input Voltage range when Bypass mode is on
4) FREE RUN SET	ON/OFF	ON	If ON, enable UPS runs on Asynchronous mode. For example: If input freq 55Hz output freq stays at 60Hz. If OFF, disable UPS runs on synchronous mode. For example: If input freq 55Hz, UPS will go to battery mode.
5) HE MODE SET	ON/OFF	OFF	If ON, enable UPS runs in High efficiency mode. The unit will be in bypass mode with 95% or higher efficiency. If OFF, the unit will be in the online mode with 85% efficiency.
6) MANUAL BYPASS	ON/OFF	OFF	If ON, enable UPS switch to Bypass mode immediately.

Settings	Options	Default	Remarks
7) OUTLET SETTING	GROUP1/GROUP2 Option 1: 1 On /2 On Option 2: 1 Off /2 On Option 3: 1 Off /2 Off Option 4: 1 On /2 Off	Option 1	This is a load-shed feature.
8) BATTERY TEST	TEST?		Perform battery test immediately
9) SILENCE SET	ON/OFF	OFF	
10) BAT CABINET SET	0: EXT B. PACKS 1: EXT B. PACKS 2: EXT B. PACKS	0	Shown options when battery Cabinets are connected
11) SITE FAULT SET	ENABLE/DISABLE	DISABLE	Alarm on main computer connected at wrong polarity or Installation to main supply without group.
12) LANGUAGE	ENGLISH GERMAN FRENCH SPANISH ITALIAN	ENGLISH	
13) GENERATOR	ON/OFF	OFF	If ON, UPS will work with a wide range of voltages and frequencies, without switching back and forth between Line and Battery mode.
14) RS232 CONTROL	ENABLE/DISABLE	ENABLE	Option to enable and disable the RS232 port. USB share the communication line with RS232. Only one option may be used at a time.

Complete the installation entirely before changing the default settings or connecting a load to the UPS.

6. Computer and Alarm Connections

At the rear of the UPS is an interface that allows direct communication with a computer system (see Figure 2, Pg. 14). There is a RS232 serial data interface, a USB data interface, and an emergency power off switch. The RS232 port and the USB interface cannot be used simultaneously.

In addition there is an optional interface slot that allows for the installation of communications cards. It may be used in parallel with either the RS232 or USB ports. An SNMP/WEB card is available for the optional interface slot that allows for the RemotEye II to manage and monitor the system over a network or over the internet.

6.1 RS-232 Standard Interface Port

Only the communication cable provided with the UPS may be used to connect the UPS to a computer when using the RS232 port of the UPS. Ensure that the operating system of the computer supports RS232 communications. Other advanced power protection solutions, such as SNMP, are available from your dealer.

The RS-232 interface uses a 9-pin D-sub connector. The names and functions of the port pins are listed in the following table.

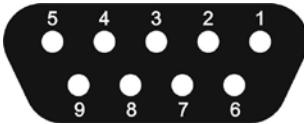

DB9 Female Connector Outline
(facing connector)

Pin #	Signal	Direction (re UPS)	Functions
2	TxD	Output	TxD Output
3	RxD	Input	RxD / Inverter Off Input
5	Common		Common
6		Output (Normally Open)	AC Fail (13VDC)
8		Output (Normally Open)	Low Battery (13VDC)
9		Output	8–24 VDC Power

Note: In Battery mode, the UPS will be turned off 2 minutes after 5V is applied to Pin 3 and Pin 5 for more than 5seconds.

Table 1 : RS232 Pin Out Signal

6.2 Dry Contact Interface (optional card)

DB9 Male Connector Outline
(facing connector)

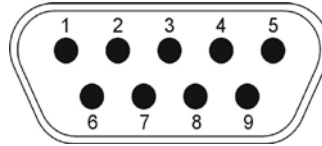

Pin #	Description	I/O Type
1	UPS fail, relay contact, normally open, active close.	output
2	Summary alarm, relay contact, normally open, active close. One of the following signals activate this signal: 1) Output fault 2) Bus fault 3) Over temperature 4) Overload 5) Over Charging 6) Battery test fail 7) Charger failure	output
3	GND for secondary	
4	Remote shutdown <ul style="list-style-type: none"> • Short Pin 4 & Pin 5: Remote Output Shutdown • Remove short between Pin 4 & Pin 5: UPS switch back to Inverter/Run 	input
5	Common	
6	Bypass active, normally open, active close	output
7	Battery low, normally open, active close	output
8	No connection	input
9	Utility fail, normally open, active close (Requires 2 seconds for pin to activate)	output

Note: Vcc Voltage is 9-12 Vdc.

Table 2 : DryContact Pin Out Signal Chart

6.3 USB Port

Connecting the UPS to a computer using the USB port of the computer requires USB compliant hardware, PC operating system support, and a UPS driver. The RS232 serial port cannot be used when using the USB port. The USB cable is a standard cable and may be purchased separately.

6.4 EPO Port (emergency power off)

A customer-supplied switch located remotely may be used to open the EPO connection and force the UPS output receptacles to be switched off. The EPO function shuts down the equipment immediately. An EPO will not provide an orderly shutdown. The UPS will have to be manually restarted in order to regain power to the outlets.

After an Emergency Power Off (EPO), do not reset the breaker until the UPS has been fully discharged. The UPS could be damaged if the unit is not fully discharged before the breaker is reset.

6.5 Network Transient Protector

The network transient protector, located on the back panel, has both IN and OUT RJ45 10 baseT jacks and will protect a single network connector. Connect the input connector to the jack labeled IN, and the output connector to the jack labeled OUT.

6.6 Load Segments

The sets of receptacles known as load segments provide organized shutdown and startup of the equipment. Less critical equipment can be turned off during power outages saving battery power for critical loads. The load group status can be viewed from the LCD display and can be changed if necessary.

7. User's Guide to Operations

Normal ongoing UPS operation requires little or no user input. Startup and shutdown requirements of the user are discussed in this section.

7.1 UPS Startup and Shutdown

Starting the UPS

- Ensure that installation is correct and that the input power cable is connected to a properly grounded outlet.
- Start the UPS by pressing the On/Off button on the front panel.
- The UPS will start the inspection of internal functions, main synchronization, and inverter startup. A successful completion allows for output power via the outlets.
- During the startup inspection the LCD will display Ready On. The LED will light up when output power has started and the LCD display will show Line Mode.
- Apply power to the load.



Shutting Down the UPS

- Shut off and disconnect the load.
- Press and hold the UPS On/Off button for five seconds. The alarm will sound and the UPS will shut down.
- The LCD will momentarily display UPS OFF.

Note: In emergency situations the EPO should be used.

7.2 Button Operation





1. “” or ON/OFF is the UPS ON/OFF button.
 - (a) Press and hold the ON/OFF button for at least 3 seconds to turn on the UPS.
 - (b) When the UPS is operating, press and hold the Load ON/OFF button for at least 3 seconds to turn off the UPS.

2. “” or ENTER is the Enter button.
 - (a) Press and hold the Enter button for at least 2 seconds to read the parameter settings of the UPS. Press the Enter button again to cycle through each successive parameter.
 - (b) Ten seconds of inactivity will return the display to the original status.
3. “” or FUNC is the Function button.
 - (a) Press and hold the Function button for at least 2 seconds to access the selectable parameters. Press the Function button again to cycle through each successive selectable parameter.
 - (b) Press the Enter button to view or change the displayed parameter.
 - (c) Ten seconds of inactivity will return the display to the original status.
4. STATUS (2400/6000VA Only) will display the UPS data.
 - (a) Press and hold the Status button for at least 2 seconds to read the parameter settings of the UPS. Press the Enter button again to cycle through each successive parameter.
 - (b) Ten seconds of inactivity will return the display to the original status.
5. ESCAPE (2400/6000VA Only) – Press Escape to return to the main display immediately.

7.3 Control Panel Functions

The front panel is composed of five LED indicators, an LCD screen, and a speaker for audible alarms.

Rack-mounted units have international symbols stenciled next to the LED indicators instead of text.

- ON/OFF or  — is on when the UPS is turned on (green).
- ON-LINE or  — is on when in the Normal or Static Bypass modes. Also indicates that there is voltage at the output terminals (green).
- ON-BAT or  — is on while operating in the Battery mode.
- BYPASS or  — is on while operating in the Bypass mode (yellow).

FAULT or 

— is on during active UPS internal errors (red). FAULT is accompanied by an audible alarm. Press any of the front panel buttons to cancel the alarm.

Status of the UPS, measurements, and alarms are all indicated on the LCD screen.

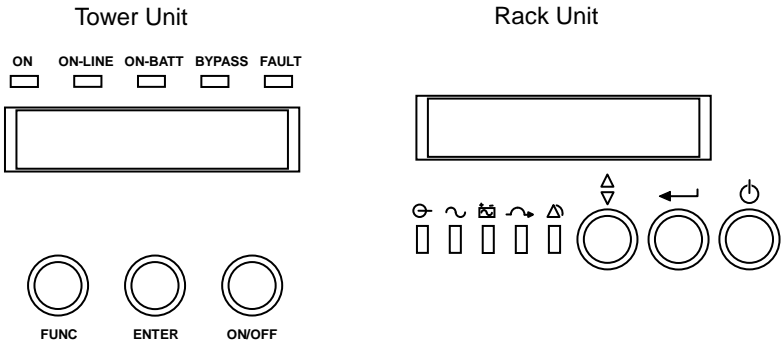

Figure 3 Control panels – 1000/1500/2000/3000VA

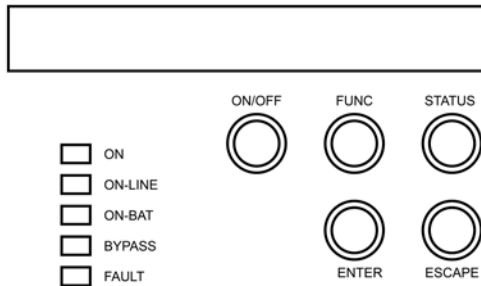

Figure 4 Control panel – 2400VA Tower/6000VA Rack Unit

7.4 Normal Display

The UPS status is shown in the normal display mode. The UPS Meters display and the Setting display may be accessed by pressing the Return button on Tower Unit and FUNC button on the Rack Unit.

7.5 UPS Meters Display

Listed below are the parameters available for viewing from the UPS meters display. Press this button to scroll through the parameters.

LCD Message	Description
O/P VOLT= xxx.xV	Shows Output AC Voltage
O/P FREQ= xx.x Hz	Shows Output Frequency
I/P VOLT= xxx.xV	Shows Input AC Voltage
I/P FREQ= xx.x Hz	Shows Input Frequency
BAT VOLT= xx.xV	Shows Battery Voltage
O/P LOAD%= xx%	Shows Load % of Max Load
O/P W= xW	Shows Output Watts
O/P VA= xVA	Shows Output VA
O/P CURR= xA	Shows Output Current
BACKUP TIME= xx min	Shows Estimated Backup Time in Minutes
BAT CHARG= xx%	Shows Approximate Percentage of Battery Capacity
TEMPERATURE= xxC	Shows Approximate Ambient Temperature
BAT PACK NUM= x	Shows External Battery Pack Number
RATING = xxxVA	Shows UPS Rating
CPU VERSION xx.x	Shows CPU Version

7.6 UPS Configurations

- 1) Parameter settings may be viewed from the UPS Settings display.
- 2) To enter the configuration mode, press and hold the Function button for one second. The first configuration parameter will be shown on the LCD display.
- 3) Press the Function button again to scroll through the remaining parameters.

- 4) Press the Enter button to select a displayed parameter.
- 5) Press the Function button to scroll through the options for the selected parameter. Press the Enter button to select the setting.
- 6) If prompted to save the selection, press the Enter button to either confirm or save the selection. See the table on page 16 for a complete listing of the user-settable parameters.
- 7) If there is no user input for ten seconds, the UPS will exit the configuration mode and return to normal mode displaying Line mode.

7.7 UPS Manual Test

Manual UPS and Battery tests may be performed from the UPS configuration screen. Tests may be performed when the battery is not being charged.

To run the battery test scroll to the “Manual Bat Test” parameter press the Enter button twice.

**** Note:** In order for the UPS to operate normally, Manual Bypass should always be set to OFF because the load will not be protected by the unit when Manual Bypass is ON.

***** Note:** Turn off the UPS and keep the AC power on to use the Generator function. (go to normal mode for \Generator\OFF).

7.8 Interpreting UPS Messages

Troubleshooting procedures described here provide instructions to be used to isolate UPS malfunctions.

Start the troubleshooting procedure in the event of a control panel alarm.

7.9 Audible Alarms

- While operating on battery power (ON BAT LED is on) the UPS will beep once at 5-second intervals.
- While operating on battery power and the battery power is low (ON BAT LED is flashing) the UPS will beep twice at 5-second intervals.
- In the event of an internal fault with an active alarm (ALARM LED is on), the UPS will provide a constant audible alarm and display an error message on the LCD display.
- While operating in the Bypass mode (BYPASS LED is on) the UPS will not beep.

7.10 Silencing an Alarm

With the exception of a LOW BATTERY Alarm, pressing any of the front panel buttons will turn off the alarm. Select Silent Alarm Mode to disable all audible alarms.

7.11 Troubleshooting

Displayed on LCD	Audible Alarm	Alarm Description	What You Should Do
Output Overload	Two Beeps/sec	The UPS is overloaded (in Line Mode). More power required than the UPS can provide. The UPS operates in bypass.	Remove loads from the UPS; least to most critical. If this solves the problem, the UPS will return to normal operation.
Battery Test	No Beeps	Battery test active.	No action needed. User Notification only.
Over-Charge	Constant Beep	Overcharged Batteries.	Turn off loads. Turn off UPS. Call service @ 1-877-867-8773
Low Battery	2 Beeps/5 sec	UPS operating on Battery Power and will shut down soon due to low battery voltage.	The unit will restart Automatically when acceptable power returns.
On-Battery	1 Beep/5 sec	UPS operating on Battery Power.	Save your data and perform a controlled shutdown.
Charger Failure	Constant Beep	Failed Charger.	Call service @ 1-877-867-8773
Over-Temperature	Constant Beep	High ambient Temperature.	Ensure that the UPS fans and vents are not blocked, and that the ambient temp. is < 40° C. If problem persists call service @ 1-877-867-8773
Output Short	Constant Beep	Output short circuit.	Call service @ 1-877-867-8773
High output Voltage	Constant Beep	High output voltage.	Call service @ 1-877-867-8773
Low Output Voltage	Constant Beep	Low output voltage.	Call service @ 1-877-867-8773
Bus Fault	2 Beeps/sec	High internal DC bus Voltage.	Turn off loads. Turn off UPS. Call service @ 1-877-867-8773
Site Wiring Fault	1 Beep/sec	Voltage detected between neutral and ground.	UPS main connector has wrong polarity. Rotate the connector (Schuko-electric contact). UPS installed to main supply without ground. See section 5.5 for information on how to disable the Site wiring alarm.
Line Abnormal	1 Beep/sec	Wrong AC Line backed up during auto restart.	

8. Maintenance

With a minimal amount of maintenance you can expect years of satisfactory operation from the UPS unit. The most critical issues for the reliability of the UPS are environmental issues. Ensure that the temperature and humidity are always in accordance with the specifications and keep the area around the unit clean and dust free. The typical battery lifetime is 4 years when operated at 77° (25 °C).

Check the back-up time capability of the UPS/battery at 6 to 12 month intervals to ensure adequate support for the application.

8.1 Battery Servicing

Servicing of batteries should be performed or supervised by personnel knowledgeable about batteries and the required precautions. See IMPORTANT SAFETY INSTRUCTIONS – Qualified Personnel.

CAUTION – When replacing batteries, replace with the same type and number of batteries.

Battery Type: Lead-Acid Type

Battery Rating: Total DC 72V, 96 Ah. (6 Pcs Battery/SET, 2 SET)

Replacement batteries available:

Manufacturer	Type	Rating
TAIWAN YUASA BATTERY CO LTD (MH28947)	REW45-12	12 Vdc, 8.0 Ah
	REW45-12FR	12 Vdc, 8.0 Ah

9. Technical Specifications

9.1 Power Range 1000-3000 VA (120 V)

Tower	US 120V Model	UT1A1A010C6	UT1A1A015C6	UT1A1A020C6	UT1A1A030C6
Rack-mount (2U)	US 120V Model	UT1A1A010C6R KB2	UT1A1A015C6R KB2	UT1A1A020C6R KB2	UT1A1A030C6R KB2
Input	Voltage	120 VAC (80 – 144 V)			
	Voltage Range	+20% to -33%			
	Frequency	50 / 60 Hz auto sensing			
	Power Factor	Greater than 0.97			
	Topology	True on-line Double conversion Input PF correction			
Output	Voltage	120 VAC			
	Capacity (VA)	1000 VA	1500 VA	2000 VA	3000 VA
	Capacity (W)	700 W	1050 W	1400 W	2100 W
	Frequency	50 / 60 Hz auto sensing *			
	Wave Form	Sine wave, zero transfer time			
	Load Power Factor	0.70			
	Efficiency AC/DC/AC	Greater than 86%			Greater than 85%
	Rated Current	8.3 A	12.5 A	16.6 A	25 A
	Overload Capacity	125% for 1 min 150% for 10 sec			125% for 1 min 130% for 10 sec
	Crest Factor	3.0 at full load			2.5 at full load
Battery	DC Voltage (Tower & 2U)	36 V / 12 V 9 AH x 3		72V / 12 V 9 AH x 6	
	Backup Time (Tower & 2U)	7 min (full load)	6 min (full load)	6 min (full load)	5 min (full load)
	Interface	RS-232 and USB standard RemotEye II® and EMD option			
Physical	Dimensions (Tower)	16.5"L x 6.0"W x 9.4"H		16.7"L x 8.9"W x 14.2"H	
	Dimensions (2U)	16.7"L x 16.9"W x 3.5"H		25.0"L x 16.9"W x 3.5"H	
	Weight (Tower/2U)	35.6 lbs / 37.6 lbs	37.4 lbs / 37.6 lbs	68.4 lbs / 69.5 lbs	72.6 lbs / 71.5 lbs
	Line Cord	5-15P		5-20P	L5-30P
	Receptacles (Tower/2U)	NEMA 5 - 15 P (6 / 6)		Tower - NEMA 5-20 P (12) 2U - NEMA 5-15 P (4)	
Environ-ment	Operating Temperature	32 – 104°F (0 – 40°C)			
	Altitude	11500 ft (3500 m) above sea level			
Warranty		Three years on electronics Two years full replacement on battery (See Toshiba warranty policy for full details.)			

- Output frequency can hard set at 50 or 60 Hz by installing an optional software upgrade. This upgrade enables the user to select a fixed output frequency and simultaneously disables the bypass mode.

Standards - Safety:UL-1778, Emissions: FCC Part 15 Class B (1000-2000 VA) FCC Part 15 Class A (3000 VA)

9.2 Power Range 2400 VA (208/240 V)

Tower	US 208/240 Model	UT1G2L024C6T
Input	Voltage	208 or 240 VAC (161 – 276 V)
	Voltage Range	+15% to -34%
	Frequency	50 / 60 Hz auto sensing
	Power Factor	Greater than 0.97
	Topology	True on-line Double conversion Input PF correction
Output	Voltage	120/208/240 VAC
	Capacity (VA)	2400 VA
	Capacity (W)	1920 W
	Frequency	50 / 60 (45-65) Hz auto sensing *
	Wave Form	Sine wave, zero transfer time
	Load Power Factor	0.8
	Efficiency AC/DC/AC	Greater than 87%
	Rated Current	10 A @ 240V
	Overload Capacity	125% for 1 min 130% for 10 sec
	Crest Factor	3.0 at full load
Battery	DC Voltage	72V / 12 V (9 AH x 6)
	Backup Time	11 min (full load)
	Interface	RS-232 and USB standard RemotEye II® and EMD option
Physical	Dimensions	23.2"L x 10.1"W x 27.6"H
	Weight	154.3 lbs
	Line Cord	None (Hardwired)
	Receptacles	None (Hardwired)
Environment	Operating Temperature	32 – 104°F (0 – 40°C)
	Altitude	3300 ft (1000 m) above sea level
Warranty		Three years on electronics Two years full replacement on battery (See Toshiba warranty policy for full details.)

- Output frequency can hard set at 50 or 60 Hz by installing an optional software upgrade. This upgrade enables the user to select a fixed output frequency and simultaneously disables the bypass mode.

Standards – FCC Part 15 Class A (2-3kVA), UL 1778, ICES-0003

Safety – EN 62040-1, Emissions: EN 62040-2, Immunity: EN 62040-2 Category C2

9.3 Power Range 6000 VA (208/240 V)

1000 Series 6kVA Specification

Specification		
Rackmount	US 208/240V	UT1G1G060C6RKB3 + UT1-BR-0607
General	Topology	True on-line, Double conversion, IGBT Power Factor Correction Input
	Certifications	CE
Input	Voltage (V)	Single Phase - 208/240Vin
	Capacity (VA)	6kVA
	Frequency	45-65 Hz auto sensing
	Frequency Synchronization	± 3Hz
	Power Factor	Greater than 0.97
	Current THD	Less than 15%
	Cold Start (0 to 100% load)	Default Output Frequency 60 Hz
	Earth leakage (max.)	2mA (UPS only)
	Bypass	Voltage (V)
		+10/-10% of nominal
		+15/-20% of nominal
		Set by display panel
Output	Voltage	208V or 240V
	Voltage Regulations	± 3%
	Capacity (W)	4.2kW
	Frequency	50 / 60 Hz auto sensing
	Battery Mode/Free Run Mode	± 0.25 Hz
	Wave Form	Sine wave, zero transfer time
	Load Power Factor	0.7 PF
	Efficiency AC/DC/AC	Greater than 89% at Nominal Voltage
	High Efficiency Mode Efficiency	Greater than 92%
	Rated Current (based on 240V)	25.0
	Inverter Overload Capacity	125% for 1 min, 150% for 10 sec
	Crest Factor	3.0 at full load
	Voltage Transient Response (battery mode with R type load)	0%100%0%; ± 15 % max. 20%100%20%; ± 9 % max.
	Voltage Transient Recovery (R type Load)	Return to nominal voltage within 30 ms
	On-line Transfer Time – Inverter to Bypass and Bypass to Inverter	Less than 4m sec
	High Efficiency Transfer Time – Inverter to Bypass and Bypass to Inverter	Less than 4m sec transfer time
	Short Circuit Protection	Electronic overload and short circuit.
	Voltage Total Harmonic Distortion (Full Linear Load)	Less than 3 % THD
	Voltage Total Harmonic Distortion (Full Non-Linear Load)	Less than 5 % THD
	Steady State Output Voltage Regulation	No-load to Full-load +/- 2% at full battery.
Common Mode Noise	less than 0.5Vrms	
Leakage Current	.5mA	
Surge Protection	MOV 260 Jules on Output	

Battery	Acceptable manufacturer	Yuasa Taiwan only	
	Type / Rating	9AH/12V Valve Regulated Lead Acid, Flame Retardant	
	Back-up Time at Full Load (at 25 degree C) (min)	7 minutes	
	Battery Bus Voltage (VDC)	240	
	Number of Batteries	20	
	Recharge	4 hours to 90% for all ratings	
	Battery Mode Voltage Regulation	±3% RMS for entire battery voltage range and 0 to 100% load	
	Battery Leakage	100 mA maximum	
	Battery Test	Automatic and Manual	
	Replaceable Batteries	Not Hot-Swappable	
	Battery Protection	Fuse	
	Pre-alarm Level	2 minutes	
	Battery Level @ Shutdown	1.67 VPC, ± 3% of battery voltage at FL with level automatically raised for lighter loading	
	Overcharge Protection	2.50 VPC, ± 3% of battery voltage	
	Temperature Compensated Charger	Maintains proper float voltage per battery specification over a temperature range of 10 to 40 degree C (2.3V/cell at 25 degree C with a temperature coefficient of minus 5 millivolts per degree C)	
	Voltage Level	2.25 minimum, 2.275 nominal, 2.30V maximum voltage of battery voltage	
	Protection against Batteries Deep Discharge		
	Environment	Operating Temperature	0 - 40°C (32 - 104°F)
		Storage Temperature	-20 - 40°C (-4 - 104°F)
		Operating Humidity	30-90% (No Condensation)
Altitude		11500 ft (3500 m) above sea level	
Acoustical Noise		50dB(A) maximum at 1 meter from Front Panel	
Heat Generation (BTU/Hour)		2234BTU/Hour	
Mechanical	Dimensions (Rackmount) LxWxH	16.8 in. x23.5 in. x10.5 in. (427 mm x 597mm x 267mm)	
	Weight (Rackmount)	148lbs (67.1 kg)	
	Line Cord	Terminal Block with L6-30P (option to remove the L6-30P)	
	Receptacles	(2) L6-30R	
	Enclosure	Enclosure of unit made from sheet metal meets NEMA 1 and UL Type 1 Standard	
	Paint System	Black Color	
	Front Panel	1000 Series Panel	
	Connectors/Options	EPO	
		Battery Connectors	
		Option card Slot (Network and Dry Contact)	
	Buzzer Volume	Mute/Unmute	
Warranty		Three years on electronics	
		Two years full replacement on battery (See Toshiba warranty policy for full details.)	

- Output frequency can hard set at 50 or 60 Hz by installing an optional software upgrade. This upgrade enables the user to select a fixed output frequency and simultaneously disables the bypass mode.

Standards – FCC Part 15 Class A (2-3kVA), UL 1778, ICES-0003

Safety – EN 62040-1, Emissions: EN 62040-2, Immunity: EN 62040-2 Category C2

9.4 Power Range 1000-3000 VA (230 V)

Tower	International 230V Model	UT1E1E010C6	UT1E1E015C6	UT1E1E020C6	UT1E1E030C6
Rack-mount (2U)	International 230V Model	UT1E1E010C6 RKB2	UT1E1E015C6 RKB2	UT1E1E020C6 RKB2	UT1E1E030C6RKB 2
Input	Voltage (International)	230 VAC (161 – 276 V)			
	Voltage Range (International)	+20% to -30%			
	Frequency	50 / 60 Hz auto sensing			
	Power Factor	Greater than 0.97			
	Topology	True on-line, Double conversion Input PF correction			
Output	Voltage (International)	230 VAC			
	Capacity (VA)	1000 VA	1500 VA	2000 VA	3000 VA
	Capacity (W)	700 W	1050 W	1400 W	2100 W
	Frequency	50 / 60 Hz auto sensing*			
	Wave Form	Sine wave, zero transfer time			
	Load Power Factor	0.7			
	Efficiency AC/DC/AC	Greater than 86%			Greater than 85%
	Rated Current (International)	4.3 A	6.5 A	13 A	13 A
	Overload Capacity	125% for 1 min., 150% for 10 sec.			125% for 1 min., 130% for 10 sec.
	Crest Factor	3.0 at full load			2.5 at full load
Battery	DC Voltage (Tower & 2U)	36 V / 12 V 9 AH x 3		72V / 12 V 9 AH x 6	
	Backup Time (Tower & 2U)	7 min (full load)	6 min (full load)	5 min (full load)	5 min (full load)
	Interface	RS-232 and USB standard RemotEye II® and EMD option			
Physical	Dimensions (Tower)	16.5" L x 6.0" W x 9.4" H		16.7" L x 8.9" W x 14.2" H	16.7" L x 8.9" W x 14.2" H
	Dimensions (2U)	16.7" L x 16.9" W x 3.5" H		25.0" L x 16.9" W x 3.5" H	25.0" L x 16.9" W x 3.5" H
	Weight (Tower/2U)	35.6 lbs / 37.6 lbs	37.4 lbs / 37.6 lbs	68.4 lbs / 69.5 lbs	72.6 lbs / 71.5 lbs
	Line Cord (International)	IEC 320			
	Receptacles (Tower/2U) International	IEC 320 (4 / 4)	IEC 320 (8 / 4)		IEC 320 (8 / 4)
Environment	Operating Temperature	32 – 104°F (0 – 40°C)			
	Altitude	11,500 ft (3500 m) above sea level			
Warranty		Three years on electronics Two years full replacement on battery (See Toshiba warranty policy for full details.)			

Output frequency can hard set at 50 or 60 Hz by installing an optional software upgrade. This upgrade enables the user to select a fixed output frequency and simultaneously disables the bypass mode.

Standards - Safety: EN 62040-1, Emissions: EN 62040-2, Immunity: EN 62040-2 Category C1 (1000-2000VA), EN 62040-2 Category C2 (2000-3000VA)

9.5 Backup Time at Partial Loads

Below is the estimated backup time at various fractions of full load for each 1000 Series model. This table assumes the batteries are fresh and begin with a .full initial charge

Load	10%	20%	30%	40%	50%	60%	70%	80%	90%	100%
1000 VA Backup (min)	150	56	38	30	23	19	15	12	10	7
1500 VA Backup (min)	80	37	21	19	18	15	13	11	8	6
2000 VA Backup (min)	150	68	38	26	19	14	11	9	7	6
2400 VA Backup (min)	200	76	53	42	33	28	22	18	15	11
3000 VA Backup (min)	80	40	25	19	15	12	9	8	6	5
6000 VA Backup (min)	45	36	29	22	18	15	13	11	9	7

Table 9.1 – Backup Time vs. Partial Load

10. Warranty Information

TOSHIBA INTERNATIONAL CORPORATION
LIMITED WARRANTY POLICY
(48 contiguous U.S. States, Canada & Mexico)
(UNINTERRUPTIBLE POWER SYSTEM)

TOSHIBA INTERNATIONAL CORPORATION (“TIC”) warrants that any Uninterruptible Power System (“UPS”) and Uninterruptible Power System Battery (“BATTERY”) (internal UPS battery and/or external battery cabinet) sold by TIC to an end user (“User”) shall be free of defects in material and workmanship. This warranty applies to all UPS series in table below:

UPS Series	Unit kVA	UPS Unit		Battery		Toshiba Dispatch (5)
		UPS Warranty (1)	On-Site (2)	Battery Warranty (3)	On-Site (4)	
1000	1, 1.5, 2, 2.4, 3, 6	36 months from shipment	No, Depot	24 months from shipment	No, Depot	Depot Only
<p>Note (1) Shipment date is determined by date on the TIC Bill of Lading.</p> <p>Note (2) For 1000 Series UPS the warranty applies if the units are sent and returned (paid for) by the user to/from the Toshiba Plant or a Toshiba designated Authorized Service Center.</p> <p>Note (3) Shipment date is determined by date on the TIC Bill of Lading * 24 month full replacement, 36 month pro-rated warranty (5 yr total)</p> <p>Note (4) For 1000 Series UPS the warranty applies if the units are sent and returned (paid for) by the user to/from the Toshiba Plant or a Toshiba Designated Authorized Service Center.</p> <p>Note (5) Toshiba Service dispatch available at normal business hours. Contacting Toshiba is possible 24 hours 7 days a week. User can purchase 24x7 dispatch programs offered through TIC’s Service Department. TIC also encourages users to review TIC’s UPS Preventative and Scheduled Maintenance/Parts Programs for Premium coverage.</p>						

If any UPS, UPS parts, and/or BATTERY fail to conform or is defective then TIC, at its option, will repair or replace it at the premises of the User (On-Site), The warranty period for a UPS or a UPS part is 12-36 months from shipment except for cases stated in table above. The warranty period for the BATTERY is 24 months from shipment except for cases stated in the table above.

LIMITATIONS AND EXCLUSIONS

- This limited warranty shall not cover the UPS, UPS parts, or BATTERY during their respective warranty periods, if the following storage, maintenance, installation, operating conditions are not met throughout the warranty periods (5 conditions below):

Valve Regulated Lead Acid (VRLA) Batteries for Toshiba UPS Required Operating, Installation, and Maintenance Conditions			
1. Temperature	Annual Average Temperature is to be 77°F (25 °C) with no greater temperature of 89 °F (32 °C) for more than 30 days		
2. Maximum # of Full Charge/Discharge Cycles			Maximum Number of Cycles (24 Months)***
	Discharge Time	Battery > 9 AHr	Battery < 9 AHr
	30 min	20	69
	15 min	25	86
	10 min	32	110
	5 min	38	130
	*** > 9AHr Typically extended runtimes < 9AHr Typically Single Phase Systems.		
3. Storage	While UPS is in Transit or in storage, it must always be in a suitable temperature (as stated above)		
4. External Battery	Parallel battery string applications must be approved by TIC in writing		
5. Idle Batteries	User must recharge the batteries if not in use (charged) for more than 6 months		

Credit for Replacement Battery When Approved Warranty		
Time from Shipments	UPS Batteries	Cost to Customer
Months	% Credit	% List Price
0-24	100	0
25-30	55	45
31-36	45	55
37-42	35	65
43-48	25	75
49-54	15	85
55-60	5	95

- This Warranty does not cover damage or defect caused by misuse, improper application, wrong or inadequate electrical current/voltage/frequency, inadequate connections, inadequate water or drain services, user negligence, repair by non-Toshiba designated personnel, accident during shipment, tampering, alterations, a change in UPS and/or BATTERY location or application, exposure to the elements, acts of God, force nature, theft, sabotage, installation contrary to TIC's recommendations or specifications (Published Operation Manuals), also if serial numbers have been altered, defaced, or removed.

3. Repair or replacement of a defective UPS, UPS part, and/or BATTERY does not extend the respective original warranty period. All defective UPS, UPS parts, and/or BATTERIES shall be the property of TIC upon replacement.
4. This warranty shall constitute the sole and exclusive remedy of all purchasers and users of the UPS, UPS part, and/or BATTERY. TIC's responsibility for UPS, UPS Parts, and/or BATTERY shall not exceed one times the net UPS and/or BATTERY purchase price. **TIC HEREBY EXPRESSLY DISCLAIMS ALL OTHER EXPRESS, STATUTORY AND IMPLIED WARRANTIES, INCLUDING WITHOUT LIMITATION, THE IMPLIED WARRANTIES OF MERCHANTABILITY AND FITNESS FOR A PARTICULAR PURPOSE.**

PROCEDURE

User must contact TIC via e-mail upsservice@tic.toshiba.com, or phone 1-800-231-1412, no later than 90 days after User's discovery of occurrence or defect in UPS, UPS part, and/or BATTERY but in no event after the expiration of the respective warranty period. Subject to the limitations of this policy and product type, TIC service or TIC service representative shall repair/replace the UPS/part warranted hereunder, without charge for material, labor (on-site except in cases presented herein). If TIC determines that the requested repair is not covered under this limited warranty policy, then TIC shall advise customer and quote cost of repair. Repair charges shall be based on service parts price and prevailing service charges at the time of repair.

If the case in process is a BATTERY (stand-alone and/or cabinet) TIC will use its published Battery Diagnostic Document to evaluate warranty applicability. First, TIC will make sure that the storage, maintenance, installation, and operating conditions were met; then the BATTERY capacity will be tested in accordance with the "performance test" guidelines IEEE STD 450. If the BATTERY fails to deliver 70% of its rated capacity it shall be deemed defective and be replaced. Either float or cyclic service will be used to determine the warranty credit (as per published Battery Diagnostic Document). The typical credit applied will be as in the table above.

MODIFICATIONS

No representative, salesperson, agent, distributor, or employee of TIC is authorized to modify any of the terms of this warranty, unless modifications are made in writing and signed by an authorized TIC officer.

THIS WARRANTY REPRESENTS THE ENTIRE AGREEMENT BETWEEN TIC AND USER WITH RESPECT TO THE SUBJECT MATTER HEREIN AND SUPERSEDES ALL PRIOR OR CONTEMPORANEOUS ORAL OR WRITTEN COMMUNICATIONS, REPRESENTATIONS, UNDERSTANDINGS OR AGREEMENTS RELATING TO THIS SUBJECT.

End User: _____

Model Number: _____

Serial Number: _____

Startup Date: _____

Warranty End Date: _____

TOSHIBA

TOSHIBA INTERNATIONAL CORPORATION

13131 W. Little York Road • Houston, TX 77041

Tel: 713-466-0277 US: 800-231-1412

www.toshiba.com/ups