

TOSHIBA

FILE NO. A06-010
Revised : Mar. 2007

SERVICE MANUAL/INTEGRATION

AIR-CONDITIONER

SPLIT TYPE

INDOOR UNIT

<DIGITAL INVERTER>

RAV-SM563UT-E	RAV-SM562BT-E	RAV-SM562CT-E
RAV-SM803UT-E	RAV-SM802BT-E	RAV-SM802CT-E
RAV-SM1103UT-E	RAV-SM1102BT-E	RAV-SM1102CT-E
RAV-SM1403UT-E	RAV-SM1402BT-E	RAV-SM1402CT-E

<SUPER DIGITAL INVERTER>

RAV-SP1102UT-E

OUTDOOR UNIT

<DIGITAL INVERTER>

RAV-SM563AT-E RAV-SM803AT-E RAV-SM1103AT-E RAV-SM1403AT-E

<SUPER DIGITAL INVERTER>

RAV-SP562AT-E RAV-SP802AT-E RAV-SP1102AT-E RAV-SP1402AT-E

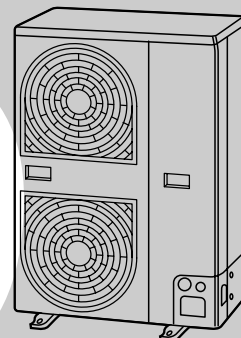
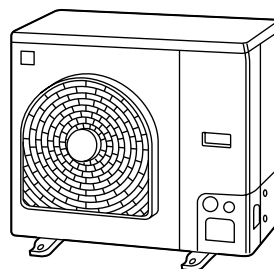
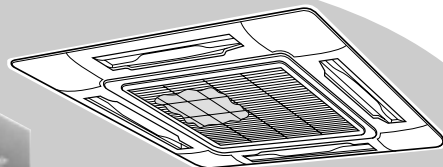
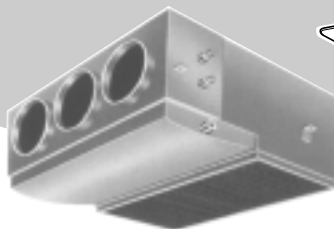
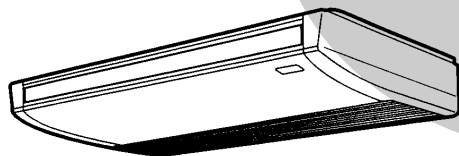

ADOPTION OF NEW REFRIGERANT

This Air Conditioner is a new type which adopts a new refrigerant HFC (R410A) instead of the conventional refrigerant R22 in order to prevent destruction of the ozone layer.

WARNING

Cleaning of the air filter and other parts of the air filter involves dangerous work in high places, so be sure to have a service person do it. Do not attempt it yourself. The cleaning diagram for the air filter is there for the service person, and not for the customer.

NOTE

A direct current motor is adopted for indoor fan motor in the Concealed Duct Standard Type air conditioner. Caused from its characteristics, a current limit works on the direct current motor. When replacing the high-performance filter or when opening the service board, be sure to stop the fan. If an above action is executed during the fan operation, the protective control works to stop the unit operation, and the check code "P12" may be issued. However it is not a trouble. When the desired operation has finished, be sure to reset the system to clear "P12" error code using the leak breaker of the indoor unit. Then push the operation stop button of the remote controller to return to the usual operation.

CONTENTS



- SAFETY CAUTION 4**
- 1. SPECIFICATIONS 9**
 - 1-1. Indoor Unit 9
 - 1-2. Outdoor Unit 17
 - 1-3. Operation Characteristic Curve 19
- 2. AIR DUCTING WORK 22**
 - 2-1. Static Pressure Characteristics of Each Model 22
- 3. CONSTRUCTION VIEWS (EXTERNAL VIEWS) 24**
 - 3-1. Indoor Unit 24
 - 3-2. Outdoor Unit 28
- 4. SYSTEMATIC REFRIGERATING CYCLE DIAGRAM 31**
 - 4-1. Indoor Unit/Outdoor Unit 31
- 5. WIRING DIAGRAM 39**
 - 5-1. Indoor Unit 39
 - 5-2. Outdoor Unit (Wiring Diagram) 42
- 6. SPECIFICATIONS OF ELECTRICAL PARTS 46**
 - 6-1. Indoor Unit 46
 - 6-2. Outdoor Unit 48
 - 6-3. Accessory Separate Soldparts 50

7. REFRIGERANT R410A	51
7-1. Safety During Installation/Serviceing	51
7-2. Refrigerant Piping Installation	51
7-3. Tools	55
7-4. Recharging of Refrigerant.....	55
7-5. Brazing of Pipes	56
7-6. Instructions for Re-use Piping of R22 or R407C	58
8. CONTROL BLOCK DIAGRAM	61
8-1. Indoor Control Circuit.....	61
8-2. Control Specifications	62
8-3. Indoor Print Circuit Board	70
9. CIRCUIT CONFIGURATION AND CONTROL SPECIFICATIONS	71
9-1. Indoor Control Circuit.....	71
9-2. Outdoor Controls	71
10. TROUBLESHOOTING	80
10-1. Summary of Troubleshooting.....	80
10-2. Check Code List	82
10-3. Error Mode Detected by LED on Outdoor P.C. Board	85
10-4. Troubleshooting Procedure for Each Check Code	86
11. REPLACEMENT OF SERVICE INDOOR P.C. BOARD	102
12. SETUP AT LOCAL SITE AND OTHERS	106
12-1. Indoor Unit.....	106
12-2. Setup at Local Site / Others	113
12-3. How to set up central control address number	115
13. ADDRESS SETUP	116
13-1. Address Setup	116
13-2. Address Setup & Group Control	117
13-3. Address Setup	118
14. DETACHMENTS.....	120
14-1. Indoor Unit.....	120
14-2. Outdoor Unit.....	134
15. EXPLODED VIEWS AND PARTS LIST	159
15-1. Indoor Unit.....	159
15-2. Outdoor Unit.....	173
15-3. Replacement of Main Parts (Sold Separately)	181
16. CORD HEATER INSTALLATION WORK	183
16-1. Required parts for installation work (Recommendation)	183
16-2. Base Plate	192

SAFETY CAUTION



The important contents concerned to the safety are described on the product itself and on this Service Manual. Please read this Service Manual after understanding the described items thoroughly in the following contents (Indications/Illustrated marks), and keep them.

[Explanation of indications]

Indication	Explanation
 DANGER	Indicates contents assumed that an imminent danger causing a death or serious injury of the repair engineers and the third parties when an incorrect work has been executed.
 WARNING	Indicates possibilities assumed that a danger causing a death or serious injury of the repair engineers, the third parties, and the users due to troubles of the product after work when an incorrect work has been executed.
 CAUTION	Indicates contents assumed that an injury or property damage (*) may be caused on the repair engineers, the third parties, and the users due to troubles of the product after work when an incorrect work has been executed.

* Property damage : Enlarged damage concerned to property, furniture, and domestic animal/pet





[Explanation of illustrated marks]

Mark	Explanation
	Indicates prohibited items (Forbidden items to do) The sentences near an illustrated mark describe the concrete prohibited contents.
	Indicates mandatory items (Compulsory items to do) The sentences near an illustrated mark describe the concrete mandatory contents.
	Indicates cautions (Including danger/warning) The sentences or illustration near or in an illustrated mark describe the concrete cautious contents.









[Confirmation of warning label on the main unit]

Confirm that labels are indicated on the specified positions
(Refer to the Parts disassembly diagram (Outdoor unit).)







If removing the label during parts replace, stick it as the original.

 DANGER	
 Turn off breaker.	Turn "OFF" the breaker before removing the front panel and cabinet, otherwise an electric shock is caused by high voltage resulted in a death or injury. During operation, a high voltage with 400V or higher of circuit (*) at secondary circuit of the high-voltage transformer is applied. If touching a high voltage with the naked hands or body, an electric shock is caused even if using an electric insulator. * : For details, refer to the electric wiring diagram.
 Execute discharge between terminals.	When removing the front panel or cabinet, execute short-circuit and discharge between high-voltage capacitor terminals. If discharge is not executed, an electric shock is caused by high voltage resulted in a death or injury. After turning off the breaker, high voltage also keeps to apply to the high-voltage capacitor.
 Prohibition	Do not turn on the breaker under condition that the front panel and cabinet are removed. An electric shock is caused by high voltage resulted in a death or injury.



 **WARNING**

 Check earth wires.	Before troubleshooting or repair work, check the earth wire is connected to the earth terminals of the main unit, otherwise an electric shock is caused when a leak occurs. If the earth wire is not correctly connected, contact an electric engineer for rework.
 Prohibition of modification.	Do not modify the products. Do not also disassemble or modify the parts. It may cause a fire, electric shock or injury.
 Use specified parts.	For spare parts, use those specified (*). If unspecified parts are used, a fire or electric shock may be caused. *: For details, refer to the parts list.
 Do not bring a child close to the equipment.	Before troubleshooting or repair work, do not bring a third party (a child, etc.) except the repair engineers close to the equipment. It causes an injury with tools or disassembled parts. Please inform the users so that the third party (a child, etc.) does not approach the equipment.
 Insulating measures	Connect the cut-off lead cables with crimp contact, etc, put the closed end side upward and then apply a water-cut method, otherwise a leak or production of fire is caused at the users' side.
 No fire	When repairing the refrigerating cycle, take the following measures. 1) Be attentive to fire around the cycle. When using a gas stove, etc, be sure to put out fire before work; otherwise the oil mixed with refrigerant gas may catch fire. 2) Do not use a welder in the closed room. When using it without ventilation, carbon monoxide poisoning may be caused. 3) Do not bring inflammables close to the refrigerant cycle, otherwise fire of the welder may catch the inflammables.
 Refrigerant	Check the used refrigerant name and use tools and materials of the parts which match with it. For the products which use R410A refrigerant, the refrigerant name is indicated at a position on the outdoor unit where is easy to see. To prevent miss-charging, the route of the service port is changed from one of the former R22. For an air conditioner which uses R410A, never use other refrigerant than R410A. For an air conditioner which uses other refrigerant (R22, etc.), never use R410A. If different types of refrigerant are mixed, abnormal high pressure generates in the refrigerating cycle and an injury due to breakage may be caused. Do not charge refrigerant additionally. If charging refrigerant additionally when refrigerant gas leaks, the refrigerant composition in the refrigerating cycle changes resulted in change of air conditioner characteristics or refrigerant over the specified standard amount is charged and an abnormal high pressure is applied to the inside of the refrigerating cycle resulted in cause of breakage or injury. Therefore if the refrigerant gas leaks, recover the refrigerant in the air conditioner, execute vacuuming, and then newly recharge the specified amount of liquid refrigerant. In this time, never charge the refrigerant over the specified amount. When recharging the refrigerant in the refrigerating cycle, do not mix the refrigerant or air other than R410A into the specified refrigerant. If air or others is mixed with the refrigerant, abnormal high pressure generates in the refrigerating cycle resulted in cause of injury due to breakage. After installation work, check the refrigerant gas does not leak. If the refrigerant gas leaks in the room, poisonous gas generates when gas touches to fire such as fan heater, stove or cooking stove though the refrigerant gas itself is innocuous. Never recover the refrigerant into the outdoor unit. When the equipment is moved or repaired, be sure to recover the refrigerant with recovering device. The refrigerant cannot be recovered in the outdoor unit; otherwise a serious accident such as breakage or injury is caused.
 Assembly/Cabling	After repair work, surely assemble the disassembled parts, and connect and lead the removed cables as before. Perform the work so that the cabinet or panel does not catch the inner cables. If incorrect assembly or incorrect cable connection was done, a disaster such as a leak or fire is caused at user's side.

 **WARNING**

 Insulator check	<p>After the work has finished, be sure to use an insulation tester set (500V mugger) to check the resistance is 2MΩ or more between the charge section and the non-charge metal section (Earth position).</p> <p>If the resistance value is low, a disaster such as a leak or electric shock is caused at user's side.</p>
 Ventilation	<p>When the refrigerant gas leaks during work, execute ventilation.</p> <p>If the refrigerant gas touches to a fire, poisonous gas generates. A case of leakage of the refrigerant and the closed room full with gas is dangerous because a shortage of oxygen occurs. Be sure to execute ventilation.</p>
 Be attentive to electric shock	<p>When checking the circuit inevitably under condition of the power-ON, use rubber gloves and others not to touch to the charging section.</p> <p>If touching to the charging section, an electric shock may be caused.</p>
 Compulsion	<p>When the refrigerant gas leaks, find up the leaked position and repair it surely.</p> <p>If the leaked position cannot be found up and the repair work is interrupted, pump-down and tighten the service valve, otherwise the refrigerant gas may leak into the room. The poisonous gas generates when gas touches to fire such as fan heater, stove or cooking stove though the refrigerant gas itself is innocuous.</p> <p>When installing equipment which includes a large amount of charged refrigerant such as a multi air conditioner in a sub-room, it is necessary that the density does not the limit even if the refrigerant leaks.</p> <p>If the refrigerant leaks and exceeds the limit density, an accident of shortage of oxygen is caused.</p> <p>For the installation/moving/reinstallation work, follow to the Installation Manual.</p> <p>If an incorrect installation is done, a trouble of the refrigerating cycle, water leak, electric shock or fire is caused.</p>
 Check after repair	<p>After repair work has finished, check there is no trouble.</p> <p>If check is not executed, a fire, electric shock or injury may be caused. For a check, turn off the power breaker.</p> <p>After repair work (installation of front panel and cabinet) has finished, execute a test run to check there is no generation of smoke or abnormal sound.</p> <p>If check is not executed, a fire or an electric shock is caused. Before test run, install the front panel and cabinet.</p>
 Check after reinstallation	<p>Check the following items after reinstallation.</p> <ol style="list-style-type: none"> 1) The earth wire is correctly connected. 2) The power cord is not caught in the product. 3) There is no inclination or unsteadiness and the installation is stable. <p>If check is not executed, a fire, an electric shock or an injury is caused.</p>

 **CAUTION**

 Put on gloves	<p>Be sure to put on gloves (*) during repair work.</p> <p>If not putting on gloves, an injury may be caused with the parts, etc.</p> <p>(*) Heavy gloves such as work gloves</p>
 Cooling check	<p>When the power was turned on, start to work after the equipment has been sufficiently cooled.</p> <p>As temperature of the compressor pipes and others became high due to cooling/heating operation, a burn may be caused.</p>

• New Refrigerant (R410A)

This air conditioner adopts a new HFC type refrigerant (R410A) which does not deplete the ozone layer.

1. Safety Caution Concerned to New Refrigerant

The pressure of R410A is high 1.6 times of that of the former refrigerant (R22). Accompanied with change of refrigerant, the refrigerating oil has been also changed. Therefore, be sure that water, dust, the former refrigerant or the former refrigerating oil is not mixed into the refrigerating cycle of the air conditioner with new refrigerant during installation work or service work. If an incorrect work or incorrect service is performed, there is a possibility to cause a serious accident. Use the tools and materials exclusive to R410A to purpose a safe work.

2. Cautions on Installation/Service

- 1) Do not mix the other refrigerant or refrigerating oil.

For the tools exclusive to R410A, shapes of all the joints including the service port differ from those of the former refrigerant in order to prevent mixture of them.

- 2) As the use pressure of the new refrigerant is high, use material thickness of the pipe and tools which are specified for R410A.
- 3) In the installation time, use clean pipe materials and work with great attention so that water and others do not mix in because pipes are affected by impurities such as water, oxide scales, oil, etc. Use the clean pipes.

Be sure to brazing with flowing nitrogen gas. (Never use gas other than nitrogen gas.)

- 4) For the earth protection, use a vacuum pump for air purge.
- 5) R410A refrigerant is azeotropic mixture type refrigerant. Therefore use liquid type to charge the refrigerant. (If using gas for charging, composition of the refrigerant changes and then characteristics of the air conditioner change.)

3. Pipe Materials

For the refrigerant pipes, copper pipe and joints are mainly used. It is necessary to select the most appropriate pipes to conform to the standard. Use clean material in which impurities adhere inside of pipe or joint to a minimum.

1) Copper pipe

<Piping>

The pipe thickness, flare finishing size, flare nut and others differ according to a refrigerant type.

When using a long copper pipe for R410A, it is recommended to select "Copper or copper-base pipe without seam" and one with bonded oil amount 40mg/10m or less. Also do not use crushed, deformed, discolored (especially inside) pipes. (Impurities cause clogging of expansion valves and capillary tubes.)

<Flare nut>

Use the flare nuts which are attached to the air conditioner unit.

2) Joint

The flare joint and socket joint are used for joints of the copper pipe. The joints are rarely used for installation of the air conditioner. However clear impurities when using them.

4. Tools

1. Required Tools for R410A

Mixing of different types of oil may cause a trouble such as generation of sludge, clogging of capillary, etc. Accordingly, the tools to be used are classified into the following three types.

- 1) Tools exclusive for R410A (Those which cannot be used for conventional refrigerant (R22))
- 2) Tools exclusive for R410A, but can be also used for conventional refrigerant (R22)
- 3) Tools commonly used for R410A and for conventional refrigerant (R22)

The table below shows the tools exclusive for R410A and their interchangeability.

Tools exclusive for R410A (The following tools for R410A are required.)

Tools whose specifications are changed for R410A and their interchangeability

No.	Used tool	Usage	R410A air conditioner installation		Conventional air conditioner installation
			Existence of new equipment for R410A	Whether conven- tional equipment can be used	Whether conventional equipment can be used
①	Flare tool	Pipe flaring	Yes	*(Note 1)	Yes
②	Copper pipe gauge for adjusting projection margin	Flaring by conventional flare tool	Yes	*(Note 1)	*(Note 1)
③	Torque wrench	Connection of flare nut	Yes	No	No
④	Gauge manifold	Evacuating, refrigerant charge, run check, etc.	Yes	No	No
⑤	Charge hose				
⑥	Vacuum pump adapter	Vacuum evacuating	Yes	No	Yes
⑦	Electronic balance for refrigerant charging	Refrigerant charge	Yes	Yes	Yes
⑧	Refrigerant cylinder	Refrigerant charge	Yes	No	No
⑨	Leakage detector	Gas leakage check	Yes	No	Yes
⑩	Charging cylinder	Refrigerant charge	(Note 2)	No	No

(Note 1) When flaring is carried out for R410A using the conventional flare tools, adjustment of projection margin is necessary. For this adjustment, a copper pipe gauge, etc. are necessary.

(Note 2) Charging cylinder for R410A is being currently developed.

General tools (Conventional tools can be used.)

In addition to the above exclusive tools, the following equipments which serve also for R22 are necessary as the general tools.

- | | |
|--|---|
| <ol style="list-style-type: none"> 1) Vacuum pump
Use vacuum pump by
attaching vacuum pump adapter. 2) Torque wrench 3) Pipe cutter 4) Reamer 5) Pipe bender 6) Level vial | <ol style="list-style-type: none"> 7) Screwdriver (+, -) 8) Spanner or Monkey wrench 9) Hole core drill 10) Hexagon wrench (Opposite side 4mm) 11) Tape measure 12) Metal saw |
|--|---|

Also prepare the following equipments for other installation method and run check.

- | | |
|--|--|
| <ol style="list-style-type: none"> 1) Clamp meter 2) Thermometer | <ol style="list-style-type: none"> 3) Insulation resistance tester 4) Electroscope |
|--|--|

1. SPECIFICATIONS

1-1. Indoor Unit

1-1-1. 4-Way Air Discharge Cassette Type

<Digital Inverter>

Model		Indoor unit	RAV-	SM563UT-E	SM803UT-E	SM1103UT-E	SM1403UT-E
		Outdoor unit	RAV-	SM563AT-E	SM803AT-E	SM1103AT-E	SM1403AT-E
Cooling capacity			(kW)	5.3	6.7	10.0	12.1
Heating capacity			(kW)	5.6	8.0	11.2	14.0
Power supply		1 phase 230V (220 – 240V) 50Hz					
Electrical characteristics	Cooling	Running current	(A)	7.89 – 7.24	10.11 – 9.26	14.42 – 13.21	7.67 – 16.19
		Power consumption	(kW)	1.65	2.09	3.11	3.77
		Power factor	(%)	95	94	98	97
		EER	(W/W)	3.21	3.21	3.22	3.21
		Energy efficiency class *		A	A	A	A
		Energy rating **		4.5	4.0	4.5	4.0
	Heating	Running current	(A)	6.89 – 6.32	10.69 – 9.80	14.38 – 13.18	18.18 – 16.67
		Power consumption	(kW)	1.44	2.21	3.10	3.88
		Power factor	(%)	95	94	98	97
		COP	(W/W)	3.89	3.62	3.61	3.61
		Energy efficiency class *		A	A	A	A
		Energy rating **		6.0	4.5	5.0	4.0
Appearance	Main unit		Zinc hot dipping steel plate				
	Ceiling panel (Sold separately)	Model	RBC-U21PG (W)-E2				
		Panel color	Moon-white (Muncel 2.5GY 9.0/0.5)				
Outer dimension	Main unit	Height	(mm)	256	256	319	319
		Width	(mm)	840	840	840	840
		Depth	(mm)	840	840	840	840
	Ceiling panel (Sold separately)	Height	(mm)	35	35	35	35
		Width	(mm)	950	950	950	950
		Depth	(mm)	950	950	950	950
Total weight	Main unit		(kg)	21	22	26	26
	Ceiling panel (Sold separately)		(kg)	4.5	4.5	4.5	4.5
Heat exchanger		Finned tube					
Fan unit	Fan			Turbo fan	Turbo fan	Turbo fan	Turbo fan
	Standard air flow	H/M/L	(m ³ /min)	17.5/13.9/12.1	20.0/15.7/13.6	28.0/22.0/18.0	34.0/25.0/20.0
	Motor		(W)	60	60	90	90
Air filter		TCB-LF1601UE2, UFM1601UE, UFH1601UE					
Controller (Sold separately)		RBC-AMT31E, AS21E2, TCB-SC642TLE2, AX21U(W)-E2					
Connecting pipe	Gas side	(mm)	12.7	15.9	15.9	15.9	
	Liquid side	(mm)	6.4	9.5	9.5	9.5	
	Drain port	(mm)	VP25				
Sound pressure level	H/M/L	(dB•A)	32/29/27	37/31/28	39/36/33	47/38/34	
Sound power level	H/M/L	(dB•A)	47/44/42	52/46/43	54/51/48	62/53/49	

* : IEC standard, ** : AS standard

<Super Digital Inverter>

Model	Indoor unit	RAV-	SM563UT-E	SM803UT-E	SP1102UT-E	SM1403UT-E
	Outdoor unit	RAV-	SP562AT-E	SP802AT-E	SP1102AT-E	SP1402AT-E
Cooling capacity		(kW)	5.3	7.1	10.0	12.5
Heating capacity		(kW)	5.6	8.0	11.2	14.0
Power supply			1 phase 230V (220 – 240V) 50Hz			
Electrical characteristics	Cooling	Running current (A)	7.17 – 6.57	8.95 – 8.21	11.24 – 10.31	16.51 – 15.14
		Power consumption (kW)	1.53	1.93	2.40	3.56
		Power factor (%)	97	98	97	98
		EER (W/W)	3.46	3.68	4.17	3.51
		Energy efficiency class *	A	A	A	A
		Energy rating **	—	—	—	—
	Heating	Running current (A)	5.62 – 5.15	9.42 – 8.63	12.28 – 11.25	16.60 – 15.22
		Power consumption (kW)	1.20	2.03	2.62	3.58
		Power factor (%)	97	98	97	98
		COP (W/W)	4.67	3.94	4.27	3.91
		Energy efficiency class *	A	A	A	A
		Energy rating **	—	—	—	—
Appearance	Main unit		Zinc hot dipping steel plate			
	Ceiling panel (Sold separately)	Model	RBC-U21PG (W)-E2			
		Panel color	Moon-white (Muncel 2.5GY 9.0/0.5)			
Outer dimension	Main unit	Height (mm)	256	256	319	319
		Width (mm)	840	840	840	840
		Depth (mm)	840	840	840	840
	Ceiling panel (Sold separately)	Height (mm)	35	35	35	35
		Width (mm)	950	950	950	950
		Depth (mm)	950	950	950	950
Total weight	Main unit (kg)		21	22	26	26
	Ceiling panel (Sold separately) (kg)		4.5	4.5	4.5	4.5
Heat exchanger			Finned tube			
Fan unit	Fan		Turbo fan	Turbo fan	Turbo fan	Turbo fan
	Standard air flow	H/M/L (m ³ /min)	17.5/13.9/12.1	20.0/15.7/13.6	28.0/22.0/18.0	33.0/25.0/20.0
	Motor (W)		60	60	90	90
Air filter			TCB-LF1601UE2, UFM1601UE, UFH1601UE			
Controller (Sold separately)			RBC-AMT31E, AS21E2, TCB-SC642TLE2, AX21U (W)-E2			
Connecting pipe	Gas side (mm)	12.7	15.9	15.9	15.9	
	Liquid side (mm)	6.4	9.5	9.5	9.5	
	Drain port (mm)	VP25				
Sound pressure level	H/M/L (dB•A)	32/29/27	37/31/28	39/36/33	42/38/34	
Sound power level	H/M/L (dB•A)	47/44/42	52/46/43	54/51/48	57/53/49	

* : IEC standard, ** : AS standard

1-1-2. Concealed Duct Type

<Digital Inverter>

Model	Indoor unit		RAV-	SM562BT-E	SM802BT-E	SM1102BT-E	SM1402BT-E	
	Outdoor unit		RAV-	SM563AT-E	SM803AT-E	SM1103AT-E	SM1403AT-E	
Cooling capacity			(kW)	5.0	7.1	10.0	12.5	
Heating capacity			(kW)	5.6	8.0	11.2	14.0	
Power supply				1 phase 230V (220 – 240V) 50Hz				
Electrical characteristics	Cooling	Running current	(A)	8.52 – 7.81	12.23 – 11.21	16.50 – 15.10	20.70 – 19.00	
		Power consumption	(kW)	1.78	2.53	3.56	4.42	
		Power factor	(%)	95	94	98	97	
		EER	(W/W)	2.81	2.81	2.81	2.83	
		Energy efficiency class *		C	C	C	C	
		Energy rating **		3.0	3.0	3.5	3.0	
	Heating	Running current	(A)	8.18 – 7.50	11.65 – 10.68	14.56 – 13.35	18.88 – 17.31	
		Power consumption	(kW)	1.71	2.41	3.14	4.03	
		Power factor	(%)	95	94	98	97	
		COP	(W/W)	3.27	3.32	3.57	3.47	
		Energy efficiency class *		C	C	B	B	
		Energy rating **		3.0	3.5	5.0	4.0	
Appearance	Main unit			Zinc hot dipping steel plate				
	Ceiling panel (Sold separately)	Model		—				
		Panel color		—				
Outer dimension	Main unit	Height	(mm)	320	320	320	320	
		Width	(mm)	700	1000	1350	1350	
		Depth	(mm)	800	800	800	800	
	Ceiling panel (Sold separately)	Height	(mm)	—	—	—	—	
		Width	(mm)	—	—	—	—	
		Depth	(mm)	—	—	—	—	
Total weight	Main unit			(kg)	30	39	54	54
	Ceiling panel (Sold separately)			(kg)	—	—	—	—
Heat exchanger				Finned tube				
Fan unit	Fan			Centrifugal	Centrifugal	Centrifugal	Centrifugal	
	Standard air flow	H/M/L	(m ³ /min)	13.0/11.9/9.8	19.0/16.2/13.3	27.0/23.0/18.9	33.0/28.0/23.1	
	Motor			(W)	120	120	120	120
Air filter			TCB-	UFM21BE UFM61BE	UFM11BFCE UFM31BE UFH51BFCE UFM71BE	UFM21BFCE UFM41BE UFH61BFCE UFH81BE		
Controller (Sold separately)				RBC-AMT31E, AS21E2, TCB-SC642TLE2, AX21E2				
Connecting pipe	Gas side	(mm)	12.7	15.9	15.9	15.9		
	Liquid side	(mm)	6.4	9.5	9.5	9.5		
	Drain port	(mm)	VP25					
Sound pressure level	H/M/L	(dB•A)	40/37/33	40/37/34	42/39/36	44/41/38		
Sound power level	H/M/L	(dB•A)	55/52/48	55/52/49	57/54/51	59/56/53		

* : IEC standard, ** : AS standard

<Super Digital Inverter>

Model	Indoor unit		RAV-	SM562BT-E	SM802BT-E	SM1102BT-E	SM1402BT-E
	Outdoor unit		RAV-	SP562AT-E	SP802AT-E	SP1102AT-E	SP1402AT-E
Cooling capacity			(kW)	5.0	7.1	10.0	12.5
Heating capacity			(kW)	5.6	8.0	11.2	14.0
Power supply				1 phase 230V (220 – 240V) 50Hz			
Electrical characteristics	Cooling	Running current	(A)	6.51 – 5.97	9.74 – 8.93	11.72 – 10.74	18.09 – 16.58
		Power consumption	(kW)	1.39	2.10	2.50	3.90
		Power factor	(%)	97	98	97	98
		EER	(W/W)	3.60	3.38	4.00	3.21
		Energy efficiency class *		A	A	A	A
		Energy rating **		—	—	—	—
	Heating	Running current	(A)	7.26 – 6.66	9.74 – 8.93	11.72 – 10.74	16.70 – 15.31
		Power consumption	(kW)	1.55	2.10	2.50	3.60
		Power factor	(%)	97	98	97	98
		COP	(W/W)	3.61	3.81	4.48	3.89
		Energy efficiency class *		A	A	A	A
		Energy rating **		—	—	—	—
Appearance	Main unit		Zinc hot dipping steel plate				
	Ceiling panel (Sold separately)	Model	—				
		Panel color	—				
Outer dimension	Main unit	Height	(mm)	320	320	320	320
		Width	(mm)	700	1000	1350	1350
		Depth	(mm)	800	800	800	800
	Ceiling panel (Sold separately)	Height	(mm)	—	—	—	—
		Width	(mm)	—	—	—	—
		Depth	(mm)	—	—	—	—
Total weight	Main unit		(kg)	30	39	54	54
	Ceiling panel (Sold separately)		(kg)	—	—	—	—
Heat exchanger				Finned tube			
Fan unit	Fan			Centrifugal	Centrifugal	Centrifugal	Centrifugal
	Standard air flow	H/M/L	(m ³ /min)	13.0/11.9/9.8	19.0/16.2/13.3	27.0/23.0/18.9	33.0/28.0/23.1
	Motor		(W)	120	120	120	120
Air filter			TCB-	UFM21BE UFM61BE	UFM11BFCE UFM31BE UFH51BFCE UFM71BE	UFM21BFCE UFM 41BE UFH61BFCE UFH 81BE	
Controller (Sold separately)				RBC-AMT31E, AS21E2, TCB-SC642TLE2, AX21E2			
Connecting pipe	Gas side		(mm)	12.7	15.9	15.9	15.9
	Liquid side		(mm)	6.4	9.5	9.5	9.5
	Drain port		(mm)	VP25			
Sound pressure level		H/M/L	(dB•A)	40/37/33	40/37/34	42/39/36	44/41/38
Sound power level		H/M/L	(dB•A)	55/52/48	55/52/49	57/54/51	59/56/53

* : IEC standard, ** : AS standard

1-1-3. Under Ceiling Type

<Digital Inverter>

Model	Indoor unit		RAV-	SM562CT-E	SM802CT-E	SM1102CT-E	SM1402CT-E	
	Outdoor unit		RAV-	SM563AT-E	SM803AT-E	SM1103AT-E	SM1403AT-E	
Cooling capacity			(kW)	5.0	7.0	10.0	12.3	
Heating capacity			(kW)	5.6	8.0	11.2	14.0	
Power supply				1 phase 230V (220 – 240V) 50Hz				
Electrical characteristics	Cooling	Running current	(A)	8.71 – 7.98	12.23 – 11.21	16.20 – 14.90	21.18 – 19.40	
		Power consumption	(kW)	1.82	2.53	3.51	4.52	
		Power factor	(%)	95	94	98	97	
		EER	(W/W)	2.75	2.77	2.85	2.72	
		Energy efficiency class *		D	D	C	D	
		Energy rating **		2.5	2.5	3.0	2.5	
	Heating	Running current	(A)	7.85 – 7.19	11.94 – 10.95	14.84 – 13.61	19.40 – 17.78	
		Power consumption	(kW)	1.64	2.47	3.20	4.14	
		Power factor	(%)	95	94	98	97	
		COP	(W/W)	3.41	3.24	3.50	3.38	
		Energy efficiency class *		B	C	B	C	
		Energy rating **		4.0	4.0	5.0	3.5	
Appearance	Main unit			Shine white				
	Ceiling panel (Sold separately)	Model		—				
		Panel color		—				
Outer dimension	Main unit	Height	(mm)	210	210	210	210	
		Width	(mm)	910	1180	1595	1595	
		Depth	(mm)	680	680	680	680	
	Ceiling panel (Sold separately)	Height	(mm)	—	—	—	—	
		Width	(mm)	—	—	—	—	
		Depth	(mm)	—	—	—	—	
Total weight	Main unit			(kg)	21	25	33	33
	Ceiling panel (Sold separately)			(kg)	—	—	—	—
Heat exchanger				Finned tube				
Fan unit	Fan			Centrifugal	Centrifugal	Centrifugal	Centrifugal	
	Standard air flow	H/M/L	(m ³ /min)	13.0/11.2/10.0	18.5/16.7/14.6	27.5/24.0/21.2	30.0/26.0/23.1	
	Motor			(W)	60	60	120	120
Air filter				Attached main unit				
Controller (Sold separately)				RBC-AMT31E, AS21E2, TCB-SC642TLE2, AX21E2				
Connecting pipe	Gas side		(mm)	12.7	15.9	15.9	15.9	
	Liquid side		(mm)	6.4	9.5	9.5	9.5	
	Drain port		(mm)	VP25				
Sound pressure level	H/M/L	(dB•A)	36/33/30	38/36/33	41/38/35	43/40/37		
Sound power level	H/M/L	(dB•A)	51/48/45	53/51/48	56/53/50	58/55/52		

* : IEC standard, ** : AS standard

<Super Digital Inverter>

Model	Indoor unit		RAV-	SM562CT-E	SM802CT-E	SM1102CT-E	SM1402CT-E
	Outdoor unit		RAV-	SP562AT-E	SP802AT-E	SP1102AT-E	SP1402AT-E
Cooling capacity			(kW)	5.0	7.1	10.0	12.5
Heating capacity			(kW)	5.6	8.0	11.2	14.0
Power supply				1 phase 230V (220 – 240V) 50Hz			
Electrical characteristics	Cooling	Running current	(A)	6.61 – 6.06	9.74 – 8.93	11.24 – 10.31	18.09 – 16.58
		Power consumption	(kW)	1.41	2.10	2.40	3.90
		Power factor	(%)	97	98	97	98
		EER	(W/W)	3.55	3.38	4.17	3.21
		Energy efficiency class *		A	A	A	A
		Energy rating **		—	—	—	—
	Heating	Running current	(A)	7.03 – 6.44	10.20 – 9.35	11.72 – 10.74	17.39 – 15.94
		Power consumption	(kW)	1.50	2.20	2.50	3.75
		Power factor	(%)	97	98	97	98
		COP	(W/W)	3.73	3.64	4.48	3.73
		Energy efficiency class *		A	A	A	A
		Energy rating **		—	—	—	—
Appearance	Main unit			Shine white			
	Ceiling panel (Sold separately)	Model		—			
		Panel color		—			
Outer dimension	Main unit	Height	(mm)	210	210	210	210
		Width	(mm)	910	1180	1595	1595
		Depth	(mm)	680	680	680	680
	Ceiling panel (Sold separately)	Height	(mm)	—	—	—	—
		Width	(mm)	—	—	—	—
		Depth	(mm)	—	—	—	—
Total weight	Main unit		(kg)	21	25	33	33
	Ceiling panel (Sold separately)		(kg)	—	—	—	—
Heat exchanger				Finned tube			
Fan unit	Fan			Centrifugal	Centrifugal	Centrifugal	Centrifugal
	Standard air flow	H/M/L	(m ³ /min)	13.0/11.2/10.0	18.5/16.7/14.6	27.5/24.0/21.2	30.0/26.0/23.1
	Motor			(W)	60	60	120
Air filter				Attached main unit			
Controller (Sold separately)				RBC-AMT31E, AS21E2, TCB-SC642TLE2, AX21E2			
Connecting pipe	Gas side		(mm)	12.7	15.9	15.9	15.9
	Liquid side		(mm)	6.4	9.5	9.5	9.5
	Drain port		(mm)	VP25			
Sound pressure level		H/M/L	(dB•A)	36/33/30	38/36/33	41/38/35	43/40/37
Sound power level		H/M/L	(dB•A)	51/48/45	53/51/48	56/53/50	58/55/52

* : IEC standard, ** : AS standard

1-1-4. Twin Type

<Digital Inverter>

Model	Type		4-Way Air Cassette		Concealed Duct		Under Ceiling		
	Indoor unit 1	RAV-	SM563UT-E	SM803UT-E	SM562BT-E	SM802BT-E	SM562CT-E	SM802CT-E	
	Indoor unit 2	RAV-	SM563UT-E	SM803UT-E	SM562BT-E	SM802BT-E	SM562CT-E	SM802CT-E	
	Outdoor unit	RAV-	SM1103AT-E	SM1403AT-E	SM1103AT-E	SM1403AT-E	SM1103AT-E	SM1403AT-E	
Cooling capacity		(kW)	10.0	12.5	10.0	12.5	10.0	12.3	
Heating capacity		(kW)	11.2	14.0	11.2	14.0	11.2	14.0	
Indoor unit									
Power supply			1 phase 230V (220 – 240V) 50Hz						
Electrical characteristics	Cooling	Running current (A)	14.40–13.20	19.17–17.57	16.51–15.14	20.71–18.99	16.28–14.92	21.18–19.42	
		Power consumption (kW)	3.11	4.09	3.56	4.42	3.51	4.52	
		Power factor (%)	98	97	98	97	98	97	
		EER (W/W)	3.22	3.06	2.81	2.83	2.85	2.72	
		Energy efficiency class *	A	B	C	C	C	D	
	Heating	Running current (A)	14.40–13.20	18.74–17.18	14.56–13.35	18.88–17.31	14.84–13.61	19.40–7.78	
		Power consumption (kW)	3.10	4.00	3.14	4.03	3.20	4.14	
		Power factor (%)	98	97	98	97	98	97	
		COP (W/W)	3.61	3.50	3.57	3.47	3.50	3.38	
		Energy efficiency class *	A	B	B	B	B	C	
Fan unit	Fan		Turbo fan	Turbo fan	Centrifugal	Centrifugal	Centrifugal	Centrifugal	
	Standard air flow	H/M/L (m ³ /min)	17.5/ 13.9/12.1	20.0/ 15.7/13.6	13.0/ 11.9/9.8	19.0/ 16.2/13.3	13.0/ 11.2/10.0	18.5/ 16.7/14.6	
	Motor (W)		60	60	120	120	60	60	
Sound pressure level		H/M/L (dB•A)	32/29/27	34/31/28	40/37/33	40/37/34	36/33/30	38/36/33	
Sound power level		H/M/L (dB•A)	47/44/42	49/46/43	55/52/48	55/52/49	51/48/45	53/51/48	
Outdoor unit									
Power supply			1 phase 230V (220 – 240V) 50Hz (Power exclusive to outdoor is required.)						
Inter connecting pipes	Standard length (m)		7.5	7.5	7.5	7.5	7.5	7.5	
	Min. length (m)		5.0	5.0	5.0	5.0	5.0	5.0	
	Max. total length (m)		50	50	50	50	50	50	
	Over 30m		40g/m (31m to 50m)						
	Height difference	Outdoor lower (m)		30	30	30	30	30	30
		Outdoor high (m)		30	30	30	30	30	30
Fan unit	Fan		Propeller fan						
	Standard air flow high (m ³ /min)		75	75	75	75	75	75	
	Motor (W)		100	100	100	100	100	100	
Connecting pipe	Gas side	Main (mm)	15.9	15.9	15.9	15.9	15.9	15.9	
		Sub (mm)	12.7	12.7	12.7	15.9	12.7	15.9	
	Liquid side	Main (mm)	9.5	9.5	9.5	9.5	9.5	9.5	
		Sub (mm)	6.4	6.4	6.4	9.5	6.4	9.5	
Sound pressure level		Cooling/Heating (dB•A)	53/54	53/54	53/54	53/54	53/54	53/54	
Sound power level		Cooling/Heating (dB•A)	70/71	70/71	70/71	70/71	70/71	70/71	

* : IEC standard

<Super Digital Inverter>

Model	Type		4-Way Air Cassette		Concealed Duct		Under Ceiling	
	Indoor unit 1	RAV-	SM563UT-E	SM803UT-E	SM562BT-E	SM802BT-E	SM562CT-E	SM802CT-E
	Indoor unit 2	RAV-	SM563UT-E	SM803UT-E	SM562BT-E	SM802BT-E	SM562CT-E	SM802CT-E
	Outdoor unit	RAV-	SP1102AT-E	SP1402AT-E	SP1102AT-E	SP1402AT-E	SP1102AT-E	SP1402AT-E
Cooling capacity		(kW)	10.0	12.5	10.0	12.5	10.0	12.3
Heating capacity		(kW)	11.2	14.0	11.2	14.0	11.2	14.0
Indoor unit								
Power supply			1 phase 230V (220 – 240V) 50Hz					
Electrical characteristics	Cooling	Running current (A)	11.24–10.31	16.51–15.14	11.72–10.74	18.09–16.58	11.24–10.31	18.09–16.58
		Power consumption (kW)	2.40	3.56	2.50	3.90	2.40	3.90
		Power factor (%)	97	98	97	98	97	98
		EER (W/W)	4.17	3.51	4.00	3.21	4.17	3.21
		Energy efficiency class *	A	A	A	A	A	A
	Heating	Running current (A)	11.95–10.95	16.60–15.22	11.95–10.95	16.70–15.31	11.95–10.95	17.39–15.94
		Power consumption (kW)	2.55	3.58	2.55	3.60	2.55	3.75
		Power factor (%)	97	98	97	98	97	98
		COP (W/W)	4.39	3.91	4.39	3.89	4.39	3.79
		Energy efficiency class *	A	A	A	A	A	A
Fan unit	Fan		Turbo fan	Turbo fan	Centrifugal	Centrifugal	Centrifugal	Centrifugal
	Standard air flow	H/M/L (m ³ /min)	17.5/ 13.9/12.1	20.0/ 15.7/13.6	13.0/ 11.9/9.8	19.0/ 16.2/13.3	13.0/ 11.2/10.0	18.5/ 16.7/14.6
	Motor (W)		60	60	120	120	60	60
Sound pressure level		H/M/L (dB•A)	32/29/27	34/31/28	40/37/33	40/37/34	36/33/30	38/36/33
Sound power level		H/M/L (dB•A)	47/44/42	49/46/43	55/52/48	55/52/49	51/48/45	53/51/48
Outdoor unit								
Power supply			1 phase 230V (220 – 240V) 50Hz (Power exclusive to outdoor is required.)					
Inter connecting pipes	Standard length (m)		7.5	7.5	7.5	7.5	7.5	7.5
	Min. length (m)		5.0	5.0	5.0	5.0	5.0	5.0
	Max. total length (m)		50	50	50	50	50	50
	Over 30m		40g/m (31m to 50m)					
	Height difference	Outdoor lower (m)	30	30	30	30	30	30
		Outdoor high (m)	30	30	30	30	30	30
Fan unit	Fan		Propeller fan					
	Standard air flow high (m ³ /min)		125	125	125	125	125	125
	Motor (W)		63 + 63	63 + 63	63 + 63	63 + 63	63 + 63	63 + 63
Connecting pipe	Gas side	Main (mm)	15.9	15.9	15.9	15.9	15.9	15.9
		Sub (mm)	12.7	15.9	12.7	15.9	12.7	15.9
	Liquid side	Main (mm)	9.5	9.5	9.5	9.5	9.5	9.5
		Sub (mm)	6.4	9.5	6.4	9.5	6.4	9.5
Sound pressure level		Cooling/Heating (dB•A)	49/51	53/54	49/51	53/54	49/51	53/54
Sound power level		Cooling/Heating (dB•A)	66/68	70/71	66/68	70/71	66/68	70/71

* : IEC standard

1-2. Outdoor Unit

<Digital Inverter>

Model name		RAV-	SM563AT-E	SM803AT-E	SM1103AT-E	SM1403AT-E
Power supply		1 phase 230V (220 – 240V) 50Hz (Power exclusive to outdoor is required.)				
Compressor	Type	Hermetic compressor				
	Motor (kW)	1.1	1.6	2.5	3.0	
	Pole	4	4	4	4	
Refrigerant charged (kg)		1.0	1.7	2.8	2.8	
Refrigerant control		Pulse motor valve				
Inter connecting pipe	Standard length (m)	7.5	7.5	7.5	7.5	
	Min. length (m)	5.0	5.0	5.0	5.0	
	Max. total length (m)	30	30	50	50	
	Additional refrigerant charge under long piping connector		20g/m (21m to 30m)	40g/m (21m to 30m)	40g/m (31m to 50m)	40g/m (31m to 50m)
	Height difference	Outdoor lower (m)	30	30	30	30
Outdoor higher (m)		30	30	30	30	
Outer dimension	Height (mm)	550	550	795	795	
	Width (mm)	780	780	900	900	
	Depth (mm)	290	290	320	320	
Appearance		Silky shade (Muncel 1Y8.5/0.5)				
Total weight (kg)		38	44	77	77	
Heat exchanger		Finned tube				
Fan unit	Fan	Propeller fan				
	Standard air flow (m ³ /h)	40	45	75	75	
	Motor (W)	43	43	100	100	
Connecting pipe	Gas side (mm)	12.7	15.9	15.9	15.9	
	Liquid side (mm)	6.4	9.5	9.5	9.5	
Sound pressure level	Cooling/Heating (dB•A)	46/48	48/50	53/54	54/54	
Sound power level	Cooling/Heating (dB•A)	63/65	65/67	70/71	71/71	
Outside air temperature, Cooling (°C)		43 to -15				
Outside air temperature, Heating (°C)		15 to -15				

<Super Digital Inverter>

Model name		RAV-	SP562AT-E	SP802AT-E	SP1102AT-E	SP1402AT-E
Power supply		1 phase 230V (220 – 240V) 50Hz (Power exclusive to outdoor is required.)				
Compressor	Type	Hermetic compressor				
	Motor (kW)	2.0	2.0	3.75	3.75	
	Pole	4	4	4	4	
Refrigerant charged (kg)		1.5	2.1	2.95	2.95	
Refrigerant control		Pulse motor valve				
Inter connecting pipe	Standard length (m)	7.5	7.5	7.5	7.5	
	Min. length (m)	5.0	5.0	5.0	5.0	
	Max. total length (m)	50	50	70	70	
	Additional refrigerant charge under long piping connector		20g/m (21m to 50m)	40g/m (31m to 50m)	40g/m (31m to 70m)	40g/m (31m to 70m)
	Height difference	Outdoor lower (m)	30	30	30	30
Outdoor higher (m)		30	30	30	30	
Outer dimension	Height (mm)	795	795	1340	1340	
	Width (mm)	900	900	900	900	
	Depth (mm)	320	320	320	320	
Appearance		Silky shade (Muncel 1Y8.5/0.5)				
Total weight (kg)		55	62	95	95	
Heat exchanger		Finned tube				
Fan unit	Fan	Propeller fan				
	Standard air flow (m ³ /h)	57	57	125	125	
	Motor (W)	63	63	63 + 63	63 + 63	
Connecting pipe	Gas side (mm)	12.7	15.9	15.9	15.9	
	Liquid side (mm)	6.4	9.5	9.5	9.5	
Sound pressure level	Cooling/Heating (dB•A)	46/47	47/49	49/51	53/54	
Sound power level	Cooling/Heating (dB•A)	63/64	64/66	66/68	70/71	
Outside air temperature, Cooling (°C)		43 to –15				
Outside air temperature, Heating (°C)		15 to –15				

1-3. Operation Characteristic Curve

• Operation characteristic curve <Digital Inverter>

RAV-SM563AT-E, RAV-SM803AT-E

<Cooling>

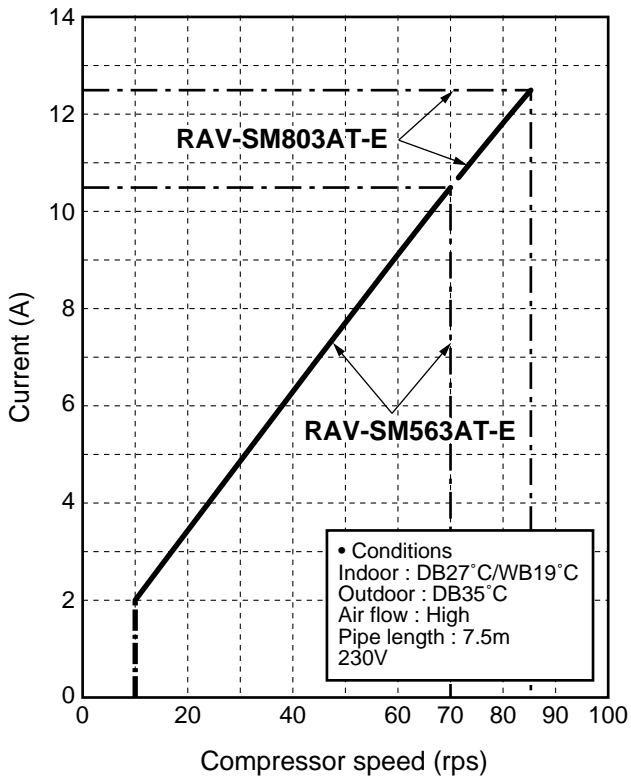

<Heating>

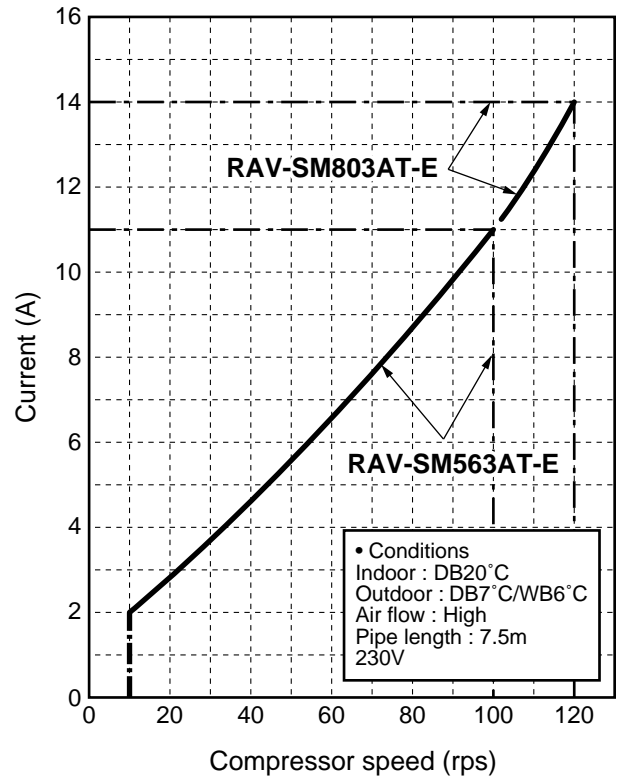

RAV-SM1103AT-E, RAV-SM1403AT-E

<Cooling>

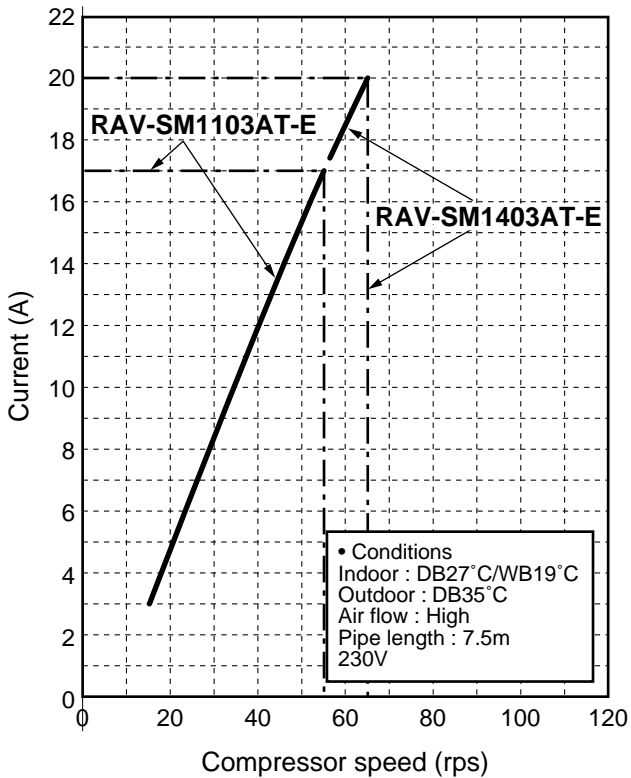

<Heating>

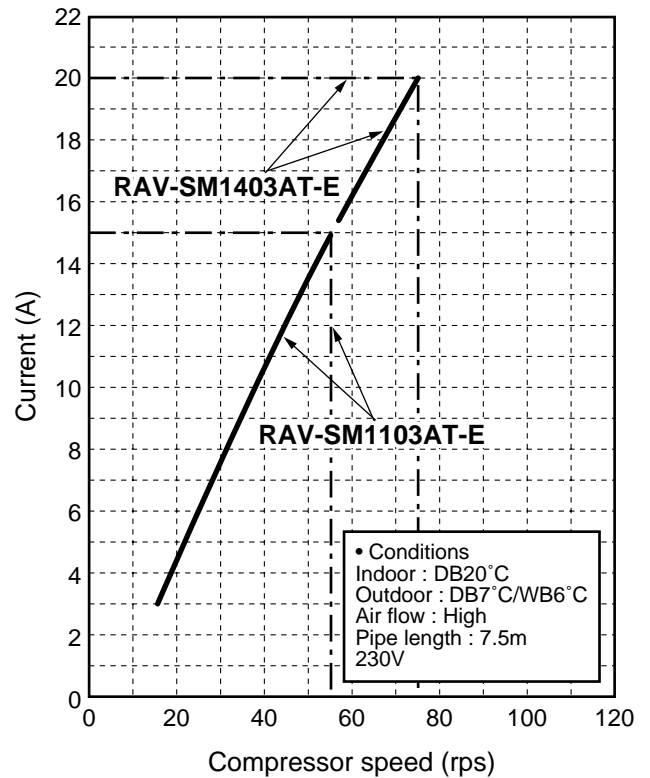

• Operation characteristic curve <Super Digital Inverter>

RAV-SP562AT-E, RAV-SP802AT-E

<Cooling>

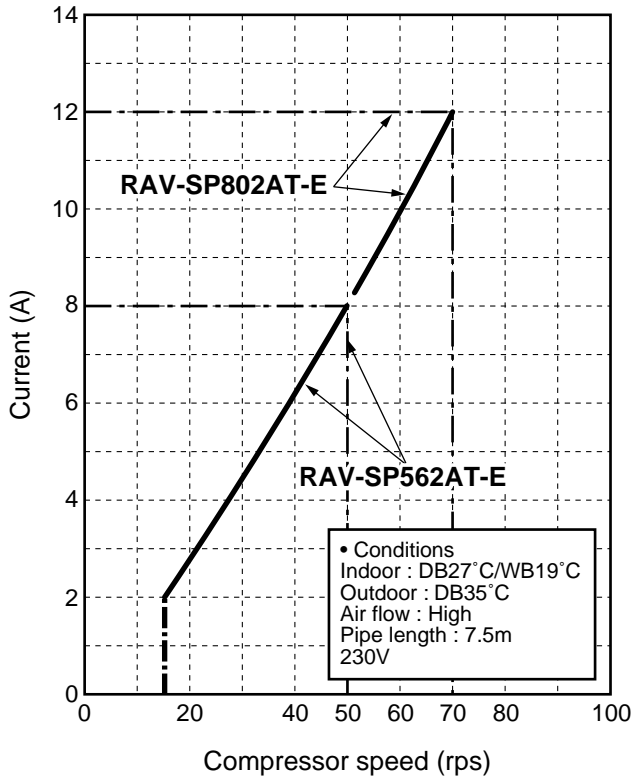

<Heating>

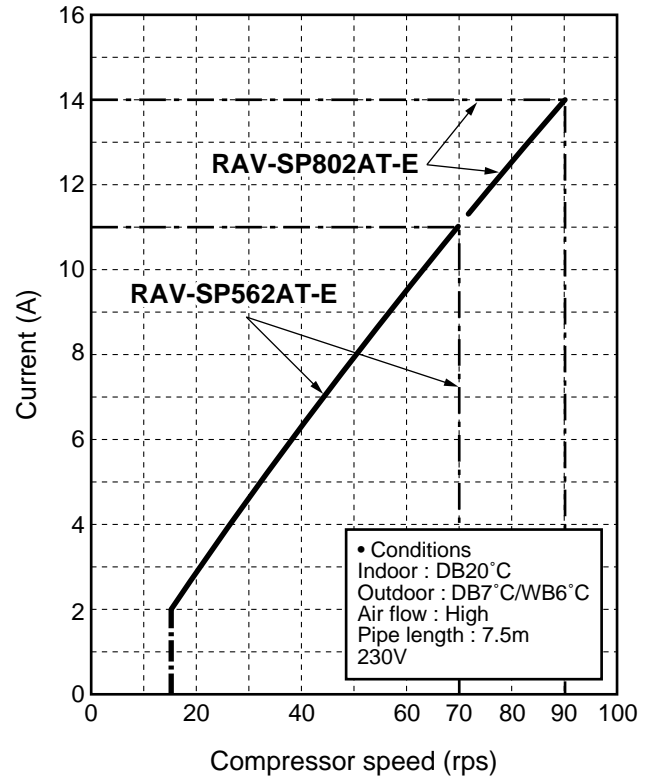

RAV-SP1102AT-E, RAV-SP1402AT-E

<Cooling>

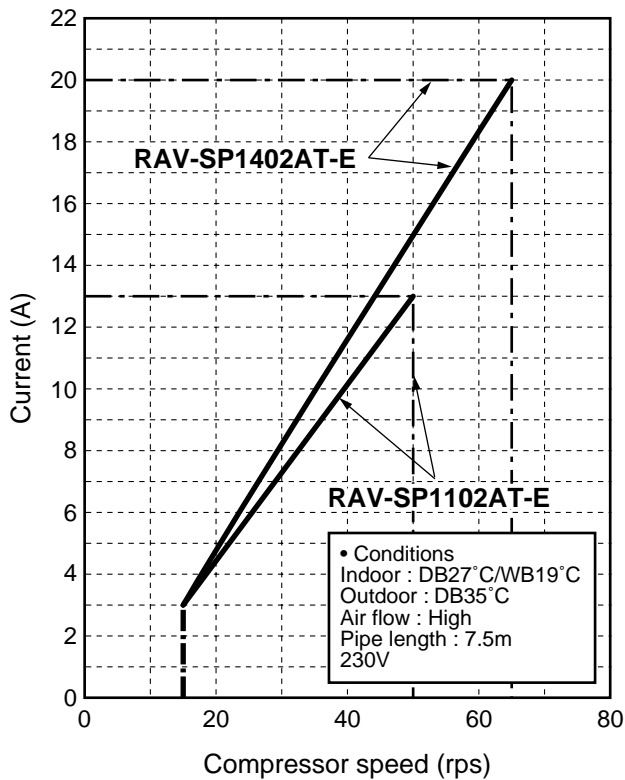

<Heating>

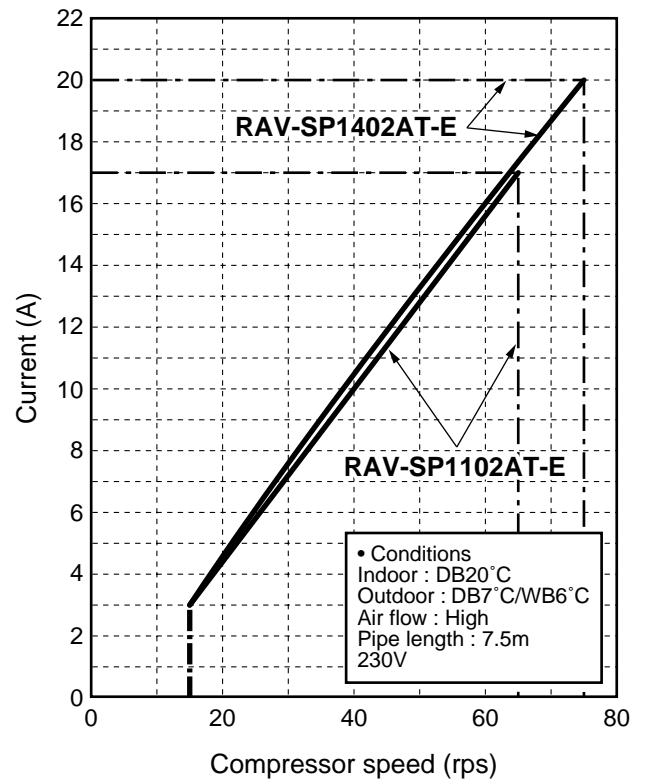

• Capacity variation ratio according to temperature

RAV-SM563AT-E, RAV-SM803AT-E, RAV-SM1103AT-E, RAV-SM1403AT-E

RAV-SP562AT-E, RAV-SP802AT-E, RAV-SP1102AT-E, RAV-SP1402AT-E

<Cooling>

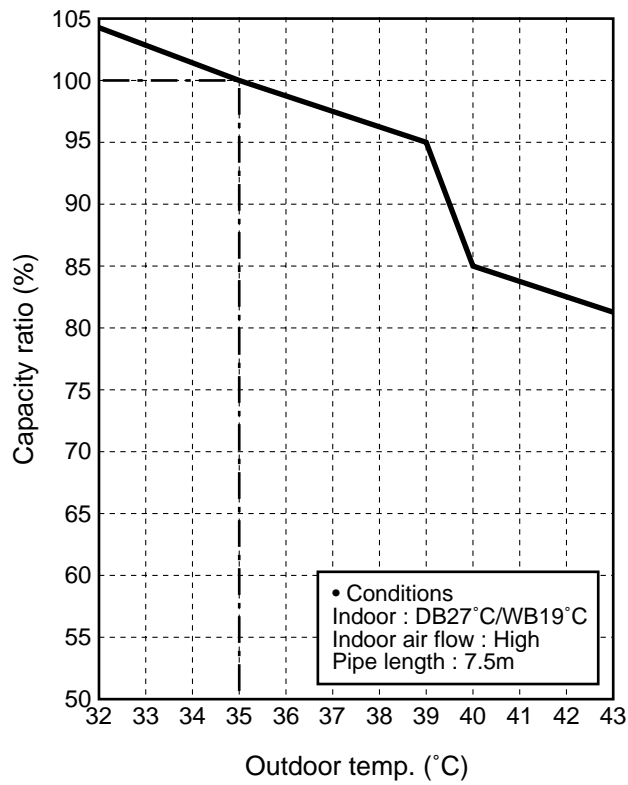

<Heating>

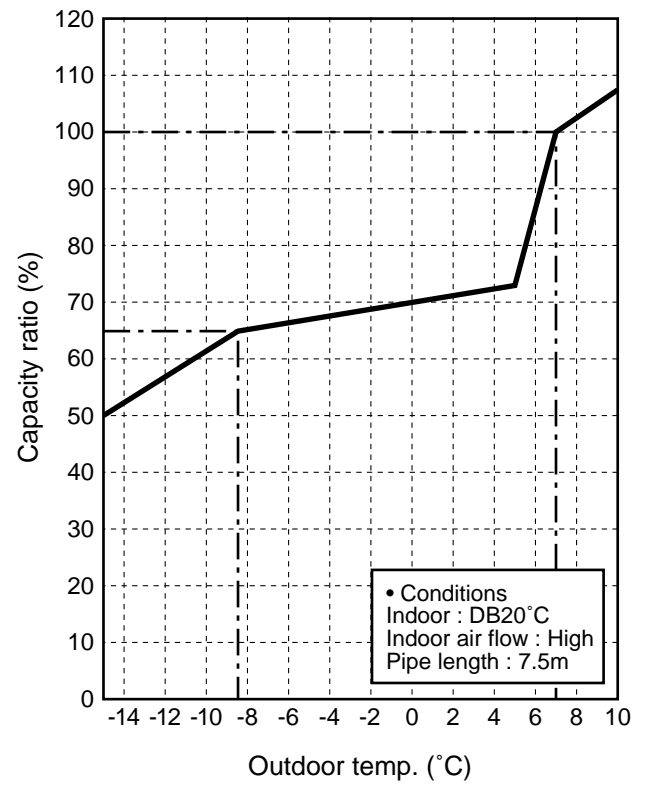

2. AIR DUCTING WORK

2-1. Static Pressure Characteristics of Each Model

RAV-SM562BT-E, RAV-SM802BT-E, RAV-SM1102BT-E, RAV-SM1402BT-E

Fig. 1 RAV-SM562BT-E (Round duct)

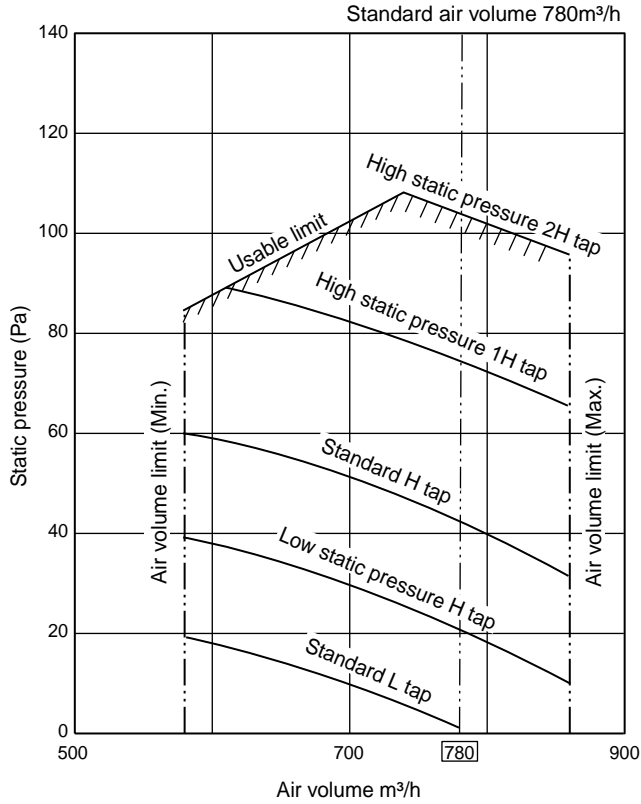

Fig. 3 RAV-SM802BT-E (Round duct)

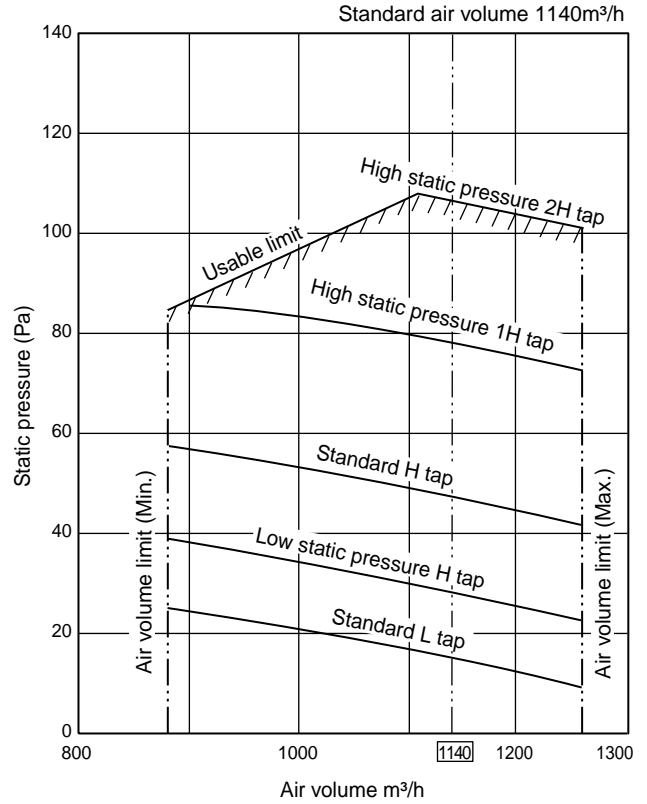

Fig. 2 RAV-SM562BT-E (Square duct)

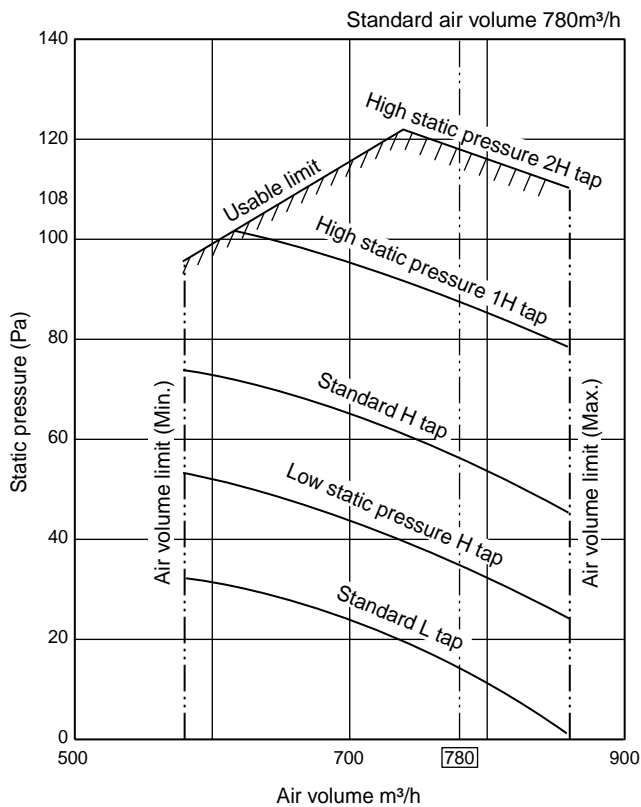

Fig. 4 RAV-SM802BT-E (Square duct)

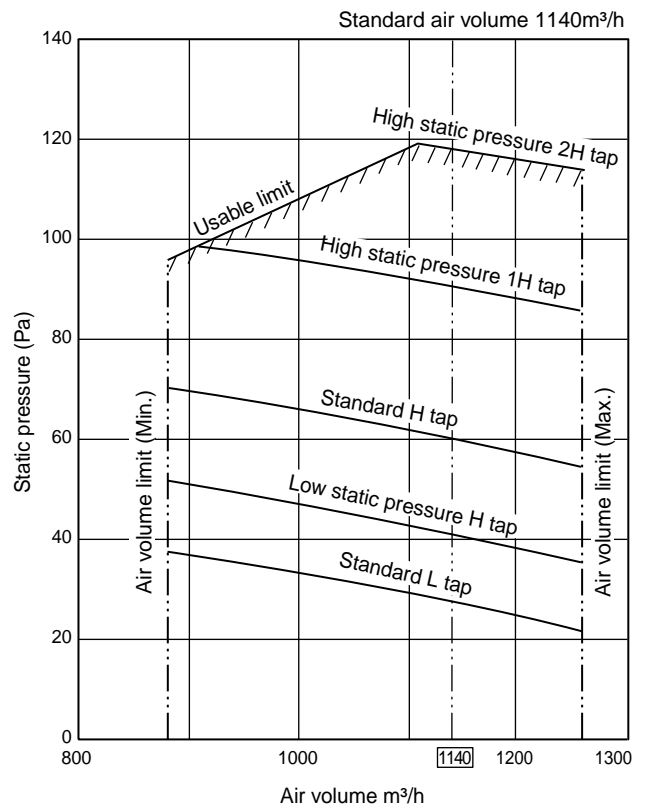

Fig. 5 RAV-SM1102BT-E (Round duct)

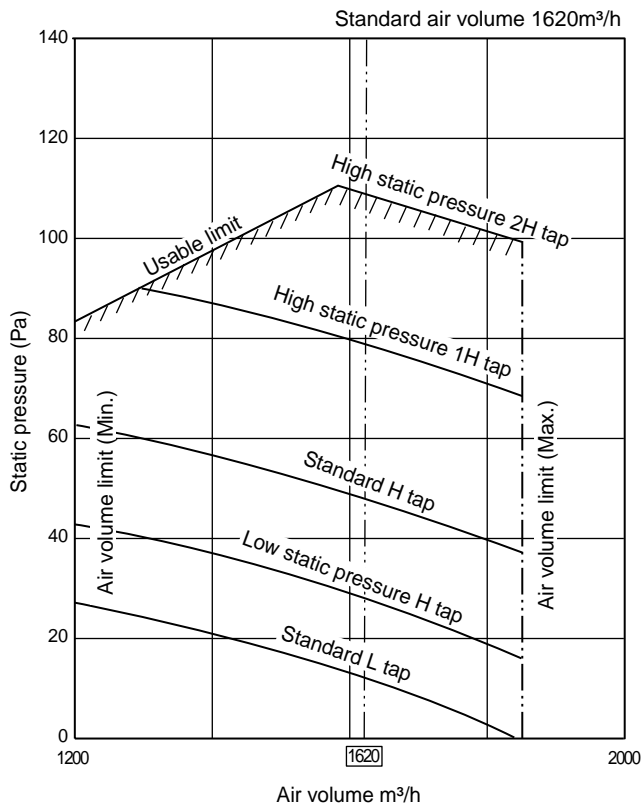

Fig. 7 RAV-SM1402BT-E (Round duct)

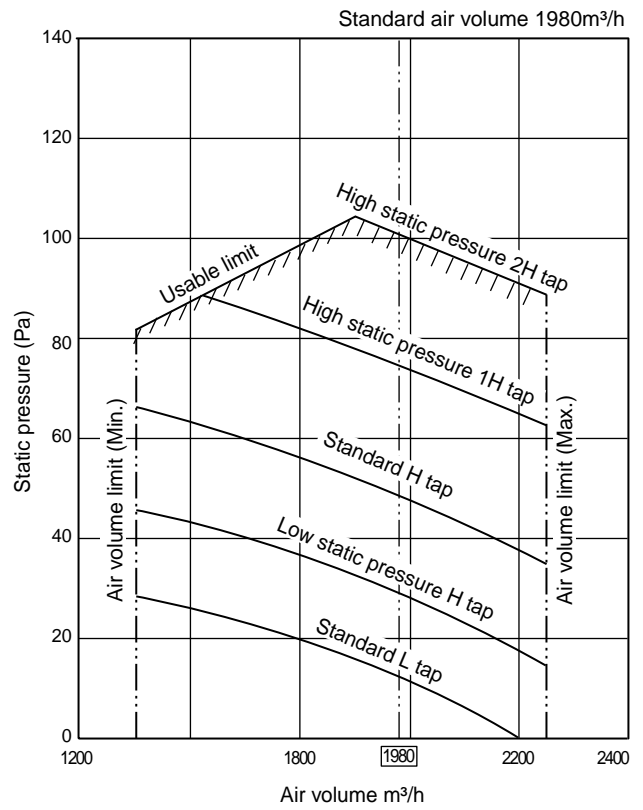

Fig. 6 RAV-SM1102BT-E (Square duct)

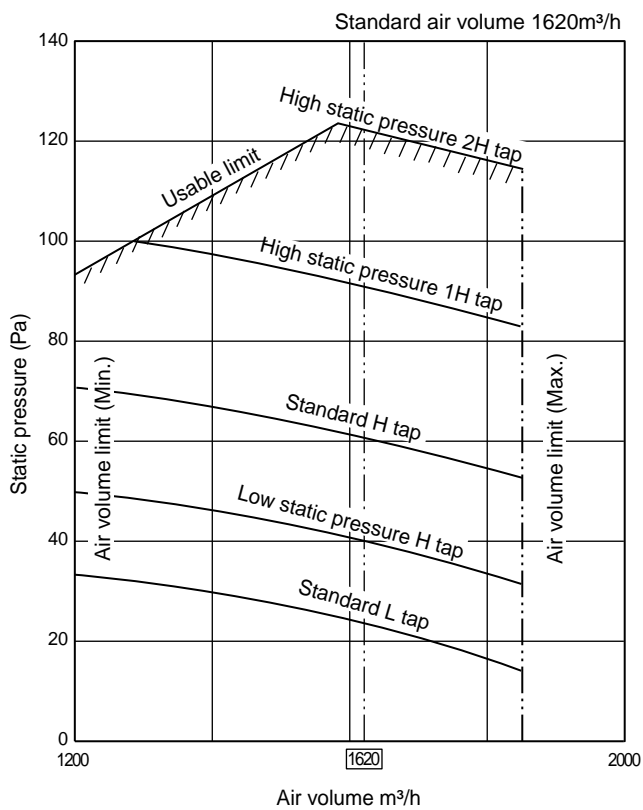
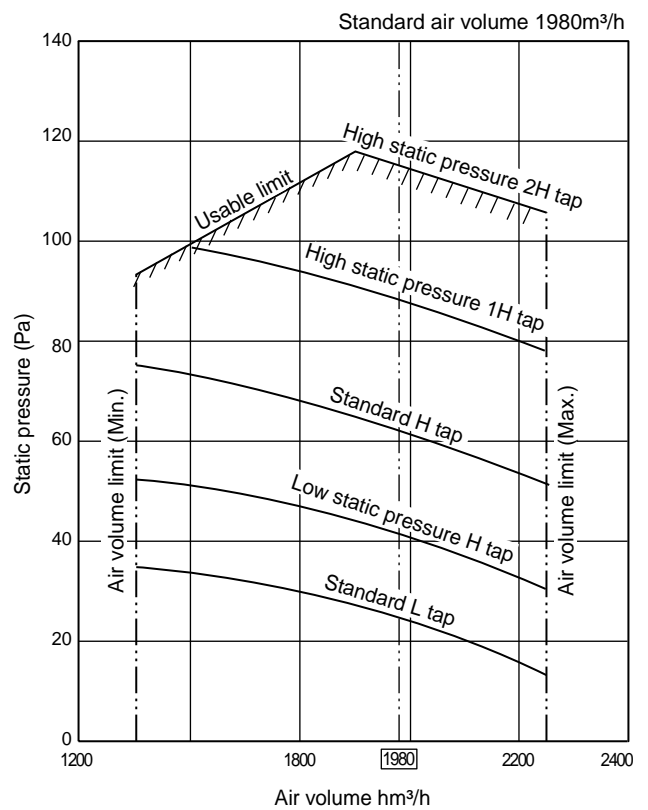

Fig. 8 RAV-SM1402BT-E (Square duct)



3. CONSTRUCTION VIEWS (EXTERNAL VIEWS)

3-1. Indoor Unit

3-1-1. 4-Way Air Discharge Cassette Type

RAV-SM563UT-E, RAV-SM803UT-E

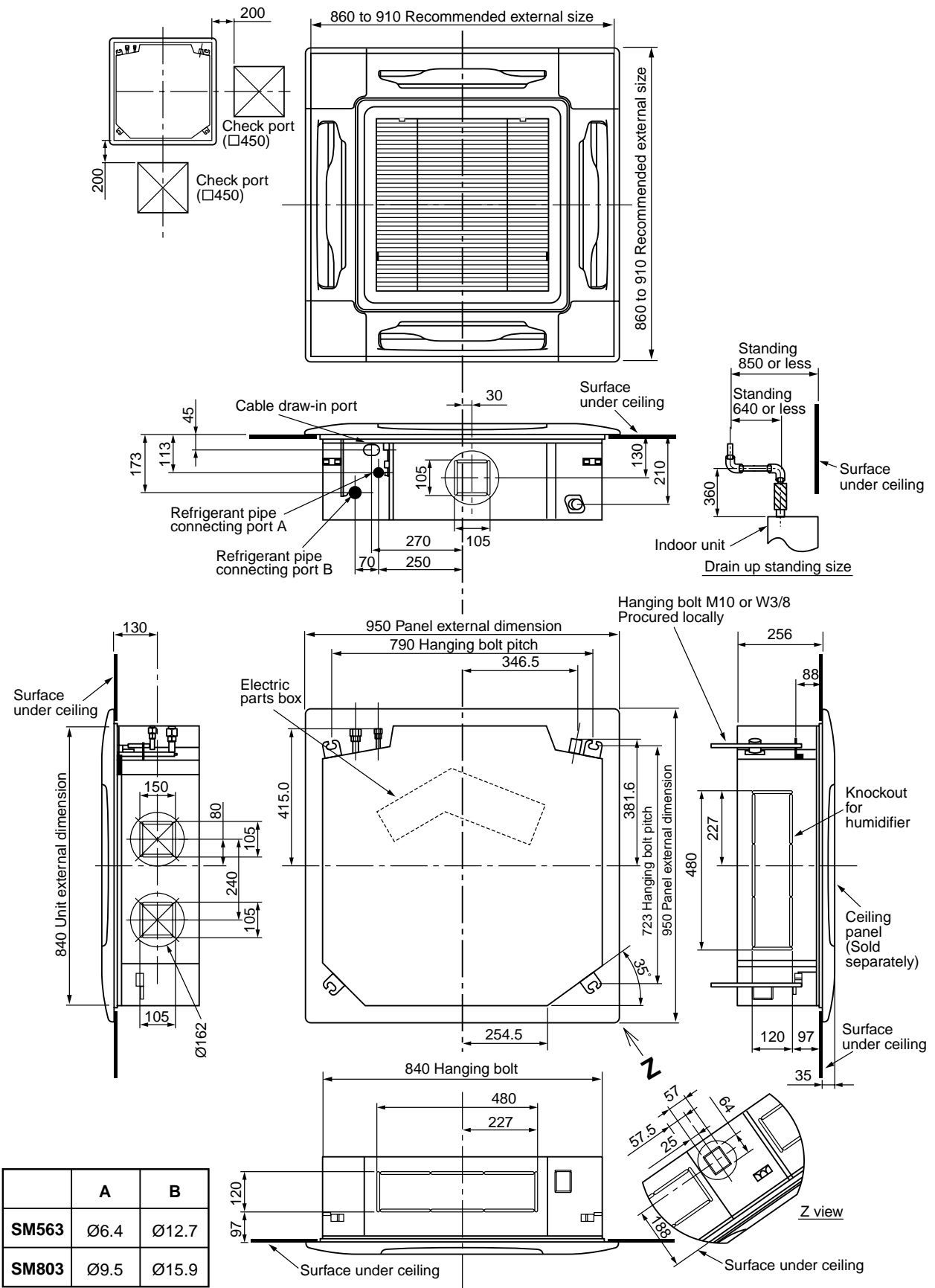

	A	B
SM563	Ø6.4	Ø12.7
SM803	Ø9.5	Ø15.9

RAV-SM1103UT-E, RAV-SM1403UT-E, RAV-SP1102UT-E

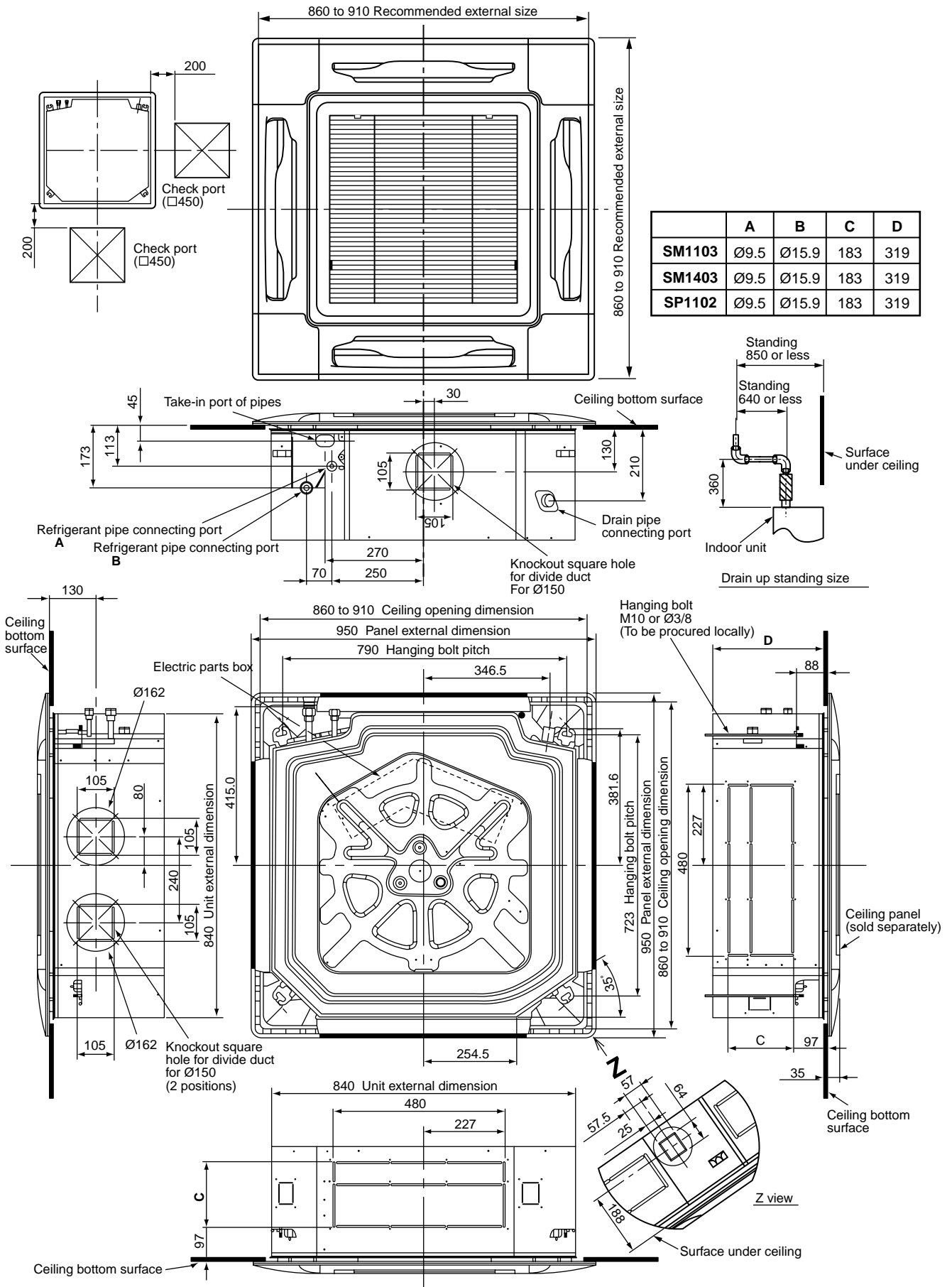

3-1-2. Concealed Duct Type

RAV-SM562BT-E, RAV-SM802BT-E, RAV-SM1102BT-E, RAV-SM1402BT-E

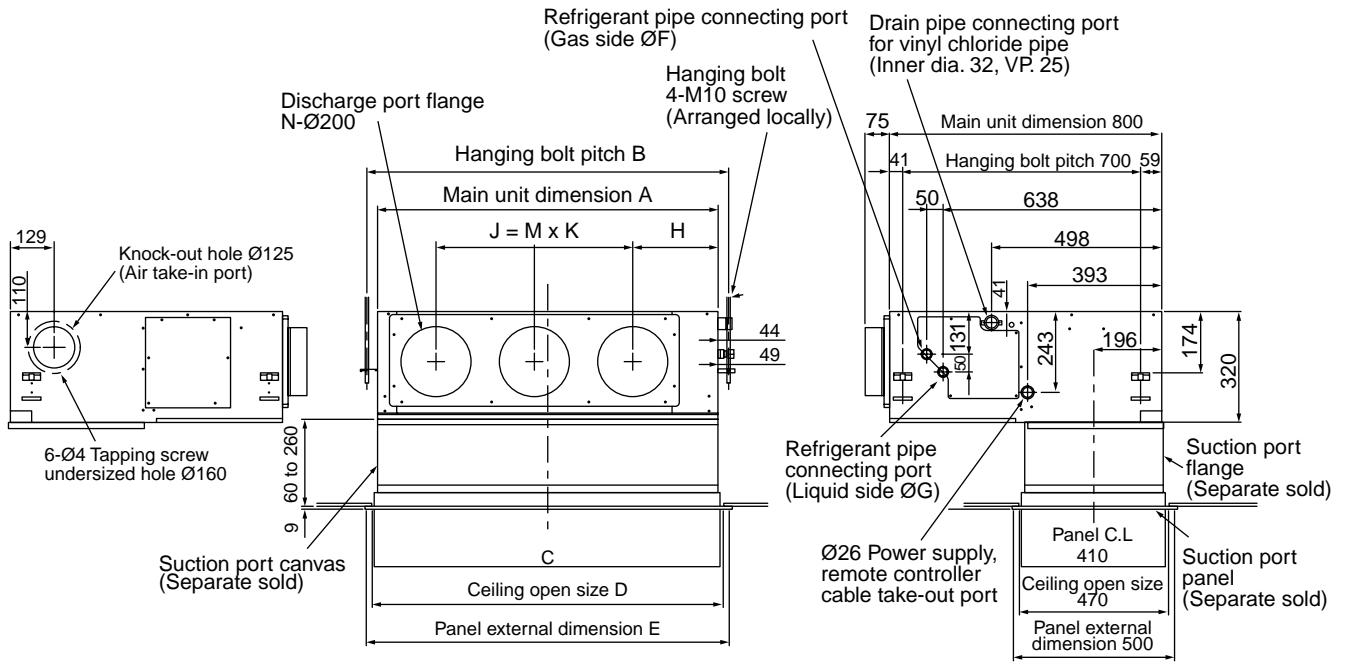

• Dimension

	A	B	C	D	E	F	G	H	J	K	M	N	O
RAV-SM562BT	700	766	690	750	780	12.7	6.4	252	280	280	1	2	410
RAV-SM802BT	1000	1066	990	1050	1080	15.9	9.5	252	580	290	2	3	410
RAV-SM1102BT RAV-SM1402BT	1350	1416	1340	1400	1430	15.9	9.5	252	930	310	3	4	410

NOTE 1 :

For maintenance of the equipment, be sure to install a check port A at the position as shown below.

NOTE 2 :

Using the drain up kit sold separately, drain-up by 300 (mm) from drain pipe draw-out port of the main unit is necessary. The drain-up over 300mm or more is impossible.

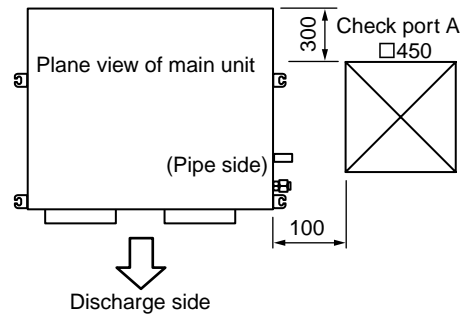

3-1-3. Under Ceiling Type

RAV-SM562CT-E, RAV-SM802CT-E, RAV-SM1102CT-E, RAV-SM1402CT-E

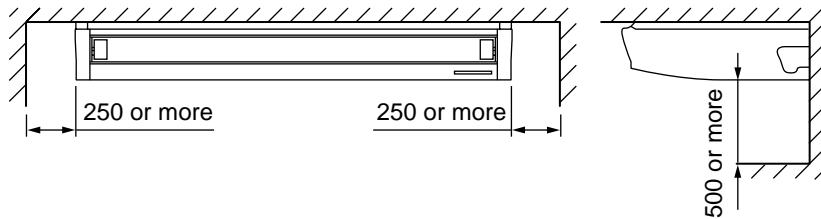
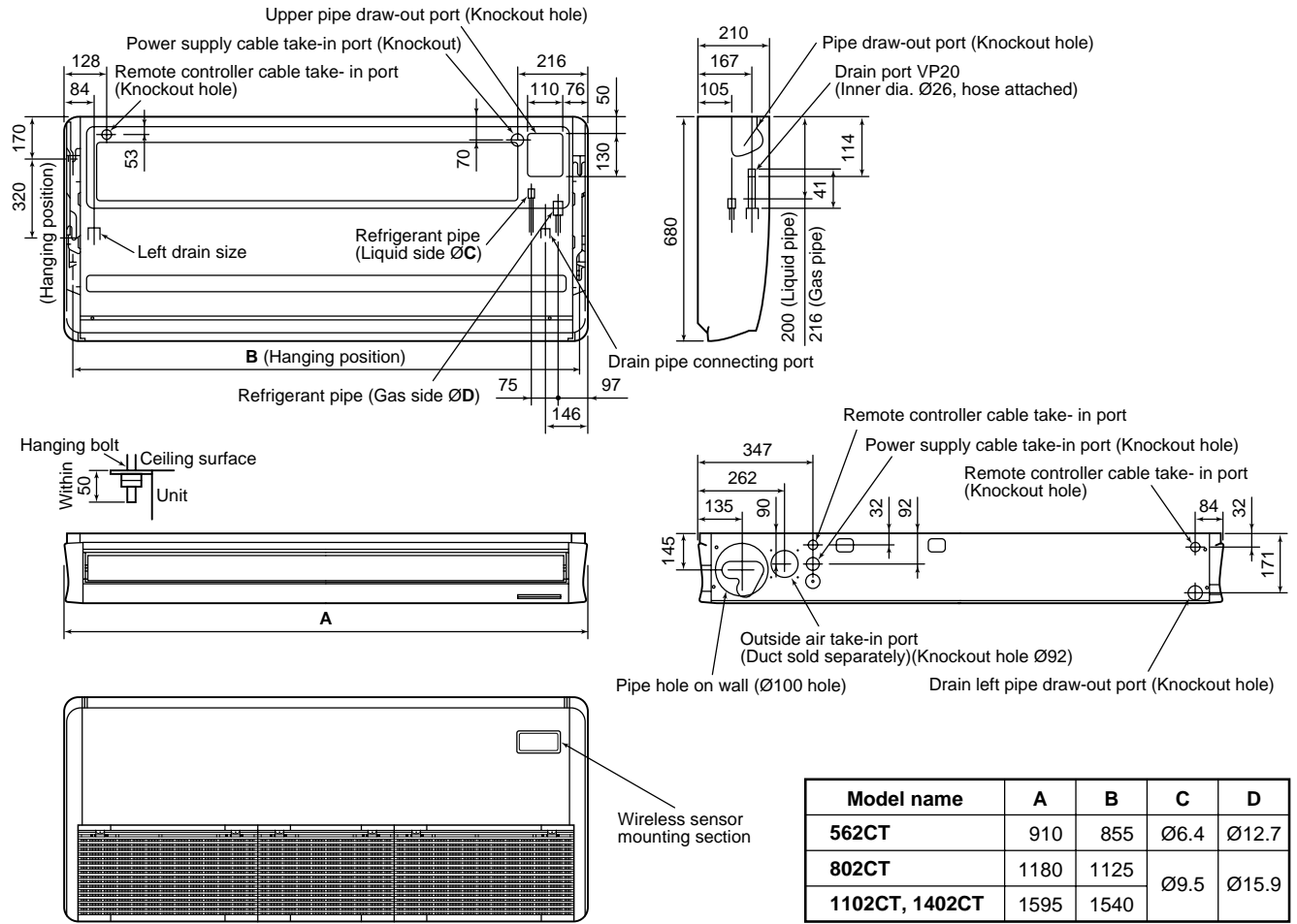

3-2. Outdoor Unit

RAV-SM563AT-E, RAV-SM803AT-E

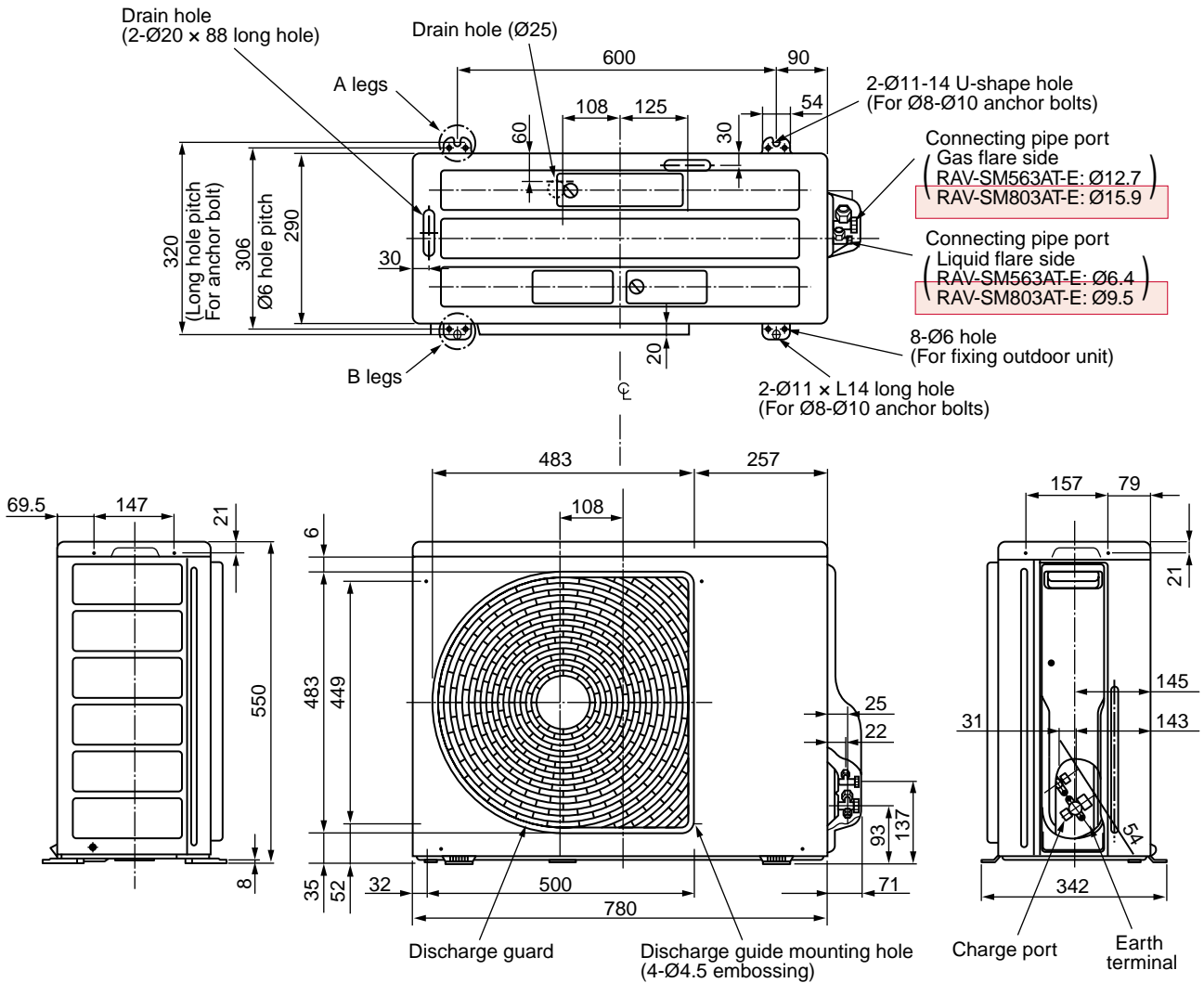

Space required for service

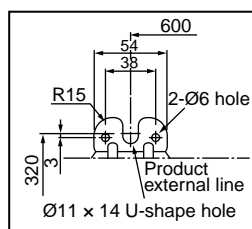
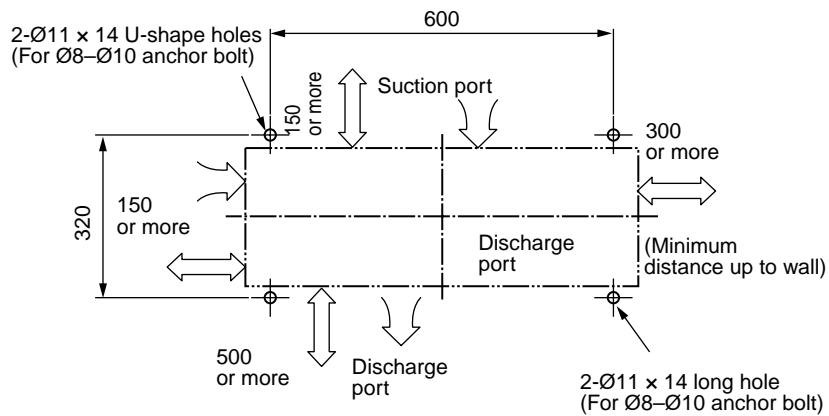

Details of A legs

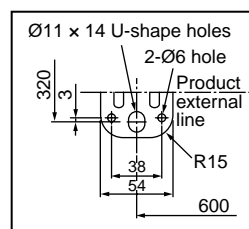

Details of B legs

RAV-SM1103AT-E, RAV-SM1403AT-E / RAV-SP562AT-E, RAV-SP802AT-E

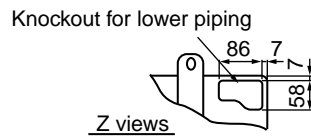
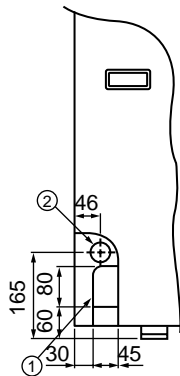
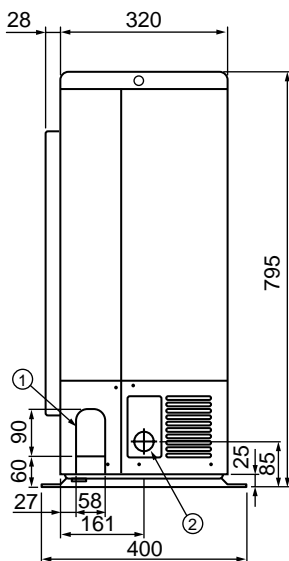
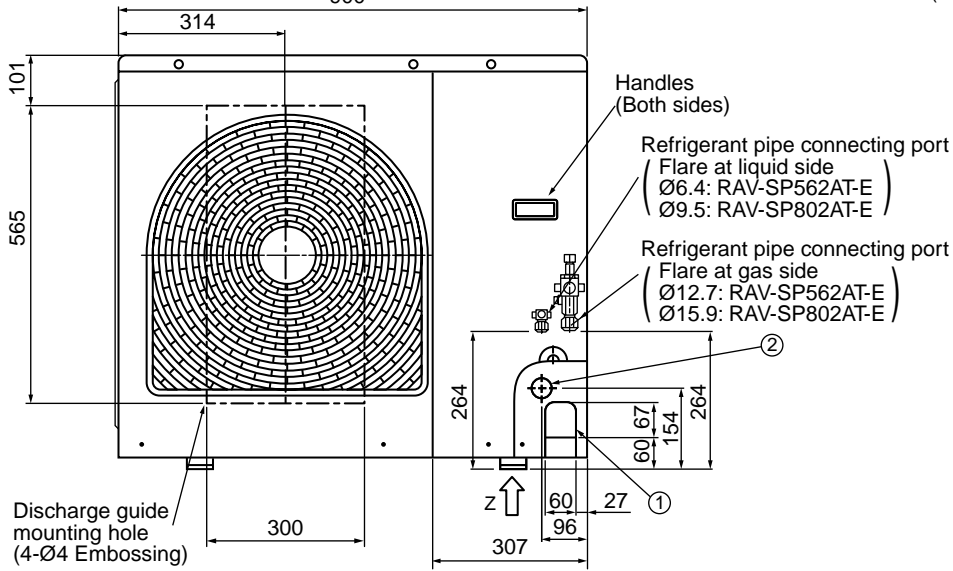
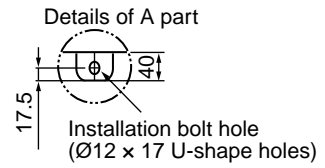
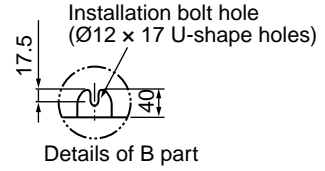
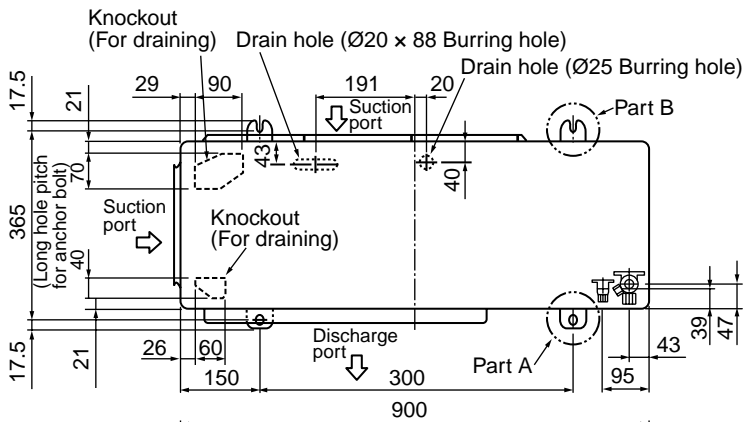

Space required for service

2-Ø12 x 17 U-shape holes (For Ø8-Ø10 Anchor bolt)

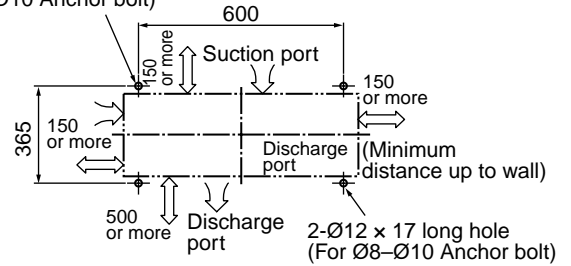

RAV-SP1102AT-E, RAV-SP1402AT-E

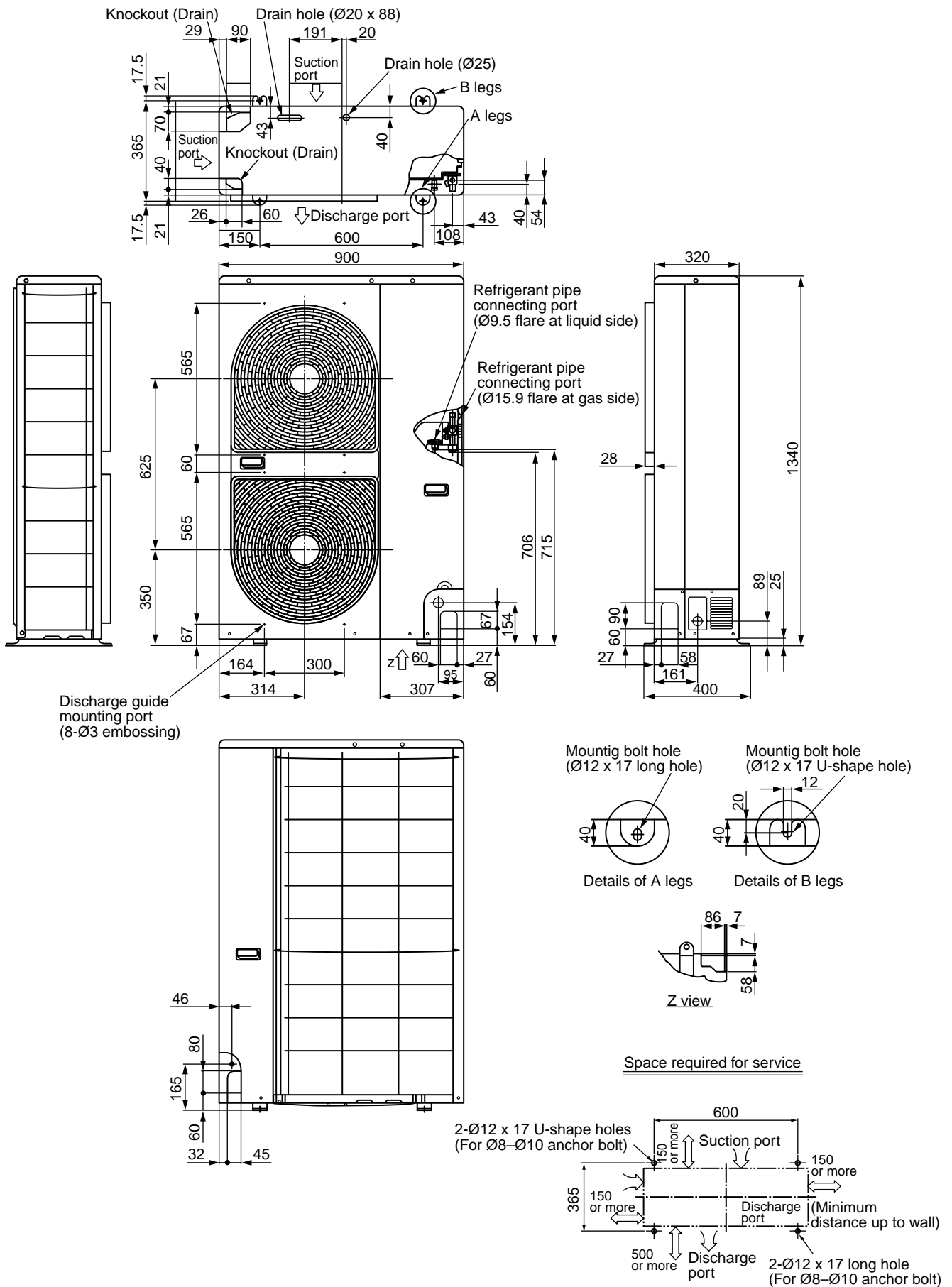

4. SYSTEMATIC REFRIGERATING CYCLE DIAGRAM

4-1. Indoor Unit/Outdoor Unit

RAV-SM563UT-E, RAV-SM562BT-E, RAV-SM562CT-E / RAV-SM563AT-E

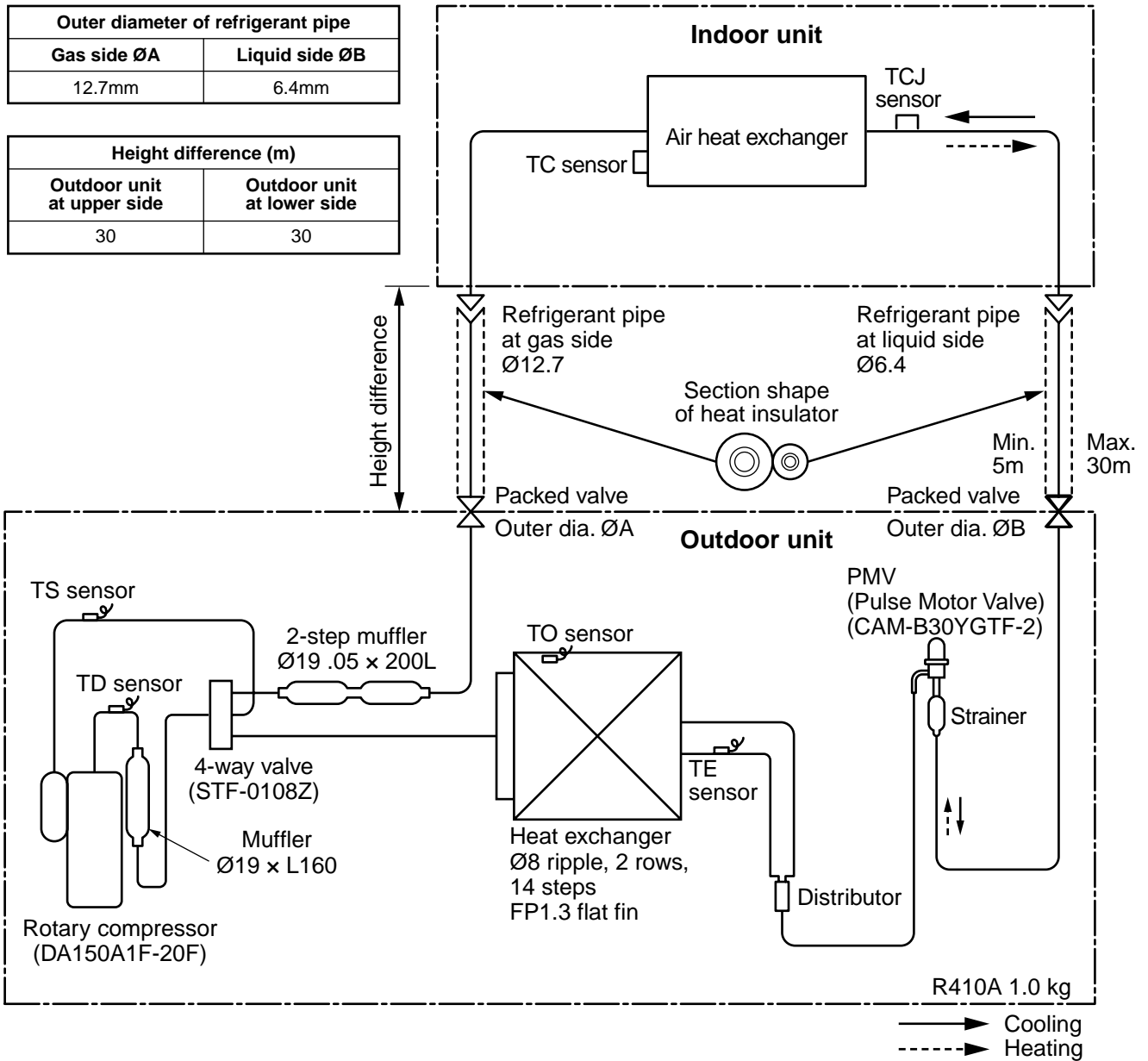

		Pressure				Pipe surface temperature (°C)				Compressor revolutions per second (rps) *	Indoor fan	Indoor/Outdoor temp. conditions (DB/WB) (°C)	
		(MPa)		(kg/cm ² G)		Discharge (TD)	Suction (TS)	Indoor heat exchanger (TC)	Outdoor heat exchanger (TE)			Indoor	Outdoor
		Pd	Ps	Pd	Ps								
Cooling	Standard	3.50	0.97	35.7	9.9	85	14	12	48	70	HIGH	27/19	35/-
	Overload	3.90	1.08	39.8	11.0	93	26	17	54	70	HIGH	32/24	43/-
	Low load	1.90	0.70	19.4	7.1	48	7	5	30	50	LOW	18/15.5	-5/-
Heating	Standard	2.31	0.61	13.6	6.2	87	5	40	1	97	HIGH	20/-	7/6
	Overload	2.86	0.89	29.2	9.1	86	17	47	11	95	LOW	28/-	24/18
	Low load	1.86	0.25	19.0	2.6	69	-14	31	-15	98	HIGH	15/-	-10/(70%)

* 4 poles are provided to this compressor.

The compressor frequency (Hz) measured with a clamp meter is 2 times of revolutions (rps) of the compressor.

RAV-SM803UT-E, RAV-SM802BT-E, RAV-SM802CT-E / RAV-SM803AT-E

Outer diameter of refrigerant pipe	
Gas side ØA	Liquid side ØB
15.9mm	9.5mm

Height difference (m)	
Outdoor unit at upper side	Outdoor unit at lower side
30	30

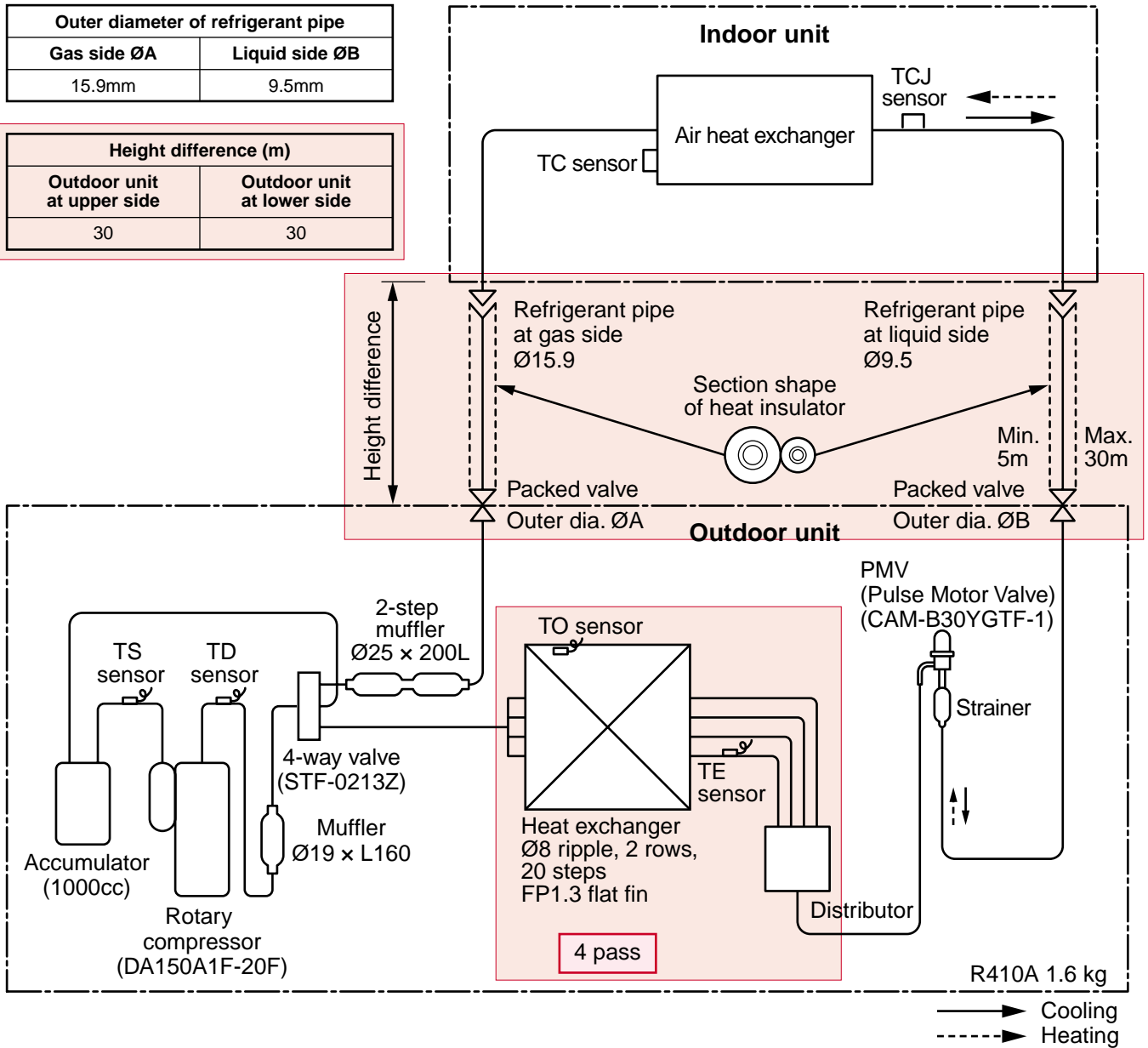

		Pressure				Pipe surface temperature (°C)				Compressor revolutions per second (rps) *	Indoor fan	Indoor/Outdoor temp. conditions (DB/WB) (°C)	
		(MPa)		(kg/cm ² G)		Discharge (TD)	Suction (TS)	Indoor heat exchanger (TC)	Outdoor heat exchanger (TE)			Indoor	Outdoor
		Pd	Ps	Pd	Ps								
Cooling	Standard	3.28	0.86	33.4	8.8	84	11	10	45	83	HIGH	27/19	35/-
	Overload	3.59	1.00	33.6	10.2	82	17	16	51	76	HIGH	32/24	43/-
	Low load	1.85	0.83	18.9	8.5	42	8	6	23	35	LOW	18/15.5	-5/-
Heating	Standard	2.53	0.62	25.8	6.3	75	3	42	2	95	HIGH	20/-	7/6
	Overload	3.42	1.07	34.9	10.9	80	20	54	17	50	LOW	28/-	24/18
	Low load	1.99	0.23	20.3	2.3	89	-19	34	-18	120	HIGH	15/-	-10/(70%)

* 4 poles are provided to this compressor.

The compressor frequency (Hz) measured with a clamp meter is 2 times of revolutions (rps) of the compressor.

RAV-SM1103UT-E, RAV-SM1102BT-E, RAV-SM1102CT-E / RAV-SM1103AT-E

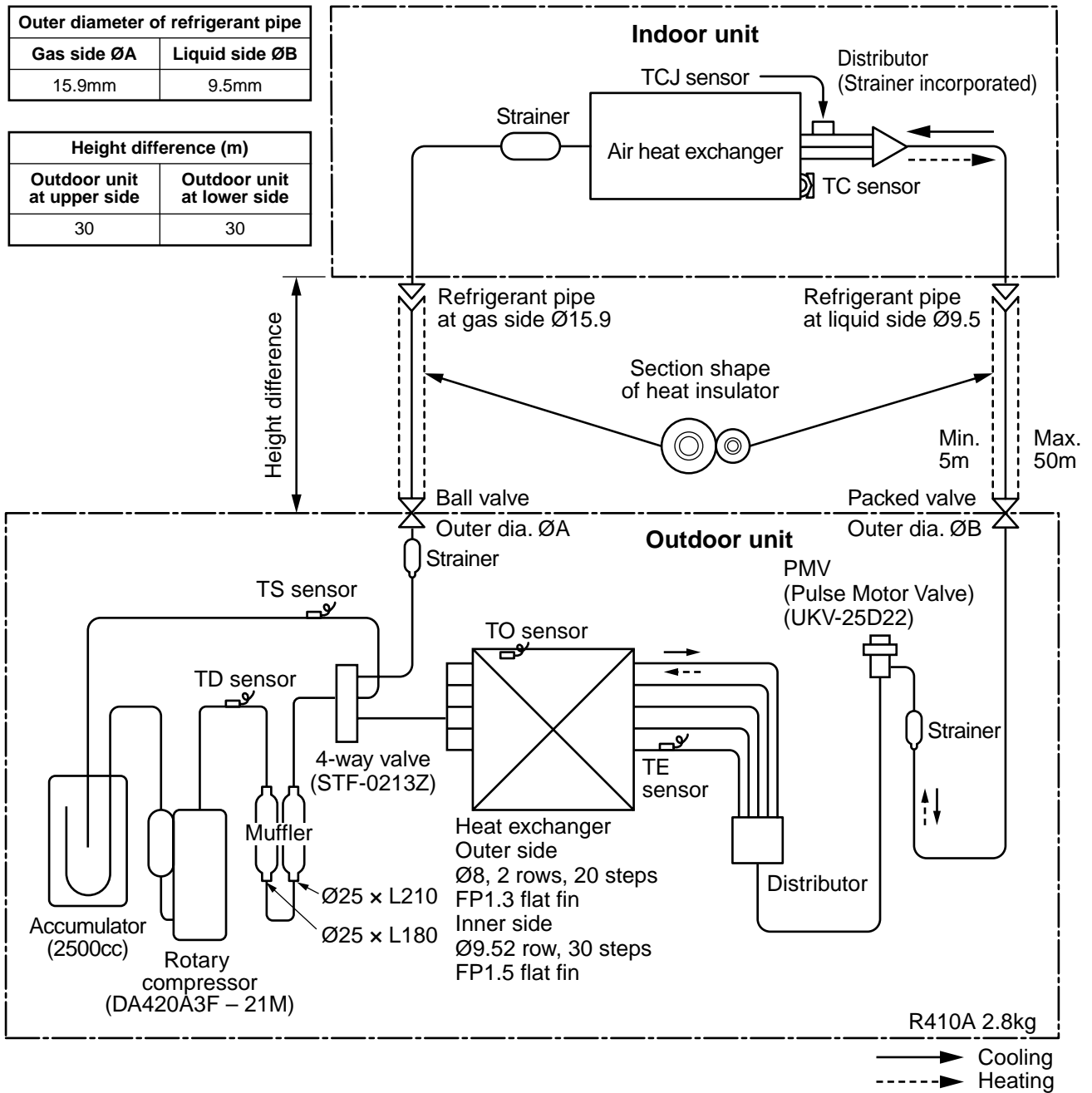

		Pressure				Pipe surface temperature (°C)				Compressor revolutions per second (rps) *	Indoor fan	Indoor/Outdoor temp. conditions (DB/WB) (°C)	
		(MPa)		(kg/cm ² G)		Discharge (TD)	Suction (TS)	Indoor heat exchanger (TC)	Outdoor heat exchanger (TE)			Indoor	Outdoor
		Pd	Ps	Pd	Ps								
Cooling	Standard	3.44	0.92	35.1	9.4	82	8	10	39	47	HIGH	27/19	35/-
	Overload	3.73	1.18	38.1	12.0	82	15	17	48	42	HIGH	32/24	43/-
	Low load	1.49	0.70	15.2	7.1	39	8	3	22	30	LOW	18/15.5	-5/-
Heating	Standard	2.80	0.61	28.6	6.2	80	0	46	1	48	HIGH	20/-	7/6
	Overload	3.43	1.08	35.0	11.0	82	14	55	13	24	LOW	30/-	24/18
	Low load	2.20	0.25	22.4	2.6	76	-19	36	-16	55	HIGH	15/-	-10/(70%)

* 4 poles are provided to this compressor.

The compressor frequency (Hz) measured with a clamp meter is 2 times of revolutions (rps) of the compressor.

RAV-SM1403UT-E, RAV-SM1402BT-E, RAV-SM1402CT-E / RAV-SM1403AT-E

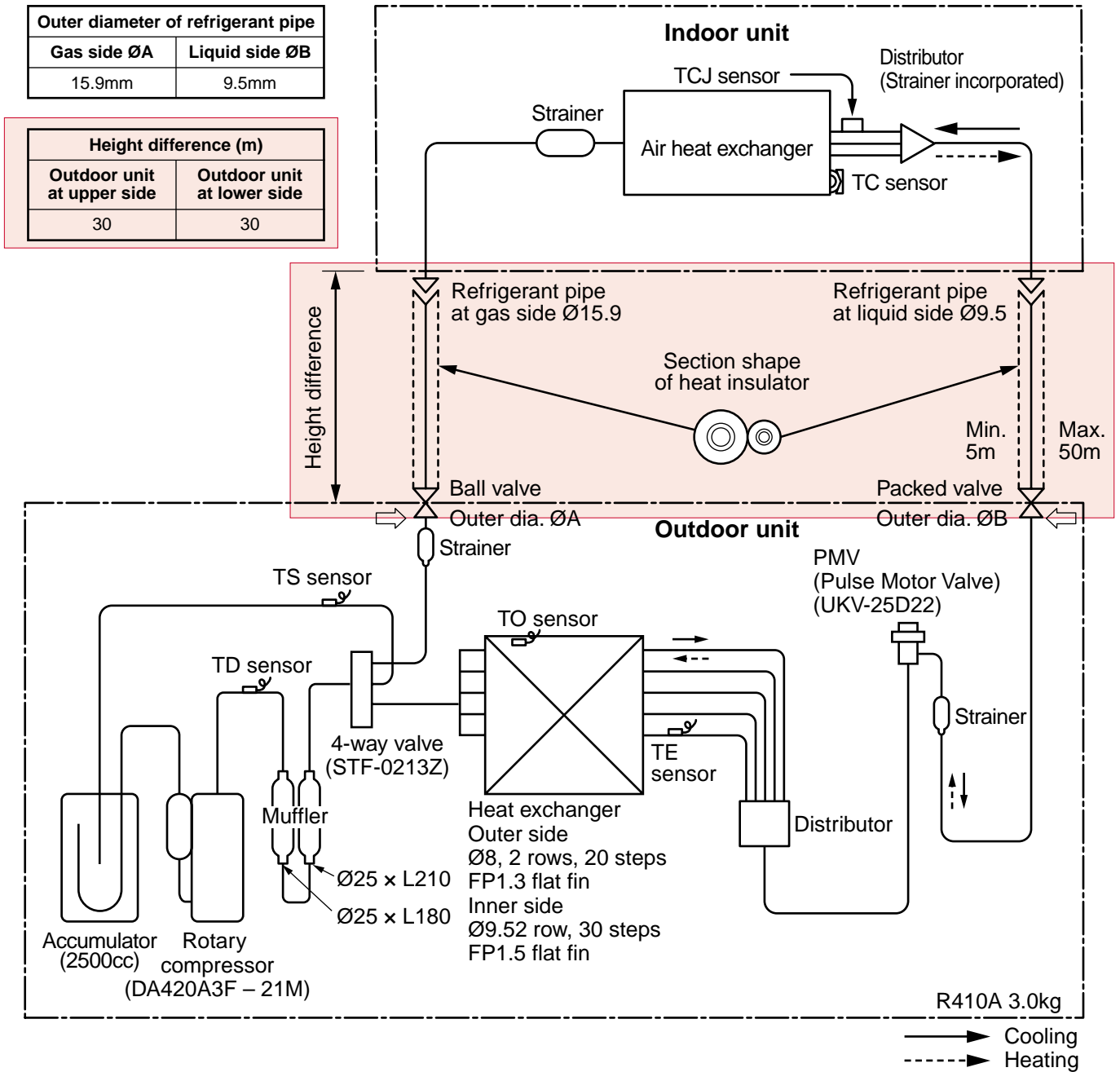

		Pressure				Pipe surface temperature (°C)				Compressor revolutions per second (rps) *	Indoor fan	Indoor/Outdoor temp. conditions (DB/WB) (°C)	
		(MPa)		(kg/cm ² G)		Discharge (TD)	Suction (TS)	Indoor heat exchanger (TC)	Outdoor heat exchanger (TE)			Indoor	Outdoor
		Pd	Ps	Pd	Ps								
Cooling	Standard	3.52	0.85	35.9	8.7	87	8	9	39	54	HIGH	27/19	35/-
	Overload	3.78	1.12	38.6	11.4	84	15	17	47	45	HIGH	32/24	43/-
	Low load	1.51	0.71	15.4	7.2	40	7	3	23	30	LOW	18/15.5	-5/-
Heating	Standard	2.88	0.60	29.4	6.1	85	1	47	1	61	HIGH	20/-	7/6
	Overload	3.41	1.08	34.8	11.0	81	14	54	13	24	LOW	30/-	24/18
	Low load	2.35	0.24	24.0	2.4	80	-19	40	-16	73	HIGH	15/-	-10/(70%)

* 4 poles are provided to this compressor.

The compressor frequency (Hz) measured with a clamp meter is 2 times of revolutions (rps) of the compressor.

RAV-SM563UT-E, RAV-SM562BT-E, RAV-SM562CT-E / RAV-SP562AT-E

Outer diameter of refrigerant pipe	
Gas side ØA	Liquid side ØB
12.7mm	6.4mm

Height difference (m)	
Outdoor unit at upper side	Outdoor unit at lower side
30	15

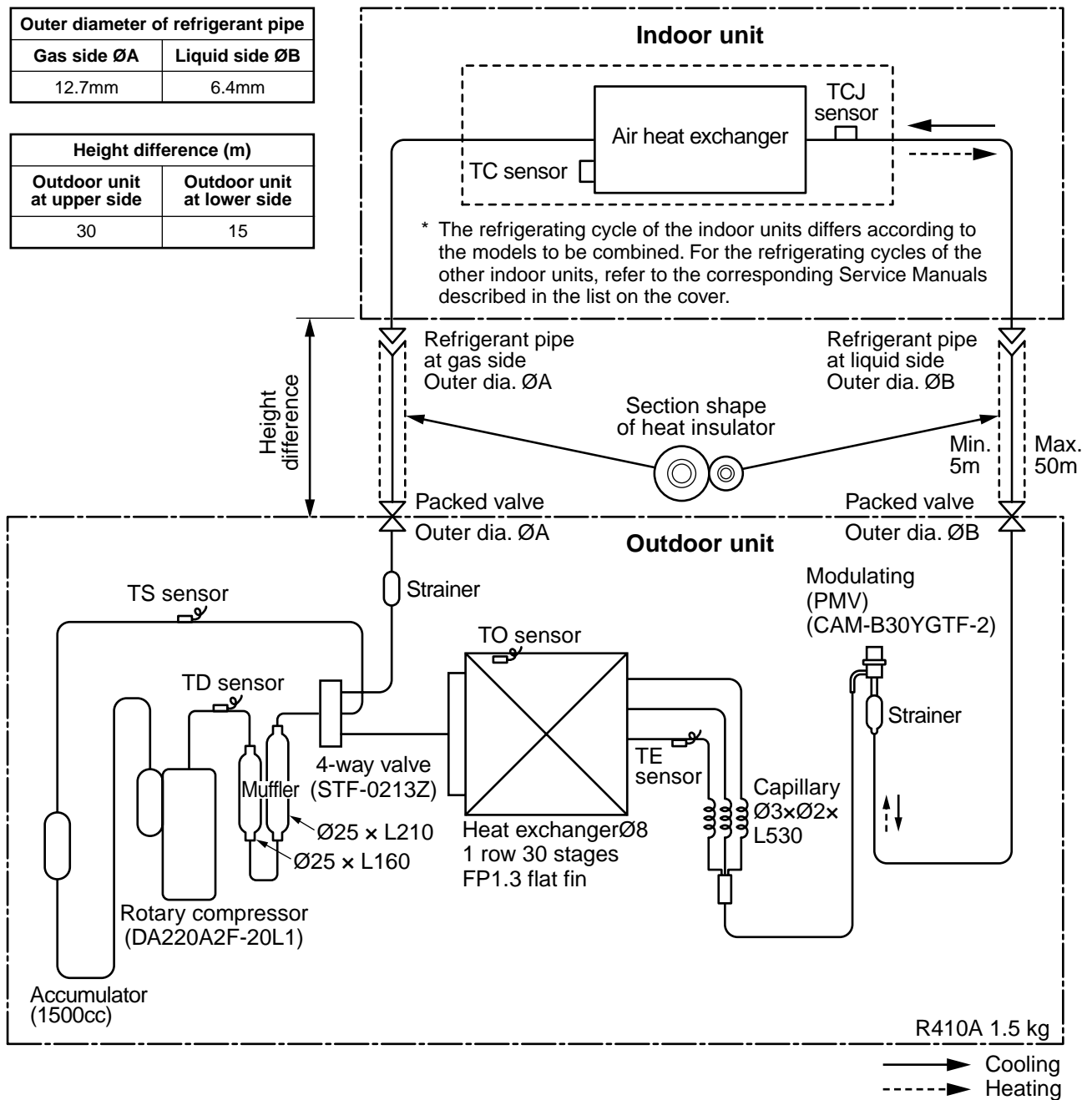

		Pressure		Pipe surface temperature (°C)				Compressor revolutions per second (rps) *	Indoor fan	Indoor/Outdoor temp. conditions (DB/WB) (°C)	
		(MPa)		Discharge (TD)	Suction (TS)	Indoor heat exchanger (TC)	Outdoor heat exchanger (TE)			Indoor	Outdoor
		Pd	Ps								
Cooling	Standard	2.71	1.03	75	15	10	38	43	HIGH	27/19	35/-
	Overload	3.48	1.16	81	20	16	51	44	HIGH	32/24	43/-
	Low load	1.92	0.74	34	5	2	11	24	LOW	18/15.5	-5/-
Heating	Standard	2.22	0.72	32	6	38	2	41	HIGH	20/-	7/6
	Overload	3.47	1.16	81	20	55	15	41	LOW	30/-	24/18
	Low load	1.79	0.25	71	-16	30	-18	70	HIGH	15/-	-15/(70%)

* 4 poles are provided to this compressor.

The compressor frequency (Hz) measured with a clamp meter is 2 times of revolutions (rps) of the compressor.

RAV-SM803UT-E, RAV-SM802BT-E, RAV-SM802CT-E / RAV-SP802AT-E

Outer diameter of refrigerant pipe	
Gas side ØA	Liquid side ØB
15.9mm	9.5mm

Height difference (m)	
Outdoor unit at upper side	Outdoor unit at lower side
30	15

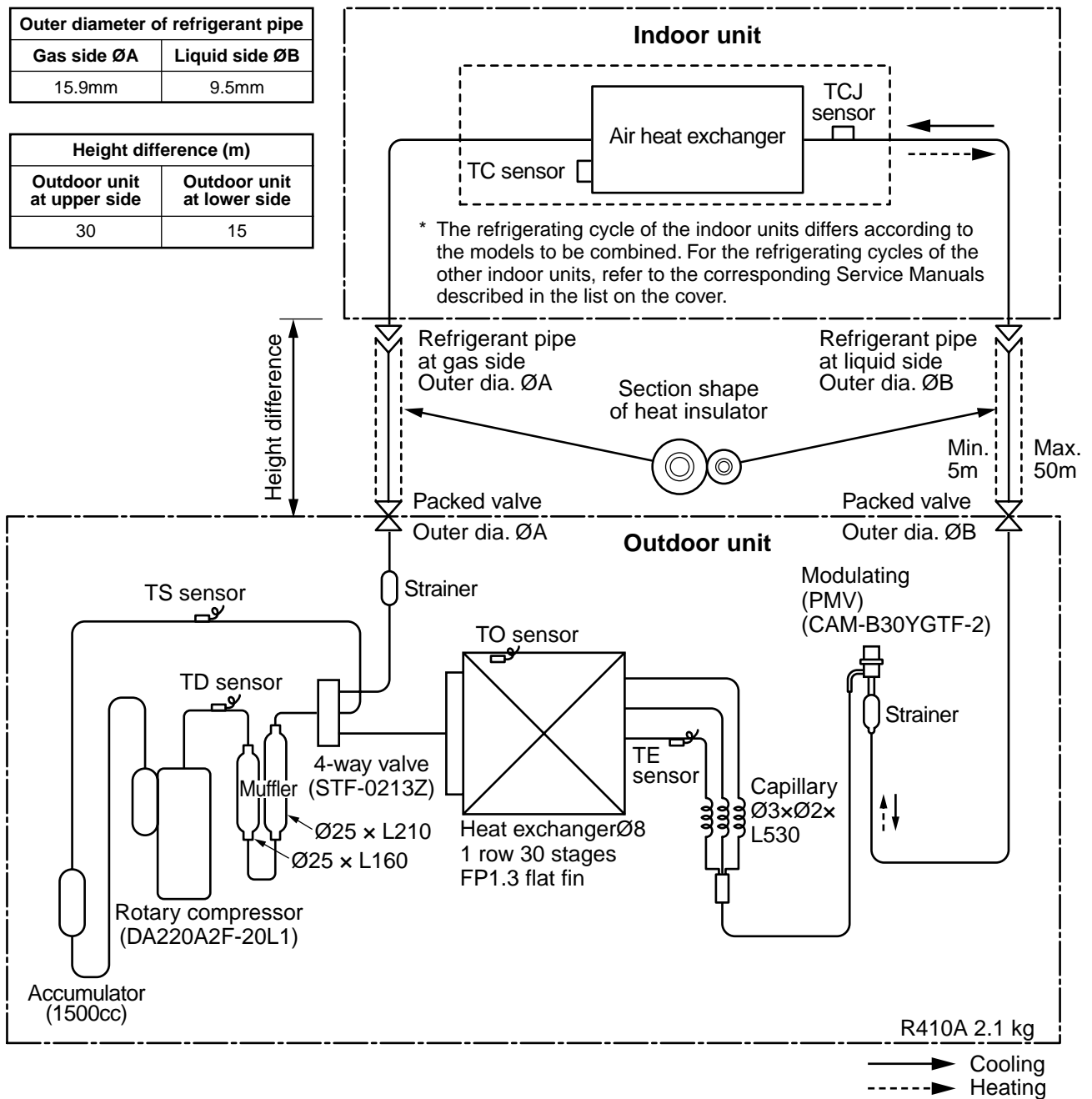

		Pressure		Pipe surface temperature (°C)				Compressor revolutions per second (rps) *	Indoor fan	Indoor/Outdoor temp. conditions (DB/WB) (°C)	
		(MPa)		Discharge (TD)	Suction (TS)	Indoor heat exchanger (TC)	Outdoor heat exchanger (TE)			Indoor	Outdoor
		Pd	Ps								
Cooling	Standard	2.72	0.93	74	12	11	40	55	HIGH	27/19	35/-
	Overload	3.57	1.10	80	21	17	52	47	HIGH	32/24	43/-
	Low load	1.89	0.74	34	7	2	12	24	LOW	18/15.5	-5/-
Heating	Standard	2.58	0.68	72	4	41	2	62	HIGH	20/-	7/6
	Overload	3.49	1.22	79	19	55	16	28	LOW	30/-	24/18
	Low load	2.30	0.25	91	-17	37	-19	90	HIGH	15/-	-15/(70%)

* 4 poles are provided to this compressor.

The compressor frequency (Hz) measured with a clamp meter is 2 times of revolutions (rps) of the compressor.

RAV-SP1102UT-E, RAV-SM1102BT-E, RAV-SM1102CT-E / RAV-SP1102AT-E

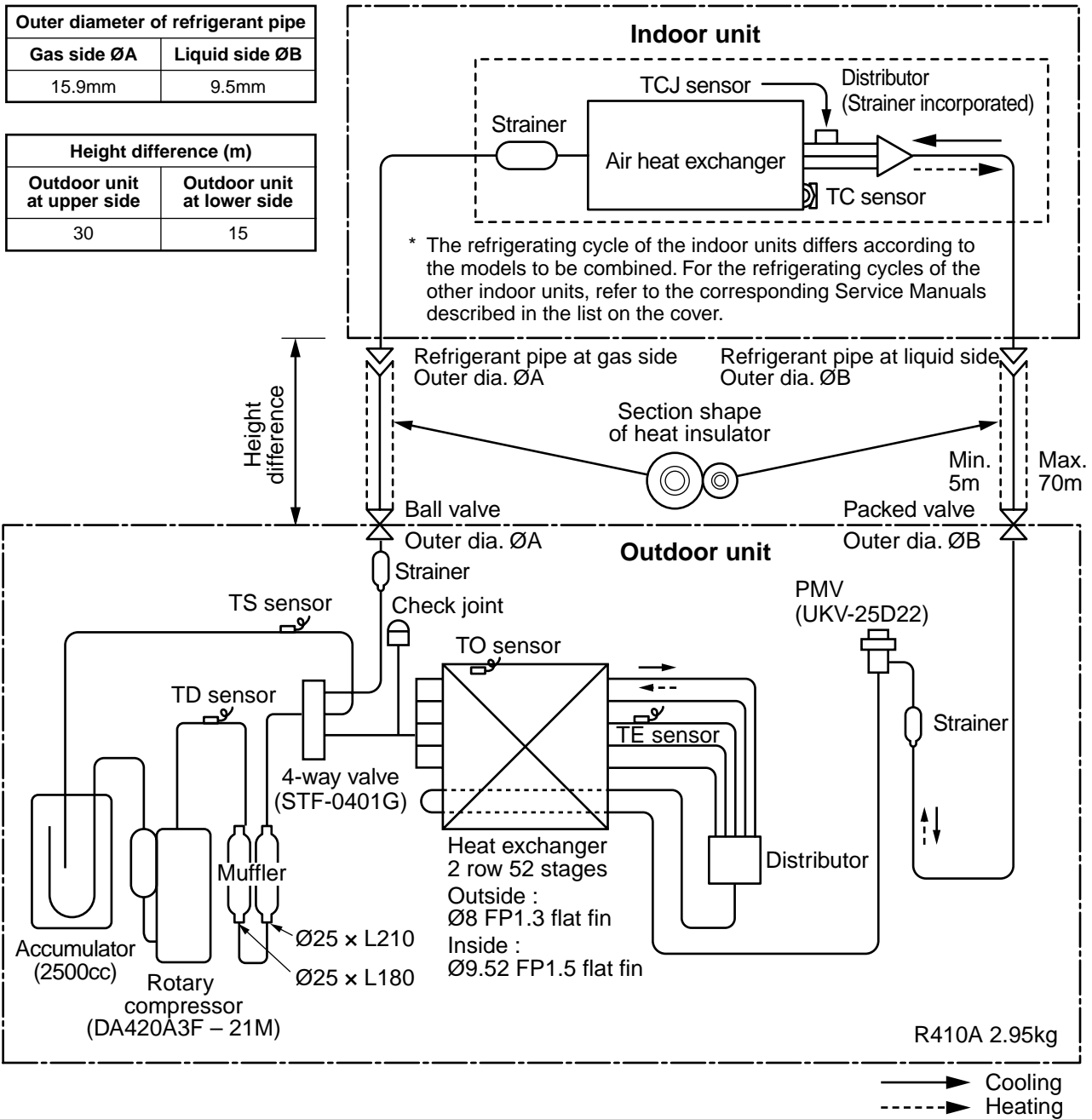

		Pressure		Pipe surface temperature (°C)				Compressor revolutions per second (rps) *	Indoor fan	Indoor/Outdoor temp. conditions (DB/WB) (°C)	
		(MPa)		Discharge (TD)	Suction (TS)	Indoor heat exchanger (TC)	Outdoor heat exchanger (TE)			Indoor	Outdoor
		Pd	Ps								
Cooling	Standard	2.55	0.98	69	12	10	40	40	HIGH	27/19	35/-
	Overload	3.28	1.08	82	17	16	48	50	HIGH	32/24	43/-
	Low load	1.76	0.76	47	8	5	27	24	LOW	18/15.5	-5/-
Heating	Standard	2.58	0.73	68	3	40	3	44	HIGH	20/-	7/6
	Overload	3.43	1.18	75	20	56	16	24	LOW	30/-	24/18
	Low load	2.10	0.32	88	-14	34	-13	63	HIGH	15/-	-15/(70%)

* 4 poles are provided to this compressor.

The compressor frequency (Hz) measured with a clamp meter is 2 times of revolutions (rps) of the compressor.

RAV-SM1403UT-E, RAV-SM1402BT-E, RAV-SM1402CT-E / RAV-SP1402AT-E

Outer diameter of refrigerant pipe	
Gas side ØA	Liquid side ØB
15.9mm	9.5mm

Height difference (m)	
Outdoor unit at upper side	Outdoor unit at lower side
30	15

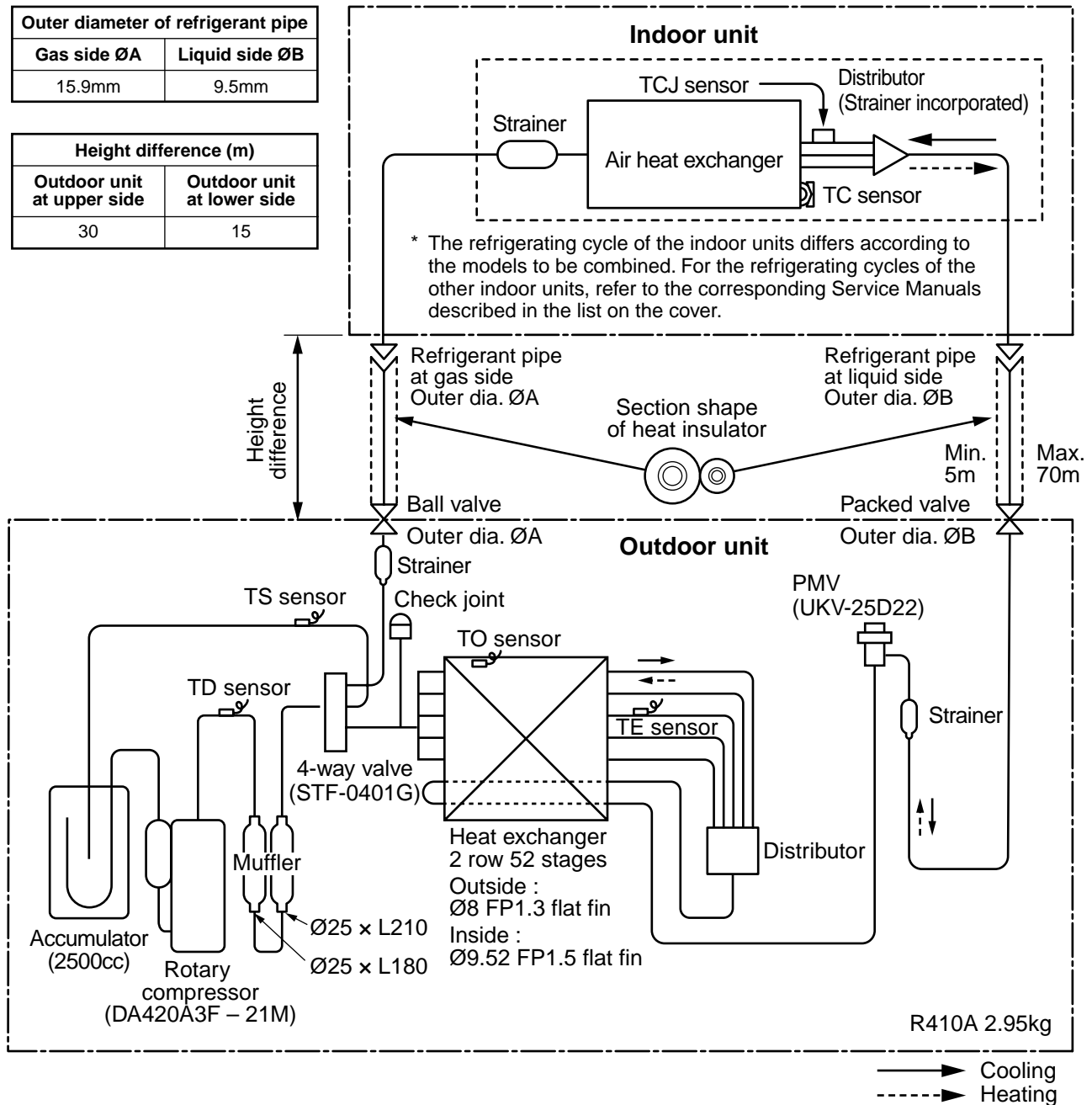

		Pressure		Pipe surface temperature (°C)				Compressor revolutions per second (rps) *	Indoor fan	Indoor/Outdoor temp. conditions (DB/WB) (°C)	
		(MPa)		Discharge (TD)	Suction (TS)	Indoor heat exchanger (TC)	Outdoor heat exchanger (TE)			Indoor	Outdoor
		Pd	Ps								
Cooling	Standard	2.76	0.91	74	11	9	39	53	HIGH	27/19	35/-
	Overload	3.46	1.03	82	17	16	48	51	HIGH	32/24	43/-
	Low load	1.77	0.78	48	9	6	27	24	LOW	18/15.5	-5/-
Heating	Standard	2.65	0.69	75	3	43	3	55	HIGH	20/-	7/6
	Overload	3.33	1.08	74	19	55	15	24	LOW	30/-	24/18
	Low load	2.50	0.22	98	-22	43	-18	73	HIGH	15/-	-15/(70%)

* 4 poles are provided to this compressor.

The compressor frequency (Hz) measured with a clamp meter is 2 times of revolutions (rps) of the compressor.

5. WIRING DIAGRAM

5-1. Indoor Unit

5-1-1. 4-Way Air Discharge Cassette Type

RAV-SM563UT-E, RAV-SM803UT-E, RAV-SM1103UT-E, RAV-SM1403UT-E, RAV-SP1102UT-E

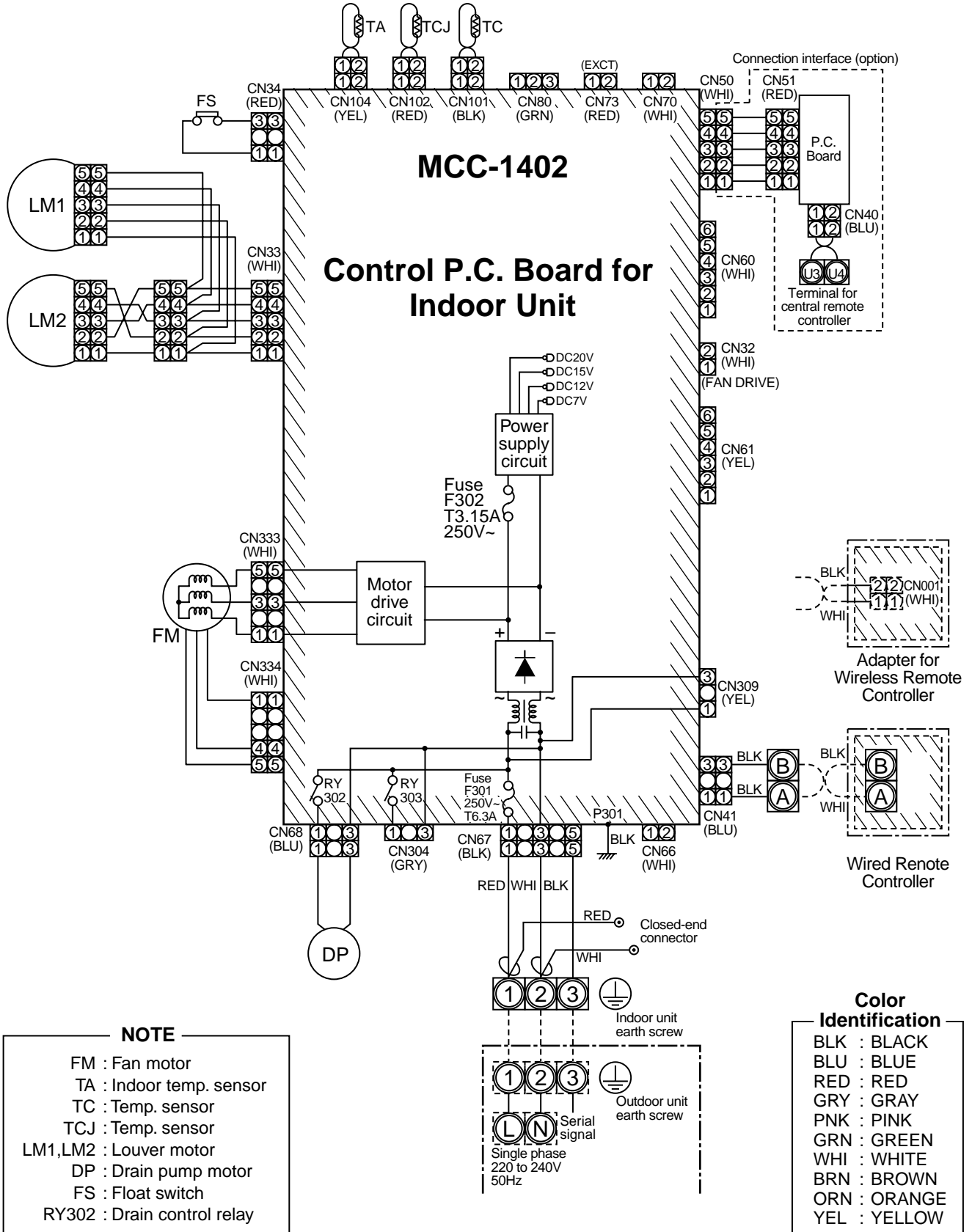

5-1-2. Concealed Duct Type

RAV-SM562BT-E, RAV-SM802BT-E, RAV-SM1102BT-E, RAV-SM1402BT-E

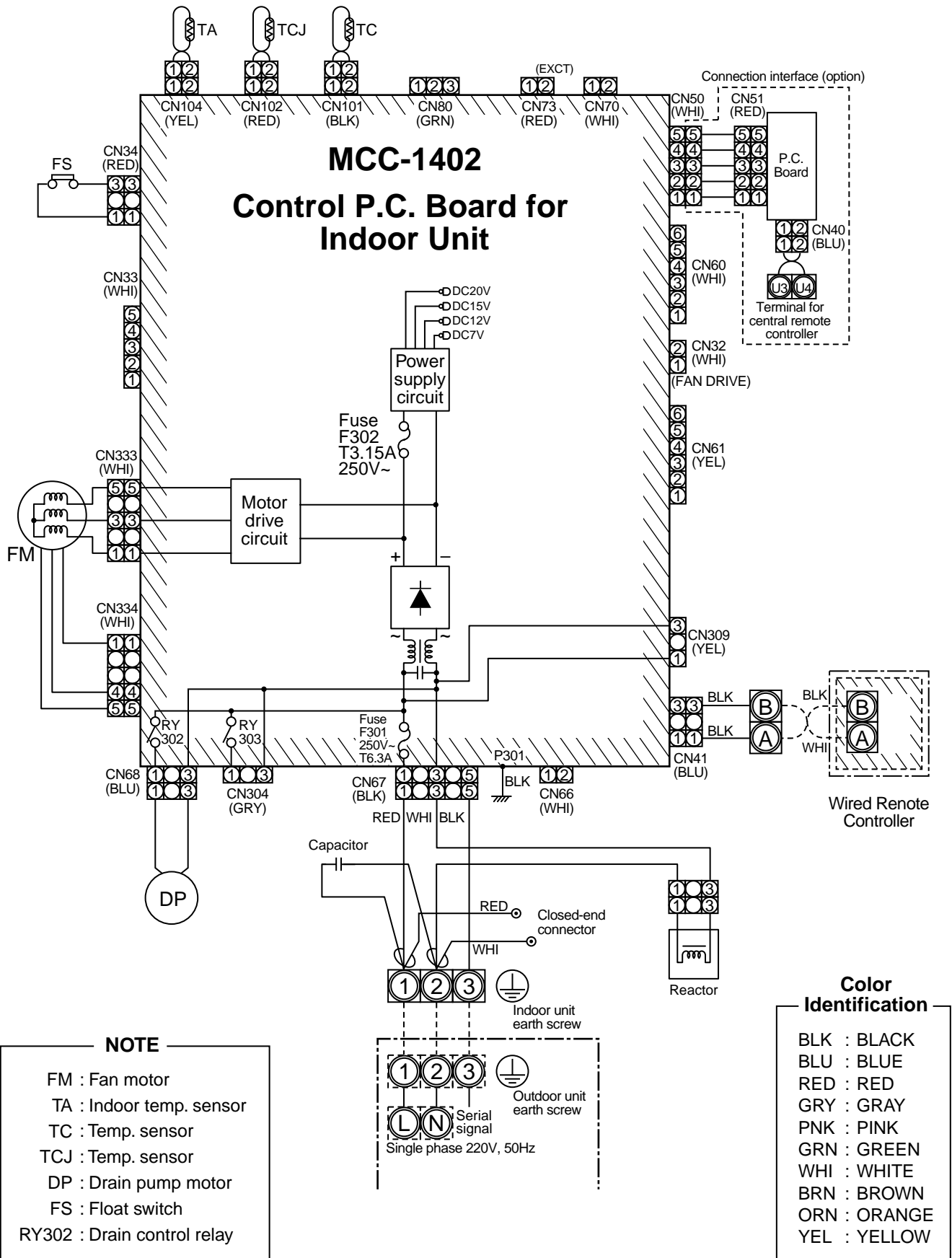

5-1-3. Under Ceiling Type

RAV-SM562CT-E, RAV-SM802CT-E, RAV-SM1102CT-E, RAV-SM1402CT-E

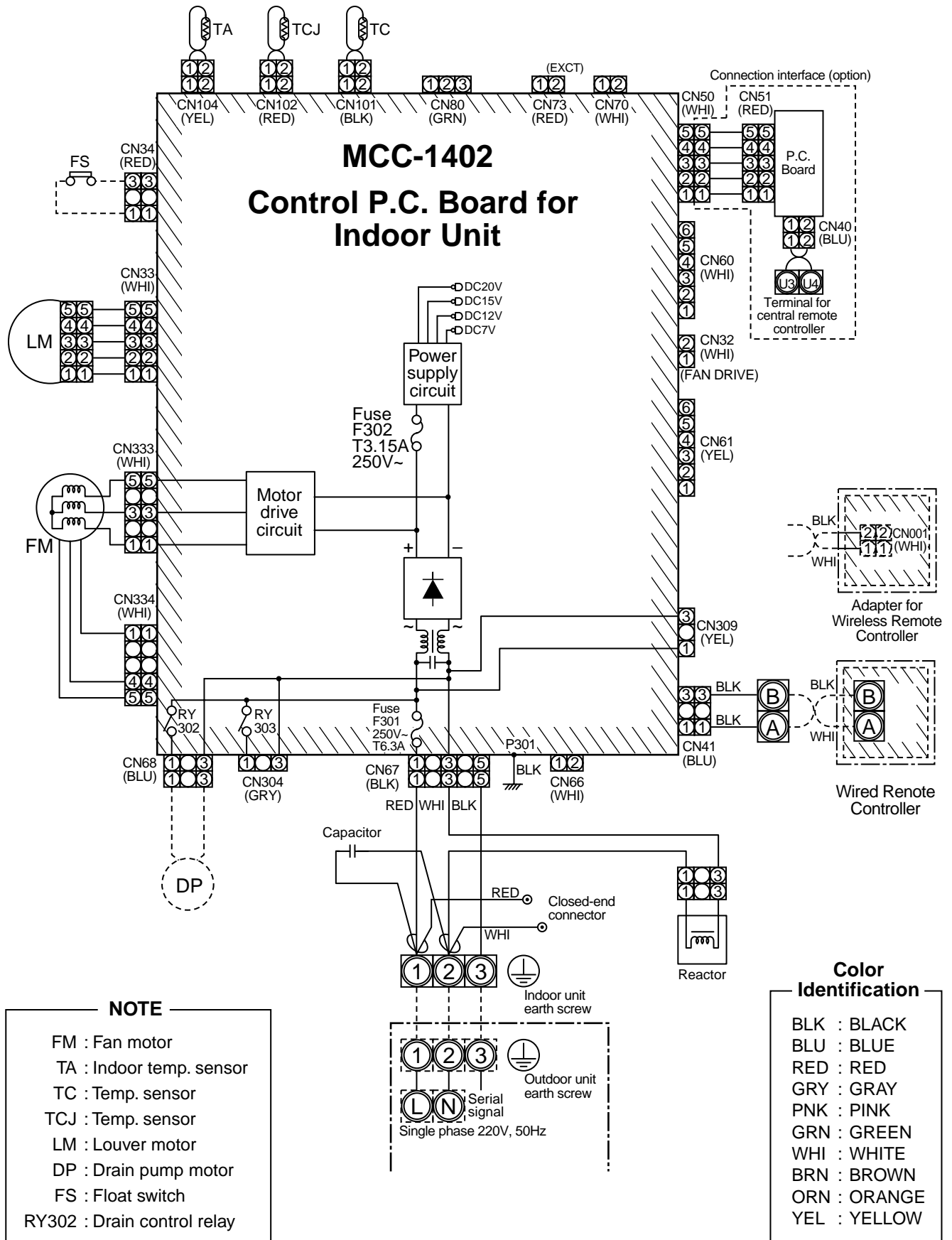

5-2. Outdoor Unit (Wiring Diagram)
 RAV-SM563AT-E, RAV-SM803AT-E

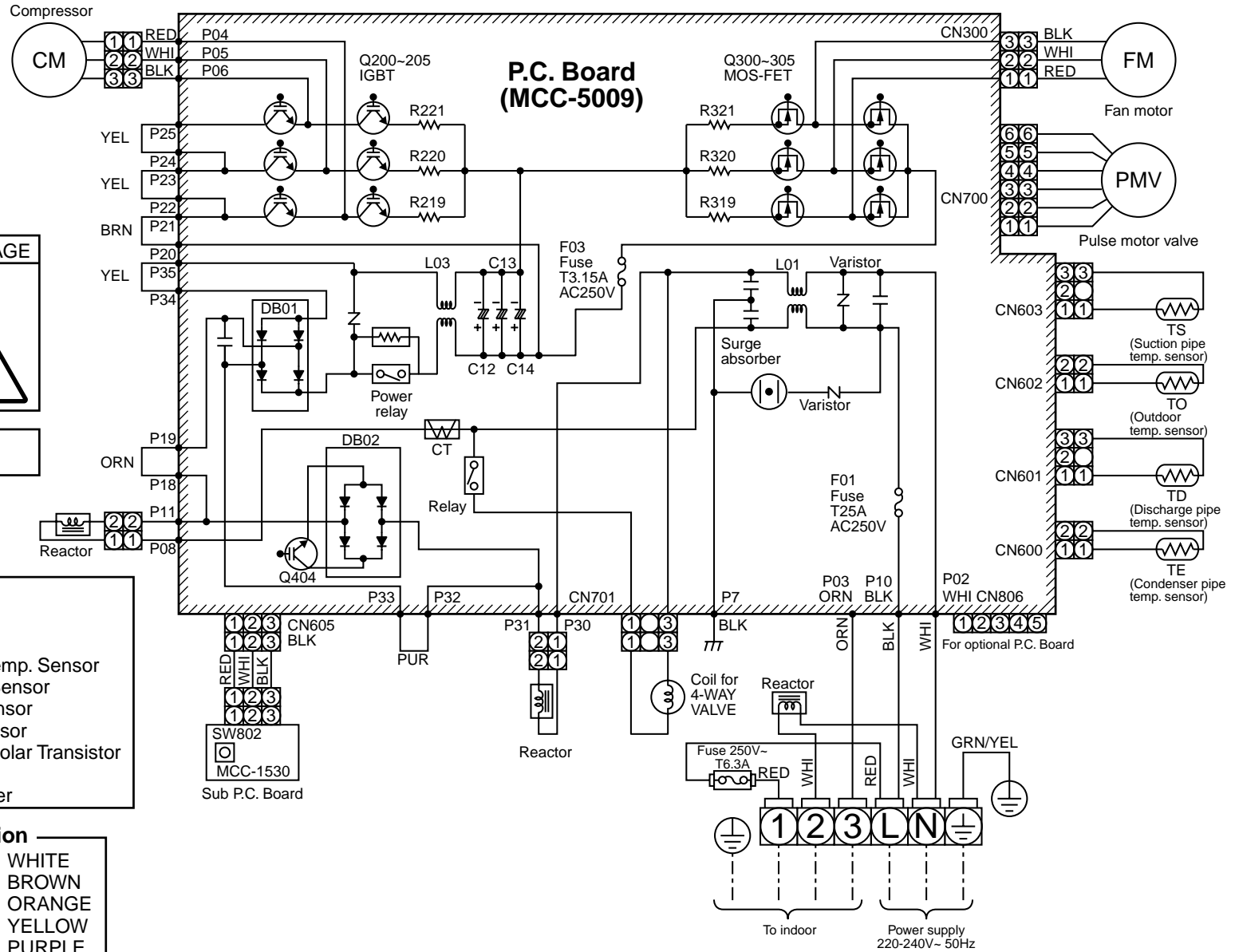

⚠ CAUTION : HIGH VOLTAGE
 The high voltage circuit is incorporated.
 Be careful to do the check service, as the electric shock may be caused in case of touching parts on the P.C. board by hand

The 4-way valve coil is turned on while the cooling operation

NOTE

- CM : Compressor
- PMV : Pulse motor valve
- FM : Fan motor
- TE : Heat exchanger Temp. Sensor
- TD : Discharge Temp. Sensor
- TO : Outdoor Temp. Sensor
- TS : Suction Temp. Sensor
- IGBT : Insulated Gate Bipolar Transistor
- DB : Rectifier
- CT : Current Transformer

Color Identification

BLK : BLACK	WHI : WHITE
BLU : BLUE	BRN : BROWN
RED : RED	ORN : ORANGE
GRY : GRAY	YEL : YELLOW
PNK : PINK	PUR : PURPLE

Color Identification

BLK : BLACK	WHI : WHITE
BLU : BLUE	BRN : BROWN
RED : RED	ORN : ORANGE
GRY : GRAY	YEL : YELLOW
PNK : PINK	PUR : PURPLE

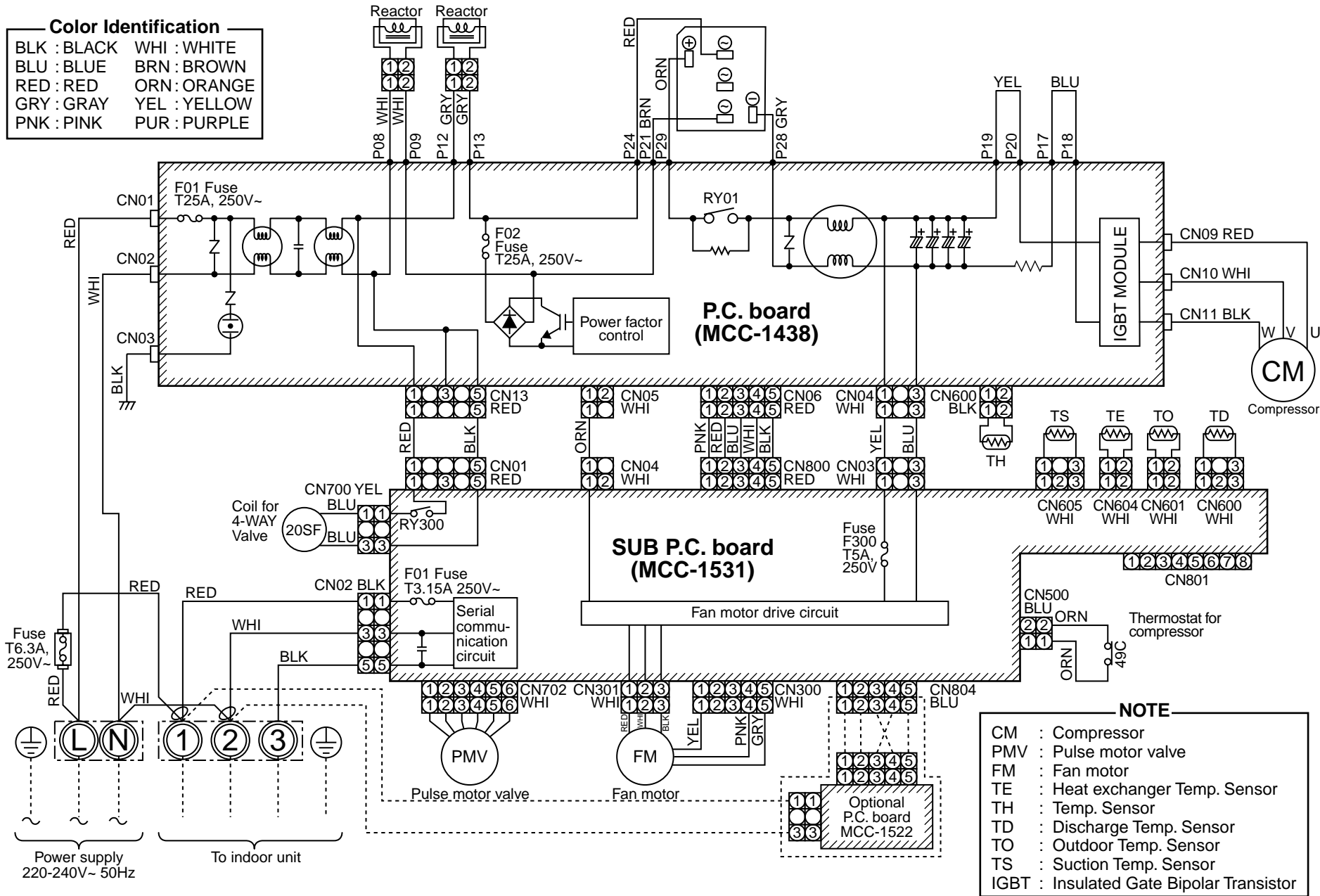

Color Identification

BLK : BLACK	WHI : WHITE
BLU : BLUE	BRN : BROWN
RED : RED	ORN : ORANGE
GRY : GRAY	YEL : YELLOW
PNK : PINK	PUR : PURPLE

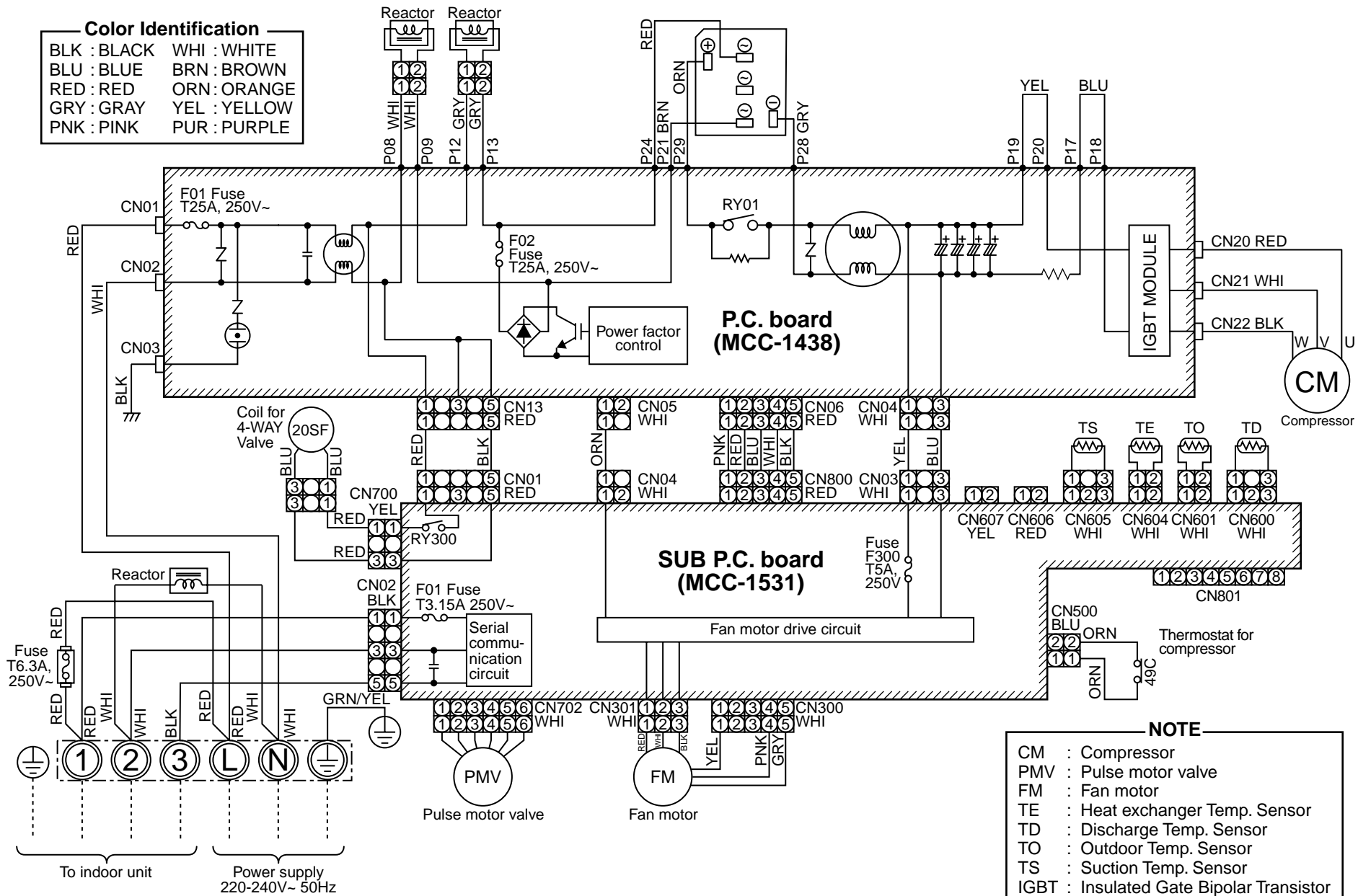

Color Identification

BLK : BLACK	WHI : WHITE
BLU : BLUE	BRN : BROWN
RED : RED	ORN : ORANGE
GRY : GRAY	YEL : YELLOW
PNK : PINK	PUR : PURPLE

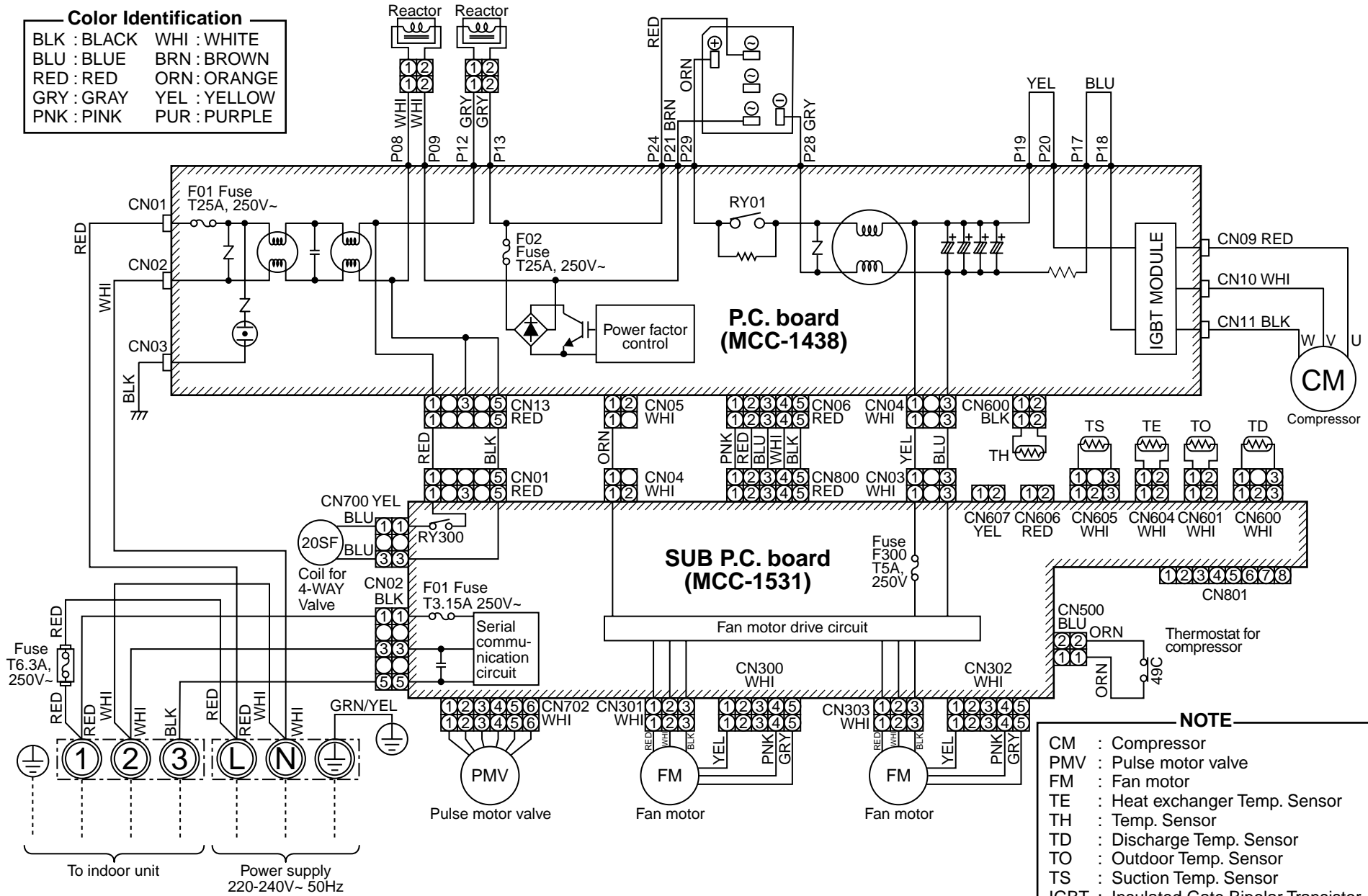

NOTE

CM	: Compressor
PMV	: Pulse motor valve
FM	: Fan motor
TE	: Heat exchanger Temp. Sensor
TH	: Temp. Sensor
TD	: Discharge Temp. Sensor
TO	: Outdoor Temp. Sensor
TS	: Suction Temp. Sensor
IGBT	: Insulated Gate Bipolar Transistor

6. SPECIFICATIONS OF ELECTRICAL PARTS

6-1. Indoor Unit

6-1-1. 4-Way Air Discharge Cassette Type

RAV-SM563UT-E, RAV-SM803UT-E

No.	Parts name	Type	Specifications
1	Fan motor (for indoor)	SWF-230-60-1R	Output (Rated) 60 W, 220–240 V
2	Thermo. sensor (TA-sensor)	155 mm	10 kΩ at 25°C
3	Heat exchanger sensor (TCJ-sensor)	Ø6 mm, 1200 mm	10 kΩ at 25°C
4	Heat exchanger sensor (TC-sensor)	Ø6 mm, 1200 mm	10 kΩ at 25°C
5	Float switch	FS-0218-102	
6	Drain pump motor	ADP-1409	

RAV-SM1103UT-E, RAV-SM1403UT-E, RAV-SP1102UT-E

No.	Parts name	Type	Specifications
1	Fan motor	SWF-200-90-1R	Output (Rated) 90 W
2	Thermo. sensor (TA-sensor)	155 mm	10 kΩ at 25°C
3	Heat exchanger sensor (TCJ-sensor)	Ø6 mm, 1200 mm	10 kΩ at 25°C
4	Heat exchanger sensor (TC-sensor)	Ø6 mm, 1200 mm	10 kΩ at 25°C
5	Float switch	FS-0218-102	
6	Drain pump motor	ADP-1409	

6-1-2. Concealed Duct Type**RAV-SM562BT-E, RAV-SM802BT-E, RAV-SM1102BT-E, RAV-SM1402BT-E**

No.	Parts name	Type	Specifications
1	Fan motor (SM802BT-E)	ICF-280-120-1B	Output (Rated) 120 W, 220–240 V
2	Fan motor (SM562BT-E/SM1102BT-E/SM1402BT-E)	ICF-280-120-2B	Output (Rated) 120 W, 220–240 V
3	Thermo. sensor (TA-sensor)	618 mm	10 kΩ at 25°C
4	Heat exchanger sensor (TCJ-sensor)	Ø6 mm, 1200 mm	10 kΩ at 25°C
5	Heat exchanger sensor (TC-sensor)	Ø6 mm, 1200 mm	10 kΩ at 25°C
6	Float switch	FS-0218-102	
7	Drain pump motor	ADP-1409	
8	Reactor	CH-43-2Z-T	10 mH, 1 A

6-1-3. Under Ceiling Type**RAV-SM562CT-E, RAV-SM802CT-E, RAV-SM1102CT-E, RAV-SM1402CT-E**

No.	Parts name	Type	Specifications
1	Fan motor (SM562CT-E)	SWF-280-60-1R	Output (Rated) 60 W, 220–240 V
2	Fan motor (SM802CT-E)	SWF-280-60-2R	Output (Rated) 60 W, 220–240 V
3	Fan motor (SM1102CT-E/SM1402CT-E)	SWF-280-120-2R	Output (Rated) 120 W, 220–240 V
4	Thermo. sensor (TA-sensor)	155 mm	10 kΩ at 25°C
5	Heat exchanger sensor (TCJ-sensor)	Ø6 mm, 1200 mm	10 kΩ at 25°C
6	Heat exchanger sensor (TC-sensor)	Ø6 mm, 1200 mm	10 kΩ at 25°C
7	Louver motor	MP24Z2N	DC 15 V
8	Reactor	CH-43-2Z-T	10 mH, 1 A

6-2. Outdoor Unit

RAV-SM563AT-E

No.	Parts name	Type	Specifications
1	Fan motor	ICF-140-43-4R	Output (Rated) 43 W
2	Compressor	DA150A1F-20F	3 phase, 4P, 1100 W
3	Reactor	CH-57	10 mH, 16A
4	Outdoor temp. sensor (To-sensor)	—	10 kΩ at 25°C
5	Heat exchanger sensor (Te-sensor)	—	10 kΩ at 25°C
6	Suction temp. sensor (Ts-sensor)	—	10 kΩ at 25°C
7	Discharge temp. sensor (Td-sensor)	—	50 kΩ at 25°C
8	Fuse (Switching power (Protect))	—	T3.15 A, AC 250 V
9	Fuse (Inverter, input (Current protect))	—	25 A, AC 250 V
10	4-way valve solenoid coil	STF-01AJ502E1	—
11	Compressor thermo. (Protection)	US-622	OFF : 125 ± 4°C, ON : 90 ± 5°C
12	Coil (Pulse Motor Valve)	CAM-MD12TF-6	—

RAV-SM803AT-E

No.	Parts name	Type	Specifications
1	Fan motor	ICF-140-43-4R	Output (Rated) 43 W
2	Compressor	DA150A1F-20F	3 phase, 4P, 1100 W
3	Reactor	CH-57	10 mH, 16 A
4	Outdoor temp. sensor (To-sensor)	—	10 kΩ at 25°C
5	Heat exchanger sensor (Te-sensor)	—	10 kΩ at 25°C
6	Suction temp. sensor (Ts-sensor)	—	10 kΩ at 25°C
7	Discharge temp. sensor (Td-sensor)	—	50 kΩ at 25°C
8	Fuse (Switching power (Protect))	—	T3.15 A, AC 250 V
9	Fuse (Inverter, input (Current protect))	—	25 A, AC 250 V
10	4-way valve solenoid coil	STF-01AJ502E1	AC 220 – 240 V
11	Compressor thermo. (Protection)	US-622	OFF : 125 ± 4°C, ON : 90 ± 5°C
12	Coil (Pulse Motor Valve)	CAM-MD12TF-6	—

RAV-SM1103AT-E

No.	Parts name	Type	Specifications
1	Fan motor	ICF-280-100-1R	Output (Rated) 100 W
2	Compressor	DA420A3F-21M	3 phase, 4P, 2000 W
3	Reactor	CH-62	6 mH, 18.5 A
4	Outdoor temp. sensor (To-sensor)	—	10 kΩ at 25°C
5	Heat exchanger sensor (Te-sensor)	—	10 kΩ at 25°C
6	Suction temp. sensor (Ts-sensor)	—	10 kΩ at 25°C
7	Discharge temp. sensor (Td-sensor)	—	50 kΩ at 25°C
8	Fuse (Switching power (Protect))	—	T3.15 A, AC 250 V
9	Fuse (Inverter, input (Current protect))	—	25 A, AC 250 V
10	4-way valve solenoid coil	STF-01AJ502E1	AC 220 – 240 V
11	Compressor thermo. (Protection)	US-622	OFF : 125 ± 4°C, ON : 90 ± 5°C
12	Coil (Pulse Motor Valve)	UKV-U048E	—

RAV-SM1403AT-E

No.	Parts name	Type	Specifications
1	Fan motor	ICF-280-100-1R	Output (Rated) 100 W
2	Compressor	DA420A3F-21M	3 phase, 4P, 3500 W
3	Reactor	CH-62	6 mH, 18.5 A
4	Outdoor temp. sensor (To-sensor)	—	10 kΩ at 25°C
5	Heat exchanger sensor (Te-sensor)	—	10 kΩ at 25°C
6	Suction temp. sensor (Ts-sensor)	—	10 kΩ at 25°C
7	Discharge temp. sensor (Td-sensor)	—	50 kΩ at 25°C
8	Fuse (Switching power (Protect))	—	T3.15 A, AC 250 V
9	Fuse (Inverter, input (Current protect))	—	25 A, AC 250 V
10	4-way valve solenoid coil	VHV-01AJ503C1	AC 220 – 240 V
11	Compressor thermo. (Protection)	US-622	OFF : 125 ± 4°C, ON : 90 ± 5°C
12	Coil (Pulse Motor Valve)	UKV-U048E	—

RAV-SP562AT-E, RAV-SP802AT-E

No.	Parts name	Type	Specifications
1	Fan motor	ICF-140-63-2R	Output (Rated) 63 W
2	Compressor	DA220A2F-20L1	3 phase, 4P, 2000 W
3	Reactor	CH-47	8 mH, 16 A
4	Outdoor temp. sensor (To-sensor)	—	10 kΩ at 25°C
5	Heat exchanger sensor (Te-sensor)	—	10 kΩ at 25°C
6	Suction temp. sensor (Ts-sensor)	—	10 kΩ at 25°C
7	Discharge temp. sensor (Td-sensor)	—	50 kΩ at 25°C
8	Fuse (Switching power (Protect))	—	T3.15 A, AC 250 V
9	Fuse (Inverter, input (Current protect))	—	25 A, AC 250 V
10	4-way valve solenoid coil	VHV-01AJ503C1	
11	Compressor thermo. (Protection)	US-622	OFF : 125 ± 4°C, ON : 90 ± 5°C
12	Coil (Pulse Motor Valve)	CAM-MD12TF-8	
13	Reactor	CH-43	10 mH, 1 A

RAV-SP1102AT-E, RAV-SP1402AT-E

No.	Parts name	Type	Specifications
1	Fan motor	ICF-140-63-2R	Output (Rated) 63 W
2	Compressor	DA420A3F-21M	3 phase, 4P, 3500 W
3	Reactor	CH-62	6 mH, 18.5 A
4	Outdoor temp. sensor (To-sensor)	—	10 kΩ at 25°C
5	Heat exchanger sensor (Te-sensor)	—	10 kΩ at 25°C
6	Suction temp. sensor (Ts-sensor)	—	10 kΩ at 25°C
7	Discharge temp. sensor (Td-sensor)	—	50 kΩ at 25°C
8	Fuse (Switching power (Protect))	—	T3.15 A, AC 250 V
9	Fuse (Inverter, input (Current protect))	—	25 A, AC 250 V
10	4-way valve solenoid coil	VHV-01AJ502E1	AC 220 V
11	Compressor thermo. (Protection)	US-622	OFF : 125 ± 4°C, ON : 90 ± 5°C
12	Coil (Pulse Motor Valve)	UKV-U011E	—

6-3. Accessory Separate Soldparts

TCB-DP22CE2 (Drain up kit)

RAV-SM562CT-E, RAV-SM802CT-E, RAV-SM1102CT-E, RAV-SM1402CT-E

No.	Parts name	Type	Specifications
1	Float switch	FS-0218-102	
2	Drain pump motor	ADP-1415	

RBC-U21PG (W) -E2 (Ceiling panel)

RAV-SM563UT-E, RAV-SM803UT-E, RAV-SM1103UT-E, RAV-SM1403UT-E / RAV-SP1102UT-E

No.	Parts name	Type	Specifications
1	Motor-louver	MP24ZN	DC 12 V
2			

7. REFRIGERANT R410A

This air conditioner adopts the new refrigerant HFC (R410A) which does not damage the ozone layer.

The working pressure of the new refrigerant R410A is 1.6 times higher than conventional refrigerant (R22). The refrigerating oil is also changed in accordance with change of refrigerant, so be careful that water, dust, and existing refrigerant or refrigerating oil are not entered in the refrigerant cycle of the air conditioner using the new refrigerant during installation work or servicing time.

The next section describes the precautions for air conditioner using the new refrigerant. Conforming to contents of the next section together with the general cautions included in this manual, perform the correct and safe work.

7-1. Safety During Installation/Servicing

As R410A's pressure is about 1.6 times higher than that of R22, improper installation/servicing may cause a serious trouble. By using tools and materials exclusive for R410A, it is necessary to carry out installation/servicing safely while taking the following precautions into consideration.

1. Never use refrigerant other than R410A in an air conditioner which is designed to operate with R410A.
If other refrigerant than R410A is mixed, pressure in the refrigeration cycle becomes abnormally high, and it may cause personal injury, etc. by a rupture.
2. Confirm the used refrigerant name, and use tools and materials exclusive for the refrigerant R410A.
The refrigerant name R410A is indicated on the visible place of the outdoor unit of the air conditioner using R410A as refrigerant. To prevent mischarging, the diameter of the service port differs from that of R22.
3. If a refrigeration gas leakage occurs during installation/servicing, be sure to ventilate fully.
If the refrigerant gas comes into contact with fire, a poisonous gas may occur.
4. When installing or removing an air conditioner, do not allow air or moisture to remain in the refrigeration cycle. Otherwise, pressure in the refrigeration cycle may become abnormally high so that a rupture or personal injury may be caused.
5. After completion of installation work, check to make sure that there is no refrigeration gas leakage.
If the refrigerant gas leaks into the room, coming into contact with fire in the fan-driven heater, space heater, etc., a poisonous gas may occur.

6. When an air conditioning system charged with a large volume of refrigerant is installed in a small room, it is necessary to exercise care so that, even when refrigerant leaks, its concentration does not exceed the marginal level.

If the refrigerant gas leakage occurs and its concentration exceeds the marginal level, an oxygen starvation accident may result.

7. Be sure to carry out installation or removal according to the installation manual.
Improper installation may cause refrigeration trouble, water leakage, electric shock, fire, etc.
8. Unauthorized modifications to the air conditioner may be dangerous. If a breakdown occurs please call a qualified air conditioner technician or electrician.
Improper repair's may result in water leakage, electric shock and fire, etc.

7-2. Refrigerant Piping Installation

7-2-1. Piping Materials and Joints Used

For the refrigerant piping installation, copper pipes and joints are mainly used. Copper pipes and joints suitable for the refrigerant must be chosen and installed. Furthermore, it is necessary to use clean copper pipes and joints whose interior surfaces are less affected by contaminants.

1. Copper Pipes
It is necessary to use seamless copper pipes which are made of either copper or copper alloy and it is desirable that the amount of residual oil is less than 40 mg/10 m. Do not use copper pipes having a collapsed, deformed or discolored portion (especially on the interior surface). Otherwise, the expansion valve or capillary tube may become blocked with contaminants.
As an air conditioner using R410A incurs pressure higher than when using R22, it is necessary to choose adequate materials.
Thicknesses of copper pipes used with R410A are as shown in Table 7-2-1. Never use copper pipes thinner than 0.8 mm even when it is available on the market.

NOTE:

Refer to the "7-6. Instructions for Re-use Piping of R22 or R407C".

Table 7-2-1 Thicknesses of annealed copper pipes

		Thickness (mm)	
Nominal diameter	Outer diameter (mm)	R410A	R22
1/4	6.4	0.80	0.80
3/8	9.5	0.80	0.80
1/2	12.7	0.80	0.80
5/8	15.9	1.00	1.00

1. Joints

For copper pipes, flare joints or socket joints are used. Prior to use, be sure to remove all contaminants.

a) Flare Joints

Flare joints used to connect the copper pipes cannot be used for pipings whose outer diameter exceeds 20 mm. In such a case, socket joints can be used.

Sizes of flare pipe ends, flare joint ends and flare nuts are as shown in Tables 7-2-3 to 7-2-6 below.

b) Socket Joints

Socket joints are such that they are brazed for connections, and used mainly for thick pipings whose diameter is larger than 20 mm. Thicknesses of socket joints are as shown in Table 7-2-2.

Table 7-2-2 Minimum thicknesses of socket joints

Nominal diameter	Reference outer diameter of copper pipe jointed (mm)	Minimum joint thickness (mm)
1/4	6.4	0.50
3/8	9.5	0.60
1/2	12.7	0.70
5/8	15.9	0.80

7-2-2. Processing of Piping Materials

When performing the refrigerant piping installation, care should be taken to ensure that water or dust does not enter the pipe interior, that no other oil other than lubricating oils used in the installed air conditioner is used, and that refrigerant does not leak. When using lubricating oils in the piping processing, use such lubricating oils whose water content has been removed. When stored, be sure to seal the container with an airtight cap or any other cover.

1. Flare Processing Procedures and Precautions

a) Cutting the Pipe

By means of a pipe cutter, slowly cut the pipe so that it is not deformed.

b) Removing Burrs and Chips

If the flared section has chips or burrs, refrigerant leakage may occur.

Carefully remove all burrs and clean the cut surface before installation.

c) Insertion of Flare Nut

d) Flare Processing

Make certain that a clamp bar and copper pipe have been cleaned.

By means of the clamp bar, perform the flare processing correctly.

Use either a flare tool for R410A or conventional flare tool.

Flare processing dimensions differ according to the type of flare tool.

When using a conventional flare tool, be sure to secure "dimension A" by using a gauge for size adjustment.

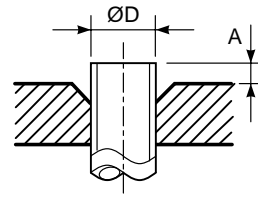

Fig. 7-2-1 Flare processing dimensions

Table 7-2-3 Dimensions related to flare processing for R410A

Nominal diameter	Outer diameter (mm)	Thickness (mm)	A (mm)		
			Flare tool for		Conventional flare tool
			R410A clutch type	Clutch type	
1/4	6.4	0.8	0 to 0.5	1.0 to 1.5	1.5 to 2.0
3/8	9.5	0.8	0 to 0.5	1.0 to 1.5	1.5 to 2.0
1/2	12.7	0.8	0 to 0.5	1.0 to 1.5	2.0 to 2.5
5/8	15.9	1.0	0 to 0.5	1.0 to 1.5	2.0 to 2.5

Table 7-2-4 Dimensions related to flare processing for R22

Nominal diameter	Outer diameter (mm)	Thickness (mm)	A (mm)		
			Flare tool for		Conventional flare tool
			R22 clutch type	Clutch type	
1/4	6.4	0.8	0 to 0.5	0.5 to 1.0	1.0 to 1.5
3/8	9.5	0.8	0 to 0.5	0.5 to 1.0	1.0 to 1.5
1/2	12.7	0.8	0 to 0.5	0.5 to 1.0	1.5 to 2.0
5/8	15.9	1.0	0 to 0.5	0.5 to 1.0	1.5 to 2.0

Table 7-2-5 Flare and flare nut dimensions for R410A

Nominal diameter	Outer diameter (mm)	Thickness (mm)	Dimension (mm)				Flare nut width (mm)
			A	B	C	D	
1/4	6.4	0.8	9.1	9.2	6.5	13	17
3/8	9.5	0.8	13.2	13.5	9.7	20	22
1/2	12.7	0.8	16.6	16.0	12.9	23	26
5/8	15.9	1.0	19.7	19.0	16.0	25	29

Table 7-2-6 Flare and flare nut dimensions for R22

Nominal diameter	Outer diameter (mm)	Thickness (mm)	Dimension (mm)				Flare nut width (mm)
			A	B	C	D	
1/4	6.4	0.8	9.0	9.2	6.5	13	17
3/8	9.5	0.8	13.0	13.5	9.7	20	22
1/2	12.7	0.8	16.2	16.0	12.9	20	24
5/8	15.9	1.0	19.4	19.0	16.0	23	27
3/4	19.0	1.0	23.3	24.0	19.2	34	36

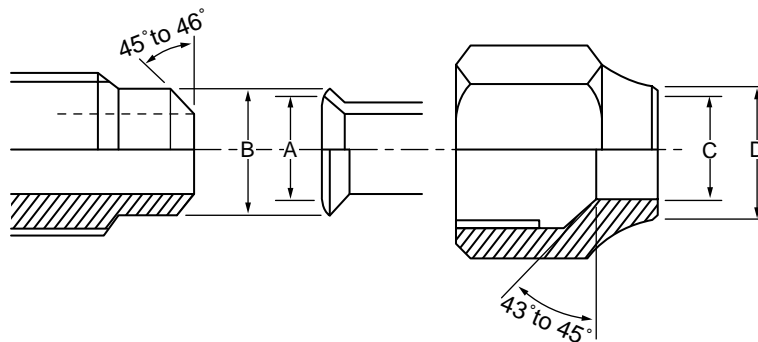

Fig. 7-2-2 Relations between flare nut and flare seal surface

2. Flare Connecting Procedures and Precautions

- a) Make sure that the flare and union portions do not have any scar or dust, etc.
- b) Correctly align the processed flare surface with the union axis.
- c) Tighten the flare with designated torque by means of a torque wrench. The tightening torque for R410A is the same as that for conventional R22. Incidentally, when the torque is weak, the gas leakage may occur. When it is strong, the flare nut may crack and may be made non-removable. When choosing the tightening torque, comply with values designated by manufacturers. Table 7-2-7 shows reference values.

NOTE:

When applying oil to the flare surface, be sure to use oil designated by the manufacturer. If any other oil is used, the lubricating oils may deteriorate and cause the compressor to burn out.

Table 7-2-7 Tightening torque of flare for R410A [Reference values]

Nominal diameter	Outer diameter (mm)	Tightening torque N•m (kgf•m)	Tightening torque of torque wrenches available on the market N•m (kgf•m)
1/4	6.4	14 to 18 (1.4 to 1.8)	16 (1.6), 18 (1.8)
3/8	9.5	33 to 42 (3.3 to 4.2)	42 (4.2)
1/2	12.7	50 to 62 (5.0 to 6.2)	55 (5.5)
5/8	15.9	63 to 77 (6.3 to 7.7)	65 (6.5)

7-3. Tools

7-3-1. Required Tools

Refer to the “4. Tools” (Page 8)

7-4. Recharging of Refrigerant

When it is necessary to recharge refrigerant, charge the specified amount of new refrigerant according to the following steps.

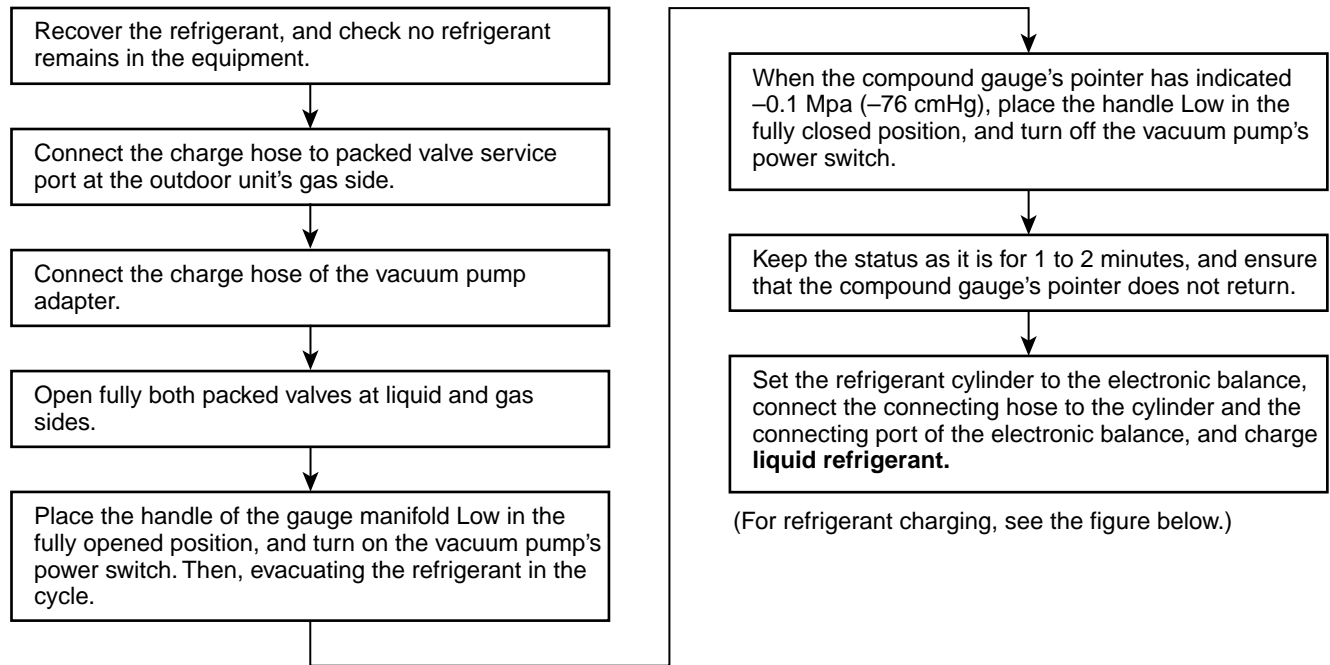

- 1) Never charge refrigerant exceeding the specified amount.
- 2) If the specified amount of refrigerant cannot be charged, charge refrigerant **bit by bit** in COOL mode.
- 3) Do not carry out additional charging.
When additional charging is carried out if refrigerant leaks, the refrigerant composition changes in the refrigeration cycle, that is characteristics of the air conditioner changes, refrigerant exceeding the specified amount is charged, and working pressure in the refrigeration cycle becomes abnormally high pressure, and may cause a rupture or personal injury.

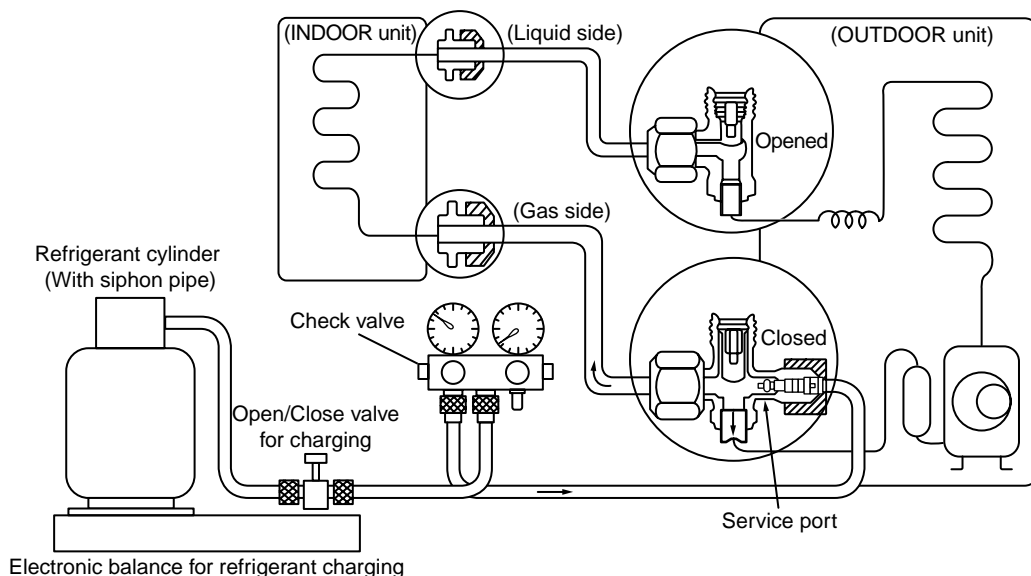
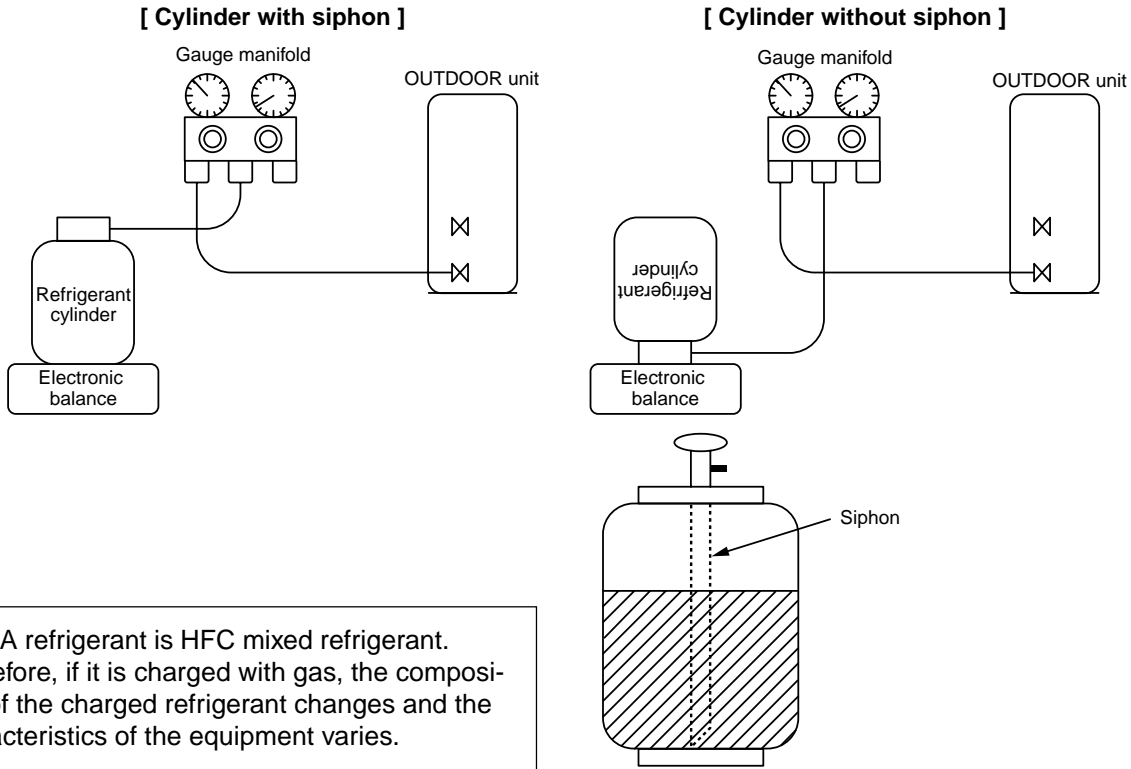

Fig. 7-4-1 Configuration of refrigerant charging

- 1) Be sure to make setting so that **liquid** can be charged.
- 2) When using a cylinder equipped with a siphon, liquid can be charged without turning it upside down.

It is necessary for charging refrigerant under condition of liquid because R410A is mixed type of refrigerant. Accordingly, when charging refrigerant from the refrigerant cylinder to the equipment, charge it turning the cylinder upside down if cylinder is not equipped with siphon.



R410A refrigerant is HFC mixed refrigerant. Therefore, if it is charged with gas, the composition of the charged refrigerant changes and the characteristics of the equipment varies.

Fig. 7-4-2

7-5. Brazing of Pipes

7-5-1. Materials for Brazing

1. Silver brazing filler

Silver brazing filler is an alloy mainly composed of silver and copper. It is used to join iron, copper or copper alloy, and is relatively expensive though it excels in solderability.

2. Phosphor bronze brazing filler

Phosphor bronze brazing filler is generally used to join copper or copper alloy.

3. Low temperature brazing filler

Low temperature brazing filler is generally called solder, and is an alloy of tin and lead. Since it is weak in adhesive strength, do not use it for refrigerant pipes.

- 1) Phosphor bronze brazing filler tends to react with sulfur and produce a fragile compound water solution, which may cause a gas leakage. Therefore, use any other type of brazing filler at a hot spring resort, etc., and coat the surface with a paint.
- 2) When performing brazing again at time of servicing, use the same type of brazing filler.

7-5-2. Flux

1. Reason why flux is necessary

- By removing the oxide film and any foreign matter on the metal surface, it assists the flow of brazing filler.
- In the brazing process, it prevents the metal surface from being oxidized.
- By reducing the brazing filler's surface tension, the brazing filler adheres better to the treated metal.

2. Characteristics required for flux

- Activated temperature of flux coincides with the brazing temperature.
- Due to a wide effective temperature range, flux is hard to carbonize.
- It is easy to remove slag after brazing.
- The corrosive action to the treated metal and brazing filler is minimum.
- It excels in coating performance and is harmless to the human body.

As the flux works in a complicated manner as described above, it is necessary to select an adequate type of flux according to the type and shape of treated metal, type of brazing filler and brazing method, etc.

3. Types of flux

• Noncorrosive flux

Generally, it is a compound of borax and boric acid.

It is effective in case where the brazing temperature is higher than 800°C.

• Activated flux

Most of fluxes generally used for silver brazing are this type.

It features an increased oxide film removing capability due to the addition of compounds such as potassium fluoride, potassium chloride and sodium fluoride to the borax-boric acid compound.

4. Piping materials for brazing and used brazing filler/flux

Piping material	Used brazing filler	Used flux
Copper - Copper	Phosphor copper	Do not use
Copper - Iron	Silver	Paste flux
Iron - Iron	Silver	Vapor flux

- 1) Do not enter flux into the refrigeration cycle.
- 2) When chlorine contained in the flux remains within the pipe, the lubricating oil deteriorates. Therefore, use a flux which does not contain chlorine.
- 3) When adding water to the flux, use water which does not contain chlorine (e.g. distilled water or ion-exchange water).
- 4) Remove the flux after brazing.

7-5-3. Brazing

As brazing work requires sophisticated techniques, experiences based upon a theoretical knowledge, it must be performed by a person qualified.

In order to prevent the oxide film from occurring in the pipe interior during brazing, it is effective to proceed with brazing while letting dry Nitrogen gas flow.

Never use gas other than Nitrogen gas.

1. Brazing method to prevent oxidation

- 1) Attach a reducing valve and a flow-meter to the Nitrogen gas cylinder.
- 2) Use a copper pipe to direct the piping material, and attach a flow-meter to the cylinder.
- 3) Apply a seal onto the clearance between the piping material and inserted copper pipe for Nitrogen in order to prevent backflow of the Nitrogen gas.
- 4) When the Nitrogen gas is flowing, be sure to keep the piping end open.
- 5) Adjust the flow rate of Nitrogen gas so that it is lower than 0.05 m³/Hr or 0.02 MPa (0.2kgf/cm²) by means of the reducing valve.
- 6) After performing the steps above, keep the Nitrogen gas flowing until the pipe cools down to a certain extent (temperature at which pipes are touchable with hands).
- 7) Remove the flux completely after brazing.

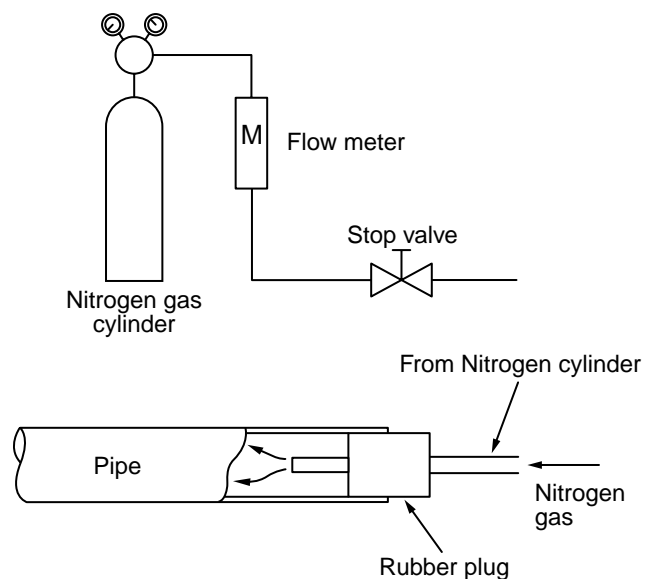

Fig. 7-5-1 Prevention of oxidation during brazing

7-6. Instructions for Re-use Piping of R22 or R407C

Instruction of Works:

The existing R22 and R407C piping can be reused for our digital inverter R410A products installations.

NOTE)

Confirmation of existence of scratch or dent of the former pipes to be applied and also confirmation of reliability of the pipe strength are conventionally referred to the local site.

If the definite conditions can be cleared, it is possible to update the existing R22 and R407C pipes to those for R410A models.

7-6-1. Basic conditions need to reuse the existing pipe

Check and observe three conditions of the refrigerant piping works.

1. Dry (There is no moisture inside of the pipes.)
2. Clean (There is no dust inside of the pipes.)
3. Tight (There is no refrigerant leak.)

7-6-2. Restricted items to use the existing pipes

In the following cases, the existing pipes cannot be reused as they are. Clean the existing pipes or exchange them with new pipes.

1. When a scratch or dent is heavy, be sure to use the new pipes for the works.
2. When the thickness of the existing pipe is thinner than the specified "Pipe diameter and thickness" be sure to use the new pipes for the works.
 - The operating pressure of R410A is high (1.6 times of R22 and R407C). If there is a scratch or dent on the pipe or thinner pipe is used, the pressure strength is poor and may cause breakage of the pipe at the worst.

* Pipe diameter and thickness (mm)

Pipe outer diameter		Ø6.4	Ø9.5	Ø12.7	Ø15.9	Ø19.0
Thickness	R410A	0.8	0.8	0.8	1.0	1.0
	R22 (R407C)					

- In case that the pipe diameter is Ø12.7 mm or less and the thickness is less than 0.7 mm, be sure to use the new pipes for works.
3. The pipes are left as coming out or gas leaks. (Poor refrigerant)
 - There is possibility that rain water or air including moisture enters in the pipe.
 4. Refrigerant recovery is impossible. (Refrigerant recovery by the pump-down operation on the existing air conditioner)
 - There is possibility that a large quantity of poor oil or moisture remains inside of the pipe.
 5. A dryer on the market is attached to the existing pipes.
 - There is possibility that copper green rust generated.

6. Check the oil when the existing air conditioner was removed after refrigerant had been recovered. In this case, if the oil is judged as clearly different compared with normal oil
 - The refrigerator oil is copper rust green : There is possibility that moisture is mixed with the oil and rust generates inside of the pipe.
 - There is discolored oil, a large quantity of the remains, or bad smell.
 - A large quantity of sparkle remained wear-out powder is observed in the refrigerator oil.
7. The air conditioner which compressor was exchanged due to a faulty compressor. When the discolored oil, a large quantity of the remains, mixture of foreign matter, or a large quantity of sparkle remained wear-out powder is observed, the cause of trouble will occur.
8. Installation and removal of the air conditioner are repeated with temporary installation by lease and etc.
9. In case that type of the refrigerator oil of the existing air conditioner is other than the following oil (Mineral oil), Suniso, Freol-S, MS (Synthetic oil), alkyl benzene (HAB, Barrel-freeze), ester series, PVE only of ether series.
 - Winding-insulation of the compressor may become inferior.

NOTE)

The above descriptions are results of confirmation by our company and they are views on our air conditioners, but they do not guarantee the use of the existing pipes of the air conditioner that adopted R410A in other companies.

7-6-3. Branching pipe for simultaneous operation system

- In the concurrent twin system, when TOSHIBA-specified branching pipe is used, it can be reused. Branching pipe model name: RBC-TWP30E-2, RBC-TWP50E-2
On the existing air conditioner for simultaneous operation system (twin system), there is a case of using branch pipe that has insufficient compressive strength. In this case please change it to the branch pipe for R410A.

7-6-4. Curing of pipes

When removing and opening the indoor unit or outdoor unit for a long time, cure the pipes as follows:

- Otherwise rust may generate when moisture or foreign matter due to dewing enters in the pipes.
- The rust cannot be removed by cleaning, and a new piping work is necessary.

Place position	Term	Curing manner
Outdoors	1 month or more	Pinching
	Less than 1 month	Pinching or taping
Indoors	Every time	

7-6-5. Final Installation Checks

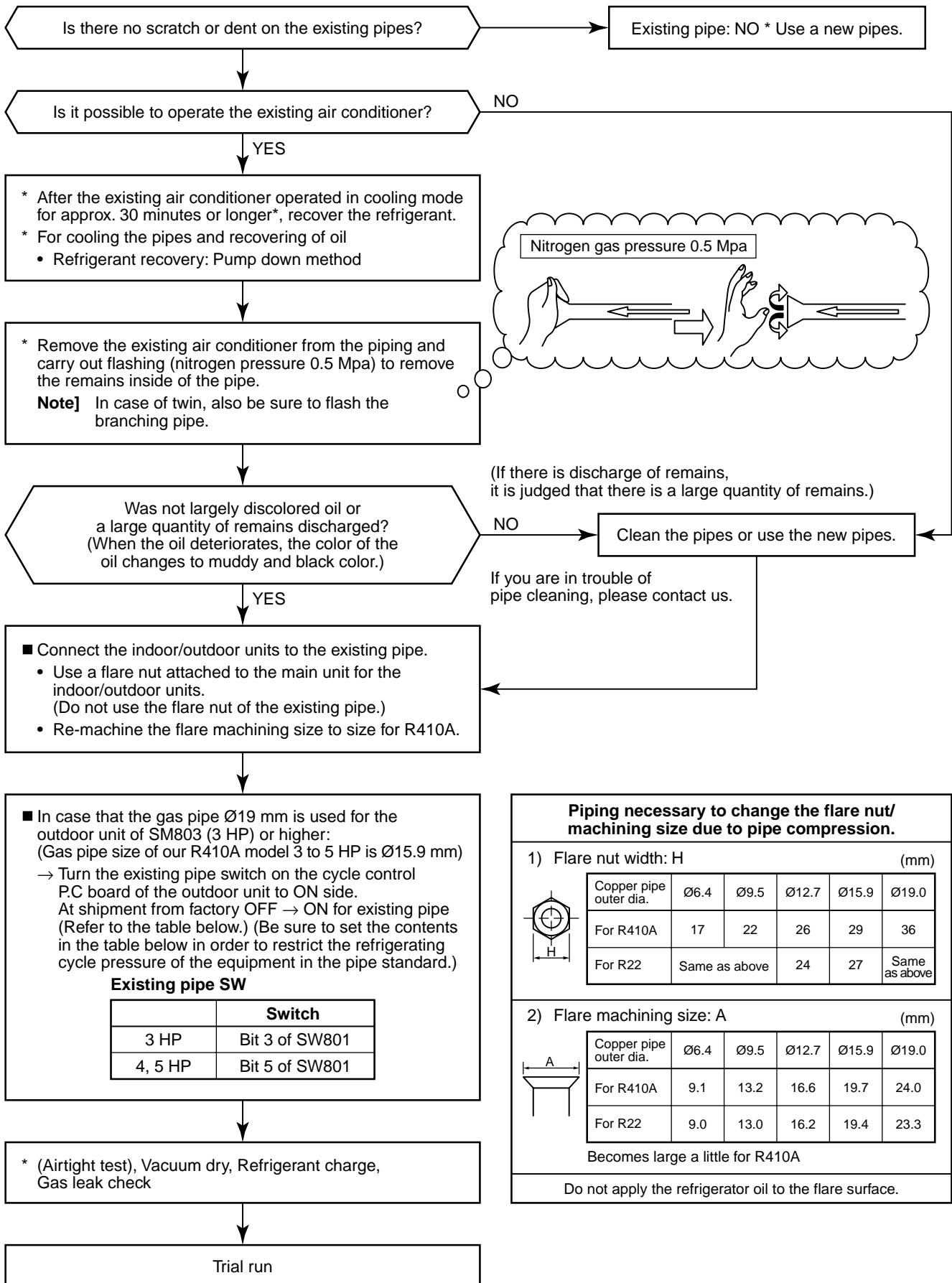

Piping necessary to change the flare nut/ machining size due to pipe compression.

1) Flare nut width: H (mm)

Copper pipe outer dia.	$\varnothing 6.4$	$\varnothing 9.5$	$\varnothing 12.7$	$\varnothing 15.9$	$\varnothing 19.0$
For R410A	17	22	26	29	36
For R22	Same as above		24	27	Same as above

2) Flare machining size: A (mm)

Copper pipe outer dia.	$\varnothing 6.4$	$\varnothing 9.5$	$\varnothing 12.7$	$\varnothing 15.9$	$\varnothing 19.0$
For R410A	9.1	13.2	16.6	19.7	24.0
For R22	9.0	13.0	16.2	19.4	23.3

Becomes large a little for R410A

Do not apply the refrigerator oil to the flare surface.

7-6-6. Recovery method of refrigerant for RAV-SM563AT-E, SM803AT-E

- When recovering refrigerant in case of reinstallation of the indoor or outdoor unit, etc., use the refrigerant recovery switch on the terminal block of the outdoor unit.

Work procedure

1. Turn on the power supply.
2. Using the remote controller, set FAN operation to the indoor unit.
3. Pushing the refrigerant recovery switch on the terminal block of the outdoor unit starts the forced cooling operation. (Max. 10 minutes), and then the refrigerant is recovered by operation of the valve.
4. After recovery of the refrigerant, push the refrigerant recovery switch together with closing the valve. The operation stops.
5. Turn off the power supply.

DANGER

Take care for an electric shock because the control P.C. board is electrified.

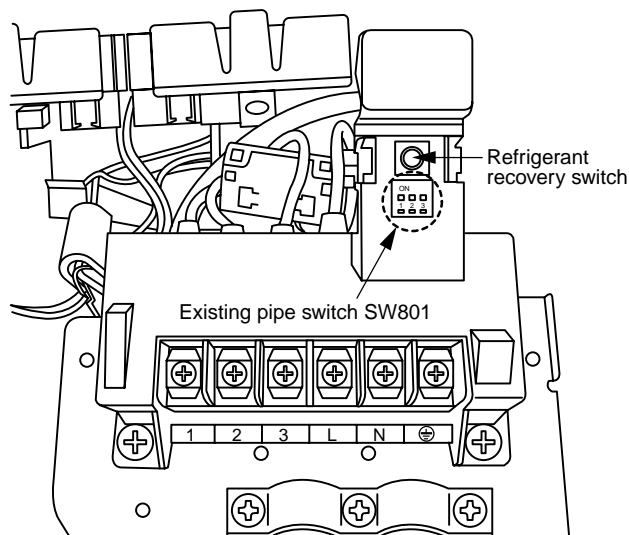

Only when the existing gas pipe $\varnothing 19$ mm is used on RAV-SM803AT-E model, change the setting of SW801 No. 3.



7-6-7. Recovery method of refrigerant for RAV-SM1103AT-E, SM1403AT-E

- When recovering refrigerant in case of reinstallation of the indoor or outdoor unit, etc., use the refrigerant recovery switch SW802 on the cycle control P.C. board of the outdoor unit.

Work procedure

1. Turn on the power supply.
2. Using the remote controller, set FAN operation to the indoor unit.
3. Pushing the refrigerant recovery switch SW802 on the cycle control P.C. board of the outdoor unit starts the forced cooling operation. (Max. 10 minutes), and then the refrigerant is recovered by operation of the valve.
4. After recovery of the refrigerant, push the refrigerant recovery switch SW802 together with closing the valve. The operation stops.
5. Turn off the power supply.

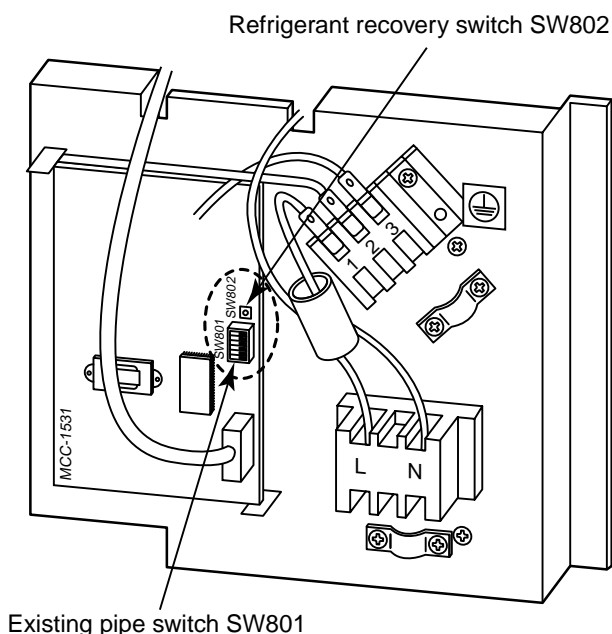

Only when the existing gas pipe $\varnothing 19$ mm is used on RAV-SM1103AT-E model, change the setting of SW801 No. 5.

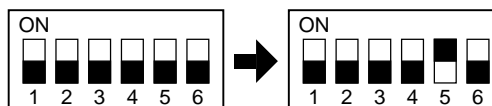

8. CONTROL BLOCK DIAGRAM

8-1. Indoor Control Circuit

- *1 Connection Interface is attached to master unit.
(In case of group control operation)
- *2 Weekly timer is not connectable to the sub remote controller.

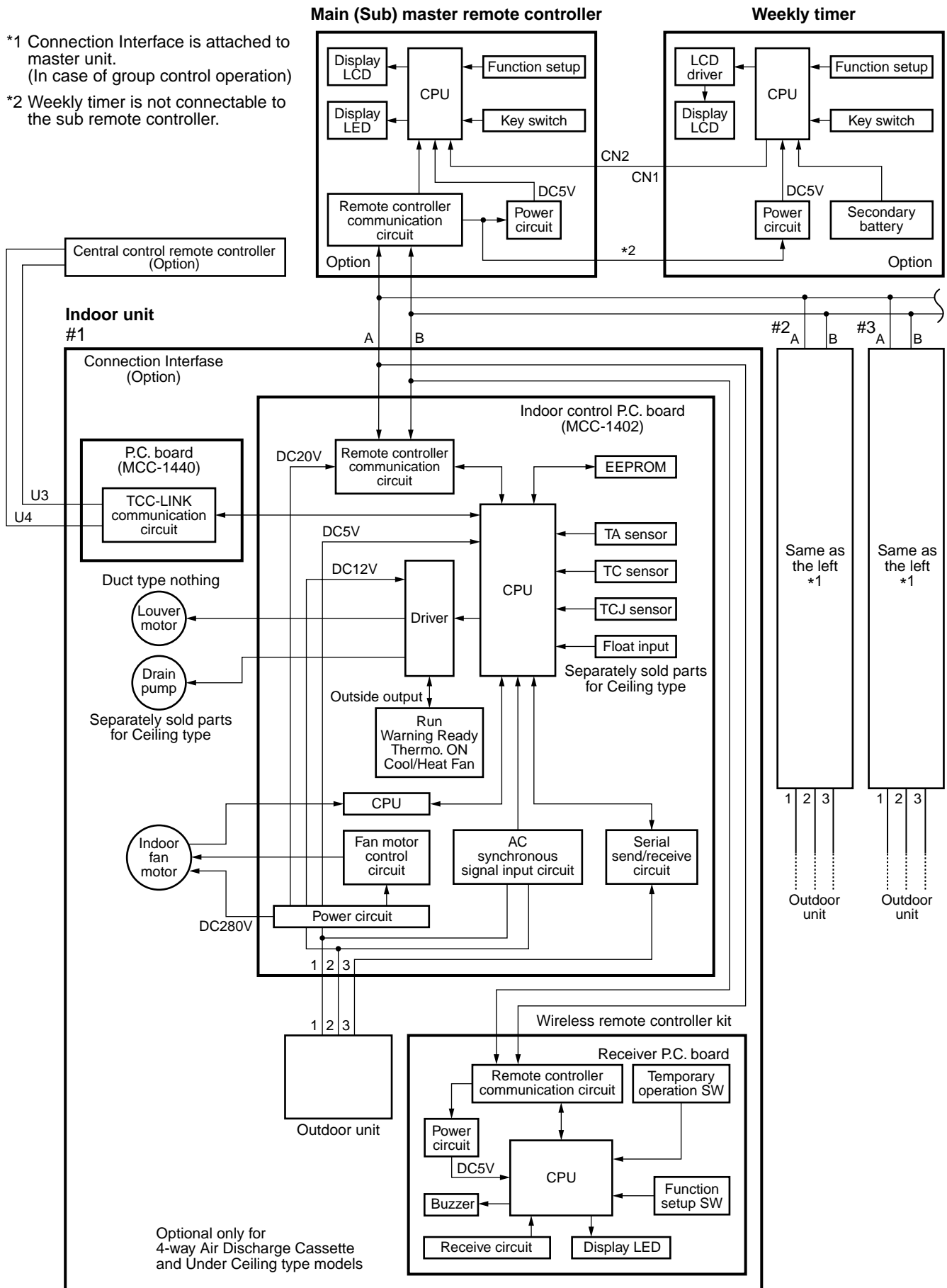

Optional only for
4-way Air Discharge Cassette
and Under Ceiling type models

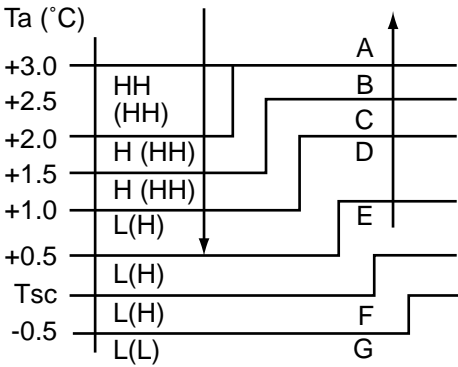

8-2. Control Specifications

No.	Item	Outline of specifications	Remarks												
1	When power supply is reset	<p>1) Distinction of outdoor units When the power supply is reset, the outdoors are distinguished, and control is exchanged according to the distinguished result.</p> <p>2) Setting of speed of the indoor fan/setting whether to adjust air direction or not. (Only 4-way models) Based on EEPROM data, speed of the indoor fan or setting whether to adjust air direction or not is selected.</p>	Air speed/ Air direction adjustment												
2	Operation mode selection	<p>1) Based on the operation mode selecting command from the remote controller, the operation mode is selected.</p> <table border="1" data-bbox="459 734 1082 1008"> <thead> <tr> <th data-bbox="464 741 699 797">Remote controller command</th> <th data-bbox="699 741 1077 797">Outline of control</th> </tr> </thead> <tbody> <tr> <td data-bbox="464 797 699 842">STOP</td> <td data-bbox="699 797 1077 842">Air conditioner stops.</td> </tr> <tr> <td data-bbox="464 842 699 887">FAN</td> <td data-bbox="699 842 1077 887">Fan operation</td> </tr> <tr> <td data-bbox="464 887 699 931">COOL</td> <td data-bbox="699 887 1077 931">Cooling operation</td> </tr> <tr> <td data-bbox="464 931 699 976">DRY</td> <td data-bbox="699 931 1077 976">Dry operation</td> </tr> <tr> <td data-bbox="464 976 699 1021">HEAT</td> <td data-bbox="699 976 1077 1021">Heating operation</td> </tr> </tbody> </table> <p data-bbox="464 1021 1082 1099">• COOL/HEAT operation mode is automatically selected by T_a and T_s for operation.</p> <div data-bbox="571 1099 997 1368"> <p>The graph plots room temperature T_a (°C) on the vertical axis, ranging from -1.5 to +1.5. A horizontal line represents the thermostat setpoint, labeled T_{sc} or T_{sh}. The region above +1.5 is designated for 'COOL' mode, and the region below -1.5 is for 'HEAT' mode. A diagonal line indicates the transition between modes. An example shows T_a rising from below T_{sc} to above +1.5, labeled '(COOL OFF)' and '(COOL ON)'.</p> </div> <p data-bbox="464 1400 1082 1456">1) Judge the selection of COOL/HEAT mode as shown in the figure above.</p> <p data-bbox="464 1478 1082 1585">When 10 minutes passed after thermostat had been turned off, the heating operation (Thermo OFF) is exchanged to cooling operation if T_{sh} exceeds +1.5 or more.</p> <p data-bbox="464 1612 1082 1668">(COOL OFF) and (COOL ON) in the figure indicate an example.</p> <p data-bbox="464 1695 1082 1803">When 10 minutes passed after thermostat had been turned off, the cooling operation (Thermo OFF) is exchanged to heating operation if T_{sc} exceeds -1.5 or less.</p> <p data-bbox="464 1830 1082 1886">2) For the automatic capacity control after judgment of COOL/HEAT, refer to item 4.</p> <p data-bbox="464 1886 1082 1942">3) For the temperature correction of room temperature control in automatic heating operation, refer to item 3.</p>	Remote controller command	Outline of control	STOP	Air conditioner stops.	FAN	Fan operation	COOL	Cooling operation	DRY	Dry operation	HEAT	Heating operation	<p>T_a : Room temperature T_s : Setup temperature T_{sc} : Setup temperature in cooling operation T_{sh} : Setup temperature + Room temperature control temperature compensation</p>
Remote controller command	Outline of control														
STOP	Air conditioner stops.														
FAN	Fan operation														
COOL	Cooling operation														
DRY	Dry operation														
HEAT	Heating operation														

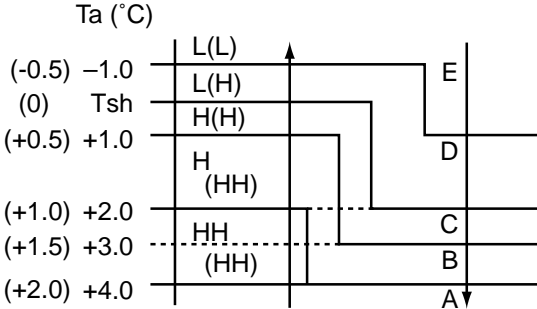
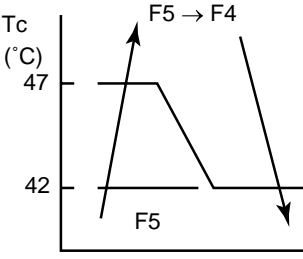
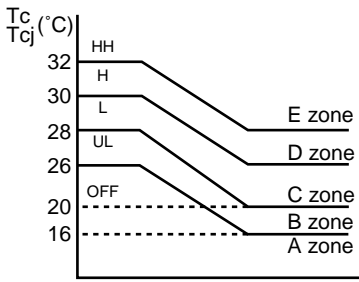
No.	Item	Outline of specifications	Remarks																								
3	Room temperature control	<p>1) Adjustment range Remote controller setup temperature (°C)</p> <table border="1" data-bbox="475 286 1082 443"> <thead> <tr> <th></th> <th>COOL/ DRY</th> <th>Heating operation</th> <th>Auto operation</th> </tr> </thead> <tbody> <tr> <td>Wired type</td> <td>18 to 29</td> <td>18 to 29</td> <td>18 to 29</td> </tr> <tr> <td>Wireless type*</td> <td>18 to 30</td> <td>16 to 30</td> <td>17 to 27</td> </tr> </tbody> </table> <p>* : Only for 4-way air discharge cassette type and Under ceiling type</p> <p>2) Using the item code 06, the setup temperature in heating operation can be compensated.</p> <table border="1" data-bbox="475 600 1082 719"> <tbody> <tr> <td>Setup data</td> <td>0</td> <td>2</td> <td>4</td> <td>6</td> </tr> <tr> <td>Setup temp. compensation</td> <td>+0°C</td> <td>+2°C</td> <td>+4°C</td> <td>+6°C</td> </tr> </tbody> </table> <p>Setting at shipment</p> <table border="1" data-bbox="475 770 764 815"> <tbody> <tr> <td>Setup data</td> <td>2</td> </tr> </tbody> </table>		COOL/ DRY	Heating operation	Auto operation	Wired type	18 to 29	18 to 29	18 to 29	Wireless type*	18 to 30	16 to 30	17 to 27	Setup data	0	2	4	6	Setup temp. compensation	+0°C	+2°C	+4°C	+6°C	Setup data	2	Shift of suction temperature in heating operation
	COOL/ DRY	Heating operation	Auto operation																								
Wired type	18 to 29	18 to 29	18 to 29																								
Wireless type*	18 to 30	16 to 30	17 to 27																								
Setup data	0	2	4	6																							
Setup temp. compensation	+0°C	+2°C	+4°C	+6°C																							
Setup data	2																										
4	Automatic capacity control (GA control)	1) Based on the difference between Ta and Ts, the operation frequency is instructed to the outdoor unit.																									
5	Air speed selection	<p>1) Operation with (HH), (H), (L), or [AUTO] mode is performed by the command from the remote controller.</p> <p>2) When the air speed mode [AUTO] is selected, the air speed varies by the difference between Ta and Ts.</p> <p><COOL></p>  <p>• Controlling operation in case when thermo of remote controller works is same as a case when thermo of the body works.</p> <p>• If the air speed has been changed once, it is not changed for 3 minutes. However when the air volume is exchanged, the air speed changes.</p> <p>• When cooling operation has started, the air speed selects a downward slope, that is, the high position.</p> <p>• If the temperature is just on the difference boundary, the air speed does not change.</p> <p>• Mode in the parentheses indicates one in automatic cooling operation.</p>	HH > H > L > LL																								

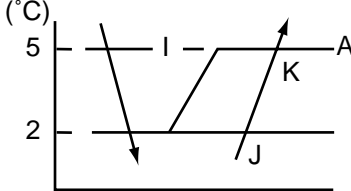
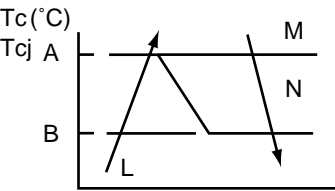
No.	Item	Outline of specifications	Remarks
5	Air speed selection (Continued)	<p><HEAT></p>  <p>Value in the parentheses indicates one when thermostat of the remote controller works. Value without parentheses indicates one when thermostat of the body works.</p> <ul style="list-style-type: none"> • If the air speed has been changed once, it is not changed for 1 minute. However when the air speed is exchanged, the air speed changes. • When heating operation has started, the air speed selects a upward slope, that is, the high position. • If the temperature is just on the difference boundary, the air speed does not change. • Mode in the parentheses indicates one in automatic heating operation. • In $T_c \geq 60^\circ\text{C}$, the air speed increases by 1 step. • In heating operation, the mode changes to [LL] if thermostat is turned off. • If $T_a \geq 25^\circ\text{C}$ when heating operation has started and when defrost operation has been cleared, it operates with HIGH (H) mode or (HH) for 1 minute from when T_c has entered in E zone of cool air discharge preventive control (Item 6). • In automatic cooling/heating operation, the revolution frequency of [HH] is set larger than that in the standard cooling/heating operation. However the revolution frequency is restricted in the automatic heating operation as shown in the following figure. 	<p>T_c: Indoor heat exchanger sensor temperature</p> <p>[PRE-HEAT] display</p> 
6	Cool air discharge preventive control	<p>1) In heating operation, the indoor fan is controlled based on the detected temperature of T_c sensor or T_{cj} sensor. As shown below, the upper limit of the revolution frequency is determined.</p> 	

No.	Item	Outline of specifications	Remarks						
7	Freeze preventive control (Low temperature release)	<p>1) The cooling operation (including Dry operation) is performed as follows based on the detected temperature of Tc sensor or Tcj sensor.</p> <p>When [J] zone is detected for 6 minutes (Following figure), the commanded frequency is decreased from the real operation frequency. After then the commanded frequency changes every 30 seconds while operation is performed in [J] zone.</p> <p>In [K] zone, time counting is interrupted and the operation is held.</p> <p>When [I] zone is detected, the timer is cleared and the operation returns to the normal operation.</p> <p>If the commanded frequency becomes S0 because the operation continues in [J] zone, the return temperature A is raised from 5°C to 12°C until [I] zone is detected and the indoor fan operates with [M] mode.</p>  <p>In heating operation, the freeze-preventive control works if 4-way valve is not exchanged and the condition is satisfied. (However the temperature for J zone dashing control is changed from 2°C to -5°C.)</p>	Tcj : Indoor heat exchanger sensor temperature						
8	High-temp release control	<p>1) The heating operation is performed as follows based on the detected temperature of Tc sensor or Tcj sensor.</p> <ul style="list-style-type: none"> • When [M] zone is detected, the commanded frequency is decreased from the real operation frequency. After then the commanded frequency changes every 30 seconds while operation is performed in [M] zone. • In [N] zone, the commanded frequency is held. • When [L] zone is detected, the commanded frequency is returned to the original value by approx. 6Hz every 60 seconds. <p>Setup at shipment</p> <table border="1" data-bbox="438 1657 662 1780"> <thead> <tr> <th colspan="2">Control temp (°C)</th> </tr> </thead> <tbody> <tr> <td>A</td> <td>B</td> </tr> <tr> <td>56 (54)</td> <td>52 (52)</td> </tr> </tbody> </table>  <p>NOTE : When the operation has started or when Tc or Tcj became lower than 30°C after start of the operation, temperature is controlled between values in parentheses of A and B.</p>	Control temp (°C)		A	B	56 (54)	52 (52)	Same when thermostat is turned off.
Control temp (°C)									
A	B								
56 (54)	52 (52)								

No.	Item	Outline of specifications	Remarks
9	Drain pump control	1) In cooling operation (including Dry operation), the drain pump is usually operated. 2) If the float switch operates while drain pump operates, the compressor stops, the drain pump continues the operation, and a check code is output. 3) If the float switch operates while drain pump stops, the compressor stops and the drain pump operates. If the float switch keeps operating for approx. 4 minutes, a check code is output.	Check code [P10]
10	After-heat elimination	When heating operation stops, the indoor fan operates with LOW mode for approx. 30 seconds.	
11	Louver control (For 4-way air discharge cassette type only)	1) Louver position setup <ul style="list-style-type: none"> • When the louver position is changed, the position moves necessarily to downward discharge position once to return to the set position. • The louver position can be set up in the following operation range. <p>In cooling/dry operation In heating/fan operation</p> <div style="display: flex; justify-content: space-around; align-items: center;">   </div> <ul style="list-style-type: none"> • In group twin/triple operation, the louver positions can be set up collectively or individually. 2) Swing setup <ul style="list-style-type: none"> • The swinging position can be moved in the following operation range. <p>All modes</p> <div style="text-align: center;">  </div> <ul style="list-style-type: none"> • In group twin/triple operation, the swinging positions can be set up collectively or individually. 3) When the unit stops or when a warning is output, the louver automatically moves downward. 4) While the heating operation is ready, the louver automatically moves upward.	<p>Warning : A check code is displayed on the remote controller, and the indoor unit stops. (Excluding [F08] and [L31])</p>

No.	Item	Outline of specifications	Remarks
12	Frequency fixed operation (Test run)	<p><In case of wired remote controller></p> <ol style="list-style-type: none"> 1. When pushing [CHECK] button for 4 seconds or more, [TEST] is displayed on the display screen and the mode enters in Test run mode. 2. Push [ON/OFF] button. 3. Using [MODE] button, change the mode from [COOL] to [HEAT]. <ul style="list-style-type: none"> • Do not use other mode than [COOL]/[HEAT] mode. • During test run operation, the temperature cannot be adjusted. • An error is detected as usual. • A frequency fixed operation is performed. 4. After the test run, push [ON/OFF] button to stop the operation. (Display in the display part is same as the procedure in item 1).) 5. Push [CHECK] button to clear the test run mode. ([TEST] display in the display part disappears and the status returns to the normal stop status.) <p><In case of wireless remote controller> (Option for 4-way air discharge cassette type only)</p> <ol style="list-style-type: none"> 1. Turn off the power of the set. Remove the adjuster with sensors from the ceiling panel. 2. Turn Bit [1: TEST] of sensor P.C. board switch [S003] from OFF to ON. Attach the sensor P.C. board cover and mount the adjuster with sensors to the ceiling panel. Turn on the power of the set. 3. Push [ON/OFF] button of the wireless remote controller and set the operation mode to [COOL] or [HEAT] using [MODE] button. (During test run operation, all the display lamps of wireless remote controller sensors flash.) <ul style="list-style-type: none"> • Do not use other mode than [COOL]/[HEAT] mode. • An error is detected as usual. • A frequency fixed operation is performed. 4. After the test run, push [ON/OFF] button to stop the operation. 5. Turn off the power of the set. Turn Bit [1: TEST] of sensor P.C. board switch [S003] from ON to OFF. Mount the adjuster with sensors to the ceiling panel. 	
13	Filter sign display (Except wireless type)	<ol style="list-style-type: none"> 1) The operation time of the indoor fan is calculated, the filter reset signal is sent to the remote controller when the specified time (2500H) has passed, and it is displayed on LCD. 2) When the filter reset signal has been received from the remote controller, time of the calculation timer is cleared. In this case, the measurement time is reset if the specified time has passed, and display on LCD disappears. 	[FILTER] goes on.

No.	Item	Outline of specifications	Remarks
14	Central control mode selection	<p>1) Setting at the central controller side enables to select the contents which can be operated on the remote controller at indoor unit side.</p> <p>2) RBC-AMT31E [Last push priority] : The operation contents can be selected from both remote controller and central controller of the indoor unit side, and the operation is performed with the contents selected at the last. [Center] : Start/Stop operation only can be handled on the remote controller at indoor unit side. [Operation Prohibited] : It cannot be operated on the remote controller at indoor unit side. (Stop status is held.)</p>	<p>(No display)</p> <p>[CENTER] goes on.</p> <p>[CENTER] goes on. In a case of wireless type, the display lamp does not change. However, contents which can be operated are same. The status set in [CENTER]/ [Operation Prohibited] mode is notified with the receiving sound "Pi, Pi, Pi, Pi, Pi" (5 times).</p>
15	Energy-save control (By connected outdoor unit)	<p>1) Selecting [AUTO] mode enables an energy-saving to be operated.</p> <p>2) The setup temperature is shifted (corrected) in the range not to lose the comfort ability according to input values of various sensors.</p> <p>3) Data (Input value room temp. Ta, Outside temp. To, Air volume, Indoor heat exchanger sensor temp. Tc) for 20 minutes are taken the average to calculate correction value of the setup temperature.</p> <p>4) The setup temperature is shifted every 20 minutes, and the shifted range is as follows. In cooling time : +1.5 to -1.0K In heating time : -1.5 to +1.0K</p>	
16	Louver control 1) Louver position	<p>The louver angle is displayed setting 0° as "Full close".</p> <p>1) In the initial operation after power-ON, the position is automatically controlled according to the operating status (COOL/HEAT).</p> <p>2) After then a louver position is stored in the microcomputer every time when position is operated on the remote controller, and the louver operates at the position stored in memory in the next operation and after. * If the operation mode has been changed from COOL to HEAT, from HEAT to COOL, or the power has turned off, the stored louver position is cleared and the status returns to one in item 1).</p>	<p>The diagram illustrates three louver positions: "Full close" at 0°, "Cooling" at 45°, and "Heating" at 103°. Each position is shown with a side-view illustration of the louver blades and a corresponding numerical angle below it.</p>
	2) Air direction adjustment (Swing operation)	<p>1) When pushing [LOUVER] button during operation, the louver starts swinging.</p> <p>2) When the louver has arrived at the desired position, push [LOUVER] again. The louver stops at that position.</p>	

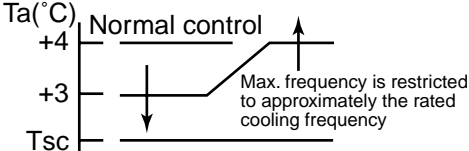
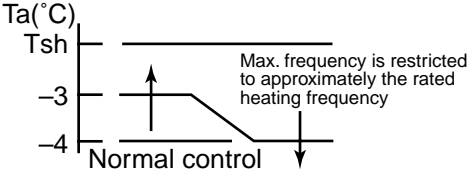
No.	Item	Outline of specifications	Remarks
17	Max. frequency cut control	<p>1) This control is operated by selecting [AUTO] operation mode.</p> <p>2) COOL operation mode: the frequency is controlled according to the following figure if $T_o < 28^\circ\text{C}$.</p>  <p>3) HEAT operation mode: the frequency is controlled according to the following figure if $T_o > 15^\circ\text{C}$. It cannot be operated on the remote controller at indoor unit side. (Stop status is held.)</p> 	
18	DC motor	<p>1) When the fan operation has started, positioning of the stator and the rotor are performed. (Moves slightly with tap sound)</p> <p>2) The motor operates according to the command from the indoor controller.</p> <p>NOTES :</p> <ul style="list-style-type: none"> • When the fan rotates while the air conditioner stops due to entering of outside air, etc, the air conditioner may operated while the fan motor stops. • When a fan locking is found, the air conditioner stops, and an error is displayed. 	Check code [P12]

8-3. Indoor Print Circuit Board

8-3-1. 4-W ay Air Discharge Cassette Type / Concealed Duct Type / Under Ceiling Type
 <MCC-1402>

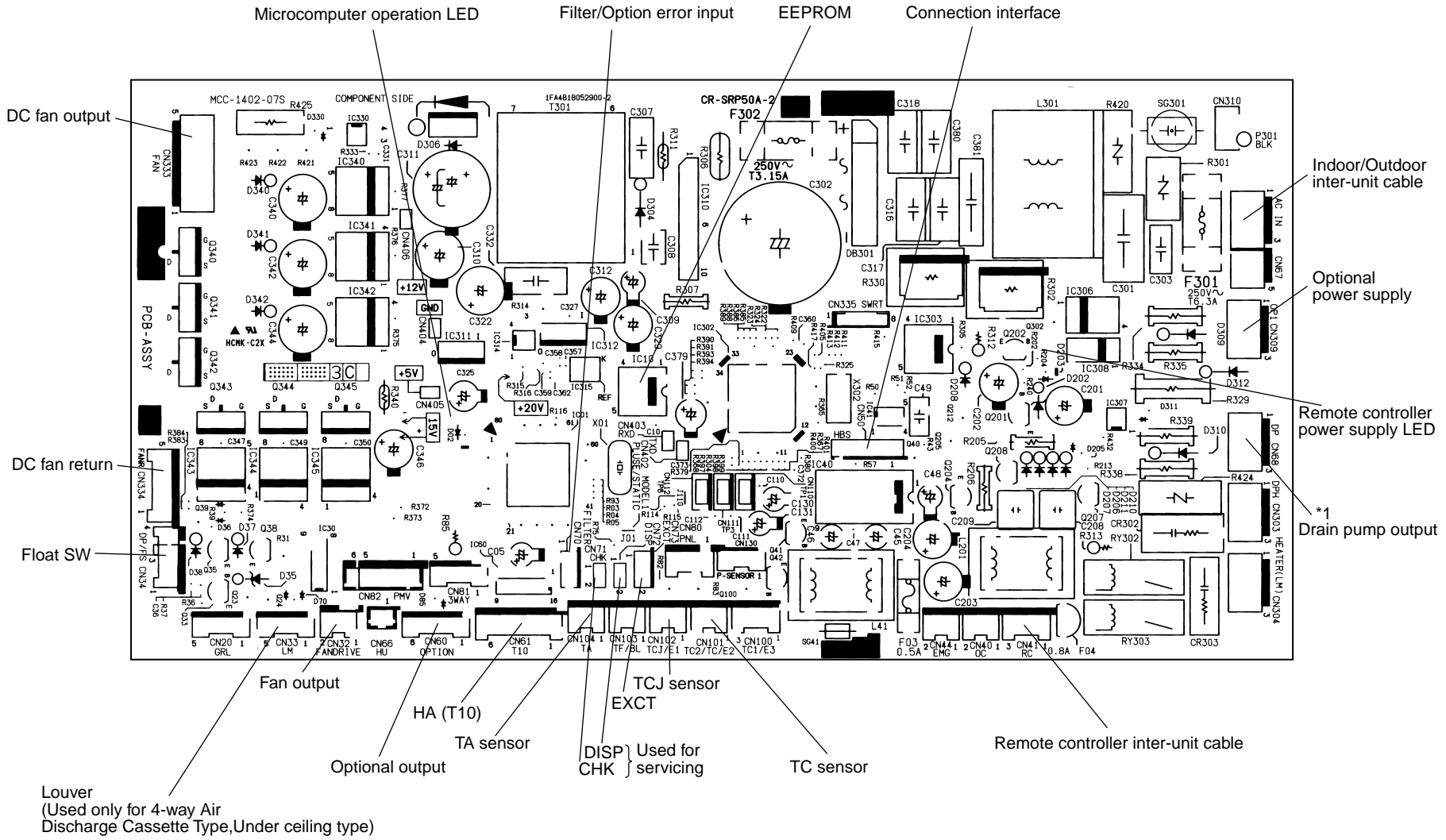

9. CIRCUIT CONFIGURATION AND CONTROL SPECIFICATIONS

9-1. Indoor Control Circuit

9-1-1. Indoor P.C. Board Optional Connector Specifications

Function	Connector No.	Pin No.	Specifications	Remarks
Option output	CN60	1	DC12V (COM)	
		2	Defrost output	ON during defrost operation of outdoor unit
		3	Thermo. ON output	ON during Real thermo-ON (Comp ON)
		4	Cooling output	ON when operation mode is in cooling system (COOL, DRY, COOL in AUTO cooling/heating)
		5	Heating output	ON when operation mode is in heating system (HEAT, HEAT in AUTO cooling/heating)
		6	Fan output	ON during indoor fan ON (Air purifier is used/Interlock cable)
Outside error input	CN80	1	DC12V (COM)	(When continued for 1 minute) Check code "L30" is output and forced operation stops.
		2	DC12V (COM)	
		3	Outside error input	
Filter option error	CN70	1	Filter/Option/Humidifier setup input	Option error input is controlled. (Protective operation for device attached to outside is displayed.)
		2	0V	* Setting of option error input is performed from remote controller. (DN=2A)
CHK Operation check	CN71	1	Check mode input	Used for operation check of indoor unit. (Communication with outdoor unit or remote controller is not performed, but the specified operation such as indoor fan "H" or drain pump ON is output.)
		2	0V	
DISP display mode	CN72	1	Display mode input	Display mode enables indoor unit and remote controller to communicate. (When power is turned on)
		2	0V	
EXCT demand	CN73	1	Demand input	
		2	0V	Forced thermo-OFF operation in indoor unit

9-2. Outdoor Controls

9-2-1. Print Circuit Board

P.C. Board Comparison Table for Digital Inverter

P.C. board		Part No.	Model name RAV -SM		Model name RAV -SP	
			563AT-E/803AT-E	1103AT-E/1403AT-E	562AT-E/802AT-E	1102AT-E/1402AT-E
Main	MCC-5009	4316V284	1			
Sub	MCC-1530	4316V293	1			
CDB	MCC-1531	4316V283		1		
		4316V282			1	1
IPDU	MCC-1438	4316V291		1		1
		4316V278			1	

1: Applied

<V lewed from parts of P.C boards>
 RAV -SM563AT-E, RAV -SM803AT-E
 <MCC-5009>

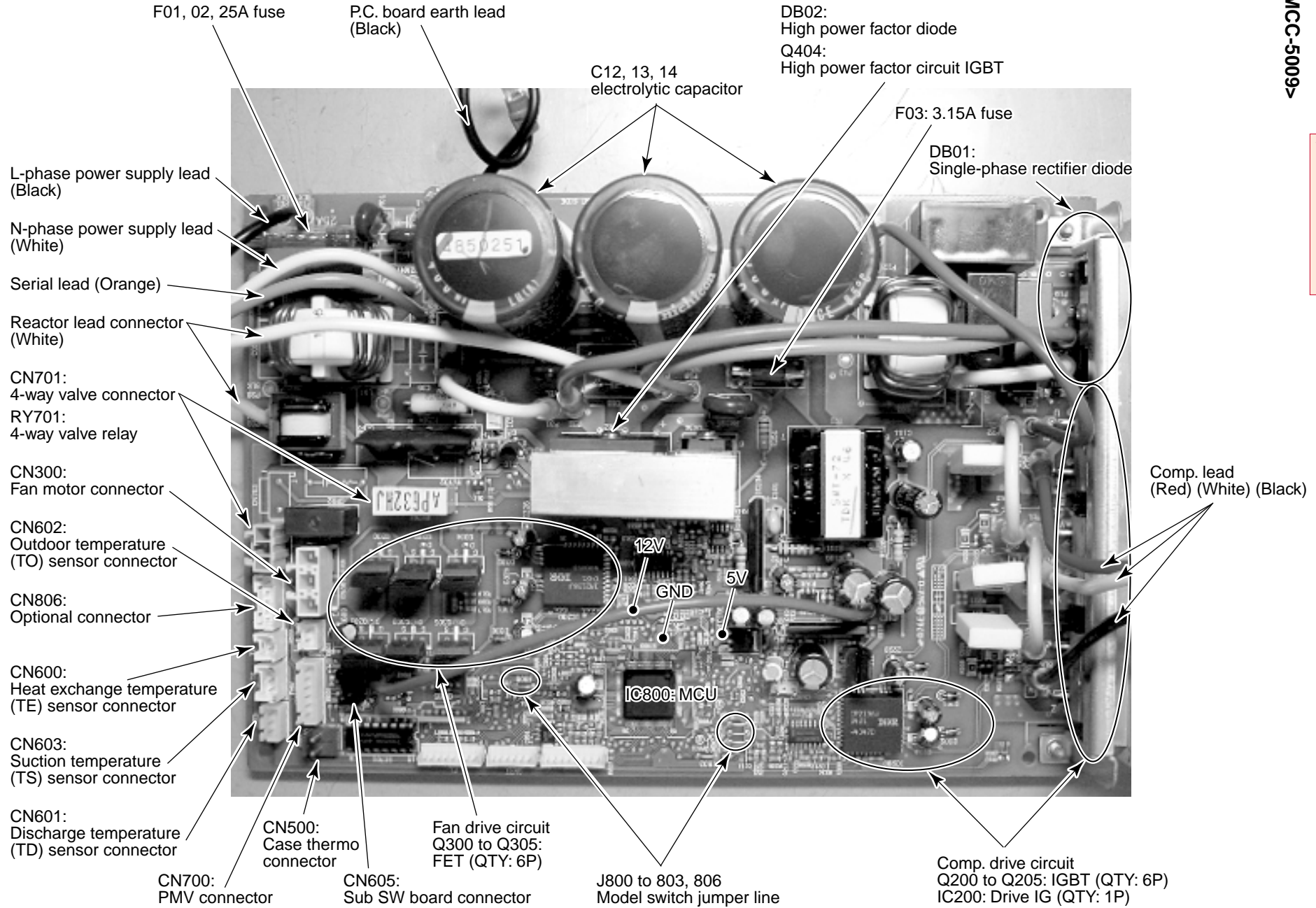

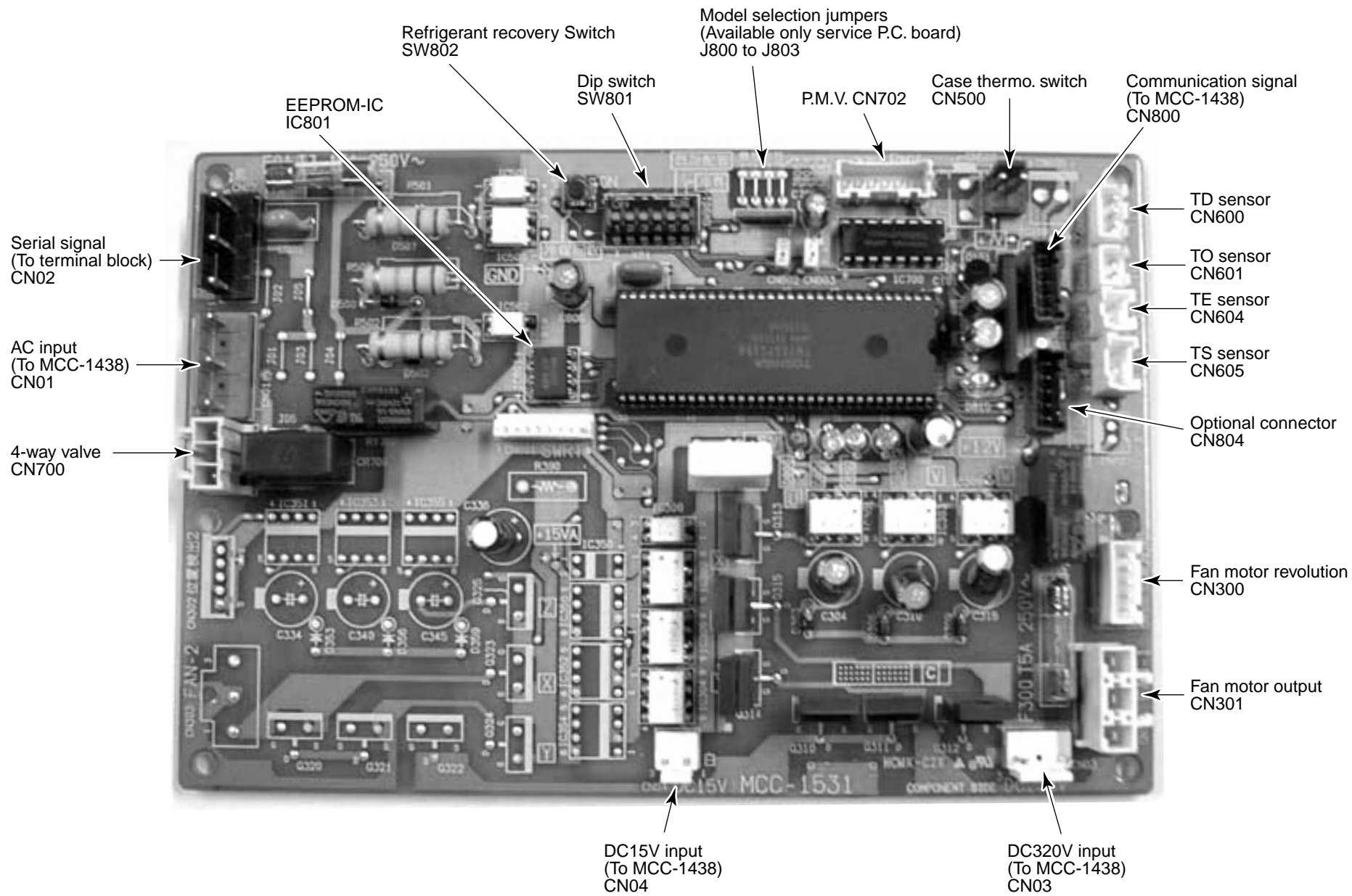

RAV -SP1102AT-E, RAV -SP1402AT-E
 <MCC-1531>

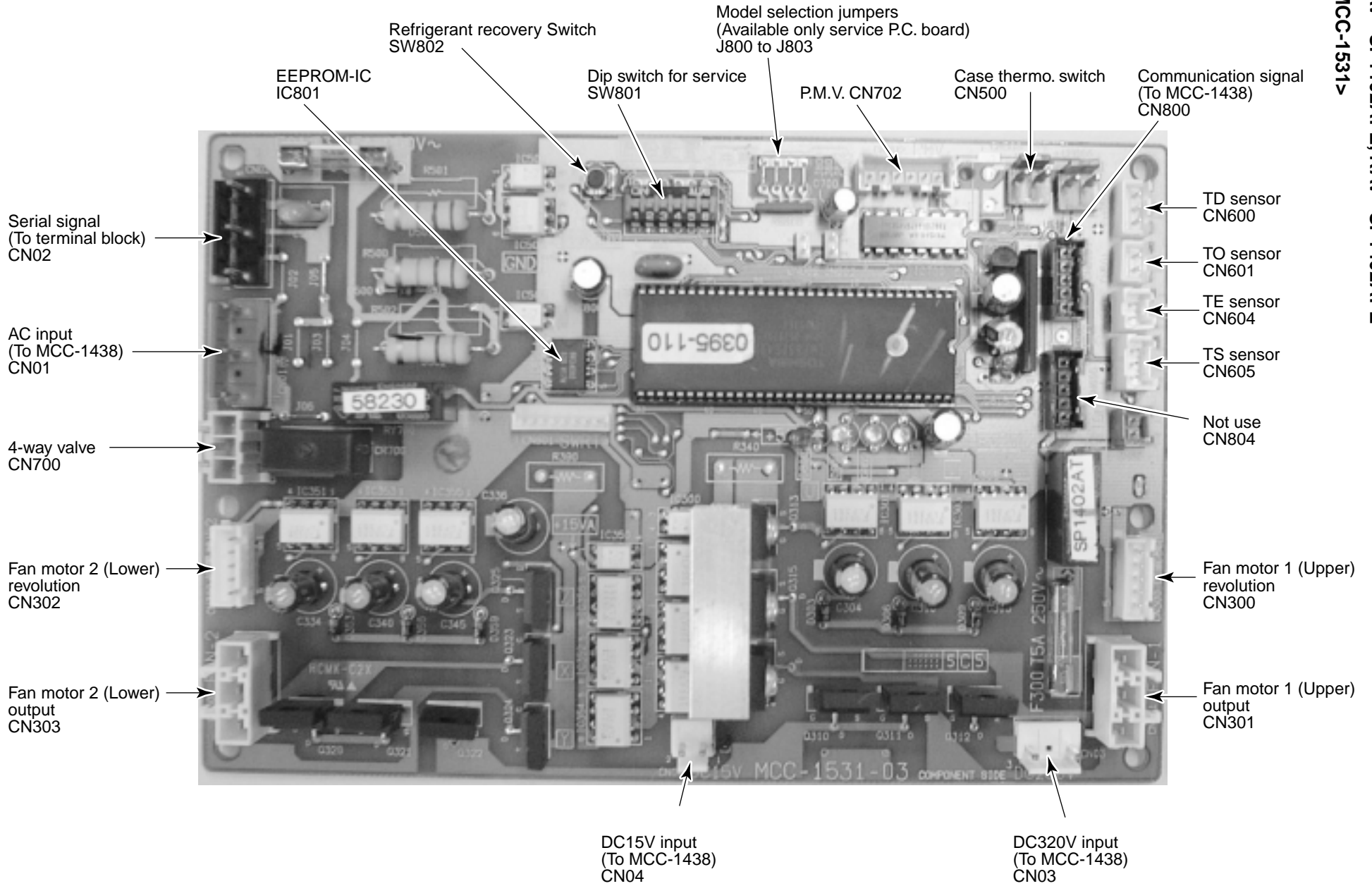

RAV -SM1103AT-E, RAV -SM1403AT-E /
 RAV -SP562AT-E, RAV -SP802AT-E, RAV -SP1102AT-E, RAV -SP1402AT-E
 <IPDU : MCC-1438>

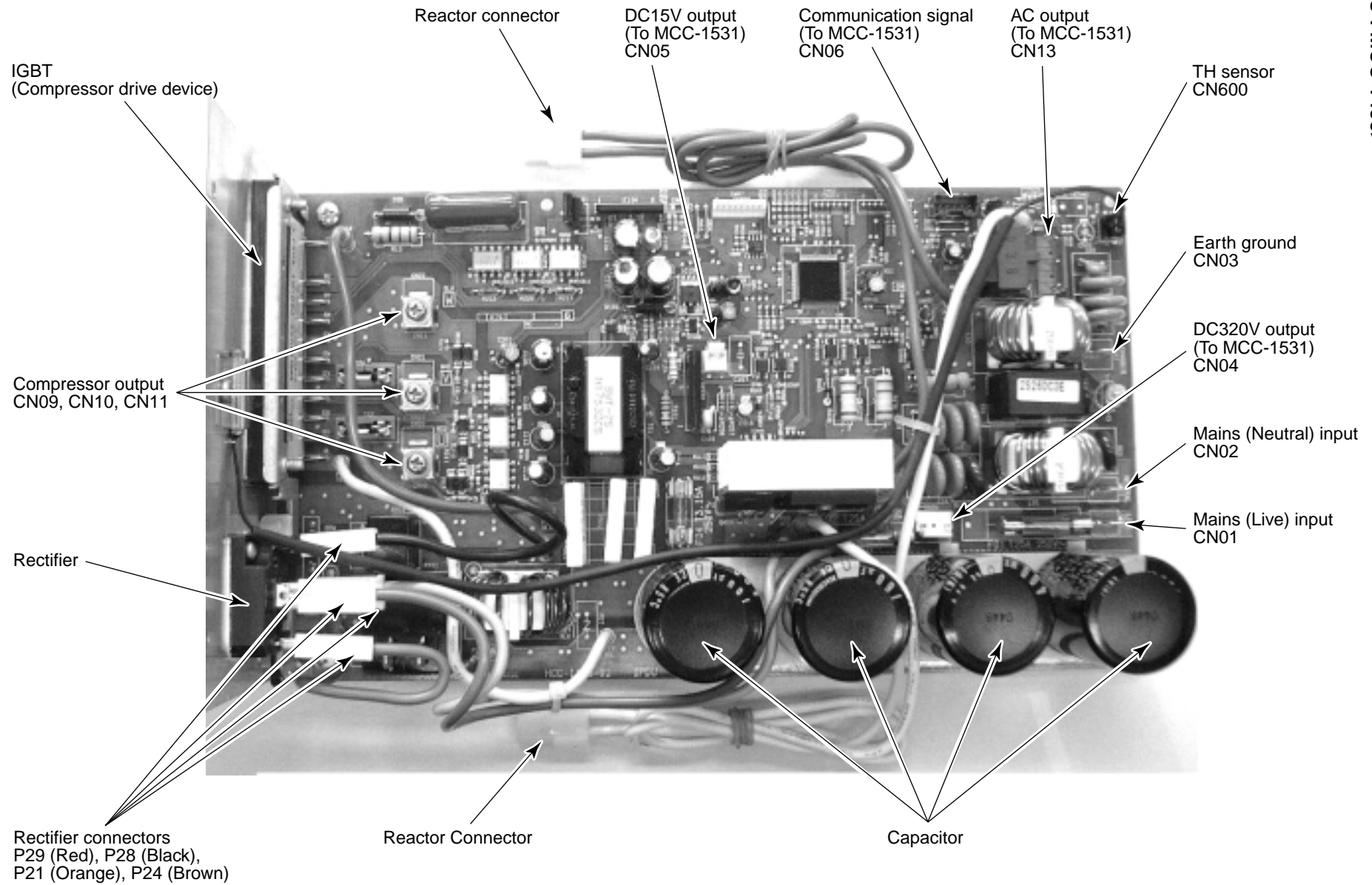

9-2-2. Outline of Main Controls

1. Pulse Modulating V valve (PMV) control

- 1) For PMV with 50 to 500 pulses during operation, respectively.
- 2) In cooling operation, PMV is controlled with the temperature difference between TS sensor and TC sensor.
- 3) In heating operation, PMV is controlled with the temperature difference between TS sensor and TE sensor.
- 4) For the temperature difference in items 2) and 3), 1 to 5K is aimed as the target in both cooling and heating operations.
- 5) When the cycle excessively rose in both cooling and heating operations, PMV is controlled by TD sensor.
The aimed value is usually 103°C for SM56, SM80 and 100°C for SM110, SM140 in both cooling and heating operations.

REQUIREMENT

A sensor trouble may cause a liquid back-flow or abnormal overheat resulting in excessive shortening of the compressor life. In a case of trouble on the compressor, be sure to check there is no error in the resistance value an the refrigerating cycle of each sensor after repair and then start the operation.

2. Discharge temperature release control

- 1) This function controls the operation frequency, that is, lowers the operation frequency when the discharge temperature has not lower or the discharge temperature has rapidly risen during PMV control. It subdivides the frequency control up to a unit of 0.6 Hz to stabilize the cycle.
- 2) When the discharge temperature is detected in an abnormal stop zone, the unit stops the compressor and restarts after 2 minutes 30 seconds. The error counter is cleared when it has continued the operation for 10 minutes.
If the abnormal stop zone has been detected by 4 times without clearing of counter, an error "P03" is displayed.
* The cause is considered as excessively little amount of refrigerant, defective PMV, or clogging of cycle.

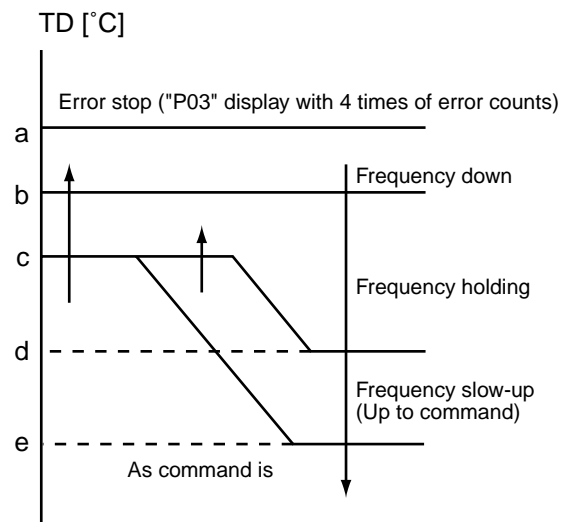

[°C]

	a	b	c	d	e
SM56, SM80	117	107	103	100	93
SM110, SM140	111	106	100	95	90

3. Current release control

The output frequency and the output voltage are controlled by AC current value detected by T02 on the outdoor P.C. board so that input current of the inverter does not exceed the specified value.

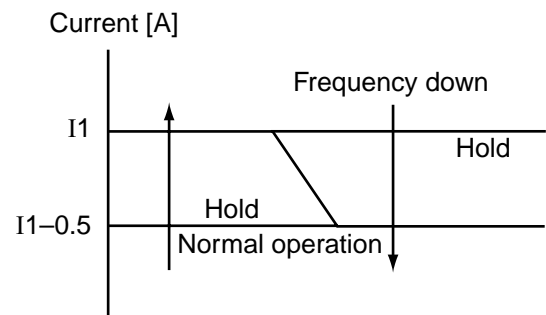

Objective model	SM56		SM80		SM110		SM140	
	COOL	HEAT	COOL	HEAT	COOL	HEAT	COOL	HEAT
I1 value [A]	10.1	12.0	12.2	14.0	18.9	19.7	19.7	19.7

4. Outdoor fan control

Allocations of fan tap revolutions [rpm]

	W 1	W 2	W 3	W 4	W 5	W 6	W 7	W 8	W 9	W A	W B	W C	W D		
SM56	200	300	350	410	480	500	530	560	640	670	700	750	800	840	840
SM80	200	300	350	410	480	500	530	560	640	670	700	750	840	940	980
SM110	250	280	320	360	410	460	520	580	640	700	760	860	860	900	930
SM140	250	280	320	360	410	460	520	580	640	700	760	860	860	900	970

1) Cooling fan control

- ① The outdoor fan is controlled by TE, TD, and TO sensors and also revolution frequency of the operation. The outdoor is controlled by every 1 tap of DC fan control (15 taps).
- ② Only during 60 seconds after the operation has started, the fan is fixed with the maximum fan tap which corresponds to the zone in the following table. After then the fan is controlled by TE sensor temperature.
- ③ Considering a case that TE sensor has come out of the holder, the fan is controlled so that revolution frequency of the fan increases regardless of TE if temperature of TD sensor has risen.

	a	b
SM56, SM80	36	32
SM110, SM110	29	26

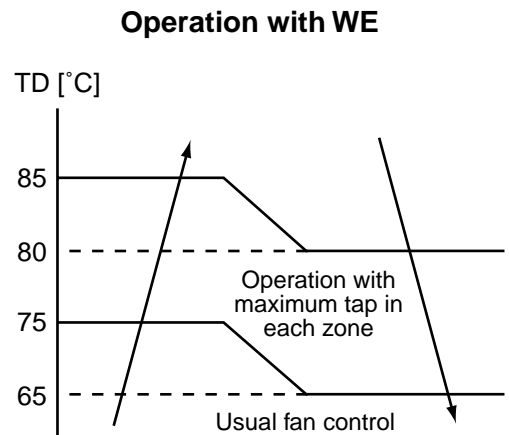
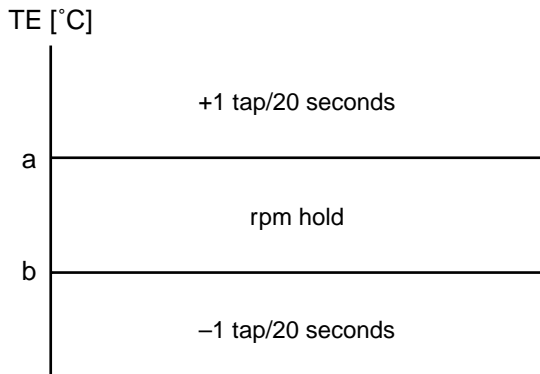

(The operation frequency differs according to the model type.)

Temp. range	Below 30Hz		Above 30 Hz below 45 Hz		Above 45 Hz	
	Min.	Max.	Min.	Max.	Min.	Max.
29°C ≤ TO	W5	WA	W7	WC	W9	WF
15 ≤ TO < 29°C	W3	W7	W5	W9	W7	WB
5 ≤ TO < 15°C	W2	W5	W4	W7	W6	W9
0 ≤ TO < 5°C	W1	W3	W3	W5	W4	W7
TO < 0°C	W1	W2	W2	W4	W3	W5
TO error	W1	WF	W1	WF	W1	WF

2) Heating fan control

- ① The outdoor fan is controlled by TE sensor, TO sensor and the operation frequency.
(From Min. W1 to Max. are controlled according to the following table.)
- ② During 3 minutes after start-up, the fan is fixed with the maximum fan tap corresponding to zone in the following table. After then the fan is controlled by temperature of TE sensor.
- ③ If status, $TE \geq 24^{\circ}\text{C}$ continues for 5 minutes, the operation stops. This status is same to the usual Thermo-OFF which has no alarm display, and the fan restarts after 2 minutes and 30 seconds. This intermittent operation is not abnormal.
- ④ When the above status ② occurs frequently, it is considered that the filter of suction part of the indoor unit is stain. Clean the filter and then restart the operation.

TE [$^{\circ}\text{C}$]	
24	-2 tap/20 seconds STOP timer count
21	-2 tap/20 seconds
18	-1 tap/20 seconds
15	rpm hold
	+1 tap/20 seconds

(The operation frequency differs according to the model type. The case of SM110 is shown in the table below.)

	Temp. range	Below 33 Hz	Above 33 Hz below 51 Hz	Above 51 Hz
Maximum	$10^{\circ}\text{C} \leq \text{TO}$	W7	W8	W9
	$5 \leq \text{TO} < 10^{\circ}\text{C}$	WA	WB	WF
	$\text{TO} < 5^{\circ}\text{C}$	WF	WF	WF
	TO error	WF	WF	WF

5. Coil heating control

- 1) This control function heats the compressor by turning on the stopped compressor instead of a case heater. It purposes to prevent slackness of the refrigerant inside of the compressor.
- 2) As usual, turn on power of the compressor for the specified time before a test run after installation, otherwise a trouble of the compressor may be caused. As same as a test run, it is recommended to turn on power of the compressor beforehand when starting operation after power of the compressor has been interrupted for a long time.
- 3) A judgment for electricity is performed by TD and TO sensors. If TO sensor is defective, a backup control is automatically performed by TE sensor. For a case of defective TO sensor, judge it with the outdoor LED display.
- 4) Coil heating is controlled by TD and TE sensor.
- 5) For every model, the power is turned off when TD is 30°C or more.

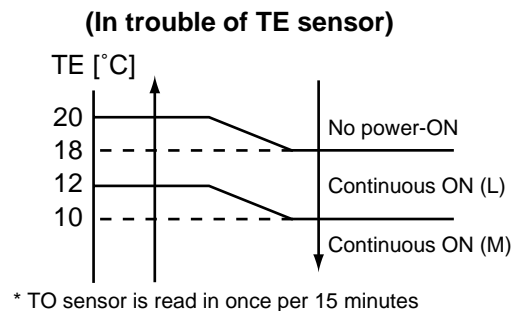
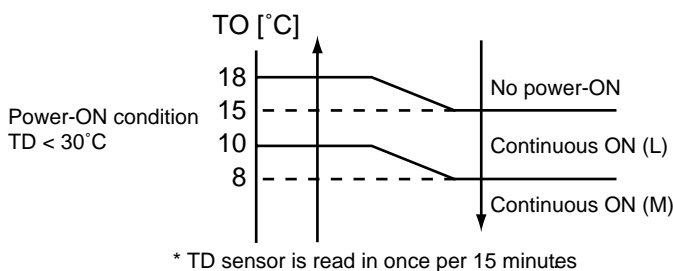

(Object: SM56, SM80)

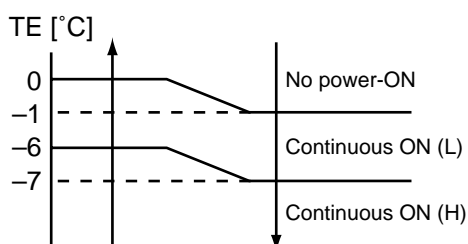

	SM110, SM140
L	20W and equivalent
M	40W and equivalent

	SM56, SM80
L	10W and equivalent
H	30W and equivalent

6. Defrost control

- ① In heating operation, defrost operation is performed when TE sensor temperature satisfies any condition in A zone to D zone.
- ② The defrost operation is immediately finished if TE sensor temperature has become 12°C or more, or it also is finished when condition of $7^{\circ}\text{C} \leq \text{TE} < 12^{\circ}\text{C}$ has continued for 1 minute. The defrost operation is also finished when defrost operation has continued for 10 minutes even if TE sensor temperature has become 7°C or lower.
- ③ After defrost operation has finished, the compressor and the outdoor fan start heating operation after stopped for approx. 50 seconds.

Start of heating operation

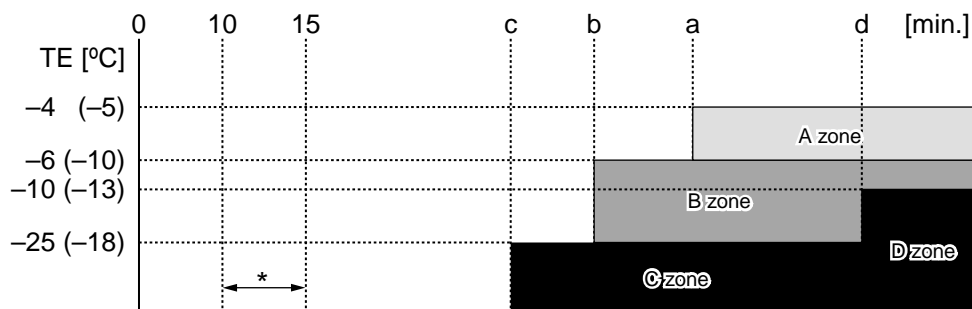

Numerals enclosed with parentheses represent numeral values of SM110 and SM140.

* The minimum TE value between 10 and 15 minutes after heating operation has started is stored in memory as TE0.

A zone	Defrost operation is performed in this zone when $\text{TE0} - \text{TE} \geq 3$ continued for T seconds.
B zone	Defrost operation is performed in this zone when $\text{TE0} - \text{TE} \geq 3$ continued for T seconds.
C zone	Defrost operation is performed when this zone continued for T seconds.
D zone	Defrost operation is performed when this zone continued for T seconds.

	SM56, SM80	SM110, SM140
a	35	50
b	29	35
c	29	30
d	90	90
T	20	20

10. TROUBLESHOOTING

10-1. Summary of Troubleshooting

<Wired remote controller type>

1. Before troubleshooting

1) Required tools/instruments

- ⊕ and ⊖ screwdrivers, spanners, radio cutting pliers, nippers, push pins for reset switch
- Tester, thermometer, pressure gauge, etc.

2) Confirmation points before check

a) The following operations are normal.

1. Compressor does not operate.

- Is not 3-minutes delay (3 minutes after compressor OFF)?
- Does not thermostat turn off?
- Does not timer operate during fan operation?
- Is not outside high-temperature operation controlled in heating operation?

2. Indoor fan does not rotate.

- Does not cool air discharge preventive control work in heating operation?

3. Outdoor fan does not rotate or air volume changes.

- Does not high-temperature release operation control work in heating operation?
- Does not outside low-temperature operation control work in cooling operation?
- Is not defrost operation performed?

4. ON/OFF operation cannot be performed from remote controller.

- Is not the control operation performed from outside/remote side?
- Is not automatic address being set up?

(When the power is turned on at the first time or when indoor unit address setting is changed, the operation cannot be performed for maximum approx. 5 minutes after power-ON.)

b) Did you return the cabling to the initial positions?

c) Are connecting cables of indoor unit and remote controller correct?

2. Troubleshooting procedure

When a trouble occurred, check the parts along with the following procedure.



NOTE :

For cause of a trouble, power conditions or malfunction/erroneous diagnosis of microcomputer due to outer noise is considered except the items to be checked. If there is any noise source, change the cables of the remote controller to shield cables.

<Wireless remote controller type> (For 4-way air discharge cassette type only models)

1. Before troubleshooting

- 1) Required tools/instruments
 - ⊕ and ⊖ screwdrivers, spanners, radio cutting pliers, nippers, etc.
 - Tester, thermometer, pressure gauge, etc.
- 2) Confirmation points before check
 - a) The following operations are normal.
 1. Compressor does not operate.
 - Is not 3-minutes delay (3 minutes after compressor OFF)?
 - Does not thermostat turn off?
 - Does not timer operate during fan operation?
 - Is not outside high-temperature operation controlled in heating operation?
 2. Indoor fan does not rotate.
 - Does not cool air discharge preventive control work in heating operation?
- 3) Outdoor fan does not rotate or air volume changes.
 - Does not high-temperature release operation control work in heating operation?
 - Does not outside low-temperature operation control work in cooling operation?
 - Is not defrost operation performed?
- 4) ON/OFF operation cannot be performed from remote controller.
 - Is not forced operation performed?
 - Is not the control operation performed from outside/remote side?
 - Is not automatic address being set up?
 - a) Did you return the cabling to the initial positions?
 - b) Are connecting cables between indoor unit and receiving unit correct?

2. Troubleshooting procedure

(When the power is turned on at the first time or when indoor unit address setting is changed, the operation cannot be performed for maximum approx. 5 minutes after power-ON.)

When a trouble occurred, check the parts along with the following procedure.

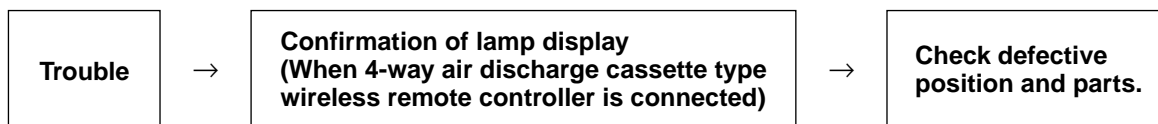

1) Outline of judgment

The primary judgment to check where a trouble occurred in indoor unit or outdoor unit is performed with the following method.

Method to judge the erroneous position by flashing indication on the display part of indoor unit (sensors of the receiving unit)

The indoor unit monitors operating status of the air conditioner, and the blocked contents of self-diagnosis are displayed restricted to the following cases if a protective circuit works.

10-2. Check Code List

Error mode detected by indoor and outdoor units

◎: Flash, ○: Go on, ●: Go off

Wireless sensor lamp display			Wired remote controller	Diagnostic function			Judgment and measures
Operation	Timer	Ready	Check code	Cause of operation	Status of air conditioner	Condition	
◎	●	●	E03	No communication from remote controller (including wireless) and communication adapters	Stop (Automatic reset)	Displayed when error is detected	1. Check cables of remote controller and communication adapters. • Handy remote controller LCD display OFF (Disconnection) • Central remote controller [97] check code
●	●	◎	E04	The serial signal is not output from outdoor unit to indoor unit. • Miscabling of inter-unit cables • Defective serial sensing circuit on outdoor P.C. board • Defective serial receiving circuit on indoor P.C. board	S top (Automatic reset)	Displayed when error is detected	1. Outdoor unit does not completely operate. • Inter-unit cable check, correction of miscabling, case thermo operation • Outdoor P.C. board check, P.C. board cables check 2. In normal operation P.C. board (Indoor receiving/Outdoor sending) check
◎	●	●	E08	Duplicated indoor unit addresses	Stop	Displayed when error is detected	1. Check whether there is modification of remote controller connection (Group/Individual) or not after power has been turned on (finish of group configuration/address check). * If group configuration and address are not normal when the power has been turned on, the mode automatically shifts to address setup mode. (Resetting of address)
◎	●	●	E10	Communication error between indoor MCU • Communication error between fan driving MCU and main MCU	Stop (Automatic reset)	Displayed when error is detected	1. Check cables of remote controller. 2. Check power cables of indoor unit. 3. Check indoor P.C. board.
◎	●	●	E18	Regular communication error between master and sub indoor units or between main and sub indoor units	Stop (Automatic reset)	Displayed when error is detected	1. Check cables of remote controller. 2. Check indoor power cable. 3. Check indoor P.C. board.
◎	◎	●	F01	Coming-off, disconnection or short of indoor heat exchanger sensor (TCJ)	Stop (Automatic reset)	Displayed when error is detected	1. Check indoor heat exchanger temperature sensor (TCJ). 2. Check indoor P.C. board.
◎	◎	●	F02	Coming-off, disconnection or short of indoor heat exchanger sensor (TC)	Stop (Automatic reset)	Displayed when error is detected	1. Check indoor heat exchanger temperature sensor (TC). 2. Check indoor P.C. board.
◎	◎	○	F04	Coming-off, disconnection or short of outdoor temperature sensor (TD)	Stop	Displayed when error is detected	1. Check outdoor temperature sensor (TD). 2. Check outdoor CDB P.C. board.
◎	◎	○	F06	Coming-off, disconnection or short of outdoor temperature sensor (TE/TS)	Stop	Displayed when error is detected	1. Check outdoor temperature sensor (TE/TS). 2. Check outdoor CDB P.C. board.
◎	◎	○	F08	Coming-off, disconnection or short of outdoor temperature sensor (TO)	Operation continues.	Displayed when error is detected	1. Check outdoor temperature sensor (TO). 2. Check outdoor CDB P.C. board.
◎	◎	●	F10	Coming-off, disconnection or short of indoor heat exchanger sensor (TA)	Stop (Automatic reset)	Displayed when error is detected	1. Check indoor heat exchanger temperature sensor (TA). 2. Check indoor P.C. board.
◎	◎	●	F29	Indoor EEPROM error • EEPROM access error	Stop (Automatic reset)	Displayed when error is detected	1. Check indoor EEPROM. (including socket insertion) 2. Check indoor P.C. board.
◎	●	●	H01	Breakdown of compressor • Displayed when error is detected	Stop	Displayed when error is detected	1. Check power voltage. AC230V ±20V 2. Overload operation of refrigerating cycle 3. Check current detection circuit at AC side.
●	◎	●	H02	Compressor does not rotate. • Over-current protective circuit operates after specified time passed when compressor had been activated.	Stop	Displayed when error is detected	1. Trouble of compressor (Compressor lock, etc.) : Replace compressor. 2. Defective cabling of compressor (Phase missing) 3. Phase-missing operation of power supply (3-phase model)
●	◎	●	H03	Current detection circuit error • Current value at AC side is high even during compressor-OFF. • Phase of power supply is missed.	Stop	Displayed when error is detected	1. Compressor immediately stops even if restarted. : Check IPDU. 2. Phase-missing operation of power supply Check 3-phase power voltage and cables.
◎	●	◎	L03	Duplicated indoor master units	Stop	Displayed when error is detected	1. Check whether there is modification of remote controller connection (Group/Individual) or not after power has been turned on (finish of group configuration/address check).
◎	●	◎	L07	There is group line in individual indoor units.	Stop	Displayed when error is detected	* If group configuration and address are not normal when the power has been turned on, the mode automatically shifts to address setup mode. (Resetting of address)
◎	●	◎	L08	Unsetting of indoor group address	Stop	Displayed when error is detected	

Wireless sensor lamp display			Wired remote controller	Diagnostic function			Judgment and measures
Operation	Timer	Ready	Check code	Cause of operation	Status of air conditioner	Condition	
◎	●	◎	L09	Unset indoor capacity	Stop	Displayed when error is detected	1. Set the indoor capacity. (DN=I1)
●	◎	●	L29	Outdoor unit and other errors • Communication error between CDB and IPDU (Coming-off of connector) • Heat sink temperature error (Detection of temperature over specified value)	Stop	Displayed when error is detected	1. Check cables of CDB and IPDU. 2. Abnormal overload operation of refrigerating cycle
◎	○	◎	L30	Abnormal outside interlock input	Stop	Displayed when error is detected	1. Check outside devices. 2. Check indoor P.C. board.
◎	○	◎	L31	Phase detection protective circuit operates. (Normal models)	Operation continues. (Compressor stops.)	Displayed when error is detected	1. Check power phase order (Reversed phase)/phase missing. 2. Check outdoor P.C. board.
No check code is displayed.				Fan motor thermal protection	Stop	Displayed when error is detected	1. Check thermal relay of fan motor. 2. Check indoor P.C. board.
◎	●	◎	P03	Discharge temperature error • Discharge temperature over specified value was detected.	Stop	Displayed when error is detected	1. Check refrigerating cycle. (Gas leak) 2. Trouble of PMV 3. Check Td sensor.
◎	●	◎	P04	High-pressure protection error by TE sensor (Temperature over specified value was detected.)	Stop	Displayed when error is detected	1. Overload operation of refrigerating cycle 2. Check outdoor temperature sensor (TE). 3. Check outdoor CDB P.C. board.
●	◎	◎	P10	Float switch operation • Disconnection, coming-off, defective float switch contactor of float circuit	Stop	Displayed when error is detected	1. Defect of drain pump 2. Clogging of drain pump 3. Check float switch. 4. Check indoor P.C. board.
●	◎	◎	P12	Indoor DC fan error	Stop	Displayed when error is detected	1. Defective detection of position 2. Over-current protective circuit of indoor fan driving unit operates. 3. Lock of indoor fan 4. Check indoor P.C. board.
◎	●	◎	P19	Error in 4-way valve system • Indoor heat exchanger temperature lowered after start of heating operation.	Stop (Automatic reset)	Displayed when error is detected	1. Check 4-way valve. 2. Check indoor heat exchanger (TC/TCJ) sensor. 3. Check indoor P.C. board.
◎	●	◎	P22	Outdoor DC fan error	Stop	Displayed when error is detected	1. Defective detection of position 2. Over-current protective circuit of outdoor fan driving unit operates. 3. Lock of outdoor fan 4. Check outdoor CDB P.C. board.
◎	●	◎	P26	Inverter over-current protective circuit operates. (For a short time) Short voltage of main circuit operates.	Stop	Displayed when error is detected	1. Inverter immediately stops even if restarted. : Compressor motor rare short 2. Check IPDU. : Cabling error
◎	●	◎	P29	IPDU position detection circuit error	Stop	Displayed when error is detected	1. Position detection circuit operates even if operating compressor by removing 3P connector. : Replace IPDU.
◎	●	◎	P31	Own unit stops while warning is output to other indoor units.	Stop (Sub unit) (Automatic reset)	Displayed when error is detected	1. Judge sub unit while master unit is in [E03], [L03], [L07], [L08]. 2. Check indoor P.C. board.

For an error mode detected in outdoor unit, the fan operates because sub unit of a group operation does not communicate with the outdoor unit.

Error mode detected by remote controller

◎: Flash, ○: Go on, ●: Go off

Wireless sensor lamp display			Wired remote controller	Diagnostic function			Judgment and measures
Operation	Timer	Ready	Check code	Cause of operation	Status of air conditioner	Condition	
—	—	—	No check code is displayed. (Remote controller does not operate.)	No communication with master indoor unit • Remote controller cable is not correctly connected. • Power of indoor unit is not turned on. • Automatic address cannot be completed.	Stop	—	Remote controller power error, Defective indoor EEPROM 1. Check remote controller inter-unit cables. 2. Check remote controller. 3. Check indoor power cables. 4. Check indoor P.C. board. 5. Check indoor EEPROM. (including socket insertion) : Phenomenon of automatic address repetition occurred.
◎	●	●	E01*2	No communication with indoor master unit • Disconnection of inter-unit cable between remote controller and master indoor unit (Detected at remote controller side)	Stop (Automatic restart) * When there is center, operation continues	Displayed when error is detected	Signal receiving of remote controller is defective. 1. Check remote controller inter-unit cables. 2. Check remote controller. 3. Check indoor power cables. 4. Check indoor P.C. board.
◎	●	●	E02	Signal sending error to indoor unit (Detected at remote controller side)	Stop (Automatic restart) * When there is center, operation continues.	Displayed when error is detected	Signal sending of remote controller is defective. 1. Check sending circuit inside of remote controller. : Replace remote controller.
◎	●	●	E09	Multiple master remote controllers are recognized. (Detected at remote controller side)	Stop (Sub unit continues operation.)	Displayed when error is detected	1. Check there are multiple master units for 2 remote controllers (including wireless). : Master unit is one and others are sub units.
◎	○	◎	L20	Duplicated indoor central addresses on communication of central control system (Detected by central controller side)	Stop (Automatic restart)	Displayed when error is detected	1. Check address setup of central control system network. (DN = 03)

*2 Check code is not displayed by wired remote controller. (Usual operation of air conditioner is disabled.)
For wireless type models, E01 is notified by the display lamp.

Error mode detected by central remote controller

◎: Flash, ○: Go on, ●: Go off

Wireless sensor lamp display			Wired remote controller	Diagnostic function			Judgment and measures
Operation	Timer	Ready	Check code	Cause of operation	Status of air conditioner	Condition	
—	—	—	C05	Sending error central remote controller	Operation continues	Displayed when error is detected	1. Check communication line/miscabling/ Check power of indoor unit. 2. Check communication. (U3, U4 terminals) 3. Check network adapter P.C. board.
—	—	—	C06	Receiving error in central remote controller	Operation continues	Displayed when error is detected	4. Check central controller (such as central control remote controller, etc.). 5. Terminal resistance check (connection interface SW01)
—	—	—	P30	Differs according to error contents of unit with occurrence of alarm.	Continuation/Stop (Based on a case)	Displayed when error is detected	Check the check code of corresponding unit by remote controller

10-3. Error Mode Detected by LED on Outdoor P.C. Board

RAV-SM1103AT-E, RAV-SM1403AT-E /
RAV-SP562AT-E, RAV-SP802AT-E, RAV-SP1102AT-E, RAV-SP1402AT-E

<SW801: LED display in bit 1, bit 2 OFF>

- When multiple errors are detected, the latest error is displayed.
- When LED display is ○ (Go on), there is the main cause of trouble on the objective part of control at CDB side and the unit stops.
- When LED display is ◎ (Flash), there is the main cause of trouble on the objective part of control at IPDU side and the unit stops.
- When case thermostat operates, the communication is interrupted on the serial circuit. If continuing the case thermostat operation, a serial communication error occurs because serial sending to the indoor unit is interrupted.

	No.	Item	Check code		LED display			
			Type A	Type B	D800 (Red)	D801 (Yellow)	D802 (Yellow)	D803 (Yellow)
CDB side	1	TE sensor error	F06	18	○	●	●	●
	2	TD sensor error	F04	19	○	○	●	●
	3	TS sensor error	F06	18	●	●	○	●
	4	TO sensor error	F08	1B	●	○	●	●
	5	Discharge temp. error	P03	1E	●	○	○	●
	6	DC outdoor fan error	P22	1A	○	○	○	●
	7	Communication error between IPDU (Abnormal stop)	L29	1C	○	●	●	○
	8	High-pressure release operation	P04	21	●	○	●	○
		—						
	9	EEPROM error	—	—	○	○	●	○
10	Communication error between IPDU (No abnormal stop)	—	—	●	●	○	○	
IPDU side	11	IGBT short-circuit protection	P26	14	◎	●	●	●
	12	Detection circuit error	P29	16	●	◎	●	●
	13	Current sensor error	H03	17	◎	◎	●	●
	14	Comp. lock error	H02	1D	●	●	◎	●
	15	Comp. breakdown	H01	1F	◎	●	◎	●

○ : Go on ● : Go off ◎ : Flash (5Hz)

<<Check code>>

The check codes are classified into Type A and Type B according to the used remote controller. Be sure to check the remote controller which you use.

Type A :

Neutral 2-cores type wired remote controller such as RBC-AMT31E, RBC-AS21E2, and wireless remote controller kit such as TCB-AX21U (W)-E2.

Type B :

Polarized 3-cores type wired remote controller such as RBC-SR1-PE2, RBC-SR2-PE2, and central control remote controller such as RBC-CR64-PE2.

10-4. Troubleshooting Procedure for Each Check Code

10-4-1. Check Code

[E01 error]

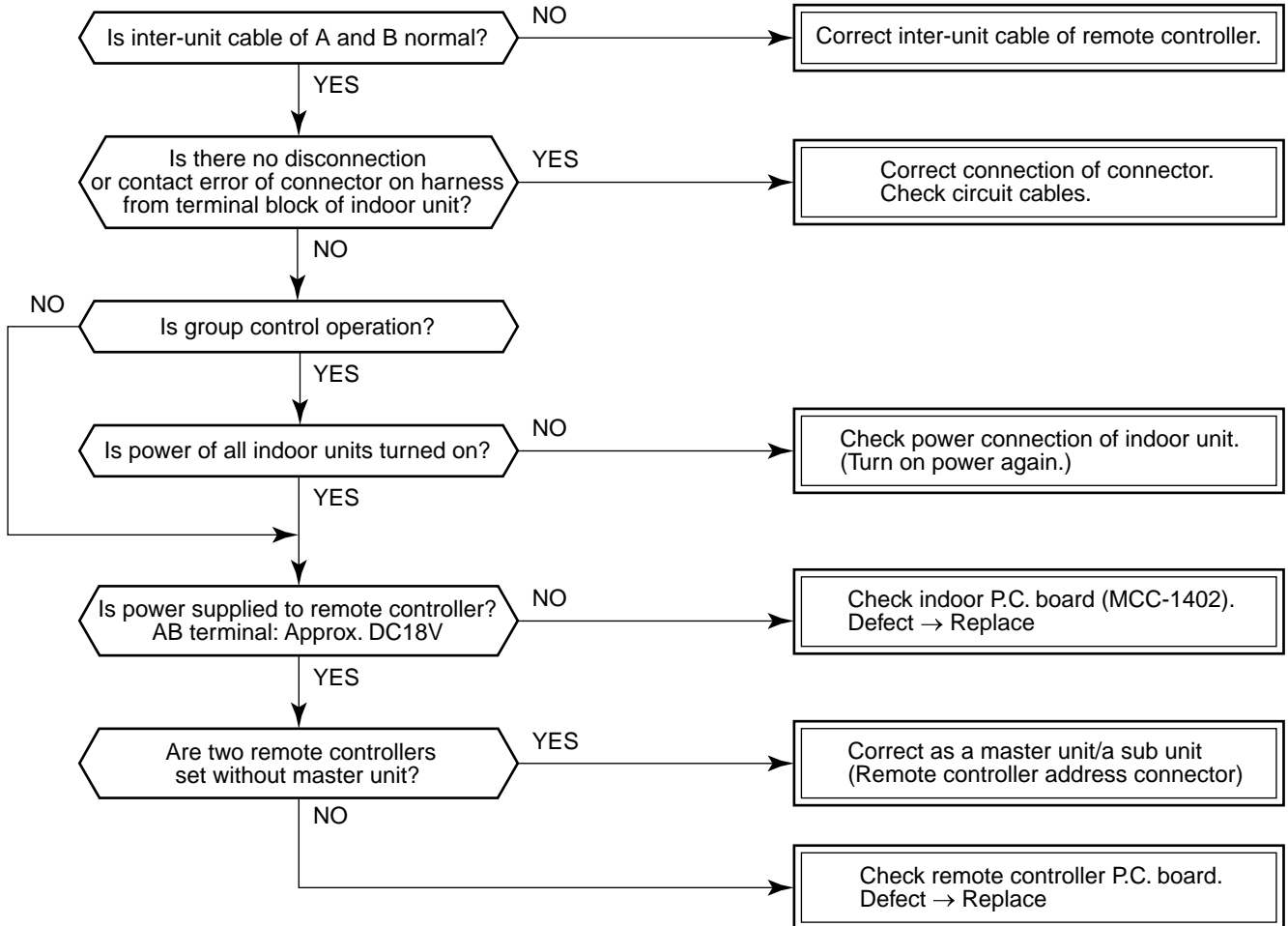

[E09 error]

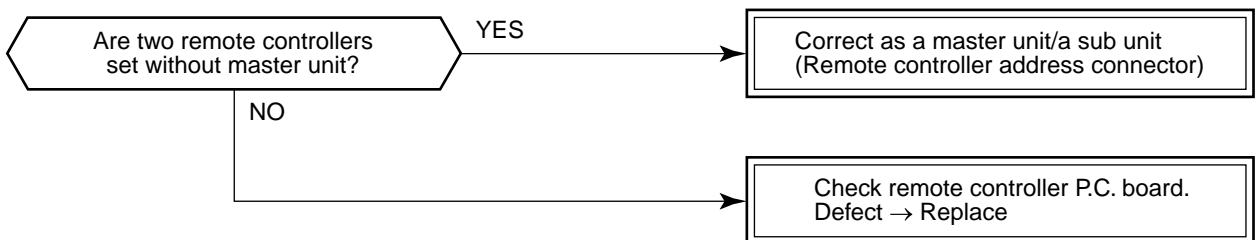

[E04 error]

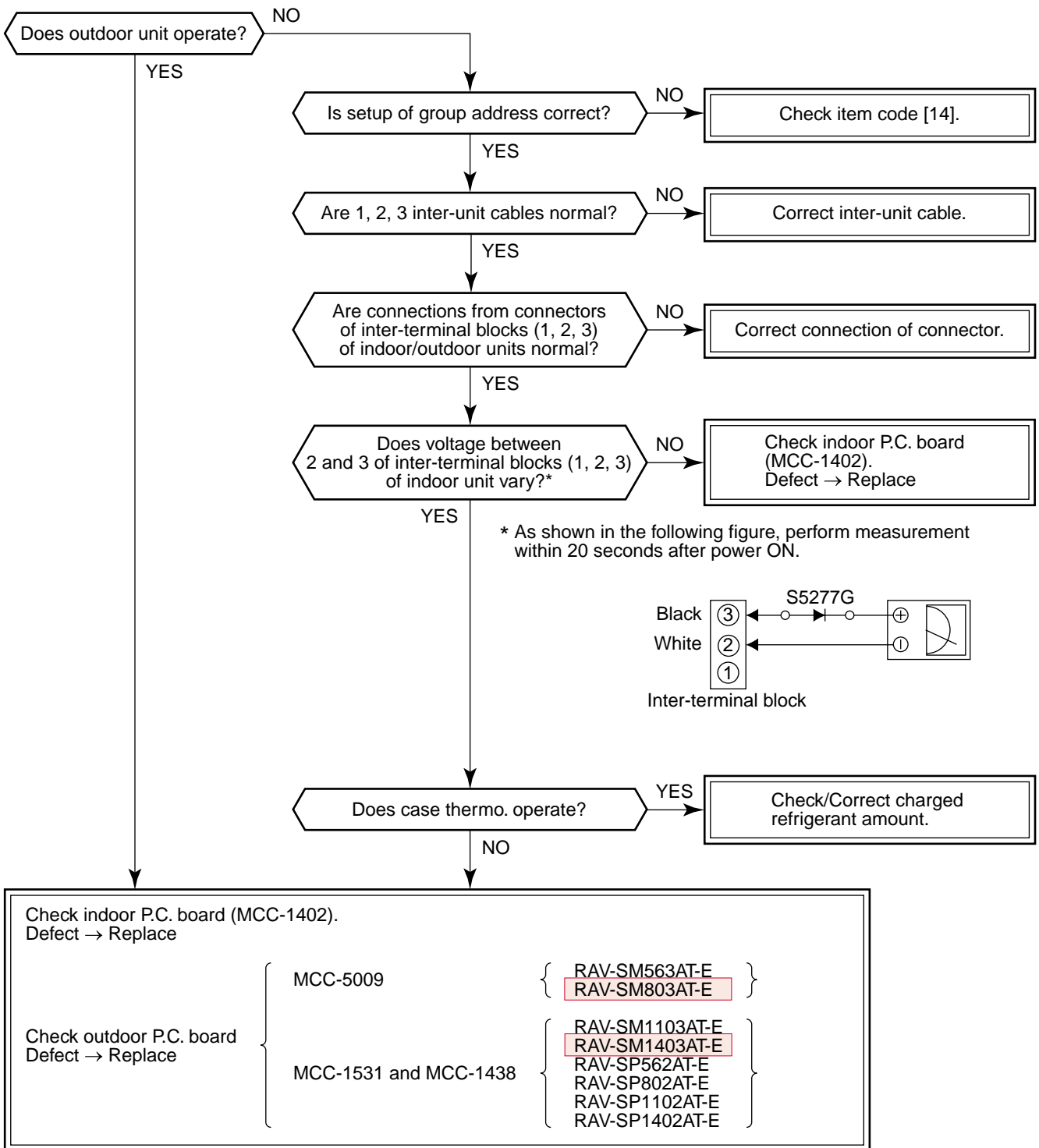

[E10 error]

Check indoor control P.C. board (MCC-1402).
Defect → Replace

[E18 error]

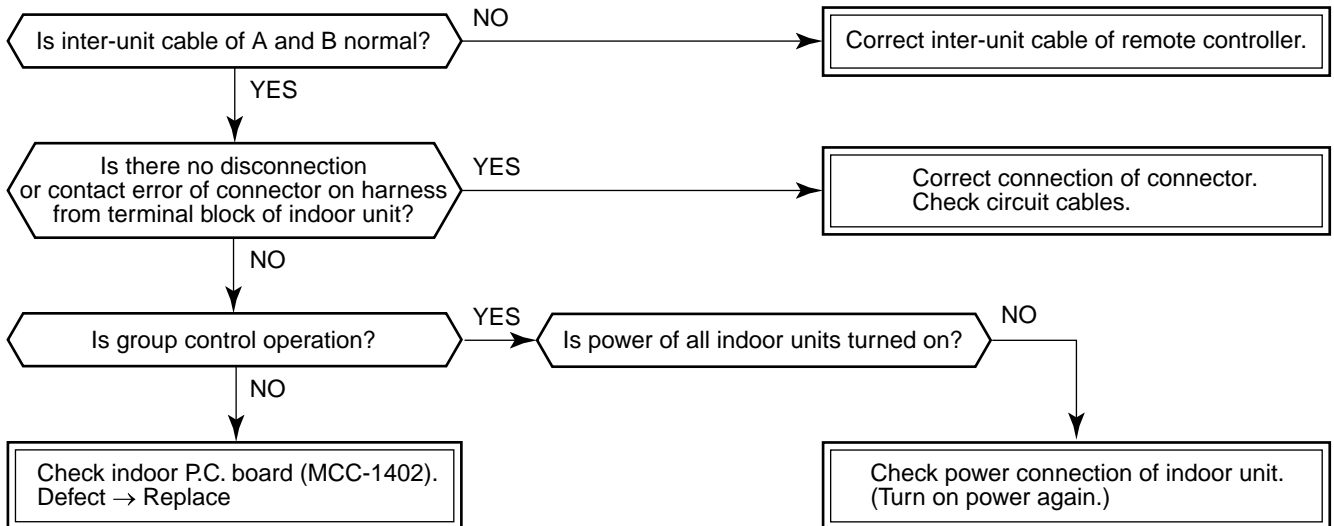

[E08, L03, L07, L08 error]

E08 : Duplicated indoor unit numbers

L03 : Two or more master units in a group control

L07 : One or more group addresses of [Individual] in a group control

L08 : Unset indoor group address (99)

If the above is detected when power has been turned on, the mode automatically enters in automatic address setup mode. (Check code is not displayed.)

However, if the above is detected during automatic address setup mode, the check code may be displayed.

[L09 error]

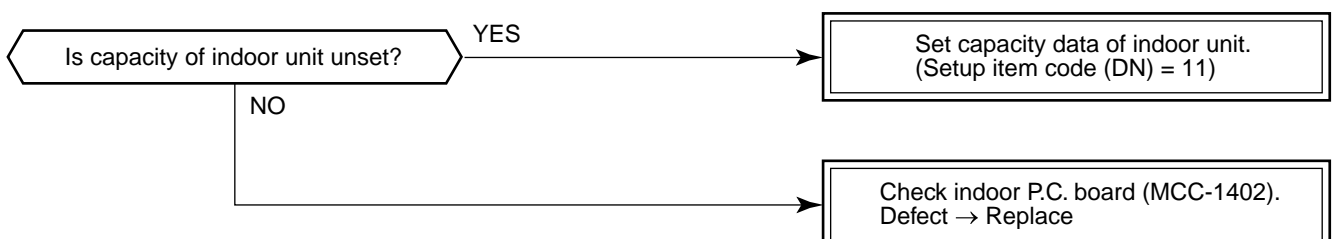

[L20 error]

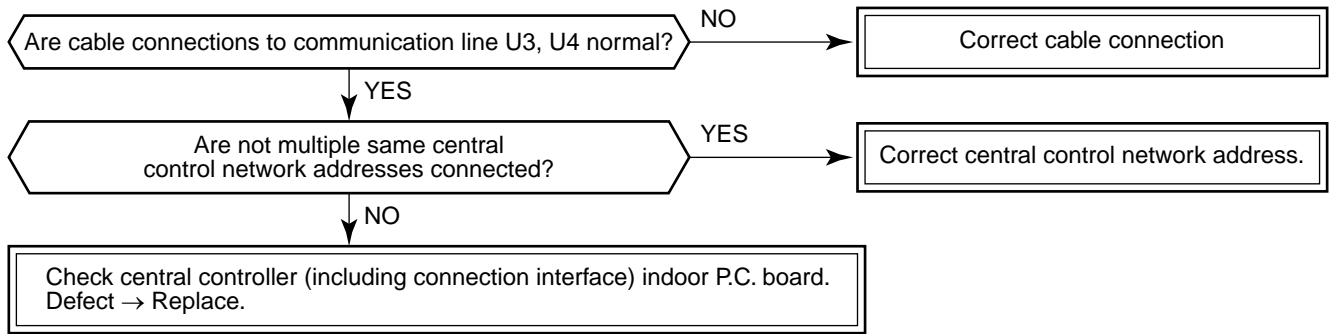

[L30 error]

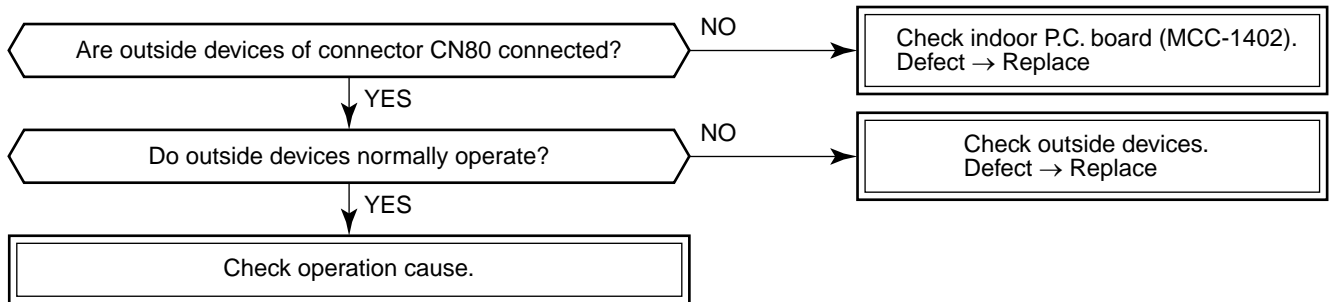

[P10 error]

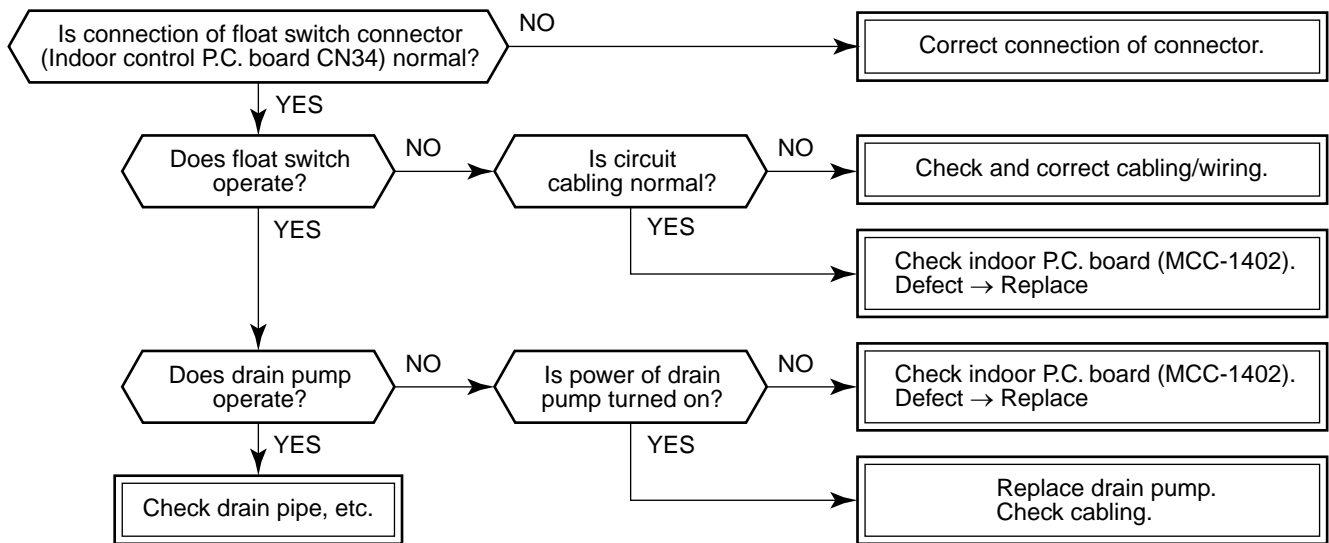

[F10 error]

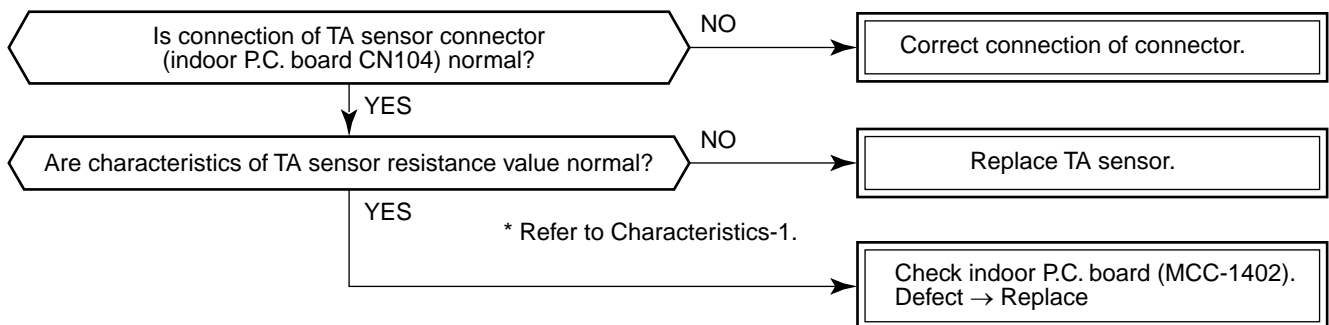

[P12 error]

<Only for 4-way air discharge cassette type models>

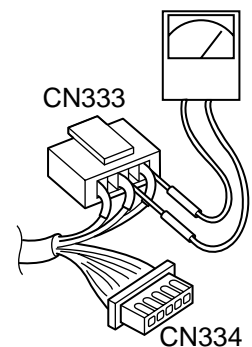
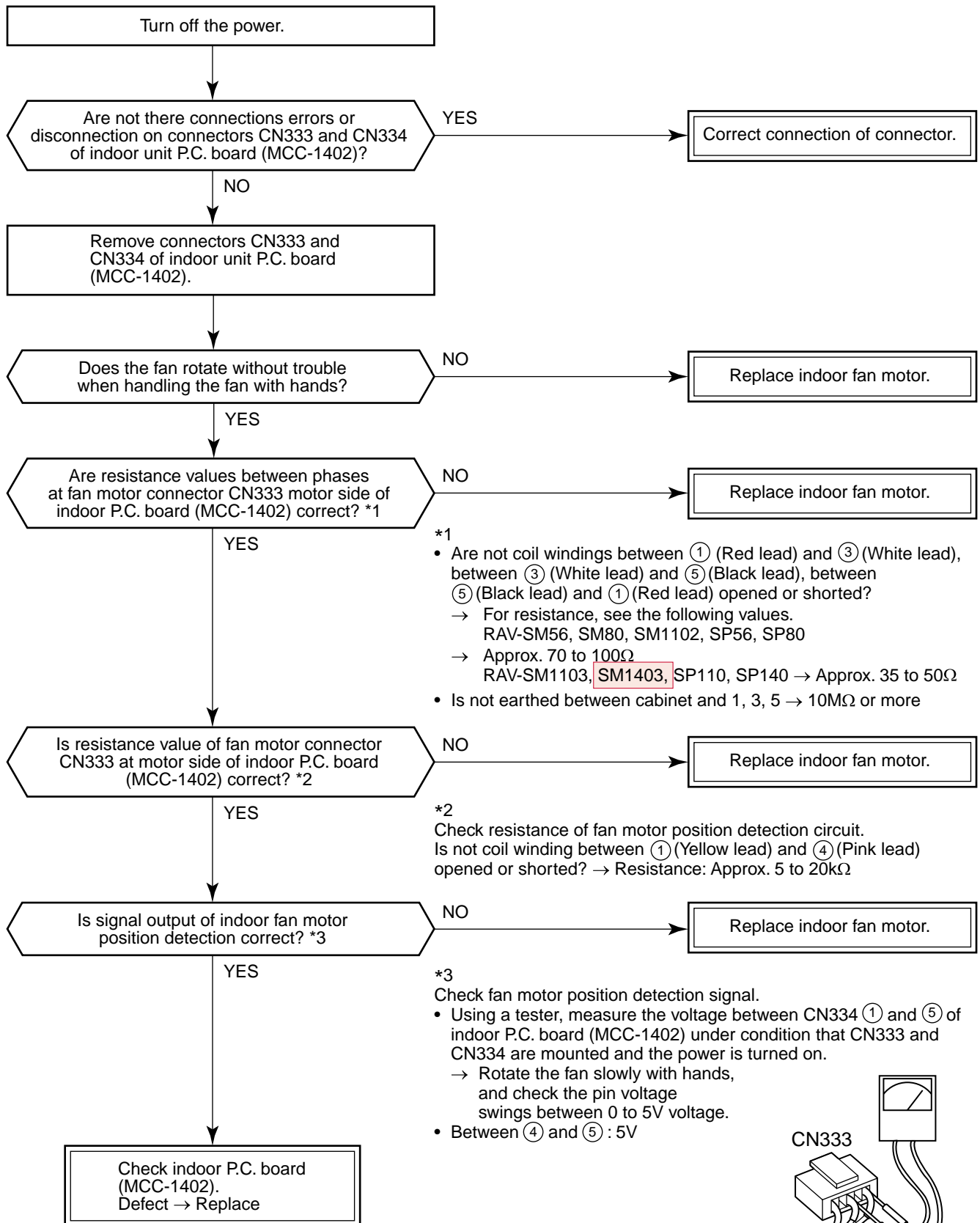

[P22 error]

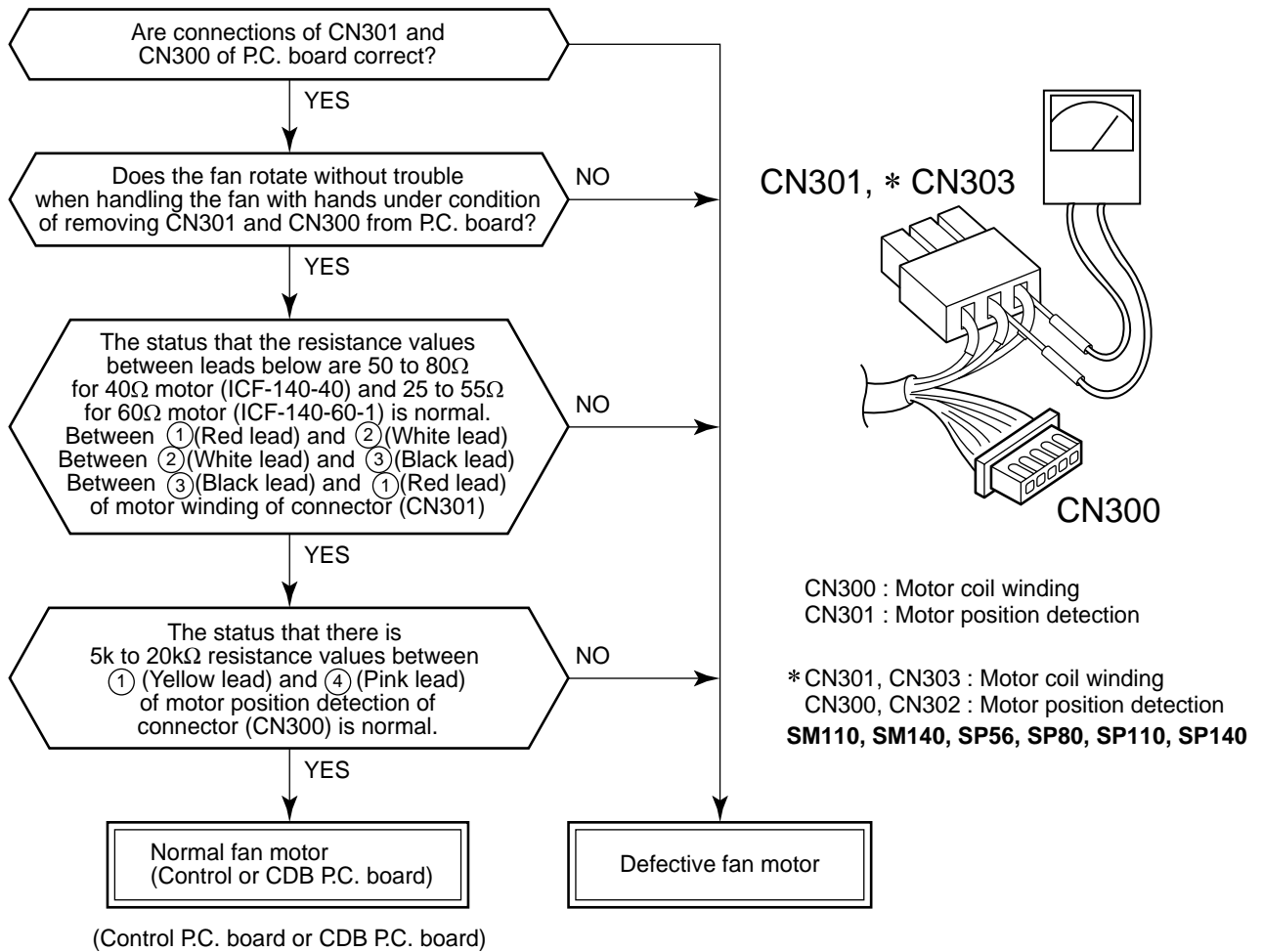

NOTE :

However, GND circuit error inside of the motor is rarely detected even if the above check is carried out. When the circuit does not become normal even if P.C. board has been replaced, replace outdoor fan motor.

	Single phase		
	RAV-SM563AT-E RAV-SM803AT-E	RAV-SP562AT-E, SP802AT-E RAV-SM1103AT-E, SM1403AT-E	RAV-SP1102AT-E, SP1402AT-E
Objective P.C. board	Control P.C. board	CDB P.C. board	CDB P.C. board
Fan motor winding	CN300	CN301	CN301/CN303
Motor position detection	CN301	CN300	CN300/CN302

[P19 error]

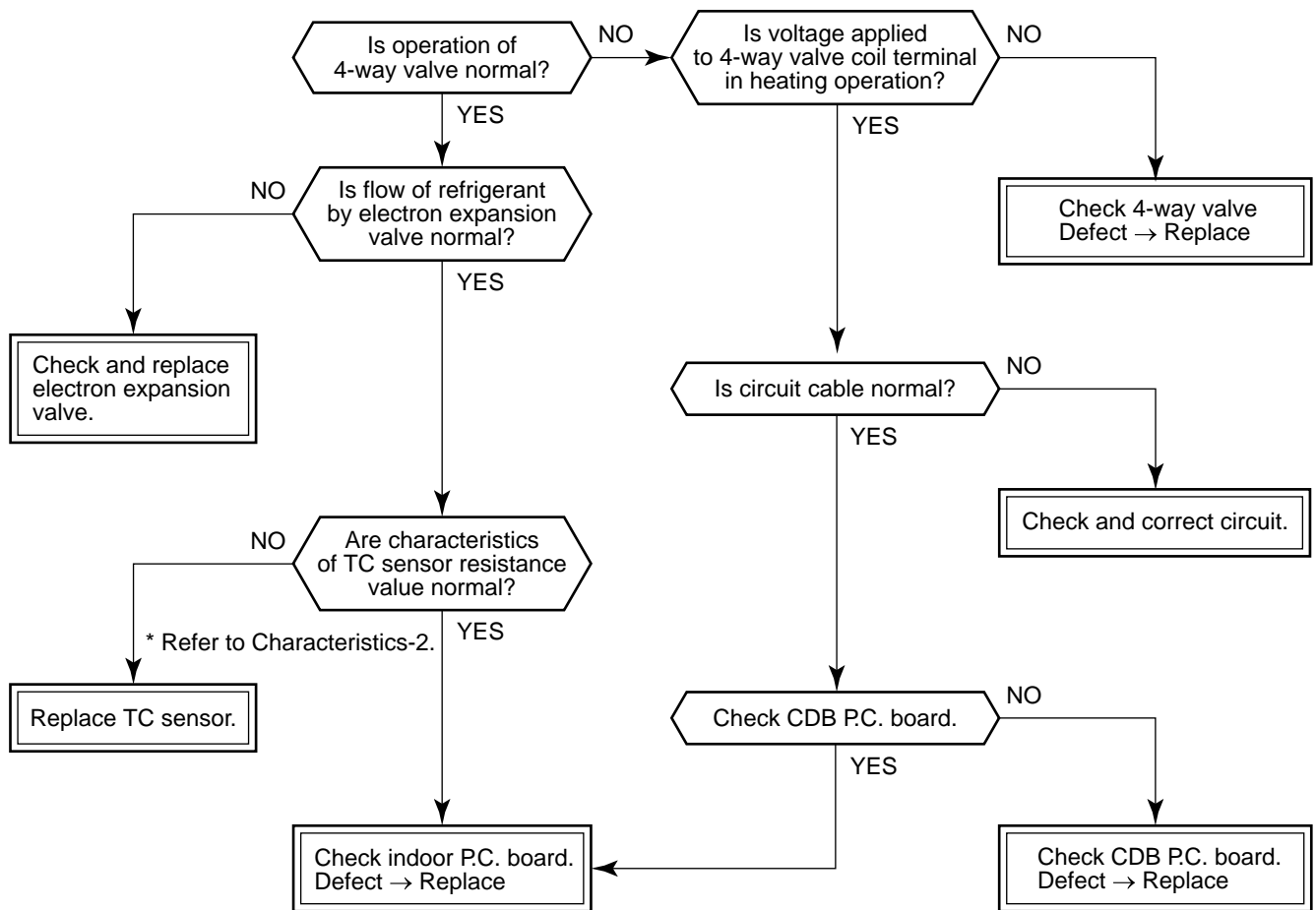

* For RAV-SM563AT-E, SM803AT-E, check control P.C. board.

- In cooling operation, if high pressure is abnormally raised, [P19 error] / [08 error] may be displayed. In this case, remove cause of pressure up and then check again referring to the item [P04 error] / [21 error].

[F02 error]

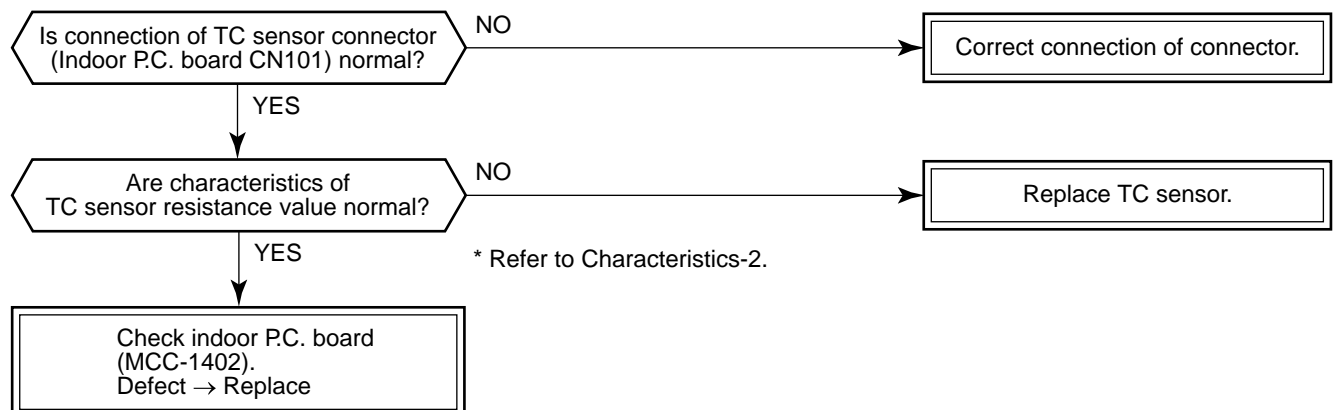

[F01 error]

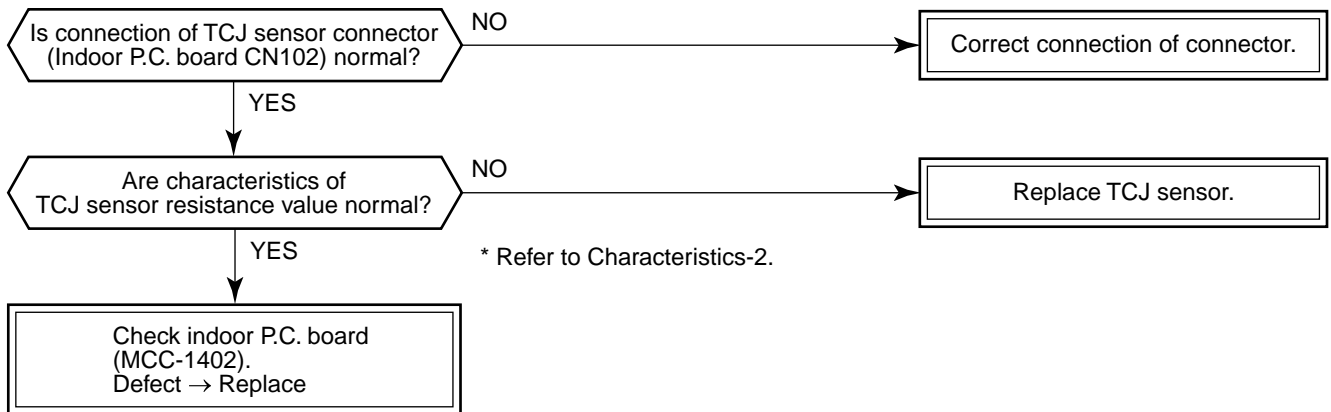

[P26 error]

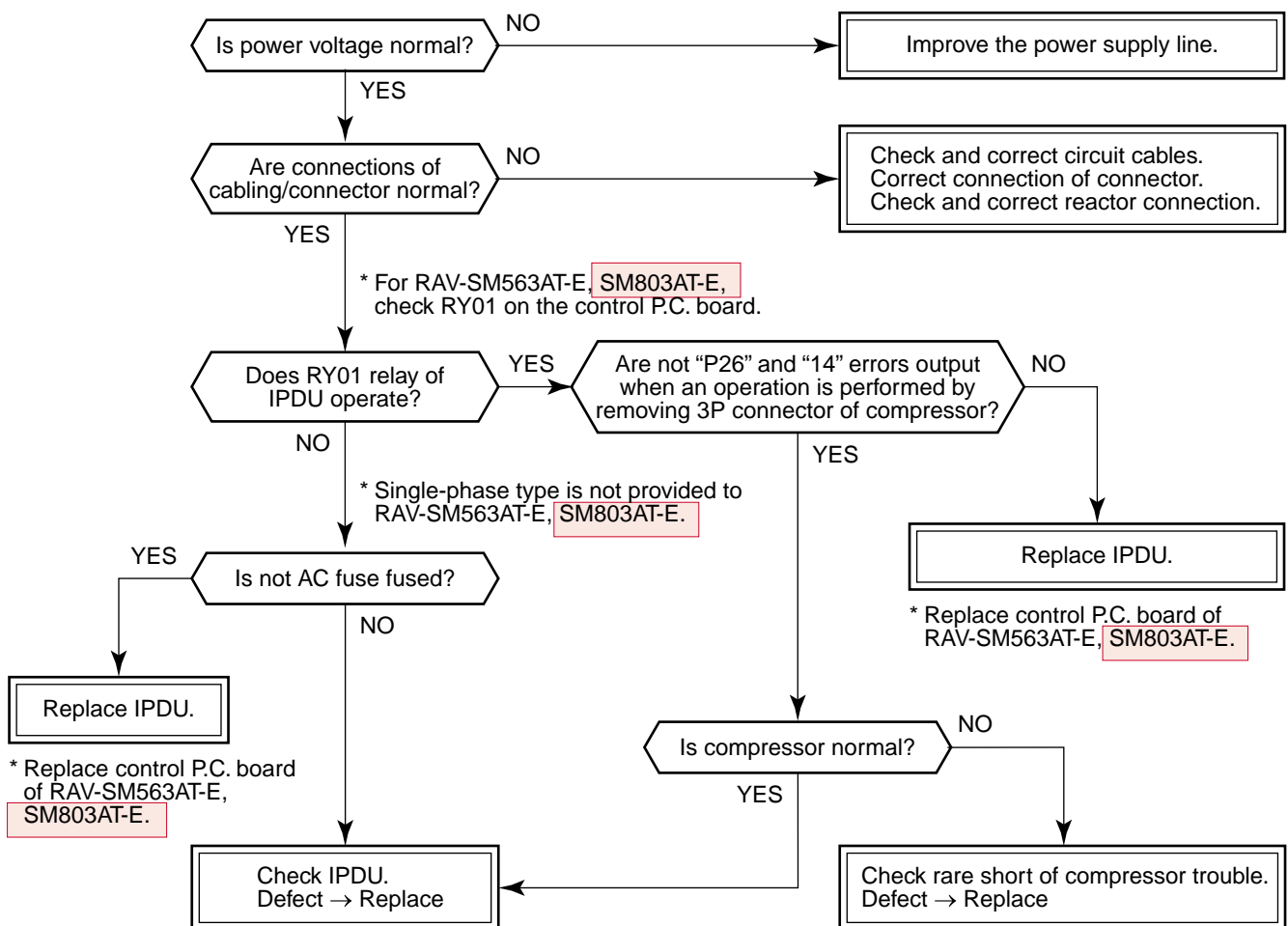

[P29 error]

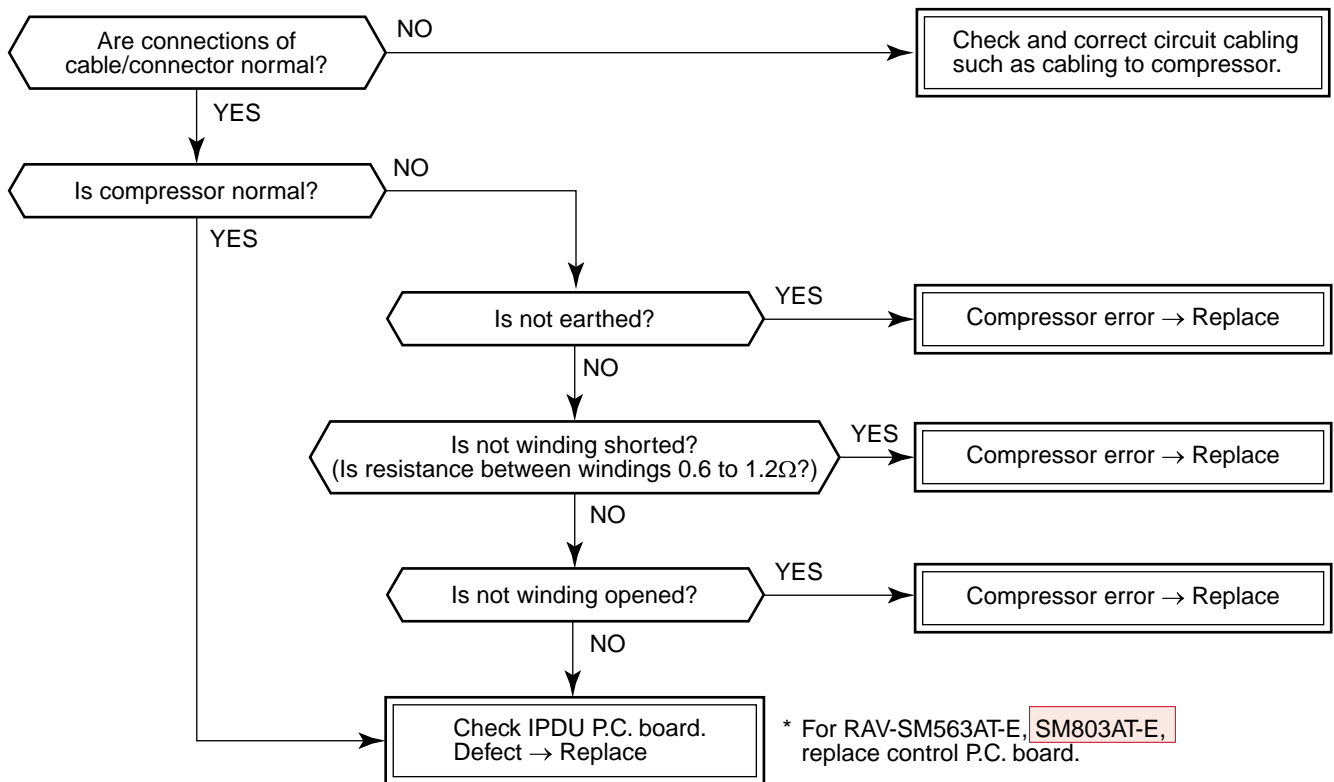

[H03 error]

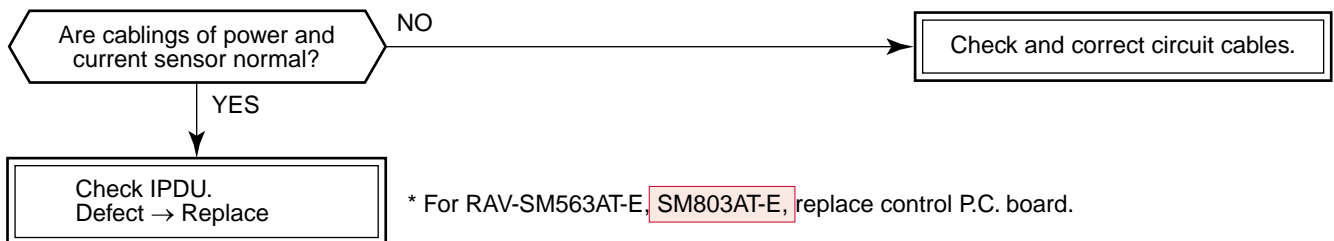

[F06 error]

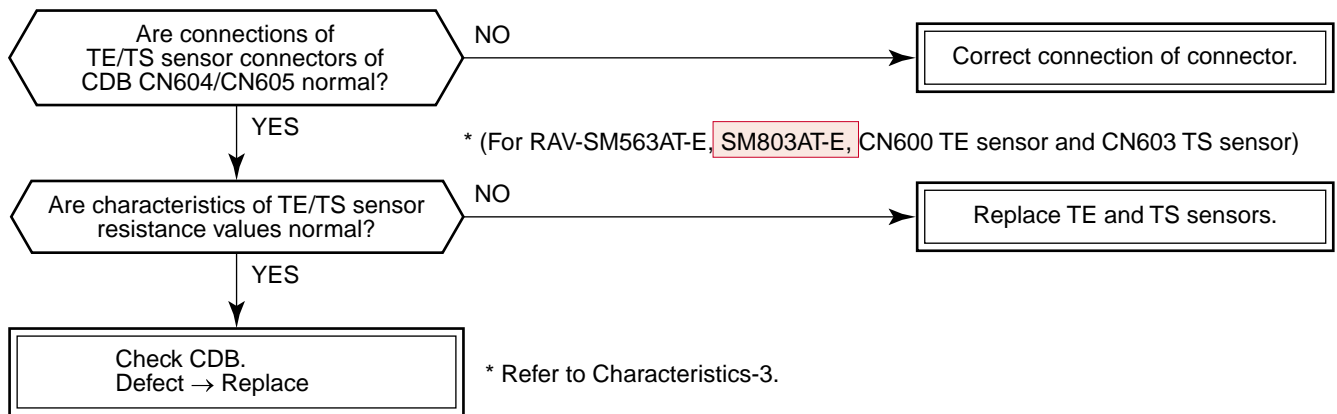

[F04 error]

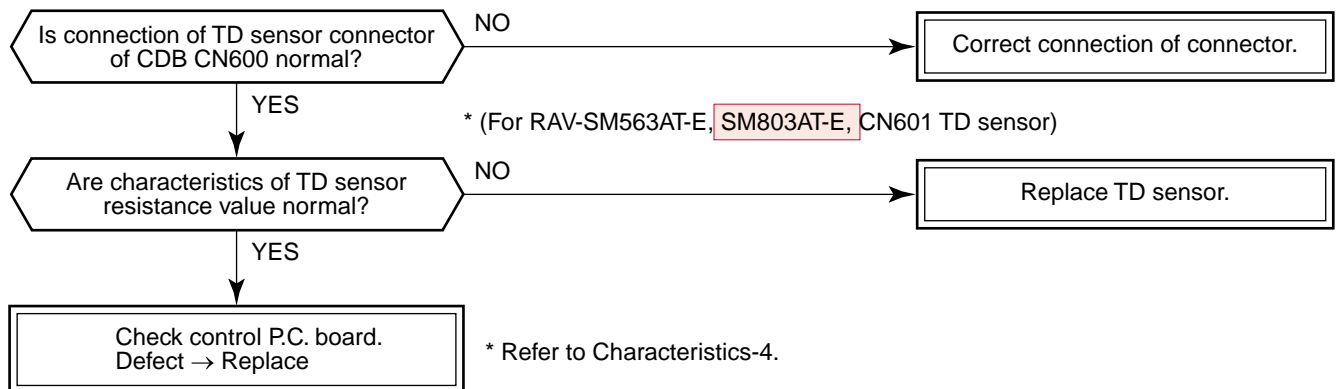

[F08 error]

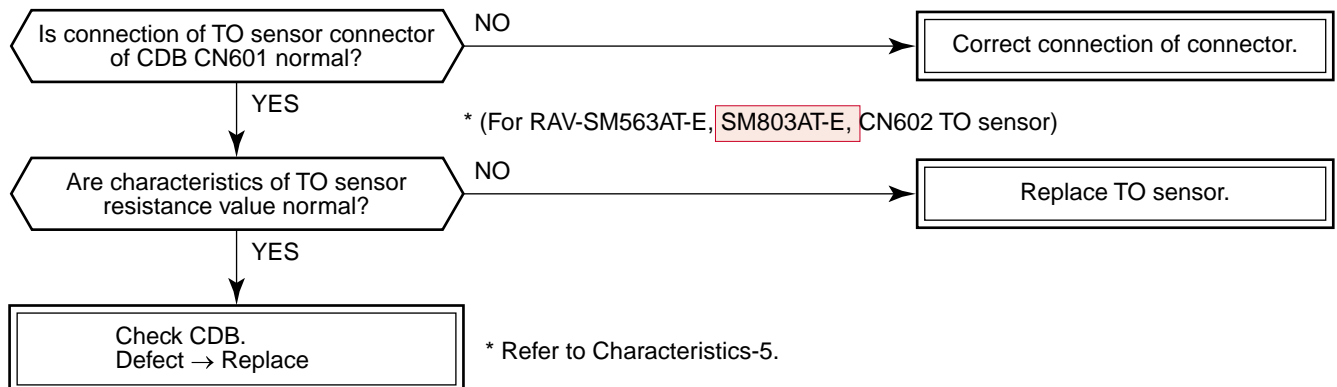

[L29 error]

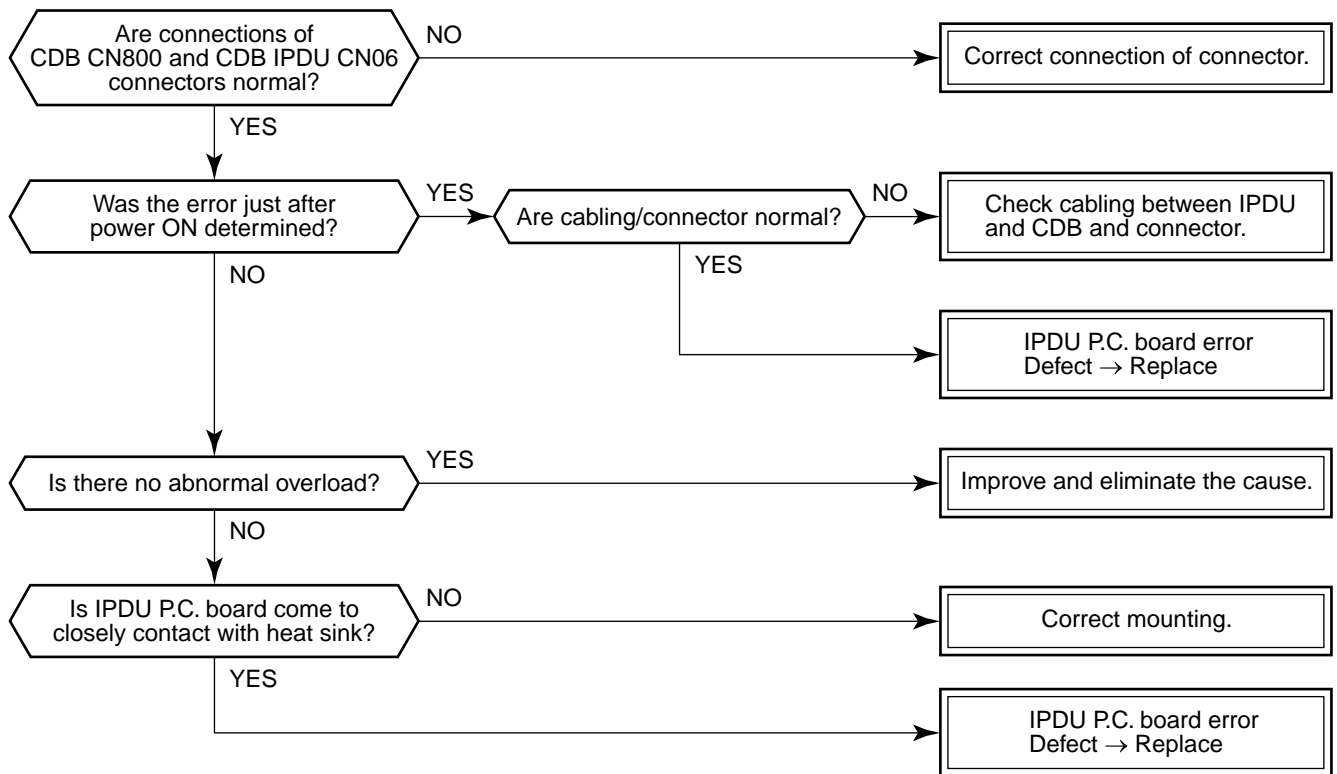

[H02 error]

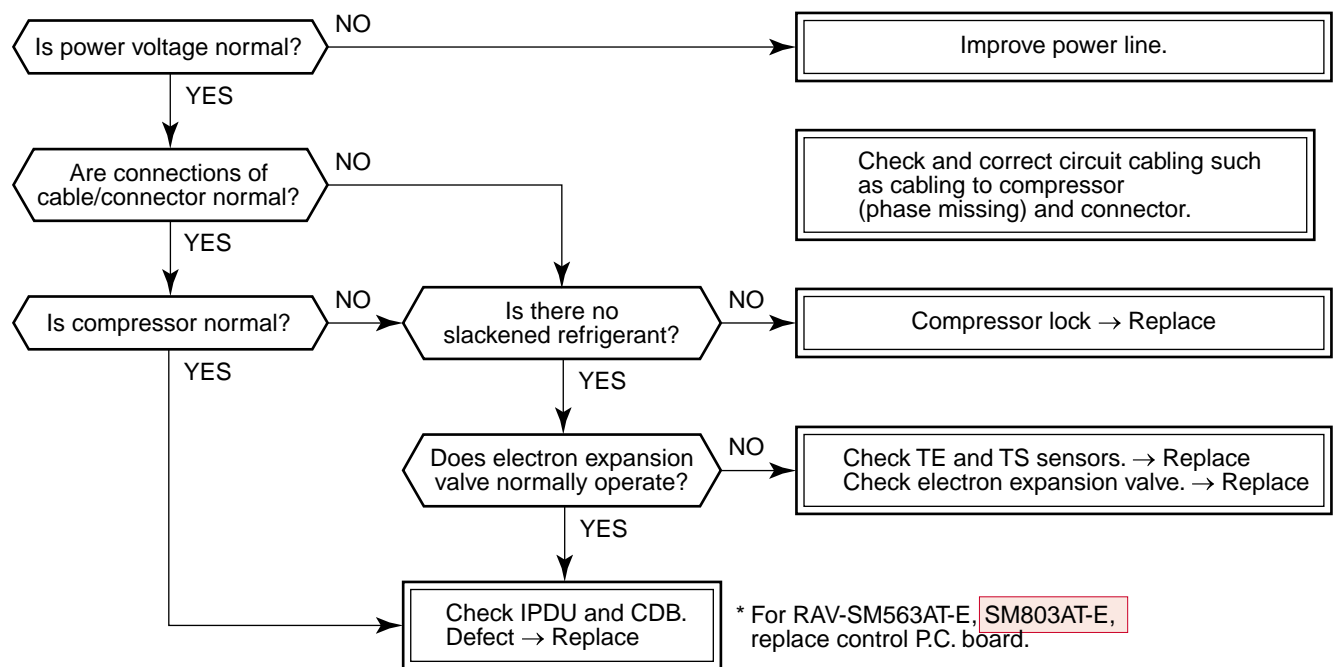

[P03 error]

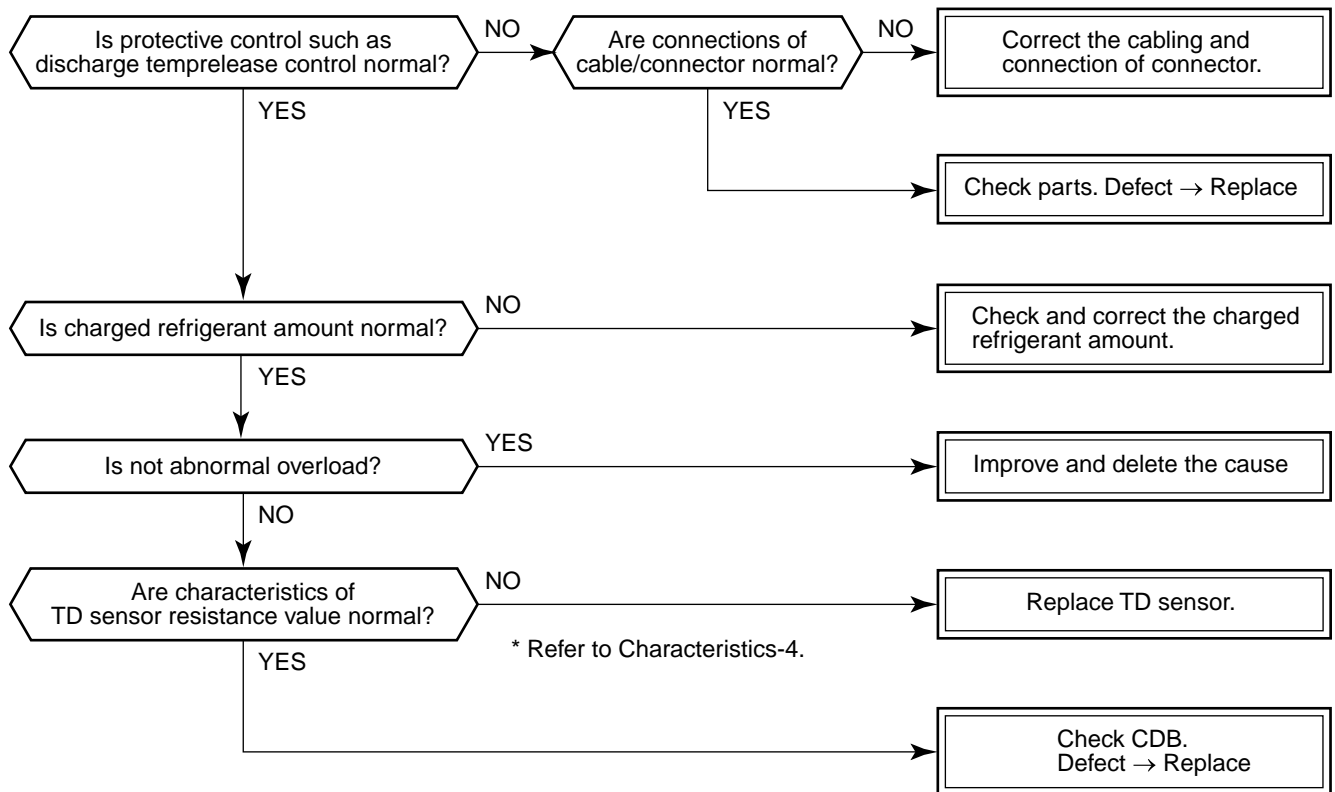

* For RAV-SM563AT-E, SM803AT-E, replace control P.C. board.

[H01 error]

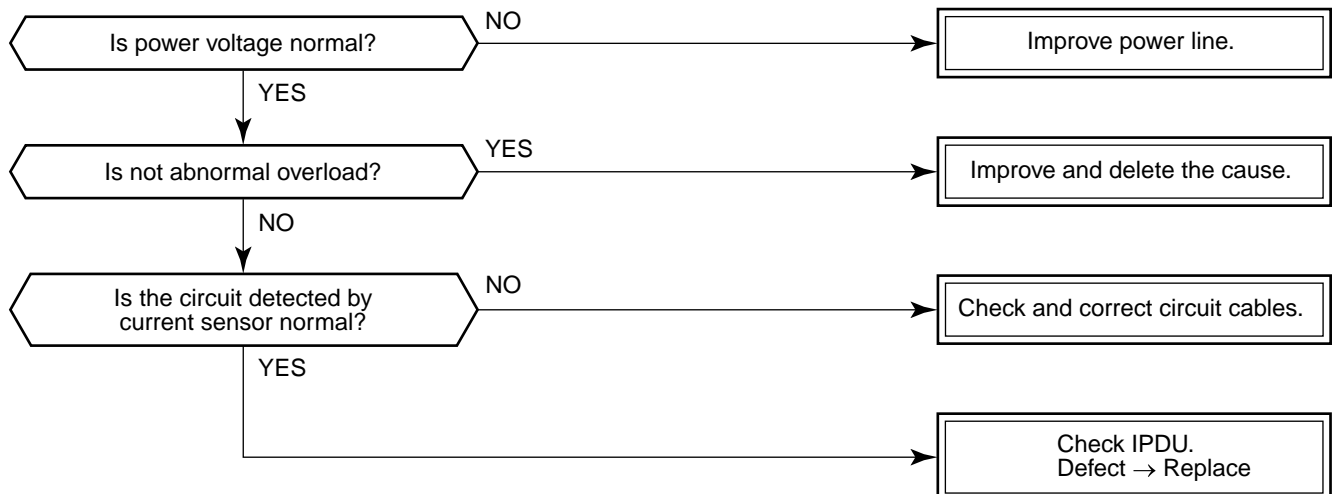

* For RAV-SM563AT-E, SM803AT-E, replace control P.C. board.

[P04 error]

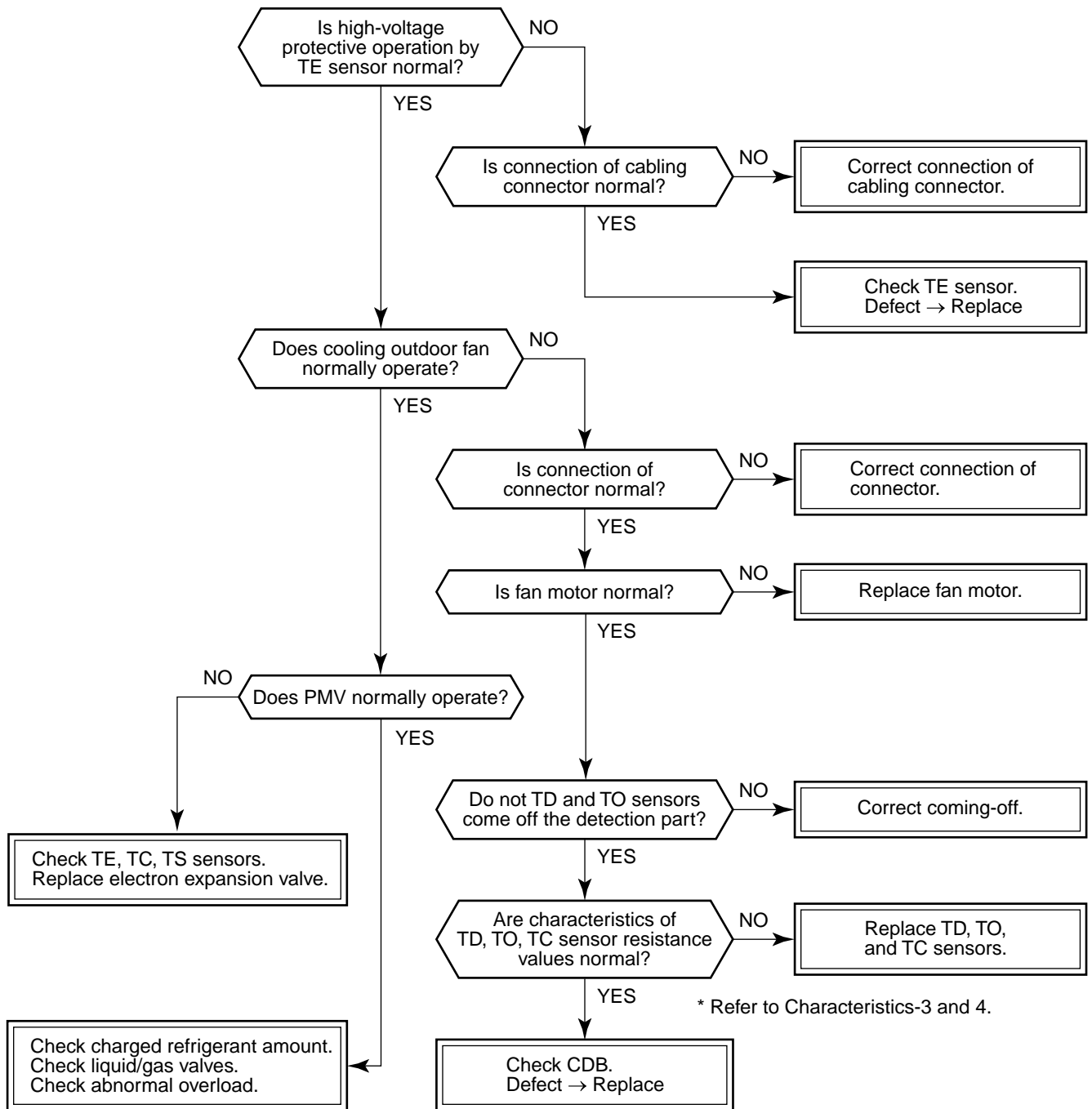

* Refer to Characteristics-3 and 4.

* For RAV-SM563AT-E, SM803AT-E, replace control P.C. board.

[C06 error] (Central controller)

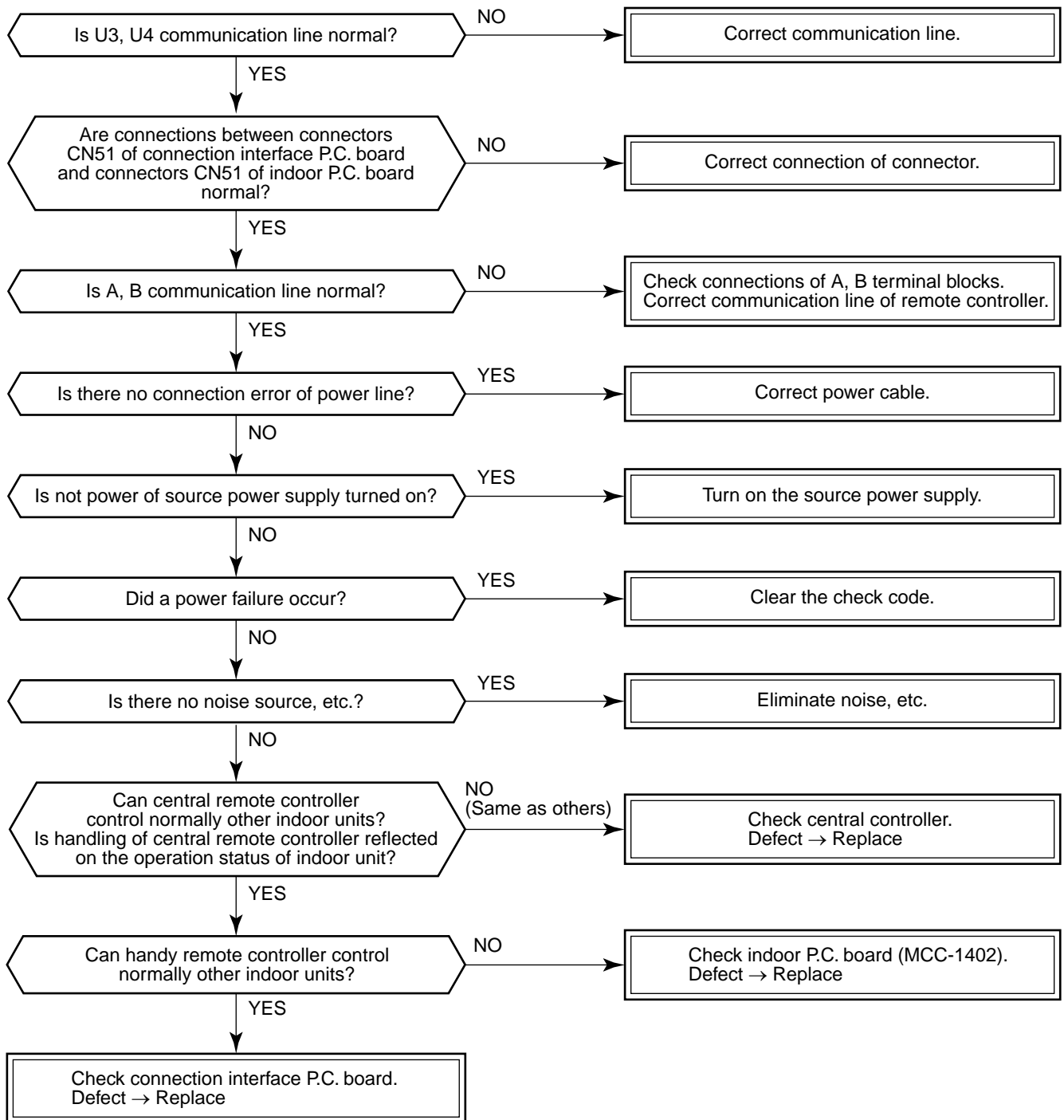

[E03 error] (Master indoor unit)

[E03 error] is detected when the indoor unit cannot receive a signal sent from the main remote controller (and central controller).

In this case, check the communication cables of the remote controllers A and B, the central control system X and Y. As communication is disabled, [E03] is not displayed on the main remote controller and the central controller. [E01] is displayed on the main remote controller and [97 error] on the central controller, respectively. If [E03] occurs during an operation, the air conditioner stops.

[F29 error] / [12 error]

[F29 error] or [12 error] indicates detection of trouble which occurred on IC10 non-volatile memory (EEPROM) on the indoor unit P.C. board during operation of the air conditioner. Replace the service P.C. board.

* If EEPROM has not been inserted when the power was turned on or if EEPROM data never be read/written, the automatic address mode is repeated. In this time, the central controller displays [97 error].

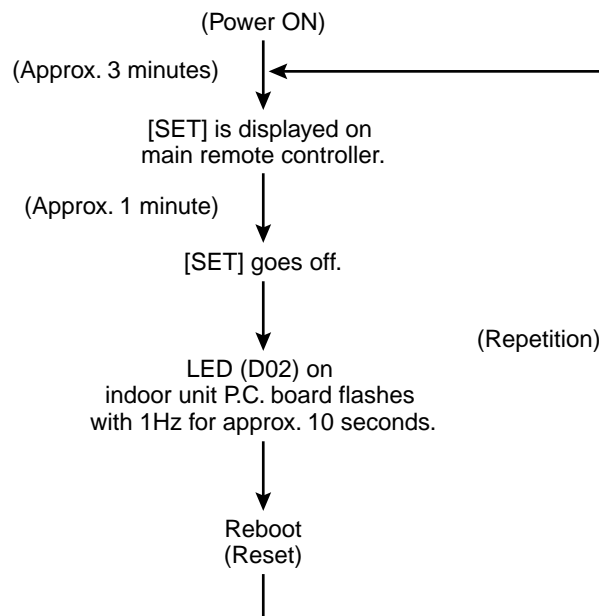

[P31 error] (Sub indoor unit)

When the master unit of a group operation has detected [E03], [L03], [L07], or [L08] error, the sub unit of the group operation detects [P31 error] and then it stops. There is no display of the check code or alarm history of the main remote controller.

(In this model, the mode enters in automatic address set mode when the master unit has detected [E03], [L03], [L07], or [L08] error.)

10-4-2. Relational Graph of Temperature Sensor Resistance Value and Temperature

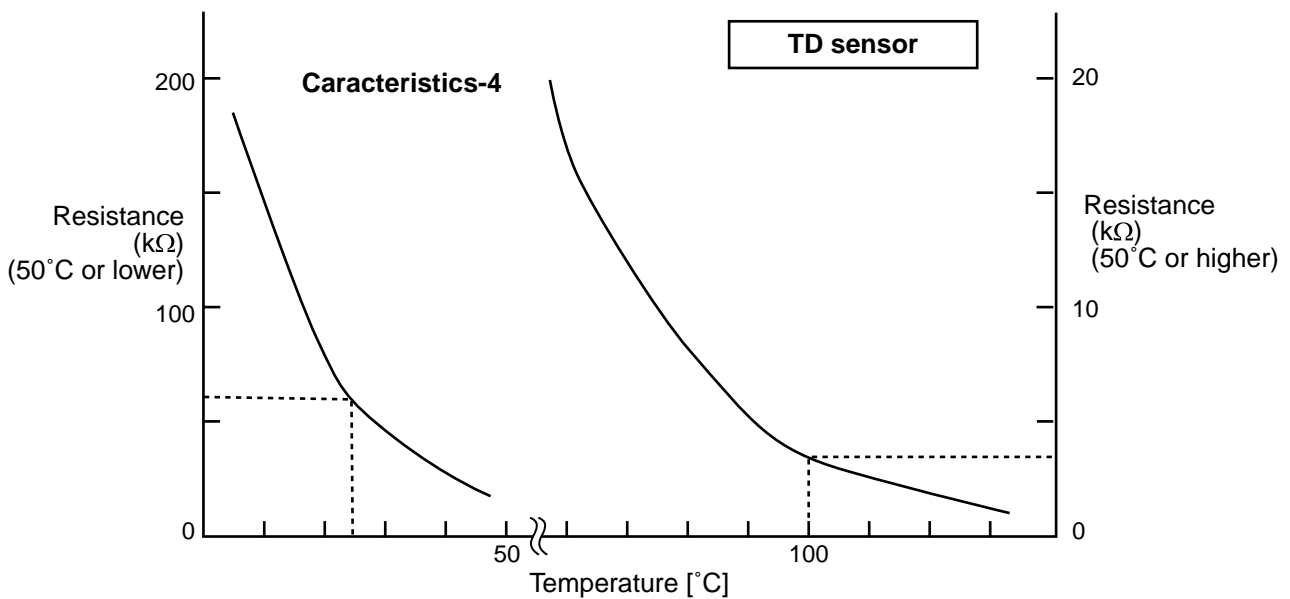
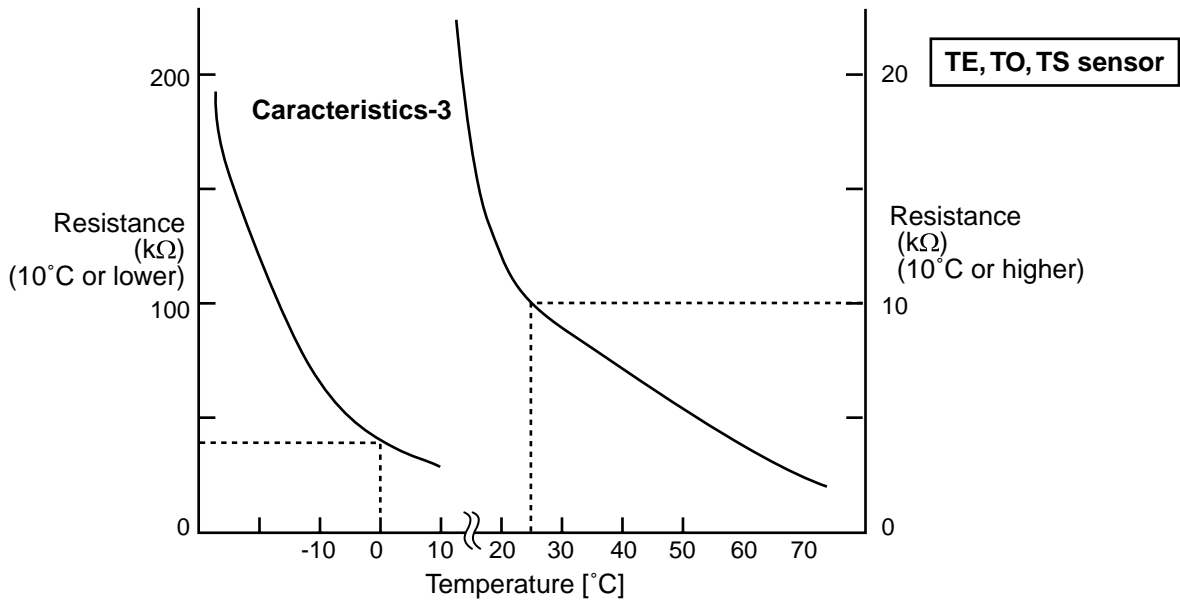
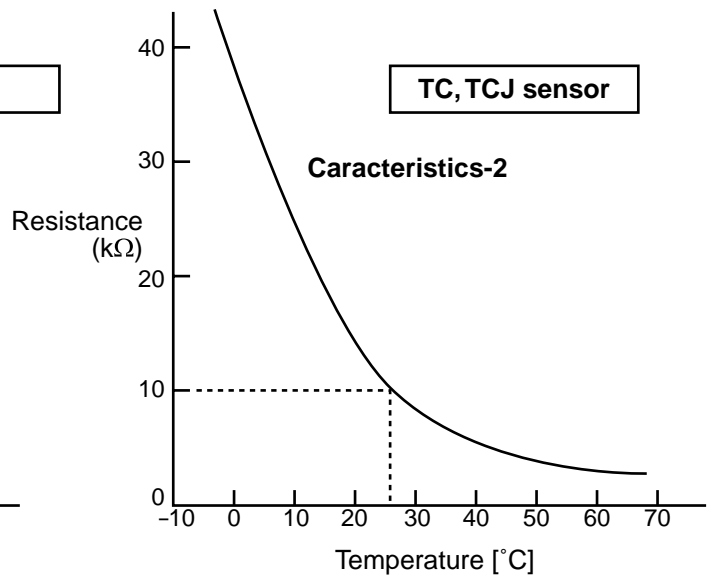
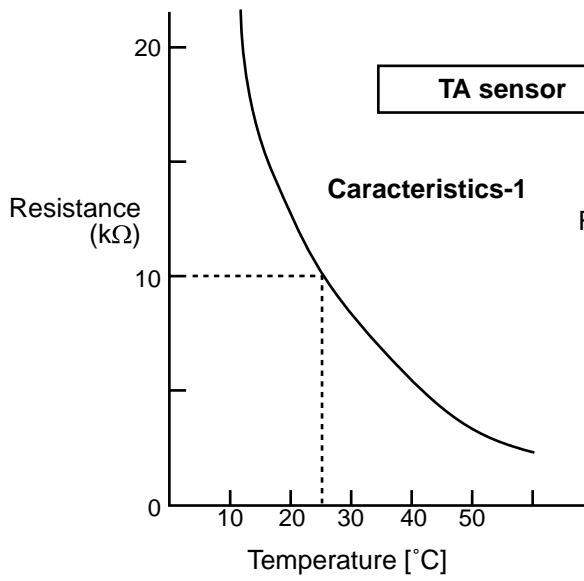

11. REPLACEMENT OF SERVICE INDOOR P.C. BOARD

[Requirement when replacing the service indoor P.C. board assembly]

In the non-volatile memory (Hereinafter said EEPROM, IC10) installed on the indoor P.C. board before replacement, the type and capacity code exclusive to the corresponding model have been stored at shipment from the factory and the important setup data such as system/indoor/group address set in (AUTO/MANUAL) mode or setting of high ceiling selection have been stored at installation time. Replace the service indoor P.C. board assembly according to the following procedure.

After replacement, check the indoor unit address and also the cycle by a test run.

<REPLACEMENT PROCEDURE>

CASE 1

Before replacement, power of the indoor unit can be turned on and the setup data can be readout from the wired remote controller.

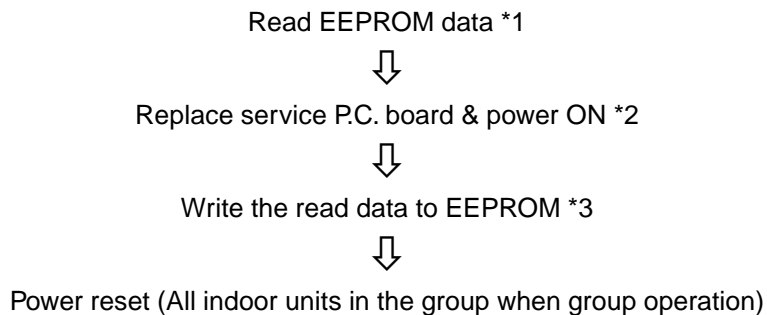

CASE 2

Before replacement the setup data can not be readout from the wired remote controller.

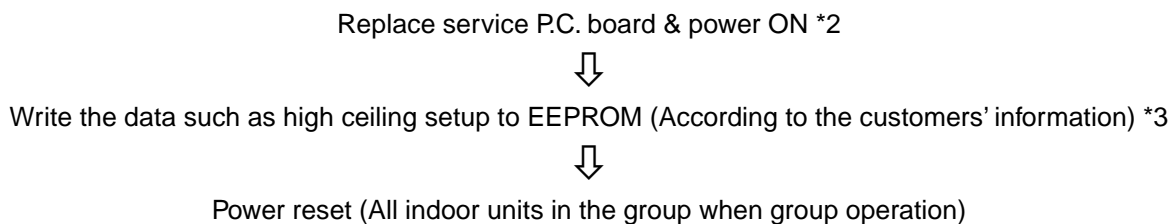

□1 Readout of the setup data from EEPROM

(Data in EEPROM contents, which have been changed at the local site, are read out together with data in EEPROM set at shipment from the factory.)

1. Push **SET**, **CL**, and **TEST** buttons of the remote controller at the same time for 4 seconds or more. **1**
(Corresponded with No. in Remote controller)
When group operation, the master indoor unit address is displayed at the first time. In this time, the item code (DN) **10** is displayed. The fan of the selected indoor unit operates and the louver starts swinging if any.
2. Every pushing **UNIT** button, the indoor unit address in the group are displayed successively. **2**
Specify the indoor unit No. to be replaced.
3. Using the set temperature **▼** / **▲** buttons, the item code (DN) can be moved up and down one by one. **3**
4. First change the item code (DN) from **10** to **01**.
(Setting of filter sign lighting time) Make a note of the set data displayed in this time.
5. Next change the item code (DN) using the set temperature **▼** / **▲** buttons. Also make a note of the set data.
6. Repeat item 5. and make a note of the important set data as shown in the later table (Ex.).
 - **01** to **FF** are provided in the item code (DN). On the way of operation, DN No. may come out.
7. After finishing making a note, push **TEST** button to return the status to usual stop status. **6**
(Approx. 1 minute is required to start handling of the remote controller.)

Minimum requirements for item code

DN	Contents
10	Type
11	Indoor unit capacity
12	Line address
13	Indoor address
14	Group address

- 1) Type and capacity of the indoor unit is necessary to set the revolutions frequency of the fan.
- 2) If Line/Indoor/Group addresses differ from those before replacement, the mode enters in automatic address setup mode and a manual resetting may be required.

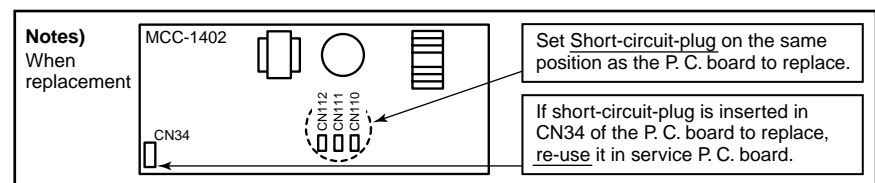

□2 Replacement of service P.C. board

1. Replace the P.C. board with a service P.C. board.
In this time, setting of jumper line (cut) or setting of (short-circuit) connecting connectors on the former P.C. board should be reflected on the service P.C. board. (See Appendix 1, page 4)
 2. According to the system configuration, turn on power of the indoor unit with any method in the following items.
 - a) In case of single (individual) operation
Turn on the power supply.
 - 1) Wait for completion of automatic address setup mode (Required time: Approx. 5 minutes) and then proceed to **□3**.
(Line address = 1, Indoor address = 1, Group address = 0 (Individual) are automatically set.)
 - 2) Push **SET**, **CL**, and **TEST** buttons of the remote controller at the same time for 4 seconds or more (**1** operation), interrupt the automatic address setup mode, and then proceed to **□3**.
(Unit No. **ALL** is displayed.)
 - b) In case of group operation
Turn on power of the indoor unit of which P.C. board has been replaced with the service P.C. board with any method in the following items.
 - 1) Turn on power of the replaced indoor unit only.
(However, the remote controller is also connected.
Otherwise **□3** operation cannot be performed.)
Same as 1) and 2) in item a).
 - 2) Turn on power of the multiple indoor units including replaced indoor unit.
 - Only 1 system for twin, triple, double twin
 - For all units in the group
- Wait for completion of automatic address setup mode (Required time: Approx. 5 minutes) and then proceed to **□3**.

* The master unit of a group may change by setup of automatic address. The line address/indoor address of the replaced indoor unit are automatically set to the vacant addresses except addresses belonging to other indoor units which have not been replaced. It is recommended to make a note that the refrigerant line which includes the corresponding indoor unit and that the corresponding indoor unit is master or sub in the group control.

□3 Writing of the setup contents to EEPROM

(The contents of EEPROM installed on the service P.C. board have been set up at shipment from the factory.)

1. Push **SET**, **CL**, and **TEST** buttons of the remote controller at the same time for 4 seconds or more. **1**
(Corresponded with No. in Remote controller)

In group operation control, the master indoor unit No. is displayed at the first time. (If the automatic address setup mode is interrupted in item 2. - a) - 2) in the previous page, the unit No. *ALL* is displayed.) In this time, the item code (DN) *10* is displayed. The fan of the selected indoor unit operates and the louver starts swinging if any.

2. Every pushing **UNIT** button, the indoor unit numbers in the group control are displayed successively. **2**
Specify the indoor unit No. of which P.C. board has been replaced with a service P.C. board.
(When the unit No. *ALL* is displayed, this operation cannot be performed.)

3. Using the set temperature **▼** / **▲** buttons, the item code (DN) can be moved up and down one by one. **3**

4. First set a type and capacity of the indoor unit.
(Setting the type and capacity writes the data at shipment from the factory in EEPROM.)

- 1) Set the item code (DN) to *10*. (As it is)
- 2) Using the timer time **▼** / **▼** buttons, set up a type. **4**
(For example, 4-way air discharge cassette type is 0001) Refer to the attached table.
- 3) Push **SET** button. (OK when the display goes on.) **5**
- 4) Using the set temperature **▼** / **▲** buttons, set *11* to the item code (DN).
- 5) Using the timer time **▼** / **▲** buttons, set the capacity.
(For example, 0012 for class 80) Refer to the attached table.

- 6) Push **SET** button. (OK when the display goes on.)
- 7) Push **TEST** button to return the status to usual stop status. **6**
(Approx. 1 minute is required to start handling of the remote controller.)

5. Next write the contents which have been set up at the local site such as the address setup in EEPROM.
Repeat the above procedure 1. and 2.

6. Using the set temperature **▼** / **▲** buttons, set *01* to the item code (DN).
(Setup of lighting time of filter sign)

7. The contents of the displayed setup data in this time should be agreed with the contents in the previous memorandum in □1.

- 1) If data disagree, change the displayed setup data to that in the previous memorandum by the timer time **▼** / **▲** buttons, and then push **SET** button. (OK when the display goes on.)
- 2) There is nothing to do when data agrees.

8. Using the set temperature **▼** / **▲** buttons, change the item code (DN).

As same as the above, check the contents of the setup data and then change them to data contents in the previous memorandum.

9. Then repeat the procedure 7. and 8.

10. After completion of setup, push **TEST** button to return the status to the usual stop status. **6**
(Approx. 1 minute is required to start handling of the remote controller.)

- * *01* to *9F* are provided in the item code (DN).
On the way of operation, DN No. may come out. When data has been changed by mistake and **SET** button has been pushed, the data can be returned to the data before change by pushing **CL** button if the item code (DN) was not yet changed.

<REMOTE CONTROLLER>

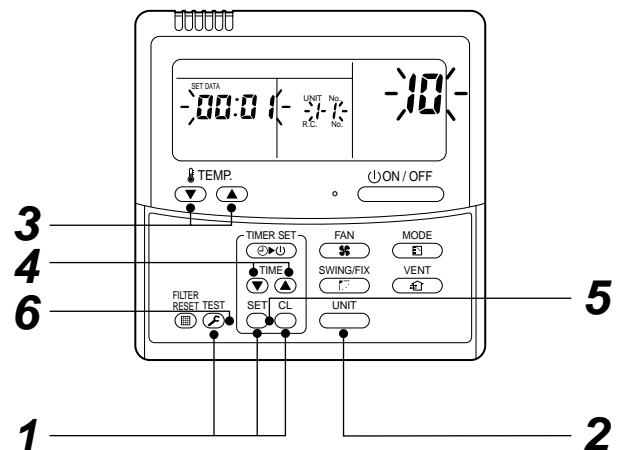

Memorandum for setup contents (Item code table (Example))

DN	Item	Memo	At shipment
01	Filter sign lighting time		According to type
02	Dirty state of filter		0000: Standard
03	Central control address		0099: Unfixed
06	Heating suction temp shift		0002: +2°C (Floor type: 0)
0F	Cooling only		0000: Shared for cooling/heating
10	Type		According to model type
11	Indoor unit capacity		According to capacity type
12	Line address		0099: Unfixed
13	Indoor unit address		0099: Unfixed
14	Group address		0099: Unfixed
19	Louver type (Adjustment of air direction)		According to type
1E	Temp difference of automatic cooling/ heating selecting control points		0003: 3 deg (Ts ± 1.5)
28	Automatic reset of power failure		0000: None
2A	Option		0002:
2b	Thermo output selection (T10 ±B)		0000: Thermo ON
2E	Option		0000:
32	Sensor selection		0000: Body sensor
5d	High ceiling selection		0000: Standard
60	Timer set (Wired remote controller)		0000: Available
8b	Correction of high heat feeling		0000: None

Type

Item code [10]

Setup data	Type	Abbreviated name
0001*	4-way air discharge cassette	RAV-SM563/803/1103/1403UT-E, RAV-SP1102UT-E
0004	Concealed duct	RAV-SM562/802/1102/1402BT-E
0007	Under ceiling	RAV-SM562/802/1102/1402CT-E

* Initial setup value of EEPROM installed on the service P.C. board

Indoor unit capacity

Item code [11]

Setup data	SM563UT-E, SM562BT-E, SM562CT-E SM803UT-E, SM802BT-E, SM802CT-E
0000*	Invalid
0009	56
0012	80

Setup data	RAV-SM1103UT-E, SM1403UT-E, SM1102BT-E, SM1402BT-E, SM1102CT-E, SM1402CT-E RAV-SP1102UT-E
0000*	Invalid
0015	110
0017	140

* Initial setup value of EEPROM installed on the service P.C. board

12. SETUP AT LOCAL SITE AND OTHERS

12-1. Indoor Unit

12-1-1. Test Run Setup on Remote Controller

RAV-SM563UT-E, **RAV-SM803UT-E**, RAV-SM562BT-E, RAV-SM802BT-E

<Wired remote controller>

- When pushing **TEST** button on the remote controller for 4 seconds or more, "TEST" is displayed on LC display. Then push **ON/OFF** button.
 - "TEST" is displayed on LC display during operation of Test Run.
 - During Test Run, temperature cannot be adjusted but air volume can be selected.
 - In heating and cooling operation, a command to fix the Test Run frequency is output.
 - Detection of error is performed as usual. However, do not use this function except case of Test Run because it applies load on the unit.
- Use either heating or cooling operation mode for [TEST].

NOTE : The outdoor unit does not operate after power has been turned on or for approx. 3 minutes after operation has stopped.
- After a Test Run has finished, push **TEST** button again and check that [TEST] on LC display has gone off. (To prevent a continuous test run operation, 60-minutes timer release function is provided to this remote controller.)

<Wireless remote controller>

(4-way Air Discharge Cassette Type only)

1 Turn off power of the unit.

Remove the adjuster attached with sensors from the ceiling panel. For removing, refer to the Installation manual attached to the ceiling panel. (Be careful to handle the adjuster because cables are connected to the sensor.) Remove the sensor cover from the adjuster. (1 screw)

2 Change ON of Bit [1: TEST] of the sensor P.C. board switch [S003] to OFF.

Mount the sensor cover and mount the adjuster with sensor to the ceiling panel.

Turn on power of the unit.

3 Push **ON/OFF** button on the wireless remote controller and select [COOL] or [HEAT] operation mode using **MODE** button.

(All the display lamps of sensors on the wireless remote controller flash during Test Run.)

- Do not perform Test Run operation in other modes than [HEAT] / [COOL] mode.
- Detection of error is performed as usual.

4 After Test Run operation, push **ON/OFF** button to stop the operation.

5 Turn off power of the unit.

Return Bit [1] of the sensor P.C. board switch [S003] to the original position. (ON @ OFF)

Mount the adjuster with sensors to the ceiling panel.

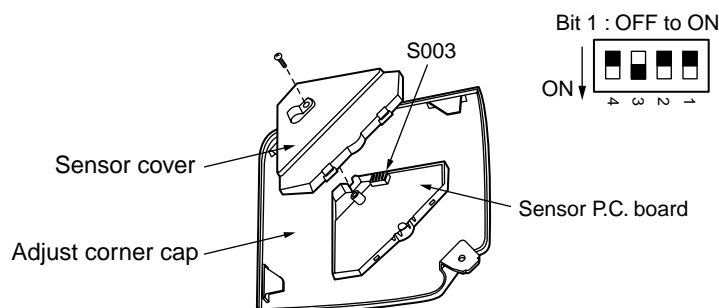



(Except 4-way Air Discharge Cassette Type and Under Ceiling Type)

1 Remove a screw which fixes the serial plate of the receiver part on the wireless remote controller.

Remove the nameplate of the receiver section by inserting a minus screwdriver, etc. into the notch at the bottom of the plate, and set the Dip switch to [TEST RUN ON].

2 Execute a test operation with  button on the wireless remote controller.

- ,  and  LED flash during test operation.
- Under status of [TEST RUN ON], the temperature adjustment from the wireless remote controller is invalid.

Do not use this method in the operation other than test operation because the equipment is damaged.

3 Use either [COOL] or [HEAT] operation mode for test operation.

- The outdoor unit does not operate approx. 3 minutes after power-ON and operation stop.

4 After the test operation finished, stop the air conditioner from the wireless remote controller, and return Dip switch of the sensor section as before.

(A 60 minutes timer clearing function is attached to the sensor section in order to prevent a continuous test operation.)

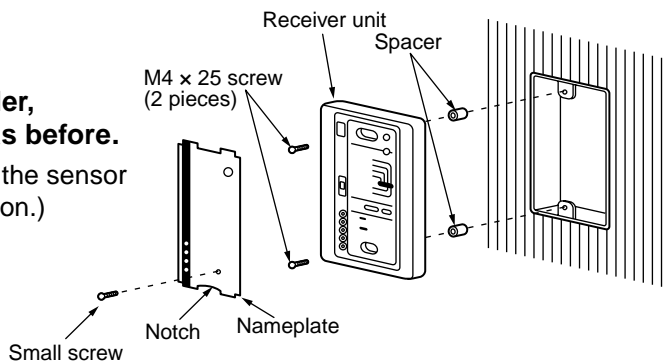

(Under Ceiling Type only)

1 Turn off power of the air conditioner.

Remove the adjust corner cap attached with sensor section from the ceiling panel. For removing method, follow to the installation manual attached to the ceiling panel. (Be careful to handle the sensor section because cables are connected to the sensor section.)

Remove the sensor cover from the adjust corner cap. (1 screw)

2 Change Bit [1: TEST] of the switch [S003] on the sensor P.C. board from OFF to ON.

Mount the sensor cover and attach the adjust corner cap with sensors to the ceiling panel.

Turn on power of the air conditioner.

3 Push  button of the wireless remote controller and select an operation mode [COOL] or [HEAT] with  button. (All the display lamps of the wireless remote controller sensor section flash during the test operation.)

- Do not use operation mode other than [COOL] or [HEAT].
- Error is detected as usual.

4 When the test operation has finished, push button to stop the operation.

5 Turn off power of the air conditioner.

Change Bit [1] of the switch [S003] on the sensor P.C. board from ON to OFF. Attach the adjust corner cap with sensors to the ceiling panel.

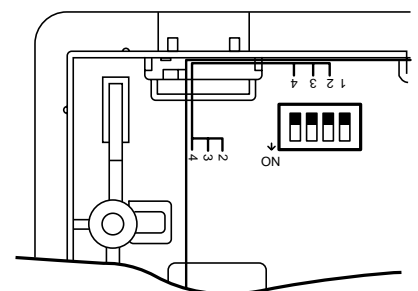

<In case of wireless remote controller>

Procedure	Description	
1	Turn on power of the air conditioner.	
	The operation is not accepted for 5 minutes when power has been turned on at first time after installation, and 1 minute when power has been turned on at the next time and after. After the specified time has passed, perform a test operation.	
2	Push [Start/Stop] button and change the operation mode to [COOL] or [HEAT] with [Mode] button. Then change the fan speed to [High] using [Fan] button.	
3	Test cooling operation	Test heating operation
	Set temperature to [18°C] using [Temperature set] button.	Set temperature to [30°C] using [Temperature set] button.
4	After checking the receiving sound "Pi", immediately push [Temperature set] button to set to [19°C]	After checking the receiving sound "Pi", immediately push [Temperature set] button to set to [29°C].
5	After checking the receiving sound "Pi", immediately push [Temperature set] button to set to [18°C].	After checking the receiving sound "Pi", immediately push [Temperature set] button to set to [30°C].
6	Then repeat the procedure 4 → 5 → 4 → 5 .	
	After approx. 10 seconds, all the display lamps on the sensor part of wireless remote controller, [Operation] (Green), [Timer] (Green), and [Ready] (Yellow) flash and the air conditioner starts operation. If the lamps do not flash, repeat the procedure 2 and after.	
7	After the test operation, push [Start/Stop] button to stop the operation.	

<Outline of test operation from the wireless remote controller>

Test cooling operation:

Start → 18°C → 19°C → 18°C → 19°C → 18°C → 19°C → 18°C → (Test operation) → Stop

Test heating operation:

Start → 30°C → 29°C → 30°C → 29°C → 30°C → 29°C → 30°C → (Test operation) → Stop

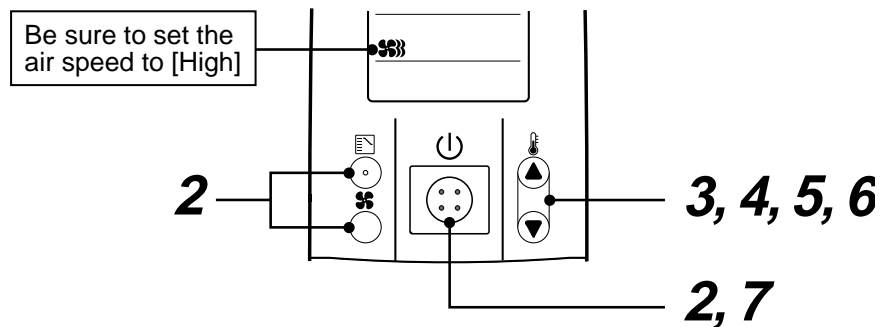

Item No. (DN) table (Selection of function)

DN	Item	Description	At shipment
01	Filter sign lighting time	0000 : None 0002 : 2500H (4-Way/Duct/Ceiling Type)	0002 for D.I. and S.D.I. models
02	Dirty state of filter	0000 : Standard 0001 : High degree of dirt (Half of standard time)	0000 : Standard
03	Central control address	0001 : No.1 unit to 0064 : No.64 unit 0099 : Unfixed	0099 : Unfixed
06	Heating suction temp shift	0000 : No shift to 0001 : +1°C 0002 : +2°C to 0010 : -10°C (Up to recommendation + 6)	0002 : +2°C (Floor type 0000: 0°C)
0F	Cooling only	0000 : Heat pump to 0001 : Cooling only (No display of [AUTO] [HEAT])	0000 : Shared for cooling/heating
10	Type	0001 : SM563/803/1103/1403UT, SP1102UT type 0004 : SM562/802/1102/1402BT type 0007 : SM562/802/1102/1402CT type	According to model type
11	Indoor unit capacity	0000 : Unfixed to 0012 : 80 type 0009 : 56 type to 0017 : 140 type 0015 : 110 type	According to capacity type
12	Line address	0001 : No.1 unit to 0030 : No.30 unit	0099 : Unfixed
13	Indoor unit address	0001 : No.1 unit to 0064 : No.64 unit	0099 : Unfixed
14	Group address	0000 : Individual to 0001 : Master of group 0002 : Sub of group	0099 : Unfixed
19			
1E	Temp difference of automatic cooling/heating mode selection COOL → HEAT, HEAT → COOL	0000 : 0 deg to 0010 : 10 deg (For setup temperature, reversal of COOL/HEAT by ± (Data value)/2)	0003 : 3 deg (Ts±1.5)
28	Automatic restart of power failure	0000 : None to 0001 : Restart	0000 : None
2A	Option		0002 : Default
2b	Thermo output selection (T10 ③)	0000 : Indoor thermo ON 0001 : Output of outdoor comp-ON receiving	0000: Thermo. ON
2E	Option		0000 : Default
30	Option		0000 : Default
31	Option		0000 : Default
32	Sensor selection	0000 : Body TA sensor to 0001 : Remote controller sensor	0000 : Body sensor
33	Temperature indication	0000 : °C (celsius) to 0001 : °F (Fahrenheit)	0000 : °C
40	Option		0003 : Default
5d	High ceiling selection (Air volume selection)	0000 : Standard filter 0001 : Oil guard, Super-long life, Optical regenerative deodorization 0003 : High performance (65%), High performance (90%), High antibacterial performance (65%)	0000 : Standard
60	Timer set (Wired remote controller)	0000 : Available (Operable) to 0001 : Unavailable (Operation prohibited)	0000 : Available
8b	Correction of high heat feeling	0000 : None to 0001 : Correction	0000 : None

12-1-2. Cabling and Setting of Remote Controller Control

2-remote controller control (Controlled by two remote controllers)

One or multiple indoor units are controlled by two remote controllers.
(Max. 2 remote controllers are connectable.)

• 1 indoor unit is controlled by 2 remote controllers

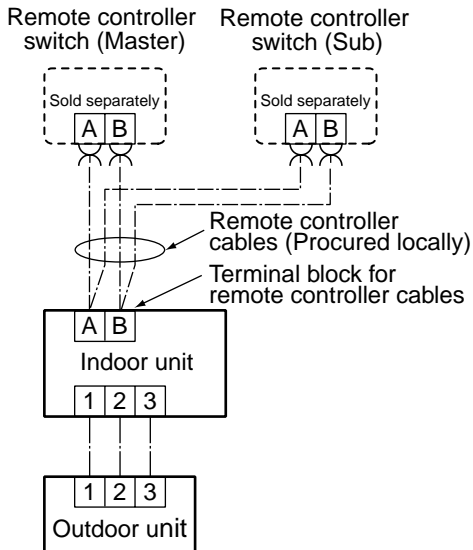

(Setup method)

One or multiple indoor units are controlled by two remote controllers.
(Max. 2 remote controllers are connectable.)

<Wired remote controller>

How to set wired remote controller as sub remote controller

Change DIP switch inside of the rear side of the remote controller switch from remote controller master to sub. (In case of RBC-AMT31E)

Remote controller (Inside of the rear side)

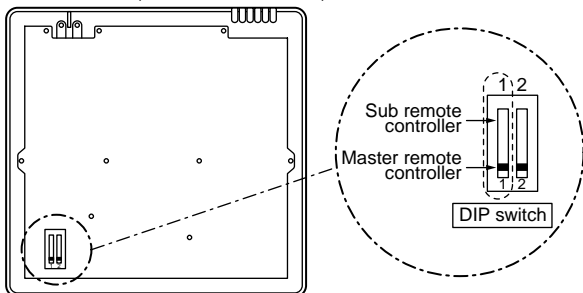

<Wireless remote controller>

(4-Way Air Discharge Cassette Type only)

How to set wireless remote controller to sub remote controller

Change OFF of Bit [3: Remote controller Sub/Master] of switch S003 to ON.

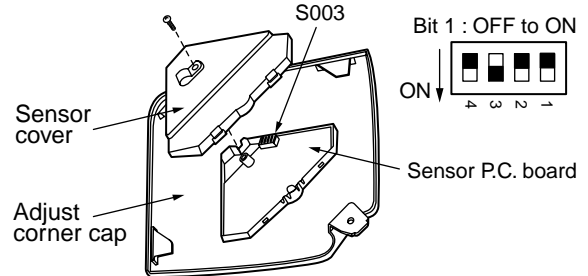

[Operation]

1. The operation contents can be changed by Last-push-priority.
2. Use a timer on either Master remote controller or Sub remote controller.

<Wireless remote controller>

(Except 4-Way Air Discharge Cassette Type and Under Ceiling Type)

How to set wireless remote controller as sub remote controller

Turn Bit [3: Remote controller Sub/Master] of the switch S003 from OFF to ON.

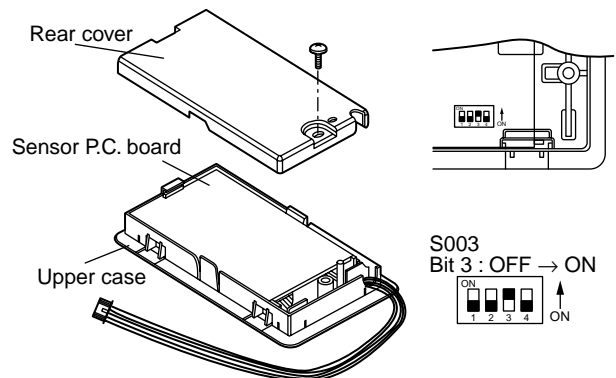

<Wireless remote controller> (Under Ceiling Type only)

How to set wireless remote controller to sub remote controller

Change OFF of Bit [3: Remote controller Sub/Master] of switch S003 to ON.

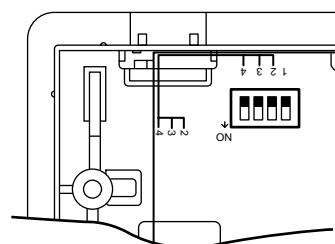

12-1-3. Monitor Function of Remote Controller Switch

■ Call of sensor temperature display

<Contents>

Each sensor temperature of the remote controller, indoor unit, and outdoor unit can become known by calling the service monitor mode from the remote controller.

<Procedure>

1 Push **CL** + **TEST** buttons simultaneously for 4 seconds or more to call the service monitor mode.
The service monitor goes on, the master indoor unit No. is displayed, and then temperature of the **item code 00** is displayed.

2 Push the temperature setup **TEMP** / **TEMP** buttons to select the sensor No. (Item code) of the sensor to be monitored.

The sensor numbers are described below:

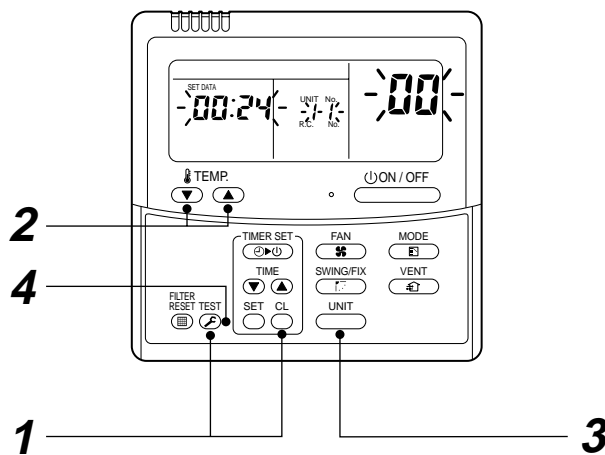

<Operation procedure>

1 → 2 → 3 → 4

Returned to usual display

	Item code	Data name		Item code	Data name
Indoor unit data	00	Room temp. (control temp.) *1	Outdoor unit data	60	Heat exchanger temp. TE
	01	Room temp. (remote controller)		61	Outside temp. TO
	02	Room temp. (TA)		62	Discharge temp. TD
	03	Heat exchanger temp. (TCJ)		63	Suction temp. TS
	04	Heat exchanger temp. (TC)		64	—
			65	Heat sink temp. THS	

*1 Only master unit in group control

3 The temperature of indoor units and outdoor unit in a group control can be monitored by pushing **UNIT** button to select the indoor unit to be monitored.

4 Pushing **TEST** button returns the display to usual display.

■ Calling of error history

<Contents>

The error contents in the past can be called.

<Procedure>

- 1 Push **CL** + **TEST** buttons simultaneously for 4 seconds or more to call the service check mode.

Service Check goes on, the **item code 01** is displayed, and then the content of the latest alarm is displayed. The number and error contents of the indoor unit in which an error occurred are displayed.

- 2 In order to monitor another error history, push the **set temperature** **▼** / **▲** buttons to change the error history No. (Item code).

Item code **01** (Latest) → Item code **04** (Old)

NOTE : Four error histories are stored in memory.

- 3 Pushing **TEST** button returns the display to usual display.

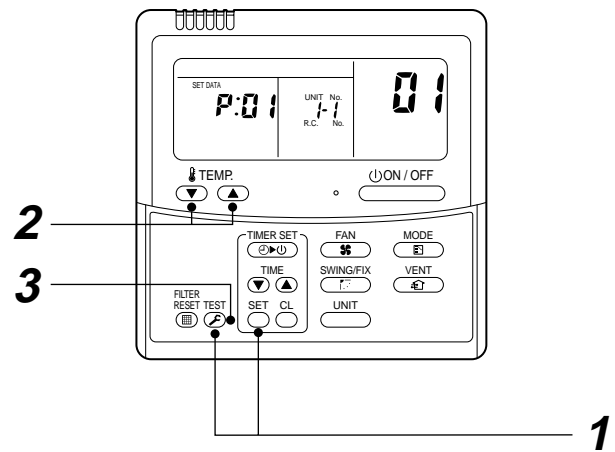

<Operation procedure>

1 → 2 → 3

Returned to usual display

<Requirement>

Do not push **CL** button, otherwise all the error histories of the indoor unit are deleted.

(Group control operation)

In a group control, operation of maximum 8 indoor units can be controlled by a remote controller.

The indoor unit connected with outdoor unit (Individual/Master of twin) controls room temperature according to setting on the remote controller.

<System example>

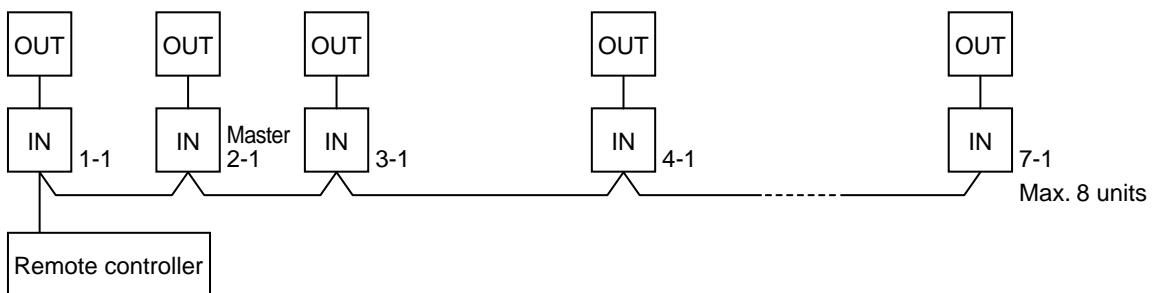

1. Display range on remote controller

The setup range (Operation mode/Air volume select/Setup temp) of the indoor unit which was set to the master unit is reflected on the remote controller.

2. Address setup

Turn on power of the indoor unit to be controlled in a group within 3 minutes after setting of automatic address.

If power of the indoor unit is not turned on within 3 minutes (completion of automatic address setting), the system is rebooted and the automatic address setting will be judged again.

- 1) Connect 3 In/Out cables surely.
- 2) Check line address/indoor address/group address of the unit one by one.
- 3) The unit No. (line/indoor gout address) which have been set once keep the present status as a rule if the unit No. is not duplicated with one of another unit.

12-2. Setup at Local Site / Others

Model name: TCB-PCNT30TLE2

12-2-1. TCC-LINK Adapter (For TCC-LINK Central Control)

1. Function

This model is an optional P.C. board to connect the indoor unit to TCC-LINK (Central controller).

2. Microprocessor Block Diagram

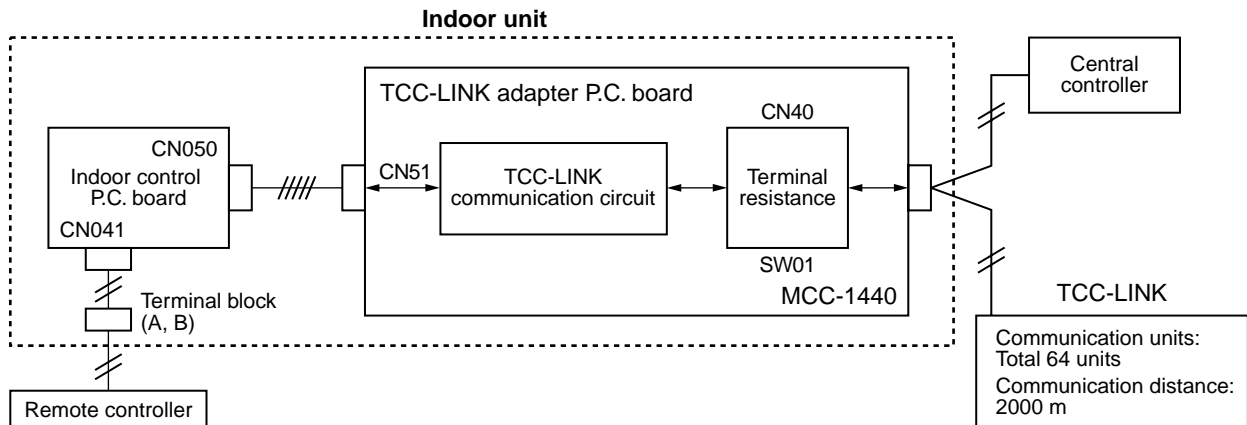

3. TCC-LINK Wiring Connection

CAUTION

- 1) When controlling customized setup collectively, TCC-LINK adapter (This option) is required.
- 2) In case of group operation or twin/triple operation, the adapter is necessary to be connected to the main unit.
- 3) Connect the central control devices to the central control system wiring.
- 4) When controlling collectively customized setup only, turn on only Bit 1 of SW01 of the least line of the system address No. (OFF when shipped from the factory)

*** In case of customized setup, the address is necessary to be set up again from the wired remote controller after automatic addressing.**

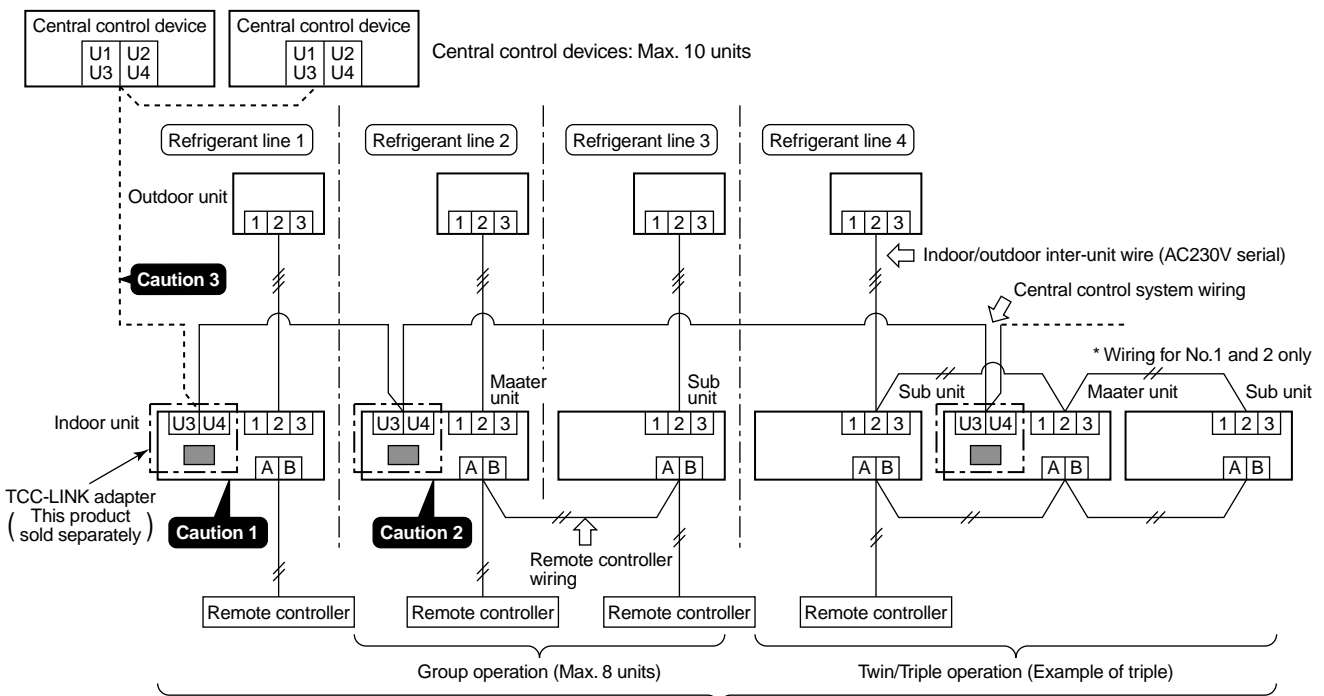

Indoor units in all refrigerant lines: Max. 64 units
 [If mixed with multi model (Link wiring), multi indoor units are included.]
 * However group sub units and twin/triple sub units of customized setup are not included in number of the units.

4. Wiring Specifications

- Use 2-core with no polar wire.
- Match the length of wire to wire length of the central control system.

If mixed in the system, the wire length is lengthened with all indoor/outdoor inter-unit wire length at side.

- To prevent noise trouble, use 2-core shield wire.
- Connect the shield wire by closed-end connection and apply open process (insulating process) to the last terminal.
- Ground the earth wire to 1 point at indoor unit side. (In case of central controlling of digital inverter unit setup)

No. of wires	Size
2	Up to 1000m: twisted wire 1.25mm ² Up to 2000m: twisted wire 2.0mm ²

CAUTION

- 1) Closed-end connection of shield wire (Connect all the connecting parts of each indoor unit)
- 2) Apply open process to the last terminal (insulating process).
- 3) Ground earth wire to 1 point at indoor unit side.

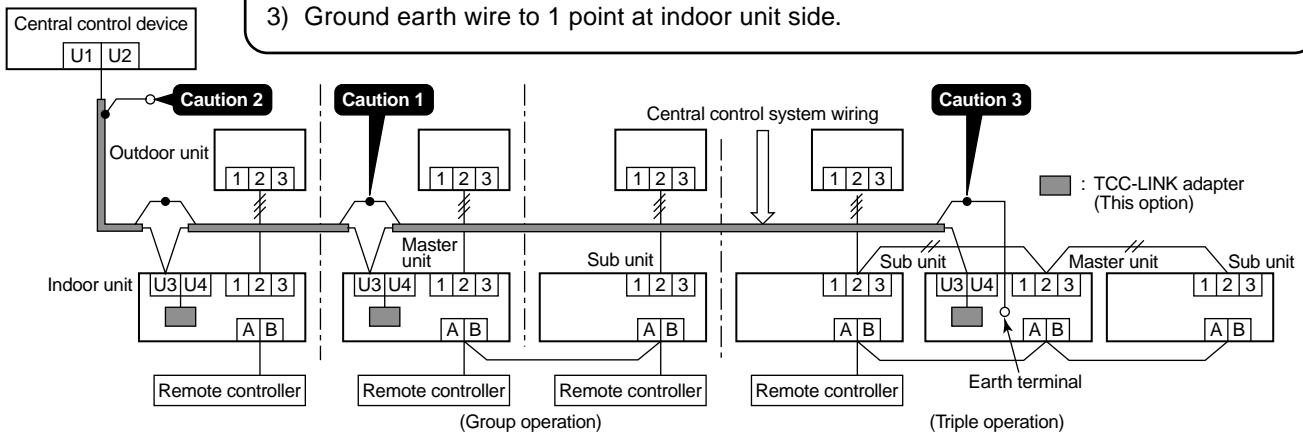

5. P.C. Board Switch (SW01) Setup

When performing collective control by customized setup only, the setup of terminator is necessary.

- Using SW01, set up the terminator.
- Set up the terminator to only the adapter connected to the indoor unit of least line address No.

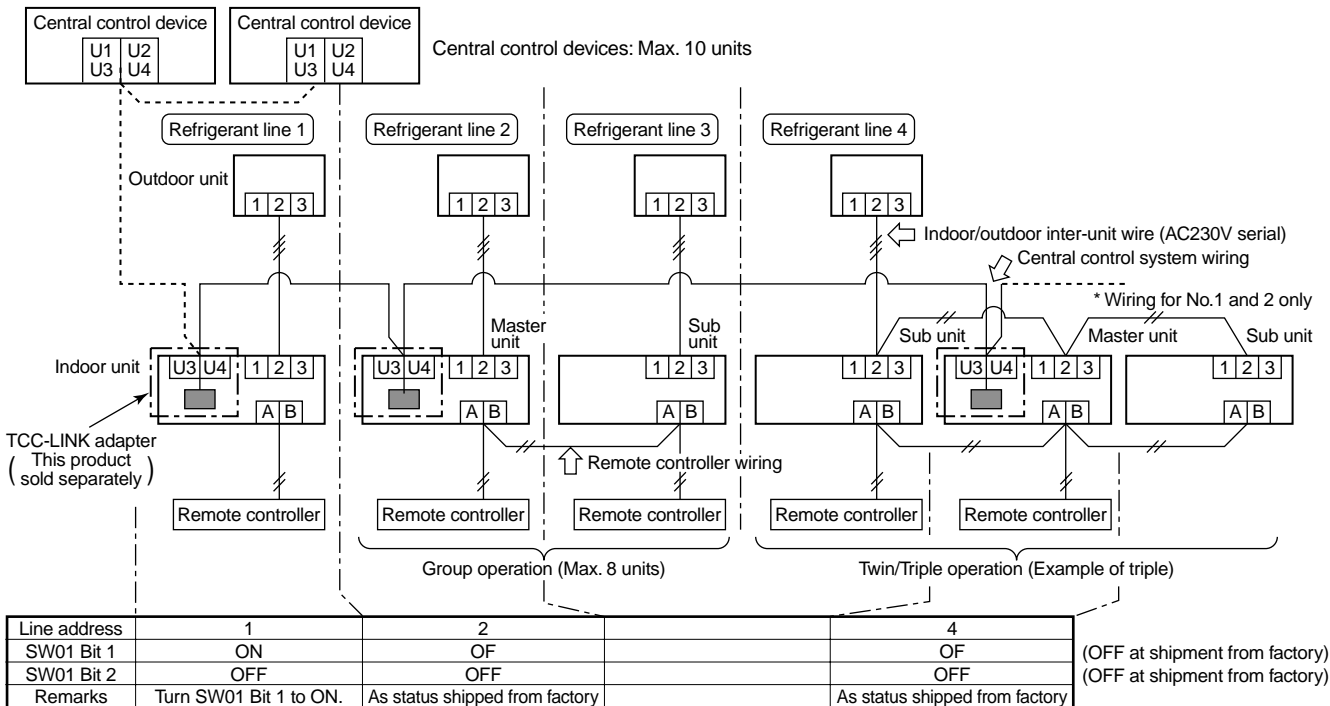

(Reference) Setup contents of switch

SW01		Terminator	Remarks
Bit 1	Bit 2		
OFF	OFF	None	Mixed with multi (Link wiring) at shipment from factory
ON	OFF	100Ω	Central control by digital inverter only
OFF	ON	75Ω	Spare
ON	ON	43Ω	Spare

6. External View of P.C. Board

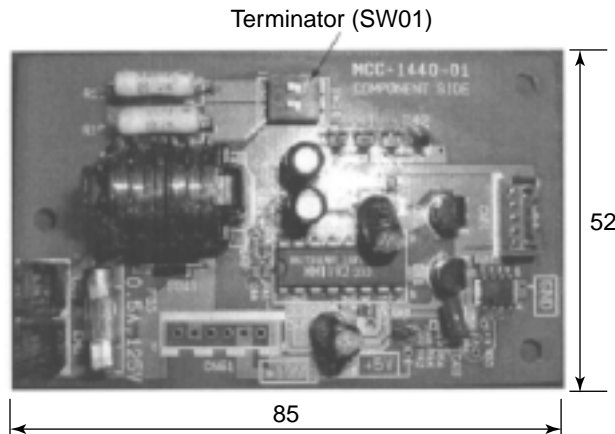

7. Address Setup

In addition to set up the central control address, it is necessary to change the indoor unit number. (Line/Indoor/Group address).

For details, refer to TCC-LINK Adapter Installation Manual.

12-3. How to set up central control address number

When connecting the indoor unit to the central control remote controller using TCC-LINK adapter, it is necessary to set up the central control address number.

- The central control address number is displayed as the line No. of the central control remote controller.

1. Setup from remote controller at indoor unit side

* If you use the network adapter P.C. board, it is effective only when No. 7 of setup switch SW01 on P.C. board is turned off.

<Procedure> Perform setup while the unit stops.

1 Push + buttons for 4 seconds or more.

When group control is executed, first the unit No. *RLU* is displayed and all the indoor units in the group control are selected. In this time, fans of all the selected indoor units are turned on. (Fig. 1)

(Keep *RLU* displayed status without pushing button.)

In case of individual remote controller which is not group-controlled, Line address and Indoor unit address are displayed.

2 Using temperature setup buttons, specify item code 03.

3 Using timer time buttons, select the setup data. The setup data is shown in the right table (Table 1).

4 Push button. (OK if display goes on.)

- To change the item to be set up, return to Procedure 2.

5 Push button.

The status returns to usual stop status.

(Table 1)

Setup data	Central control address No.
0001	1
0002	2
0003	3
⋮	⋮
0064	64
0099	Unset (Setup at shipment from factory)

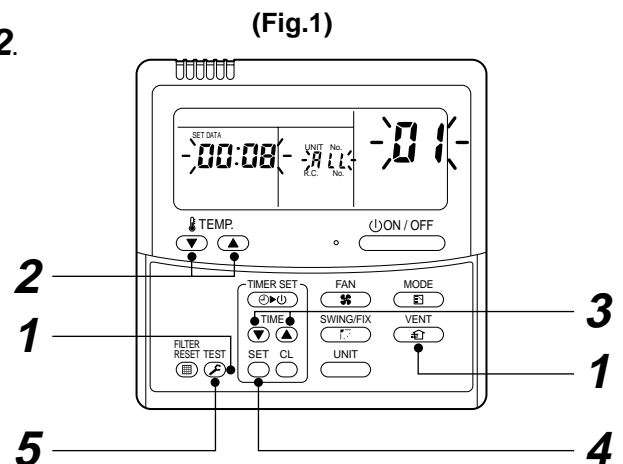

13. ADDRESS SETUP

13-1. Address Setup

<Address setup procedure>

When an outdoor unit and an indoor unit are connected, or when an outdoor unit is connected to each indoor unit respectively in the group operation even if multiple refrigerant lines are provided, the automatic address setup completes with power-ON of the outdoor unit. The operation of the remote controller is not accepted while automatic address works. (Approx. 4 to 5 minutes)

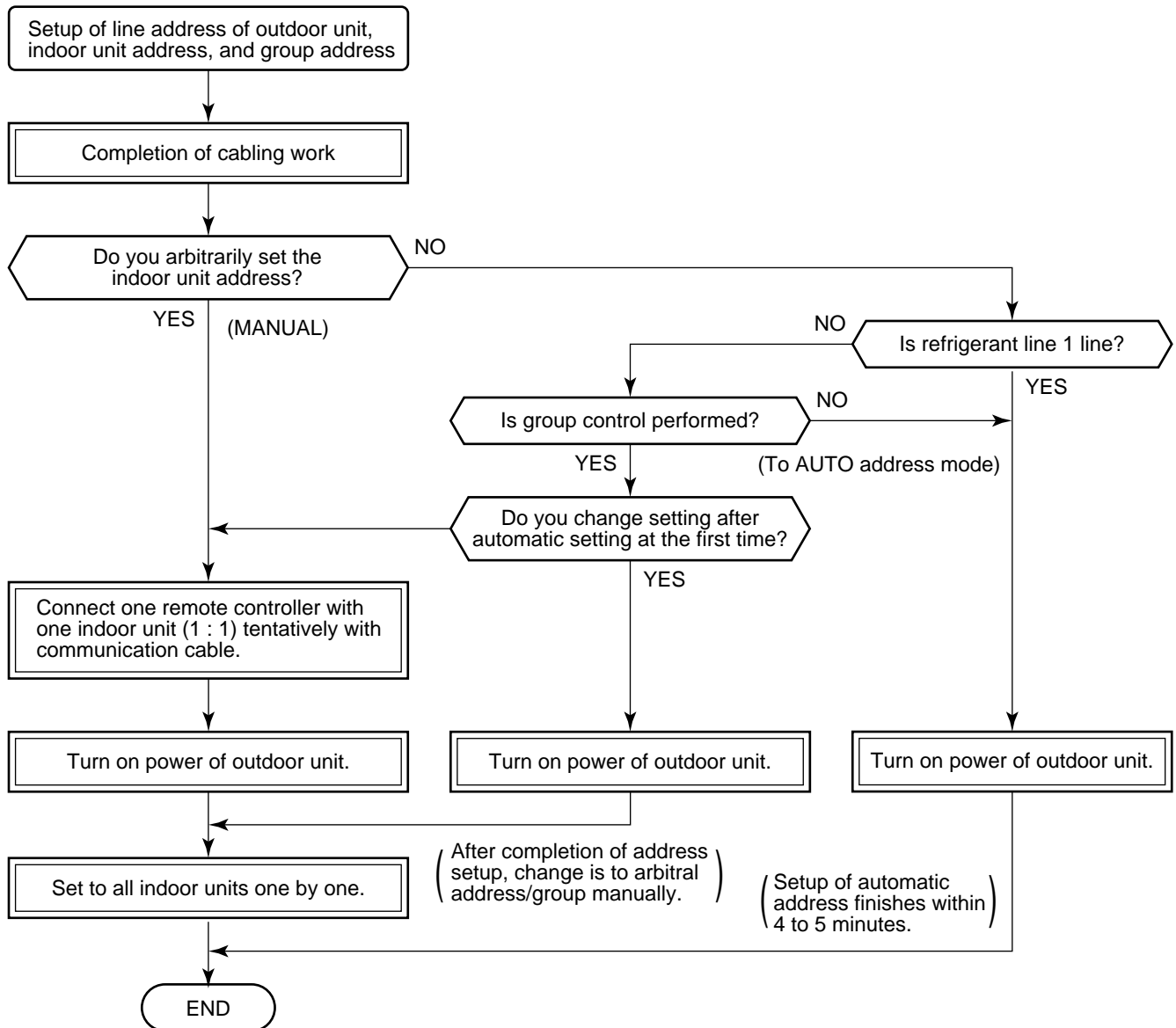

- When the following addresses are not stored in the neutral memory (IC10) on the indoor P.C. board, a test run operation cannot be performed. (Unfixed data at shipment from factory)

	Item code	Data at shipment	Setup data range
Line address	12	0099	0001 (No. 1 unit) to 0030 (No. 30 unit)
Indoor unit address	13	0099	0001 (No. 1 unit) to 0030 (No. 30 unit) Max. value of indoor units in the identical refrigerant line (Double twin = 4)
Group address	14	0099	0000 : Individual (Indoor units which are not controlled in a group) 0001 : Master unit (1 indoor unit in group control) 0002 : Sub unit (Indoor units other than master unit in group control)

13-2. Address Setup & Group Control

<Terminology>

Indoor unit No. : N - n = Outdoor unit line address N (Max. 30) - Indoor unit address n (Max. 64)

Group address : 0 = Individual (Not group control)
 1 = Master unit in group control
 2 = Sub unit in group control

Master unit (= 1) : The representative of multiple indoor units in group operation sends/receives signals to/from the remote controllers and sub indoor units. (* It has no relation with an indoor unit which communicates serially with the outdoor units.)

The operation mode and setup temperature range are displayed on the remote controller LCD. (Except sir direction adjustment of louver)

Sub unit (= 2) : Indoor units other than master unit in group operation

Basically, sub units do not send/receive signals to/from the remote controllers. (Except errors and response to demand of service data)

13-2-1. System configuration

1. Single

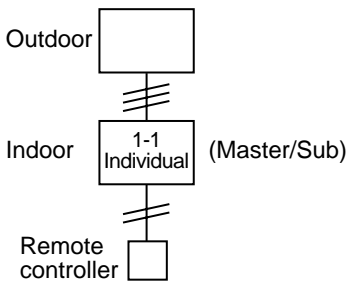

2. Single group operation

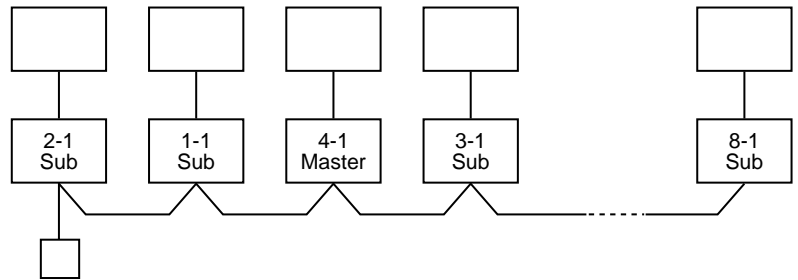

13-2-2. Automatic address example from unset address (No miscabling)

1. Standard (One outdoor unit)

1) Single

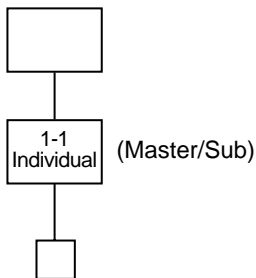

2) Gr operation

(Multiple outdoor units = Multiple indoor units only with serial communication)

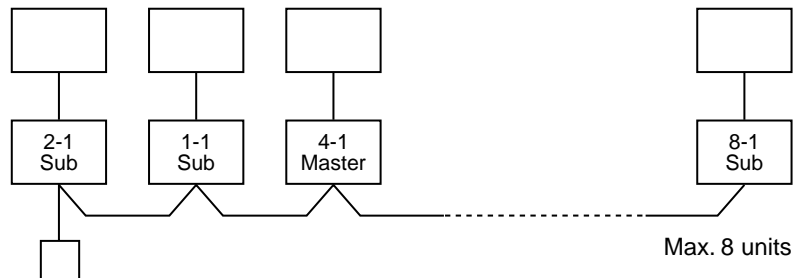

Only turning on source power supply (Automatic completion)

13-3. Address Setup

In case that addresses of the indoor units will be determined prior to piping work after cabling work
(Manual setting from remote controller)

<Address setup procedure>

- Set an indoor unit per a remote controller.
- Turn on power supply.

(Example of 2-lines cabling)
(Real line: Cabling, Broken line: Refrigerant pipe)

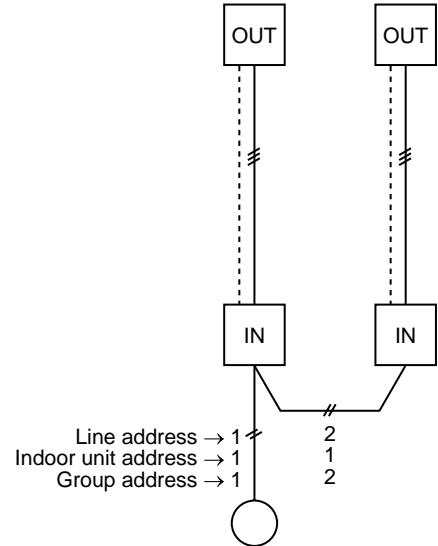

- 1** Push **SET** + **CL** + **TEST** buttons simultaneously for 4 seconds or more.
- 2** (← Line address)
Using the temperature setup **▼** / **▲** buttons, set **12** to the item code.
- 3** Using timer time **▼** / **▲** buttons, set the line address.
- 4** Push **SET** button. (OK when display goes on.)
- 5** (← Indoor unit address)
Using the temperature setup **▼** / **▲** buttons, set **13** to the item code.
- 6** Using timer time **▼** / **▲** buttons, set **1** to the line address.
- 7** Push **SET** button. (OK when display goes on.)
- 8** (← Group address)
Using the temperature setup **▼** / **▲** buttons, set **14** to the item code.
- 9** Using timer time **▼** / **▲** buttons, set **0000** to Individual, **0001** to Master unit, and **0002** to sub unit.
- 10** Push **SET** button. (OK when display goes on.)
- 11** Push **TEST** button.
Setup completes. (The status returns to the usual stop status.)

For the above example, perform setting by connecting singly the wired remote controller without remote controller inter-unit cable.

Group address
Individual : 0000
Master unit : 0001
Sub unit : 0002 } In case of group control

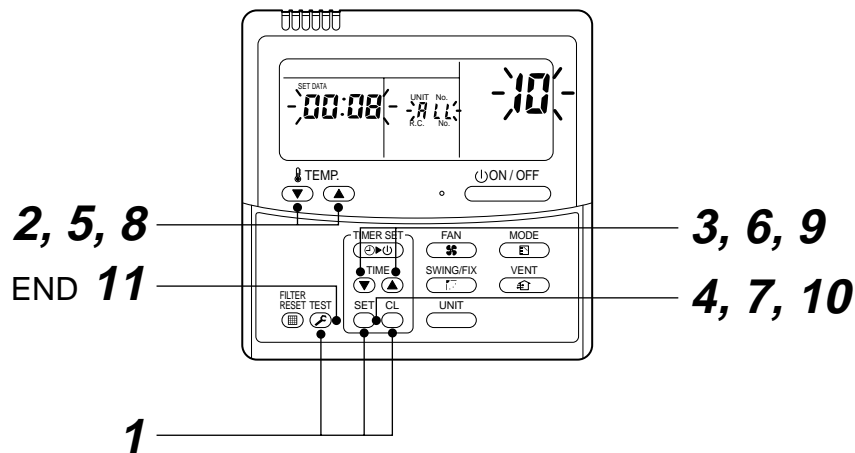

<Operation procedure>

1 → 2 → 3 → 4 → 5 → 6 → 7 → 8 → 9 → 10 → 11 END

■ Confirmation of indoor unit No. position

1. To know the indoor unit addresses though position of the indoor unit body is recognized

- In case of individual operation (Wired remote controller : indoor unit = 1 : 1)
(Follow to the procedure during operation)

<Procedure>

1 Push  button if the unit stops.

2 Push  button.

Unit No. *1-1* is displayed on LCD.

(It disappears after several seconds.)

The displayed unit No. indicate line address and indoor unit address.

(When other indoor units are connected to the identical remote controller (Group control unit), other unit numbers are also displayed every pushing  button.

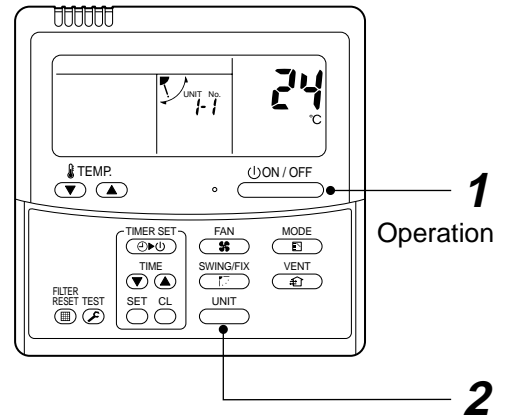

<Operation procedure>



1 → 2 END

2. To know the position of indoor unit body by address

- To confirm the unit No. in the group control
(Follow to the procedure during operation) (in this procedure, the indoor units in group control stop.)

<Procedure>

The indoor unit numbers in the group control are successively displayed, and fan, louver, and drain pump of the corresponding indoor unit are turned on.
(Follow to the procedure during operation)

1 Push  and  buttons simultaneously for 4 seconds or more.

- Unit No. *ALL* is displayed.
- Fans and louvers of all the indoor units in the group control operate.

2 Every pushing  button, the unit numbers in the group control are successively displayed.

- The unit No. displayed at the first time indicates the master unit address.
- Fan and louver of the selected indoor unit only operate.

3 Push  button to finish the procedure.
All the indoor units in the group control stop.

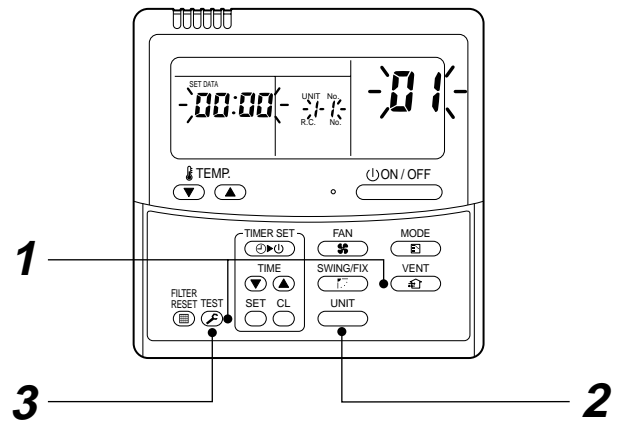

<Operation procedure>

1 → 2 → 3 END



14. DETACHMENTS

14-1. Indoor Unit

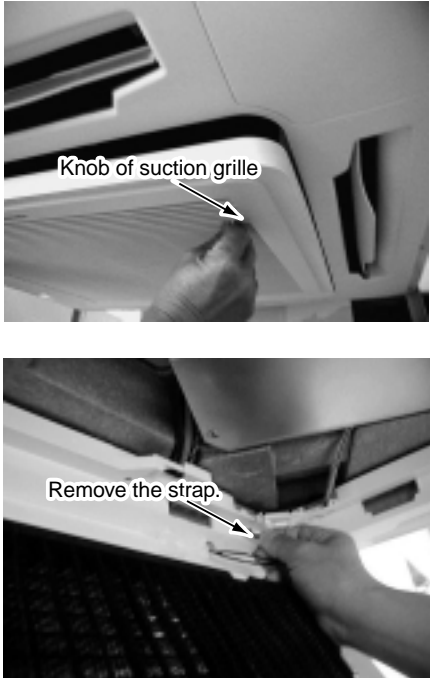
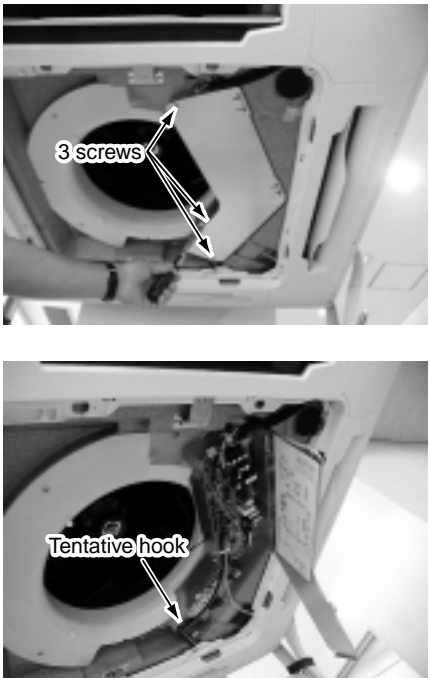

14-1-1. 4-Way Air Discharge Cassette Type

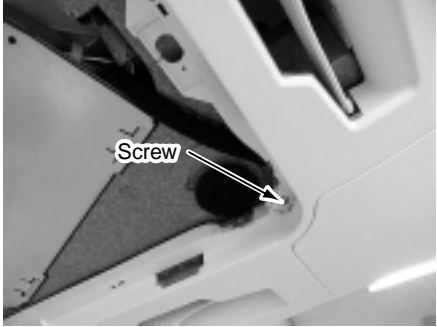
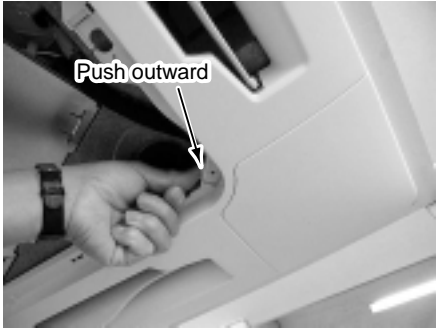
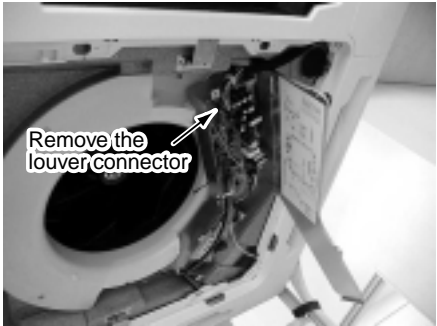
RAV-SM563UT-E, RAV-SM803UT-E, RAV-SM1103UT-E, RAV-SM1403UT-E
RAV-SP1102UT-E

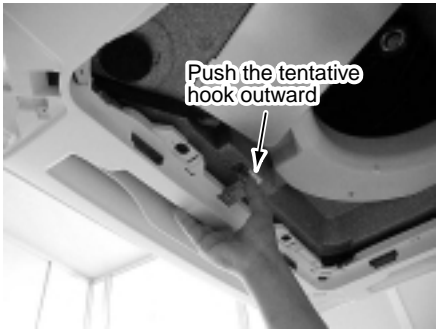
No.	Part name	Procedure	Remarks
①	Suction grille	<p style="text-align: center;">REQUIREMENT</p> <p>Never forget to put on the gloves at disassembling work, otherwise an injury will be caused.</p> <p>1. Detachment</p> <ol style="list-style-type: none"> 1) Stop operation of the air conditioner, and then turn off switch of the breaker. 2) Hang down the suction grille while sliding two knobs of the suction grille inward. 3) Remove a strap connecting the panel and the suction grille to remove the suction grille. <p>2. Attachment</p> <ol style="list-style-type: none"> 1) Hang the suction grille to the panel. 2) Attach the strap of the suction grille to the panel as before. 3) Close the suction grille, slide the knobs outward, and then fix it. 	
②	Electric parts cover	<p>1. Detachment</p> <ol style="list-style-type: none"> 1) Perform work of item 1. of ①. 2) Remove screws fixing the electric parts cover. (Ø4 × 10, 3 pcs.) 3) Remove the electric parts cover from the tentative hook, and then open the cover. <p>2. Attachment</p> <ol style="list-style-type: none"> 1) Close the electric parts cover and hang the cover hole to the tentative hook. 2) Tighten the fixing screws. (Ø4 × 10, 3 pcs.) 	

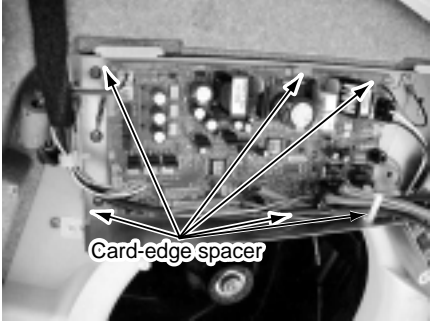
No.	Part name	Procedure	Remarks
③	Adjust corner cap	<p>1. Detachment</p> <ol style="list-style-type: none"> 1) Perform work of item 1. of ①. 2) Remove screws at 4 corners of the suction port. (Ø4 × 10, 4 pcs.) 3) Push the knob outward and remove the adjust corner cap by sliding it. <p>2. Attachment</p> <ol style="list-style-type: none"> 1) Mount the adjust corner cap by sliding it inward. 2) Tighten screws at 4 corners of the suction port. (Ø4 × 10, 4 pcs.) 	 <p>Screw</p>  <p>Push outward</p>
④	Ceiling panel	<p>1. Detachment</p> <ol style="list-style-type: none"> 1) Perform works of items 1 of ①, 1 of ② and 1 of ③. 2) Remove the louver connector (CN33, White, 5P) connected to the control P.C. board, and then remove the lead wire from the clamp. <div style="border: 1px solid black; padding: 5px; margin: 10px 0;"> <p>NOTE : Remove the connector by releasing locking of the housing.</p> </div> <ol style="list-style-type: none"> 3) Remove screws fixing the ceiling panel. (M5, 4 pcs.) 4) Push the tentative hook outward to remove the ceiling panel. <p>2. Attachment</p> <ol style="list-style-type: none"> 1) Hang the tentative hook of the main body drain pan to the tentative hook of the ceiling panel. <div style="border: 1px solid black; padding: 5px; margin: 10px 0;"> <p>NOTE : A panel has directional property, so mount a panel with attention to the marks.</p> </div> <ol style="list-style-type: none"> 2) Tighten fixing screws. (M5, 4 pcs.) 3) Connect louver connector of the ceiling panel to connector (CN33, White, 5P) on the control P.C. board. 	 <p>Remove the louver connector</p>  <p>Fixing screw</p>  <p>Push the tentative hook outward</p>

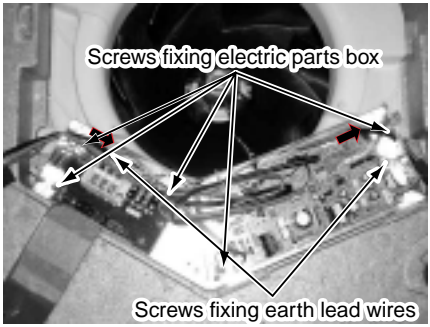
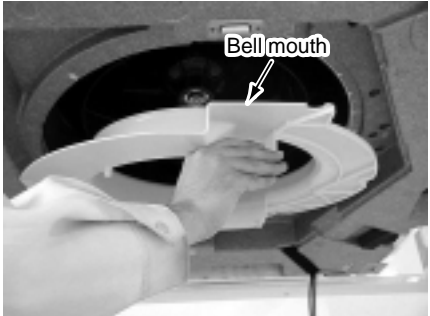
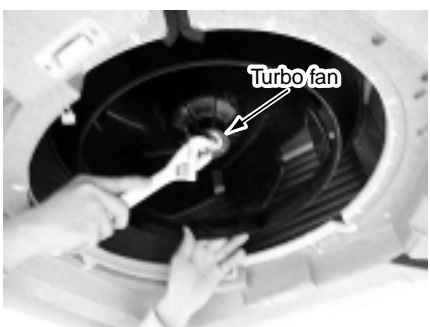
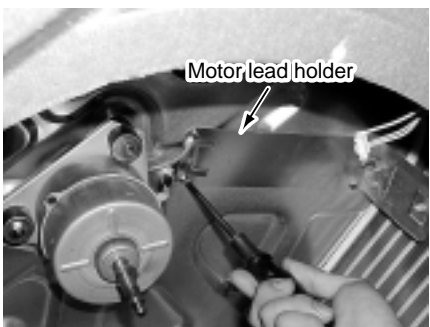
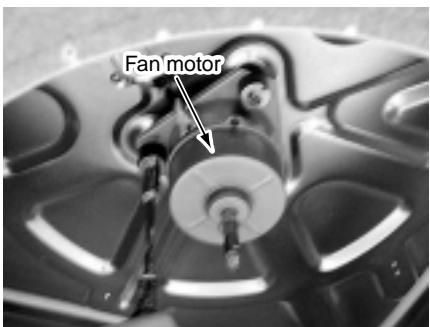
No.	Part name	Procedure	Remarks
⑤	Control P.C. board	<p>1. Detachment</p> <ol style="list-style-type: none"> 1) Perform works of items 1 of ① and 1 of ②. 2) Remove connectors which are connected from the control P.C. board to other parts. <ul style="list-style-type: none"> CN33 : Louver motor (5P: White) CN34 : Float switch (3P: Red) CN41 : Terminal block of remote controller (3P: Blue) CN68 : Drain pump (3P: Blue) CN67 : Terminal block of power supply (5P: Black) CN101: TC sensor (2P: Black) CN102: TCJ sensor (2P: Red) CN104: Room temperature sensor (2P: Yellow) CN333: Power supply of fan motor (5P: White) CN334: Position detection of fan motor (5P: White) <div style="border: 1px solid black; padding: 5px; margin: 10px 0;"> <p>NOTE : Remove the connector by releasing locking of the housing.</p> </div> <ol style="list-style-type: none"> 3) Unlock locking of the card-edge spacer at 6 positions to remove the control P.C. board. <p>2. Attachment</p> <ol style="list-style-type: none"> 1) Fix the control P.C. board to the card-edge spacer at 6 positions. 2) Connect the connectors removed in item 1 to the original positions. 	

No.	Part name	Procedure	Remarks
⑥	Fan motor	<p>1. Detachment</p> <ol style="list-style-type: none"> 1) Perform works of items 1 of ① and 1 of ②. 2) Remove clamps of the lead wires connected to the following connectors of the control P.C. board. CN33 : Louver motor (5P: White) CN34 : Float switch (3P: Red) CN68 : Drain pump (3P: Blue) CN101 : TC sensor (2P: Black) CN102 : TCJ sensor (2P: Red) CN333 : Power supply of fan motor (5P: White) CN334 : Position detection of fan motor (5P: White) <div style="border: 1px solid black; padding: 5px; margin: 10px 0;"> <p>NOTE : Remove the connector by releasing locking of the housing.</p> </div> <ol style="list-style-type: none"> 3) Remove screws fixing earth lead wire in the electric parts box. (Ø4 × 6, 2 pcs.) 4) Remove indoor/outdoor inter-unit cable and remote controller cable of the terminal block. 5) Remove screws fixing the electric parts box. (Ø4 × 10, 5 pcs.) 6) Remove screws fixing the bell mouth. (Ø4 × 10, 6 pcs.) 7) Remove nuts fixing the turbo fan. (M6, 1 pc.) 8) Remove screws fixing holder of the motor lead wires to remove the motor lead wires from the clamp. (Ø4 × 8, 3 pcs.) 9) Remove nuts fixing the fan motor to remove it. <p>2. Attachment</p> <ol style="list-style-type: none"> 1) Fix the parts, fan motor, holder of the motor lead, turbo fan, bell mouth, and electric parts box successively to their original positions. <div style="border: 1px solid black; padding: 5px; margin: 10px 0;"> <p>NOTE 1 : When fixing the turbo fan, be sure to match the fan boss with D-cut of the motor shaft.</p> <p>NOTE 2 : Fix the turbo fan with torque wrench 5.9 ± 0.6Nm.</p> </div> <ol style="list-style-type: none"> 2) Connect connectors, earth lead wire, indoor/outdoor inter-unit cable, and remote controller cable which have been disconnected in the above item 1 as before. 	 <p>Screws fixing electric parts box</p>  <p>Screws fixing earth lead wires</p>  <p>Bell mouth</p>  <p>Turbo fan</p>  <p>Motor lead holder</p>  <p>Fan motor</p>

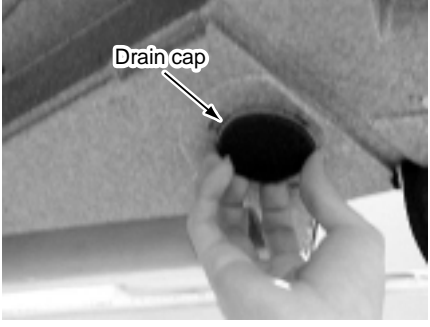
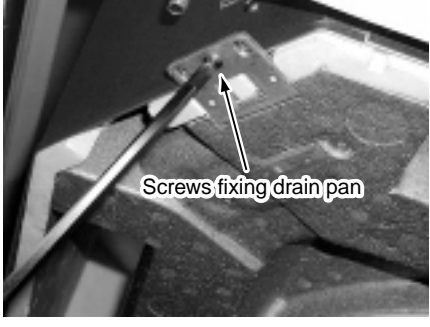
No.	Part name	Procedure	Remarks
⑦	Drain pan	<p>1. Detachment</p> <ol style="list-style-type: none"> 1) Perform works of items 1 of ①, 1 of ②, 1 of ③ and 1 of ④. 2) Remove clamps of the lead wires connected to the following connectors of the control P.C. board. CN34 : Float switch (3P: Red) CN68 : Drain pump (3P: Blue) CN101 : TC sensor (2P: Black) CN102 : TCJ sensor (2P: Red) CN333 : Power supply of fan motor (5P: White) CN334 : Position detection of fan motor (5P: White) <div style="border: 1px solid black; padding: 5px; margin: 10px 0;"> <p>NOTE : Remove the connector by releasing locking of the housing.</p> </div> <ol style="list-style-type: none"> 3) Remove screws fixing earth lead wire in the electric parts box. (Ø4 × 6, 2 pcs.) 4) Remove indoor/outdoor inter-unit cable and remote controller cable of the terminal block. 5) Remove screws fixing the electric parts box. (Ø4 × 10, 5 pcs.) 6) Remove screws fixing the bell mouth. (Ø4 × 10, 6 pcs.) 7) Remove the drain cap, and drain water accumulated in the drain pan. <div style="border: 1px solid black; padding: 5px; margin: 10px 0;"> <p>NOTE 1 : When removing the drain cap, be sure to prepare a bucket to catch the drained water.</p> <p>NOTE 2 : Thermal insulator is adhered to the drain cap. Be careful not to peel off the insulator. If the insulator has been peeled, adhere it with double-face tape, etc. as before.</p> </div> <ol style="list-style-type: none"> 8) Remove screws fixing the drain pan. (Ø4 × 8, 4 pcs.) <p>2. Attachment</p> <ol style="list-style-type: none"> 1) Fix the parts, drain cap, drain pan, bell mouth, and electric parts box successively to their original positions. 2) Connect connectors, earth lead wire, indoor/outdoor inter-unit cable, and remote controller cable which have been disconnected in the above item 1 as before. 	 <p>Screws fixing earth lead wires</p>  <p>Drain cap</p>  <p>Screws fixing drain pan</p>

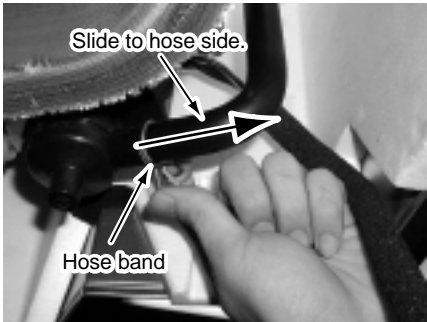
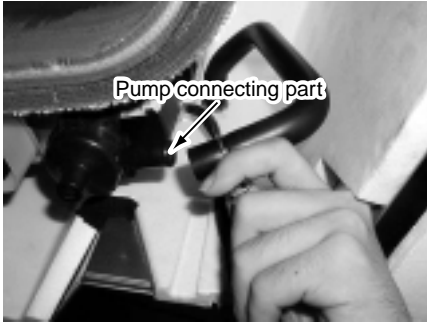
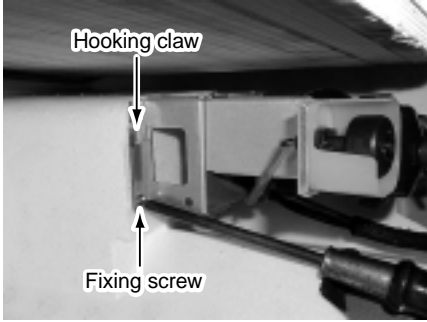
No.	Part name	Procedure	Remarks
⑧	Drain pump assembly	<p>1. Detachment</p> <ol style="list-style-type: none"> 1) Perform works of items 1 of ①, 1 of ②, 1 of ③, 1 of ④ and 1 of ⑦. 2) Picking the hose band, slide it from pump connecting part to remove the drain hose. 3) Remove screw fixing the drain pump assembly, slide hooking claws of the drain pump assembly and the main body (1 position), and then remove the assembly. (Ø4 x 8, 3 pcs.) <p>3. Attachment</p> <ol style="list-style-type: none"> 1) Fix the drain pump assembly as before. <div data-bbox="406 683 954 869" style="border: 1px solid black; padding: 5px; margin-bottom: 10px;"> <p>NOTE : The drain pump is fixed with a hook and 3 screws. In screwing, be sure that screws do not to run on hooking claw at the main body side.</p> </div> <ol style="list-style-type: none"> 2) Attach the drain hose and hose band as before. <div data-bbox="406 974 954 1142" style="border: 1px solid black; padding: 5px;"> <p>NOTE : Insert the drain hose up to the end of pump connecting part, and bind the white mark position of the hose with band.</p> </div>	  

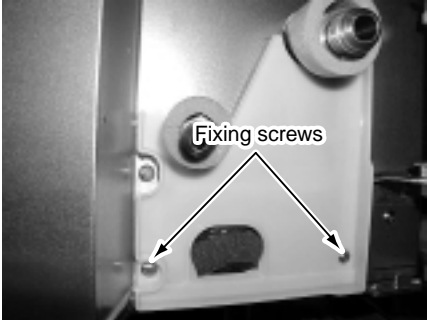
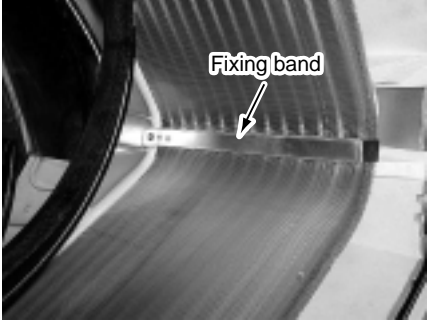
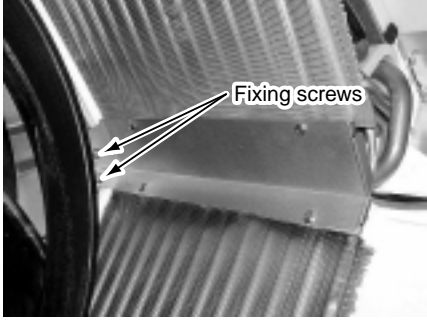
No.	Part name	Procedure	Remarks
⑨	Heat exchanger	<p>1. Detachment</p> <ol style="list-style-type: none"> 1) Recover refrigerant gas. 2) Remove refrigerant pipe at the indoor unit side. 3) Perform works of items 1 of ①, 1 of ②, 1 of ③, 1 of ④ and 1 of ⑦. 4) Remove screws fixing the pipe cover. (Ø4 × 8, 2 pcs.) 5) Remove the heat exchanger by removing fixing band and fixing screws while holding the heat exchanger. (Ø4 × 8, 3 pcs.) <p>2. Attachment</p> <ol style="list-style-type: none"> 1) Fix the parts, heat exchanger, fixing band, pipe cover, drain cap, drain pan, bell mouth, and electric parts box successively to their original positions. 2) Connect connectors, earth lead wire, indoor/outdoor inter-unit cable, and remote controller cable which have been disconnected in the above item 1 as before. 3) Connect the refrigerant pipe as before, and then perform vacuuming. 	  

14-1-2. Concealed Duct Type

RAV-SM562BT-E, RAV-SM802BT-E, RAV-SM1102BT-E, RAV-SM1402BT-E

Be sure to turn off the power supply or circuit breaker before disassembling work

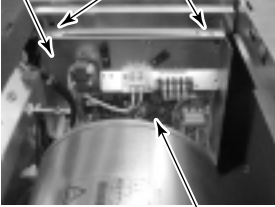
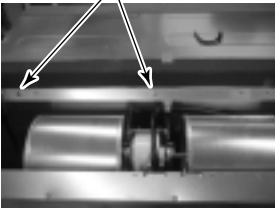
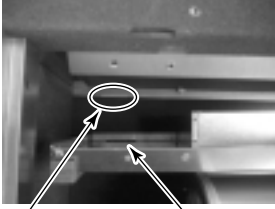
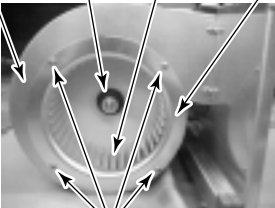
No.	Part name	Procedure	Remarks
①	Electrical parts box	<ol style="list-style-type: none"> 1. Remove the air filter. 2. Remove the set screws (2 positions) of the electrical parts cover. 3. Remove the electrical parts cover. 4. Remove the set screws (2 positions) of the electrical parts box. 5. Remove the electrical parts box. The electrical parts box is fixed to the main unit with claws at the right side. Lift up it once and pull toward you. Then claws come off. <p>In this time, remove connectors of TA sensor, TC sensor and TCJ sensor if necessary.</p>	<p>Screws (Fixing electrical parts cover and box)</p> <p>Electrical parts cover</p>  <p>①-2 ①-3</p> <p>Screws (Fixing electrical parts box and main unit)</p> <p>Electrical parts box</p>  <p>Claw (Reverse side)</p> <p>①-4 ①-5</p>
②	Multi blade fan	<ol style="list-style-type: none"> 1. Remove the air filter. 2. Remove the connector of the fan motor P.C. board. 3. Remove the hexagon head screw (562: 2, 802, 1102, 1402 : 3 positions) of fixing fan assembly and main unit. 4. Remove the fan assembly from main unit. The fan assembly is fixed to the main unit with claws (3 positions) at the upper side. Lift up it once and pull toward rear side. Then claws come off. 5. Remove the set screws (4 positions) of fixing fan case and fan cover. 6. Remove the fan cover. 7. Loosen the sets crew of the Multi blade fan using hexagon wrench. 8. Pull the Multi blade fan towered fan case side. Then fans come off. 	<p>Hexagon head screws (Fixing fan assembly and main unit)</p>  <p>②-3</p>  <p>②-4</p> <p>Fixing claw (Main unit)</p> <p>Fixing hole (Fan assembly)</p> <p>Fan case</p> <p>Multi blade fan</p> <p>Set screw</p> <p>Fan case cover</p>  <p>Screws (Fixing fan case cover)</p> <p>②-5 ②-6</p>

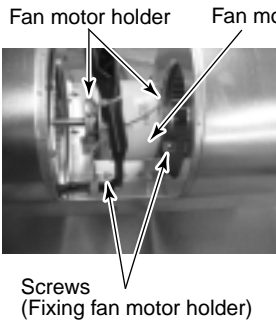
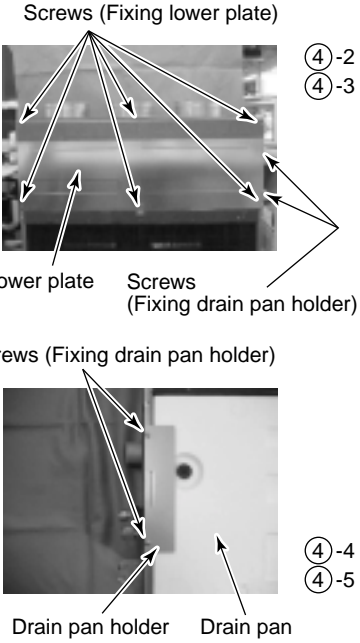
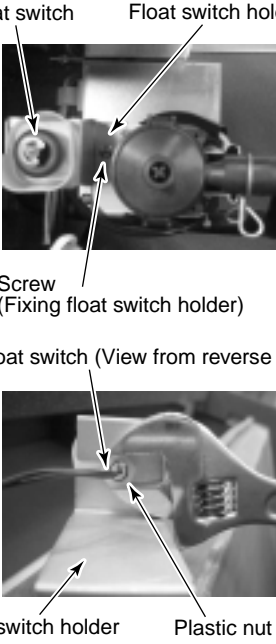
No.	Part name	Procedure	Remarks
③	Fan motor	<ol style="list-style-type: none"> 1. Remove the Multi blade fan. 2. Remove the hexagon head screw of fixing fan motor holder. 3. Remove the fan motor holder (2 positions). 	 <p>Fan motor holder Fan motor</p> <p>Screws (Fixing fan motor holder)</p> <p>③-2 ③-3</p>
④	Drain pan	<ol style="list-style-type: none"> 1. Take down the main unit and then treat the drain pan on the floor. 2. Remove the set screws (562 : 7, 802, 1102, 1402 : 9 positions) of fixing lower plate. 3. Remove the lower plate from main unit. 4. Remove the set screws (562 : Nothing, 802 : 2 positions, 1102, 1402 : 4 positions) of fixing drain pan holder and main unit. 5. Remove the drain pan holder (562 : Nothing, 802 : 1 position, 1102, 1402 : 2 positions) from main unit. 6. Remove the drain pan. Pull it lower side. 	 <p>Screws (Fixing lower plate)</p> <p>Lower plate Screws (Fixing drain pan holder)</p> <p>Screws (Fixing drain pan holder)</p> <p>Drain pan holder Drain pan</p> <p>④-2 ④-3 ④-4 ④-5</p>
⑤	Float switch	<ol style="list-style-type: none"> 1. Remove the drain pan. 2. Remove the set screw (1 position) of fixing float switch holder. 3. Remove the plastics nut of foxing float switch. 4. Remove the float switch. 	 <p>Float switch Float switch holder</p> <p>Screw (Fixing float switch holder)</p> <p>Float switch (View from reverse side)</p> <p>Float switch holder Plastic nut</p> <p>⑤-2 ⑤-3</p>

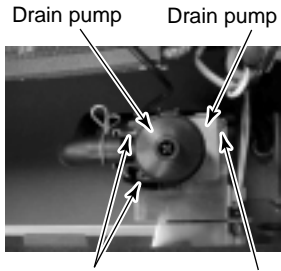
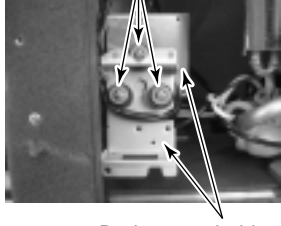
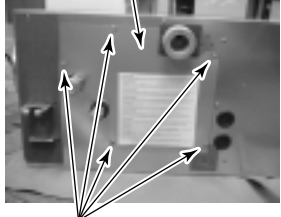
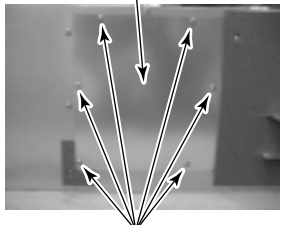
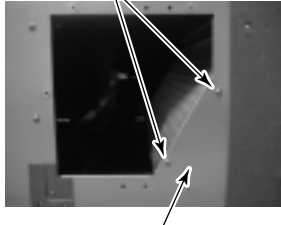
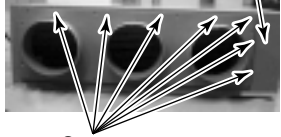
No.	Part name	Procedure	Remarks
⑥	Drain pump	<ol style="list-style-type: none"> 1. Remove the drain pan and float switch. 2. Remove the set screws (3 positions) of fixing drain pump plate and main unit. 3. Remove the set screws (3 positions) of fixing drain pump plate and drain pump. 	 <p>Drain pump Drain pump holder</p> <p>⑥-2</p> <p>Screws (Fixing drain pump holder)</p> <p>Screws (Fixing plate and drain pump)</p>  <p>⑥-3</p> <p>Drain pump holder</p> <p>⑥-3. View from reverse side of drain pump</p>
⑦	TC, TCJ sensor	<ol style="list-style-type: none"> 1. Remove the set screws (5 positions) and check port cover (right side). 2. Pull out the sensor is inserted into pipe of the heat exchanger. 	<p>Checking port cover (Right side)</p>  <p>⑦-1</p> <p>Screws (Fixing check port cover (Right side))</p>
⑧	Heat exchanger	<ol style="list-style-type: none"> 1. Take down the main unit and then treat the heat exchanger on the floor. 2. Remove the drain pan. 3. Remove the check port cover (right side). 4. Remove the set screws (6 positions) and check port cover (left side). 5. Remove the set screws (2 positions) of fixing heat exchanger and main unit (left side). 6. Remove the set screws (7 positions) of fixing heat exchanger and main unit (front right side). 	<p>Check port cover (Left side)</p>  <p>⑧-4</p> <p>Screws (Fixing check port cover (Left side))</p> <p>Screws (Fixing heat exchanger)</p>  <p>⑧-5</p> <p>Main unit (Left side)</p> <p>Main unit (Front side)</p>  <p>⑧-6</p> <p>Screws</p>

14-1-3. Under Ceiling Type

RAV-SM562CT-E, RAV-SM802CT-E, RAV-SM1102CT-E, RAV-SM1402CT-E

Be sure to turn off the power supply or circuit breaker before disassembling work

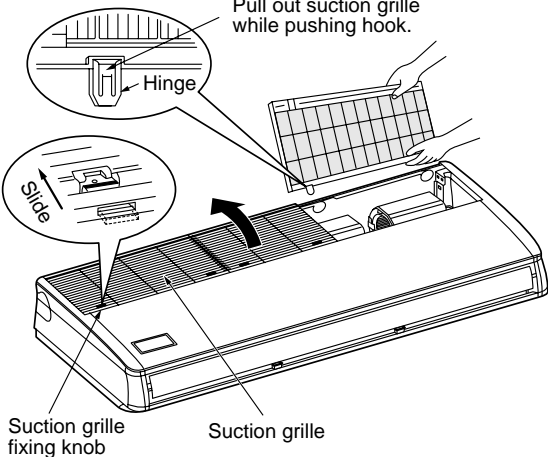
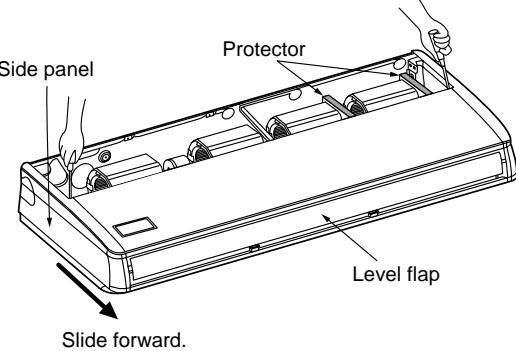
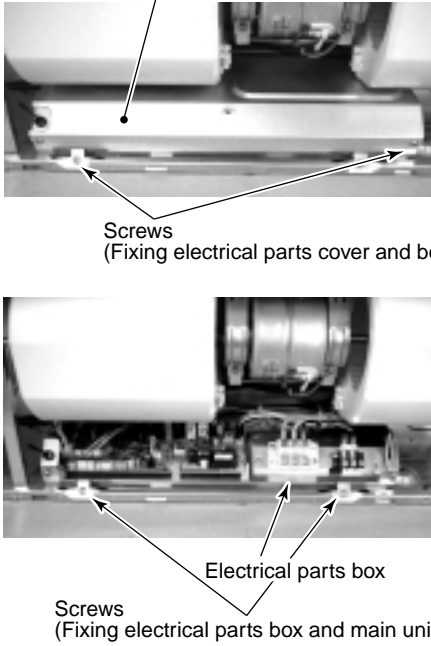
No.	Part name	Procedure	Remarks
①	Suction grille	<ol style="list-style-type: none"> Slide the suction grille fixing knobs (2 positions) toward the arrow direction of left figure, and open the suction grille. Under the condition of the suction grille opened, push the hook section of hinges (2 positions) at the rear side, and then pull out the suction grille. 	 <p>Pull out suction grille while pushing hook.</p> <p>Suction grille fixing knob</p> <p>Suction grille</p>
②	Side panel	<ol style="list-style-type: none"> Open the suction grille. After removing the side panel screws (2 positions), slide the side panel forward and then remove it. 	 <p>Slide forward.</p>
③	Electrical parts box	<ol style="list-style-type: none"> Remove the suction grille. Loosen the set screws (2 positions) of the electrical parts cover. Remove the electrical parts cover. Remove the set screws (2 positions) of the electrical parts box. Remove the electrical parts box. <p>In this time, remove connectors of TA sensor, TC sensor and TCJ sensor if necessary.</p>	 <p>Electrical parts cover</p> <p>Screws (Fixing electrical parts cover and box)</p> <p>③-2 ③-3</p> <p>Electrical parts box</p> <p>Screws (Fixing electrical parts box and main unit)</p> <p>③-4 ③-5</p>

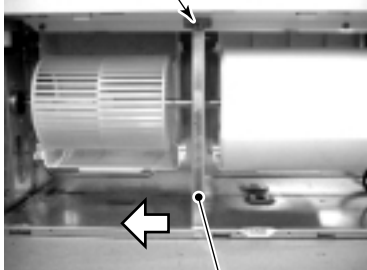
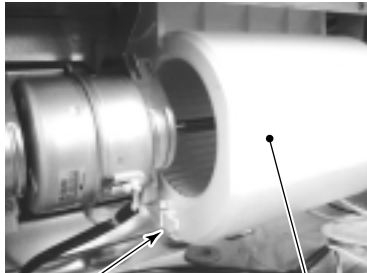
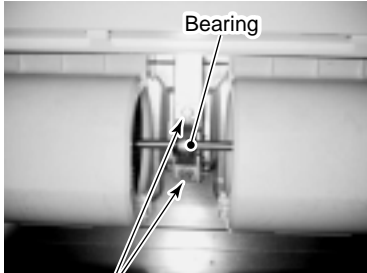
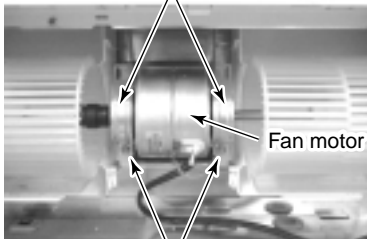
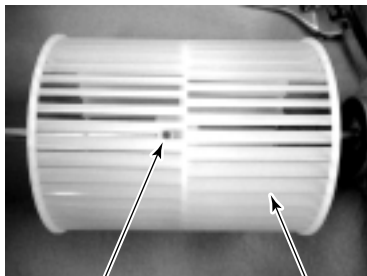

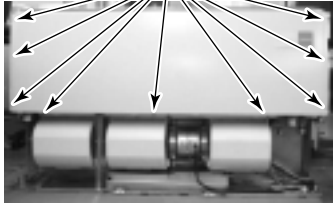
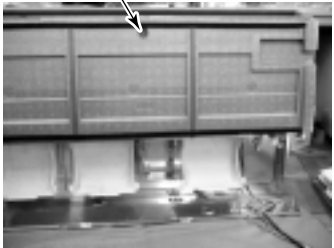
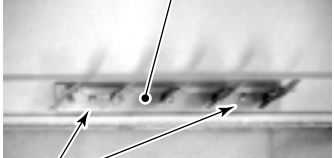
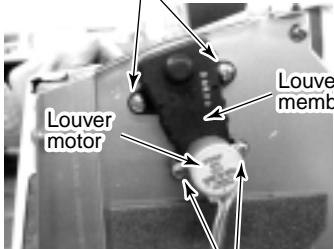
No.	Part name	Procedure	Remarks
④	Multi blade fan motor	<ol style="list-style-type: none"> 1. Remove the suction grille. 2. Remove the connector of the fan motor from P.C. board. 3. (SM802, SM1102, SM1402CT-E only) Remove the set screw (1 position) to fixing and reinforcing bar. (Slide the reinforcing bar toward arrow side on the left figure.) 4. Push the fan cover fixing hooks (2 positions) forward fan cover side and remove the fan cover. 5. (SM1102, SM1402CT-E only) Remove the hexagon head screws (2 positions) to fix bearing and the bearing. 6. Remove the hexagon head screw of fixing fan motor and fan motor holder then the assembly removed from the main unit. 7. Loosen the sets crew of the multi blade fan using hexagon wrench. 8. Pull the multi blade fan towered fan case side. Then fans come off. 	<p>Screws (Fixing reinforcing bar and main unit)</p>  <p style="text-align: right;">④-3</p> <p>Reinforcing bar</p>  <p style="text-align: right;">④-4</p> <p>Fan cover fixing hook Fan cover (Lower side)</p>  <p style="text-align: right;">④-5</p> <p>Bearing</p> <p>Hexagon head screws (Fixing bearing and main unit)</p>  <p style="text-align: right;">④-6</p> <p>Fan motor holder</p> <p>Fan motor</p> <p>Hexagon screws (Fixing fan motor and main unit)</p>  <p style="text-align: right;">④-7</p> <p>Set screw of multi blade fan Multi blade fan</p>

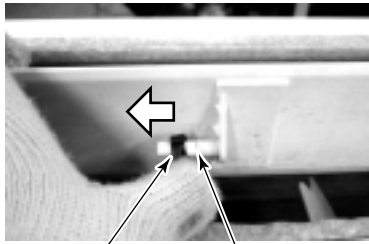
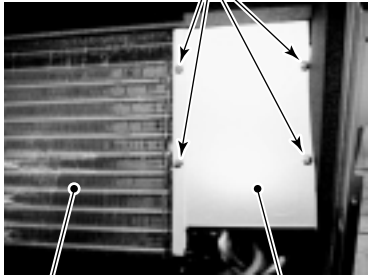
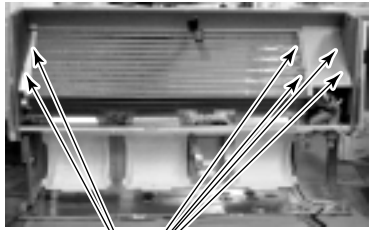
No.	Part name	Procedure	Remarks
⑤	Drain pan	<ol style="list-style-type: none"> 1. Take down the main unit and then treat the drain pan on the floor. 2. Remove the both side panels and suction grilles. 3. (SM802, SM1102, SM1402CT-E only) Remove the set screw (1 position) to fixing and reinforcing bar. (Slide the reinforcing bar toward arrow side on the right figure.) 4. Remove the set screws (9 positions) of fixing lower plate. 5. Remove the heat insulation on the drain pan. (SM562, SM802 : 1 position, SM1102, SM1402 : 2 positions) 6. Remove the set screws (SM562, SM802 : 1 position, SM1102, SM1402 : 2 positions) of fixing drain pan and main unit. 7. Remove the drain pan. Pull it lower side. 	<p>Screws (Fixing lower plate and main unit)</p>  <p>⑤-4</p> <p>Heat insulation The screw that fixed drain pan and main unit is under this insulation.</p>  <p>⑤-5 ⑤-6</p>
⑥	Vertical grille	<ol style="list-style-type: none"> 1. Remove the drain pan. 2. Remove the set screws (2 positions) of fixing vertical grille. 3. Remove the vertical grille. 	<p>Vertical grille</p>  <p>Screws (Fixing drain pan and vertical grille) ⑥-2</p>
⑦	Louver motor, Louver drive member	<ol style="list-style-type: none"> 1. Remove the side cover (right side only). 2. Remove the set screws (2 positions) and louver motor. 3. Remove the set screws (2 positions) and louver drive member. 	<p>Screws (Fixing louver drive member and main unit)</p>  <p>Louver motor Louver drive member</p> <p>⑦-3</p> <p>Screws (Fixing louver motor and louver drive member)</p>





No.	Part name	Procedure	Remarks
⑧	Horizontal louver	<ol style="list-style-type: none"> 1. Push the louver holder toward arrow direction of right figure, and pull out the center shaft (SM562, SM802 : 1 position, SM1102, SM1402 : 2 positions) from louver holder. 2. Pull off the left and right chaft of horizontal louver. 	 <p style="text-align: right;">⑧-1</p> <p>Louver holder Shaft of horizontal louver</p>
⑨	TC, TCJ sensor	<ol style="list-style-type: none"> 1. Remove the drain pan. 2. Remove the set screws (4 positions) and heat exchanger support. 3. Pull out the sensor is inserted into pipe of the heat exchanger. 	 <p style="text-align: center;">Screws (Fixing heat exchanger support)</p> <p style="text-align: right;">⑨-3</p> <p>Heat exchanger Heat exchanger support</p>
⑩	Heat exchanger	<ol style="list-style-type: none"> 1. Take down the main unit and then treat the heat exchanger on the floor. 2. Remove the drain pan. 3. Remove the set screws (6 positions) of fixing heat exchanger and main unit. 	 <p style="text-align: right;">⑩-3</p> <p>Screws (Fixing heat exchanger and main unit)</p>

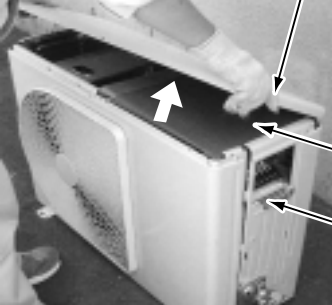
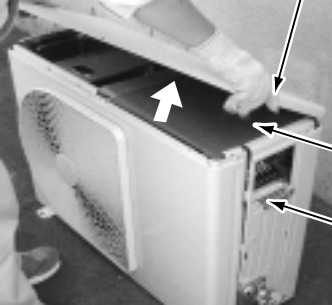
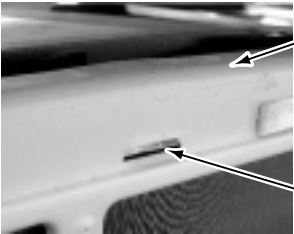

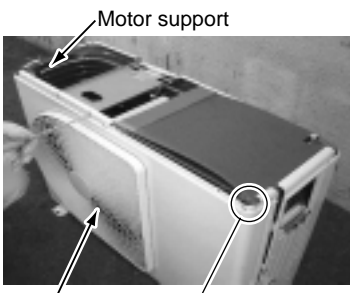
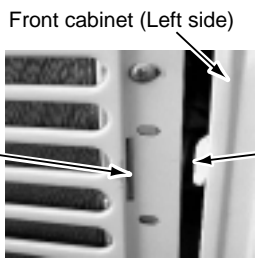
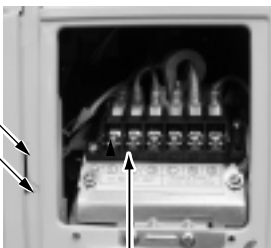
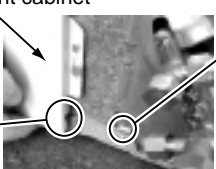
14-2. Outdoor Unit

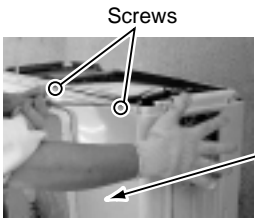

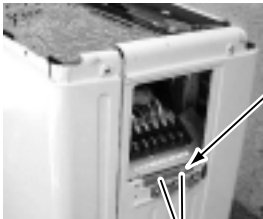
RAV-SM563AT-E, RAV-SM803AT-E

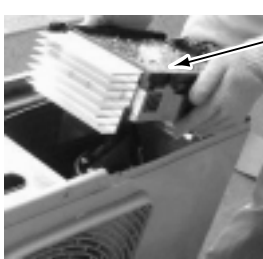
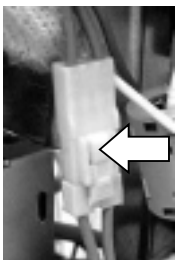
No.	Part name	Procedure	Remarks
①	Common procedure	<p style="text-align: center;">CAUTION</p> <p>Never forget to put on the gloves at working time, otherwise an injury will be caused by the parts, etc.</p> <p>1. Detachment</p> <ol style="list-style-type: none"> 1) Stop operation of the air conditioner, and turn off the main switch of the breaker for air conditioner. 2) Remove the valve cover. (ST1T Ø4 x 10L, 1 pc.) <ul style="list-style-type: none"> • After removing screw, remove the valve cover pulling it downward. 3) Remove wiring cover (ST1T Ø4 x 10L, 2 pcs.), and then remove connecting cable. 4) Remove the upper cabinet. (ST1T Ø4 x 10L, 2 pcs.) <ul style="list-style-type: none"> • After taking off screws, remove the upper cabinet pulling it upward. <p>2. Attachment</p> <ol style="list-style-type: none"> 1) Attach the waterproof cover. <p style="text-align: center;">CAUTION</p> <p>Be sure to attach a waterproof cover. If it is not attached, there is a possibility that water enters inside of the outdoor unit.</p> <ol style="list-style-type: none"> 2) Attach the upper cabinet. (ST1T Ø4 x 10L, 2 pcs.) <ul style="list-style-type: none"> • Hook the rear side of the upper cabinet to claw of the rear cabinet, and then put it on the front cabinet. 3) Perform cabling of connecting cables, and fix with cord clamp. (ST1T Ø4 x 10L 3 pcs.) 4) Attach the wiring cover. (ST1T Ø4 x 10L, 2 pcs.) 5) Attach the valve cover. (ST1T Ø4 x 10L, 1 pc.) <ul style="list-style-type: none"> • Insert the upper part of the upper cabinet, set hooking claw of the valve cover to the slit (at three positions) of the main body, and then attach it pushing upward. 	    

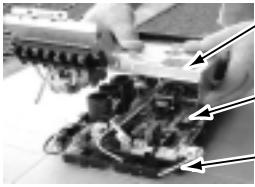
No.	Part name	Procedure	Remarks
②	Front cabinet	<p>1. Detachment</p> <ol style="list-style-type: none"> 1) Perform work of item 1 of ①. 2) Remove screws (ST1T Ø4 × 10L, 2 pcs.) of the front cabinet and the inverter cover. 3) Take off screws of the front cabinet and the bottom plate. (ST1T Ø4 × 10L 3 pcs.) 4) Take off screws of the front cabinet and the motor support. (ST1T Ø4 × 10L, 2 pcs.) <ul style="list-style-type: none"> • The left side of the front side if made to insert to the rear cabinet, so remove it pulling upward. <p>3. Attachment</p> <ol style="list-style-type: none"> 1) Insert hook at the left side of the front side into the rear cabinet. 2) Hook the lower part at the right side of the front to concavity of the bottom plate. Insert the hook of the rear cabinet into the slit of the front cabinet. 3) Attach the removed screws to the original positions. 	 <p>Motor support</p> <p>Front cabinet</p> <p>For single-phase type models, also take off this screw</p>  <p>Front cabinet (Left side)</p> <p>Slit</p> <p>Claw</p>  <p>Slit</p> <p>Hook</p> <p>Cord clamp</p>  <p>Front cabinet</p> <p>Lower slit</p> <p>Concavity at bottom plate</p>

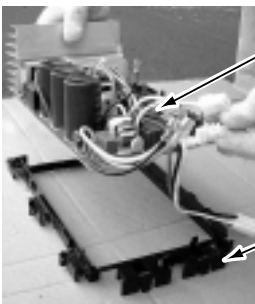
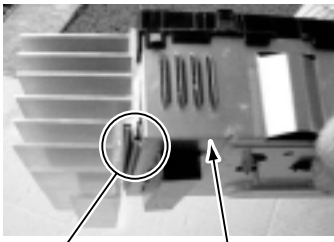
No.	Part name	Procedure	Remarks
③	Inverter assembly	<p>1. Detachment</p> <p>1) Perform work of item 1 of ①.</p> <p>2) Take off screws of the upper part of the front cabinet.</p> <ul style="list-style-type: none"> • If removing the inverter cover under this condition, P.C. board can be checked. • If there is no space in the upper part of the upper cabinet, perform work of ②. <div style="border: 1px solid black; padding: 5px; text-align: center; margin: 10px 0;">CAUTION</div> <p>Be careful to check the inverter because high-voltage circuit is incorporated in it.</p> <p>3) Perform discharging by connecting ⊕ , ⊖ polarities by discharging resistance (approx. 100Ω, 40W) or plug of soldering iron to ⊕ , ⊖ terminals of the C14 (printed as "CAUTION HIGH VOLTAGE") electrolytic capacitor (500μF) of P.C. board.</p> <div style="border: 1px solid black; padding: 5px; text-align: center; margin: 10px 0;">WARNING</div> <p>The electrolytic capacitor may not normally discharge according to error contents and the voltage may remain. Therefore, be sure to discharge the capacitor.</p> <div style="border: 1px solid black; padding: 5px; text-align: center; margin: 10px 0;">WARNING</div> <p>For discharging, never use a screwdriver and others for short-circuiting between ⊕ and ⊖ electrodes. As the electrolytic capacitor is one with a large capacity, it is very dangerous because a large electric spark will occur.</p> <p>4) Take off screws (ST1T Ø4 × 10L, 2 pcs.) fixing the main body and the inverter box.</p> <p>5) Remove various lead wires from the holder at upper part of the inverter box and wiring holder at right side of the terminal block.</p> <p>6) Remove the lead wire from the bundled part at left side of the terminal block.</p> <p>7) Pull the inverter box upward.</p> <p>8) Disconnect connectors of various lead wires.</p> <div style="border: 1px solid black; padding: 5px; text-align: center; margin: 10px 0;">REQUIREMENT</div> <p>As each connector has a lock mechanism, avoid to remove the connector by holding the lead wire, but by holding the connector.</p>	 <p>Screws</p> <p>Front cabinet</p>  <p>Inverter cover</p>  <p>Cord clamp</p> <p>Screws</p>  <p>Plug of soldering iron</p> <p>Discharging position (Discharging period 10 seconds or more)</p>  <p>Inverter assembly</p>  <p>Remove the connectors with locking function by pushing the part indicated by the arrow mark.</p>

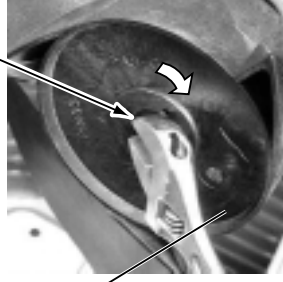

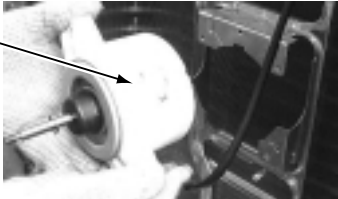
No.	Part name	Procedure	Remarks
④	Control P.C. board assembly	<p>1) Disconnect lead wires and connectors connected from the control P.C. board assembly to other parts.</p> <p>1. Lead wires</p> <ul style="list-style-type: none"> • Connection with the power terminal block: 3 wires (Black, White, Orange) • Earth wire: 1 wire (Black) <p>2. Connectors</p> <ul style="list-style-type: none"> • Connection with compressor: Remove 3P connector. • Connection with reactor: Remove the relay connectors from P07, 08 (2P, White) and P12, 13 (2P, Yellow) <p>CN300 : Outdoor fan (3P, White) CN301 : Position detection (5P, White) CN701 : 4-way valve (3P, Yellow) CN600 : TE sensor (2P, White) CN601 : TD sensor (3P, White) CN603 : TS sensor (3P, White) CN602 : TO sensor (3P, White) CN500 : Case thermo. (2P, White) CN703 : PMV (6P, White)</p> <p>2) Remove the inverter box (Metal plate).</p> <p>3) Remove the control board assembly from P.C. board base. (Remove the heat sink and the control board assembly as they are screwed.)</p> <p>NOTES:</p> <p>1. CN300, CN301 and CN701, etc. at the control board assembly side are connectors with locking function. Therefore, remove the connector while pushing the part indicated by an arrow mark.</p> <p>2. Remove 4 hooking claws of P.C. board base, and remove upward the heat sink with hands.</p> <p>4) Take off 3 screws fixing the heat sink and main control board assembly side, and replace the board with a new one.</p> <p>NOTE: When mounting a new board, check that the board is correctly set in the groove of the base holder of P.C. board base. Attach the P.C. board so that the heat sink comes securely contact with the metal sheet.</p>	 <p>Take off earth screws.</p> <p>Power line</p>  <p>Inverter box (Metal sheet)</p> <p>Control P.C. board assembly</p> <p>P.C. board base</p>  <p>Hooking claws (4 positions)</p>  <p>Control P.C. board assembly</p> <p>P.C. board base</p>  <p>Heat sink</p> <p>Inverter box (Metal sheet)</p>

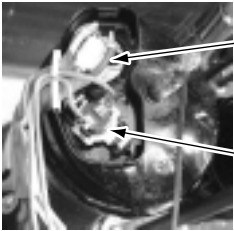
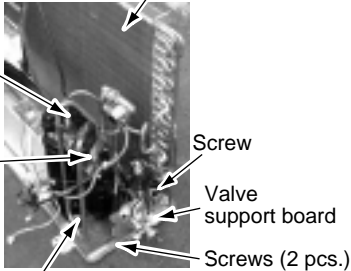
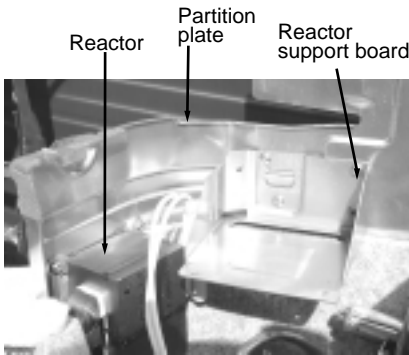
No.	Part name	Procedure	Remarks
⑤	Rear cabinet	1) Perform works of items 1 of ① and ②, ③. 2) Take off fixed screws for the bottom plate. (ST1T Ø4 × 10L, 3 pcs.) 3) Take off fixed screws for the heat exchanger. (ST1T Ø4 × 10L, 2 pcs.) 4) Take off fixed screw for the valve mounting plate. (ST1T Ø4 × 10L, 1 pc.)	
⑥	Fan motor	1) Perform works of items 1 of ① and ②. 2) Take off the flange nut fixing the fan motor and the propeller. <ul style="list-style-type: none"> • Turning it clockwise, the flange nut can be loosened. (To tighten the flange nut, turn counter-clockwise.) 3) Remove the propeller fan. 4) Disconnect the connector for fan motor from the inverter. 5) Take off the fixing screws (3 pcs.) holding by hands so that the fan motor does not fall. <p>NOTE: Tighten the flange nut with torque 4.9Nm (50kgf/cm).</p>	 <p>Loosen the nut by turning clockwise</p>  <p>Propeller fan</p>  <p>Fan motor</p>

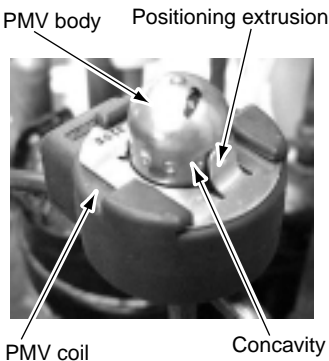
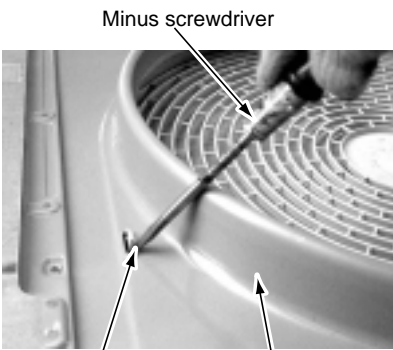
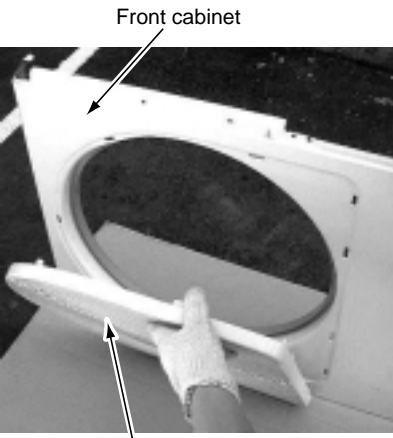
No.	Part name	Procedure	Remarks
⑦	Compressor	<ol style="list-style-type: none"> 1) Perform works of items 1 of ① and ②, ③, ④, ⑤. 2) Discharge refrigerant gas. 3) Remove the partition plate. (ST1T Ø4 × 10L, 2 pcs.) 4) Remove the noise-insulator. 5) Remove the terminal covers of the compressor, and disconnect lead wires of the compressor and the compressor thermo assembly from the terminal. 6) Remove pipes connected to the compressor with a burner. <div style="border: 1px solid black; border-radius: 10px; padding: 5px; margin: 10px 0; text-align: center;"> <p>CAUTION</p> <p>Pay attention to that flame does not involve 4-way valve or PMV. (If doing so, a malfunction may be caused.)</p> </div> <ol style="list-style-type: none"> 7) Take off the fixing screws of the bottom plate and heat exchanger. (ST1T Ø4 × 10L, 2 pcs.) 8) Take off the fixing screws of the valve clamping plate to the bottom plate. 9) Pull upward the refrigerating cycle. 10) Take off nut fixing the compressor to the bottom place. <div style="border: 1px solid black; border-radius: 10px; padding: 5px; margin: 10px 0; text-align: center;"> <p>CAUTION</p> <p>When reconnecting the lead wires to the compressor terminals after replacement of the compressor, be sure to caulk the Faston terminal without loosening.</p> </div>	<p style="text-align: center;">Partition plate</p>   
⑧	Reactor	<ol style="list-style-type: none"> 1) Perform works of item 1 of ① and ③. 2) First take off two screws (ST1T Ø4 × 10L) of the reactor fixed to the reactor support. 3) Remove the reactor support from the partition plate. (ST1T Ø4 × 10L, 4 pcs.) 4) Take off two screws (ST1T Ø4 × 10L) directly attached to the partition plate. 	

No.	Part name	Procedure	Remarks
⑨	Pulse Modulating Valve (P.M.V.) coil	<p>1. Detachment</p> <ol style="list-style-type: none"> 1) Perform works of items ① and ②. 2) Release the coil from the concavity by turning it, and remove coil from the P.M.V. <p>2. Attachment</p> <ol style="list-style-type: none"> 1) Put the coil deep into the bottom position. 2) Fix the coil firmly by turning it to the concavity. 	 <p>PMV body Positioning extrusion</p> <p>PMV coil Concavity</p>
⑩	Fan guard	<p>1. Detachment</p> <ol style="list-style-type: none"> 1) Perform works of items 1 of ①, and ②. 2) Remove the front cabinet, and put it down so that fan guard side directs downward. <div style="border: 1px solid black; border-radius: 10px; padding: 5px; text-align: center; margin: 10px 0;"> <p>CAUTION</p> <p>Perform works on a corrugated cardboard, cloth, etc. to prevent flaw on the product.</p> </div> <ol style="list-style-type: none"> 3) Remove the hooking claws by pushing with minus screwdriver along with the arrow mark in the right figure, and remove the fan guard. <p>2. Attachment</p> <ol style="list-style-type: none"> 1) Insert claws of the fan guard in the hole of the front cabinet. Push the hooking claws (10 positions) with hands and then fix the claws. <div style="border: 1px solid black; border-radius: 10px; padding: 5px; text-align: center; margin: 10px 0;"> <p>CAUTION</p> <p>All the attaching works have completed. Check that all the hooking claws are fixed to the specified positions.</p> </div>	 <p>Minus screwdriver</p> <p>Hooking claw Front cabinet</p>  <p>Front cabinet</p> <p>Fan guard</p>

RAV-SM1103AT-E, RAV-SM1403AT-E / RAV-SP562AT-E, RAV-SP802AT-E

No.	Part name	Procedure	Remarks
①	Common procedure	<p style="text-align: center;">CAUTION</p> <p>Never forget to put on the gloves at working time, otherwise an injury will be caused by the parts, etc.</p> <p>1. Detachment</p> <ol style="list-style-type: none"> 1) Stop operation of the air conditioner, and also turn off switch of the breaker. 2) Remove the front panel. (ST1T Ø4 × 10L, 3 pcs.) <ul style="list-style-type: none"> • After taking off screws, remove the front panel by pulling it downward. 3) Disconnect the connecting cables and power cord from the terminals and cord clamp. 4) Remove the upper cabinet. (ST1T Ø4 × 10L, 6 pcs.) <p>2. Attachment</p> <ol style="list-style-type: none"> 1) Attach the waterproof cover. <p style="text-align: center;">CAUTION</p> <p>Be sure to attach a waterproof cover. If it is not attached, there is a possibility that water enters inside of the outdoor unit.</p> <ol style="list-style-type: none"> 2) Attach the upper cabinet. (ST1T Ø4 × 10L, 6 pcs.) 3) Connect the connecting cable and power cord at the terminal and fix them with cord clamp. <p style="text-align: center;">CAUTION</p> <p>Using bundling band sold at a market, be sure to fix the power cables and indoor/outdoor connecting cables along the inter-unit cable so that they do not come to contact with the compressor, valves and cables at gas side, and the discharge pipe.</p> <ol style="list-style-type: none"> 4) Attach the front cabinet. (ST1T Ø4 × 10L, 3 pcs.) 	 <p>Front cabinet</p>  <p>Upper plate of cabinet</p> <p>Water-proof cover</p>

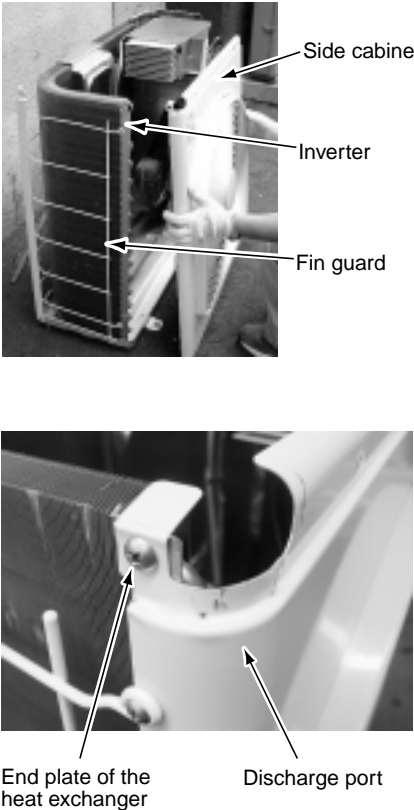
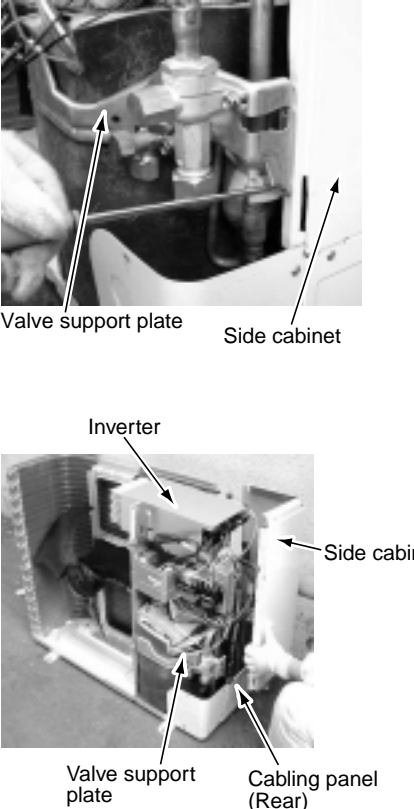

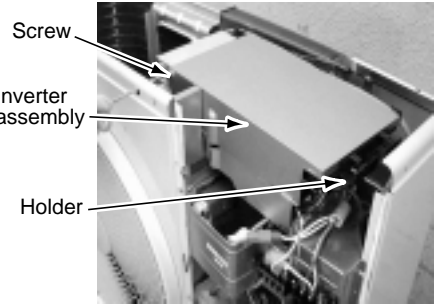
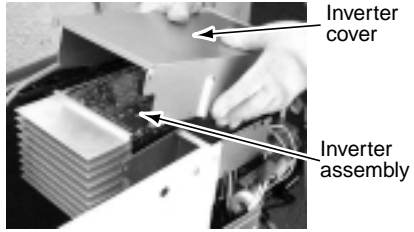
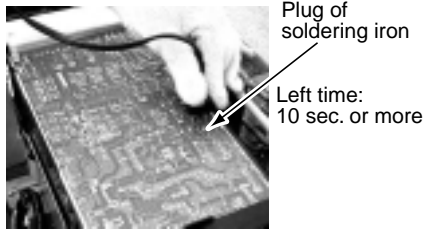
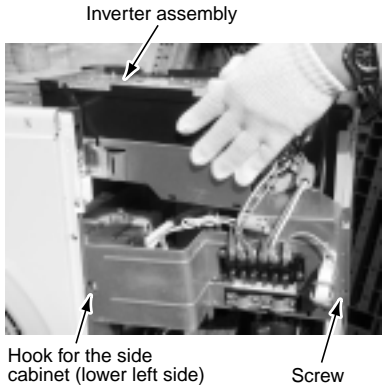
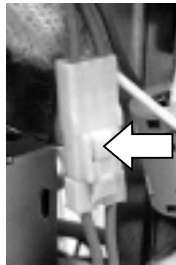
No.	Part name	Procedure	Remarks
②	Discharge port cabinet	<p>1. Detachment</p> <ol style="list-style-type: none"> 1) Perform work of item 1 of ①. 2) Take off screws (ST1T Ø4 × 10L, 3 pcs.) of discharge port cabinet for the partition plate. 3) Take off screws (ST1T Ø4 × 10L, 2 pcs.) of discharge port cabinet for the bottom plate. 4) Take off screw (ST1T Ø4 × 10L, 1 pc.) of discharge port cabinet for the heat exchanger. 5) Take off screws (ST1T Ø4 × 10L, 2 pcs.) of discharge port cabinet for the fin guard. <p>2. Attachment</p> <ol style="list-style-type: none"> 1) Put the upper left side of the discharge port cabinet on the end plate of the heat exchanger, and then fix it with screw. (ST1T Ø4 × 10L, 1 pc.) 2) Attach the removed screws to the original positions. 	 <p>Side cabinet Inverter Fin guard</p> <p>End plate of the heat exchanger Discharge port</p>
③	Side cabinet	<ol style="list-style-type: none"> 1) Perform work of item 1 of ①. 2) Remove screw fixing the inverter and the side cabinet. (ST1T Ø4 × 10, 1 pc.) 3) Remove screws of the side cabinet and the valve support plate. (ST1T Ø4 × 10, 2 pcs.) 4) Remove screw of the side cabinet and the cabling panel (Rear). (ST1T Ø4 × 10, 1 pc.) 5) Remove screw of the side cabinet and the bottom plate. (ST1T Ø4 × 10, 1 pc.) 6) Remove screw of the side cabinet and the fin guard (Heat exchanger). (ST1T Ø4 × 10, 2 pcs.) 	 <p>Valve support plate Side cabinet</p> <p>Inverter Side cabinet Valve support plate Cabling panel (Rear)</p>

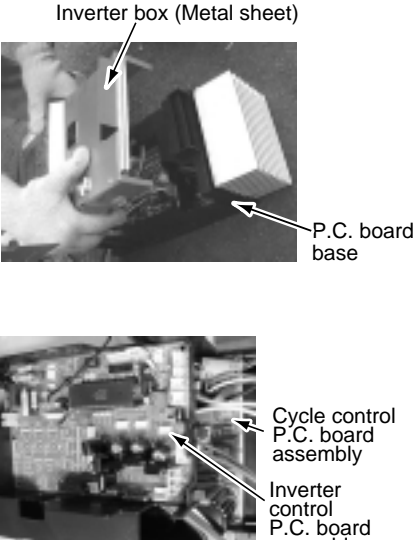
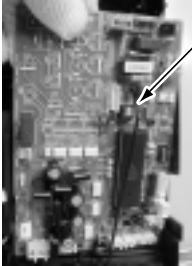
No.	Part name	Procedure	Remarks
④	Inverter assembly	<p>1) Perform works of items of 1) to 5) of ①.</p> <p>2) Take off screw (ST1T Ø4 × 10L, 1 pc.) of the upper left part of the inverter cover.</p> <ul style="list-style-type: none"> • If removing the inverter cover under this condition, P.C. board can be checked. • If there is no space in the upper part of the upper cabinet, perform works of items 6) to 7) of (1) and remove the partition fixing plate. (ST1T Ø4 × 10L, 1 pc.) <p style="text-align: center;">CAUTION</p> <p>Be careful to check the inverter because high-voltage circuit is incorporated in it.</p> <p>3) Perform discharging by connecting the discharging resistance (approx. 100Ω, 40W) or plug of soldering iron to ⊕, ⊖ terminals of the C10 too 13 (printed as "CAUTION HIGH VOLTAGE") electrolytic capacitor (760μF) of P.C. board.</p> <p style="text-align: center;">WARNING</p> <p>The electrolytic capacitor may not normally discharge according to error contents and the voltage may remain. Therefore, be sure to discharge the capacitor.</p> <p style="text-align: center;">WARNING</p> <p>For discharging, never use a screwdriver and others for short-circuiting between ⊕ and ⊖ electrodes. As the electrolytic capacitor is one with a large capacity, it is very dangerous because a large electric spark will occur.</p> <p>4) Remove various lead wires from the holder at upper part of the inverter box.</p> <p>5) Remove the hook for the partition plate (lower left side).</p> <p>6) Remove the hook for the side cabinet (lower left side) and the screw, and lift up the inverter assembly upward. (ST1T Ø4 × 10L, 1 pc.) In this time, cut off the band bundling each lead wire.</p> <p style="text-align: center;">REQUIREMENT</p> <p>As each connector has a lock mechanism, avoid to remove the connector by holding the lead wire, but by holding the connector.</p>	     <p>Remove the connectors with locking function by pushing the part indicated by the arrow mark.</p>

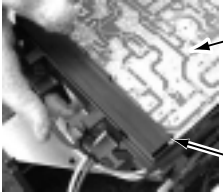
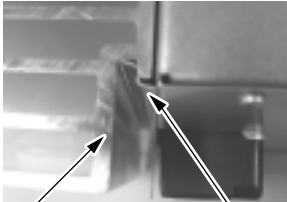

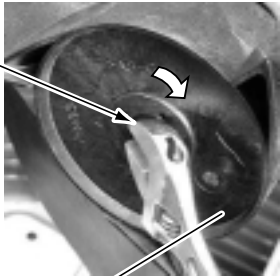
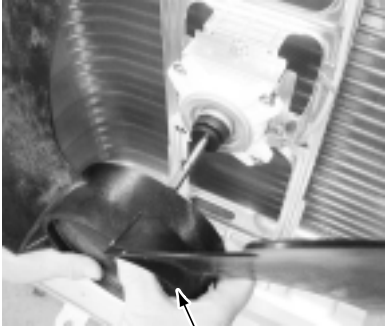
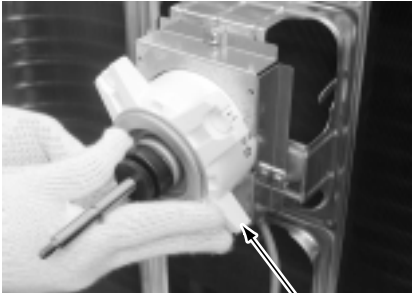
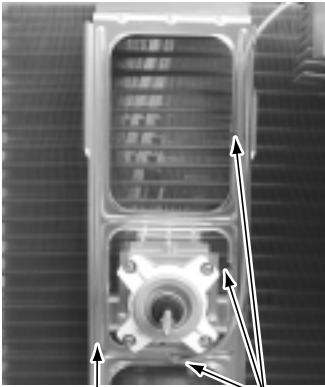
No.	Part name	Procedure	Remarks
④	Inverter assembly (Continued)	<p>7) Remove connectors which are connected from the cycle P.C. board to other parts.</p> <p>CN600: TD sensor (3P: White) CN601: TO sensor (2P: White) CN604: TE sensor (2P: White) *(Note 1) CN605: TS sensor (3P: White) *(Note 1) CN301: Outdoor fan (3P: White) *(Note 1) CN300: Position detection (5P: White) CN500: Case thermo. (2P: Blue) *(Note 1) CN702: P.M.V. (Pulse Motor Valve) coil (6P: White) *(Note 1)</p> <p>Relay connector: 4-way valve (3P: Yellow) *(Note 1) Relay connector: Reactor 2 pcs. (2P: White) *(Note 1)</p> <p>Compressor lead: Remove terminal cover of the compressor, and remove the lead wire from terminal of the compressor.</p> <p>*(Note 1) Remove the connectors by releasing lock of the housing.</p> <p>8) Remove various lead wires. 9) Cut off tie lap which fixes various lead wires to the inverter assembly.</p>	
⑤	Cycle P.C. board	<p>1) Remove connectors and lead wires which are connected from the cycle P.C. board to other parts.</p> <p>1. Connector</p> <p>CN01 : Connection with IPDU P.C. board (5P, Red) *(Note 1) CN02 : Indoor/Outdoor connection terminal block (5P, Black) CN03 : Connection with IPDU P.C. board (3P, White) *(Note 1) CN04 : Connection with IPDU P.C. board (2P, White) *(Note 1) CN700 : 4-way valve (3P, Yellow) *(Note 1) CN800 : Connection with IPDU P.C. board (5P, Red) *(Note 1)</p> <p>*(Note 1) Remove the connector while releasing locking of the housing.</p> <p>2) Mount a new cycle P.C. board.</p>	

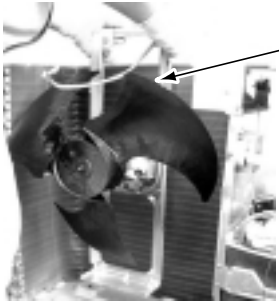
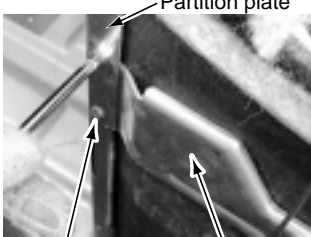

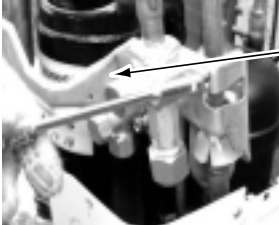
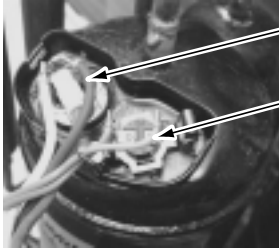
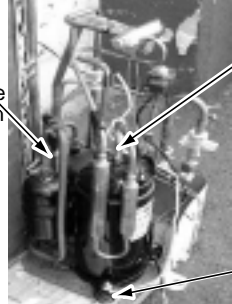
No.	Part name	Procedure	Remarks
⑥	IPDU P.C. board	<p>1) Perform the works in ④ and ⑤.</p> <p>2) Remove the connectors and the lead wires which are connected from IPDU P.C. board to the other parts.</p> <p>1. Connector</p> <p>CN04 : Connection with cycle P.C. board (3P: White) *(Note 1)</p> <p>CN05 : Connection with cycle P.C. board (2P: White) *(Note 1)</p> <p>CN06 : Connection with cycle P.C. board (5P: Red) *(Note 1)</p> <p>CN13 : Connection with cycle P.C. board (5P: Red) *(Note 1)</p> <p>2. Lead wire</p> <p>CN01 : Connection with power terminal block (Red)</p> <p>CN02 : Connection with power terminal block (White)</p> <p>CN03 : Connection with inverter box (Black)</p> <p>CN09 : Connection with compressor (Red)</p> <p>CN10 : Connection with compressor (White)</p> <p>CN11 : Connection with compressor (Black)</p> <p>Rectifier diode</p> <p>⊕ : Orange lead wire *(Note 2)</p> <p>⊖ : Gray lead wire *(Note 2)</p> <p>⊖ : Red lead wire (Top)</p> <p>⊖ : Brown lead wire (Bottom)</p> <p>*(Note 1) Remove the connectors by releasing lock of the housing.</p> <p>3) Remove the control P.C. board assembly from P.C. board base. (Remove the heat sink and the inverter control P.C. board assembly as they are screwed.)</p> <p>*(Note 2) Remove the heat sink upward by taking off two claws of P.C. base and holding the heat sink.</p> <p>4) Take off two screws which fix the heat sink and IGBT and also take off support hooks of the P.C. board (5 positions) to remove IPDU P.C. board.</p> <p>5) Mount a new IPDU P.C. board.</p> <p>*(Note 3) The rectifier diode has polarity, so be careful to ⊕ and ⊖ . If ⊕ and ⊖ are mistaken, a trouble is caused.</p> <p>*(Note 4) When mounting a new board, check that it is correctly set in the groove of the base holder of P.C. board base.</p>	 <p>Inverter control P.C. board assembly</p>  <p>Inverter control P.C. board assembly</p> <p>Groove for P.C. board</p>  <p>Heat sink</p> <p>Inverter box (Metal sheet)</p>

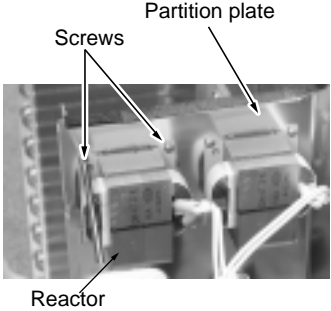
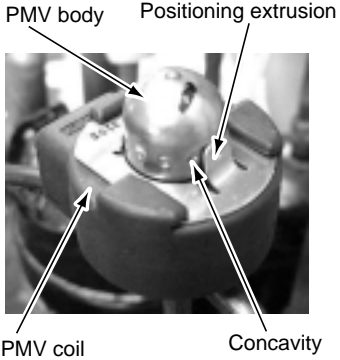
No.	Part name	Procedure	Remarks
⑦	Fan motor	<p>1) Perform works of items 1) to 5), 7) of ①</p> <p>2) Remove the flange nut fixing the fan motor and the propeller fan.</p> <ul style="list-style-type: none"> • Loosen the flange nut by turning clockwise. (To tighten the flange nut, turn it counterclockwise.) <p>3) Remove the propeller fan.</p> <p>4) Remove the lead wire from the hook fixing the fan motor lead wires on the motor base. (Three positions)</p> <p>5) Disconnect the connector for fan motor from the inverter.</p> <p>6) Take off the fixing screws (4 pcs.) while holding by hands so that the fan motor does not fall.</p> <p>*(Note) Tighten the flange nut with torque 9.8N•m (100kgf/cm).</p>	 <p>Flange nut</p> <p>Loosen by turning clockwise</p>  <p>Propeller fan</p>  <p>Fan motor</p>  <p>Motor base</p> <p>Fixing claws for fan motor lead wires (3 positions)</p>

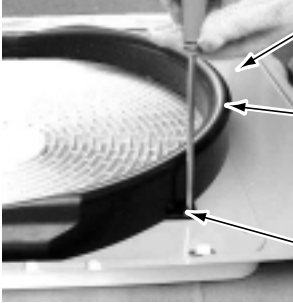
No.	Part name	Procedure	Remarks
⑧	Compressor	<ol style="list-style-type: none"> 1) Perform works of items ①, ②, ③, and ④. 2) Evacuate refrigerant gas. 3) Disconnect the connector for fan motor from the inverter. 4) Take off screws fixing the motor base to the bottom plate. (ST1T Ø4 x 10L, 2 pcs.) 5) Remove the motor base together with the fan motor and the propeller fan. 6) Take off screws fixing the partition plate to the valve support plate. (ST1T Ø4 x 10L, 2 pcs.) 7) Remove the valve support plate. (M6 x 4 pcs.) 8) Take off screws of the partition plate and the bottom plate. (ST1T Ø4 x 10L, 2 pcs.) 9) Take off screws of the partition plate and the heat exchanger. (ST1T Ø4 x 10L, 2 pcs.) 10) Remove the noise-insulator. 11) Remove the terminal covers of the compressor, and disconnect lead wires of the compressor and the compressor thermo assembly from the terminal. 12) Remove pipes connected to the compressor with a burner. <div style="border: 1px solid black; border-radius: 10px; padding: 5px; margin: 10px 0; text-align: center;"> <p>CAUTION</p> <p>Pay attention to that flame does not involve 4-way valve or PMV. (If doing so, a malfunction may be caused.)</p> </div> <ol style="list-style-type: none"> 13) Pull the refrigerating cycle upward. 14) Take off nut fixing the compressor on the bottom plate. (3 pcs.) 15) Pull the compressor toward you. <div style="border: 1px solid black; border-radius: 10px; padding: 5px; margin: 10px 0; text-align: center;"> <p>CAUTION</p> <p>When reconnecting the lead wires to the compressor terminals after replacement of the compressor, be sure to caulk the Faston terminal without loosening.</p> </div>	 <p>Motor base</p>  <p>Partition plate</p>  <p>Screw Valve support</p>  <p>Partition plate</p>  <p>Valve support</p>  <p>Compressor lead wire Case thermo</p>  <p>Remove (Suction pipe) Remove (Discharge pipe) Compressor nut (3 pcs.)</p>

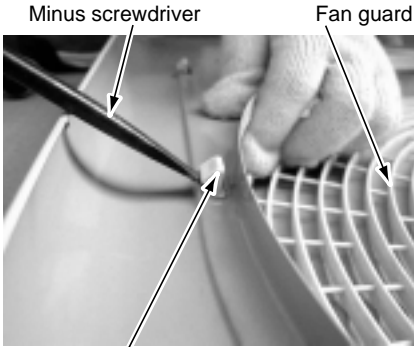
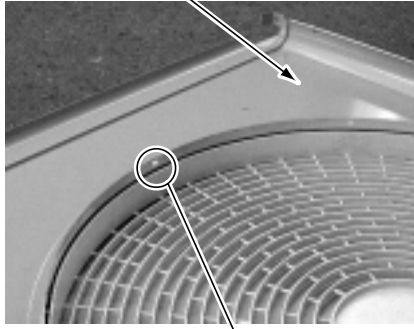
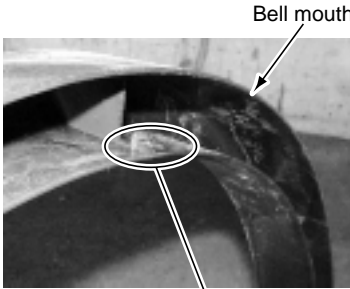
No.	Part name	Procedure	Remarks
⑨	Reactor	1) Perform works of items 1 of ① and ④. 2) Take off screws fixing the reactor. (Ø4 x 10L , 2 pcs. per one reactor. An outdoor unit has two reactors on the partition plate.)	
⑩	Pulse Modulating Valve (PMV) coil	1. Detachment 1) Perform works of items 1 of ① and ③. 2) Remove the coil from PMV body while pulling it upward. 2. Attachment 1) Match the positioning extrusion of the coil surely to the concavity of PMV body to fix it.	

No.	Part name	Procedure	Remarks
①	Fan guard	<p>1. Detachment</p> <p>1) Perform works of items 1 of ① and ②.</p> <p>2) Remove the air flow cabinet, and put it down so that the fan guard side directs downward.</p> <div data-bbox="416 412 946 530" style="border: 1px solid black; padding: 5px; margin: 10px 0;"> <p>Perform work on a corrugated cardboard, cloth, etc. to prevent flaw to the product.</p> </div> <p>3) Take off screws fixing the bell mouth. (ST1T Ø4 × 10L, 2 pcs.)</p> <p>4) Remove the bell mouth.</p> <p>5) Remove the hooking claws by pushing with minus screwdriver along with the arrow mark as shown in right figure.</p> <p>2. Attachment</p> <p>1) Insert claw of the fan guard in hole of the discharge panel. Push the hooking claws (5 positions) with hands and fix the claws.</p> <div data-bbox="416 927 946 1077" style="border: 1px solid black; padding: 5px; margin: 10px 0;"> <p>After all the attachment works are completed, check that all the hooking claws are fixed to the specified positions.</p> </div> <p>2) Mount the bell mouth by hooking three claws at upper side of the bell mouth in the slits on the discharge cabinet.</p> <p>3) After attachment, fix the bell mouth with screws. (ST1T Ø4 × 10L, 2 pcs.)</p>	    

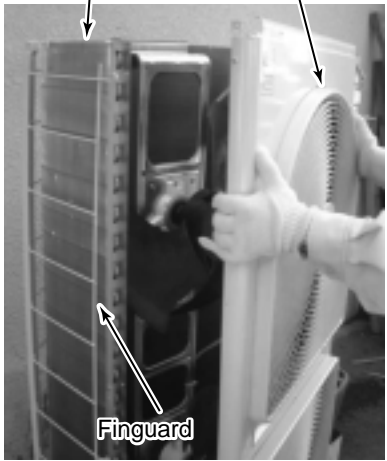
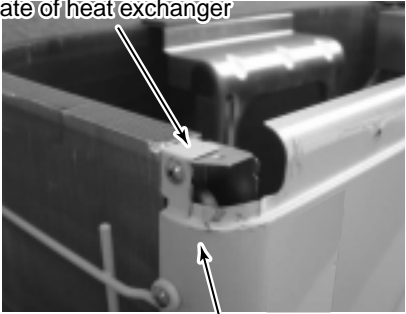
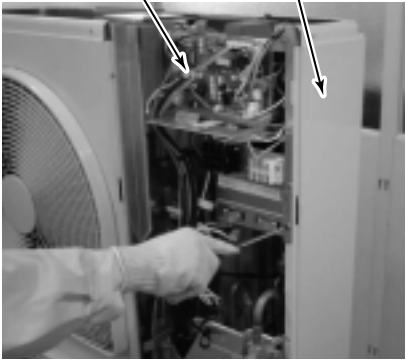
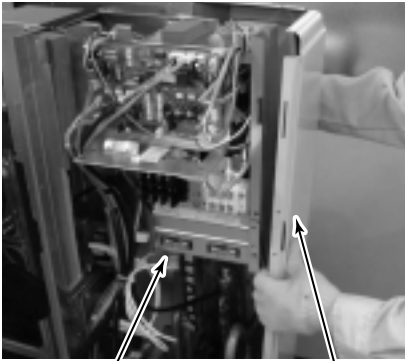

No.	Part name	Procedure	Remarks
①	Common procedure	<p style="text-align: center;">REQUIREMENT</p> <p>Before works, put on gloves, otherwise an injury may be caused by parts, etc.</p> <p>1. Detachment</p> <ol style="list-style-type: none"> 1) Stop operation of the air conditioner, and turn off switch of the breaker. 2) Remove the front panel. (ST1T Ø4 × 10, 3 pcs.) <ul style="list-style-type: none"> • After removing the screws, remove the front panel while drawing it downward. 3) Remove the power cable and the indoor/outdoor connecting cable from cord clamp and terminal. 4) Remove the roof plate. (ST1T Ø4 × 10, 6 pcs.) <p>2. Attachment</p> <ol style="list-style-type: none"> 1) Mount the roof plate. (ST1T Ø4 × 10, 6 pcs.) 2) Connect the power cable and the indoor/outdoor connecting cable to terminal, and then fix them with cord clamp. <p style="text-align: center;">REQUIREMENT</p> <p>Be sure to fix the power cable and the indoor/outdoor connecting cable with bundling band on the market along the inter-unit cable so that they do not come to contact with the compressor, the valve and the cable at gas side, and the discharge pipe.</p> <ol style="list-style-type: none"> 3) Attach the front panel. (ST1T Ø4 × 10, 3 pcs.) 	<p style="text-align: center;">Front panel</p>  <p style="text-align: center;">Roof plate</p> 

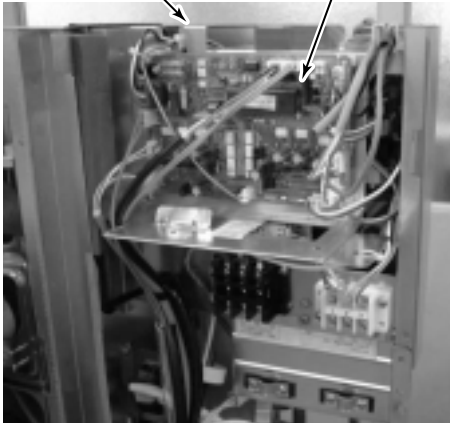
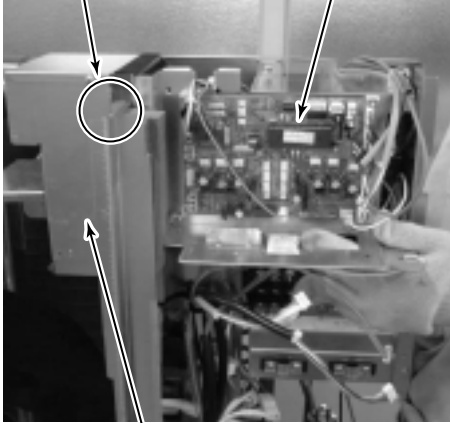
No.	Part name	Procedure	Remarks
②	Air-outlet cabinet	<p>1. Detachment</p> <ol style="list-style-type: none"> 1) Perform the work in 1 of ①. 2) Take off screws for the air-outlet cabinet and the partition plate. (ST1T Ø4 × 10, 3 pcs.) 3) Take off screws for the air-outlet cabinet and the base plate. (ST1T Ø4 × 10, 2 pcs.) 4) Take off screw for the air-outlet cabinet and the heat exchanger. (ST1T Ø4 × 10, 1 pc.) 5) Take off screws for the air-outlet cabinet and the fin guard. (ST1T Ø4 × 10, 2 pcs.) <p>2. Attachment</p> <ol style="list-style-type: none"> 1) Put the upper left side of the air-outlet cabinet on the end plate of heat exchanger, and fix it with screw. (ST1T Ø4 × 10, 1 pc.) 2) Attach the taken-off screws to the original positions. 	<p>Heat exchanger Air-outlet cabinet</p>  <p>Finguard</p> <p>Upper side of the end plate of heat exchanger</p>  <p>Air-outlet cabinet</p>
③	Side cabinet	<ol style="list-style-type: none"> 1) Perform the work in 1 of ①. 2) Take off screws fixing the inverter and the side cabinet. (ST1T Ø4 × 10, 2 pcs.) 3) Take off screws for the side cabinet and the valve fixed plate. (ST1T Ø4 × 10, 2 pcs.) 4) Take off screw for the side cabinet and the piping panel (Rear). (ST1T Ø4 × 10, 1 pc.) 5) Take off screw for the side cabinet and the base plate. (ST1T Ø4 × 10, 1 pc.) 6) Take off screws for the side cabinet and the fin guard. (ST1T Ø4 × 10, 4 pcs.) 	<p>Inverter Side cabinet</p>   <p>Valve fixed plate Side cabinet</p>

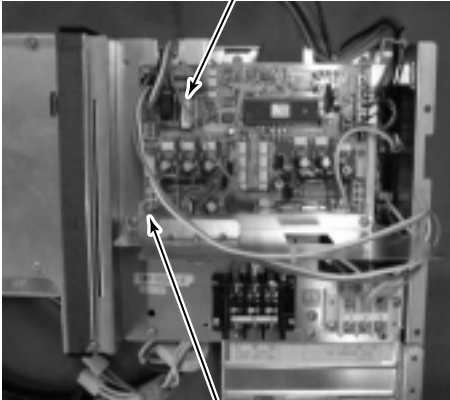

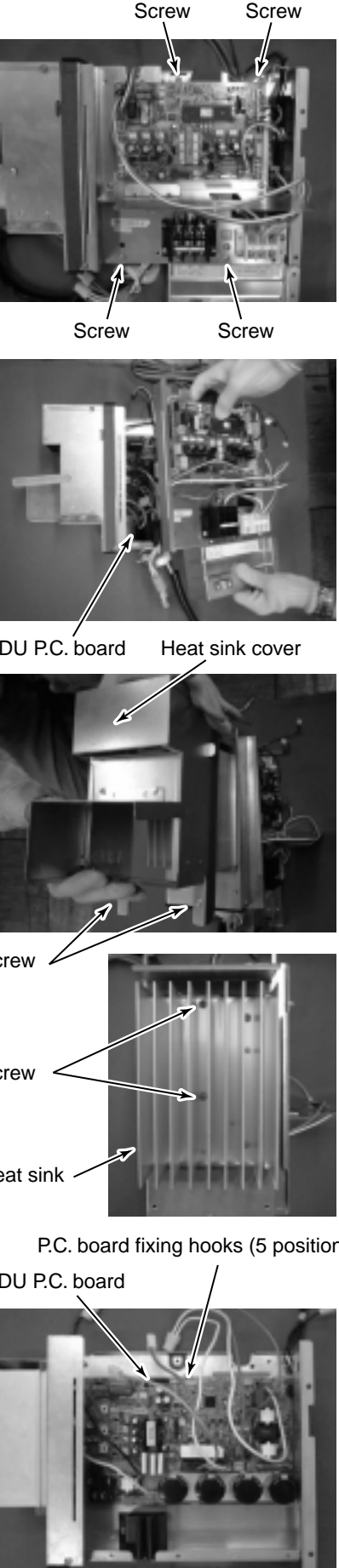
No.	Part name	Procedure	Remarks
④	Inverter assembly	<p>1) Perform the works in 1 of ① and ③.</p> <p>2) Remove connectors which are connected from the cycle P.C. board to other parts.</p> <p>CN600: TD sensor (3P: White)</p> <p>CN601: TO sensor (2P: White)</p> <p>CN604: TE sensor (2P: White) *(Note 1)</p> <p>CN605: TS sensor (3P: White) *(Note 1)</p> <p>CN301: Upper outdoor fan (3P: White) *(Note 1)</p> <p>CN300: Detection of upper position (5P: White)</p> <p>CN303: Lower outdoor fan (3P: White) *(Note 1)</p> <p>CN302: Detection of lower position (5P: White)</p> <p>CN500: Case thermo. (2P: Blue) *(Note 1)</p> <p>CN700: 4-way valve (3P: Yellow) *(Note 1)</p> <p>CN702: PMV (Pulse Motor Valve) coil (6P: White) *(Note 1)</p> <p>Relay connector: Reactor 2 pcs. (2P: White)</p> <p>Compressor lead: Remove terminal cover of the compressor, and remove the lead wire from terminal of the compressor.</p> <p>*(Note 1) Remove the connectors by releasing lock of the housing.</p> <p>3) Remove various lead wires from the holder at upper part of the inverter.</p> <p>4) Cut off tie lap which fixes various lead wires to the inverter assembly.</p> <p>5) Lift up the hook (upper left) with the partition plate upward just removing.</p> <p>* Caution to mount the inverter assembly Mount the inverter assembly to the partition plate so that hooks of the heat sink cover do not come near the partition plate but also near the fan side.</p>	<p>Inverter assembly Cycle P.C. board</p>  <p>Hooks of heat sink cover (2 positions) Inverter assembly</p>  <p>Heat sink cover</p>

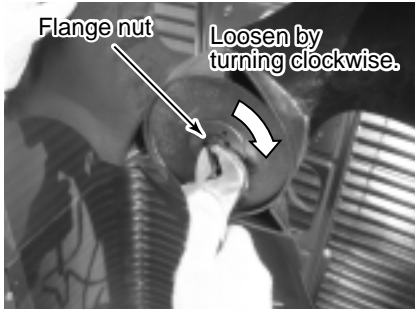

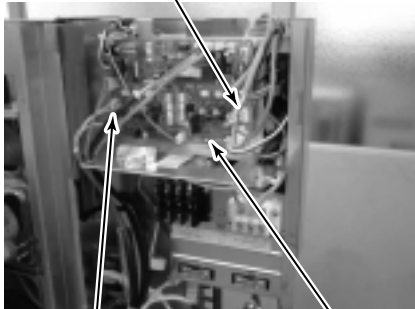
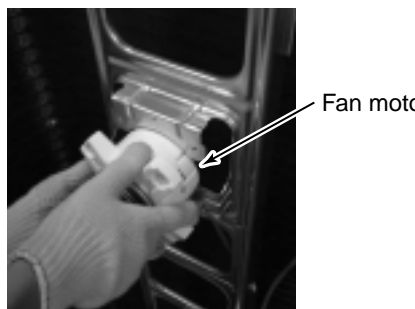
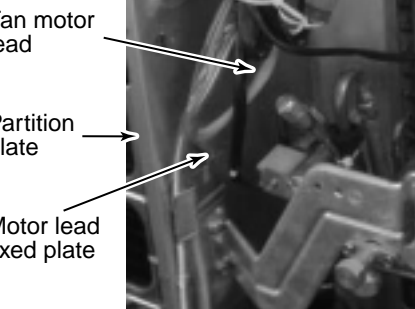
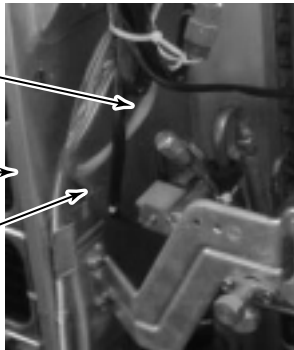
No.	Part name	Procedure	Remarks
⑤	Cycle P.C. board	<p>1) Perform the works in 1 of ① and ③.</p> <p>2) Remove connectors and lead wires which are connected from the cycle P.C. board to other parts.</p> <p>1. Connector</p> <p>CN800: Connection with IPDU P.C. board (5P: Red) *(Note 1)</p> <p>CN01: Connection with IPDU P.C. board (5P: Red) *(Note 1)</p> <p>CN02: Indoor/Outdoor connection terminal block (5P: Black) *(Note 1)</p> <p>CN03: Connection with IPDU P.C. board (3P: White) *(Note 1)</p> <p>CN04: Connection with IPDU P.C. board (2P: White) *(Note 1)</p> <p>*(Note 1) Remove the connectors by releasing lock of the housing.</p> <p>3) Remove the supporting hooks at 4 corners to remove the cycle P.C. board.</p> <p>4) Mount a new cycle P.C. board.</p> <p>5) Lift up the hook (upper left) with the partition plate upward just removing.</p>	<p>Cycle control P.C. board assembly</p>  <p>P.C. board fixing hooks (4 positions)</p>

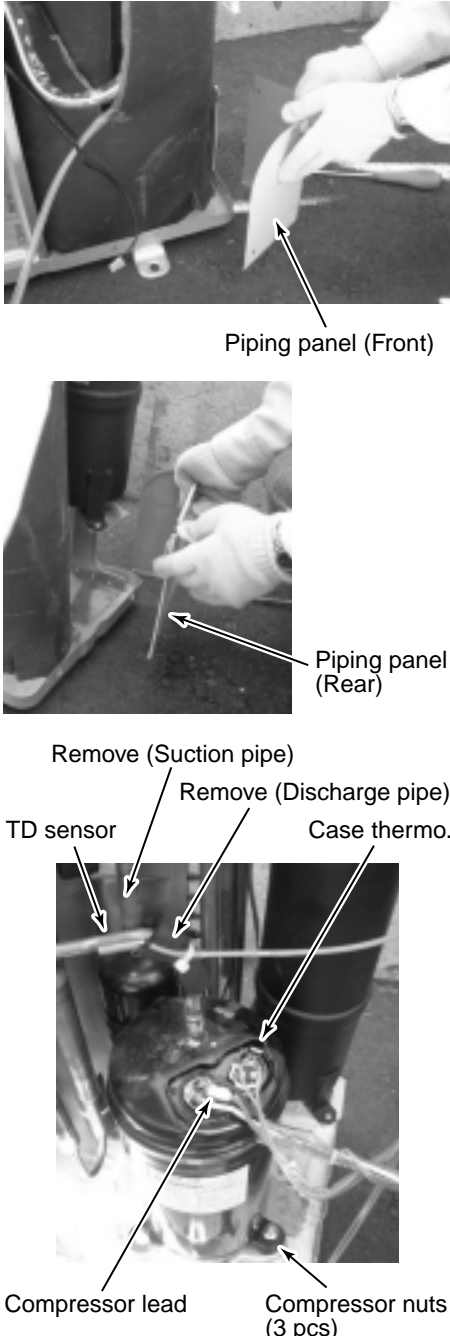
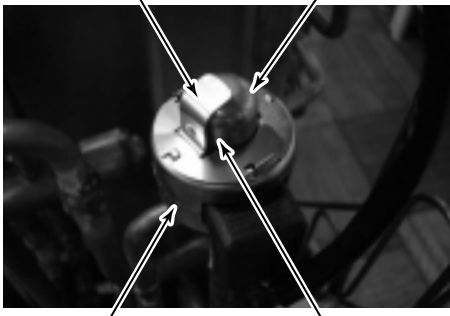
No.	Part name	Procedure	Remarks
⑥	IPDU P.C. board	<p>1) Perform the works in ④ and ⑤.</p> <p>2) Take off screws of the inverter assembly to separate the inverter assembly. (M4 × 8, 4 pcs)</p> <p>3) Remove the connectors and the lead wires which are connected from IPDU P.C. board to the other parts.</p> <p>1. Connector</p> <p>CN04: Connection with cycle P.C. board (3P: White) *(Note 1)</p> <p>CN05: Connection with cycle P.C. board (2P: White) *(Note 1)</p> <p>CN06: Connection with cycle P.C. board (5P: Red) *(Note 1)</p> <p>CN13: Connection with cycle P.C. board (5P: Red) *(Note 1)</p> <p>CN600: Heat sink sensor (2P: Black)</p> <p>2. Lead wire</p> <p>CN01: Connection with power terminal block (Red)</p> <p>CN02: Connection with power terminal block (White)</p> <p>CN03: Connection with inverter box (Black)</p> <p>CN09: Connection with compressor (Red)</p> <p>CN10: Connection with compressor (White)</p> <p>CN11: Connection with compressor (Black)</p> <p>Rectifier diode</p> <p>⊕ : Orange lead wire *Note 2</p> <p>⊖ : Gray lead wire *Note 2</p> <p>⊖ : Red lead wire (Top)</p> <p>⊖ : Brown lead wire (Bottom)</p> <p>*(Note 1) Remove the connectors by releasing lock of the housing.</p> <p>4) Remove the heat sink cover. (M4 × 8, 2pcs)</p> <p>5) Take off two screws which fix the heat sink and IGBT and also take off support hooks of the P.C. board (5 positions) to remove IPDU P.C. board.</p> <p>6) Mount a new IPDU P.C. board.</p> <p>*(Note 2) The rectifier diode has polarity, so be careful to ⊕ and ⊖ . If ⊕ and ⊖ are mistaken, a trouble is caused.</p>	 <p>Screw Screw</p> <p>Screw Screw</p> <p>IPDU P.C. board Heat sink cover</p> <p>Screw</p> <p>Screw</p> <p>Heat sink</p> <p>P.C. board fixing hooks (5 positions)</p> <p>IPDU P.C. board</p>

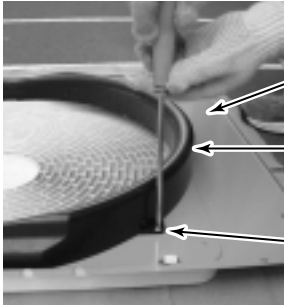
No.	Part name	Procedure	Remarks
⑦	Fan motor	<p>1) Perform the works in 1 of ① and 1 of ②.</p> <p>2) Take off flange nut fixing the fan motor with the propeller fan.</p> <ul style="list-style-type: none"> Loosen the flange nut by turning clockwise. (When tightening, turn it counter-clockwise.) <p>3) Remove the propeller fan.</p> <p>4) Remove connector for the fan motor from the inverter.</p> <p>5) Take off fixing screws (4 pcs) with supporting the fan motor so that it does not fall down.</p> <p>6) When replacing the fan motor at lower side, remove the motor lead fixed plate which is fixed to the partition plate with screw (ST1T Ø4 × 10, 1 pc), pull the fan motor lead out of the partition plate, and then remove the fan motor.</p> <p>* Cautions in assembling fan motor</p> <p><In case of RAV-SP1102AT-E></p> <ul style="list-style-type: none"> Be sure to mount the propeller fan and the fan motor at upper and lower sides because they are different. Tighten the flange nut with the following torque. <ul style="list-style-type: none"> Upper side: 9.8N·m (100kgf·cm) Lower side: 4.9N·m (50kgf·cm) <p><In case of RAV-SP1402AT-E></p> <ul style="list-style-type: none"> The same propeller fan and the fan motor are used at upper and lower sides. Tighten the flange nut with the following torque. <ul style="list-style-type: none"> Upper side: 9.8N·m (100kgf·cm) Lower side: 9.8N·m (100kgf·cm) Be sure to mount the motor lead fixed plate so that the fan motor lead is not caught in. Be sure that the propeller fan does not come to contact with the fan motor lead. 	 <p>Flange nut</p> <p>Loosen by turning clockwise.</p>  <p>Propeller fan</p>  <p>Fan motor connector at upper side</p>  <p>Fan motor connector at lower side</p>  <p>Fan motor</p>  <p>Fan motor lead</p> <p>Partition plate</p> <p>Motor lead fixed plate</p>

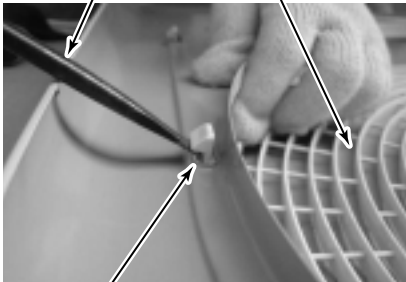
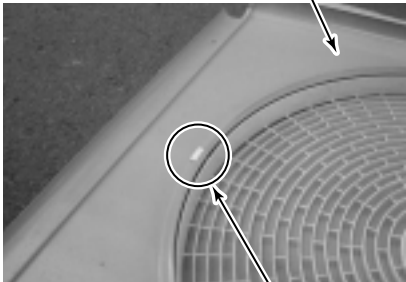
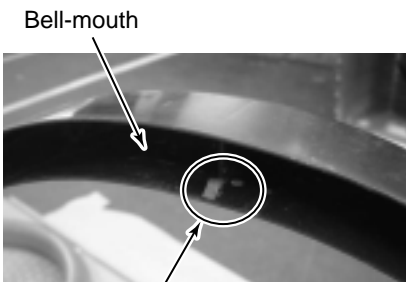
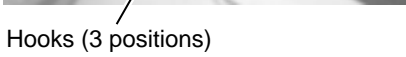
No.	Part name	Procedure	Remarks
⑧	Compressor	<ol style="list-style-type: none"> 1) Recover refrigerant gas. 2) Perform the works in 1 of ① and in ③. 3) Remove the piping panel (Front). Take off screws of the piping panel (Front) and the base plate. (ST1T Ø4 × 10, 2 pcs) Take off screws of the piping panel (Front) and the piping panel (Rear). (ST1T Ø4 × 10, 2 pcs) 4) Remove the piping panel (Rear). Take off screws of the piping panel (Rear) and the base plate. (ST1T Ø4 × 10, 2 pcs) 5) Remove the sound-insulation plate. 6) Remove terminal cover of the compressor, and then remove compressor lead and case thermo. of the compressor. (ST1T Ø4 × 10, 2 pcs) 7) Remove TD sensor fixed to the discharge pipe. 8) Using a burner, remove pipe connected to the compressor. <div style="border: 1px solid black; padding: 5px; margin: 10px 0;"> <p>NOTE) Pay attention that 4-way valve or PMV is not exposed to a flame. (Otherwise, a malfunction may be caused.)</p> </div> <ol style="list-style-type: none"> 9) Pull out discharge pipe and suction pipe of the refrigerating cycle upward. 10) Take off the compressor nuts (3 pcs) fixing the compressor to the base plate. 11) Draw out the compressor toward you. 	 <p>Piping panel (Front)</p> <p>Piping panel (Rear)</p> <p>Remove (Suction pipe)</p> <p>Remove (Discharge pipe)</p> <p>TD sensor</p> <p>Case thermo.</p> <p>Compressor lead</p> <p>Compressor nuts (3 pcs)</p>
⑨	PMV coil	<ol style="list-style-type: none"> 1. Detachment <ol style="list-style-type: none"> 1) Perform the works in 1 of ① and in ③. 2) Hold outside of the coil by hands and turn it while lifting upward. The fixing hooks come off the fixing concavities and then the coil can be removed from PMV body. 2. Attachment <ol style="list-style-type: none"> 1) Match the positioning extrusion of the coil surely to the concave part of PMV body, and then fix it. 	 <p>Positioning extrusion</p> <p>PMV body</p> <p>PMV coil</p> <p>Concave part</p>

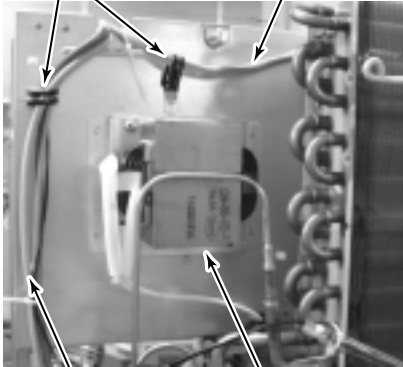
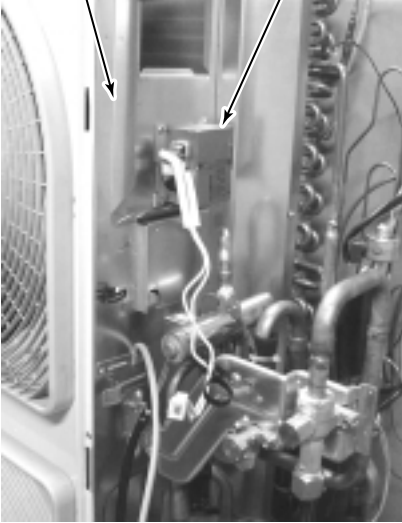
No.	Part name	Procedure	Remarks
⑩	Fan guard	<p>1. Detachment</p> <p>1) Perform the works in 1 of ① and in 1 of ②.</p> <div data-bbox="406 331 949 477" style="border: 1px solid black; padding: 5px; margin: 10px 0;"> <p style="text-align: center;">REQUIREMENT</p> <p>To prevent damage on the products, treat component on a corrugated paper, cloth, etc.</p> </div> <p>2) Remove the air-outlet cabinet, and then put down it directing the fan guard side downward.</p> <p>3) Take off screws fixing the bell-mouth. (ST1T Ø4 x 10, 2 pcs)</p> <p>4) Remove the bell-mouth.</p> <p>5) Take off screws fixing the fan guard. (ST1T Ø4 x 10, 2 pcs)</p> <p>6) Remove hanging hook of the fan guard by pushing with a minus screwdriver.</p> <p>2. Attachment</p> <p>1) Insert the extrusion at the upper side of the fan guard into the square hole of the air-outlet cabinet, and then insert the hanging hook. Fix the hanging hooks (5 positions) by pushing with hands.</p> <div data-bbox="406 1077 949 1193" style="border: 1px solid black; padding: 5px; margin: 10px 0;"> <p style="text-align: center;">REQUIREMENT</p> <p>Check that all the hanging hooks are fixed to the specified positions.</p> </div> <p>2) After attachment, fix it with screws. (ST1T Ø4 x 10, 2 pcs)</p> <p>3) Mount the bell-mouth by hanging hooks (3 positions) at upper side of the bell-mouth to the square holes of the air-outlet cabinet.</p> <p>4) After attachment, fix it with screws. (ST1T Ø4 x 10, 2 pcs)</p> <p>* Caution in assembling bell-mouth</p> <ul style="list-style-type: none"> • The size (color) of the bell-mouth at upper side differs from that at lower side. (Only for RAV-SP1102AT-E) <p style="text-align: center;"><In case of RAV-SP1102AT-E></p> <p>Upper side: Black Lower side: Gray</p> <p style="text-align: center;"><In case of RAV-SP1402AT-E></p> <p>Upper side: Black Lower side: Black</p>	     

No.	Part name	Procedure	Remarks
①	Reactor	<p>1) Perform works of items ① to ④.</p> <div data-bbox="416 277 970 510" style="border: 1px solid black; padding: 5px;"> <p>NOTE) The same two reactors are installed to this outdoor unit though each installation place is different. One is attached to a partition board, and the other is attached to an electric parts box.</p> </div> <p>2) Remove the connector of the reactor lead wire connected to the inverter assembly. 3) Remove fixing screws of the reactor.</p> <p style="text-align: center;"><Cautions for assembling></p> <p>The temperature of the reactor becomes high during operation of the outdoor unit. Using a cord holder, fix various sensor lead wires or fan motor lead wires in the surroundings of the reactor to be fixed to the electric parts box as shown below so that they do not come to contact with the reactor.</p> <div data-bbox="416 719 970 1563" style="border: 1px solid black; padding: 5px;">  <p style="text-align: center;">Cord holder Fan motor lead wire</p> <p style="text-align: center;">Various sensor lead wires Reactor</p> </div>	<div data-bbox="1023 253 1426 835" style="border: 1px solid black; padding: 5px;">  <p style="text-align: center;">Partition board Reactor</p> </div> <div data-bbox="1023 891 1426 1619" style="border: 1px solid black; padding: 5px;">  <p style="text-align: center;">Electric parts box Reactor</p> </div>

15. EXPLODED VIEWS AND PARTS LIST

15-1. Indoor Unit

15-1-1. 4-Way Air Discharge Cassette Type

RAV-SM563UT-E, RAV-SM803UT-E

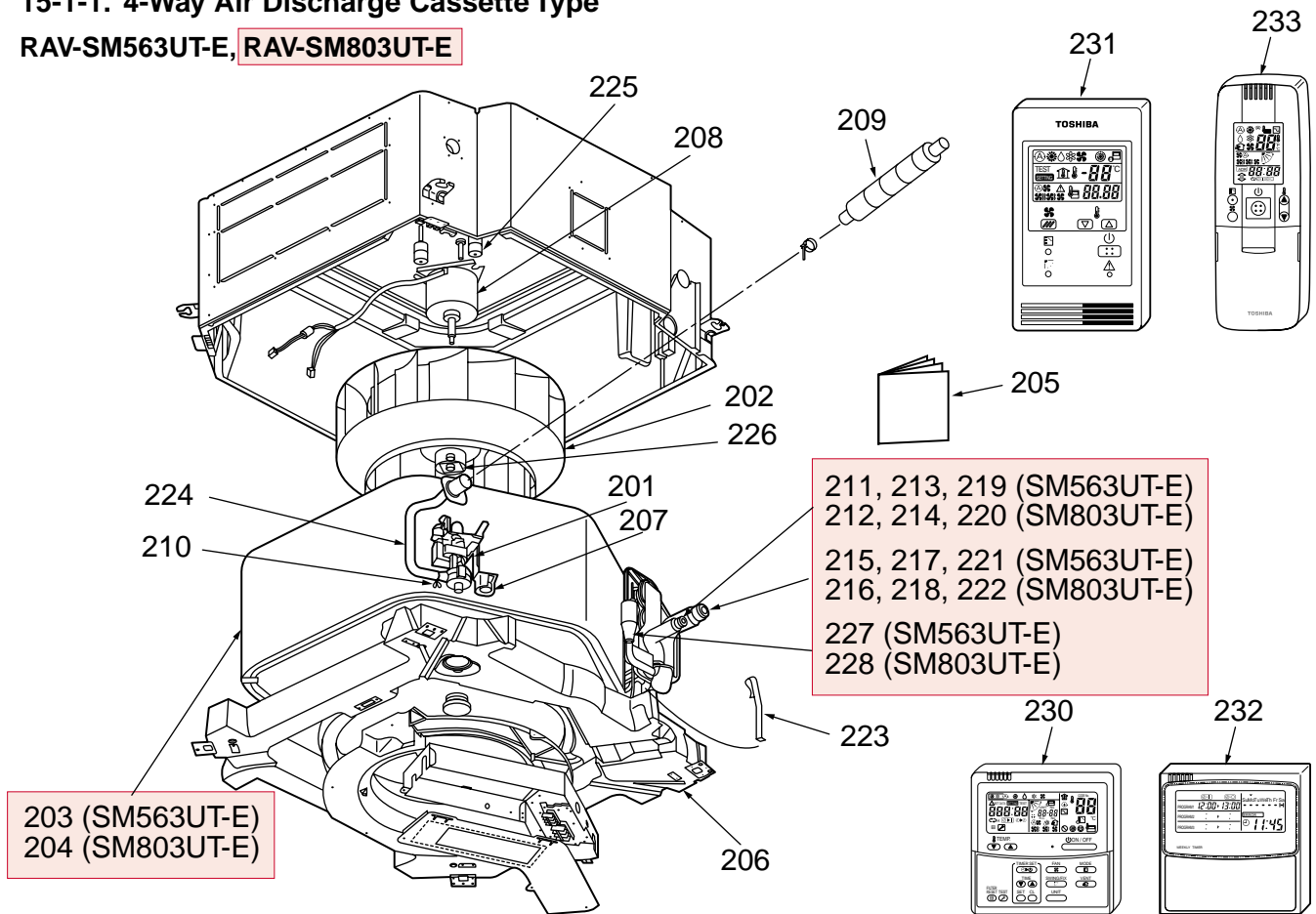

Location No.	Part No.	Description
201	43121736	Pump, Drain, ADP-1409, 220-240V
202	43120215	Fan, Ass'y Turbo, TJ461
203	4314J265	Refrigeration Cycle Ass'y
204	4314J266	Refrigeration Cycle Ass'y
205	431S8055	Owner's Manual
206	43172187	Pan Ass'y, Drain, PS-F+ABS, Sheet
207	43151290	Switch, Float, FS-0218-102
208	43121738	Motor, Fan, SWF-230-60-1R
209	43170244	Hose, Drain, 25A
210	43079249	Band, Hose
211	43047685	Nut, Flare, 1/4 IN, Ø6.35
212	43047686	Nut, Flare, 3/8 IN, Ø9.52
213	43149351	Socket, Ø6.35
214	43049776	Socket, Ø9.52
215	43047688	Nut, Flare, 1/2 IN, Ø12.7
216	43149352	Nut, Flare, 5/8 IN, Ø15.88
217	43149353	Socket, 1/2 IN, Ø12.7

Location No.	Part No.	Description
218	43149354	Socket, 5/8 IN, Ø15.88
219	43049697	Bonnet, Ø6.35
220	43047609	Bonnet, Ø9.52
221	43147195	Bonnet, 1/2 IN, Ø12.7
222	43194029	Bonnet, Ø15.88
223	43019904	Holder, Sensor, SUS
224	43170245	Hose, Drain
225	43139137	Rubber, Cushion
226	43097212	Nut
227	4314Q009	Distributor Ass'y
228	4314Q010	Distributor Ass'y
230	43166002	Remote Controller, SX-A1EE (RBC-AMT31E)
231	43166004	Remote Controller, SX-A11JE2 (RBC-AS21E2)
232	43166005	Remote Controller, EX-W2JE2 (RBC-EXW21E2)
233	43166006	Remote Controller, WH-H1JE2 (RBC-AX22CE2)

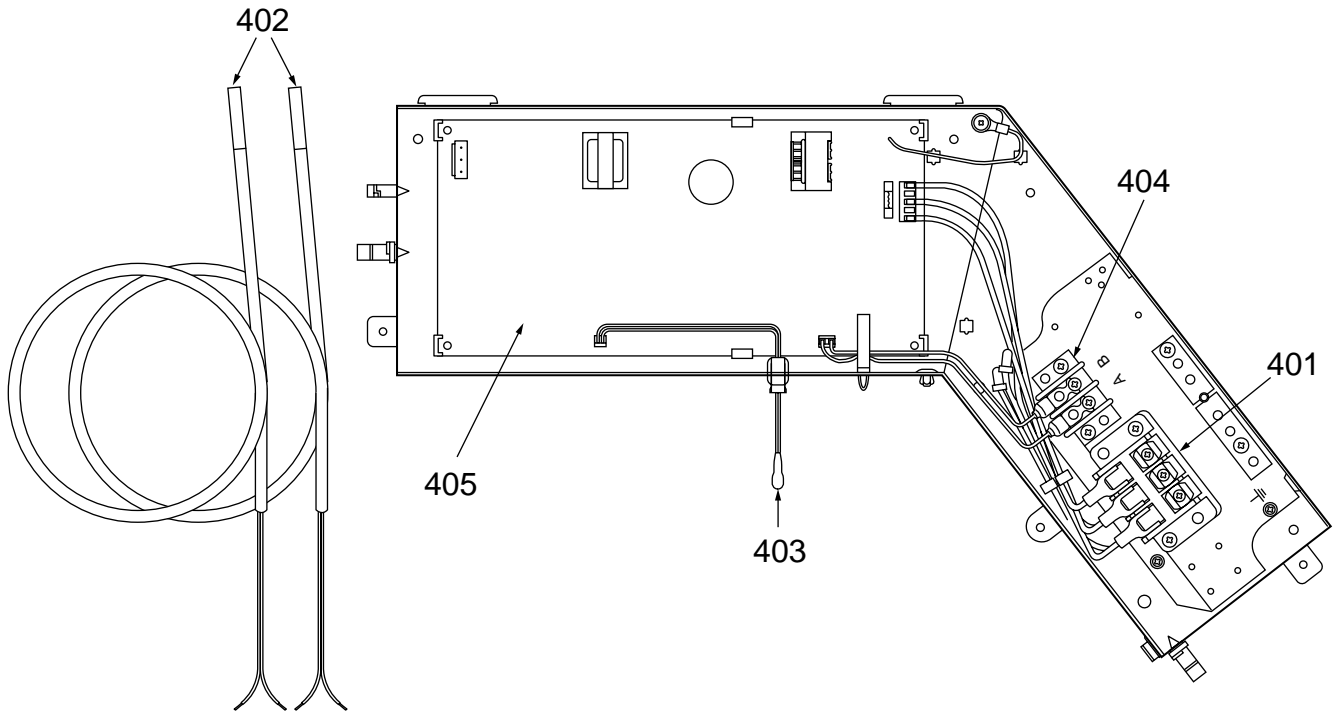

Location No.	Part No.	Description
401	43160565	Terminal Block, 3P, 20A
402	43050425	Sensor, TC (F6)
403	43050426	Sensor, TA
404	43160568	Terminal Block, 2P, 1A, AC30V
405	4316V323	P.C. Board Ass'y, MCC-1402

RAV-SP1102UT-E

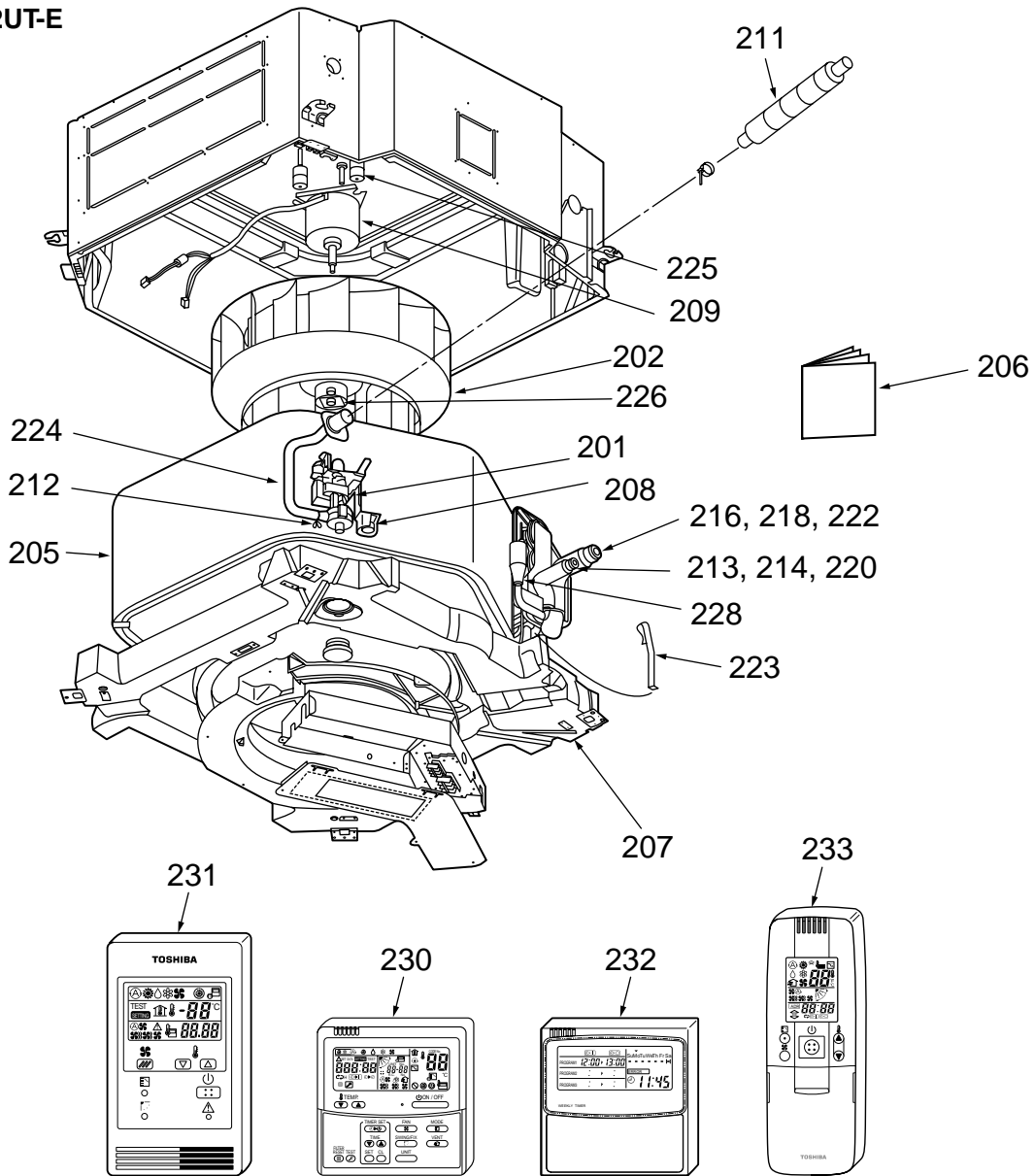

Location No.	Part No.	Description
201	43121736	Pump, Drain, ADP-1409, 220-240V
202	43120214	Fan Ass'y Turb, TY461
205	4314J267	Refrigeration Cycle Ass'y
206	4318T681	Owner's Manual
207	43172187	Pan Ass'y, Drain, PS-F+ABS, Sheet
208	43151290	Switch, Float, FS-0218-102
209	43121737	Motor, Fan, SWF-200-90-1R
211	43170244	Hose, Drain, 25A
212	43079249	Band, Hose
213	43047686	Nut, Flare, 3/8 IN, Ø9.6
214	43049776	Socket, Ø9.6
216	43149352	Nut, Flare, 5/8 IN, Ø15.9
218	43149354	Socket, 5/8 IN, Ø15.9

Location No.	Part No.	Description
220	43047609	Bonnet, Ø9.6
222	43194029	Bonnet, Ø15.9
223	43019904	Holder, Sensor, SUS
224	43170245	Hose, Drain
225	43139137	Rubber, Cushion
226	43097212	Nut
228	434Q011	Distributor Ass'y
230	43166002	Remote Controller, SX-A1EE (RBC-AMT31E)
231	43166004	Remote Controller, SX-A11JE2 (RBC-AS21E2)
232	43166005	Remote Controller, EX-W2JE2 (RBC-EXW21E2)
233	43166006	Remote Controller, WH-H1JE2 (RBC-AX22CE2)

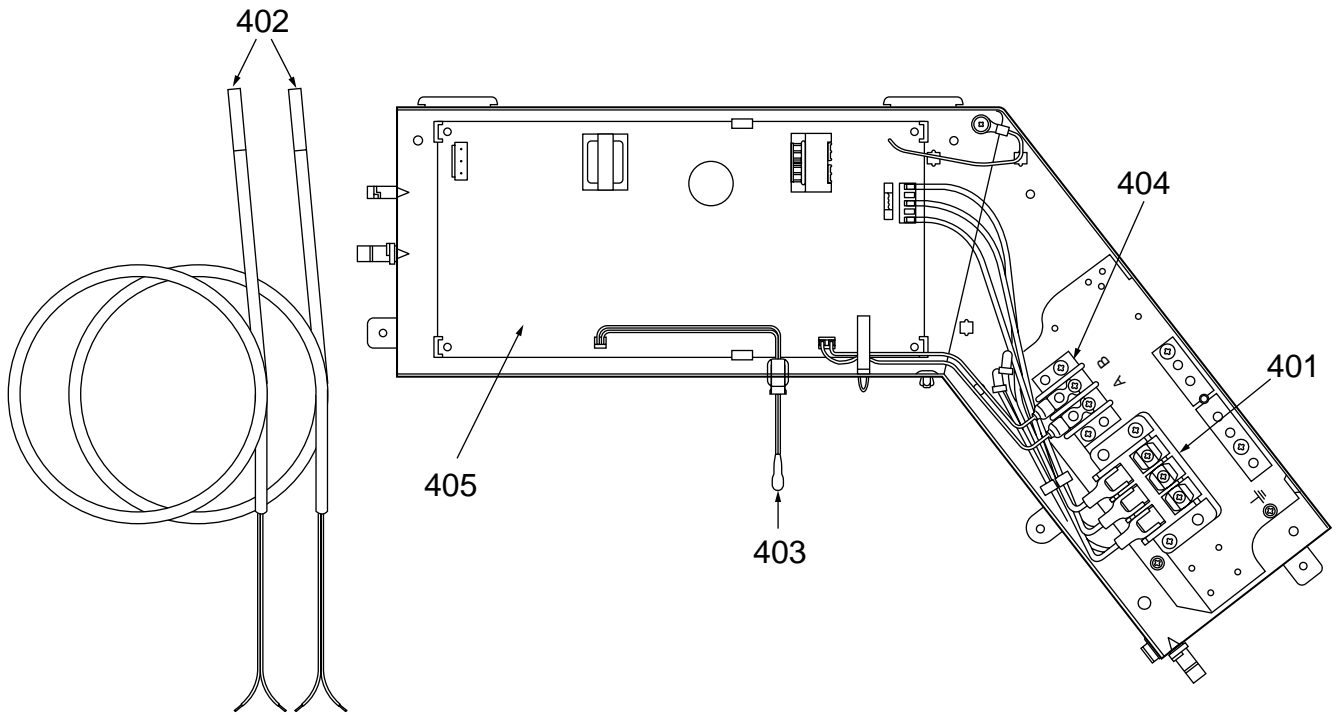

Location No.	Part No.	Description
401	43160565	Terminal Block, 3P, 20A
402	43050425	Sensor, TC (F6)
403	43050426	Sensor, TA
404	43160568	Terminal Block, 2P, 1A, AC30V
405	4316V280	P.C. Board Ass'y, MMC-1402

RAV-SM1103UT-E, RAV-SM1403UT-E

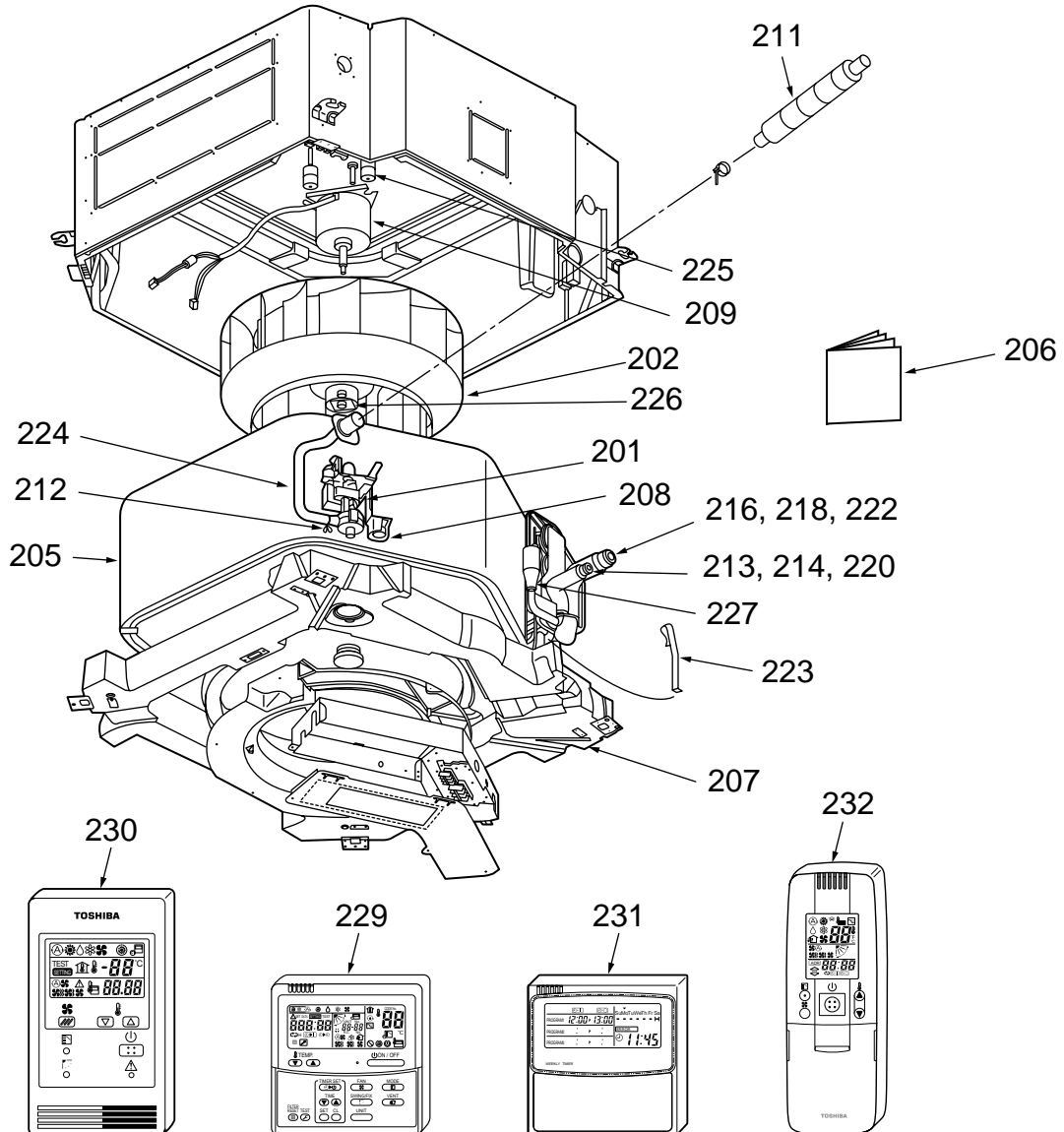

Location No.	Part No.	Description
201	43121736	Pump, Drain, ADP-1409, 220-240V
202	43120214	Fan Ass'y Turb, TY461
205	4314J366	Refrigeration Cycle Ass'y
206	431S8055	Owner's Manual
207	431172187	Pan Ass'y, Drain, PS-F+ABS, Sheet
208	43151290	Switch, Float, FS-0218-102
209	43121737	Motor, Fan, SWF-200-90-1R
211	43170244	Hose, Drain, 25A
212	43079249	Band, Hose
213	43047686	Nut, Flare, 3/8 IN, Ø9.62
214	43049776	Socket, Ø9.62
216	43149352	Nut, Flare, 5/8 IN, Ø15.88
218	43149354	Socket, 5/8 IN, Ø15.88

Location No.	Part No.	Description
220	43047609	Bonnet, Ø9.62
222	43194029	Bonnet, Ø15.88
223	43019904	Holder, Sensor, SUS
224	43170245	Hose, Drain
225	43139137	Rubber, Cushion
226	43097212	Nut
227	4314Q061	Distributor Ass'y
229	43166002	Remote Controller, SX-A1EE (RBC-AMT31E)
230	43166004	Remote Controller, SX-A11JE2 (RBC-AS21E2)
231	43166005	Remote Controller, EX-W2JE2 (RBC-EXW21E2)
232	43166006	Remote Controller, WH-H1JE2 (RBC-AX22CE2)

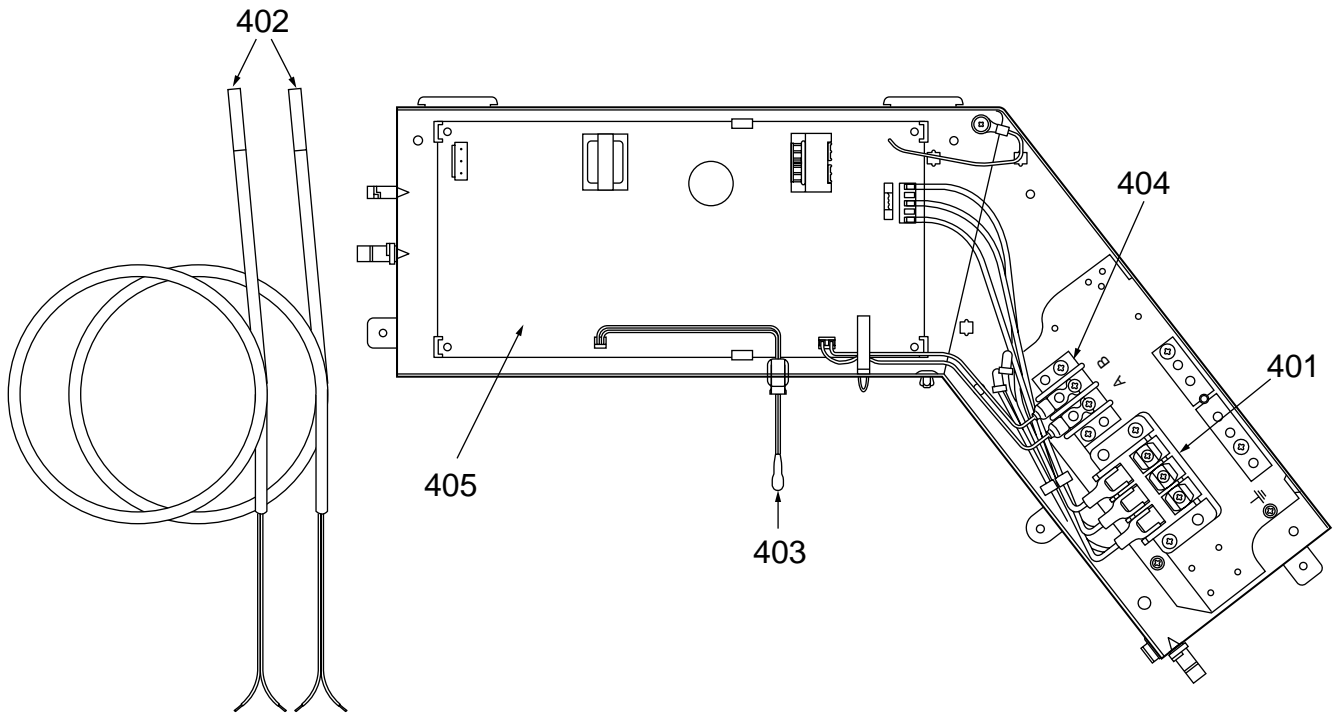

Location No.	Part No.	Description
401	43160565	Terminal Block, 3P, 20A
402	43050425	Sensor, TC (F6)
403	43050426	Sensor, TA
404	43160568	Terminal Block, 2P, 1A, AC30V
405	4316V323	P.C. Board Ass'y, MMC-1402

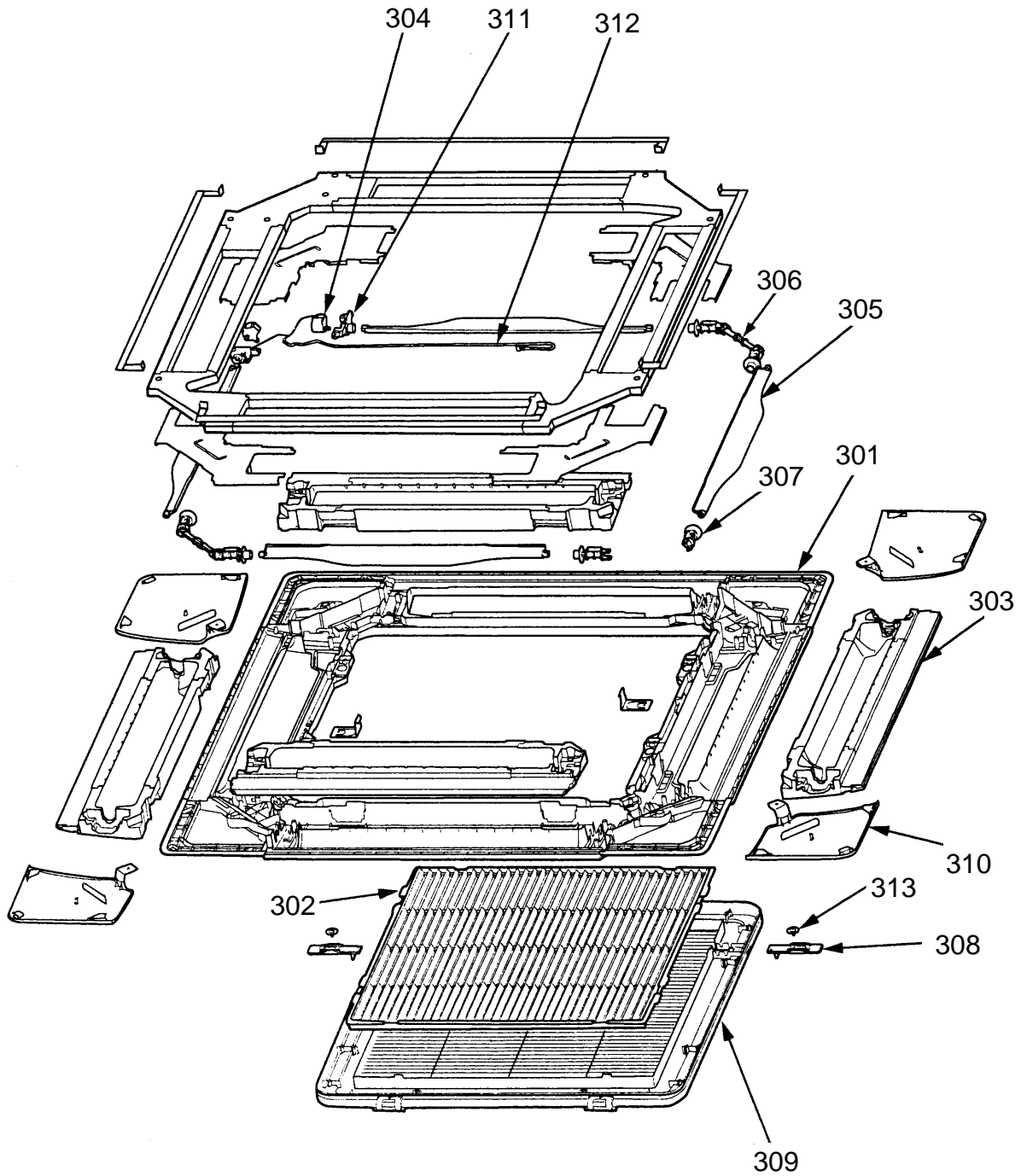

Location No.	Part No.	Description
301	43409164	Panel, PS-HI100
302	43480010	Air Filter, ABS
303	43407120	Outlet, Air Form, PS-F
304	4302C063	Motor, Louver, MP24ZN
305	43409173	Louver, ABS
306	43422001	Joint, Kit
307	43422002	Joint, Kit

Location No.	Part No.	Description
308	43407116	Grille, Catch, ABS
309	43409168	Grille, Air, Inlet
310	43409182	Cover, Panel Ass'y, PS-HI100
311	43407123	Fix, Motor, ABS
312	43160573	Lead, Motor
313	43182002	Washer, SPCC

15-1-2. Concealed Duct Type

RAV-SM562BT-E

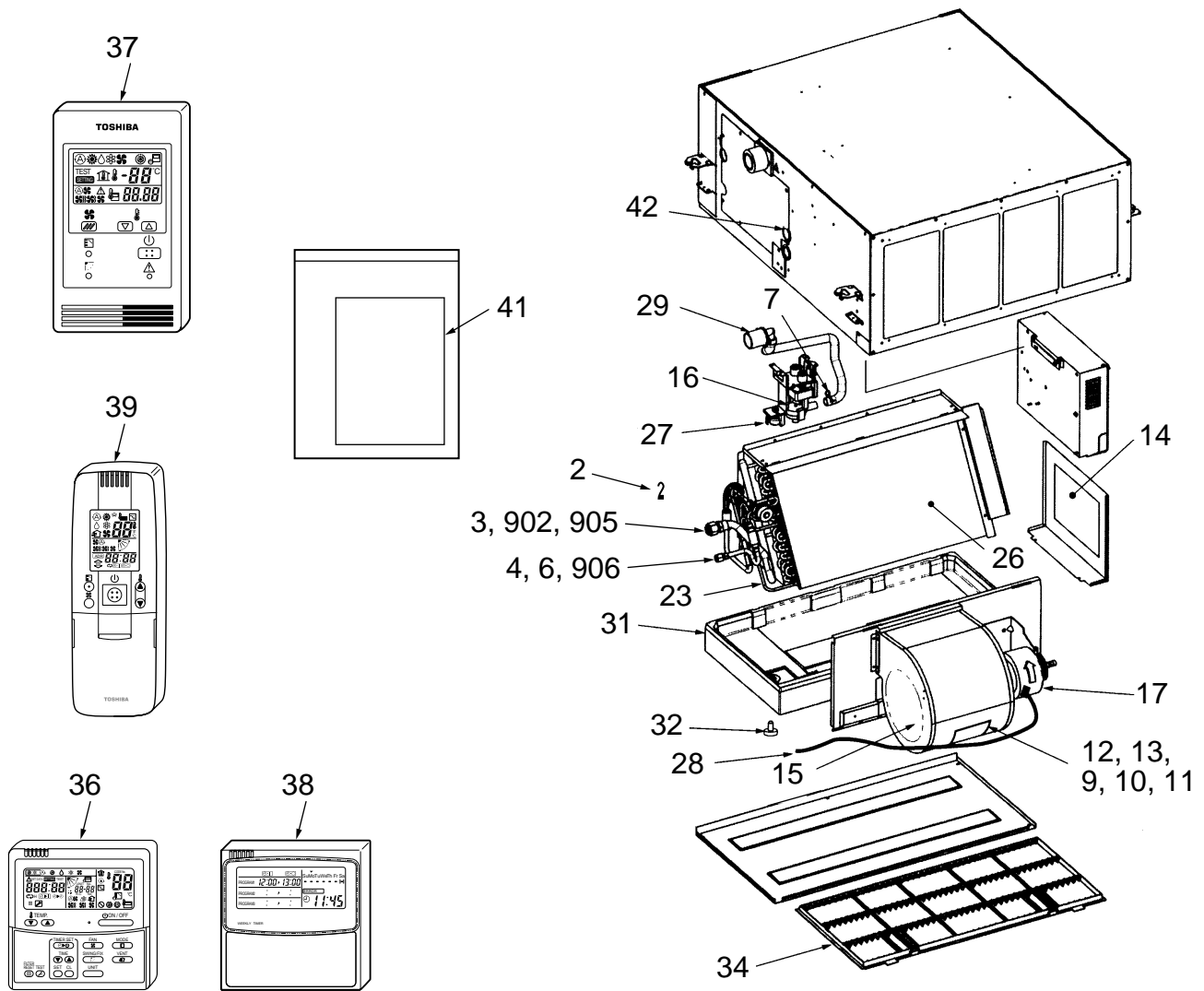

Location No.	Part No.	Description
2	43019904	Holder, Sensor
3	43047303	Bonnet
4	43047685	Nut, Flare, 1/4 IN
6	43049697	Bonnet
7	43079249	Band, Hose
15	43120226	Fan, Multi Blade
16	43121747	Pump Ass'y, Drain
17	43121740	Motor, Fan
23	4314Q015	Distributor Ass'y
26	4314J268	Refrigeration cycle Ass'y
28	43160553	Lead, Motor, Fan
29	43170233	Hose, Drain
31	43172168	Pan Ass'y, Drain
32	43179110	Plug

Location No.	Part No.	Description
34	43180311	Air Filter
36	43166002	Remote Controller, SX-A1EE (RBC-AMT31E)
37	43166004	Remote Controller, SX-A11JE2 (RBC-AS21E2)
38	43166005	Remote Controller, EX-W2JE2 (RBC-EXW21E2)
39	43166006	Remote Controller, WH-H1JE2 (RBC-AX22CE2)
41	4318T683	Owner's Manual
42	43196012	Bushing
902	43149351	Soket
905	43047688	Nut, Flare, 1/2, IN
906	43149353	Soket

RAV-SM802BT-E

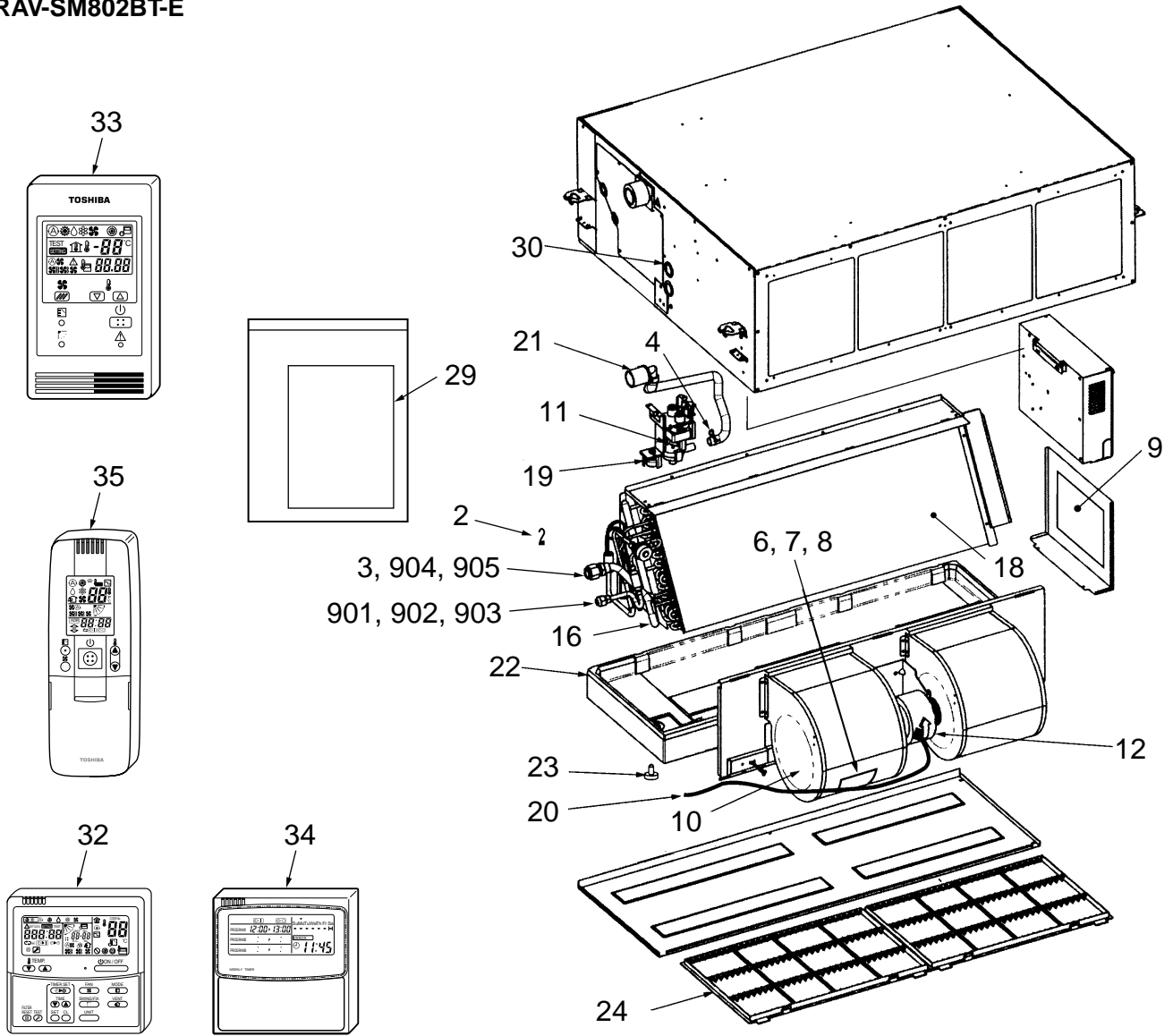

Location No.	Part No.	Description
2	43019904	Holder, Sensor
3	43047609	Bonnet
4	43079249	Band, Hose
10	43120226	Fan, Multi Blade
11	43121747	Pump Ass'y, Drain
12	43121739	Motor, Fan
16	4314Q016	Distributor Ass'y
18	4314J269	Refrigeration cycle Ass'y
20	43160553	Lead, Motor, Fan
21	43170233	Hose, Drain
22	43172167	Pan Ass'y, Drain
23	43179110	Plug
24	43180312	Air Filter
29	4318T683	Owner's Manual

Location No.	Part No.	Description
30	43196012	Bushing
32	43166002	Remote Controller, SX-A1EE (RBC-AMT31E)
33	43166004	Remote Controller, SX-A11JE2 (RBC-AS21E2)
34	43166005	Remote Controller, EX-W2JE2 (RBC-EXW21E2)
35	43166006	Remote Controller, WH-H1JE2 (RBC-AX22CE2)
901	43049776	Soket
902	43194029	Bonnet
903	43149355	Nut, Flare, 3/8, IN
904	43149352	Nut, Flare, 5/8, IN
905	43149354	Soket

RAV-SM1102BT-E, RAV-SM1402BT-E

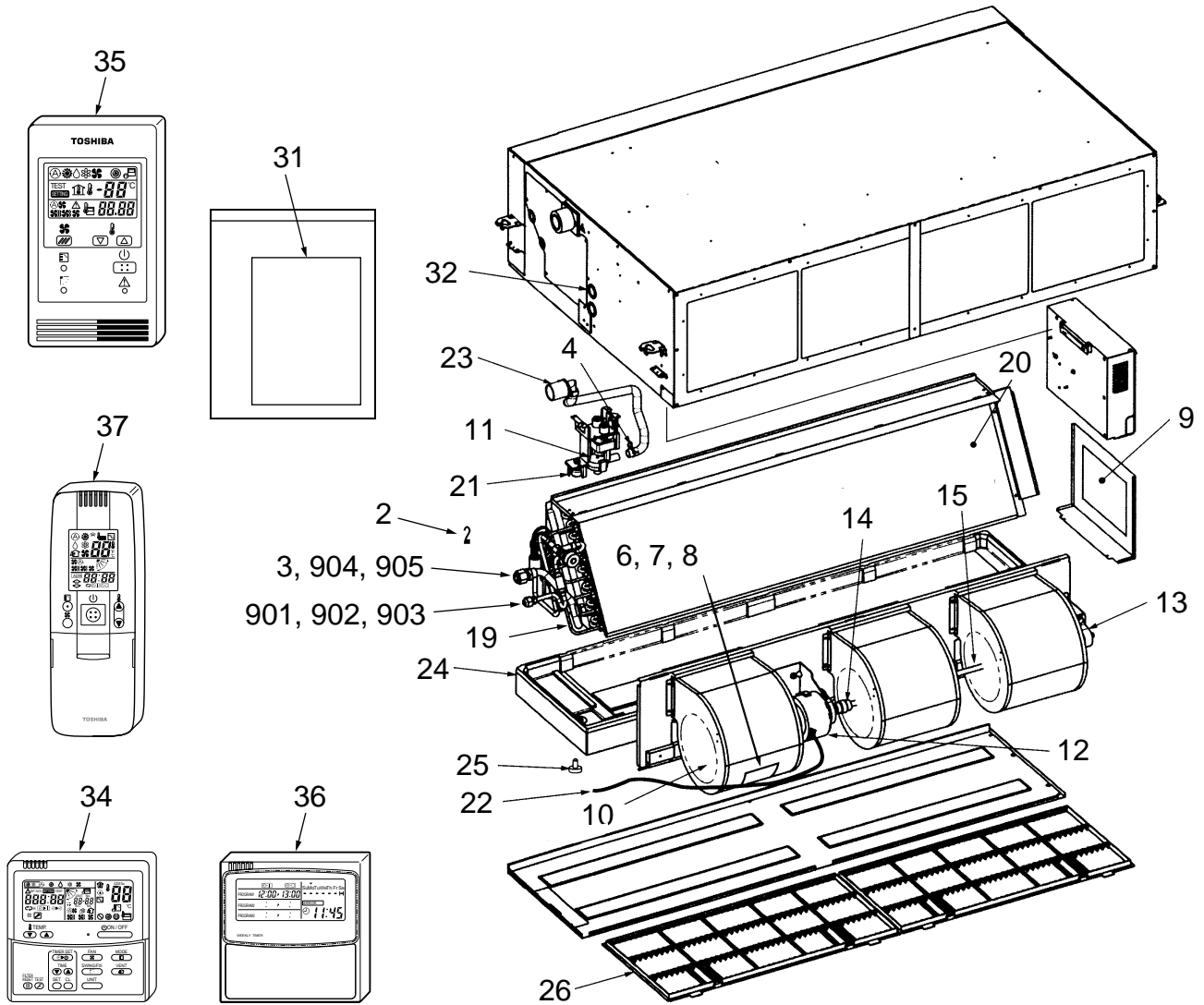

Location No.	Part No.	Description
2	43019904	Holder, Sensor
3	43047609	Bonnet
4	43079249	Band, Hose
10	43120226	Fan, Multi Blade
11	43121747	Pump Ass'y, Drain
12	43121740	Motor, Fan
13	43125131	Bearing, Shaft
14	43125162	Coupling
15	43125163	Shaft
19	4314Q017	Distributor Ass'y
20	4314J270	Refrigeration cycle Ass'y
22	43160553	Lead, Motor, Fan
23	43170233	Hose, Drain
24	43172166	Pan Ass'y, Drain
25	43179110	Plug

Location No.	Part No.	Description
26	43180311	Air Filter
31	4318T683	Owner's Manual
32	43196012	Bushing
34	43166002	Remote Controller, SX-A1EE (RBC-AMT31E)
35	43166004	Remote Controller, SX-A11JE2 (RBC-AS21E2)
36	43166005	Remote Controller, EX-W2JE2 (RBC-EXW21E2)
37	43166006	Remote Controller, WH-H1JE2 (RBC-AX22CE2)
901	43049776	Soket
902	43194029	Bonnet
903	43149355	Nut, Flare, 3/8, IN
904	43149352	Nut, Flare, 5/8, IN
905	43149354	Soket

RAV-SM562BT-E, RAV-SM802BT-E, RAV-SM1102BT-E, RAV-SM1402BT-E

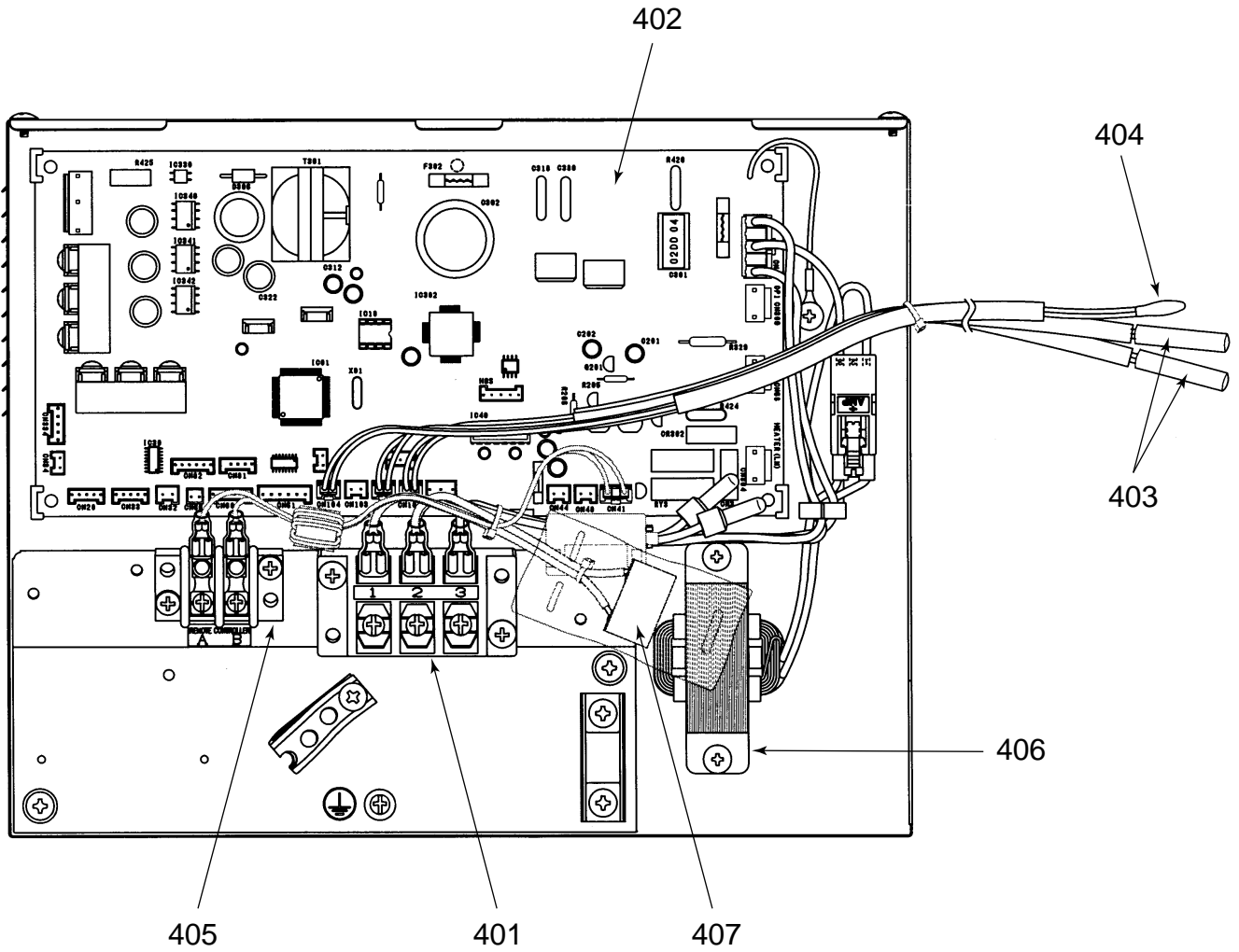

Location No.	Part No.	Description
401	43160565	Terminal Block, 3P, 20A
402	4316V281	P.C. Board Ass'y, MMC-1402
403	43050425	Sensor, TC (F6)
404	43050426	Sensor, TA

Location No.	Part No.	Description
405	43160568	Terminal Block, 2P
406	43158193	Reactor
407	43155203	Capacitor

15-1-3. Under Ceiling Type

RAV-SM562CT-E, RAV-SM802CT-E, RAV-SM1102CT-E, RAV-SM1402CT-E

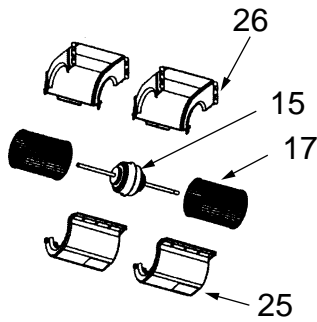
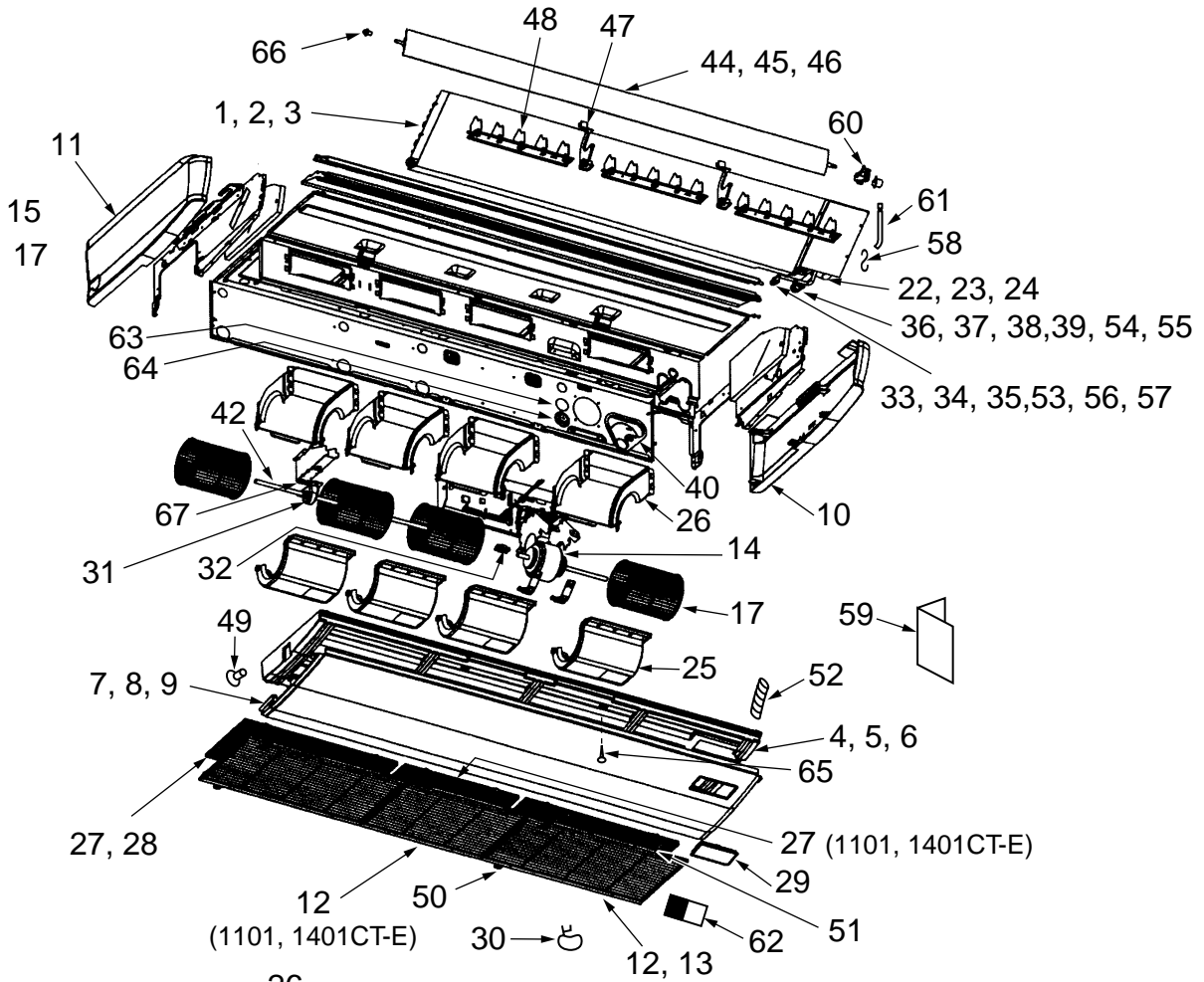

RAV-SM562CT-E
(Fan assembly)

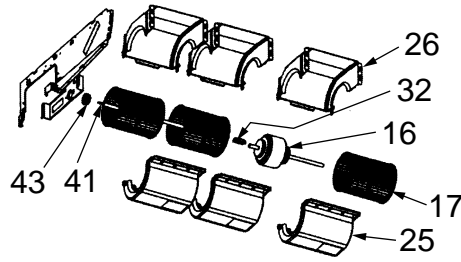

RAV-SM802CT-E
(Fan assembly)

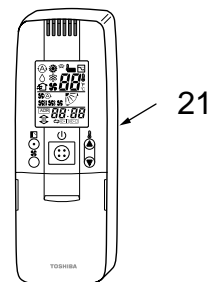
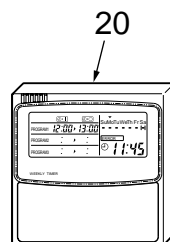
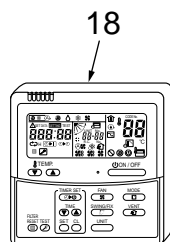
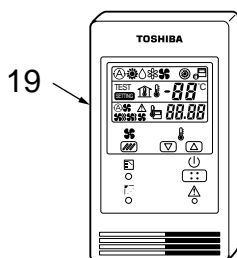

Location No.	Part No.	Description
1	4314J271	Refrigeration cycle Ass'y (SM562CT)
2	4314J272	Refrigeration cycle Ass'y (SM802CT)
3	4314J273	Refrigeration cycle Ass'y (SM1102CT, SM1402CT)
4	43172188	Pan Drain Ass'y (SM562CT)
5	43172189	Pan Drain Ass'y (SM802CT)
6	43172190	Pan Drain Ass'y (SM1102CT, SM1402CT)
7	43100356	Panel, Under (SM562CT)
8	43100357	Panel, Under (SM802CT)
9	43100358	Panel, Under (SM1102CT, SM1402CT)
10	43102647	Cover Ass'y, Right Side
11	43102648	Cover Ass'y, Left Side
12	43109407	Grille, Inlet (SM562CT, SM1102CT, SM1402CT)
13	43109408	Grille, Inlet (SM802CT, SM1102CT, SM1402CT)
14	43121741	Motor, Fan, SWF-280-120-2R, 120W (SM1102CT, SM1402CT)
15	43121742	Motor, Fan, SWF-280-60-1R, 60W (SM562CT)
16	43121743	Motor, Fan, SWF-280-60-2R, 60W (SM802CT)
17	43120227	Fan, Multi Blade
18	43166002	Remote Controller, SX-A1EE (RBC-AMT31E)
19	43166004	Remote Controller, SX-A11JE2 (RBC-AS21E2)
20	43166005	Remote Controller, EX-W2JE2 (RBC-EXW21E2)
21	43166006	Remote Controller, WH-H1JE2 (RBC-AX22CE2)
22	4314Q012	Distributor Ass'y (SM562CT)
23	4314Q013	Distributor Ass'y (SM802CT)
24	4314Q014	Distributor Ass'y (SM1102CT, SM1402CT)
25	43122084	Case, Fan, Lower
26	43122085	Case, Fan, Upper
27	43180314	Air Filter (SM562CT, SM1102CT, SM1402CT)
28	43180315	Air Filter (SM802CT, SM1102CT, SM1402CT)
29	43108014	Base, Receiver
30	43179136	Band, Hose
31	43125131	Bearing, Shaft (SM1102CT, SM1402CT)

Location No.	Part No.	Description
32	43125162	Coupling (SM802CT, SM1102CT, SM1402CT)
33	43047685	Nut, Flare, 1/4 IN (SM562CT)
34	43049776	Socket (SM802CT, SM1102CT, SM1402CT)
35	43149351	Socket (SM562CT)
36	43047688	Nut, Flare, 1/2 IN (SM562CT)
37	43149352	Nut, Flare, 5/8 IN (SM802CT, SM1102CT, SM1402CT)
38	43149353	Socket, 1/2 IN (SM562CT)
39	43149354	Socket, 5/8 IN (SM802CT, SM1102CT, SM1402CT)
40	43149326	Cover, Back Base
41	43125164	Shaft, SS400B-D2 12 (SM802CT)
42	43125165	Shaft, SS400B-12 DIA (SM1102CT, SM1402CT)
43	43125159	Bearing (SM802CT)
44	43109409	Grille Ass'y, Horizontal (SM562CT)
45	43109410	Grille Ass'y, Horizontal (SM802CT)
46	43109411	Grille Ass'y, Horizontal (SM1102CT, SM1402CT)
47	43107260	Support, Grille Horizontal
48	43122086	Grille Ass'y, Vertical
49	43179129	Cap Drain
50	43107254	Hinge, Grille Inlet
51	43107255	Hook, Grille Inlet
52	43170234	Hose, Drain
53	43047609	Bonnet (SM802CT, SM1102CT, SM1402CT)
54	43047303	Bonnet (SM562CT)
55	43194029	Bonnet (SM802CT, SM1102CT, SM1402CT)
56	43149355	Nut, Flare, 3/8 IN (SM802CT, SM1102CT, SM1402CT)
57	43049697	Bonnet (SM562CT)
58	43019904	Holder, Sensor
59	4318T682	Owner's Manual
60	43121746	Driver Ass'y, Horizontal L Louver
61	43160556	Lead, Louver Horizontal
62	43108016	Mark TOSHIBA
63	43162049	Bushing, 50DIA
64	43162050	Bushing, 56DIA
65	43197189	Screw, Fix Drain Pan
66	43107252	Shaft, Horizontal Louver
67	43139153	Spacer, Bearing (SM1102CT, SM1402CT)

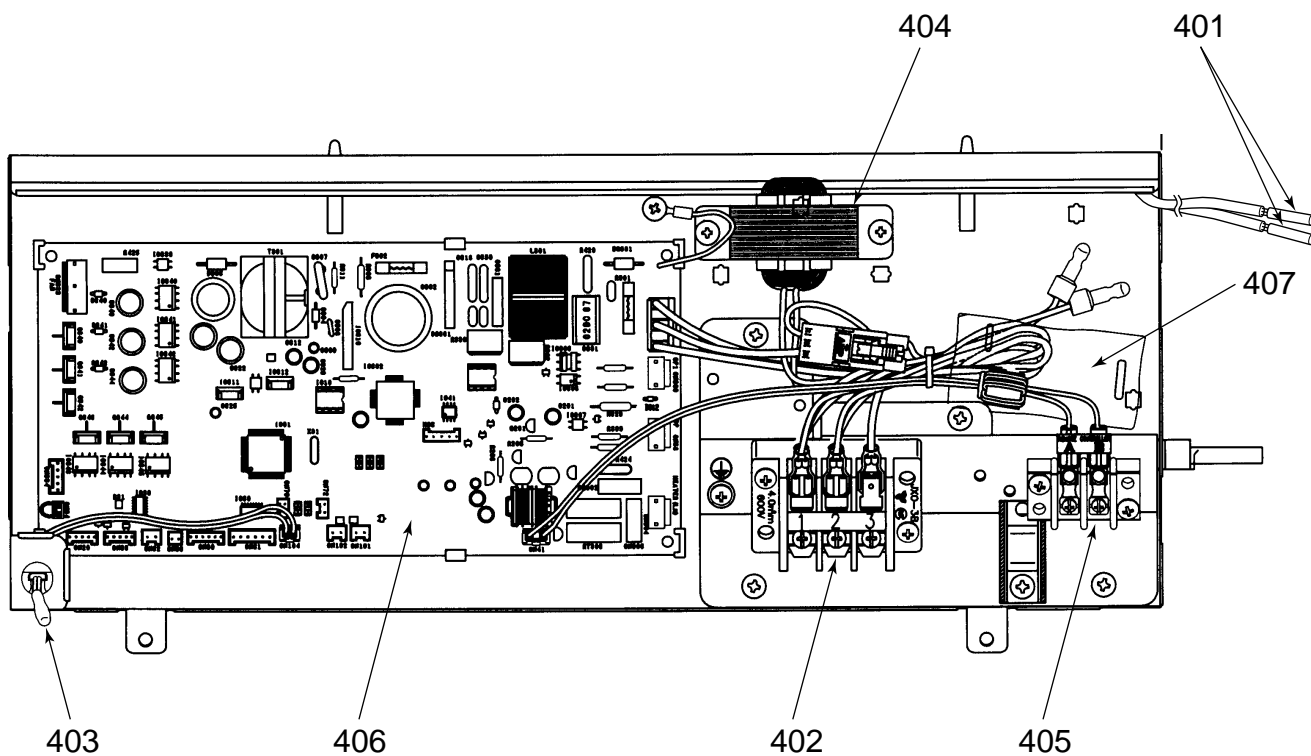

Location No.	Part No.	Description
401	43050425	Sensor, TC (F6)
402	43160565	Terminal Block, 3P, 20A
403	43050426	Sensor, TA
404	43158193	Reactor

Location No.	Part No.	Description
405	43160568	Terminal Block, 2P
406	4316V280	P.C. Board Ass'y, MMC-1402
407	43155203	Capacitor

15-2. Outdoor Unit

RAV-SM563AT-E, RAV-SM803AT-E

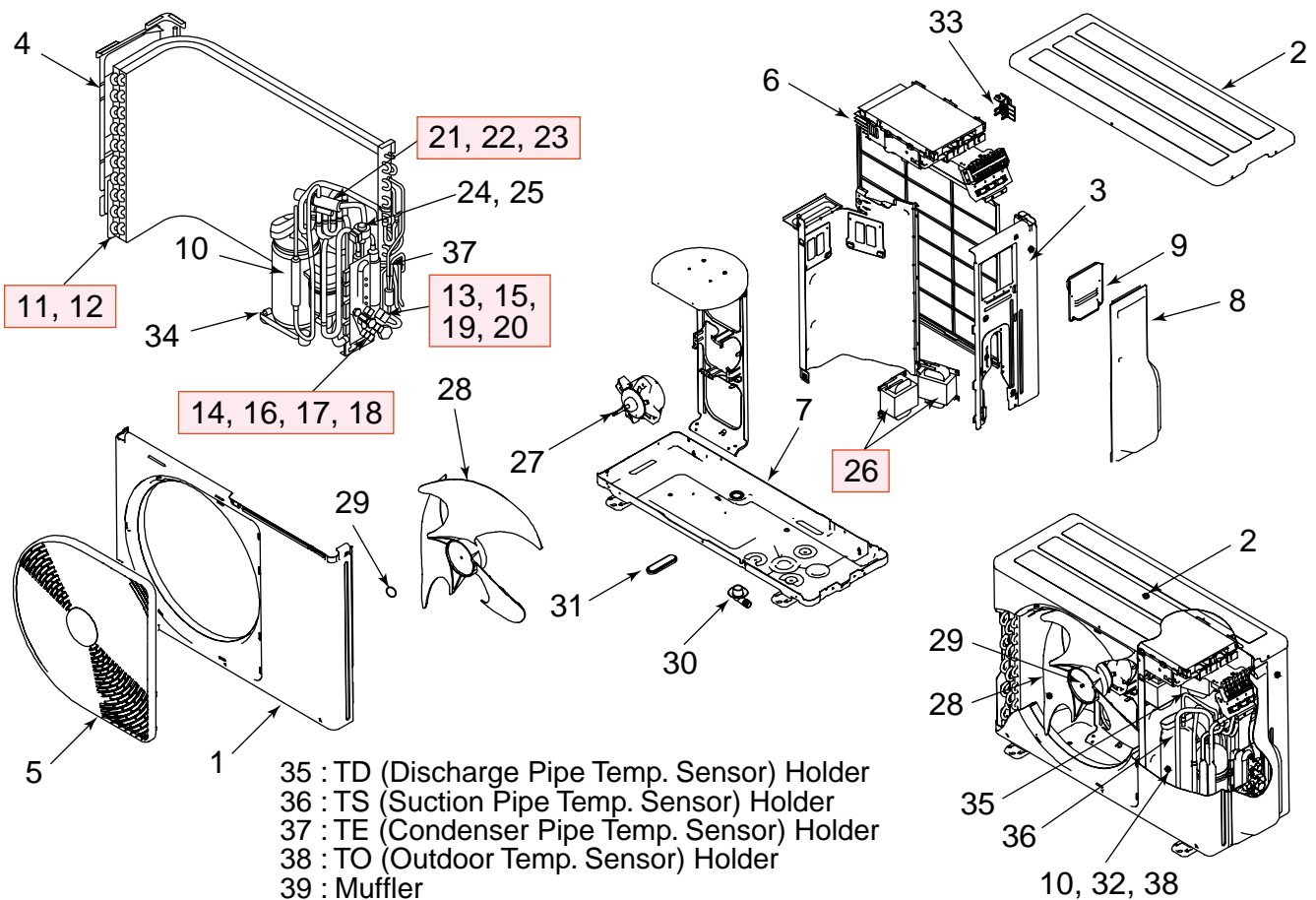

Location No.	Part No.	Description
1	43005657	Cabinet, Front
2	43005642	Cabinet, Upper
3	43005658	Cabinet, Side, Right
4	43005634	Cabinet, Side, Left
5	4301V035	Guard, Fan
6	4301V053	Guard, Fin
7	43100346	Base Ass'y
8	43119471	Cover, Valve, Packed
9	43162055	Cover, Wiring Ass'y
10	43041786	Compressor Ass'y, DA150, A1F-20F
11	4314G204	Condenser Ass'y (SM563AT-E)
12	4314G251	Condenser Ass'y (SM803AT-E)
13	37546845	Valve, Packed, 6.35 (SM563AT-E)
14	43146680	Valve, Packed, 12.7 (SM563AT-E)
15	43146686	Valve, Packed, 9.52 (SM803AT-E)
16	43146681	Valve, Packed, 15.9 (SM803AT-E)
17	43147196	Bonnet, 1/4 IN (SM563AT-E)
18	43147195	Bonnet, 1/2 IN (SM563AT-E)

Location No.	Part No.	Description
19	43194029	Bonnet (SM803AT-E)
20	43047401	Bonnet, 3/8 IN (SM803AT-E)
21	43046444	Valve, 4-Way, STF-0108Z (SM563AT-E)
22	43046445	Valve, 4-Way, STF-0213Z (SM803AT-E)
23	43146722	Coil, Solenoid,
24	43146695	Valve, Pulse, Modulating
25	37546849	Coil, PMV, CAM-MD12TF-1
26	43055521	Reactor
27	4302C068	Motor, Fan, ICF-140-43-4
28	43020329	Fan, Propeller, PJ421
29	43047669	Nut, Flange
30	43032441	Nipple, Drain
31	43089160	Cap, Waterproof
32	43050407	Thermostat, Bimetal
33	43063339	Holder, Sensor (TO)
34	43049749	Rebber, Cushion
35	43063321	Holder, Sensor
36	43063322	Holder, Sensor
37	43063325	Holder, Sensor
38	43063317	Holder, Thermostat
39	4314Q064	Muffler (SM563AT-E)
39	4314Q063	Muffler (SM803AT-E)

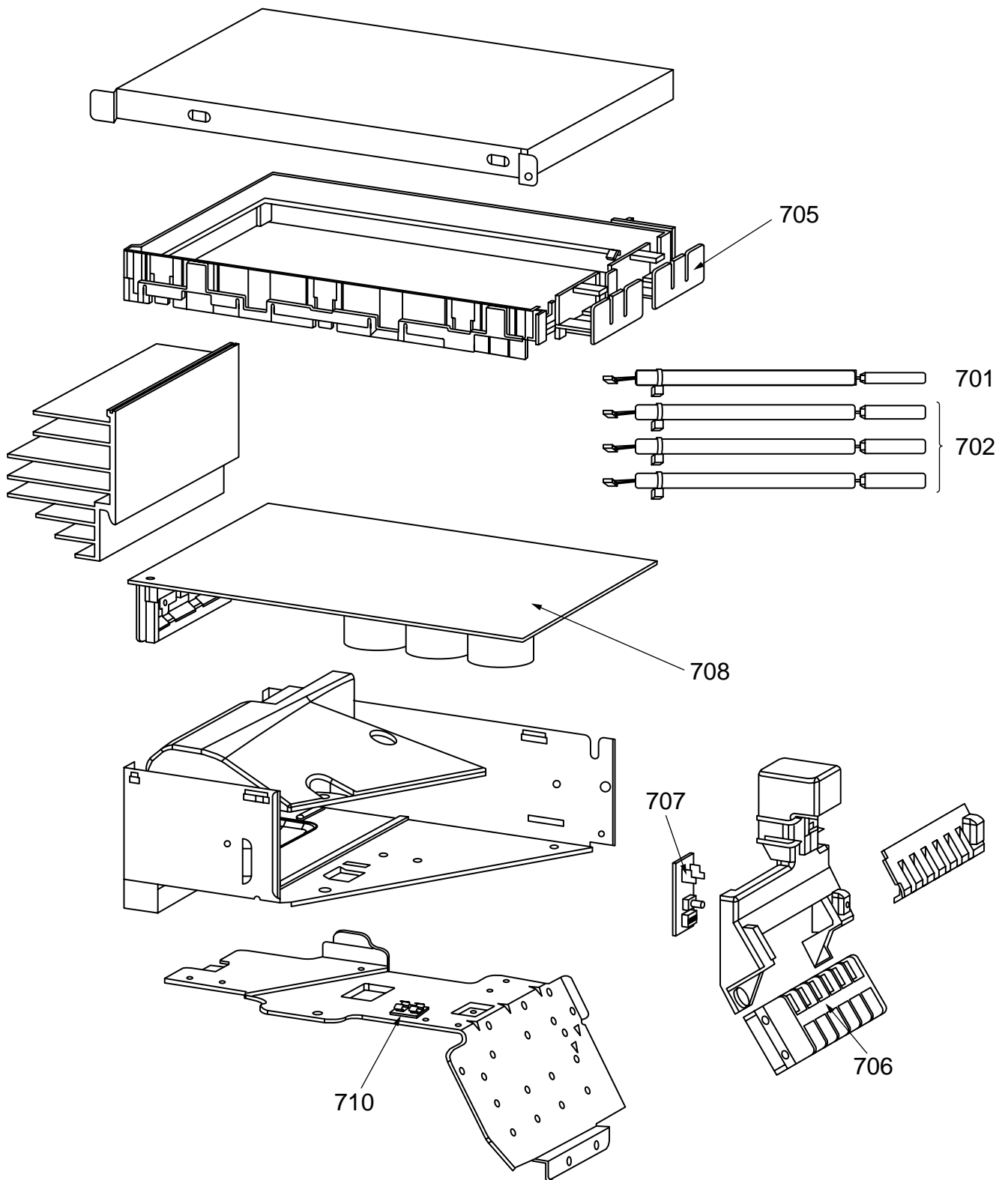

Location No.	Part No.	Description
701	43150319	Sensor Ass'y, Service
702	43050425	Sensor Ass'y, Service
705	43062228	Base, P.C. Board
706	43160566	Terminal Block, 6P, 20A

Location No.	Part No.	Description
707	4316V293	P.C. Board Ass'y, SW, MCC-1530
708	4316V284	P.C. Board Ass'y, MCC-5009
710	43160571	Fuse Holder, 15A, 250V

RAV-SM1103AT-E, RAV-SM1403AT-E

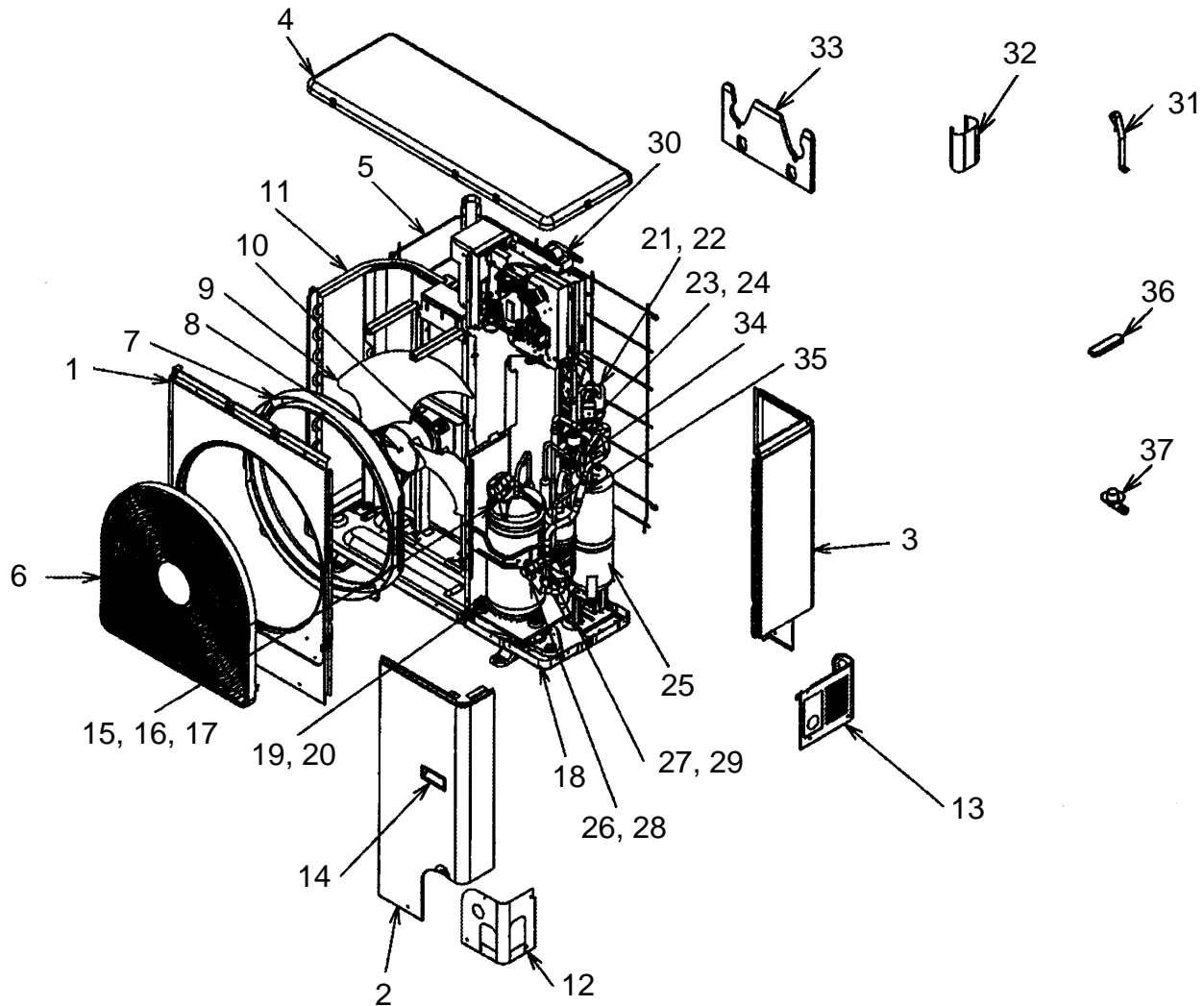

Location No.	Part No.	Description
1	43005635	Cabinet, Air Outled
2	43100350	Cabinet, Front Ass'y
3	43100349	Cabinet, Side Ass'y
4	43100355	Panel, Upper
5	43191633	Guard, Fin
6	43191651	Guard, Fan
7	43122065	Bell Mouth
8	43047669	Nut, Flange
9	43120224	Fan, Propeller, PE492
10	43121744	Motor, Fan, ICF-280-100-1R
11	4314G209	Condenser Ass'y
12	43100347	Panel, Front, Piping
13	43100345	Panel, Back, Piping
14	43119390	Hanger
15	43041787	Compressor Ass'y, DA420A3F-21M
16	43050407	Thermostat, Bimetal
17	43063317	Holder, Thermostat
18	43100343	Base Ass'y
19	43197183	Bolt, Compressor

Location No.	Part No.	Description
20	43149324	Rubber, Cushion, EPDM
21	43046445	Valve, 4-WAY, STF-0213Z
22	43146722	Coil, Solenoid, STF-01AJ502E1
23	43146634	Valve, Pulse, Modulating
24	43146685	Coil, PMV, UKV-U048E
25	43148170	Accumulator Ass'y
26	43146686	Valve, Packed, 9.52 DIA
27	43146699	Valve, Ball
28	43047401	Bonnet, 3/8 IN
29	43194029	Bonnet
30	43158190	Reactor
31	43019904	Holder, Sensor
32	43063188	Holder, TC Sensor
33	43063332	Holder, Sensor
34	4314Q019	Strainer
35	4314Q033	Strainer
36	43089160	Cap, Waterproof
37	43032441	Nipple, Drain

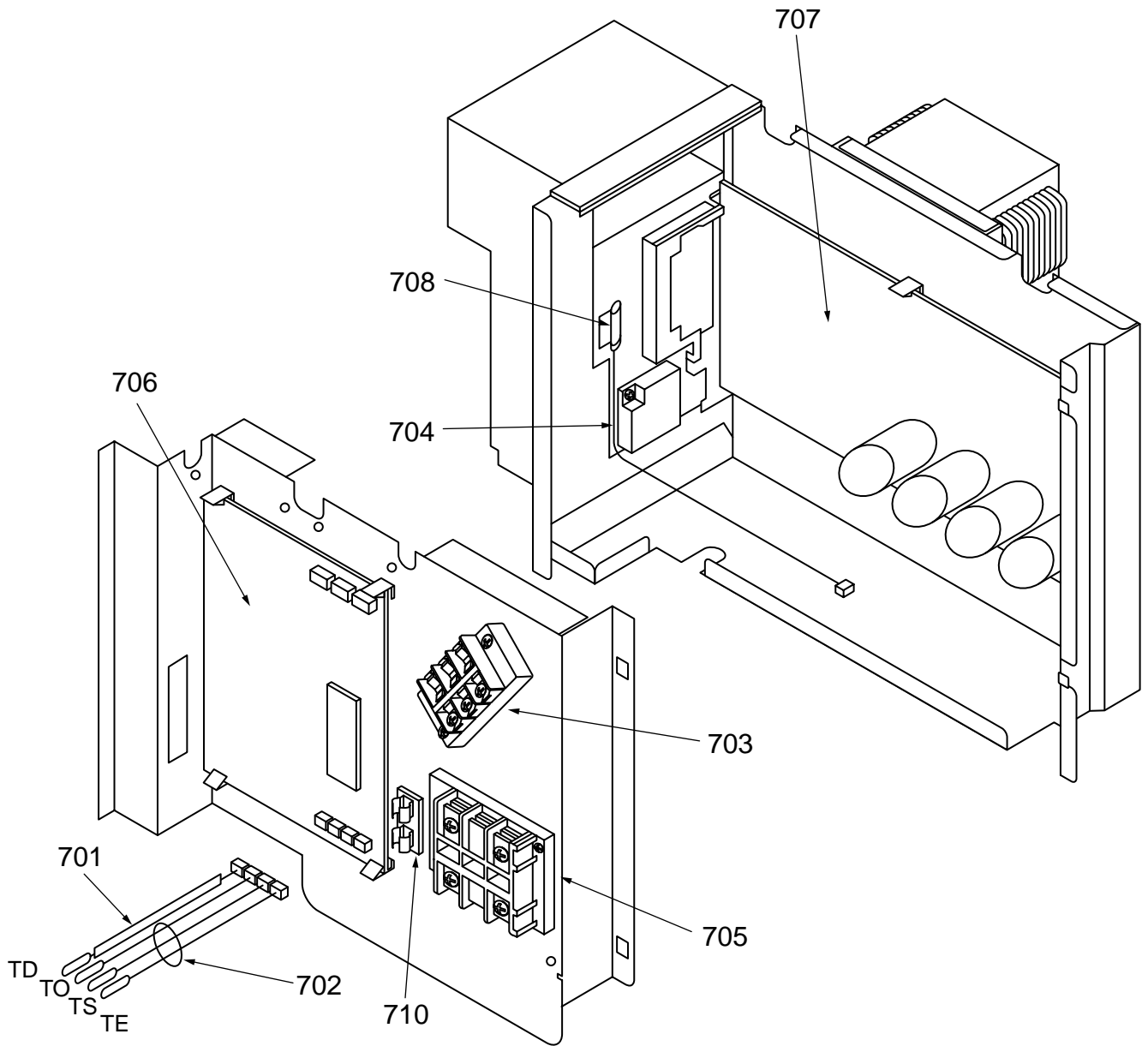

Location No.	Part No.	Description
701	43150319	Sensor Ass'y, Service
702	43050425	Sensor Ass'y, Service
703	43160565	Terminal Block, 3P, 20A
704	43131052	Rectifier
705	43160567	Terminal Block, 3P, 30A

Location No.	Part No.	Description
706	4316V283	P.C. Board Ass'y, CDB, MCC-1531
707	4316V291	P.C. Board Ass'y, IPDU, MCC-1438
708	43150320	Sensor Ass'y, Service
710	43160571	Fuse Holder, 15A, 250V

RAV-SP562AT-E, RAV-SP802AT-E

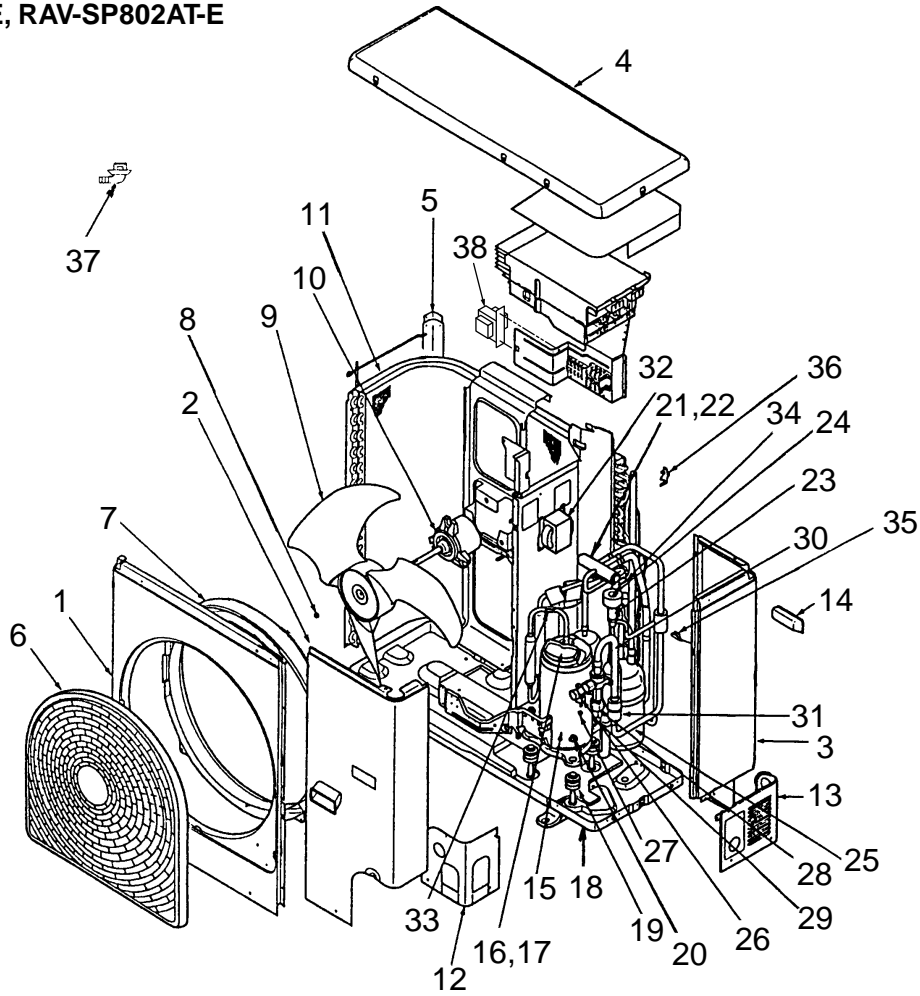

Location No.	Part No.	Description
1	43100348	Cabinet, Air Outlet
2	43100350	Cabinet, Front Ass'y
3	43100349	Cabinet, Side Ass'y
4	43100351	Panel, Upper
5	43005489	Guard, Fin
6	43191651	Guard, Fan, PP-K
7	43122065	Bell, Mouth
8	43047669	Nut, Flange
9	43120213	Fan, Propeller, PJ491, AS-G
10	4302C069	Motor, Fan, ICF-140-63-2R
11	4314G205	Condenser Ass'y (SP802AT-E)
11	4314G200	Condenser Ass'y (SP562AT-E)
12	43100347	Panel, Front, Piping
13	43100345	Panel, Back, Piping
14	43119390	Hanger
15	43041785	Compressor Ass'y, DA220A2F-20L
16	43050407	Thermostat, Bimetal
17	43063317	Holder, Thermostat
18	43100342	Base Ass'y
19	43049739	Cushion, Rubber
20	43097212	Nut
21	43046445	Valve, 4-Way, STF-0213Z
22	43046443	Coil, Solenoid, VHV-01AJ503C1

Location No.	Part No.	Description
23	43146695	Valve, Pulse, Modulating, CAMB30YGTF-2
24	43046450	Coil, PMV, CAM-MD12TF-8
25	43048066	Accumulator Ass'y
26	43046392	Valve, Packed, 6.35 (SP562AT-E)
26	37546845	Valve, Packed, 9.52DIA (SP802AT-E)
27	43047686	Bonnet, 3/8 IN (SP802AT-E)
27	43147196	Bonnet, 1/4 IN (SP562AT-E)
28	43146680	Valve, Packed, 12.7, HKU-R410A-H4 (SP562AT-E)
28	43146699	Valve, Ball (SP802AT-E)
29	43147194	Bonnet, 5/8 IN (SP802AT-E)
29	43047303	Bonnet, 1/2 IN (SP562AT-E)
30	4314Q018	Strainer
31	4314Q021	Strainer (SP562AT-E)
31	4314Q022	Strainer (SP802AT-E)
32	43058276	Reactor, CH47-Z-T
33	43063321	Holder, Sensor
34	43063322	Holder, Sensor
35	43063325	Holder, Sensor
36	43063332	Holder, Sensor
37	43032441	Nipple, Drain
38	43158192	Reactor, CH-43-Z-T

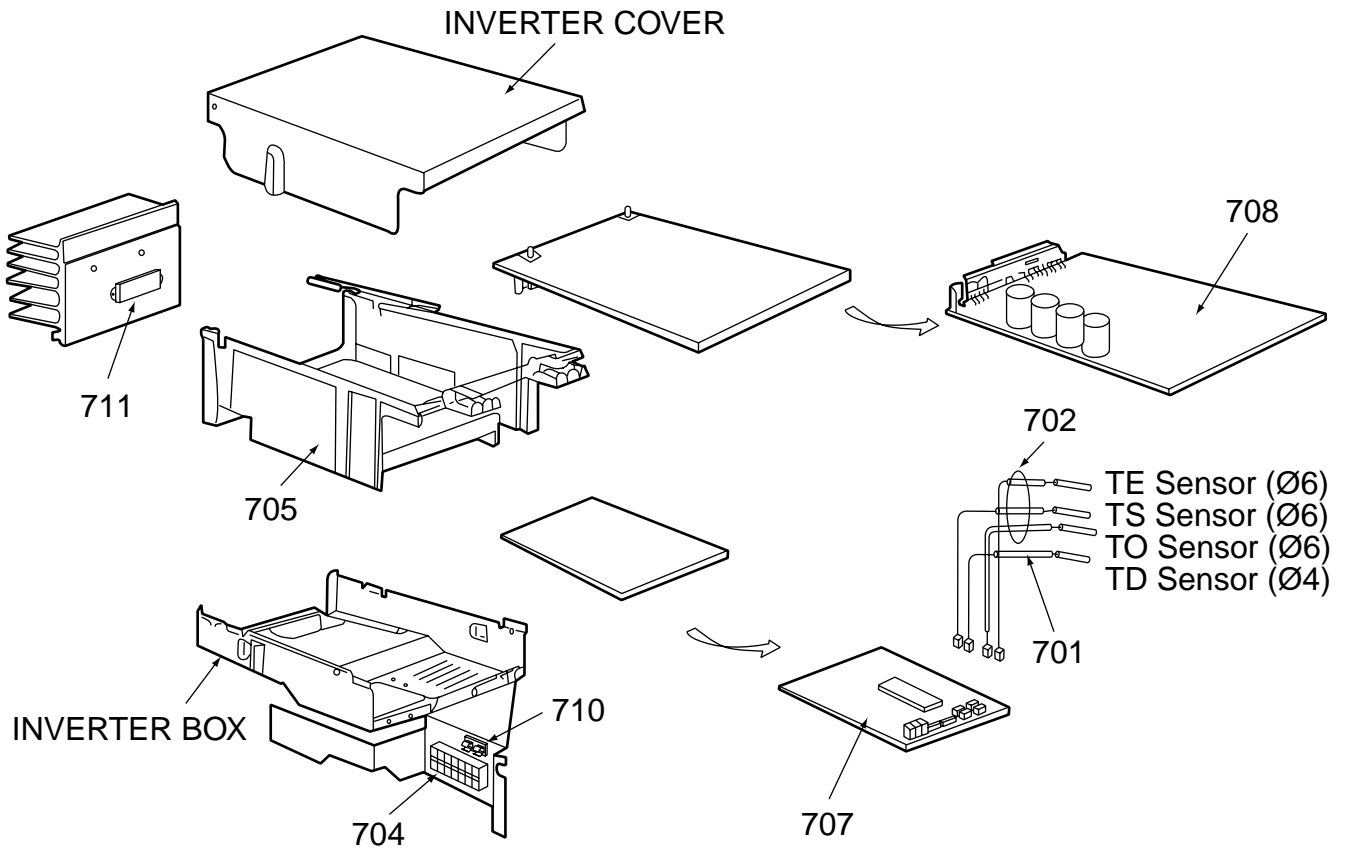

Location No.	Part No.	Description
701	43150319	Sensor, TD (F4)
702	43050425	Sensor, TC (F6)
704	43160566	Terminal Block, 6P, 20A
705	43162042	Base, P.C. Board
707	4316V282	P.C. Board Ass'y, CDB, MCC-1531

Location No.	Part No.	Description
708	4316V278	P.C. Board Ass'y, IPDU, MCC-1438
710	43160571	Fuse Holder, 15A, 250V
711	43131052	Rectifier

RAV-SP1102AT-E, RAV-SP1402AT-E

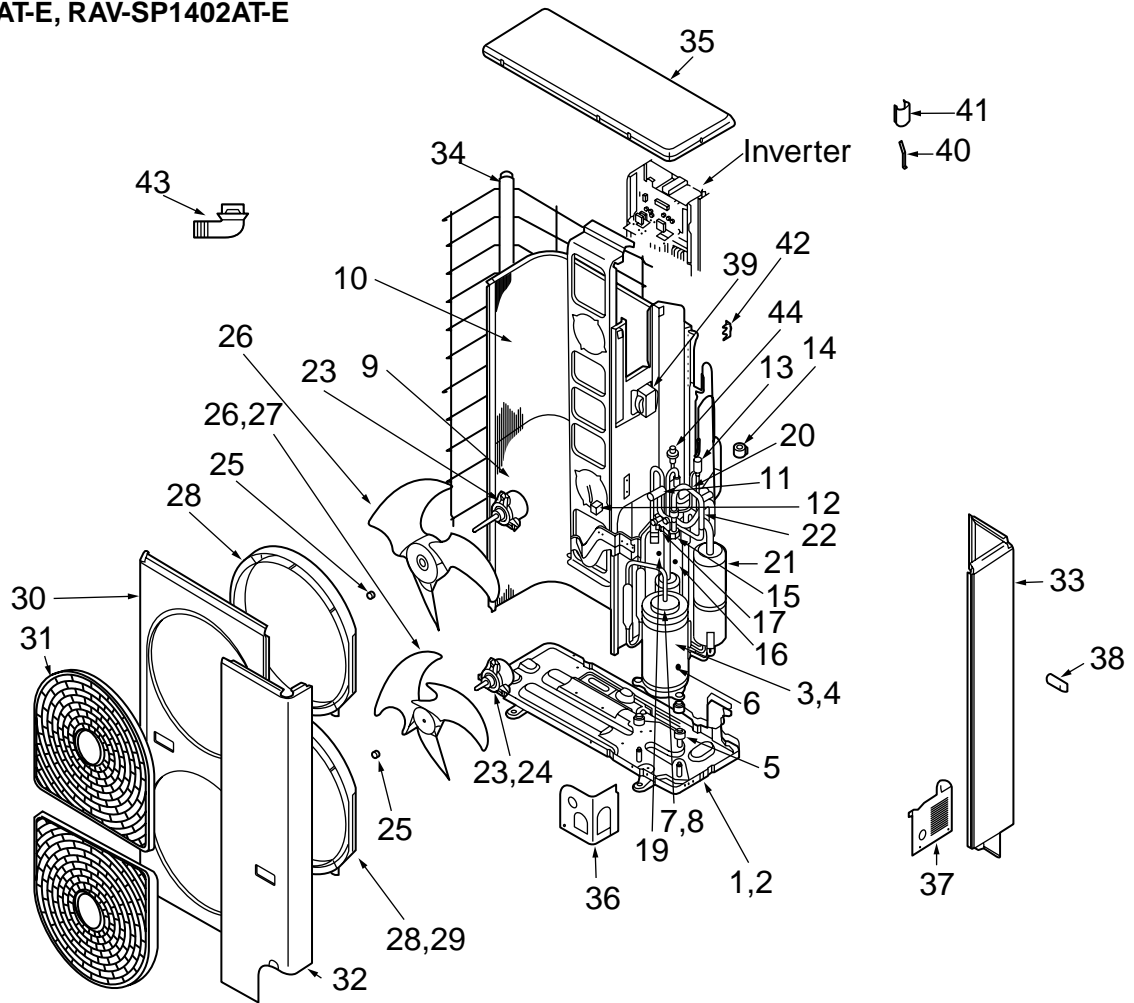

Location No.	Part No.	Description
2	43100343	Base Ass'y
4	43041787	Compressor Ass'y, DA420A3F-21M
5	43049739	Cushion, Rubber
6	43097212	Nut
7	43050407	Thermostat, Bimetal
8	43063317	Holder, Thermostat
9	4314G207	Condenser, Down
10	4314G208	Condenser, Up
11	43146687	Valve, 4-WAY, STF-0401G
12	43146683	Coil, Solenoid, VHV-01AJ502E1,
13	43146634	Valve, Pulse, Modulating, UKV-25D22
14	43146695	Coil, PMV
15	43146613	Valve, Ball, 5/8 IN
16	43147194	Bonnet, 5/8 IN
17	43146686	Valve, Packed, 3/8 IN
19	43047401	Bonnet, 3/8 IN
20	4314Q019	Strainer
21	43148170	Accumulator Ass'y, 2.5L

Location No.	Part No.	Description
21	43148170	Accumulator Ass'y, 2.5L
22	4314Q020	Strainer
23	4302C069	Motor, Fan, ICF-140-63-2R
25	43047669	Nut, Flange
26	43120213	Fan, Propeller, PJ491, AS-G
28	43122065	Bell Mouth, Plastic
30	43100352	Panel, Air Outlet
31	43191651	Guard, Fan, PP-K
32	43100353	Panel, Front
33	43100354	Panel, Side
34	43191602	Guard, Fin
35	43100355	Plate, Roof
36	43100347	Panel, Front, Piping
37	43100345	Panel, Back, Piping
38	43119390	Hanger
39	43158190	Peacter, CH-62-Z-T
40	43019904	Holder, Sensor, SUS
41	43063188	Holder, TC Sensor
42	43063332	Holder, Sensor
43	43032441	Nipple, Drain
44	43146676	Check, Joint

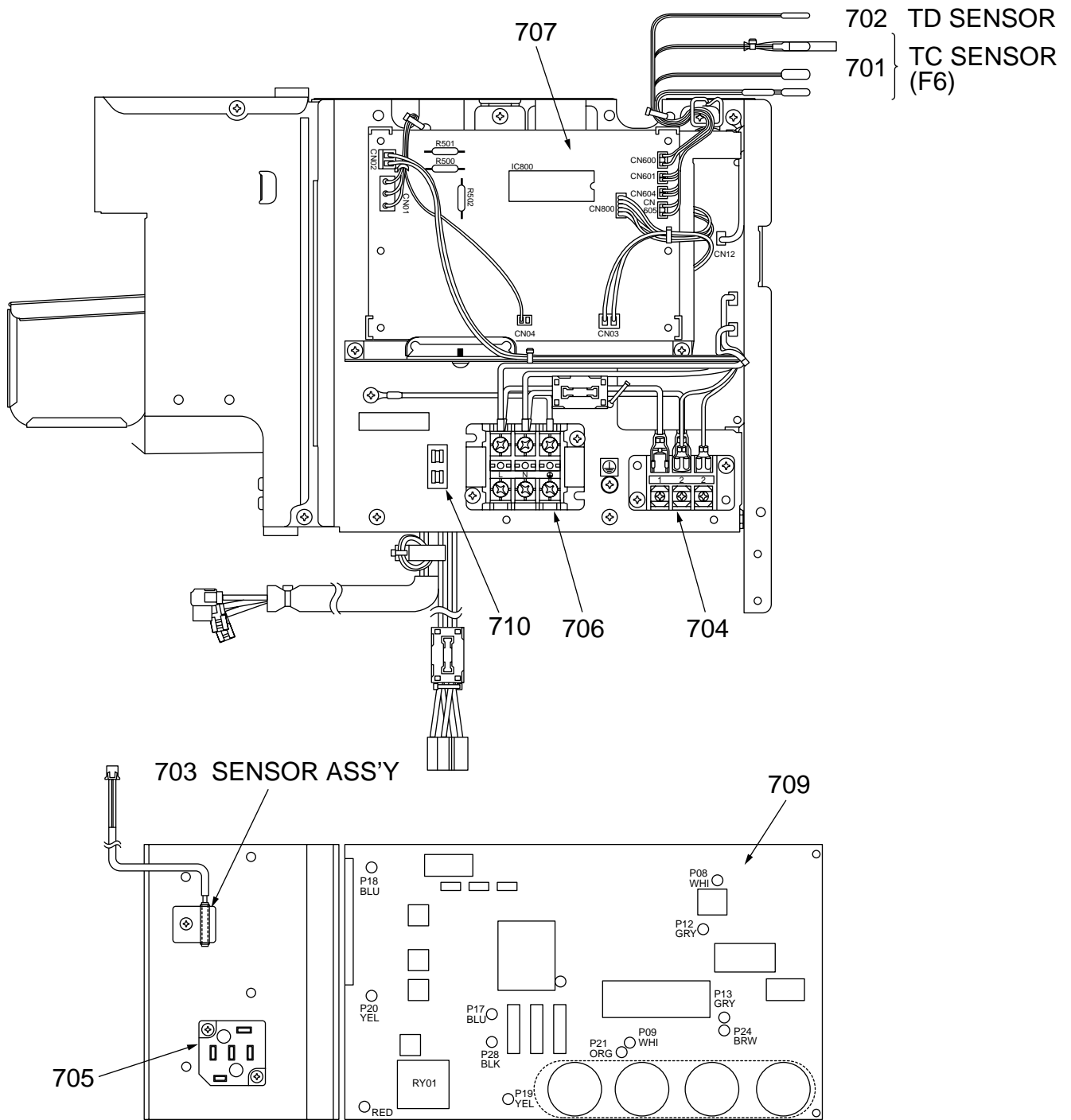

Location No.	Part No.	Description
701	43050425	Sensor Ass'y, Service
702	43150319	Sensor Ass'y, Service
703	43150320	Sensor Ass'y, Service
704	43160565	Terminal Block, 3P, 20A
705	43131052	Rectifier
706	43160567	Terminal Block, 3P, 30A

Location No.	Part No.	Description
707	4316V282	P.C. Board Ass'y, CDB, MCC-1531
709	4316V291	P.C. Board Ass'y, IPDU, MCC-1438
710	43160571	Fuse Holder, 15A, 250V

15-3. Replacement of Main Parts (Sold Separately)

15-3-1. Drain up Kit

TCB-DP22CE2

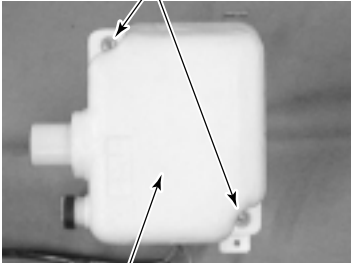
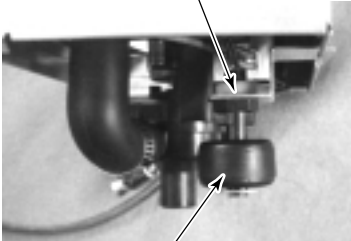
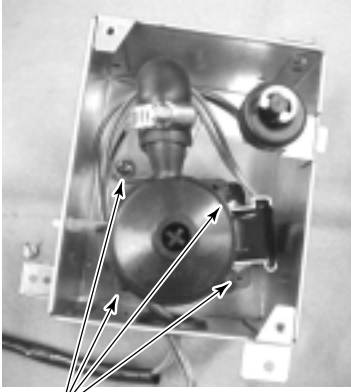
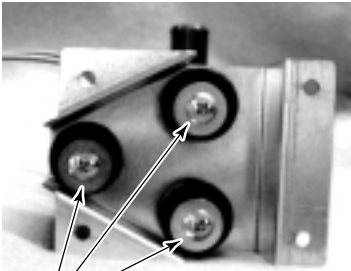
No.	Part name	Procedure	Remarks
①	Drain pan	<ol style="list-style-type: none"> 1. Remove the Drain up kit from the main unit. 2. Remove the set screws (2 positions) and drain pan. 	<p data-bbox="1018 389 1310 434">Screws (Fixing drain pan and main unit)</p>  <p data-bbox="1062 730 1155 752">Drain pan</p> <p data-bbox="1362 685 1410 707">①-2</p>
②	Float switch	<ol style="list-style-type: none"> 1. Remove the drain pan. 2. Remove the plastics nut of fixing float switch. 3. Remove the float switch. 	<p data-bbox="1129 819 1238 842">Plastics nut</p>  <p data-bbox="1094 1122 1203 1144">Float switch</p> <p data-bbox="1362 1077 1410 1099">②-2</p>
③	Drain pump	<ol style="list-style-type: none"> 1. Remove the drain pan. 2. Remove the set screws (4 positions) of fixing drain pump plate and main unit. 3. Remove the screws (3 positions) of fixing drain pump plate and drain pump. 	 <p data-bbox="1018 1630 1326 1675">Screws (Fixing drain pump and main unit)</p> <p data-bbox="1362 1581 1410 1603">③-2</p>  <p data-bbox="1007 2007 1326 2051">Screws (Fixing drain pump and drain plate)</p> <p data-bbox="1362 1973 1410 1995">③-3</p>

15-3-2. Wireless Remote Control Kit

RBC-AX22CE2

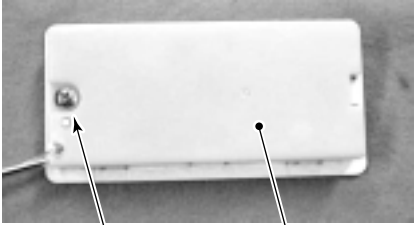
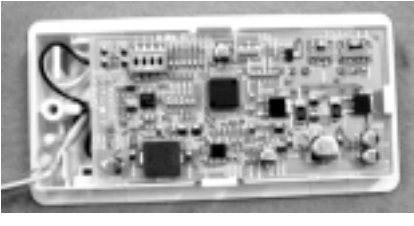
No.	Part name	Procedure	Remarks
①	P.C. board	<ol style="list-style-type: none"> 1. Remove the signal receiving unit from main unit. 2. Remove the set screw (1 position) and P.C. board cover. 3. Remove the p.c. board. 	 <p style="text-align: right;">①-2</p> <p style="text-align: center;">Screw P.C. board cover</p>  <p style="text-align: right;">①-3</p>

16. CORD HEATER INSTALLATION WORK

This is on installation for 2 HP and 3 HP Products

(RAV-SM563AT-E, RAV-SM803AT-E, RAV-SP562AT-E, RAV-SP802AT-E).

In case of 4 HP or 5 HP, refer to this installation as reference.

16-1. Required parts for installation work (Recommendation)

The above products conform to RoHS (2002/95/EC). Therefore when procuring and using the following recommended parts at local site, it is recommended to confirm each part conforms to RoHS before use.

No.	Part name	Q'ty	Specifications/Vendor	Remarks
1	Cord heater	1	Drain line heaters CSC2 (3.0m, 40W/m) by Flexelec com. (Please go to the following URL.) http://www.flexelec.com	Procured locally
2	Thermostat	1	US-622AXRLQE by ASAHI KEIKI Operating temperature: on $4 \pm 4^{\circ}\text{C}$, off $15 \pm 3^{\circ}\text{C}$ A thermostat holder is incorporated with a thermostat in the package. (Please go to the following URL.) http://www.asahikeiki.co.jp/product/product.html On self-responsibility, you can use a product manufactured by other company (For example, Texas Instruments) if its characteristics are equivalent to those of ASAHI KEIKI. However, when the shape of the thermostat holder is different from that of ASAHI KEIKI, apply some treatment to No.14 thermostat fixing plate and then fix the holder.	Procured locally
3	Fuse	1	ES3-5000, 250V / 5A by NAGASAWA Electric Co. (Please go to the following URL.) http://www.nagasawa-el.co.jp/ On self-responsibility, you can use a product manufactured by other company if its characteristics are equivalent to those of NAGASAWA Electric Co.	Procured locally
4	Fuse holder	1	GM1H-02 by NAGASAWA Electric Co. (Please go to the following URL.) http://www.nagasawa-el.co.jp/ On self-responsibility, you can use a product manufactured by other company if its characteristics are equivalent to those of NAGASAWA Electric Co.	Procured locally
5	P-shape clamp	13	Use heat-resistance, weatherproof and non-hydrolytic type. Material: 4-fluorinated ethylene copolymer Harness diameter: $\varnothing 5.9$ Use equivalence with the above specifications. 11 pieces are used to fix the cord heater to the outdoor unit base plate. One piece is used to fix the power cord to the thermostat fixing plate. One piece is used to fix the power cord to the terminal fixing plate.	Procured locally
6	P-shape clamp	1	Use heat-resistance, weatherproof and non-hydrolytic type. Material: 4-fluorinated ethylene copolymer Harness diameter: $\varnothing 9.1$ Use equivalence with the above specifications. One piece is used to fix the cord heater to the outdoor unit base plate.	Procured locally
7	Screw	12	Self-tapping screw type-B $\varnothing 4 \times 6\text{mm}$, truss head, stainless These screws are used to fix the cord heater to the outdoor unit base plate with P-shape clamp.	Procured locally
8	Screw	4	Self-tapping screw type-B $\varnothing 4 \times 8\text{mm}$, truss head, stainless Two screws are used to fix the thermostat fixing plate to the side cabinet (R). One screw is used to fix the power cord to the thermostat fixing plate. One screw is used to fix the power cord to the terminal fixing plate.	Procured locally
9	Screw	2	Self-tapping screw type-B $\varnothing 3.5 \times 6\text{mm}$, pan head These screws are used to fix the thermostat to the thermostat fixing plate with the thermostat holder.	Procured locally
10	Faston	2	#250 They are used for the connecting part to the thermostat.	Procured locally
11	Sleeve for Faston	2	UL sleeve for #250	Procured locally
12	Close-end connector	2	Use the most appropriate connector with the power cord diameter.	Procured locally

No.	Part name	Q'ty	Specifications/Vendor	Remarks
13	Power cord	1	2-cores x 0.75mm ² or more, H05RN-F	Procured locally
14	Thermostat fixing plate	1	Material: SGCC-Z08, Board thickness: 0.8t	Procured locally (Drawing attached)
15	PVC tube	1	Inside diameter Ø8 x outside diameter Ø11 x 70 mm	Procured locally
16	Shield tube	1	Inside diameter Ø18 x outside diameter Ø26 x 70 mm Material: Polyethylene foam	Procured locally
17	Bundling tie	1	Bundling tie for securing the wires Material: 6/6 nylon	Procured locally

NOTE: The parts on the above table are recommended parts.

2. Required tools for installation work

No.	Part name	Specifications	Usage
1	Plus screwdriver		It is used for disassembling and assembling of each cabinet.
2	Wrench		It is used for disassembling and assembling of compressor fixing nuts.
3	Motor drill	Drill diameter: Ø3.2 and Ø5.0	It is used to make the additional holes on the base or the side cabinet (R).
4	Faston crimping tool	Fixing jig for #250	
5	Close-end connector crimping tool		
6	Cutting plier		
7	Stripper		
8	Cutter knife		
9	Insulation tape		
10	Metal-cutting shears		It is used to process the side cabinet (L).

3. Cord heater installation wiring diagram

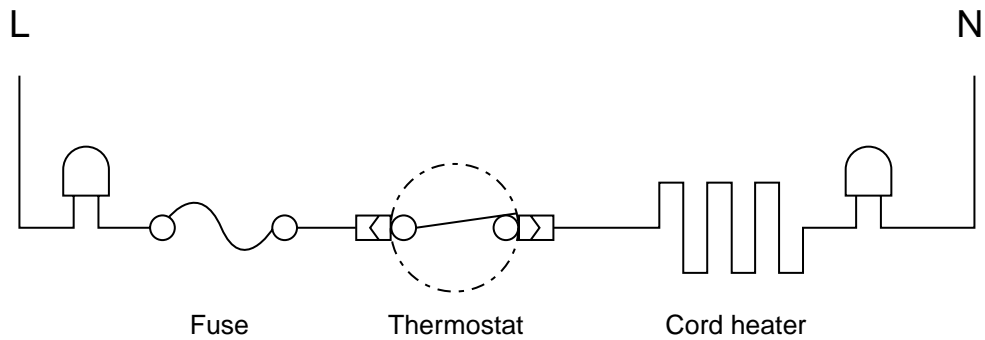

* Be sure to connect the fuse and the thermostat to LIVE side of the cord heater.

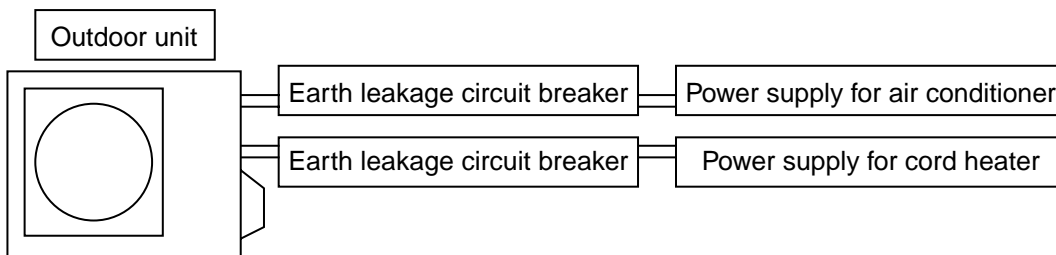

NOTE:



Separate the cord heater power from the air conditioner power, and connect it to its exclusive breaker.

By doing so, the power consumption can be decreased because the breaker can be turned off if there is no possibility of freezing of the base plate in cooling operation, etc.

When the cord heater power is connected to the inverter P.C. board assembly or others without connected to the exclusive breaker, the control P.C. board of the inverter assembly may cause a failure.

When the cord heater has been mounted on a base plate, do not mount the water-proof cap and drain nipple which are provided with the outdoor unit on the base plate.

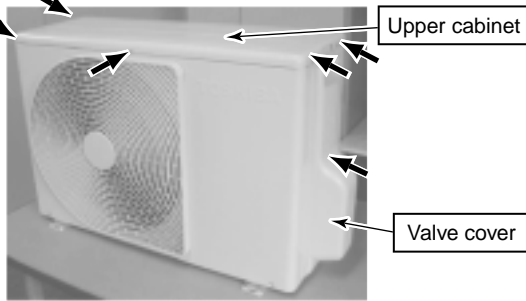
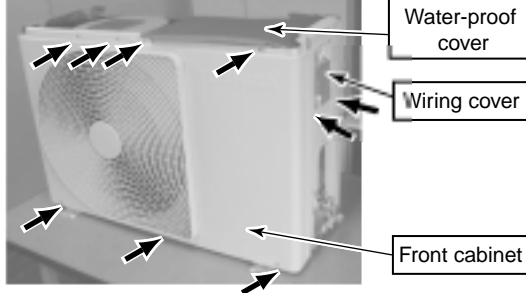
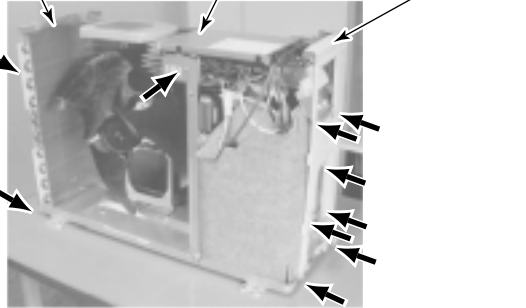
4. Cord heater installation work procedure

No.	Photo / Explanatory diagram	Procedure																																								
1		Remove each cabinet, inverter assembly, motor base assembly, and partition board assembly. * Do not damage the electric parts such as cables, connectors, etc. while this work.																																								
1-1	 <p>Upper cabinet</p> <p>Valve cover</p>	Remove the upper cabinet and the valve cover. Related parts / Screws list <table border="1" data-bbox="837 443 1437 607"> <thead> <tr> <th rowspan="2">Part name</th> <th colspan="2">Used screw</th> </tr> <tr> <th>Screw type</th> <th>Quantity</th> </tr> </thead> <tbody> <tr> <td>Upper cabinet</td> <td>Ø4 × 8</td> <td>5</td> </tr> <tr> <td>Valve cover</td> <td>Ø4 × 1</td> <td>1</td> </tr> </tbody> </table>	Part name	Used screw		Screw type	Quantity	Upper cabinet	Ø4 × 8	5	Valve cover	Ø4 × 1	1																													
Part name	Used screw																																									
	Screw type	Quantity																																								
Upper cabinet	Ø4 × 8	5																																								
Valve cover	Ø4 × 1	1																																								
1-2	 <p>Water-proof cover</p> <p>Wiring cover</p> <p>Front cabinet</p>	Remove the front cabinet, the wiring cover and the water-proof cover. Related parts / Screws list <table border="1" data-bbox="837 857 1437 1021"> <thead> <tr> <th rowspan="2">Part name</th> <th colspan="2">Used screw</th> </tr> <tr> <th>Screw type</th> <th>Quantity</th> </tr> </thead> <tbody> <tr> <td>Front cabinet</td> <td>Ø4 × 8</td> <td>7</td> </tr> <tr> <td>Wiring cover</td> <td>Ø4 × 8</td> <td>2</td> </tr> </tbody> </table>	Part name	Used screw		Screw type	Quantity	Front cabinet	Ø4 × 8	7	Wiring cover	Ø4 × 8	2																													
Part name	Used screw																																									
	Screw type	Quantity																																								
Front cabinet	Ø4 × 8	7																																								
Wiring cover	Ø4 × 8	2																																								
1-3	 <p>Side cabinet (L)</p> <p>Inverter assembly</p> <p>Side cabinet (R)</p>	Remove the side cabinet (R/L) and the inverter assembly. Related parts / Screws list <table border="1" data-bbox="837 1216 1437 1424"> <thead> <tr> <th rowspan="2">Part name</th> <th colspan="2">Used screw</th> </tr> <tr> <th>Screw type</th> <th>Quantity</th> </tr> </thead> <tbody> <tr> <td>Side cabinet (R)</td> <td>Ø4 × 8</td> <td>7</td> </tr> <tr> <td>Side cabinet (L)</td> <td>Ø4 × 8</td> <td>3</td> </tr> <tr> <td>Inverter assembly</td> <td>Ø4 × 8</td> <td>1</td> </tr> </tbody> </table>	Part name	Used screw		Screw type	Quantity	Side cabinet (R)	Ø4 × 8	7	Side cabinet (L)	Ø4 × 8	3	Inverter assembly	Ø4 × 8	1																										
Part name	Used screw																																									
	Screw type	Quantity																																								
Side cabinet (R)	Ø4 × 8	7																																								
Side cabinet (L)	Ø4 × 8	3																																								
Inverter assembly	Ø4 × 8	1																																								
1-4		Remove the inverter assembly. <table border="1" data-bbox="837 1568 1437 2051"> <thead> <tr> <th>No.</th> <th>Part name</th> <th>Connector No.</th> <th>Connector color</th> </tr> </thead> <tbody> <tr> <td>1</td> <td>TE sensor</td> <td>CN600</td> <td>White</td> </tr> <tr> <td>2</td> <td>TD sensor</td> <td>CN601</td> <td>White</td> </tr> <tr> <td>3</td> <td>TO sensor</td> <td>CN602</td> <td>White</td> </tr> <tr> <td>4</td> <td>TS sensor</td> <td>CN603</td> <td>White</td> </tr> <tr> <td>5</td> <td>4-way valve coil</td> <td>CN701</td> <td>Yellow</td> </tr> <tr> <td>6</td> <td>PMV coil</td> <td>CN700</td> <td>White</td> </tr> <tr> <td>7</td> <td>Fan motor</td> <td>CN300</td> <td>White</td> </tr> <tr> <td>8</td> <td>Compressor lead</td> <td>(Intermediate connector)</td> <td>White</td> </tr> <tr> <td>9</td> <td>Reactor (2 pieces.)</td> <td>(Intermediate connector)</td> <td>White</td> </tr> </tbody> </table>	No.	Part name	Connector No.	Connector color	1	TE sensor	CN600	White	2	TD sensor	CN601	White	3	TO sensor	CN602	White	4	TS sensor	CN603	White	5	4-way valve coil	CN701	Yellow	6	PMV coil	CN700	White	7	Fan motor	CN300	White	8	Compressor lead	(Intermediate connector)	White	9	Reactor (2 pieces.)	(Intermediate connector)	White
No.	Part name	Connector No.	Connector color																																							
1	TE sensor	CN600	White																																							
2	TD sensor	CN601	White																																							
3	TO sensor	CN602	White																																							
4	TS sensor	CN603	White																																							
5	4-way valve coil	CN701	Yellow																																							
6	PMV coil	CN700	White																																							
7	Fan motor	CN300	White																																							
8	Compressor lead	(Intermediate connector)	White																																							
9	Reactor (2 pieces.)	(Intermediate connector)	White																																							

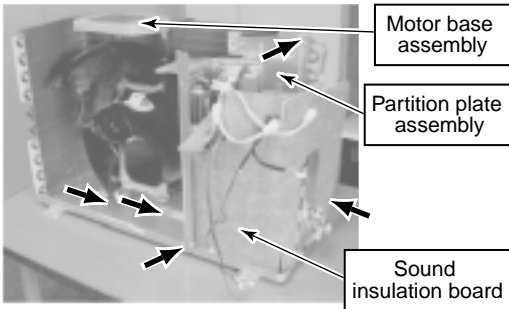
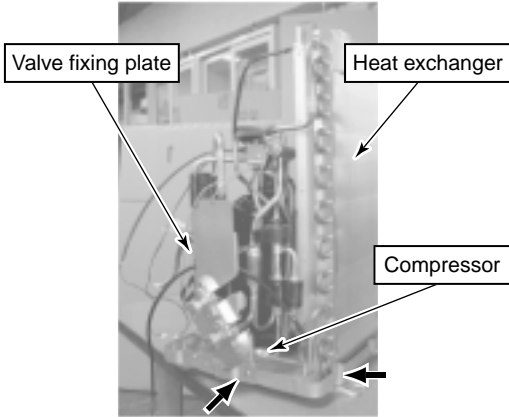
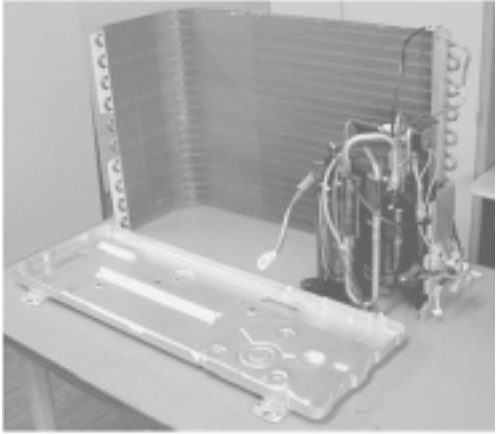
No.	Photo / Explanatory diagram	Procedure														
1-5		<p>Remove the motor base assembly, partition plate assembly and the sound insulation board.</p> <p>Related parts / Screws list</p> <table border="1" data-bbox="799 331 1437 546"> <thead> <tr> <th rowspan="2">Part name</th> <th colspan="2">Used screw</th> </tr> <tr> <th>Screw type</th> <th>Quantity</th> </tr> </thead> <tbody> <tr> <td>Motor base assembly (Including motor and fan)</td> <td>Ø4 × 8</td> <td>2</td> </tr> <tr> <td>Partition plate assembly (Including reactor)</td> <td>Ø4 × 8</td> <td>3</td> </tr> </tbody> </table>	Part name	Used screw		Screw type	Quantity	Motor base assembly (Including motor and fan)	Ø4 × 8	2	Partition plate assembly (Including reactor)	Ø4 × 8	3			
Part name	Used screw															
	Screw type	Quantity														
Motor base assembly (Including motor and fan)	Ø4 × 8	2														
Partition plate assembly (Including reactor)	Ø4 × 8	3														
1-6		<p>Remove the fixing screws of the heat exchanger and the valve fixing plate. Remove the compressor fixing bolt.</p> <p>Related parts / Screws list</p> <table border="1" data-bbox="799 719 1437 925"> <thead> <tr> <th rowspan="2">Part name</th> <th colspan="2">Used screw</th> </tr> <tr> <th>Screw type</th> <th>Quantity</th> </tr> </thead> <tbody> <tr> <td>Heat exchanger</td> <td>Ø4 × 8</td> <td>1</td> </tr> <tr> <td>Valve fixing plate</td> <td>Ø4 × 8</td> <td>1</td> </tr> <tr> <td>Compressor</td> <td>bolt</td> <td>3</td> </tr> </tbody> </table>	Part name	Used screw		Screw type	Quantity	Heat exchanger	Ø4 × 8	1	Valve fixing plate	Ø4 × 8	1	Compressor	bolt	3
Part name	Used screw															
	Screw type	Quantity														
Heat exchanger	Ø4 × 8	1														
Valve fixing plate	Ø4 × 8	1														
Compressor	bolt	3														
1-7		<p>As shown in the left figure, remove the set of refrigeration cycle assembly from the outdoor unit base plate.</p> <p>* In this time, work attentively so that the cycle pipes are not damaged by dent or deformation. Apply protective measures to pipes if necessary.</p>														

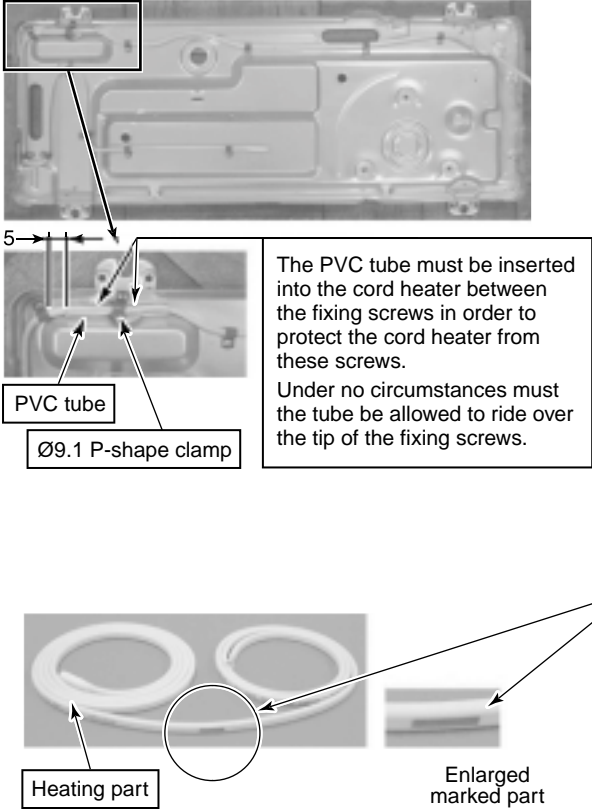
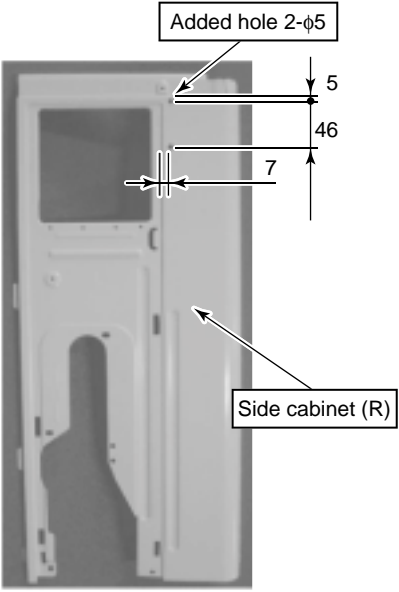
No.	Photo / Explanatory diagram	Procedure
2	<p>Cord heater installation work</p> <p>Drill a hole on the outdoor unit base plate, and fix the cord heater to the outdoor unit base plate using P-shape clamp.</p> <p>Connect the cord heater cables.</p>	
2-1	<p>Using a motor drill, etc., drill $\varnothing 3.2$ holes on the outdoor unit base plate.</p> <p>See APPENDIX-1 and 2 for the additional hole positions.</p> <p>These holes are used to fix the cord heater to the outdoor unit base plate with P-shape clamp.</p>	
2-2	 <p>The PVC tube must be inserted into the cord heater between the fixing screws in order to protect the cord heater from these screws.</p> <p>Under no circumstances must the tube be allowed to ride over the tip of the fixing screws.</p> <p>Labels: PVC tube, $\varnothing 9.1$ P-shape clamp, Heating part, Enlarged marked part.</p>	<p>Insert the PVC tube into the cord heater.</p> <p>This tube is designed to protect the cord heater from the fixing screws used to secure the anchoring feet.</p> <p>As shown in the left figure, install the cord heater (1.5m) to the outdoor unit base plate by using P-shape clamp and screws (Self-tapping screw type-B $\varnothing 4 \times 6$mm, stainless).</p> <p>Pay attention to the direction of P-shape clamp so that it is set to the same direction in the left figure.</p> <ul style="list-style-type: none"> * If the drain port is frozen due to installation status, etc., draw around the cord heater so that the end part of the heater is inserted into the drain port. In this case, add some fixing positions to fix the cord heater surely. * The end part from the marked part of the cord heater heats up. When there is the heating part near the electric parts box, a fire may generate. Be sure to set the heating part on the outdoor unit base plate at the fan room side or near it. (within 20cm from the outdoor unit base plate) * Be careful that the cord heater does not hit the fan. Fix the cord heater without any loosening or sag.
2-3	 <p>Labels: Added hole 2-$\varnothing 5$, Side cabinet (R).</p>	<p>Drill a hole on the side cabinet (R) for fixing the thermostat fixing plate.</p> <p>$\varnothing 5$ hole at two positions</p> <p>When drilling a hole on the side cabinet (R), be sure not to damage the cabinet.</p>

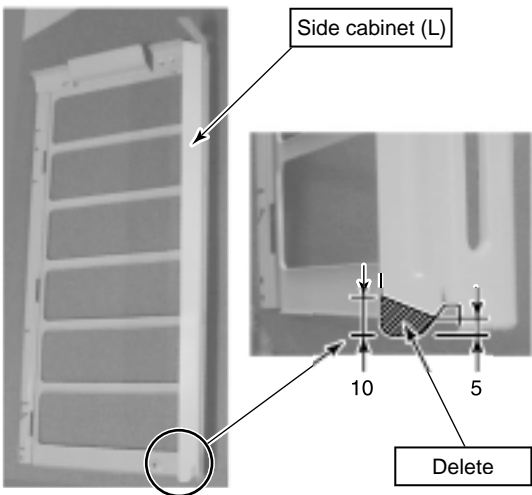
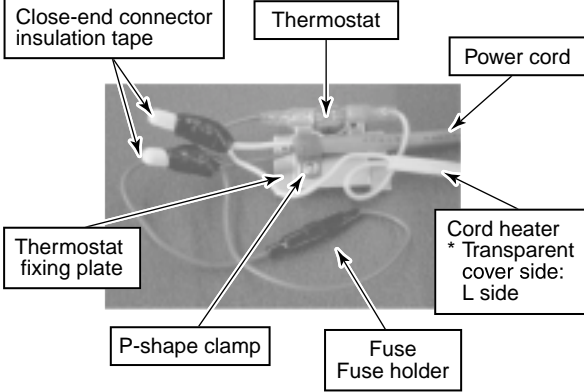
No.	Photo / Explanatory diagram	Procedure
2-4	 <p>The diagram consists of two parts. On the left is a vertical view of a side cabinet (L) with a shaded area on its right edge. On the right is a close-up of the corner where the cabinet meets the main unit. A shaded triangular area is labeled 'Delete'. Two dimensions are indicated: '10' for the height of the delete area and '5' for its width.</p>	<p>Rework the side cabinet (L) to remove part of it.</p> <p>The area to be removed is indicated by the shaded lines in the left figure.</p> <p>After removing part of the side cabinet (L), deburr the edges of the side cabinet (L).</p>
2-5	 <p>The diagram shows a top-down view of the electrical components being assembled. Labels include: 'Close-end connector insulation tape' pointing to the ends of the power cord; 'Thermostat' pointing to the central component; 'Power cord' pointing to the main cable; 'Thermostat fixing plate' pointing to the base; 'P-shape clamp' pointing to the clamp on the power cord; 'Fuse Fuse holder' pointing to the fuse holder; and 'Cord heater * Transparent cover side: L side' pointing to the heater component.</p>	<p>Perform end process and bundling of each cable.</p> <p>Using fixing screws (Self-tapping screw type-B Ø3.5 × 6mm), fix the thermostat to the thermostat fixing plate.</p> <p>Perform end process for various lead cables and connect them according to the wiring diagram.</p> <p>Attach #250 Faston and UL-approved sleeves each to the end of lead cables which are connected to the thermostat.</p> <p>Using insulation tape, apply protective measures to the connected parts by the close-end connectors.</p> <p>Using P-shape clamp and the screws (Self-tapping screw type-B Ø4 × 8mm), fix the power cord to the thermostat fixing plate.</p> <p>When the power cord size does not match with P-shape clamp, procure the most appropriate one at the local site.</p>

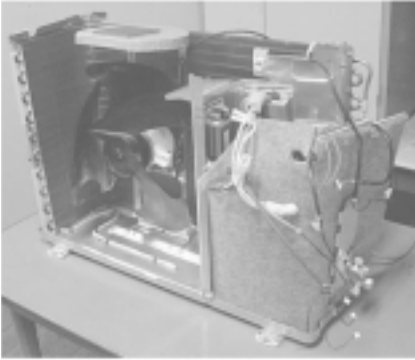
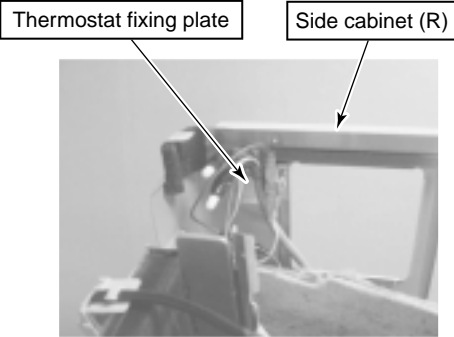
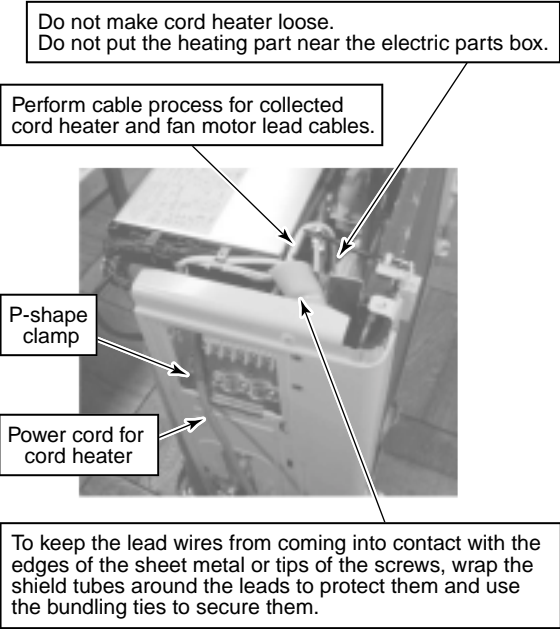
No.	Photo / Explanatory diagram	Procedure
3	<p>Assembly</p> <p>Return a set of the refrigeration cycle assembly into the outdoor unit base plate and reassemble sound insulation board, partition plate assembly, fan motor assembly, and side cabinet (R/L) as original. Fix the thermostat fixing plate to the side cabinet (R), built in the inverter assembly, and then connect various cables. After then, incorporate front cabinet, upper cabinet, wiring cover, and valve cover as before.</p>	
3-1		<p>Return a set of the refrigeration cycle assembly into the outdoor unit base plate, and assemble sound insulation board, partition plate assembly, fan motor assembly, and side cabinet (R/L) as original.</p>
3-2		<p>Using screws (Self-tapping screw type-B $\text{Ø}4 \times 8\text{mm}$, stainless), fix the thermostat fixing plate to the side cabinet (R).</p>
3-3		<p>After incorporating the inverter assembly as before, furthermore perform cable process for cord heater and power cord.</p> <p>For the cord heater, perform cable process so that there is no looseness or sag at the fan side.</p> <p>Perform cable process for the cord heater together with the fan motor lead cable, and collect the remained part of cables at cable process part of the inverter.</p> <p>Secure the power cord for the cord heater to the terminal block mounting plate using the P-shape clamp, and pull it out from the wiring area of the side cabinet (R).</p> <p>* Check that there is the marked part of the cord heater on the outdoor unit base plate or near it. When there is the heating part near the electric parts box, a fire may generate.</p> <p>Since the lead wires connected to the cord heater and thermostat may come into contact with the edges of the sheet metal or tips of the screws, wrap the shield tubes around the leads to protect them and use the bundling ties to secure them.</p>
3-4	<p>Incorporate front cabinet, upper cabinet, wiring cover, water-proof cover and valve cover as before.</p>	
4	<p>In installation work, connect power cord for the cord heater to another breaker separated from one for power cord of the air conditioner.</p>	

5. Drawing of thermostat fixing plate

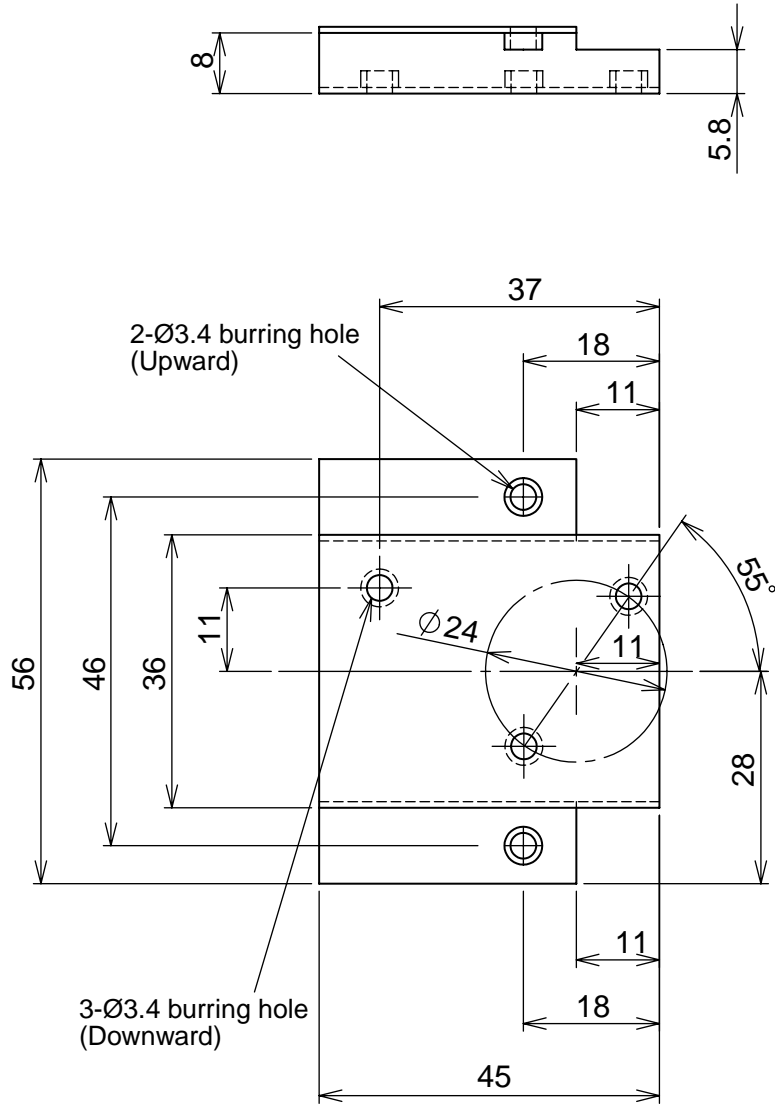

Material: SGCC-Z08, Thickness: 0.8t

16-2. Base Plate

1. RAV-SM563AT-E, RAV-SM803AT-E

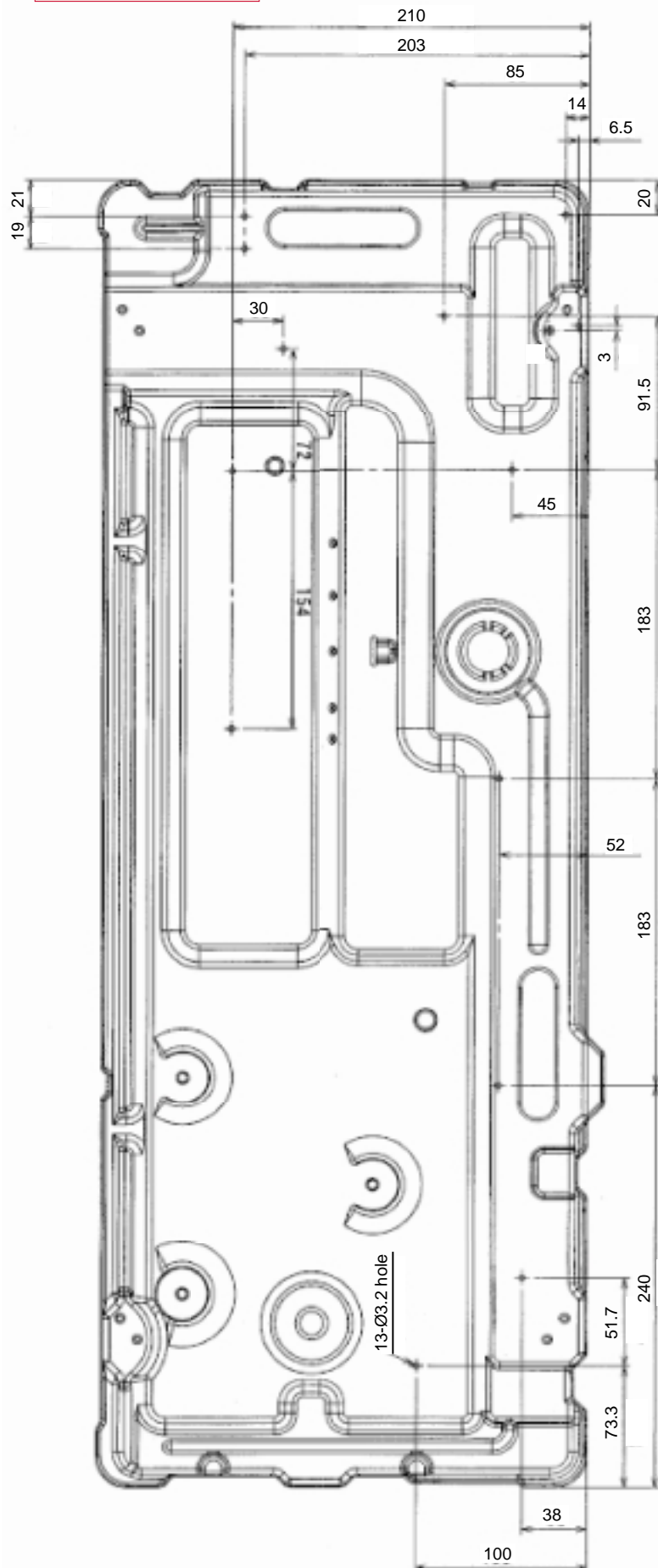

2. RAV-SM1103AT-E, RAV-SM1403AT-E,
RAV-SP562AT-E, RAV-SP802AT-E, RAV-SP1102AT-E, RAV-SP1402AT-E

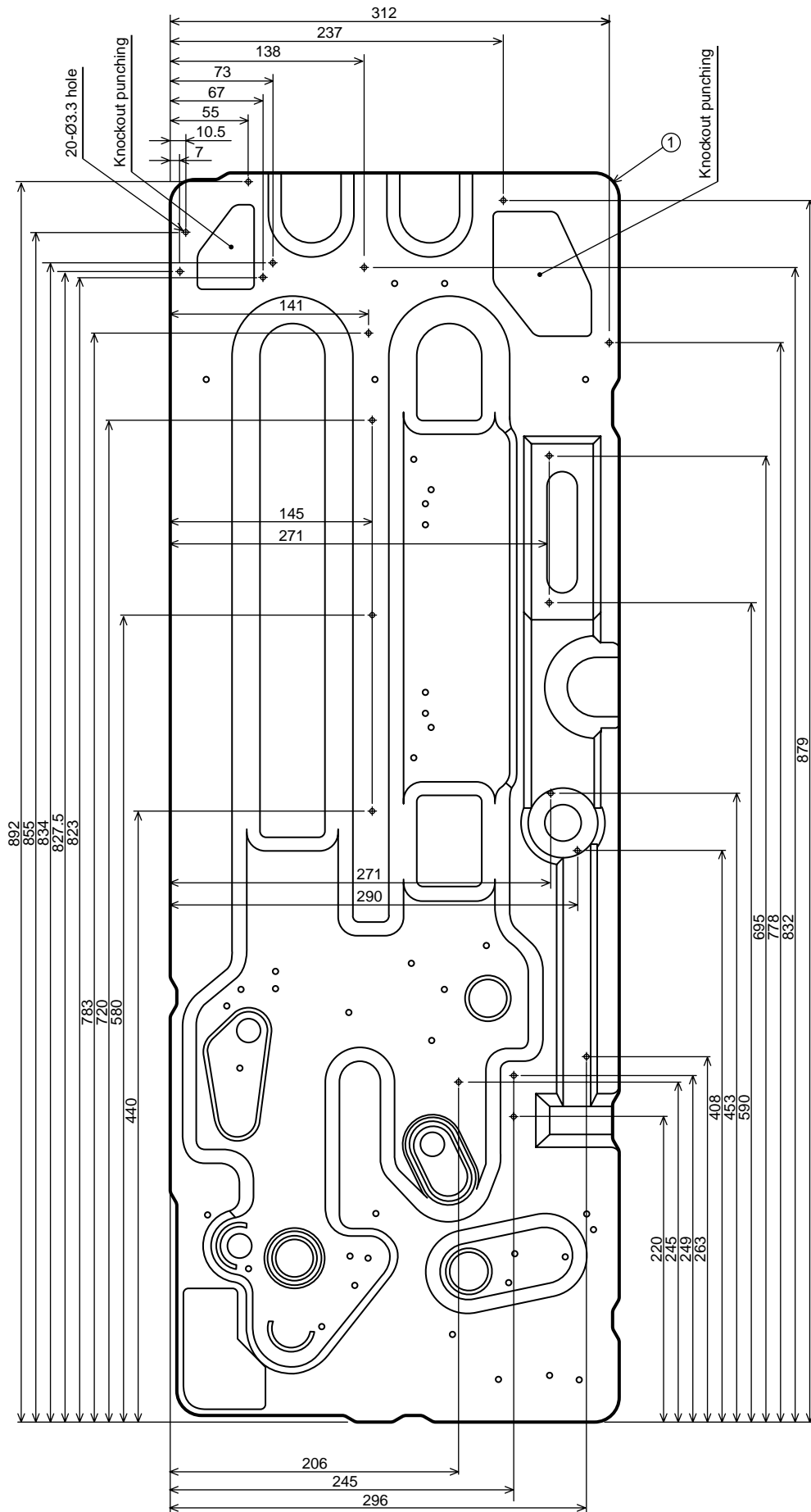

WARNINGS ON REFRIGERANT LEAKAGE

Important

Check of Concentration Limit

The room in which the air conditioner is to be installed requires a design that in the event of refrigerant gas leaking out, its concentration will not exceed a set limit.

The refrigerant R410A which is used in the air conditioner is safe, without the toxicity or combustibility of ammonia, and is not restricted by laws to be imposed which protect the ozone layer. However, since it contains more than air, it poses the risk of suffocation if its concentration should rise excessively. Suffocation from leakage of R410A is almost non-existent. With the recent increase in the number of high concentration buildings, however, the installation of multi air conditioner systems is on the increase because of the need for effective use of floor space, individual control, energy conservation by curtailing heat and carrying power etc.

Most importantly, the multi air conditioner system is able to replenish a large amount of refrigerant compared with conventional individual air conditioners. If a single unit of the multi conditioner system is to be installed in a small room, select a suitable model and installation procedure so that if the refrigerant accidentally leaks out, its concentration does not reach the limit (and in the event of an emergency, measures can be made before injury can occur).

In a room where the concentration may exceed the limit, create an opening with adjacent rooms, or install mechanical ventilation combined with a gas leak detection device.

The concentration is as given below.

$$\frac{\text{Total amount of refrigerant (kg)}}{\text{Min. volume of the indoor unit installed room (m}^3\text{)}} \leq \text{Concentration limit (kg/m}^3\text{)}$$

The concentration limit of R410A which is used in multi air conditioners is 0.3kg/m³.

NOTE 1 :

If there are 2 or more refrigerating systems in a single refrigerating device, the amounts of refrigerant should be as charged in each independent device.

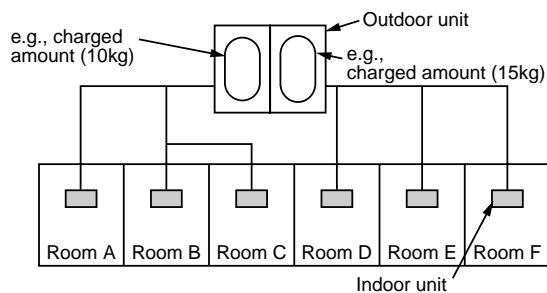

For the amount of charge in this example:

The possible amount of leaked refrigerant gas in rooms A, B and C is 10kg.

The possible amount of leaked refrigerant gas in rooms D, E and F is 15kg.

NOTE 2 :

The standards for minimum room volume are as follows.

- (1) No partition (shaded portion)

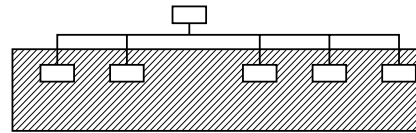

- (2) When there is an effective opening with the adjacent room for ventilation of leaking refrigerant gas (opening without a door, or an opening 0.15% or larger than the respective floor spaces at the top or bottom of the door).

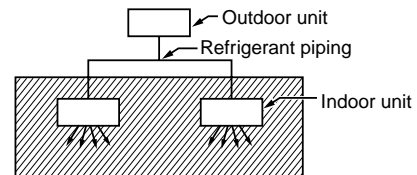

- (3) If an indoor unit is installed in each partitioned room and the refrigerant piping is interconnected, the smallest room of course becomes the object. But when a mechanical ventilation is installed interlocked with a gas leakage detector in the smallest room where the density limit is exceeded, the volume of the next smallest room becomes the object.

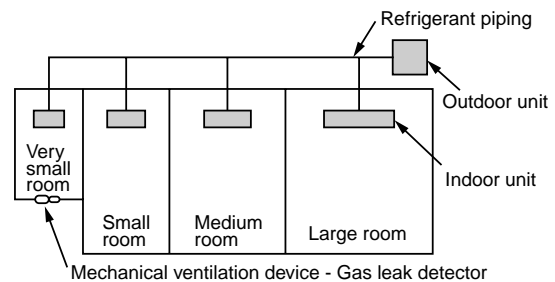

NOTE 3 :

The minimum indoor floor area compared with the amount of refrigerant is roughly as follows:
(When the ceiling is 2.7m high)

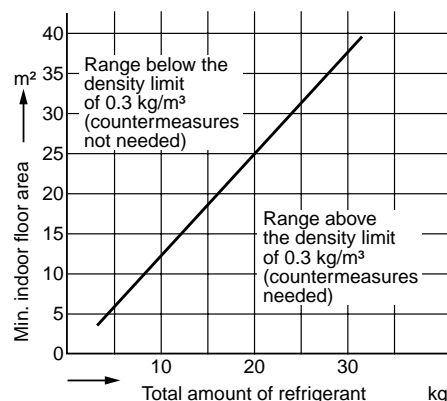

TOSHIBA CARRIER CORPORATION

2 CHOME 12-32, KONAN, MINATOKU, TOKYO, 108-0075, JAPAN

Copyright © 1999 to 2007 TOSHIBA CARRIER CORPORATION, ALL Rights Reserved.