

# TOSHIBA



## HDD/DVD VIDEO RECORDER **RD-XS32SB**

### OWNER'S MANUAL



### OPERATIONS

Read "INSTALLATION GUIDE" first.



Introduction

Recording

Playback

Editing

Library

Function setup

Others

# TOSHIBA



Printed on 100% Recycled Paper

Printed in China

P000403710  
© PM0016697010

© 2004 Toshiba Corporation

# Table of contents

## Introduction

■ <b>Caution for safety</b> .....	4
■ <b>About this product</b> .....	5
■ <b>Compatible discs</b> .....	6
■ <b>Index to parts and controls</b> .....	12
Front panel .....	12
Rear panel .....	14
Remote control .....	16
Display .....	18
■ <b>Before operating this recorder</b> .....	20
■ <b>Key operation - EASY NAVI &amp; QUICK MENU</b> ..	23

## Recording

■ <b>Before recording</b> .....	26
Initializing a DVD-RAM/RW disc (Logical Format) ...	28
DVD-RAM physical format .....	29
Entering characters .....	30
■ <b>Recording a TV programme</b> .....	32
■ <b>Recording an external source</b> .....	37
■ <b>Programing a recording (REC MENU)</b> .....	40
■ <b>VIDEO Plus+ Recording</b> .....	46
■ <b>Others</b> .....	48
Relay recording .....	48
A-B recording .....	48
Reservation Disc ("Lock program record") .....	49
To delete recorded content .....	50
To protect recorded content .....	50
Technical information .....	51

## Playback

■ <b>Information on playback</b> .....	54
■ <b>Playing recorded contents (CONTENT MENU)</b> .....	55
■ <b>Playing a DVD video disc</b> .....	60
Locating a title using the top menu .....	61
■ <b>Pausing a TV broadcast to resume later</b> .....	62
■ <b>Playing a TV programme currently being recorded</b> .....	63

■ <b>Playing at various speeds</b> .....	64
Playing in fast reverse or fast forward .....	64
Skipping to the next/previous chapter or track .....	65
Playing in slow-motion .....	65
Playing frame by frame .....	66
Viewing still pictures (Playing a disc that contains still pictures) .....	66
■ <b>Locating by entering the number</b> .....	67
Locating by entering the number of a desired section .....	67
Locating a specific point by entering its elapsed time (Time Search) .....	68
■ <b>Watching a TV broadcast in the sub window (P in P Playback)</b> .....	69
■ <b>Selecting the camera angle</b> .....	70
■ <b>Selecting Subtitles</b> .....	71
■ <b>Zooming a picture</b> .....	72
■ <b>Selecting the sound</b> .....	73
■ <b>Viewing JPEG files</b> .....	76
JPEG files compatibility .....	77
■ <b>Playing MP3/WMA files</b> .....	78
Playable files .....	79
■ <b>Checking the current status and settings</b> .....	80
Operational status and setting details .....	80
Using the time bar .....	81
■ <b>Functions in the Quick Menu</b> .....	82

## Editing

■ <b>Before editing</b> .....	86
For better use the HDD of this recorder .....	86
Editing on this recorder .....	87
■ <b>Creating chapters</b> .....	90
■ <b>Playlist editing (Collecting desired scenes)</b> .....	95
■ <b>Creating thumbnails (Changing the picture on the CONTENT MENU)</b> .....	100
■ <b>Before dubbing</b> .....	103
■ <b>High speed Library dubbing (Dubbing only a specified part)</b> .....	106

■ Dubbing selected items (Dubbing specified parts together) .....	108
■ Rate conversion dubbing (Dubbing at a modified bit rate) .....	112
■ Line-U dubbing (Recording pictures while viewing them) .....	116
■ Deleting selected items (Deleting multiple specified parts) .....	118
■ Combine Original titles (Combine two titles into one) .....	120
■ Creating a DVD-Video using DVD-R/RW .....	122
■ DVD-Video finalizing process .....	132
■ DV recording (Recording from a digital video camera) .....	136

## Library

■ Using Library data .....	140
Basic operation of the Library system .....	140
■ Searching for a desired title .....	141
Changing the listing order .....	141
Searching .....	141
Jumping .....	142
■ Viewing Library data .....	143
Viewing title information .....	143
Viewing disc information .....	143
Maintenance of Library data .....	144
■ Checking remaining space .....	147
Viewing a number and space of a disc .....	147
Viewing remaining space .....	147

## Function Setup

■ Customizing the function settings .....	150
DVD Player settings .....	154
Picture/Audio settings .....	157
Display settings .....	159
Operational settings .....	160
DVD recorder operation .....	161
Management settings .....	163
Setting of picture and sound quality for recording .....	164

## Others

■ Before calling service personnel .....	166
■ Error codes on the display window .....	169
■ Recording duration .....	170
■ Language code list .....	171
■ Specification .....	172

# Caution for safety

Read “SAFETY PRECAUTIONS”, “IMPORTANT SAFETY INSTRUCTIONS”, “Precautions” and others of the “INSTALLATION GUIDE” first.

# About this product

## Some differences



This DVD recorder is more similar to a computer than it is to a standard DVD player. In addition to a microprocessor, it contains a hard disc drive (an HDD), an operating system, random access memory (RAM), and a DVD-RAM/R/RW drive. The operating system includes software stored on the HDD that is transferred to the RAM when the machine is turned on and at other times during operation. This transfer can take time. Thus, when you turn on the DVD recorder, it may be a minute or so before it is ready to use. Likewise, other functions may not be performed as quickly as they would on other AV equipment. In addition, because programs stored on the DVD-RAM/R/RW drive cannot be accessed as quickly as those stored on the HDD, accessing those programs (or deleting a program from a DVD-RAM or DVD-RW disc) may take more time. Please take these factors into consideration as you use the DVD recorder.

## About the hard disc drive (HDD)

Like any HDD, the HDD in the DVD recorder is a fragile device that is susceptible to partial or complete failure if it is jarred or as a result of use over time. It will not last forever. Therefore, do not use the HDD for longer term storage of programs you wish to retain. [If portions of the HDD become damaged, programs recorded on those portions may exhibit pixelization or block noise when played back. Repeated playback of the program may cause the problem to get worse and, eventually, the program may become unplayable. Accordingly, if you notice such noise in a program that you want to save, you should transfer to a recordable DVD disc as soon as possible.] Recordable DVD discs are also susceptible to damage if not handled and stored carefully and some or all of the programs on them may become unplayable. You can reduce these risks by using high quality DVD recordable discs and checking their playability from time to time. If it becomes necessary to service your DVD recorder, it may be necessary to delete some or all of the programs on the HDD.

## Playback Restrictions

This owner's manual explains the basic instructions for this recorder. Some DVD video discs are produced in a manner that allows specific or limited operation during playback. As such, the recorder may not respond to all operating commands. This is not a defect in the recorder. Please refer to the notes on compatible discs later in this Introduction and to the discussion of DVD playback and features later in this manual.

“” may appear on the TV screen during operation.  
 “” means that the operation is not permitted by the recorder or the disc.

## Recording Restrictions

Copy-protected contents of DVD-Video disc, VIDEO CDs or audio CDs on the market cannot be copied on this recorder.

Contents without copy protection should be copied or edited only in accordance with applicable copyright laws, which may restrict copying or editing. Contents that permit single copying (copy once contents) can be recorded onto DVD-RAM discs, with some dubbing and editing restrictions. DVD-R/RW discs cannot record these contents.

## Compatibility

In isolated cases, a disc bearing the DVD or CD logo may not fully and properly play back all features. This can be due, among other reasons, to problems and errors that can occur during the creation or recording of DVD and other software and the manufacture of software discs (including blank discs). Moreover, because of variations in the quality of discs, this recorder may not be able to record on all discs that bear a DVD-RAM, DVD-R or DVD-RW logo, but you should not encounter difficulty if you use only high quality recordable DVD discs.



# Compatible discs

When you want to play DVD or CD software or copy programmes from the HDD to a recordable DVD, load an appropriate disc into the recorder. There are many types and formats of discs. Please use the following information to select an appropriate disc.

## Notes

- Handle the disc according to the disc instruction manual.
- Depending on the data recording method or the disc status, playback or recording on this recorder may not be possible, even if the disc is labeled as below. Toshiba cannot assure that all discs bearing the DVD or CD logos will operate as expected. Please see the discussion of compatibility on page 5.

## For recording / playback

Disc	Mark	Specification	Remarks
DVD-RAM		<ul style="list-style-type: none"> <li>• Single sided 4.7GB (12cm (4<sup>3</sup>/<sub>4</sub> in.))</li> <li>• Double sided 9.4GB (12cm (4<sup>3</sup>/<sub>4</sub> in.))</li> </ul>	<p>Read carefully the section "On DVD-RAM discs" (➡ page 8).</p> <p>Select a DVD-RAM disc that shows a statement on its package such as "this disc can be used with video recorders and drives compatible with 4.7GB DVD-RAM discs" or "this disc can copy images that permit single copying."</p>
DVD-R		<ul style="list-style-type: none"> <li>• 4.7GB For General Ver.2.0 (12cm (4<sup>3</sup>/<sub>4</sub> in.))</li> </ul>	<p>Read carefully the section "On DVD-R discs" (➡ page 9).</p> <p>Depending on the disc status or the recording equipment, playback of the disc may not be possible on this recorder.</p>
DVD-RW		<ul style="list-style-type: none"> <li>• Ver. 1.1 or later (12cm (4<sup>3</sup>/<sub>4</sub> in.))</li> </ul>	<p>Read carefully the section "On DVD-RW discs" (➡ page 9).</p> <p>Depending on the disc status or the recording equipment, playback of the disc may not be possible on this recorder.</p>

## Using different disc types for different purposes

### DVD-RAM discs for your personal library

DVD-RAM discs comply with the global standard DVD-VR (Video Recording) format, and are optimized for recording of TV programs. You can rewrite repeatedly without deterioration of an image quality, erase unnecessary parts, divide a chapter, or specify playback area by frame. Its cartridge is suitable for a longer-term storage and family use, and its large capacity of 9.4 GB allows more recording space.

### DVD-R discs when creating your own original discs for distribution

DVD-R discs are designed to comply with the global standard DVD-Video format, and can be recorded only once. DVD-R discs are convenient when you edit your original content (recorded personal events such as a wedding party) with this recorder, transfer them to the recorder and make copies to send to your friends or relatives. The discs can be played on other compatible DVD players. DVD-RW discs, which are rewriteable, can be used as well.











\* DVD-R and DVD-RW may not be the best suited format for recording TV programs. Because of the way the discs are formatted, it may not be possible to edit or divide the program as you may prefer, to record secondary languages, or programs that are copy protected in a way that allows only one copy. (NOTE: "Copy once" protected programs generally can be recorded to DVD-RAM discs.)



\* This recorder records on a DVD-R/RW disc in DVD-Video format only. In DVD-VR format, recording is not possible.

\* On DVD-R/RW discs, direct recording, copying or the method "Creating a DVD-Video" (➡ page 122) are available.

We cannot guarantee that DVD-RAM/RW discs recorded on this recorder will be playable on all DVD recorders/players. Similarly, there is no guarantee that all DVD-RAM/RW discs recorded on other recorders will be playable on this recorder.

## For playback only

Disc	Mark	Specification	Remarks
DVD video disc		<ul style="list-style-type: none"> <li>• 12cm (4<sup>3</sup>/<sub>4</sub> in.) / 8cm (3<sup>1</sup>/<sub>4</sub> in.)</li> <li>• Region number  or </li> </ul>	The region number of this DVD recorder is 2. If region numbers, corresponding to a specific playable area, are printed on your DVD video disc and you do not find  or  , or the disc is encoded to permit playback only in regions other than Region 2, disc playback will not be allowed by the recorder.
DVD-RW		<ul style="list-style-type: none"> <li>• 12cm (4<sup>3</sup>/<sub>4</sub> in.)</li> <li>• DVD-VR mode</li> </ul>	It is not possible to play contents recorded from programs which are not copy-free. Depending on the disc status, playback may not be possible.
VIDEO CD		<ul style="list-style-type: none"> <li>• 12cm (4<sup>3</sup>/<sub>4</sub> in.) / 8cm (3<sup>1</sup>/<sub>4</sub> in.)</li> <li>• Version 1.1 and 2.0</li> </ul>	
Audio CD		<ul style="list-style-type: none"> <li>• 12cm (4<sup>3</sup>/<sub>4</sub> in.) / 8cm (3<sup>1</sup>/<sub>4</sub> in.)</li> </ul>	
CD-R		<ul style="list-style-type: none"> <li>• 12cm (4<sup>3</sup>/<sub>4</sub> in.)</li> <li>• CD-DA (audio CD) format</li> </ul>	Depending on the disc status, playback may not be possible.
CD-RW			

- You cannot play discs other than those listed above.
- You cannot play non-standardized discs even if they may be labeled as above.
- You cannot play discs with specialized encoding (such as SACD discs) or the DVD audio portions of DVD Audio discs.
- You cannot play SVCD discs.
- This recorder uses the PAL colour system for recording and playback. The NTSC colour system is used for playback only, by selecting an appropriate setting. A disc may fail to play, if it has data in the PAL colour system and the NTSC colour system. You cannot add the PAL colour system data to the disc with the data recorded in the NTSC colour system even if they have region marks  or  .
- There may be some DVD discs designed for this market that cannot be played on this recorder. If you encounter please contact TOSHIBA customer service.
- Toshiba cannot assure that all discs bearing the DVD or CD logos will operate as expected. Please see the discussion of compatibility on page 5.

## On DVD-RAM discs

### ■ Use only DVD-RAM discs that comply with DVD-RAM standard Version 2.0 or 2.1.

The recorder cannot record on a disc formatted in any other standard. When using such a disc, initialize it by using the disc-format function of this recorder.

- The recorder may not record, dub, or edit some DVD-RAM discs, because they are edited/recorded with another manufacture's equipment or PC, contain a large number of titles, or have little remaining capacity. Also, a DVD-RAM disc may not be edited or recorded if its title contains still pictures.
- DVD-RAM discs formatted in UDF2.0 on a PC are not compatible with this recorder. Before using these discs, initialize them on this recorder.
- This recorder complies with current copyright protection technology and can copy a disc only when the disc permits copying once. When there is no indication on the disc, copying will not be allowed. Such an indication on a disc is required also for the Library Management database.

### ■ DVD-RAM discs with cartridges are recommended for recording.

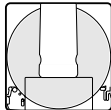
- Two types of DVD-RAM discs are available: ones with cartridges and ones without cartridges. You can use either of them with this recorder, but the former ones are recommended. 
- In order to record highly detailed data, make sure the disc is clean. DVD-RAM discs with cartridges are easier to handle in this regard.
- Do not open the cartridge shutter. The disc may not play, or may not be recorded or edited once it becomes dirty.
- There are two types of DVD-RAM cartridges; removable (TYPE 2/4) and not removable (TYPE 1). It is recommended you do not remove the disc even when you can. Refer to the instruction manual that comes with the disc if it is absolutely necessary to remove the disc.
- Some commercially available cartridge discs cannot be recorded or edited once the inside discs are removed.

### ● To protect recorded contents

Slide the write-protect tab to "PROTECT" with something small enough. The disc can play, but cannot be edited or erased. Refer to the instructions that come with the disc.

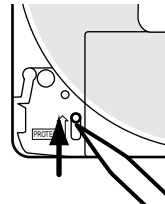

### ■ When using a disc without a cartridge (commercially available discs)

- Discs without cartridges can easily attract fingerprints and dust, which is the reason they are not recommended. If you cannot avoid using them, handle with proper care.
- When you write in a title column on a disc, use a pen with a soft tip. Do not use a pen with a hard tip, such as a ballpoint pen.

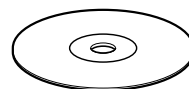

### Recommended discs

The following discs have been tested with this recorder:  
 9.4 GB double-sided cartridge: Panasonic LM-AD240U  
 4.7 GB single-sided cartridge: Panasonic LM-AB120U

- The company does not hold any responsibility to compensate the contents which should have been recorded, and any losses or damages (e.g. losses of business profit, or business intermission) that may arise from malfunction of this recorder (not recording/editing as intended). Problems arising in the following situations are included.
  - When a DVD disc recorded on this recorder is used in a DVD recorder of another manufacturer, or used (insertion, playback, recording or editing) in a personal computer DVD drive.
  - When a DVD that has been used as above is used again in this recorder.
  - When a DVD disc recorded in a DVD recorder of another manufacturer, or in a personal computer DVD drive is used.
- Some functions such as Library may not work with PC discs.



## On DVD-R discs

### ■ Standards

- DVD-R for General Ver.2.0 discs can be used for recording and playback.
- Discs compatible with 2X speed recording (labeled Ver.2.1/2X etc.) and discs compatible with 4X speed recording (labeled Ver.2.1/4X etc.) can also be used.
- Select discs labeled “for video,” “for recording,” “120 min.” etc.
- DVD-R for authoring Ver.1.1 cannot be used.

### ■ Recording conditions

- Images for which copying is prohibited or restricted (copy once or copy prohibited) cannot be recorded. Even if the disc is labeled as CPRM compatible, this recorder can only be used to record copy-free material.

### ■ Recommended discs

Taiyo-Yuden 4X

### ■ Tested discs

Panasonic LM-RF120 (4.7GB/120 min.)

## On DVD-RW discs

### ■ Standards

- Discs labeled DVD-RW Ver.1.1 can be used.
- Discs compatible with 2X speed recording (labeled Ver.1.1/2X etc.) can also be used.
- Select discs labeled “for video,” “for recording,” “120 min.” etc.

### ■ Recording conditions

- Images for which copying is prohibited or restricted (copy once or copy prohibited) cannot be recorded. Even if the disc is labeled as CPRM compatible, this recorder can only be used to record copy-free material.
- DVD-VR mode recording is not possible.

### ■ Recommended discs\*

JVC 2X





### Note

- There are limitations on times of repeat recording on the same disc.

\*Operation has been confirmed with recommended discs and tested discs, but some other discs may not be usable.

## Marks on DVD video discs

The following are examples of marks and the meanings.

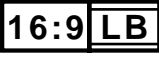
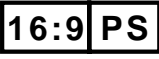
Mark	Meanings
	Number of audio streams recorded in the disc. (2 streams such as English and Japanese in this example.)
	Number of subtitle languages recorded in the disc. (2 subtitle languages are recorded in this example.)
	Number of camera angles recorded in the disc. (3 camera angles are recorded in this example.)
	Pictures are recorded in the standard picture shape (4:3 aspect ratio).
	Pictures are recorded in the letter box picture shape (4:3 aspect ratio with horizontal black bars in the top and bottom of pictures).
	Pictures are recorded in the 16:9 wide picture shape. TVs with 4:3 aspect ratio will display them in the letter box style.
	Pictures are recorded in the 16:9 wide picture shape. TVs with 4:3 aspect ratio will display them in the pan scan style (one or both sides of pictures are cut).
	Actual picture shape may vary depending on the aspect ratio or mode selection of the TV.

## Structure of disc contents

Normally, DVD video discs are divided into titles, and the titles are subdivided into chapters.

VIDEO CDs/audio CDs are divided into tracks.

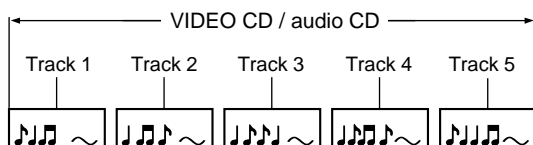
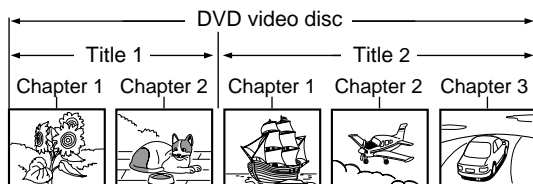

**Title:** Divided contents of a DVD video disc. Roughly corresponds to a story title in short stories.

**Chapter:** Divided contents of a title. This corresponds to a chapter in a story.

**Track:** Divided contents of a VIDEO CD or an audio CD.

Each title, chapter, or track is assigned a number, which is called "title number", "chapter number", or "track number" respectively.

Some discs may not have these numbers.

When you record on the HDD or a DVD-RAM disc, one recording will always equal one title. You can divide a title into several chapters by marking borders in it to facilitate scene search.

## On handling discs

- Do not touch the playback side of the disc.

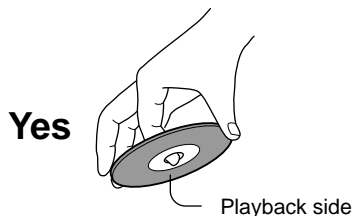

- Do not stick paper or tape to discs.



## On cleaning discs

- Fingerprints and dust on the disc cause picture and sound deterioration. Wipe the disc from the center outwards with a soft cloth. Always keep the disc clean.



- If you cannot wipe off the dust with a soft cloth, wipe the disc lightly with a slightly moistened soft cloth and finish with a dry cloth.
- Do not use any type of solvent such as thinner, benzene, commercially available cleaners or antistatic spray for vinyl LPs. It may damage the disc.

## On storing discs

- Do not store discs in a place subject to direct sunlight or near heat sources.
- Do not store discs in places subject to moisture and dust such as a bathroom or near a humidifier.
- Store discs vertically in a case. Stacking or placing objects on discs outside of their case may cause warping.

## Discs and purposes

The table shows main functions which are available on this recorder per disc category. This will help you choose discs.

	DVD-RAM disc	DVD-RW disc	DVD-R disc
Characteristics on this recorder	Suitable for repeat use of the disc, and data storage for video library. Copy once contents can be recorded using a compatible disc.	Suitable for saving data in DVD-Video format to play on compatible devices.  You can erase recorded contents to use the disc repeatedly.	Suitable for saving data in DVD-Video format to play on compatible devices.  Once you execute DVD-Video finalizing process on a recorded disc so that it can be played on other players, you cannot make addition, correction and deletion of contents on the disc.
For the first use	No preparatory steps required, however initializing is recommended.	Initialize the disc.	No preparatory steps required.
Recording a TV program	Yes	Yes	Yes
Erasing recorded contents	Yes	Yes If the disc has been executed DVD-Video finalizing process, first cancel the process then delete contents.	Yes Deleting contents cannot restore the disc space. <u>After you execute DVD-Video finalizing process on a recorded disc, you cannot delete contents of the disc.</u>
Recording additional content on a recorded disc	Yes	Yes If the disc has been executed DVD-Video finalizing process, first cancel the process then delete contents.	Yes <u>After you execute DVD-Video finalizing process on a recorded disc, you cannot add contents to the disc.</u>
Indexing recorded contents Naming a title Creating a thumbnail	Yes Yes	Yes Yes <u>After you execute DVD-Video finalizing process on a recorded disc, you cannot name a title or create a thumbnail.</u>	Yes Yes <u>After you execute DVD-Video finalizing process on a recorded disc, you cannot name a title or create a thumbnail.</u>
Collecting favorite scenes (Playlist Editing) Making a new title from a Playlist containing favorite scenes (Copy within the same disc)	Yes Yes	No No	No No
Playing contents recorded on this recorder, on other devices	Contents can be played on any devices compatible with DVD-RAM discs. Follow the instruction of the device to play.	Execute DVD-Video finalizing process on this recorder. This process makes the disc playable on other compatible devices. (Some models excepted.)	Execute DVD-Video finalizing process on this recorder. This process makes the disc playable on other compatible devices. (Some models excepted.)
When a message appears and the loaded disc cannot be used:	Initialize the disc. If it is still unusable, try to execute DVD-RAM physical format.	Initialize the disc.	—

# Index to Parts and Controls

See pages with arrows for details.

## Front panel

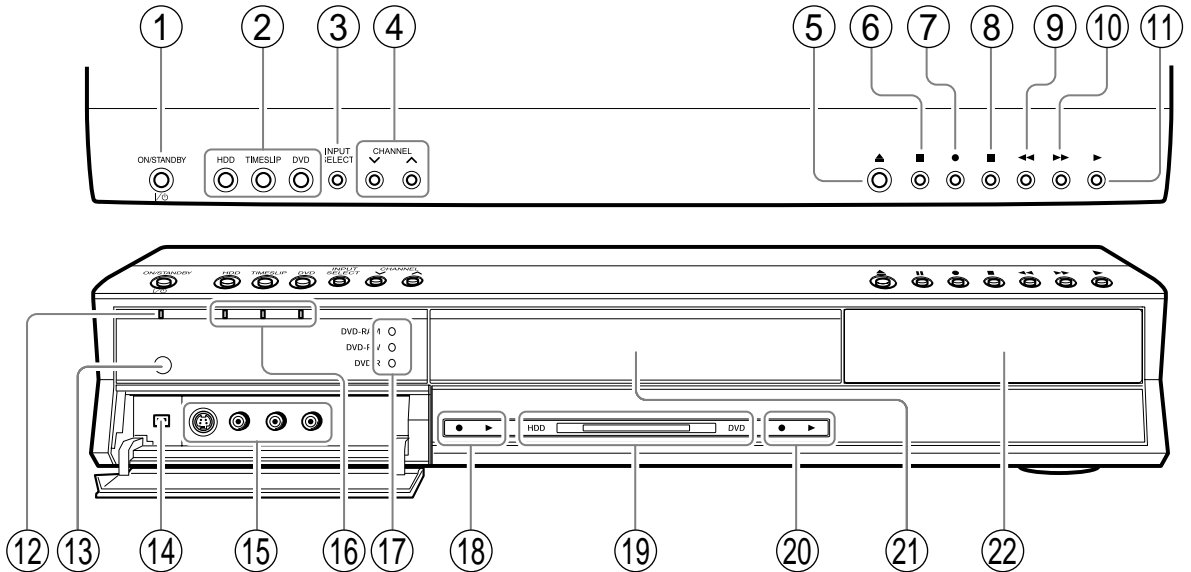

\* The above illustration displays the front panel with the cover open. See the following page on how to open or close the cover.

- 1 ON/STANDBY button** ➔ pages 20, 21  
Turns the power on/restores the unit in the standby mode.
- 2 Three mode button (HDD, TIMESLIP, DVD)** ➔ page 32, 55, 60, 62, 63  
Selects recording/playback media.
- 3 INPUT SELECT button** ➔ page 38  
Pressing repeatedly selects between various input sources.
- 4 CHANNEL buttons** ➔ page 20, 33  
Selects the channel.  
(This is not available to select satellite channels regardless of the IR control cable connection and the set top box setting.)
- 5 ▲ (OPEN/CLOSE) button** ➔ page 20  
Opens and closes the disc tray.
- 6 ■ (PAUSE) button** ➔ page 35, 60  
Stops playback or recording momentarily.
- 7 ● (REC) button** ➔ page 34  
Starts recording.
- 8 ■ (STOP) button** ➔ page 35, 60  
Stops playback or recording.
- 9 PICTURE SEARCH (◀◀) button** ➔ page 64  
Scans the picture backwards.
- 10 PICTURE SEARCH (▶▶) button** ➔ page 64  
Scans the picture forward.
- 11 ▶ (PLAY) button** ➔ page 60  
Starts playback.
- 12 ON/STANDBY indicator** ➔ page 20, 21  
Displays the operational state of the recorder.
- 13 Remote sensor** ➔ page 12 in "INSTALLATION GUIDE"
- 14 DV IN connector** ➔ page 136  
Use this when recording from a digital video camera.
- 15 INPUT jacks** ➔ page 37  
Use this when recording from other input source such as a VTR or a camcorder.

- 16 **Three mode indicator** ➡ page 32, 55, 60, 62, 63  
Indicates the selection by the three mode button.

- 17 **Media indicator**  
Indicates the current media.

- 18 **Operation Status Indicator (HDD)**  
Indicates the operation status of the HDD.
- : Recording
  - ▶ : Playing
  - ▶ : Copying within the disc

- 19 **HDD indicator**  
Illuminates in the HDD mode.

- 20 **Operation Status Indicator (DVD)**  
Indicates the operation status of the DVD.
- : Recording
  - ▶ : Playing
  - ▶ : Copying within the disc

- 21 **Disc tray** ➡ page 20  
Place a disc to play or record.

- 22 **Front panel display** ➡ page 18

■ **To open or close the cover on the front panel**

Put your finger on the left edge of the cover and pull it down to open.

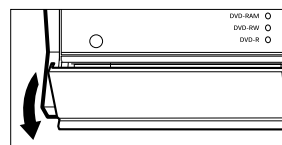

**Note**

- Do not place a heavy object on the cover while it is open. Doing so may damage the recorder.

## Rear Panel

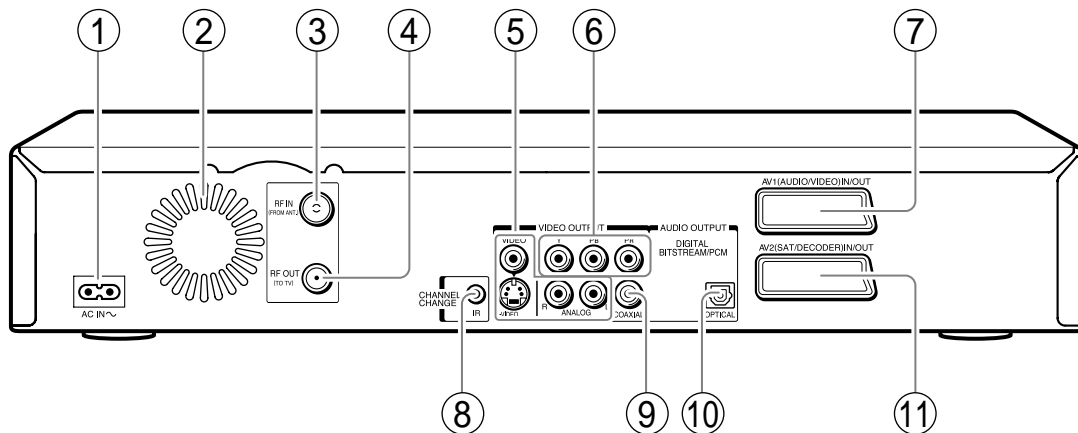

**1 AC IN socket** ➔ page 15 in “INSTALLATION GUIDE”

Connects to the supplied power cord.

**2 Ventilation fan**

**3 RF IN (FROM ANT.) input socket** ➔ page 14 in “INSTALLATION GUIDE”

Connects to an aerial or satellite signal.

**4 RF OUT (TO TV) output socket** ➔ page 14 in “INSTALLATION GUIDE”

Connects the supplied coaxial cable to a TV.

**5 VIDEO OUTPUT, AUDIO OUTPUT jacks** ➔ page 16 in “INSTALLATION GUIDE”

Outputs video and audio signals to a connected TV or amplifier.

**6 Component VIDEO OUTPUT jacks** ➔ page 17 in “INSTALLATION GUIDE”

Outputs video signals to a connected TV or monitor.

Connects to a TV or monitor equipped with component video jacks.

**7 AV1(AUDIO/VIDEO)IN/OUT socket** ➔ page 37

- Use this socket when connecting the TV that has the terminal in this shape.

- Use this socket when connecting the video or other equipment that has the terminal in this shape.

**8 CHANNEL CHANGE IR jack** ➔ page 20 in “INSTALLATION GUIDE”

Connect the supplied IR control cable to control cable/satellite channels according to timer programs.

**9 DIGITAL BITSTREAM/PCM COAXIAL AUDIO OUTPUT jack** ➔ page 22, 23, 24 in “INSTALLATION GUIDE”

Use this to connect the recorder to an audio receiver equipped with a coaxial digital audio input jack.

**10 DIGITAL BITSTREAM/PCM OPTICAL AUDIO OUTPUT jack** ➡ page 22, 23, 24 in “INSTALLATION GUIDE”

Use this to connect the recorder to an audio receiver equipped with an optical digital audio input jack.

When connecting the optical digital cable, remove the cap and fit the connector into the jack firmly. When not using the jack, keep the cap inserted to protect it from dust intrusion.

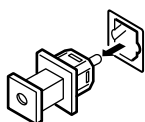

**11 AV2(SAT/DECODER)IN/OUT socket** ➡ page 37

Use this socket when connecting the video or other equipment that has the terminal in this shape.

Remote control

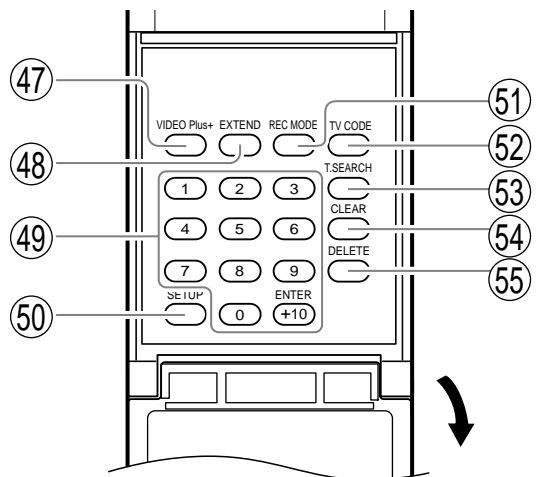
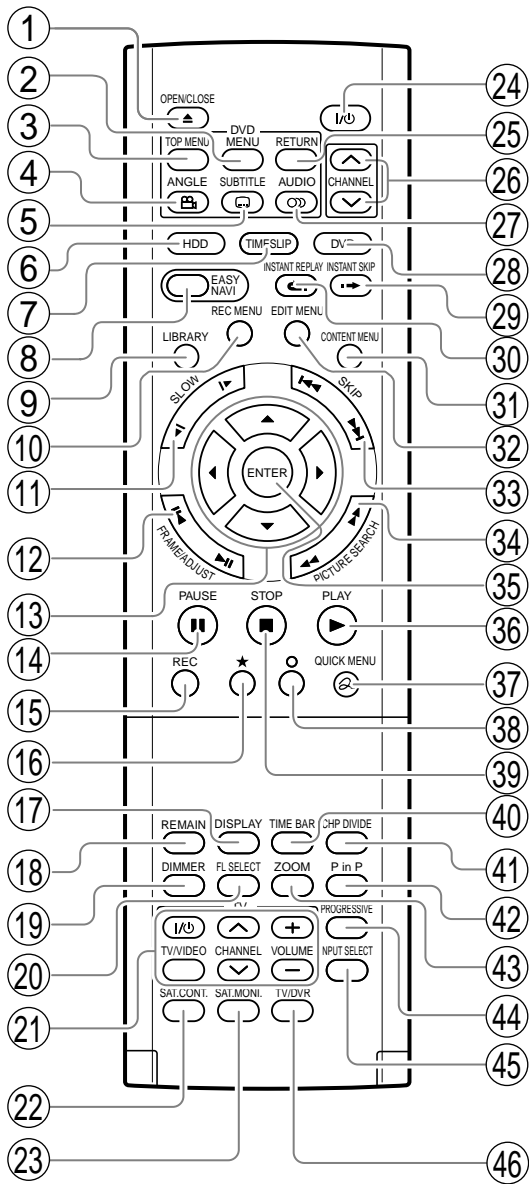



- ① OPEN/CLOSE button ➔ page 20, 21
- ② MENU button\*<sup>1</sup>
- ③ TOP MENU button ➔ page 61
- ④ ANGLE button ➔ page 70
- ⑤ SUBTITLE button ➔ page 71
- ⑥ HDD button ➔ page 32, 38, 55
- ⑦ TIMESLIP button ➔ page 62, 63
- ⑧ EASY NAVI button ➔ page 23
- ⑨ LIBRARY button ➔ page 140
- ⑩ REC MENU button ➔ page 40
- ⑪ SLOW button ➔ page 65
- ⑫ FRAME/ADJUST button ➔ page 40, 66
- ⑬ Direction buttons (▲/▼/◀/▶) ➔ page 55, 150
- ⑭ PAUSE button ➔ page 35, 56
- ⑮ REC button ➔ page 34
- ⑯ ★ button ➔ page 55
- ⑰ DISPLAY button ➔ page 80
- ⑱ REMAIN button ➔ page 27
- ⑲ DIMMER button ➔ page 19
- ⑳ FL SELECT button ➔ page 19
- ㉑ Buttons for TV operation ➔ page 52 in "INSTALLATION GUIDE"
- ㉒ SAT.CONT. button ➔ page 19, 32
- ㉓ SAT.MONI. button ➔ page 39
- ㉔ ON/STANDBY button ➔ page 20, 21
- ㉕ RETURN button\*<sup>2</sup>
- ㉖ CHANNEL buttons ➔ page 20, 33
- ㉗ AUDIO button ➔ page 73
- ㉘ DVD button ➔ page 32, 38, 60
- ㉙ INSTANT SKIP button ➔ page 64
- ㉚ INSTANT REPLAY button ➔ page 64
- ㉛ CONTENT MENU button ➔ page 55, 95
- ㉜ EDIT MENU button ➔ page 108
- ㉝ SKIP button ➔ page 65
- ㉞ PICTURE SEARCH button ➔ page 55, 64
- ㉟ ENTER button ➔ page 55, 150
- ㊱ PLAY button ➔ page 60
- ㊲ QUICK MENU button ➔ page 24, 82
- ㊳ O button ➔ page 150
- ㊴ STOP button ➔ page 35
- ㊵ TIME BAR button ➔ page 81
- ㊶ CHP DIVIDE button ➔ page 90
- ㊷ P in P button ➔ page 69
- ㊸ ZOOM button ➔ page 72
- ㊹ PROGRESSIVE button ➔ page 17 in "INSTALLATION GUIDE"
- ㊺ INPUT SELECT button ➔ page 38
- ㊻ TV/DVR button ➔ page 35
- ㊼ VIDEO Plus+ button ➔ page 46
- ㊽ EXTEND button ➔ page 43, 45
- ㊾ Number buttons ➔ page 46, 67
- ㊿ SETUP button ➔ page 150
- ① REC MODE button ➔ page 34
- ② TV CODE button ➔ page 52 in "INSTALLATION GUIDE"
- ③ T.SEARCH button ➔ page 67
- ④ CLEAR button ➔ page 67
- ⑤ DELETE button ➔ page 50

\*<sup>1</sup> MENU

Use this to display a menu screen that is recorded on a DVD video disc.

Operate the menu screen as the same manner as "Locating a title using the top menu (➔ page 61)". A menu screen is not recorded on some discs.

\*<sup>2</sup> RETURN

Returns to the previous screen (the screen may be specified depending on the disc).

Refer to the instructions of the disc.

## Display

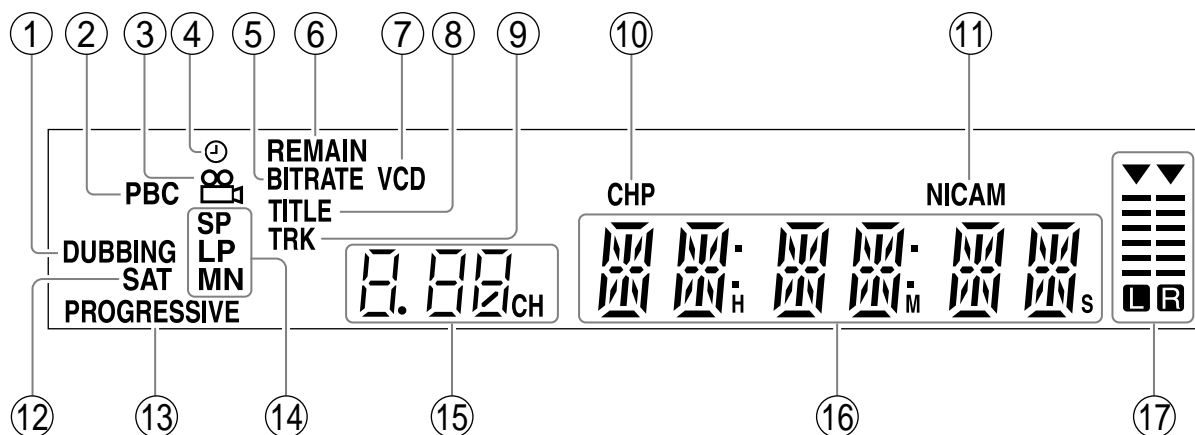

- 1 DUBBING indicator**  
Illuminates when copying.
- 2 PBC indicator**  
Illuminates when PBC function is "On" (➔ page 156) and a PBC-controllable VIDEO CD is loaded.
- 3 Angle icon ➔ page 70**  
Illuminates when playing a scene recorded with multi angles.
- 4 Program recording indicator**  
Illuminates when the recorder holds a timer program.
- 5 Bit rate indicator**  
Illuminates when displaying the bit rate selected for recording, or when displaying the actual bit rate.
- 6 REMAIN (Remaining space) indicator**  
Illuminates when an available recording time is displayed.
- 7 VCD/CD indicator**  
VCD : Illuminates when a VIDEO CD is loaded.  
CD : Illuminates when an audio CD is loaded.
- 8 Title indicator**  
Illuminates when a title number is displayed.
- 9 TRK (Track) indicator**  
Illuminates when a track number is displayed.
- 10 CHP (Chapter) indicator**  
Illuminates when a chapter number is displayed.
- 11 NICAM indicator**  
Illuminates when "NICAM" (➔ page 158) is set to "On" and while receiving stereo stereo/Mode I, II/mono programmes of NICAM broadcasts.
- 12 SAT indicator**  
See the next page.
- 13 PROGRESSIVE indicator**  
Illuminates when video signals are output in the progressive format.
- 14 Picture quality mode indicator ➔ page 161**  
The current picture quality mode lights up.  
The modes are: MN (Manual)/SP (Standard Play)/LP (Long Play)/SP+LP+MN (Auto)

### ■ Dimming the display

Pressing the DIMMER button on the remote control changes the brightness of the display (normal/dimmed/off).

### ■ Switching the display

Every time you press the FL SELECT button, the display changes between the channel, title number, and time. The display may not change, depending on the disc or recording conditions.

### ⑮ Channel indicator

Displays the current channel or other numbers such as a title number, track number, bit rate or input selection.

### ⑯ Multi display

Displays the current time, elapsed time, remaining time, starting time of programmed recording, chapter number or message, etc.

### ⑰ Analog output level indicator

Displays the analog output level.

L+R: Stereo and bilingual (left (main) channel and right (sub) channel)

L : Left (main) channel

R : Right (sub) channel

Off : Mono

Level indicator may not show exact sound level. It only shows the average level.

### ■ SAT indicator and channel selection

While the SAT indicator illuminates, you can select channels of a connected satellite receiver from the recorder.

(It is necessary to finish the connection and the settings (▶ page 20, 45, INSTALLATION GUIDE).)

Each time you press the SAT.CONT. button, the SAT indicator turns on and off.

# Before operating this recorder

## ■ Is your recorder ready?

- Refer to the supplied "INSTALLATION GUIDE" manual and finish the necessary preparations.
- Turn on the connected equipment such as a TV or audio system and select the input from the recorder.

## ■ Turning the power on

(This owner's manual instructions are based on the assumption that all proper connections have been completed and the TV is turned on.)

Press ON/STANDBY on the front panel of the recorder or on the remote control.

ON/STANDBY button

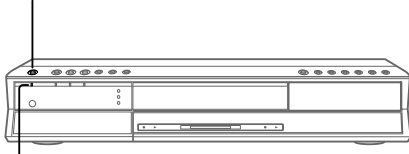

ON/STANDBY indicator

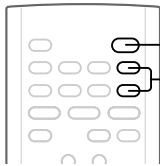

ON/STANDBY button

CHANNEL buttons

When the power turns on, the ON/STANDBY indicator changes from red (standby mode) to green (operation). After a few seconds, a start-up screen appears. The following icon appears at the top right corner of the screen.

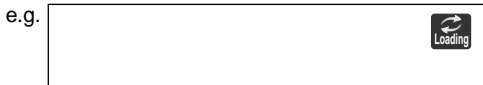

When this icon disappears, the recorder is ready to operate. If the disc drive contains a disc, it takes a little longer to start up.

## ■ Viewing TV channels through this recorder

After turning the power on, the recorder will output TV channel signals to the connected TV (also in the stop mode).

You can select a desired channel by pressing the CHANNEL or the number buttons.

While the SAT indicator is on, channels of the connected satellite receiver are selected. It is necessary to finish the connection and the settings. Refer to  page 20, 45, INSTALLATION GUIDE.

## ■ Loading a disc

Check disc compatibility beforehand ( page 6, 7) and use a proper playable disc.

### Caution

- Keep your fingers well clear of the disc tray. Neglecting this may cause serious personal injury. Keep a close watch on children.
- Do not use a cracked, deformed, or repaired disc.

### 1 Open the disc tray.

Press  on the front panel or the OPEN/CLOSE button on the remote control.

 button

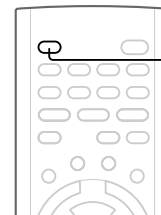
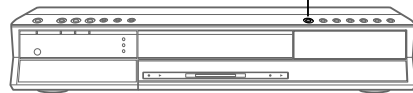

OPEN/CLOSE button

### 2 Insert a disc.

#### Disc without a cartridge

Insert with the playback side down.

There are two kinds of disc size. Place a disc to fit the guide. If a disc is out of the guide, it may result in damage to the disc or malfunction.

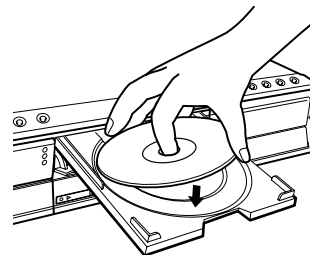

Place a disc in the inside hollow.

#### DVD-RAM disc with cartridge (TYPE1/TYPE2/TYPE4)

##### Single sided

Turn the printed side up, and insert the cartridge into the tray frame following the direction of the arrow on the cartridge.

##### Double sided

Turn the desired recording/playback side up, and insert the cartridge into the tray frame following the direction of the arrow on the cartridge.

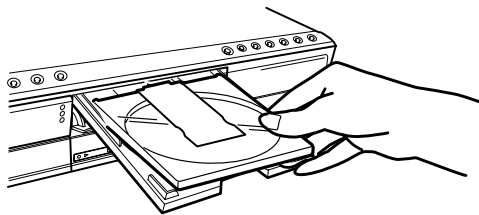

### 3 Close the disc tray.

Press **▲** on the front panel or the OPEN/CLOSE button on the remote control.

#### Notes

- Use the button on the front panel or the remote control to open and close the disc tray. Do not push or hold the disc tray while it is moving. Doing so may cause the recorder to malfunction.
- Do not insert a disc which is unplayable, or any object other than a playable disc.
- Do not apply downforce to the disc tray. Doing so may cause the recorder to malfunction.
- If the disc tray stops while closing, the mechanical protection system of this recorder will open it. Do not force it to close. Doing so may cause malfunction.
- If the disc tray will not open, turn the recorder off, and press the **▲** button on the front panel or the OPEN/CLOSE button on the remote control. This may turn the recorder on and open the disc tray. If it still won't open, contact your nearest TOSHIBA dealer.

### ■ Turning the power off

Press **ON/STANDBY** on the front panel of the recorder or on the remote control.

The "Unloading" icon appears at the top right corner of the screen, and the ON/STANDBY indicator turns red, then the power turns off (Standby mode.)

#### Caution

- If the power fails or the power cord is disconnected from a wall outlet while the recorder is in operation (ON/STANDBY indicator lit in green), the HDD or a loaded disc may become recording disabled. In such a case, executing an initialization of the disc using the formatting function of the recorder may refresh it. However, all contents stored on the disc will be completely erased by this initialization process.
- This recorder may indicate alert messages with some DVD-RAM discs right after insertion. If such a disc is used for playback or recording on other equipment, all data in the disc may be damaged and the disc will not be played. By executing an initialization of the disc using the formatting function of the recorder, the disc will become operational.
- If the recorder freezes and does not respond at all, leave it alone for about 15 minutes or longer. This may restore the recorder. After the recorder has recovered, turn it off once and turn it on again to use as usual. If the recorder is still inoperable after more than 15 minutes have passed, press and hold the ON/STANDBY button on the front panel or the remote control for about 10 seconds or longer. The recorder is forced to quit and the power turns off. Turn the recorder on again and use it as usual. (This is an emergency measure, which may cause losses and/or damages of data. Avoid casual use of this measure. If you try this while the recorder is working properly, especially while the "Loading" or "Unloading" icon is flashing, it may result in initializing of the HDD.) (This 15-minute measure is available only when "Screen protector" is set to "On." (▶ page 159))

#### Note

- If there are any performance malfunctions of the HDD or the DVD-RAM drive, immediately discontinue use of this recorder, and disconnect the power cord from a wall outlet, then contact your dealer. Continuous use of the recorder in such a condition will aggravate the condition and result in increased cost and repair time.

### ■ Disc tray lock

You can lock the disc tray.

**Press and hold **||** on the front panel or PAUSE on the remote control for longer than about 3 seconds.**

To unlock, during stop press the button for longer than about 3 seconds.

#### Note

- Turning the power off also unlocks the disc tray.

## Before operating this recorder (Continued)

### Start-up/Shutdown (closing) icons

These icons are displayed at the top right corner of the screen when startup or finishing. While they are flashing, the recorder is operating as follows:



Start-up, reading a disc, finishing the recording



Unloading a disc, finishing the operation



Opening a disc tray



Closing a disc tray

### Status display

Each time you operate the recorder, the following displays appear on the TV screen to indicate the status of the recorder.

Status display

e.g.



Main on-screen displays

(Depending on the disc, some of these may not appear.)

- ▶ : Playback
- || : Pause
- : Stop
- ▶▶ : Fast-forward
- ◀◀ : Fast-reverse
- ▶▶ : Forward skip\*
- ◀◀ : Reverse skip\*
- ▶|x1/2 : Forward slow-motion
- ◀|x1/2 : Reverse slow-motion
- ||▶ : Forward frame by frame playback
- ◀|| : Reverse frame by frame playback
- : Recording
- || : Recording pause
- Title End : When title playback is completed
- ▶→ : Instant skip
- ←▶ : Instant replay
- Chapter Divide : Chapter division
- ▶↶ : Forward skip by 1/20
- ◀↷ : Reverse skip by 1/20

\* Accompanied with the followings:

HDD DVD-RAM DVD-RW DVD-R :

Title number/title name and chapter number/  
chapter name

DVD-VIDEO :

Title number and chapter number

VCD CD :

Track number

### Notes

- To disable the status display, set "On screen display" (▶ page 159) to "Off."
- You can add the current status of the settings to this display. See ▶ page 80.

# Key operation - EASY NAVI & QUICK MENU

The EASY NAVI button opens the “EASY NAVI Main Menu”, a main gate to the functions of this recorder. From this menu, you can access the desired functions while viewing a current picture. Additionally, the QUICK MENU button provides you a sub-menu of the current function.

## ■ EASY NAVI

Press EASY NAVI.

Sound is muted and the following GUI appears. (Actual displays vary depending on operational status.)

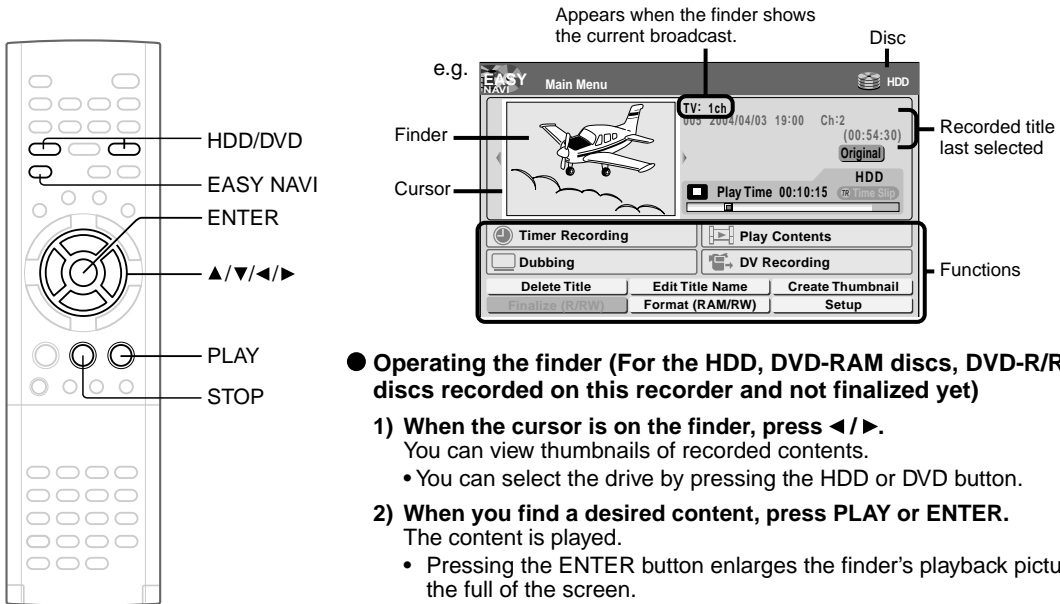

### ● Operating the finder (For the HDD, DVD-RAM discs, DVD-R/RW discs recorded on this recorder and not finalized yet)

#### 1) When the cursor is on the finder, press ◀/▶.

You can view thumbnails of recorded contents.

- You can select the drive by pressing the HDD or DVD button.

#### 2) When you find a desired content, press PLAY or ENTER.

The content is played.

- Pressing the ENTER button enlarges the finder's playback picture to the full of the screen.
- You can change playback speed. See ➡ page 64.

#### 3) To stop, press STOP.

A current channel broadcast appears. (“TV:xxch” accompanies.)

- Pressing the REC button starts recording. On recording, see ➡ page 25.

### ● Item selection

Press ▲/▼/◀/▶ to select an item, then press ENTER.

(Unavailable features are grayed out.)

Item	Function	➡ page
<b>Timer Recording</b>	A list of timer programs appears.	40
<b>Play Contents</b>	Recorded contents are listed in a thumbnail view.	55
<b>Dubbing</b>	You can access a menu to dub the current content.	106
<b>DV Recording</b>	The setting menu for recording contents from equipment connected to the DV terminal appears.	136
<b>Delete Title</b>	You can delete the current content. Operate according to the message.	50
<b>Edit Title Name</b>	An on-screen keyboard appears.	30
<b>Create Thumbnail</b>	You can change the thumbnail picture.	100
<b>Finalize (R/RW)</b>	You can execute the DVD-Video finalizing process on the loaded disc.	132
<b>Format (RAM/RW)</b>	You can format the loaded disc.	28
<b>Setup</b>	A setup menu appears.	150

(Continued)

- **To exit the EASY NAVI**  
**Press EASY NAVI again.**

**Note**

- For a disc other than the specified one, the finder cannot be operated. To play the disc, exit the EASY NAVI then press the PLAY button, or select the "Play Contents" function.
- If a loaded disc contains NTSC signals, more functions will be unavailable.

■ **Quick Menu operation**

To access various optional functions of this recorder, open the Quick Menu. The Quick Menu displays a list of selections relevant to your current mode.

● **Opening a Quick Menu**

1) **Press QUICK MENU.**

The following menu ("Quick Menu") appears.  
(Actual selections vary depending on operational status.)

e.g.

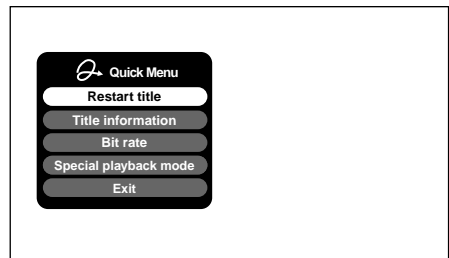

- 2) **Press ▲ / ▼ to select an item, then press ENTER.**

● **To exit the Quick Menu**

**Press QUICK MENU again.**

Alternatively

**Select "Exit" with ▲ / ▼, then press ENTER.**



## Hint on reading this manual

The following icons show the playable discs for each function described on this instruction manual.

**HDD** : HDD

**DVD-RAM** : DVD-RAM disc

**DVD-RW** : DVD-RW disc

**DVD-R** : DVD-R disc

**DVD-VIDEO** : DVD video disc

**VCD** : VIDEO CD

**CD** : Audio CD  
(For CD containing JPEG or MP3/WMA files,  
see  page 76, 78.)

Most instructions are based on remote control operation, unless otherwise noted. You can use the buttons on the remote control and those on the main unit as well when they have the same function.

If copy protection signal is detected during recording on this recorder, the recording automatically pauses and a message appears. In this case, the PAUSE button cannot release the recording. (It is possible to end the recording by pressing the STOP button.) If the copy protection signal continues, the recording will terminate.

# Recording

Recording variations for many types of programmes or situations.

- Before recording
- Recording a TV programme
- Recording an external source
- Programing a recording (REC MENU)
- VIDEO Plus+ Recording
- Others

# Before recording

Please be sure to read this critical background information prior to making a recording.

**This recorder is equipped with a built-in HDD. Conventional video cassette recorders have required tapes to record, while this recorder enables recording on the HDD whenever you want, without selecting an available tape or confirming its recording time or tape remaining. Further, the DVD-RAM drive on this recorder can record on a DVD-RAM/RW/R disc in the same way as a tape. You can also copy contents recorded on the HDD to a DVD-RAM/RW/R disc to create your own library.**

## ■ Is your recorder ready?

Before recording a TV program on this recorder, insure that channels you want to record are correctly tuned in on this recorder.

If not tuned in, read the separate "INSTALLATION GUIDE" volume again, and confirm all the necessary connections and settings have been done.

Also, insure the clock is set precisely for program recording. Set the clock using the "Initial settings" menu (➡ page 30, INSTALLATION GUIDE).

## ■ Disc initializing

Whenever you use a new DVD-RAM/RW disc on this recorder, be sure to initialize the disc. For DVD-RAM disc, initialization is indispensable to the database system of this recorder.

Normally, the HDD does not need to be formatted. If the HDD does not work normally due to a problem, format the HDD for possible recovery. Once you format the HDD, all the recorded titles and Library information are deleted. Before formatting, be sure to write Library information to a DVD-RAM disc and check any titles to be deleted.

DVD-RW discs can be emptied by initializing.

DVD-R discs can be used on this recorder without initializing.

For details of initialization of DVD-RAM/RW discs, see ➡ page 28.

If an initialized DVD-RAM disc is still unusable, it may become usable by executing "DVD-RAM physical format" in the "Management settings" menu.

For "DVD-RAM physical format", see ➡ page 29.

## ■ Note on recording on a DVD-RAM disc

Confirm disc compatibility and prepare an available DVD-RAM disc to record on (➡ page 6, 8).

Some discs may need to be formatted for use on this recorder. A message will appear asking you to execute disc formatting. Follow the procedure displayed on-screen to format the DVD-RAM disc compatible with this recorder.

Some DVD-RAM discs formatted on a PC may not be usable.

## Note

- This recorder records on a DVD-RAM disc if it complies with DVD-RAM standard Version 2.0 or 2.1. However, you may not record on some DVD-RAM discs that have complicated contents (often, to protect the recorded data). When you select a DVD-RAM disc that has already been recorded, check that the disc is suitable for recording or the remaining time of the disc is displayed. It is recommended to use a new DVD-RAM disc for an important recording.

## ■ Note on recording on a DVD-RW disc

Confirm disc compatibility and prepare an available DVD-RW disc to record on (➡ page 6, 9).

Some discs may need to be initialized for use on the recorder. A message will appear asking you to execute disc initializing. Follow the procedure displayed on-screen for initialize the DVD-RW disc compatible with this recorder.

Some DVD-RW discs initialized on a PC may not be usable.

To play a DVD-RW disc recorded on this recorder on other devices, finalize the DVD-RW disc on this recorder. (➡ page 132)

The finalization disables the disc's rewritability. To rewrite a finalized DVD-RW disc, cancel the finalization (➡ page 135).

- On DVD-RW discs recorded on other devices, you cannot execute DVD-Video finalize process or cancel the finalize process, or add recordings on this recorder.
- You cannot rewrite or edit a DVD-RW disc if recorded in DVD-VR mode.
- DVD-RW discs which are recorded on other devices and not finalized yet, cannot be read on this recorder. Do not rush to initialization. Check that the contents can be erased or not.

### ■ Note on recording on a DVD-R disc

Confirm disc compatibility and prepare an available DVD-R disc to record on (➡ page 6, 9).

To play a DVD-R disc recorded on this recorder on other devices, finalize the DVD-R disc on this recorder. (➡ page 132)

The finalization permanently disables the disc's writeability. (Cancelling the finalization is not possible.)

- DVD-Video finalize process cannot be cancelled if once executed on a DVD-R disc.
- On DVD-R discs recorded on other devices, you cannot execute DVD-Video finalize process or add recordings on this recorder.
- DVD-R discs with the method of "DVD-Video Creation" have been already executed the DVD-Video finalize process. Therefore, they cannot be added the contents.

### ■ If you want to record contents which will be copied to a DVD-R/RW disc later on

See ➡ page 36.

### ■ To check space remaining on a disc

#### 1) Press the REMAIN button.

The current capacity per disc is displayed at the bottom of the screen. The current capacity of the selected drive is displayed on the front panel display.

#### 2) After checking the capacity, press the button again to turn off the display.

#### Note

- You can also check the capacity of the disc by selecting "Disc budget calculation" from the Quick Menu within the REC MENU (➡ page 44).

### ■ When "HDD recording is not possible due to..." appears

The HDD is full. To record new content, delete unnecessary titles or transfer some content to a DVD-RAM disc.

### ■ Programmed recording and operational status

The recorder gives priority to programmed recordings in every operating mode. Even if the recorder is playing, recording or editing, or even in standby mode, at a starting time of a programmed recording the recorder will make itself ready or stop those operations and start the recording.

However, "Creating a DVD-Video" (➡ page 122) and "DVD-Video finalizing process" (➡ page 132) operations may have priority over programmed recordings.

### ■ When the programmed settings overlap

Before the first recording is completed, the second programme is scheduled to begin recording. When using a DVD-RAM disc, the recording of the previous programme stops 15 seconds before the next programme starts. (If you have been recording over 8 hours on the same drive, the current recording stops approximately 2 minutes before the next programme starts.)

When using a DVD-R or DVD-RW disc, the recording of the previous programme stops about 2 minutes before the next programme starts, to complete data process. In this 2 minutes, you cannot operate the loaded DVD-R or DVD-RW disc.

### ■ On a programmed recording across the change-over of Daylight-saving time

- When the clock gains across Daylight-saving time during a programmed recording, it means that the recording completion time is consequently set one-hour earlier. In this case, set the programmed recording one-hour longer in advance. If not set accordingly, the programmed recording stops one-hour shorter.
- When the clock loses across Daylight-saving time during a programmed recording, it means that the recording completion time is consequently set one-hour later. In this case, as the programmed recording continues one-hour longer, delete unnecessary chapters by chapter dividing after the completion of recording.

#### Notes

- The "Loading" icon appears in the top right of the screen after recording. This indicates that the unit is executing the final recording process (writing managing information). Operations other than changing channels cannot be done until this icon disappears. The time for executing this process differs depending on the recording time or capacity of the disc.
- Note that all recording content may be deleted if the unit is disconnected from a wall outlet, or a power failure occurs, during recording.
- If a power failure occurs within 5 minutes prior to the programmed recording start time, the programmed recording may not be executed.
- A programmed recording may not be executed correctly if scheduled when Daylight-Saving time starts or ends.

## Initializing a DVD-RAM/RW disc (Logical Format)

**Be sure to read this section prior to using a DVD-RAM/RW disc on this recorder for the first time. For DVD-R, initializing is not necessary.**

A disc should be initialized in the following cases: (The recorder may display a message to request you to do so.)

e.g.

- When you use a DVD-RAM/RW disc on this recorder for the first time.
- If data fragments produced by repeated recording or erasing have accumulated.
- If a disc error has occurred.
- When you want to record on a DVD-RAM disc for PC. (➡ page 8)

Initializing formats a disc logically and insures that it will perform to its full capability. However, this erases all data on the disc, so make sure that it does not matter if data on the disc is erased whenever you initialize a disc.

### ■ How to initialize a disc

To initialize a DVD-RAM disc, load it in the recorder. See ➡ page 20 for loading a disc.

#### 1) During stop, press QUICK MENU.

The following menu appears. (The actual contents depends on the operational status of the recorder.)

e.g.

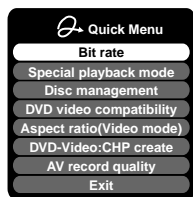

#### 2) Press ▲ / ▼ to select “Disc management,” then press ENTER.

A sub-menu appears on the right side.

e.g.

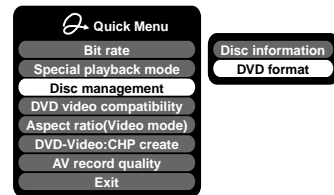

#### 3) Press ▲ / ▼ to select “DVD format,” then press ENTER.

e.g.

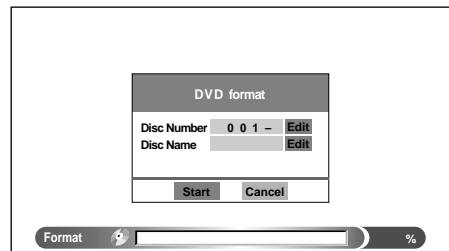

### Numbering a disc

The recorder automatically numbers discs when initializing. However, you can assign a desired number (using 3 digits) and designate sides A and B on a double-sided disc. (DVD-RW discs cannot be numbered.)

- (1) Press the ▲ / ▼ buttons to select “Edit” of “Disc Number” then press the ENTER button.
- (2) Press the ▲ / ▼ buttons to select a digit.
- (3) Press the ◀ / ▶ buttons to shift.
- (4) Repeat steps (2) and (3).
- (5) Press the ENTER button.

### Naming a disc

You can name a disc.

- (1) Press the ▲ / ▼ buttons to select “Edit” of “Disc Name,” then press the ENTER button. The character input window appears.
- (2) Enter a disc name following the procedure of “Entering characters” (➡ page 30).
- (3) Press the ★ button to eliminate the window.

- 4) Press ◀/▶ to select “Start,” then press ENTER.

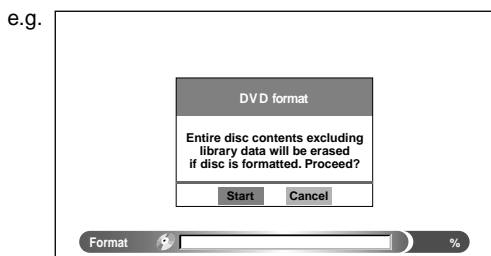

- 5) Press ◀/▶ to select “Start,” then press ENTER.  
Initialization starts.

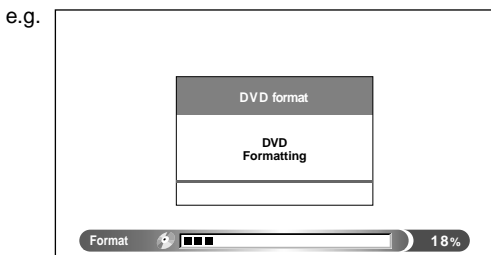

When initialization is completed, the setup window disappears.

## DVD-RAM physical format

Physical formatting is a simple execution for a disc which cannot be used or read (or which is becoming hard to read). It may refresh such a disc for recording and playback. (There is no guarantee that all such discs will be recovered.)

“DVD-RAM logical format” process only rewrites certain data on file system and management information, however, “DVD-RAM physical format” rewrites all data on a disc, therefore it takes a much longer time to complete. For a 4.7GB single sided DVD-RAM, about 70 minutes will be necessary. While processing, all recorder operations and functions including program recording will not work until the process is finished. Also this process erases all data stored on the DVD-RAM disc.

- 1) During stop, press SETUP.

- 2) Press ◀/▶ to select “Management settings” then press ENTER.

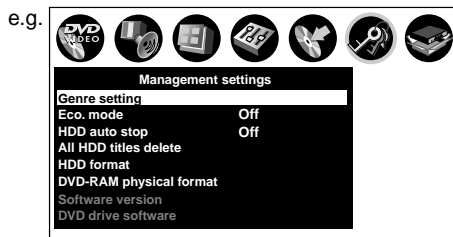

- 3) Press ▲/▼ to select “DVD-RAM physical format,” then press ENTER.

- 4) Press ◀/▶ to select “Yes,” then press ENTER to execute.

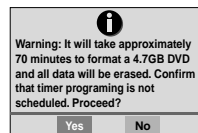

To cancel, select “No”, then press the ENTER button.

- 5) Read the message, and press ◀/▶ to select “Yes” or “No”, then press ENTER.

## Notes

- The physical format process may fail if executed to a dirty DVD-RAM disc. Also, the disc may be difficult to record, even if it finished. Before executing DVD-RAM physical format process, be sure to confirm the disc is not dirty. Clean it if necessary. If the disc has scratches or dust beyond cleaner's efficacy, do not execute DVD-RAM physical format process on the disc.
- The following DVD-RAM discs require physical formatting:
  - A disc which is not formatted correctly.
  - The disc which has errors during writing because of dirt on the disc, and cannot be further recorded, or cannot initialize normally.
- You need to start physical formatting from the first step again when you use a failed disc.
- Physical formatting does not work if the disc contains a lot of voids beyond the limitation of this recorder.
- If an error occurs in physical formatting, “ERR-01” appears in the front panel display. To turn off the message, press the DISPLAY button on the remote control.

## Entering characters

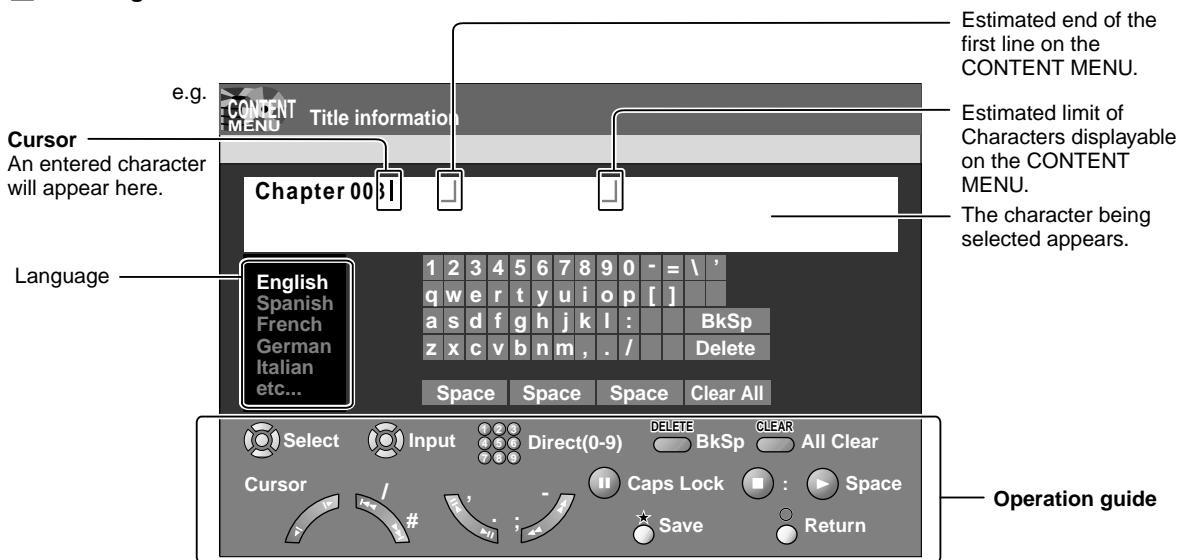

### ■ Operation guidance of the remote control

To enter the character, normally use the direction ▲/▼/◀/▶ buttons on the remote. About the other buttons to be used are shown on the operation guide.

: Shifts a cursor.

: Enters the number.

: Erases one character immediately to the left side of the cursor.

: Erases all the characters on the input column.

: Caps Lock

: Saves the changes on the input column and returns to the previous screen.

: Cancels the changes on the input column and returns to the previous screen.

: Enters a space.

: Enters a symbol.

### ■ Switching a language

Before entering a character, move a cursor to the language selection area by pressing the ◀/▶ buttons. Then press the ▲/▼ buttons to select a language, then press the ENTER button.

## ■ Entering characters

The cursor may be followed by unwanted characters. You can erase them if necessary by either of the following measures:

### Erasing characters

- Erasing all the characters on the writing board  
Select "Clear All" by pressing the ▲ / ▼ / ◀ / ▶ buttons, then press the ENTER button.  
Alternatively, open the lid of the remote control and press the CLEAR button.
- Erasing one character before the cursor  
Select "BkSp" by pressing the ▲ / ▼ / ◀ / ▶ buttons, then press the ENTER button.  
Alternatively, open the lid of the remote control and press the DELETE button.

- (1) Press the **||** button to select an input mode.
- (2) Press the ▲ / ▼ / ◀ / ▶ buttons to select a character, then press the ENTER button.  
The selected character is input on the cursor.
- (3) Repeat steps (1) and (2) to enter characters.
- (4) When finished, press **★** to save the characters.  
The characters you entered appears.

### Notes

- You can enter up to 64 characters.
- When unnecessary information appears, or when you want to alter the input character, press the CLEAR button to erase all, or press the DELETE button to erase an unnecessary character.

# Recording a TV programme

To record a TV programme currently being broadcast, follow the procedures of this chapter.

## ■ Preparation

- When you record on a DVD-RAM/R/RW disc, load it into the recorder.
  - Load a disc which has sufficient space available to record the programme.
  - Make sure the loaded disc is not write-protected.
- If you record on a DVD-R or a DVD-RW disc, set "DVD compatible mode" (➡ page 162) to "On (Mode I)" or "On (Mode II)". In DVD-R/RW recording, "Off" setting is regarded as "On (Mode I)".
- If you record on a DVD-R or DVD-RW disc, set "Aspect ratio(video mode)" (➡ page 162) according to recording sources.



SAT.CONT.

## 1 Press HDD or DVD to select a media to record on.

HDD

HDD : To record on the HDD.

DVD : To record on a DVD-RAM/R/RW disc.

DVD

## 2 Press INPUT SELECT repeatedly to select a recording source.

INPUT SELECT

Each time you press the button, the indicator alternates.

**Ch:** To record a TV programme with recorder tuner.

**L:** To record a source connected to the INPUT jacks on the front panel (➡ page 37).

**AV1:** To record a source connected to the AV1 socket on the rear panel (➡ page 37).

**AV2:** To record a source connected to the AV2 socket on the rear panel (➡ page 37).

**L-U:** To record pictures currently played (➡ page 116).

To record a satellite programme, press the SAT.CONT. button to turn on the SAT indicator. The input you have set (➡ page 45, INSTALLATION GUIDE) is selected. For details, see ➡ page 19.





Open the lid.

### 3 Press the number buttons to select a channel to record.

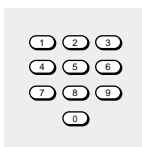

The CHANNEL buttons (↖↗) are also available.

- While the SAT indicator is on, channels of the connected satellite receiver are selected.

### 4 Press QUICK MENU to display the Quick Menu. (If you want to use the default setting for “AV record quality,” skip to step 8.)

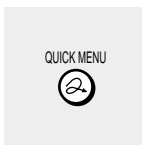

### 5 Press ▲/▼ to select “AV record quality,” then press ENTER.

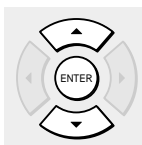

### 6 Press ◀/▶ to select a media to be recorded, then press ADJUST to select the setting number.



e.g.

AV record quality			
HDD	Setting 1	DVD	---
Manual	6.6	L-PCM	SP 4.6 DD/DM1
Custom setting			
Setting	Mode	Rate	Audio quality
1	Manual	6.6	L-PCM
2	SP	4.6	DD/DM1
3	LP	2.2	DD/DM1
4	Manual	6.0	DD/DM2
5	Manual	3.2	DD/DM1
Total recording time: 71min. (with 4.7 GB unused)			

See page 41 for details on “Mode”, “Rate” and “Audio quality”.

(Continued)



**7 Press ENTER.**



The menu disappears.

---

**8 Press REC.**



Recording starts.

### ■ Selecting the recording mode

Before recording, you can select the setting of picture and sound quality. During stop mode, press the REC MODE button. By pressing the button repeatedly, you can select one from 5 settings of “AV record quality” appearing in the front panel display.

#### Notes

- During recording, you cannot change the recording parameters, such as modes, channels, etc.
- The number of titles cannot exceed 99 for a DVD-RAM/RW/R disc or 396 for the HDD.
- One continuous recording cannot exceed in any case 8 hours. Recording automatically stops at 8 hours.
- During normal recording, you can set the programmed recording using the REC MENU.
- You cannot start recording immediately before a programmed recording starts.
- For recorded sound, see ➡ page 74.
- During monaural sound recording, the same sound is recorded on both the left and right channels.
- When “Audio” is set to “L-PCM”, multi-channel sound is recorded as stereo sound. When playing this recorded sound, you will hear NICAM Mode I and NICAM Mode II sounds simultaneously. Press the AUDIO button to select a desired sound.
- When “DVD compatible mode” is set to “On (Mode I)” or “On (Mode II)”, the unit records the same sounds on both the left and right channels when receiving monaural sound. When receiving the NICAM Mode I/Mode II sound, the selected sound, Mode I or Mode II, is recorded on both the left and right channels.
- Depending on the disc condition, pressing the REC button may take a longer time to start recording.
- When a starting time of a programmed recording comes, a recording in execution is stopped and the programmed recording starts. If you do not want to stop the recording, cancel the timer program before it starts.
- Even if you set “Aspect ratio(video mode)” (➡ page 162) to “16:9”, images are recorded in 4:3 aspect ratio when using a DVD-R or DVD-RW disc with “Rate” set to “1.4” (Mbps).
- Be careful of a programmed recording across the change-over of Daylight-saving time (➡ page 27).

### ■ To stop recording

Press **STOP**.

### ■ To pause recording (to omit an unnecessary portion)

During recording, press **PAUSE**.

To resume recording, press it again.

#### Note

- Pausing recording automatically creates a new chapter division at that point.

### ■ To change a TV channel to be recorded

1) During recording, press **PAUSE**.

Recording pauses.

2) Press **CHANNEL** to change the channel.

3) Press **PAUSE** to resume recording.

### ■ To view a TV programme while recording another

1) Start recording on this recorder.

2) Press the **TV/DVR** button.

3) Using the channel selector of the TV, select a desired channel on the TV.  
If you press the **TV/DVR** button again, you will go back to the display that you are recording.

### ■ To record and play at the same time

#### ● To start recording while playing a disc

Stop playback, then select the other disc by pressing the **HDD** or **DVD** button, and start recording on that disc.

#### ● To play a disc while recording on another disc

Select the disc that is not being recorded by pressing the **HDD** or **DVD** button, and start playback on the disc.

#### Note

- During a dubbing job, the unoccupied drive is available for recording or playback, however, cannot perform a function which records and plays simultaneously.

### ■ To set an end time of a recording which is in progress

1) During recording, press **QUICK MENU**.

The Quick Menu appears.

2) Press **▲ / ▼** to select "End time" then press **ENTER**.

The display changes as follows:

e.g.



3) Press **◀ / ▶** to select an item then press **ADJUST** to change the value.

4) Press **ENTER**.

#### Notes

- By setting an end time, it is memorized as a programmed one, and the  indicator in the front panel display illuminates to indicate that the recorder holds a timer program of recording.
- The programmed end time must be set for 5 minutes later than the current time.

### Recording a TV programme (Continued)

#### ■ To play a recorded title while recording another on the same disc (Recorded Title Play)

HDD DVD-RAM

During recording, you can play a title recorded on the same disc.

1) While recording, press **CONTENT MENU**.

2) Press **▲ / ▼ / ◀ / ▶** to select a desired title, then press the **ENTER**.

Playback of the selected title starts.

Pressing the **STOP** button stops playback, and the content currently recorded returns. If you press the **PLAY** button, playback resumes from the location you last stopped.

#### Notes

- The playback picture may appear after a delay of several seconds.
- While you are using this function, the following operations/functions are not available.
  - Programmed playback (repeat playback, intro scan etc.)
  - Editing (Playlist programming, dubbing, title/chapter naming, title thumbnail setting, etc.)
- This function is not available at a 10 minutes overlapped portion of the relay recording or A-B recording (➡ page 48).
- Depending on the data condition, playback may pause.
- During a dubbing job, this function is not available.

#### ■ When recording contents which will be copied to a DVD-RW/R disc later on

Before recording, set "DVD compatible mode" (➡ page 162) to "On".

Each timer program must be set its "DVD compatible mode" from the Quick Menu.

# Recording an external source

You can record programmes from connected equipment on the HDD or a DVD-RAM/R/RW disc.

Connect according to A or B.

## A: Using the AV socket on the rear of the recorder

For recording from a digital video camera recorder, etc. connected to the DV input terminal on the front panel, see  page 136, "DV recording."

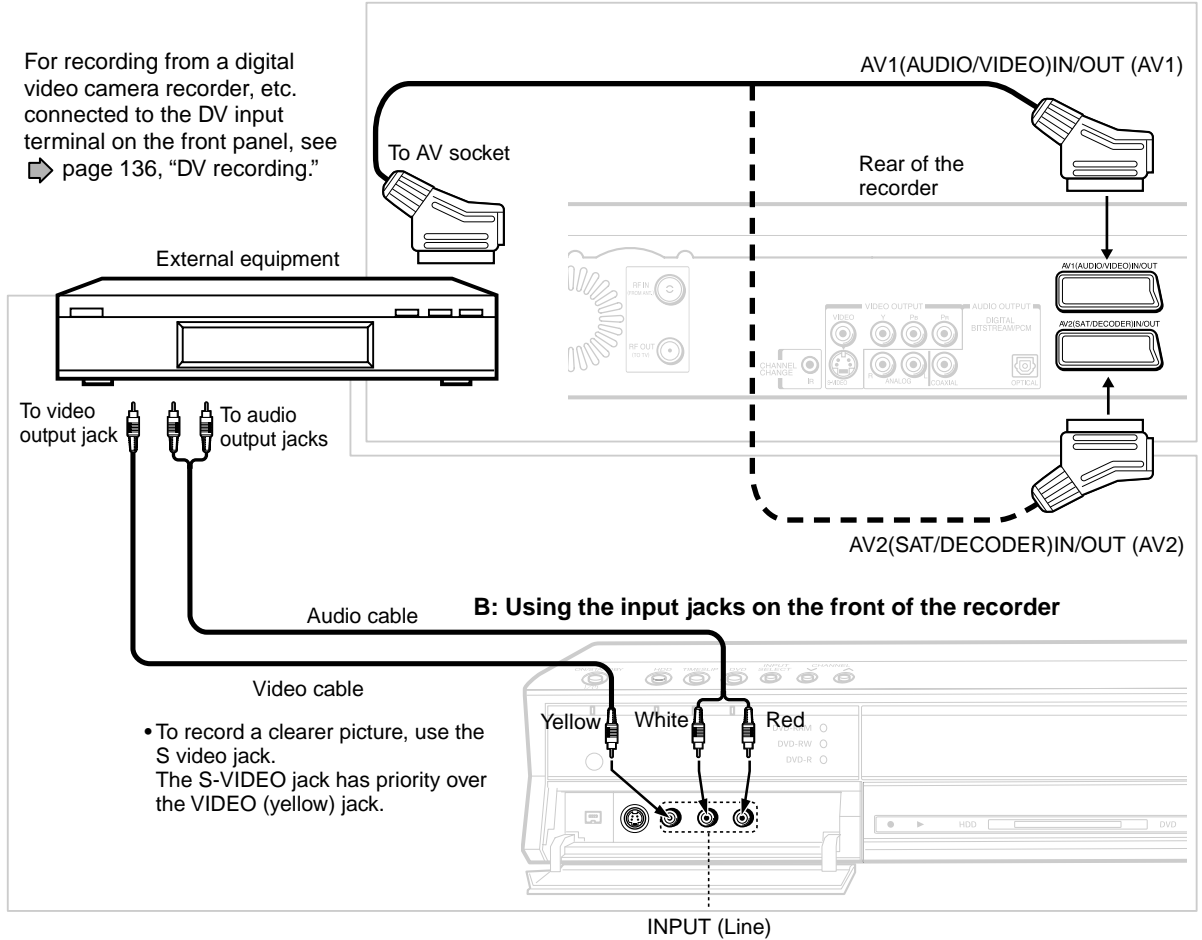

- To record a clearer picture, use the S video jack. The S-VIDEO jack has priority over the VIDEO (yellow) jack.

## ■ Preparation

- When you record on a DVD-RAM/R/RW disc, load it into the recorder.
  - Load a disc which has sufficient remaining space to record the programme.
  - Make sure the loaded disc is not write-protected.

## Notes

- Even if a source of high quality sound track such as DVD audio is recorded with this recorder, the sound quality becomes regular audio CD's one. Refer to the instructions of the connected equipment.
- When you record an external source onto a DVD-R/RW disc or a contents which will be copied to a DVD/R/RW disc later on, set the connected equipment to output sound you want to record (if selectable such as multiplex broadcasting), as the recorder records sounds of external source in the stereo type onto a DVD-R/RW disc, neglecting the setting of "DVD compatible mode" ( page 162).
- DVD-R/RW discs cannot record contents with copy restriction signal embedded (copy-protected or copy once contents), DVD-RAM discs can record copy once contents.
- Some satellite programmes via a connected tuner may contain both 4:3 pictures and 16:9 pictures. DVD-R/RW discs cannot record such contents, under restriction of DVD-Video standard. To record them, use the HDD or DVD-RAM discs.

(Continued)



SAT.CONT.

# 1 Press INPUT SELECT repeatedly so that “L,” “AV1” or “AV2” appears on the front panel display, corresponding to the input in which the device is connected.



Each time you press the button, the indicator changes.

**L:** To record pictures from equipment connected to the INPUT jacks on the front panel.

**AV1:** To record pictures from equipment connected to the AV1 socket on the rear panel.

**AV2:** To record pictures from equipment connected to the AV2 socket on the rear panel.

**L-U:** To record pictures currently played (➡ page 116).

To record a satellite programme, press the SAT.CONT. button to turn on the SAT indicator. The input you have set (➡ page 45, INSTALLATION GUIDE) is selected. For details, see ➡ page 19.

# 2 Press HDD or DVD to select a recording media.



**HDD :** To record on the HDD.

**DVD :** To record on a DVD-RAM/R/RW disc.



# 3 Start playback of the source content on the connected equipment.

# 4 Press REC of this recorder to start recording.



# 5 When recording is completed, press STOP.

STOP



## ■ Notes on recording from a connected VCR or camcorder

### ● Check the condition of the source equipment before playing.

Set the equipment in good condition, e.g. clean the head or adjust the tracking, etc. to obtain optimum playback. Bad condition may produce noises in playback. These noises may be detected as copy protection signals, resulting in stop of recording on this recorder.

Play a source in an usual mode. Avoid using any correcting or enhancing features, as they may add signals which can be detected as copy protection signals.

Source quality or tape condition beyond adjustments on the source equipment may stop a recording on this recorder.

### ● Do not operate the source equipment during recording on this recorder.

Operations such as pausing, resuming, fast-forwarding (CUE) and fast-reversing (REVIEW), etc. may produce noises, which may be detected as copy protection signals. Therefore, first start playback on the source equipment to confirm that the desired source can be played properly, and then start recording on this recorder. Do not operate the source equipment during recording. After completing the desired scene, stop the recording on the recorder, and then stop the playback on the source equipment. Delete unnecessary scenes using editing functions (▶ page 118). If you want to operate the source equipment during recording, pause or stop the recording. After operating the source equipment, resume the recording as above.

### ● When recording from a camcorder

Follow the above notes. Be sure to power the camcorder by its AC adapter, not batteries. If batteries are used, the recording may be finished on the way.

## ■ Satellite monitor function

### • To view a satellite programme while recording a TV programme

- 1) Start recording on this recorder.
- 2) Press the SAT.MONI. button.
- 3) Select a desired satellite channel.

### • To view a satellite programme while the recorder is in the playback or stop mode

- 1) Press the SAT.MONI. button.
- 2) Select a desired satellite channel.

### Notes

- Pressing the SAT.MONI. button again ends the satellite monitor function.
- While the satellite monitor function is working, "SATMON" is displayed on the front panel display.

# Programming a recording (REC MENU)

Use the REC MENU to program a recording. It will take less time to prepare, as it provides all necessary information for recording, including estimated disc space remaining.

For more information, see “Before recording” (➡ page 26).

Be careful when you program a recording across the change-over of Daylight-saving time (➡ page 27).

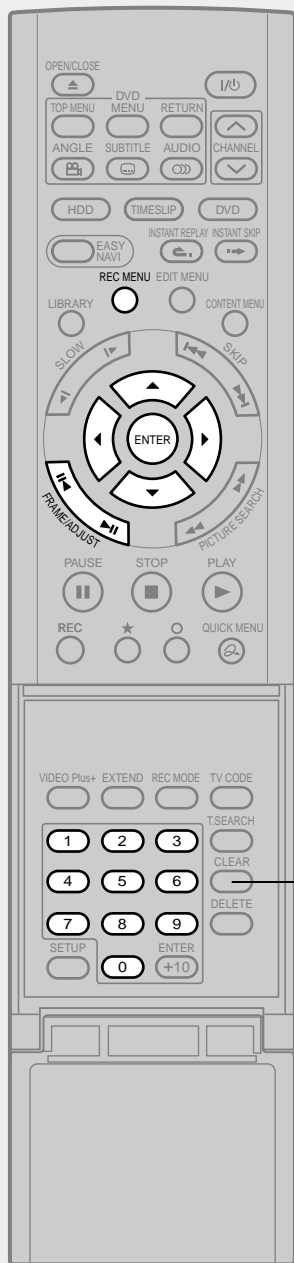

Open the lid.

CLEAR

## 1 During stop, press REC MENU.



The “REC MENU Timer Programming” appears.

e.g.

Exec	CH	Date	Start	End	Media	Mode	Rate	Audio	Disc
	1				HDD	SP	4.6	Dolby	

## 2 Press ENTER.

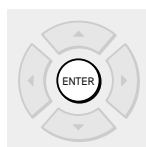

“CH” is ready for setting.

e.g.

Exec	CH	Date	Start	End	Media	Mode	Rate	Audio	Disc
✓	2				HDD	SP	4.6	Dolby	

## 3 Select an item by pressing ◀/▶, then press ADJUST (◀◀/▶▶) to set the item.

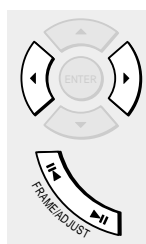

e.g.

Exec	CH	Date	Start	End	Media	Mode	Rate	Audio	Disc
✓	4	4/10 (Sa)	7 00	8 00	DVD	SP	4.6	Dolby	

- Refer to the setting items on the next page.
- You can also set the item by pressing the ▲ / ▼ buttons.
- “CH” can be input by the number buttons.  
To select channels of the connected satellite receiver, first press the SAT.CONT. button so that “S” appears in “CH”, then select the channels (1-999). The number buttons are also available. Be sure to keep the satellite receiver powered on.

## 4 When complete, press ENTER.



To programme another recording, press the ▼ button to move to the next line, then repeat steps 2 to 4.

## 5 Press REC MENU to exit.



Your programme is entered.

- If you want to turn off the power, press the power button.



## ■ Setting items

Exec	√	A timer program with this mark will be executed, To disengage, remove this indicator.
CH	1-99, L, AV1, AV2	Select a channel you want to record. (While “L”, “AV1” or “AV2” is selected, the number buttons are not available to select channels.)
Date	Specified date (from today to 2 month later) Every Sunday to Saturday, Monday to Thursday, Monday to Friday, Monday to Saturday, everyday.	Select a date of a TV programme you want to record.
Start*	0:00 - 23:59	Enter a starting time of recording. (An initial setting is 10 minutes later.) You can also use the number buttons under the lid.
End*	0:00 - 23:59	Enter an end time. (Set the timer to begin recording no sooner than 2 minutes past the current time. Recording must not exceed 8 hours.) You can also use the number buttons under the lid.
Media	DVD	When you record on a DVD-RAM/RW/R disc.
	HDD	When you record on the HDD.
	A-B	When you use A – B (double-side) recording (▶ page 48). “Mode” is automatically set to “Auto”.
Mode	SP	Standard setting of recording time and picture quality. (Not applicable when “L-PCM” is selected.)
	LP	For longer recording, but inferior to “SP” in picture quality. (Not applicable when “L-PCM” is selected.)
	MN(Manual)	Customized setting of rate (bit rate).
	Auto	To set a rate automatically according to the remaining volume of the disc. (If the disc does not have room for the TV programme, the programme cannot be recorded to the end.) When you select an HDD, the recorder records for a length of time corresponding to that of a blank DVD-RAM disc (4.7GB). Not applicable to a recording for 2.5 hours or longer.
Rate	1.4, 2.0-9.2	Not applicable when “SP”, “LP” or “Auto” is selected. You can set a rate at intervals of 0.2Mbps from 2.0 to 9.2. (The upper limit of the value depends on the “Audio” setting.)
Audio	□□ D /M1**	Standard setting.
	□□ D /M2**	Superior to □□ D/M1. Recommended for recording music programmes.
	L-PCM	Uncompressed original digital audio. Equal quality to audio CD, but recordable time will be shorter.
Disc		A programmed recording onto a Reservation Disc is marked with an icon.

\* “Start” and “End” accept time up to 30:59 if you use the number buttons. When you enter a time over 24:00 and press the ENTER button, “Date” will gain one day, and the time will be corrected to 0:00-6:59.

\*\* The digital recording technology for consumer products of Dolby Laboratories is used for □□ D/M1 and □□ D/M2. Dolby Digital 192 kbps is set for □□ D/M1 and Dolby Digital 384 kbps for □□ D/M2.

### Notes

- See ▶ page 51, 161 for details on “Mode”, “Rate”, and “Audio”.
- If you record with setting the bit rate to about 4.0 Mbps or below, the recorded pictures may not be played properly if change the playback speed. There will be noise, and the picture quality is lower than other rate settings.

### ■ Suggestions for the picture quality setting

- **For normal recording or when you cannot decide which mode to choose.**  
Select “SP”.
- **When you need a longer recording time and video quality is not important**  
Select “LP”. Inferior to “SP” in picture quality, but it can record longer.
- **To record a high picture quality**  
Select “MN (Manual)” to set a desired bit rate. The higher the bit rate, better the picture quality is, but shorter the recording length becomes. We recommend that you set about 6.0 Mbps to 6.8 Mbps.
- **To fill the disc**  
Select “Auto”. A bit rate is calculated automatically according to the remaining volume of the disc. Some contents may not be recorded on the disc even if you select this function. This is not the function to make full use of the remaining space capacity.

(Continued)

## Programming a recording (REC MENU) (Continued)

## Notes

- The disc tray does not close automatically, even when the recording start time arrives. Set the recorder loaded an available DVD-RAM/R/RW disc beforehand.
- It is not possible to record the same contents onto both the HDD and a DVD-RAM/R/RW disc simultaneously.
- When there is little time before a programmed recording starts, you may not be able to start another recording.
- Playback of the DVD drive pauses when a programmed recording onto the HDD starts.
- Confirm the "DVD compatible mode" (➡ page 162) setting. "Main" or "SAP" records main sound or sub-sound of multiplex broadcasts respectively, and does not record the other. Therefore, select "Main" or "SAP" only when you record onto a DVD-R/RW disc.
- When recording onto a DVD-R/RW disc, set "DVD compatible mode" (➡ page 162) to the desired recording sound for each timer program.

### ■ Setting the details for every timer program

You can specify detail items for each of your timer programme.

#### 1) Press QUICK MENU at step 3 on ➡ page 40.

The Quick Menu is displayed.

e.g.

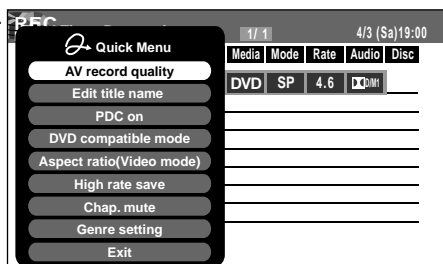

#### 2) Press ▲ / ▼ to select an item and press ENTER.

##### AV record quality

Select an item from registered selections (1-5) for the picture and audio quality.

##### Edit title name

Enter a name for the timer program.

Use the input screen to enter a name (➡ page 30).

##### PDC on

Perform the programme PDC recording.

#### **PDC (Programme Delivery Control System)**

Programme PDC is a system of telling the recorder when a programme actually starts. Typically, when you want to record a programme you will tell the recorder to start recording, probably, five minutes before the advertized starting time of the programme and to finish ten minutes or so after the programme is due to finish. So even if the programme starts early or finishes late you will normally still get to see what you wanted to record. However when live programmes over-run or the day's television schedule is changed from that advertized, you may miss the desired programme

which may have been delayed or even cancelled and the recorder will record the programme even if it is two or more hours late. With PDC, you enter the exact start time and the recorder will wait until the signal is sent to confirm the programme is starting and the recorder will record the programme even if it is two or more hours late.

##### PDC off

Perform the normal programmed recording.

##### DVD compatible mode

When recording onto a DVD-R/RW disc or recording a content which will be copied to a DVD-R/RW, make this selection (➡ page 162) for each timer program.

"Off" setting is neglected and regarded as "Main" in DVD-R/RW recording.

##### Aspect ratio(Video mode)

Select the aspect ratio when recording onto a DVD-R/RW disc. (➡ page 162)

##### High rate save

Use this feature when you want to save space while using the best picture quality rate for recording. This will use 9.2 Mbps for recording and reduce the rate temporarily for the portion where the high rate is not required where picture is fairly constant.

Off: This feature is disabled and the normal recording is performed.

On: This feature is enabled.

#### Notes

- When the audio quality is set to "L-PCM", the picture quality is set to "Manual 8.0 Mbps". When the audio quality is set to any other selection, the picture quality is set to "Manual 9.2 Mbps".
- While this is set to "On," you cannot change the mode or rate.
- The space used may not change, depending on the picture contents.

### Chap. mute

This feature automatically creates divisions for chapters when no audio (no audible sound) portion is found.

For example, when you have recorded a programme of music clips, you can use this feature to jump to the beginning of a clip during playback. It does not create completely independent chapters or automatically divide into chapters when no audio portion is found.

Off : This feature is disabled.

On : Division for chapters when no audio portion is found.

#### Notes

- Divisions for chapters may not be created, depending on the contents of the programme or the condition of no audio portion, or it may be created at different positions. A division for a chapter may be created within a music clip.
- Depending on the specification made for the recording sound level, a division for a chapter may not be created or it may be created at different positions.
- Setting "On" may create many chapters, and their number may reach the maximum allowed. At that point, no more chapters can be created. In this case, decrease the chapters, for example by combining chapters (➡ page 94).
- This feature is not available on DVD-R/RW discs. To create chapters automatically during recording on DVD-R/RW discs, set "DVD-Video:CHP create." (➡ page 162).

### Genre setting

You can set a genre before setting programmed recording.

To see the registered list, refer to Genre setting (➡ page 163).

Set the genre according to recording contents.

The selection you have made for the timer program is shown at the bottom of the display.

### ■ Shifting a time period of a recording (Time Shift)

If a prior TV programme extends beyond its scheduled time and into one that you programmed, you can shift the programmed start and end time of the recording.

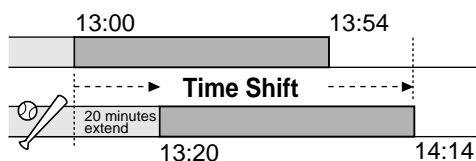

- 1) Press **REC MENU**.  
The REC MENU appears.
- 2) Press **▲ / ▼** to select a timer program you want to shift the time period.
- 3) Open the lid of the remote control and press **EXTEND**.  
"Start time" and "End time" are ready to be input.
- 4) Press **EXTEND** repeatedly.  
Each time you press the button, "Start time" and "End time" is shifted in 10 minutes intervals to, up to 60 minutes later.
- 5) Press **ENTER**.
- 6) Press **REC MENU** to exit.

#### Note

- After you shifted the time of a timer program which will be repeated daily or weekly, you should restore the original start/stop time for future recordings.

### ■ Adding a timer program

- 1) Press **REC MENU**.  
The REC MENU appears.
- 2) Press **▼** to select a blank line, then press **ENTER**.
- 3) Press **◀ / ▶** to select the item, then press **ADJUST** to set the item.
- 4) When complete, press **ENTER**.
- 5) Press **REC MENU** to exit.

#### Note

- While the recorder is preparing for or executing a programmed recording, you cannot add a timer program which will start within 5 minutes and 15 seconds from the current time.

### ■ Deleting a timer program

- 1) Press **REC MENU**.  
The REC MENU appears.
- 2) Press **▲ / ▼** to select a timer program you want to delete.
- 3) Press **QUICK MENU**.  
The Quick Menu appears.
- 4) Press **▲ / ▼** to select "Program cancel", then press **ENTER**.  
Check the message, then delete the entry.
- 5) Press **REC MENU** to exit.

#### Note

- You cannot delete a timer program while another is executed.

### ■ Correcting a timer program

- 1) Press **REC MENU**.  
The REC MENU appears.
- 2) Press **▲ / ▼** to select a timer program you want to change, then press **ENTER**.
- 3) Press **◀ / ▶** to select an item, then press **ADJUST** to set the item.
- 4) Press **ENTER**.  
The modification is registered.
- 5) Press **REC MENU** to exit.

#### Important

- You cannot correct a timer program within 5 minutes before the recording start time. You can only delete the timer program.

#### Note

- You can program a timer recording whose start time has already passed, unless the another program recording will start within 5 minutes. The portion of the program before the recording starts cannot be saved.

### ■ Elapsed programming (using past data for programming)

- 1) Press **REC MENU**.  
The REC MENU appears.
- 2) Press **QUICK MENU**.  
The Quick Menu appears.
- 3) Press **▲ / ▼** to select “Elapsed programming”, then press **ENTER**.  
The “Elapsed programming” list appears.
- 4) Press **▲ / ▼** to select a program, then press **ENTER**.
- 5) Press **◀ / ▶** to select an item to correct, then press **ADJUST** to change the value.
- 6) When complete, press **ENTER**.
- 7) Press **REC MENU** to exit.

#### Note

- Up to 36 past programs are saved. Addition of a new one deletes the oldest one.

### ■ Deleting the past data for programming

- 1) On the REC MENU, press **QUICK MENU**.
- 2) Press **▲ / ▼** to select “Elapsed programming”, then press **ENTER**.  
The “Elapsed programming” list appears.
- 3) Press **▲ / ▼** to select a program to delete.
- 4) Press **QUICK MENU**, then **▲ / ▼** to select “Elapsed programming delete”, and press **ENTER**.  
The selected data is deleted.  
If you want to delete all data at once, select “All elapsed programming delete”.

### ■ Remaining volume

- 1) Press **REC MENU**.  
The REC MENU appears.
- 2) Press **QUICK MENU**.  
The Quick Menu appears.
- 3) Press **▲ / ▼** to select “Disc budget calculation” then press **ENTER**.  
The Disc budget calculation menu appears.
- 4) Press **▲ / ▼** to select a timer program, then press **ENTER** or press **ADJUST**.  
The recorder calculates on a bar graph how much a specific program (identified by a check mark) will occupy on the disc.  
Pressing the **ADJUST** button can display or remove the check mark.

e.g.

REC MENU	CH	Date	Start	End	Media	Mode	Rate	Audio	Result
<input checked="" type="checkbox"/>	3	4/10 (Sa)	11:30	~11:50	HDD	MN	6.6	DDb2	○
<input checked="" type="checkbox"/>	10	4/13 (Tu)	9:30	~10:00	DVD	MN	6.6	DDb2	○
<input checked="" type="checkbox"/>	42	4/16 (Fr)	10:30	~11:30	HDD	LP	2.2	DDb1	○
<input checked="" type="checkbox"/>	4	4/16 (Fr)	8:30	~11:30	DVD	SP	4.6	DDb2	⊗

HDD  Elapsed  Selected(current)  Available DVD

Selected program Available disc space

When the entry item is marked X, the recording does not fit. Change the setting.

### 5) Correct the parameters of the timer program if necessary.

**(Skip to step 7 if you do not need this.)**

You can change "Media", "Mode", "Rate" and "Audio".

Select an item you want to modify and press the ENTER button. The item will be ready to be altered. Press the ADJUST button to modify. When complete, press the ENTER button.

You can adjust to a lower mode (SP to LP) and/or lower the rate to reduce the quality of the recording, and thus provide more disc capacity (space).

### 6) Press ★.

Program modification is registered.

### 7) Press REC MENU to exit the GUI.

#### Notes

- When a Reservation disc (▶ page 49) is inserted in the recorder, you cannot check the remaining volume of other discs.
- The nearest 8 programs are calculated at a time.
- While the recorder is preparing for or executing a programmed recording, any program modification cannot be registered. Only programs which will start after 5 minutes or later can be modified.
- Available disc volume is not displayed for a DVD-R/RW disc on which DVD-Video finalize process was executed.

#### ■ To stop a programmed recording

To finish,

**Press ■ on the front panel twice.**

When you press it once, a message appears. While the message is displayed, press the ■ button once again.

To pause recording,

**Press II on the front panel.**

To resume recording, press it again.

#### ■ Turning the power off automatically after completing a programmed recording

##### 1) While executing a programmed recording, press QUICK MENU.

The Quick Menu appears.

##### 2) Press ▲ / ▼ to select "Auto power off" then press ENTER.

#### ■ Keeping the power on even after the programmed recording finished

If the recorder turns itself on to execute a programmed recording, it will turn itself off after finishing the recording. You can restrict this and keep the recorder powered on.

##### 1) While executing a programmed recording, press QUICK MENU.

##### 2) Press ▲ / ▼ to select "Continuous power on" then press ENTER.

#### ■ Delaying the end time of a programmed recording while it is recording

**While a programmed recording has started, open the lid of the remote control and press EXTEND.**

The first press displays the programmed end time (in the front panel display).

Each time you press the button, it is delayed 10 minutes, up to 60 minutes.

#### Notes

- Pressing a button except EXTEND in the above procedure will set the currently selected delay.
- You cannot delay the end time of a programmed recording which will end within 1 minute from the current time.
- Even if you delay the end time of a programmed recording, the recording will stop when the disc is exhausted. Also it will stop if 8 hours elapsed.

# VIDEO Plus+ Recording

You can program a recording simply by entering the corresponding PlusCode® numbers.

## ■ Preparation

- Make sure that the recorder's clock, receiving channels and their guide channels are set correctly (➔ page 28, "INSTALLATION GUIDE").
- When you record on a DVD-RAM/R/RW disc, load it into the recorder.
  - Load a disc which has space available to record the programme.
  - Make sure the loaded disc is not write-protected.

### For satellite receiver users:

- Finish the set top box setting (➔ page 45, "INSTALLATION GUIDE"), and turn on the satellite receiver.



Open the lid.

CLEAR

## 1 Open the lid of the remote control, and press VIDEO Plus+.



The "REC MENU Timer Programming" with the PlusCode input window appears.

e.g.

REC MENU Timer Programming									
Exec	CH	Date	Start	End	Media	Mode	Rate	Audio	Disc
✓	3	4/10 (Sa)	11:30	-11:50	HDD	MN	6.6	DDMR2	
✓	10	4/13 (Tu)	9:30	-10:00	DVD	MN	6.6	DDMR2	
...	...	...	...	...	HDD	SP	4.6	DDMR1	
VIDEO PLUS+									
PLUS CODE: [ ][ ][ ][ ][ ][ ][ ][ ][ ][ ]									

## 2 Press the appropriate number buttons to enter the PlusCode.

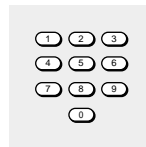

- Refer to newspapers or TV magazines to obtain PlusCodes.
- To correct entered digits, press the CLEAR button to erase them and press the number buttons to re-enter again.

### Note

- When you enter the number starting from 0, a 9-digit number is entered.

## 3 Press ENTER.



The entered program is highlighted.

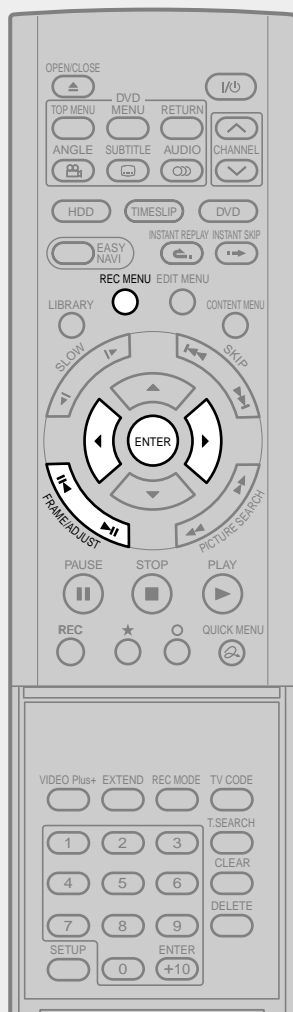

## 4 Select an item by pressing ◀/▶, then press ADJUST (◀◀/▶▶) to set the item, if necessary.



For details about items, see ➡ page 40.

To record a program from the connected satellite recorder, keep the satellite receiver powered on.

## 5 Press ENTER.

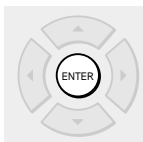

## 6 To enter another program, repeat steps 1 to 5.

## 7 After completing all your entries, press REC MENU.

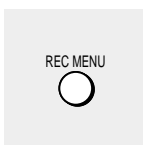

The REC MENU disappears.

To confirm your data, it is recommended to turn on the REC MENU again.

### Notes

- The maximum timer program capacity is 32. Any new program will be rejected if the recorder is full. To enter a new program, you must cancel an existing one (➡ page 43).
- Depending on the program, an actual recording may continue a few minutes longer than programmed.
- Entries made under the following conditions will be rejected.
  - when an entry is for a non existing program.
  - when the digit order of an entry is in error.
  - when the guide channel has not yet been set.
- To erase a timer program, press the QUICK MENU button to display a Quick Menu on the REC MENU. For details, see “Deleting a timer program” (➡ page 43).
- When recording onto a DVD-R/RW disc, set “DVD compatible mode” (➡ page 42) to the desired recording sound for each timer program.
- In the event of a broadcast delay, the next program starts even if when the start time arrives prior to the end of the previous program.

# Others

## Relay recording HDD DVD-RAM

This function automatically diverts a recording to the HDD if a DVD-RAM disc is near capacity.

When the remaining time of the DVD-RAM disc has reached about 10 minutes, the recorder starts recording the same content on the HDD as well as DVD-RAM. The chapter marks are automatically made at the start and end points of the overlapped recording portion. You can delete the unnecessary overlapped portion afterwards by referring to the chapter marks.

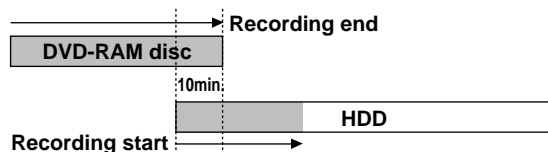

To engage the Relay Recording function, set "Relay recording" to "On" (➡ page 162).

### Notes

- When the capacity of the HDD is not sufficient, the operation is cancelled.
- While recording the overlapped portion, you cannot pause the recording.
- While recording the overlapped portion, you cannot play a recorded title on the same disc.
- When another programmed recording is set just after the relay recording, the relay recording stops about 2 minutes before the next programmed recording starts.

## A-B recording HDD DVD-RAM

This function records one programme at the highest possible rate onto a double sided DVD-RAM disc (9.4GB) or 2 single sided DVD-RAM discs (4.7GB). You can record a long programme with a clearer picture on a DVD-RAM disc.

The A-B recording function records the first half of the programme on the DVD-RAM disc and second half of the programme on the HDD. After the recording, copy the second half recorded on the HDD to the DVD-RAM disc. You can create a DVD-RAM library that has each half of a programme recorded at the highest possible quality.

### Notes

- For A-B recording, use a 12 cm DVD-RAM disc (4.7GB single sided or 9.4GB double sided) that is formatted on this unit just before recording. Do not use an 8-cm disc. Check that the total available space of the HDD is sufficient for the recording one DVD-RAM disc.
- DVD-RW/R discs are not available on the A-B recording.

### ● To use the A-B recording function

At step 3 (➡ page 40), set "Media" to "A-B". "Mode" is automatically set to "Auto".

When the timer setting is completed, "⌚" illuminates on the front panel display.

### ● When recording starts

The same content is recorded on the HDD and the DVD-RAM disc 10 minutes before the unit exchanges the recording media.

Chapter marks are automatically made at the start and end points of the overlapped recording portion, so you can delete the unnecessary overlapped portion afterwards.

If no DVD-RAM disc is loaded, or the loaded disc contains recorded content, all of the recording is made entirely on the HDD. The recording will contain one title with a chapter mark at a dividing point.

During A-B recording, the picture quality mode is set to "Auto" and the unit automatically calculates the picture rate from the disc capacity. Even if the picture rate is set to "Auto", the picture quality of the A-B recording is lower than that of the recording on the HDD, because the unit adds 10 minutes of the overlapped portion to the recording time for capacity calculation. Therefore, the picture rate will remain when the unit cannot record onto a DVD-RAM disc and records on the HDD instead.

### ● After recording

Copy the second half of the programme recorded on the HDD to the alternate side of the double sided DVD-RAM disc, or another single sided DVD-RAM disc. See ➡ page 106 for dubbing operations. When you want to delete the overlapped portion, perform the procedure detailed on ➡ page 50 to delete the overlapped portion either on the HDD or the DVD-RAM disc.

If the entire programme has been recorded on the HDD, copy both parts of programme onto both sides of a blank double sided DVD-RAM disc or two single sided DVD-RAM discs by referring to the chapter mark at the dividing point.



## Reservation Disc (“Lock program record”)

### DVD-RAM

This function is convenient when you wish to record multiple serial related programs on the same disc.

The disc on which you write the reservation data is called “Reservation Disc.” A Reservation Disc may contain only one reservation.

Once a Reservation Disc is created, you cannot use other discs to record the same serial program. The Reservation Disc can be used only for recording a program reserved for the Reservation Disc.

As an example, if you create a Reservation Disc for a serial broadcast from 9 pm to 10 pm on Monday, then you can use that disc only for that program. When you attempt to make a reservation or record that serial, the recorder will ask you to insert that Reservation Disc.

#### 1) Load a DVD-RAM disc.

#### 2) Press REC MENU.

The REC MENU appears.

#### 3) Press ▲ / ▼ to select the program you want to record.

Make sure that “Media” shows “DVD”.

#### 4) Press QUICK MENU.

The Quick Menu appears.

#### 5) Press ▲ / ▼ to select “Lock program record” then “Yes” and press ENTER.

After the recording data is entered, a Reservation disc icon appears on the REC MENU.

If the Reservation Disc is not loaded, the entry data and icon are displayed in gray.

#### ● To cancel the Reservation Disc setting

Load the disc you want to cancel and select the recording option on the REC MENU. Press the QUICK MENU button to select “Unlock program record” then “Yes”, and press the ENTER button.

#### ● To delete the information of a Reservation Disc

If you lose a Reservation Disc, delete the information of the Reservation Disc.

Press the QUICK MENU button to select the program of which data you want to delete, and press the QUICK MENU button. Select “Program record unlock” and then “Unlock selected program.”

If no programmed recording is set on the loaded disc, press the QUICK MENU button to select “Program record unlock” and then “Unlock prog. rec. disc”.

If you schedule a date for programmed recording on the Reservation Disc, the recording information is automatically deleted after the programmed recording is completed.

#### ● To stop the Reservation Disc recording

Press the STOP button on the front panel once. The message appears.

While it is displayed, press the STOP button again. Recording stops.

#### ■ If the start time of a programmed recording of a Reservation Disc comes while recording

A recording start time has priority. The current recording stops about 15 seconds before the start time, and a recording of a Reservation Disc starts on time.

e.g. When a start time of a programmed recording of a Reservation Disc comes during recording on the HDD:

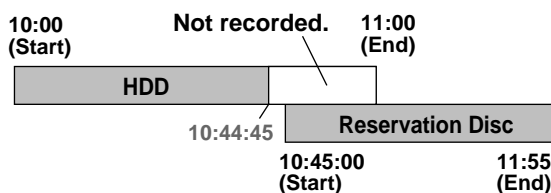

## To delete recorded content

HDD DVD-RAM DVD-RW DVD-R

### Important note

Any deleted title/chapter (original) cannot be restored. Before deleting, be sure to check contents on the disc.

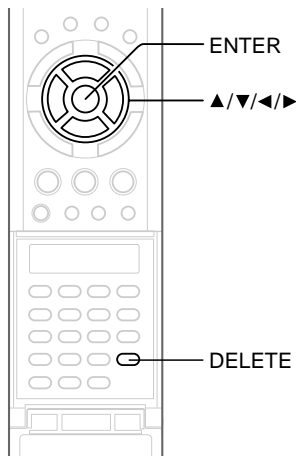

- 1) Perform steps 1 and 2 in “Playing recorded contents (CONTENT MENU)” (➡ page 55) to select a title (chapter).
- 2) Open the lid of the remote control and press the DELETE button.  
Alternate method:  
Press the QUICK MENU button, then press the ▲ / ▼ buttons to select “Title delete” (“Chapter delete”) and press the ENTER button.
- 3) Read the message and press the ◀ / ▶ buttons to select “Yes,” then press the ENTER button.

### Notes

- Deleting a title (a chapter) decreases the numbers of the succeeding titles (chapters).
- A chapter of about 5 seconds or shorter may not be deleted. Deleting a short chapter may not change the display of the available disc volume.
- Deleting a playlist (➡ page 87) title/chapter does not affect the original title/chapter.
- Deleting an original (➡ page 87) title/chapter affects all the corresponding playlist title/chapters.
- Deleting all chapters in a title erases the title itself.
- Title and chapter which contains still pictures cannot be deleted.
- On a DVD-R/RW disc, deleting is not possible if the disc is finalized (➡ page 132).
- Chapters in a DVD-R/RW disc cannot be deleted.
- On a DVD-RW disc, only a title last recorded can restore the disc capacity by being deleted.
- On a DVD-R disc, deleting cannot restore the disc capacity.

## To protect recorded content

HDD DVD-RAM

You can protect recorded content from unexpected deletion.

Protection is provided for each title (original).

- 1) Perform steps 1 and 2 in “Playing recorded contents (CONTENT MENU)” (➡ page 55) to select a title.
- 2) Press the QUICK MENU button, and press the ▲ / ▼ buttons to select “Title information”. Then press the ENTER button.
- 3) Press the QUICK MENU button, and press the ▲ / ▼ buttons to select “Lock” and then press the ENTER button.  
The mark  appears.

### Notes

- To cancel protection, repeat this procedure.
- Disc initialization erases all titles on a disc even if they are protected.
- Executing “All HDD titles delete” (➡ page 163) erases all titles on the HDD even if they are protected.

## Technical information

### ● About recording time

The recording time of a typical VCR (Video Cassette Recorder) is determined by the length of a video tape and recording speed (SP, LP, etc.). Video tapes with various recording times are available in the market. On the other hand, the recording time of a DVD-RAM/R/RW depends on the bit rate (Mbps: amount of data transmitted per second), which can be varied in MPEG2 (Moving Picture Experts Group2) compression technology.

As an example, when you pour water into a bucket from a faucet, the faster the water flows, the sooner the bucket is filled with water. On the other hand, the slower the water flows, the more slowly the bucket is filled. The DVD-RAM/R/RW is, so to speak, such a bucket, and the degree you turn the faucet is bit rate, the time required to fill the bucket with water is the recording time available for a disc. The higher you set the bit rate (making much more water flow), the sooner a disc is filled. Consequently, the recording time becomes shorter. The lower you set the bit rate, the longer time it takes to fill a disc.

### ● About picture quality (SP, LP, Auto, MN(Manual mode))

The higher you set the bite rate, the more the volume of information for the picture. The lower the bit rate, the less the volume of picture information. However a high bit rate does not always mean that the picture quality is high. The difference between the 1.4 Mbps and 9.2 Mbps is obvious, but when comparing similar bit rates, the difference may be insignificant. Generally when you set the bit rate low for longer recording time, the data volume shortage will result in a lack of detail information. As a result, the picture quality is decreased (more noticeable with dynamically moving images). For example, square noises (block noise) may occur in a scene with fast action or a scene with light and shadows, such as a water surface.

This recorder has a two settings, 2 hour recording at "SP" mode or 4 hour recording at "LP" mode (both assume a blank 4.7 GB DVD-RAM). It is recommended to consider the "SP" mode as a standard mode and use the "LP" mode when you want to record for long time regardless of the picture quality. If you want to record for about 2 hours or are uncertain which one to select, select the "Auto" mode.

On a blank 4.7 GB DVD-RAM disc, the "Auto" mode automatically sets the appropriate bit rate corresponded to the recording time from about 1 hour to up to 2 and a half hours so that you can achieve the best picture quality. If a part of a DVD-RAM disc has already been recorded, the "Auto" mode sets the bit rate suitable for the remaining space on the disc. (The picture quality is determined referring the remaining space just before recording. When the remaining space is scarce in the disc, the picture quality may decrease from what you set beforehand or the recording may stop halfway.) "Auto" mode is available also on DVD-R/RW recordings.

When you want to record a music program or animation with high picture quality, it is recommended that you select the "MN" mode. If you select more than 6 Mbps, you can usually record with considerably higher picture quality. However the higher you set the bit rate, the shorter the recording time.

### ● $\square\square$ D /M1, $\square\square$ D /M2

Sound recording format onto DVD-RAM discs. When recording, sounds are converted into digital signals and compressed. In playback, they are extracted to the original sound. The standard differentiates  $\square\square$  D / M1 and  $\square\square$  D /M2 in data volume to use.  $\square\square$  D /M1 and  $\square\square$  D /M2 are applied the digital recording technology for consumer products of Dolby Laboratories. Dolby Digital 192 kbps is set for  $\square\square$  D / M1 and Dolby Digital 384 kbps for  $\square\square$  D /M2.

### ● L-PCM (Linear PCM)

Sound recording format, like Dolby Digital. However, sounds are converted into digital signals and recorded as they are without compression. This process requires more data than Dolby Digital.



# Playback

Play your favorite contents.

- **Information on playback**
- **Playing recorded contents (CONTENT MENU)**
- **Playing a DVD video disc**
- **Pausing a TV broadcast to resume later**
- **Playing a TV programme currently being recorded**
- **Playing at various speeds**
- **Locating by entering the number**
- **Watching a TV broadcast in the sub window (P in P Playback)**
- **Selecting the camera angle**
- **Selecting Subtitles**
- **Zooming a picture**
- **Selecting the sound**
- **Viewing JPEG files**
- **Playing MP3/WMA Files**
- **Checking the current status and settings**
- **Functions in the Quick Menu**

# Information on playback

The operation procedure depends on the kind of disc. See the respective pages for basic procedure to play the disc.

## ● To play contents recorded onto the HDD or DVD-RAM discs

Playing recorded contents (CONTENT MENU) (➡ page 55)

## ● To play a DVD video disc

Playing a DVD video disc (➡ page 60)

## ● To play a DVD-R/RW disc

DVD-R/RW discs recorded on this recorder

Playing recorded contents (CONTENT MENU) (➡ page 55)

DVD-R/RW discs recorded on other devices

Playing recorded contents (CONTENT MENU) (➡ page 55)

Playing a DVD video disc (➡ page 60)

DVD-R/RW discs recorded in DVD-VR mode

Playing a DVD-RW disc recorded in DVD-VR mode (➡ page 59)

## ■ To switch the drive to play

Press the STOP button to stop playback. Then press the HDD or DVD button to select the drive.

## ■ To switch the picture to view TV broadcasts

Press the STOP button to stop playback.

## ■ To start recording

Press the STOP button to stop playback.

Then press the HDD or DVD button to select a recording media, and press the REC button to start recording.

## ■ Screen Protection

If you pause playback or display a menu and leave it still for about 15 minutes, the recorder switches the output picture source to a TV broadcast or connected equipment.

A still picture may be displayed after all titles are played. In this case, the screen protection activates after about 10 seconds.

## Notes

- Do not move the recorder during playback. It may damage the disc.
- Occasionally the picture may stop at the last scene, or the main menu may appear after playing.  
If you display a still picture such as the main menu on the TV screen for a prolonged period, the TV may be damaged (image burn). To prevent this, press the STOP button to stop playback.
- A still picture for about 15 minutes while the TIMESLIP indicator illuminates, will return to normal playback. If the playback is completed, a still picture of the title end will continue unless you press the TIMESLIP button.

# Playing recorded contents (CONTENT MENU)

Titles and chapters recorded on the HDD or a DVD-RAM/R/W disc are displayed in thumbnail view, so that you can easily locate a desired one.

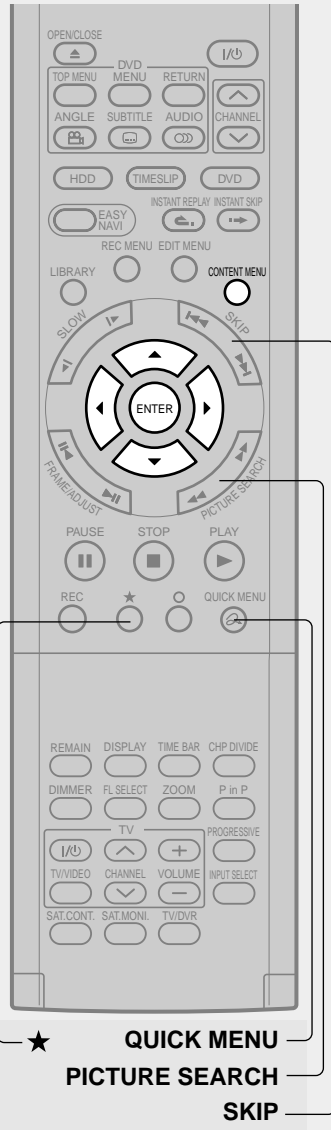

## 1

### During stop or playback, press **CONTENT MENU**.

The "CONTENT MENU Title List" appears.

e.g.

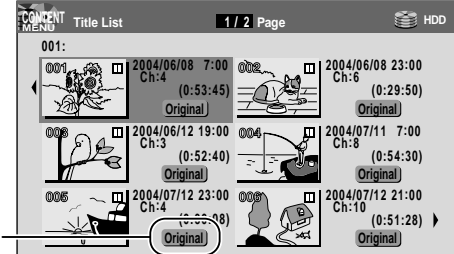

Attribution (original/playlist) → page 87

You can switch between HDD and DVD drives by pressing the HDD or DVD button.

---

## 2

### Press **▲/▼/◀/▶** to select a title (chapter).

You can view succeeding or prior pages by pressing the **PICTURE SEARCH (◀◀/▶▶)** button.

To select a chapter, select a title and press the **★** button.

The Chapter List appears.

By pressing the **★** button again, you can return to the Title List.

---

## 3

### Press **ENTER**.

Playback starts from a selected title (chapter).

**Notes**

- In a CONTENT MENU, titles (Original) precede titles (Playlist), in order from the oldest one respectively.
- To turn off the CONTENT MENU, press the CONTENT MENU button. Absence of operations for longer than about 15 minutes also turns off the CONTENT MENU.
- The mark **||** is displayed in every thumbnail when "HDD/RAM title play" (→ page 160) is set to "Title resume". When set to "Serial playback", it is displayed in a thumbnail last operated.
- You can change a thumbnail picture. See → page 100.
- You cannot display the CONTENT MENU for DVD-R/RW discs recorded on other devices.
- For playing a recorded title while recording another, see → page 36.
- A black thumbnail with "Recording" means that the title is being recorded or its recording will start within 15 seconds. This thumbnail cannot start playback.

#### ■ To stop playback

Press **STOP**.



#### ■ To pause playback (still playback)

Press **PAUSE**.



To resume normal playback, press the **PLAY** button or the **PAUSE** button.

#### Note

- Sound is muted during still mode.

#### ■ Resuming playback from the location last stopped (Title resume)

The recorder memorizes the location you last stopped playback to resume there.

To use this function, set "HDD/RAM title play" (➡ page 160) to "**Title resume**." The recorder will memorize the location you last stopped at in each title, so you can resume playback there. For example, if there are 6 titles, you can start each of them as if you had stored 6 video tapes in the recorder.

- **To return to the beginning of the title**  
During playback, press the **QUICK MENU** button, then press the **▲ / ▼** buttons to select "Restart title," then press the **ENTER** button.
- **To play another title**  
Press the **CONTENT MENU** button to display "CONTENT MENU Title List," then select a title.

You can make the recorder memorize only the very last point, regardless of the number of titles. Set "HDD/RAM title play" (➡ page 160) to "**Serial playback**."

- **To return to the beginning of the title**  
Press the **SKIP (I◀◀)** button repeatedly until the beginning of the title appears.
- **To play the other title**  
Press the **SKIP (I◀◀ / ▶▶I)** button repeatedly.

#### Notes

- Depending on the status or the contents, playback may not start from the location last stopped, but instead another location. For example, from the beginning of the disc or title.
- Depending on the disc, there may be a slight difference between the location the recorder memorized and the actual location where playback starts.
- This function is not available on DVD-R/RW discs.
- The resuming function will not work if the write-protect tab is set to "PROTECT" (➡ page 8).

#### ■ Playing the digest (Skip search)

This feature repeats playback of about 5 seconds and skip of 1 minute from the beginning to the end of a recorded title, so that you can view the digest of it.

- 1) **Perform steps 1 and 2 on ➡ page 55, and select a title that you want to view the digest.**
- 2) **Press QUICK MENU.**  
The Quick Menu is displayed.
- 3) **Press ▲ / ▼ to select "Special playback mode", then press ENTER.**
- 4) **Press ▲ / ▼ to select "Skip search", then press ENTER.**  
The Skip Search starts.

#### Notes

- This feature can be used only one title (original) recorded on the HDD or a DVD-RAM disc.
- While using this feature, you cannot use speed-related functions such as fast forward or fast reverse.
- If you press the **ENTER** button while using this feature, the normal playback starts.
- To cancel this feature, press the **STOP** button twice.



### ■ Viewing the first scenes of titles (Original) (Intro scan)

- 1) After step 1 on  page 55, press **QUICK MENU**.  
The Quick Menu appears.
- 2) Press **▲ / ▼** to select “Special playback mode”, then press **ENTER**.
- 3) Press **▲ / ▼** to select “Intro scan”, then press **ENTER**.

The recorder plays the first 5 seconds of each title beginning from title 1.

You can go forward or back by pressing the **SKIP** buttons.

**▶▶** : to go to the next title.

**◀◀** : to go back to the current title.

Press twice to go back to the previous title.

- 4) When you find a desired title, press **ENTER**.  
The selected title is played.

#### Notes

- To stop Intro Scan, press the **STOP** button twice.
- This feature can be used only titles (Original) recorded on the HDD or a DVD-RAM disc.

### ■ Playing all titles (Original/Playlist) in a disc

Set “HDD/RAM title play” ( page 160) to “Serial playback”. You can play all titles in the HDD and DVD-RAM disc in the order of the thumbnails on the **CONTENT MENU**, as if they were recorded in one video tape.

### ■ Playing all titles (Original) in a disc (Play All ORG Titles)

You can play all Original titles in the HDD or a DVD-RAM disc in the order of the thumbnails on the **CONTENT MENU**, as if they were recorded in one video tape.

- 1) During stop, press **QUICK MENU**.  
The Quick Menu appears.
- 2) Press **▲ / ▼** to select “Special playback mode”, then press **ENTER**.

e.g.

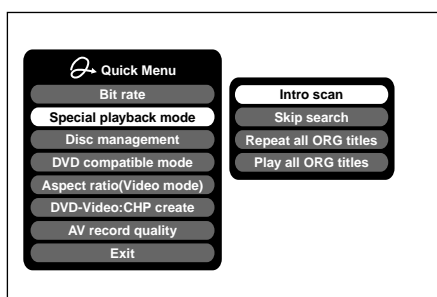

- 3) Press **▲ / ▼** to select “Play all ORG titles”, then press **ENTER**.

e.g.

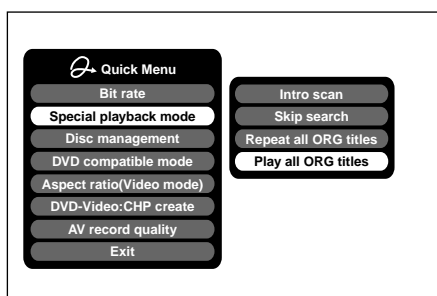

Playback starts from the beginning of title 1.

#### Notes

- To stop “Play all ORG titles”, press the **STOP** button twice. (However, doing this when you are playing a title recorded in the HDD or a DVD-RAM disc while recording ( page 36) will stop the recording.)  
Alternatively, press the **QUICK MENU** button to display the quick menu, and press the **▲ / ▼** buttons to select “Cancel play all ORG titles” and press the **ENTER** button.
- When the last title is complete, All ORG Title Play stops.
- If you select “Repeat all ORG titles” at step 3), “Play all ORG titles” repeats.
- This function is available only for titles recorded on the HDD or DVD-RAM discs.

■ **Checking the background information on a selected title**



1) At step 2 on  page 55, select a title (chapter) then press **QUICK MENU**.

The Quick Menu appears.

2) Press **▲ / ▼** to select “Title information”, then press **ENTER**.

Detailed information of a selected title (chapter) appears. You can switch the chapters in the title by pressing the **PICTURE SEARCH (◀◀ / ▶▶)** buttons.

**Notes**

- From the Quick Menu on the “CONTENT MENU Title Information”, you can change the details such as name, genre or time, which will help sorting and searching on Library system ( page 140). Also you can protect the title from unexpected erasure ( page 50).
- To return to the previous display, press the **O** button.
- To cancel the procedure, press the **CONTENT MENU** button.

■ **Changing the order of the titles**

You can change the order or sort the titles by genre.

1) Press **CONTENT MENU**.

The CONTENT MENU appears.

2) Press **QUICK MENU**.

The Quick Menu appears.

3) Press **▲ / ▼** to select “Display changeover”, then press **ENTER**.

e.g.

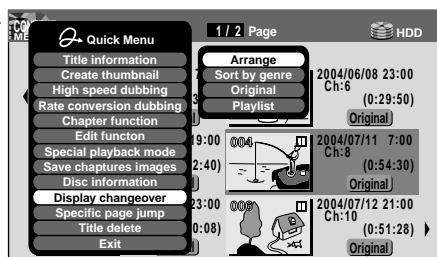

4) Press **▲ / ▼** to select the item, then press **ENTER**.

- **Arrange**  
The titles are rearranged along with the selected order.  
Press the **▲ / ▼** buttons to select the order, then press the **ENTER** button.
- **Sort by genre**  
Titles of the selected genre are sorted.  
Press the **▲ / ▼** buttons to select the genre, then press the **ENTER** button.
- **Original**  
Titles (Original) are sorted.
- **Playlist**  
Titles (Playlist) are sorted.

**Note**

- The recorder holds your selection until the power is turned off. To cancel, select “Display changeover” then “Cancel Arrange/Narrowing” from the Quick Menu.

## ■ Jumping to a specified page

### 1) Press CONTENT MENU.

The CONTENT MENU appears.

### 2) Press QUICK MENU.

The Quick Menu appears.

### 3) Press ▲ / ▼ to select “Specific page jump”, then press ENTER.

### 4) Enter the page number you want by pressing ADJUST, ▲ / ▼ or the number buttons.

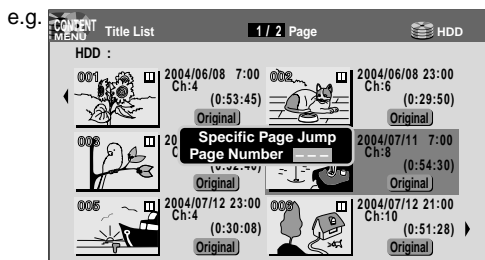

To clear the number, press the CLEAR button.

### 5) Press ENTER.

The specified page appears.

## ■ Playing a DVD-RW disc recorded in DVD-VR mode

See ➡ page 55.

### Notes

- Some disc's conditions or discs which contain copy once contents may not permit proper playback.
- “Title resume” (➡ page 160) is not available.

# Playing a DVD video disc

You can also play VIDEO CDs, audio CDs or finalization processed DVD-R/RW discs in the same manner. To play recorded contents, follow the instructions on  page 55.

## ■ Preparation

- Turn on a TV or audio system and select the corresponding input source that the recorder is connected to.
- Load a disc you want to play. ( page 20)

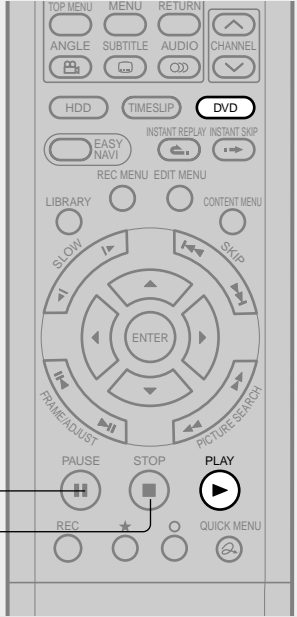

**STOP PAUSE**

### 1 Press DVD.

The DVD indicator on the front panel illuminates. This status indicates that the recorder is ready to play a disc in the disc tray (DVD mode).

---

### 2 Press PLAY.

Playback starts.

- Depending on the disc, playback starts automatically by loading the disc.
- The recorder may take a short time to start playback. This occurs because the recorder is reading the data of a disc.

## ■ To stop playback

Press STOP.



## ■ To pause playback (still playback)

Press PAUSE.



To resume normal playback, press the PLAY button or the PAUSE button.

### Note

- Sound is muted during still mode.

### Note

- DVD video disc provides high resolution pictures and a lot of information. Because of this, you may notice some fine picture noises on TV screen, which you have never seen with regular broadcast TV programme. While the amount of noise depends on the TV you use with the recorder, you should generally reduce the sharpness adjustment on your TV when viewing DVD video discs.

## ■ Resuming playback from the location last stopped (Resume Play)

DVD-RW | DVD-R | DVD-VIDEO | VCD | CD

You can resume playback from the location where you stopped.

If you press the PLAY button after stopping playback, playback resumes from the location you have stopped.

If you stop playback by pressing the STOP button twice, the resume playback feature will be cancelled.

### Notes

- Resume feature cannot function when:
  - you select a disc menu language (➡ page 154) or change the parental lock setting (➡ page 155).
  - you play a PBC-featured VIDEO CD while “PBC” (➡ page 156) is set to “On”.
  - you open the disc tray.
  - you cancel the DVD-Video finalizing process of a DVD-RW disc.
- There may be a difference in the location where playback resumes depending on the disc.
- While the recorder retains a location in memory, initial setting changes with GUI may function only after the memory is cleared.

## Locating a title using the top menu

DVD-RW | DVD-R | DVD-VIDEO

Some DVD video discs may include a top menu, on which you can view the structure of contents or select a scene. Most of the top menus automatically appear in certain scenes, and also are displayed on demand. Actual operation of the top menu depends on the disc. This section explains a general example of how to operate a top menu. Also refer to the instructions of the disc itself.

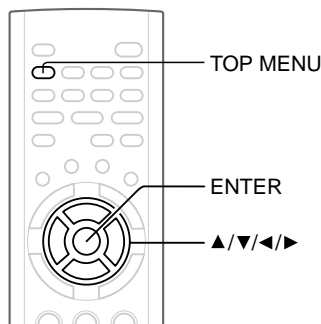

- 1) Press TOP MENU.
- 2) Press ▲ / ▼ / ◀ / ▶ to select the title you want.  
If the titles in the top menu are assigned a number, you can directly locate a specific title by pressing its designated number with the number buttons.
- 3) Press ENTER.

### Notes

- The instructions above describe basic procedures which may vary depending on the contents of the DVD video disc. If different instructions appear on the TV screen, follow those instructions.
- If you display the top menu during playback and press the TOP MENU button again without selecting any title, the recorder may resume playback from the point where you first pressed the TOP MENU button. (depending on the actual DVD video disc.)
- This method of locating a title is available only on a disc that contains a top menu.
- Instruction notes of discs may refer to the button that displays the top menu as the TITLE button.

# Pausing a TV broadcast to resume later

This function enables you to pause a TV broadcast and resume viewing at a later, more convenient time, by storing the TV broadcast temporarily on the HDD.

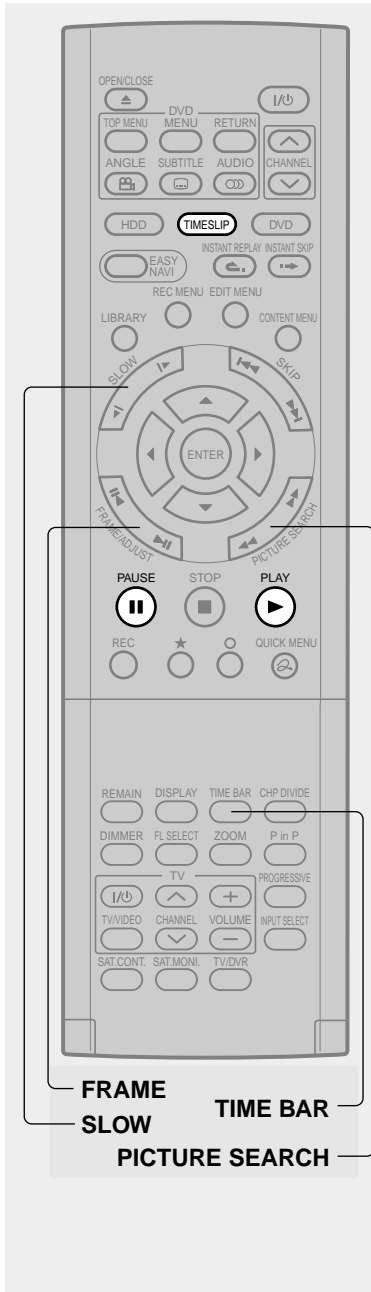

## 1 While viewing a TV broadcast via this recorder or immediately before it starts, press **TIMESLIP**.

TIMESLIP

The current picture pauses.

The recorder begins to store the broadcast on the HDD the moment you press the TIMESLIP button.

## 2 Resume playback by pressing **PAUSE** or **PLAY**.

PAUSE



PLAY



- You can confirm how far you are from the current broadcast by pressing the TIME BAR button.
- Playback may not resume immediately after you press the PLAY or PAUSE button.

## 3 Locate a scene you want by the following methods.

### Fast-forward/fast-reverse:

Press the PICTURE SEARCH button.

### Forward/reverse slow-motion:

Press the SLOW button.

### Forward/reverse frame by frame play:

First press the PAUSE button then press the FRAME button.

- To resume normal playback, press the PLAY button.
- You can play in fast-forward to within 10 seconds prior to the current broadcast.

## 4 Press **TIMESLIP** to exit this mode.

TIMESLIP

The recorder stops storing the broadcast on the HDD.

A message appears and asks you whether you will save the stored data or erase it.

Press the ◀/▶ buttons to select, then press the ENTER button.

### Notes

- This function is not available during recording.
- Pause TV recording stops when the HDD is filled up. It will not begin if the HDD is full.
- While using this pause TV recording, you cannot program a recording.
- Playback may jump a few seconds back or pause depending on the disc or data condition.

# Playing a TV programme currently being recorded

You can begin playback from the beginning of a programme currently being recorded. You will find this function of great advantage on long programmes, as you do not have to wait for the end of recording to begin playback.

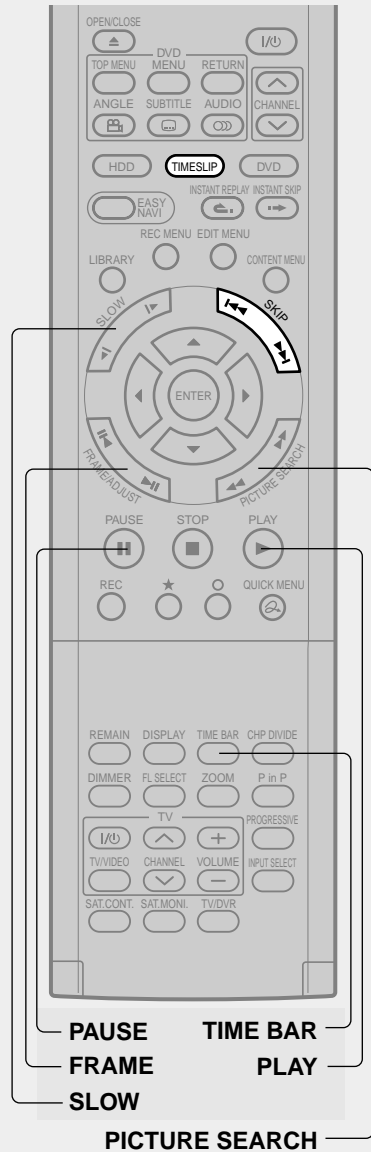

## 1 While recording a TV programme on the HDD or a DVD-RAM disc, press **TIMESLIP**.



The recorder displays a TV program as it is being recorded.

## 2 Go back to the beginning of the TV program using **SKIP**.



When you go back to the beginning, playback starts automatically.

You can confirm how far you are from the current broadcast by pressing the **TIME BAR** button.

## 3 Locate a scene you want through the following operations if necessary.

### **Fast-forward/fast-reverse:**

Press the **PICTURE SEARCH** button.

### **Forward/reverse slow-motion:**

Press the **SLOW** buttons.

### **Forward/reverse frame by frame play:**

First press the **PAUSE** button then press the **FRAME** button.

- To resume normal playback, press the **PLAY** button.
- You can play in fast-forward to within 10 seconds prior to the current broadcast.

## 4 Press **TIMESLIP** to exit.



The current broadcast returns.

### Notes

- Time slip recording/playback stops when the disc is filled up. You can play up to a location where the recorder stopped the recording. The time slip recording/playback cannot begin if the disc is full.
- The playback picture may appear after a delay of several seconds.
- The playback location will never be identical to the record location in the programme. It will always trail the record location by a few seconds.
- While using time slip recording/playback, you cannot program a recording.
- While the **TIMESLIP** indicator is on, you cannot change the setting of the feature that turns off the recorder after a programmed operation has finished.
- Even while "Auto power off" is selected, the recorder does not turn off if the recording end time comes during playback of a programme being recorded.
- This function is not available on a DVD-RAM disc while the A-B recording is executing or when "Relay recording" is set to "On."
- Playback may jump a few seconds back or pause depending on the disc or data condition.

# Playing at various speeds

## Playing in fast reverse or fast forward

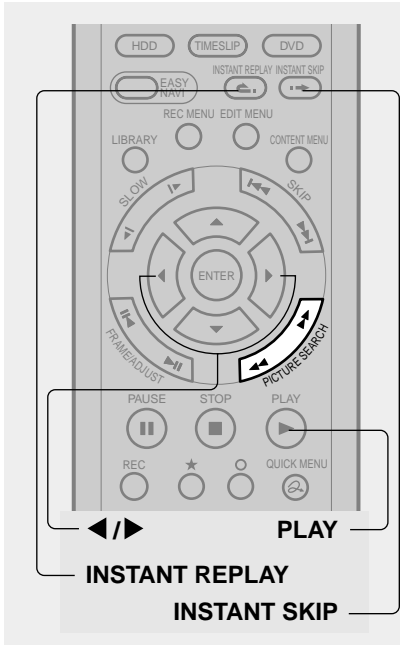

### 1 During normal playback, press PICTURE SEARCH.

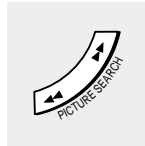

- ▶▶ : Fast forward playback
- ◀◀ : Fast reverse playback

Each time you press the button, the playback speed changes.  
 During fast forward playback at “▶▶” speed, sound is reproduced. (Not available on VIDEO CD.)

- This function is not available when you play a title recorded on a DVD-RAM disc while recording another.

#### Notes

- The playback speed may vary depending on the disc.
- Depending on the disc or data condition, picture and sound in fast forward playback at “▶▶” speed may be disturbed.

#### ■ To resume normal playback

Press **PLAY**.

#### ■ To skip the contents in pre-determined increments

During playback, press **INSTANT SKIP**.

Each time you press the button, you can skip by the specified time.

You can select the interval per press of the button.

See “Instant skip interval” (➡ page 160).

#### ■ To skip by 1/20 of whole

During playback, press **◀/▶**.

Each time you press the button, you can skip by 1/20 of the current title or track if it is longer than 1 minute.

#### ■ Time bar display

Fast-forward or fast-reverse playback automatically displays a time bar.

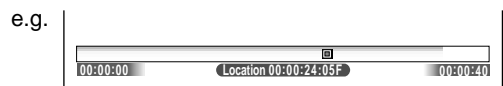

For details, see ➡ page 81.

#### ■ To skip back in pre-determined increments

During playback, press **INSTANT REPLAY**.

Each time you press the button, you can go back by the specified time to resume playback.

You can select the interval per press of the button.

See “Instant replay interval” (➡ page 160).

#### Notes

- Some discs may not permit this operation.
- Depending on disc structure, some operations may be limited.
- Depending on playback status, some operations may not work.



## Skipping to the next/previous chapter or track

HDD DVD-RAM DVD-RW DVD-R DVD-VIDEO VCD CD

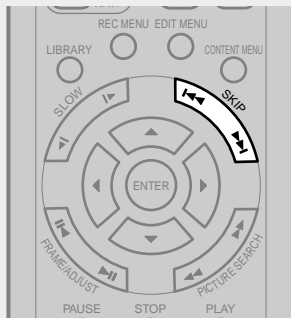

### 1 Press SKIP (◀◀/▶▶) repeatedly until the chapter or track number you want appears.



Playback starts from the selected chapter or track.

▶▶ : Playback starts from the beginning of the next chapter or track.

◀◀ : Playback starts from the beginning of the current chapter or track.

When you press twice, playback starts from the beginning of the previous chapter or track.

#### Notes

- Some titles may not display chapter numbers.
- When playing the HDD or a DVD-RAM disc, you can access chapters only in the current title if “HDD/RAM title play” (▶ page 160) is set to “Title resume”. To access chapters in other titles, set to “Serial playback”.
- When playing a DVD video disc or a DVD-R/RW disc, you can locate chapters only in the current title if “DVD title stop” (▶ page 156) is set to “On”. To access chapters in other titles, set to “Off”. However, in this instance even though you press the SKIP button (◀◀) to go back to the previous title, playback starts not from the last chapter of the title but from the first chapter.

## Playing in slow-motion

HDD DVD-RAM DVD-RW DVD-R DVD-VIDEO VCD

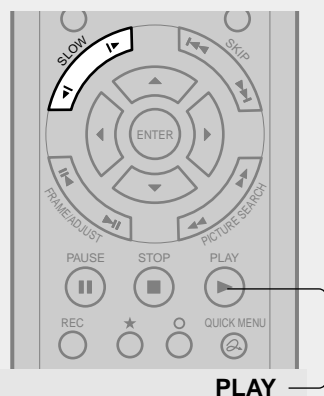

### 1 Press SLOW during playback.



▶ : Forward slow-motion

◀ : Reverse slow-motion

Each time you press the SLOW button, the slow-motion speed changes.

#### Notes

- Slow-motion does not provide smooth playback.
- When playing a VIDEO CD, reverse slow-motion playback is not available.
- The speed level displayed is approximate.

#### ■ To resume normal playback

Press PLAY.

Playing frame by frame

HDD DVD-RAM DVD-RW DVD-R DVD-VIDEO VCD

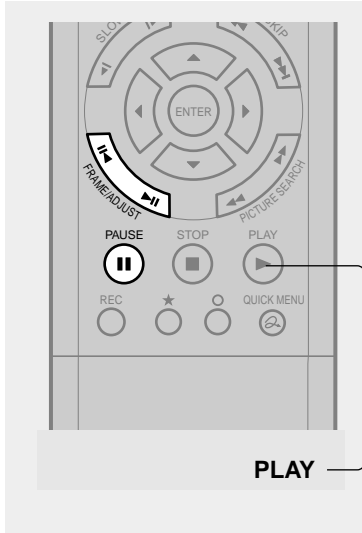

1 During playback, press PAUSE.



A still picture is displayed.

2 Press FRAME (◀▶/▶▶).



▶▶ : Playback direction  
 ◀▶ : Opposite direction

■ To resume normal playback

Press PLAY or PAUSE.

Notes

- Sound is muted during frame by frame playback.
- Frame by frame playback cannot provide smooth playback.
- Picture may advance more than 1 frame at a time.
- Depending on the scene, some frames may not be played.
- When playing a VIDEO CD, reverse frame by frame playback is not available.

Viewing still pictures (Playing a disc that contains still pictures)

DVD-RAM DVD-VIDEO



1 Press PLAY.



The first still picture on a disc is displayed.

Some DVD video discs may allow you to change the pictures using the PLAY, ENTER or SKIP button.

2 Press FRAME (◀▶/▶▶).



▶▶ : Displays the next still picture.  
 ◀▶ : Displays the previous still picture.

# Locating by entering the number

## Locating by entering the number of a desired section

Normally titles, chapters, and tracks are numbered. By entering these numbers, you can access a desired section.



Open the lid.

CLEAR

### 1 Press T.SEARCH.



If you are using a VIDEO CD/audio CD, skip step 2.  
e.g.



### 2 Press ▲ / ▼ to select a section (title or chapter) you want to locate.

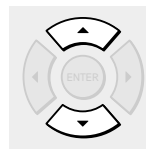

e.g. When you want to locate a chapter.



### 3 Press the number buttons to enter a number of the section.

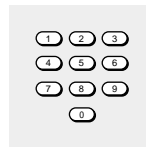

e.g. To enter 25, press "2", then press "5".

### 4 Press ENTER.

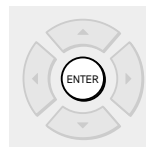

Playback starts from the selected location.

#### Notes

- Pressing the CLEAR button resets the numbers. To clear the display, press the T.SEARCH button several times (depending on the disc).
- This method of locating a title is available only on a disc that contains title numbers.
- If a title is erased, the numbers of the following titles decrease respectively.
- When you record a new title (Original) on the HDD or a DVD-RAM disc, it is added prior to current titles (Playlist), and each following title (Playlist) reference number will advance by a factor of 1.

**Locating a specific point by entering its elapsed time (Time Search)**



Open the lid.

CLEAR

**1 Press T.SEARCH.**



You may have to press repeatedly, depending on the disc. Press the button until the following display appears.

e.g.



**2 Press the number buttons and ◀/▶ to enter the desired time location on the disc.**

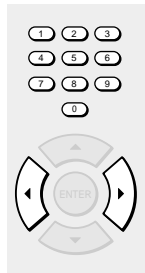

e.g. To enter 1 hour, 25 minutes, and 30 seconds

“0” → “1” → ▶ → “2” → “5” → ▶ → “3” → “0”  
hour                      minute                      second

**3 Press ENTER.**



Playback starts from the selected location.

**Notes**

- Some discs may not respond to this process.
- Some scenes may not be accessed precisely as you specified.
- This method for accessing specific locations is available only within the current title of the HDD or a DVD-RAM/R/RW/DVD video disc or within a current track of a VIDEO CD/audio CD.
- Pressing the CLEAR button resets the numbers.

# Watching a TV broadcast in the sub window (P in P Playback)

During playback, you can watch a TV broadcast in the sub window. (P in P : Picture in Picture)



**CHANNEL**

## 1 During playback, press P in P.



A sub window (programme on the air or on the recording) appears.

e.g.

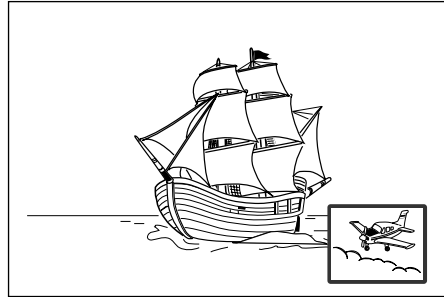

## 2 Press ▲ / ▼ / ◀ / ▶ to select the position of the sub window.

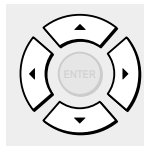

You can shift the sub window in following 4 directions.

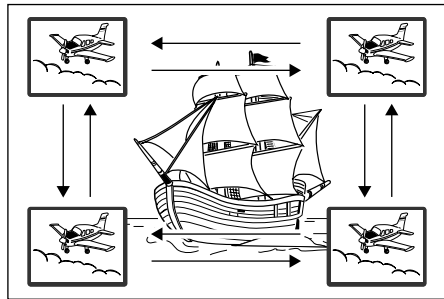

↑ / ↓ / ← / → is the moving range.

To turn off the sub window, press the P in P button.

### Notes

- You can change the channel of the sub window by pressing the CHANNEL  $\vee / \wedge$  button.
- The P in P function is available only during playback.
- You cannot swap the playback picture with the picture within the sub window, or change the audio settings.
- Press the P in P button during "Chase Play" or "Pause TV", the actual broadcast appears on the sub window in real time.
- If this function is stopped after shifting the sub window, before you press the P in P button again, the sub window will appear in the last position you set. However, if you turn off the power, the sub window re-appears in the lower right (default) position.

# Selecting the camera angle

If the scene was recorded with multiple angles, you can easily change the camera angle of the scene you are watching.



## 1 Press ANGLE while playing a scene recorded with multiple angles.

ANGLE  

While playing a scene recorded with multiple angles, the angle icon appears on the TV screen and on the front panel. Press the ANGLE button while the angle icon is displayed.

e.g.

Angle  
1 / 6



↑

Total number of angles

↓

Current selection

---

## 2 Press ADJUST while the angle number is displayed on the TV screen.



You can also select the camera angle by pressing the ANGLE button several times.

↓

Angle  
2 / 6

↓

↓

Angle  
3 / 6

↓

⋮

↓

↓

Angle  
6 / 6

↶

• The angle icon disappears after about 3 seconds if no further selections are made.

**Notes**

- You can also change the camera angle during still playback. The camera angle changes to the new setting when you resume normal playback.
- If you pause a picture immediately after changing a camera angle, the resumed playback picture may not display the new camera angle.
- Depending on the disc, the camera angle may not change even though the angle number changes.

**■ To turn off the angle icon**

Set "On screen display" in the setup menu to "Off" (➡ page 159).  
 Most of the on-screen display including the angle icon will not appear.  
 While the angle icon is flashing on the front panel display, you can change the camera angle.

# Selecting Subtitles

You can display subtitles on the TV screen and select a subtitle language from those included on the disc.



## 1 Press SUBTITLE during playback.

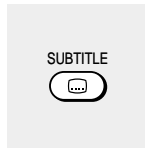

The current subtitle setting appears.

e.g. 

Subtitle	1	--
Status	Off	

 — Setting number and language

The language code appears instead of the language name. Refer to the list of languages and their abbreviations. (➡ page 171)

## 2 Press ▼ to select "Status," then press ADJUST to select "On."

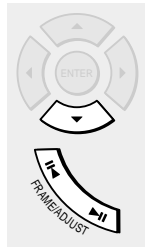

Skip to step 3 if "On" is already displayed.

## 3 Press ▲ to select "Subtitle," then press ADJUST to select a language.

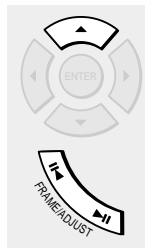

The subtitles of recorded languages appear.



The display turns off after about 3 seconds if you do not make a selection.

### Notes

- Some DVD video discs are set to display subtitles automatically.
- Depending on the scene, subtitles may not appear immediately after you set the subtitle function to on.
- Some DVD video discs will allow you to change subtitle languages and turn subtitles on or off only via the disc menu.

### ■ To turn the subtitles on or off

At step 2, select "Off" by pressing the ADJUST button.

# Zooming a picture

You can magnify areas within a picture.

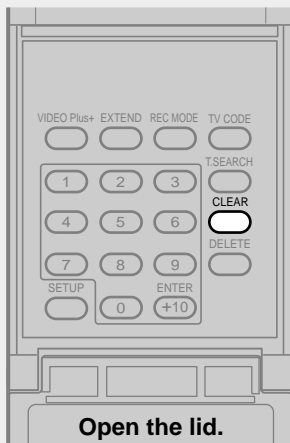

## 1 Press ZOOM.

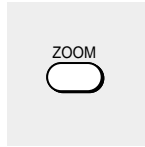

A zoom scope appears.

e.g.

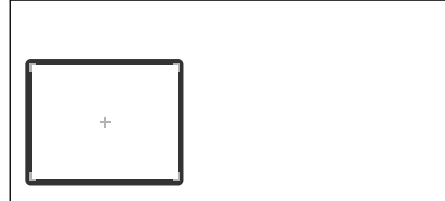

## 2 Select a zoom point and magnification level.

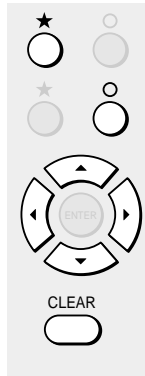

★ :  
Raises the magnification level.

○★ :  
Lowers the magnification level.

▲/▼/◀/▶ :  
Moves the zoom point. (only after the image has been magnified)

CLEAR :  
Returns the zoom point to the center of the picture.

### Notes

- Some discs may not respond to zoom feature.
- During some scenes, the buttons may not work as described.
- The zoom feature is canceled when the disc menu is operated.
- The magnification level varies depending on the picture size you select (➡ page 50, in "INSTALLATION GUIDE").
- The zoom feature is not available while displaying a GUI.
- The zoom feature is canceled when you stop playback or start playback.

### ■ To cancel the zoom

Press ZOOM.



# Selecting the sound

You can select a preferred language and a sound format.

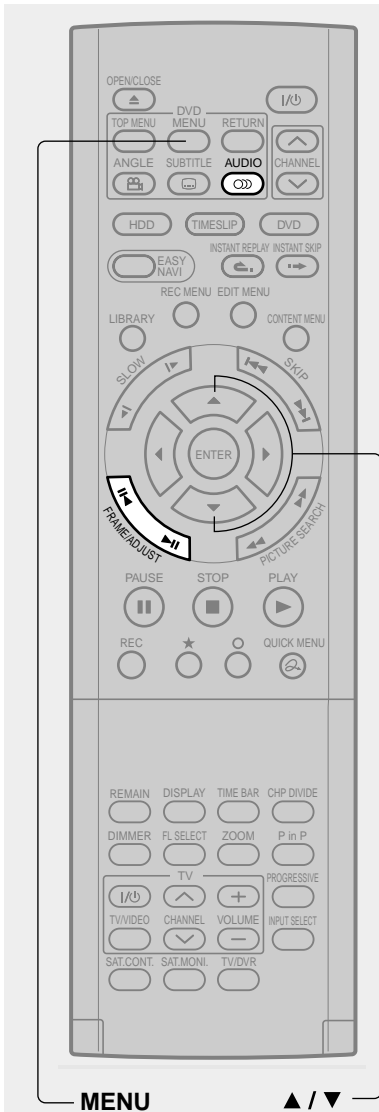

## 1 Press AUDIO during playback or while receiving a broadcast.



The current audio setting appears.

The language code appears instead of the language name. Refer to the list of languages and their abbreviations. (➡ page 171)

## 2 Press ADJUST while the audio setting is displayed on the TV screen.



Variation of channels depends on the disc or the type of TV broadcast.

- **HDD** **DVD-RAM**, TV channel signals

**Stereo sound**  
 → “Stereo” (left channel and right channel)  
 → “Stereo L” (left channel)  
 → “Stereo R” (right channel)  
 (→ Back to “Stereo”)

### Dual Mono sound (NICAM)

“Dual L” → “Dual R” → “Dual LR” (→ Back to “Dual L”)

- **DVD-RW** **DVD-R** **DVD-VIDEO**

Language name / sound recording system / No. of channels

e.g.

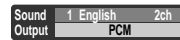

- **VCD**

“Stereo” → “Stereo L” → “Stereo R” (→ Back to “Stereo”)

The display turns off if you do not operate for more than 3 seconds.

If you press the ▲ / ▼ buttons to select “Output,” you can select the audio output setting (➡ page 158) by using the ADJUST button.

Selecting the sound (Continued)

**Recorded sounds**

According to your setting of "NICAM" on the setup menu screen, (▶ page 158), the sound is recorded onto different channels of the disc below. Set "NICAM" to "On" or "Off" appropriately.

Setting on the setup screen		Type of receiving broadcast	Contents of recorded sound		Type of record
DVD Compatible Mode	NICAM		Lch	Rch	
Off	Off	Mono + NICAM L, R	Mono	Mono	Stereo
		Mono + NICAM M1, M2	Mono	Mono	Stereo
		Mono + NICAM M1	Mono	Mono	Stereo
		Mono	Mono	Mono	Stereo
	On	Mono + NICAM L, R	L	R	Stereo
		Mono + NICAM M1, M2	M1	M2	Dual Mono*
		Mono + NICAM M1	M1	M1	Stereo
On (Mode I)	Off	Mono + NICAM L, R	Mono	Mono	Stereo
		Mono + NICAM M1, M2	Mono	Mono	Stereo
		Mono + NICAM M1	Mono	Mono	Stereo
		Mono	Mono	Mono	Stereo
	On	Mono + NICAM L, R	L	R	Stereo
		Mono + NICAM M1, M2	M1	M1	Stereo
		Mono + NICAM M1	M1	M1	Stereo
On (Mode II)	Off	Mono + NICAM L, R	Mono	Mono	Stereo
		Mono + NICAM M1, M2	Mono	Mono	Stereo
		Mono + NICAM M1	Mono	Mono	Stereo
		Mono	Mono	Mono	Stereo
	On	Mono + NICAM L, R	L	R	Stereo
		Mono + NICAM M1, M2	M2	M2	Stereo
		Mono + NICAM M1	M1	M1	Stereo
		Mono	Mono	Stereo	

\* This will be "Stereo" when a recording is made with "L-PCM" selected.

### Notes

- Some discs allow you to change audio selections only via the disc menu. If this is the case, press the MENU button and choose the appropriate language from the selections on the disc menu.
- When you turn on the recorder or replace a disc, the recorder returns to the initial default setting. (➡ page 154)  
Depending on the disc, the sound that is specified the disc is played back.
- Immediately after you have switched sounds, there may be a temporary discrepancy between the display and actual sound.
- The BITSTREAM/PCM jack may not output NICAM Mode I/II sound you select. In this instance, set "Audio out select" to "PCM".  
(➡ page 158)
- You cannot change NICAM sound if recorded with "DVD compatible mode" (➡ page 162) set to "On". Even when "DVD compatible mode" (➡ page 162) is set to "Off," the recorder regards it as "On (Mode I)" when recording to a DVD-R/RW disc.

### ■ Output sound conversion table

Disc	Sound format	Audio setting (➡ page 158) and output in the default setting display					
		Bitstream		Analog 2ch		PCM	
		BITSTREAM/ PCM jack	Analog (L/R) jacks	BITSTREAM/ PCM jack	Analog (L/R) jacks	BITSTREAM/ PCM jack	Analog (L/R) jacks
DVD-video disc*	Dolby Digital	Bitstream	48 kHz/20 bit	Bitstream	48 kHz/20 bit	48 kHz/16 bit	48 kHz/20 bit
	Linear PCM	48 kHz/16 bit	48 kHz/16 bit	48 kHz/16 bit	48 kHz/16 bit	48 kHz/16 bit	48 kHz/16 bit
		48 kHz/20 bit	48 kHz/16 bit	48 kHz/20 bit	48 kHz/16 bit	48 kHz/20 bit	48 kHz/16 bit
		48 kHz/24 bit	48 kHz/16 bit	48 kHz/24 bit	48 kHz/16 bit	48 kHz/24 bit	48 kHz/16 bit
		96 kHz/16 bit	48 kHz/16 bit	48 kHz/16 bit	—	96 kHz/16 bit	48 kHz/16 bit
		96 kHz/20 bit	48 kHz/16 bit	48 kHz/20 bit	—	96 kHz/20 bit	48 kHz/16 bit
	96 kHz/24 bit	48 kHz/16 bit	48 kHz/24 bit	—	96 kHz/24 bit	48 kHz/16 bit	
DTS	Bitstream	—	Bitstream	—	—	—	
MPEG2	Bitstream	48 kHz/16 bit	Bitstream	48 kHz/16 bit	48 kHz/16 bit	48 kHz/16 bit	
VIDEO CD	MPEG1	44.1 kHz/16 bit	44.1 kHz/16 bit	44.1 kHz/16 bit	44.1 kHz/16 bit	44.1 kHz/16 bit	44.1 kHz/16 bit
Audio CD	Linear PCM 44.1 kHz/16 bit	44.1 kHz/16 bit	44.1 kHz/16 bit	44.1 kHz/16 bit	44.1 kHz/16 bit	44.1 kHz/16 bit	44.1 kHz/16 bit
	DTS	Bitstream	(Noise)	Bitstream	(Noise)	Bitstream	(Noise)
HDD	Dolby Digital	Bitstream	48 kHz/20 bit	Bitstream	48 kHz/20 bit	48 kHz/16 bit	48 kHz/20 bit
	Linear PCM 48 kHz/16 bit	48 kHz/16 bit	48 kHz/16 bit	48 kHz/16 bit	48 kHz/16 bit	48 kHz/16 bit	48 kHz/16 bit
DVD-RAM/ R/RW	Dolby Digital	Bitstream	48 kHz/20 bit	Bitstream	48 kHz/20 bit	48 kHz/16 bit	48 kHz/20 bit
	Linear PCM 48 kHz/16 bit	48 kHz/16 bit	48 kHz/16 bit	48 kHz/16 bit	48 kHz/16 bit	48 kHz/16 bit	48 kHz/16 bit
	MPEG2	Bitstream	48 kHz/16 bit	Bitstream	48 kHz/16 bit	48 kHz/16 bit	48 kHz/16 bit
CD-R/RW	MP3/WMA	44.1 kHz or 32 kHz or 48 kHz / 16 bit					

\* "DVD video disc" above does not include DVD-R/RW discs recorded on this recorder.

- Do not select a connection or setting indicated as "Noise" in the above list.

Manufactured under license from Dolby Laboratories. "Dolby" and the double-D symbol are trademarks of Dolby Laboratories.

# Viewing JPEG files

You can play JPEG files that have been recorded on a CD-R or CD-ROM on the recorder.

## ■ Preparations

- Prepare a compatible disc (➡ page 77) that contains JPEG files you want to view.
- Set "Priority contents" (➡ page 160) to "Photo".
- Make your TV shape conform to the 4:3 picture size. Only 4:3 pictures can be played regardless of the function settings via the on-screen displays of the recorder (➡ page 50, "INSTALLATION GUIDE"). If the TV is adjusted to other sizes, e.g. "WIDE," images will appear to be horizontally expanded. For details, refer to the owner's manual of your TV.

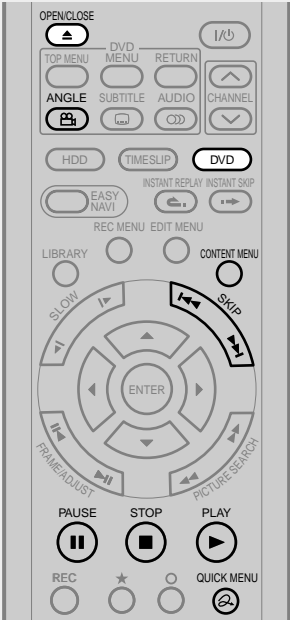

**1 Press DVD.**

DVD

---

**2 Load a CD that contains JPEG files.**

OPEN/CLOSE

Each photo appears for about 3 seconds (slide show).  
If a slide show does not start, press the PLAY button.

Depending on the disc, the "CONTENT MENU Picture List" appears. See "On the "CONTENT MENU Picture List"" (➡ page 77) to operate.

## Notes

- Some files may not display their own entire images depending on the size.
- JPEG picture playback is not available during recording on the HDD.
- Operation to JPEG file will be disabled at about 5 minutes before a programmed recording starts.

## ■ To stop playback (slide show)

### Press STOP.

If you press the PLAY button after pressing the STOP button, playback will start from the photo you stopped.

## ■ To pause playback (slide show)

### Press PAUSE.

To resume, press the PAUSE button again or press the PLAY button.

## ■ To skip photos

During playback, press the SKIP button repeatedly.

▶▶: To skip forward.

◀◀: To skip backward.

## ■ To rotate a picture

### Press ANGLE repeatedly.

Each time you press the button, the picture rotates by 90° degree.

## Notes

- The rotated image is displayed after its original posture appears momentarily.

## ■ To magnify a picture

Follow the procedure on ➡ page 72.

## Notes

- The magnified image is displayed after its original posture appears momentarily.
- For small pictures, the reduction level may be limited.

## ■ Viewing a specified photo (single view)

Full screen still view.  
2 ways are available:

### ● On the “CONTENT MENU Picture List”

#### 1) Press CONTENT MENU.

The “CONTENT MENU Picture List” appears.

Depending on the disc, the recorder creates either temporary folder, “Auto” or “All”.

“Auto”: For CD of which compatibility confirmed by TOSHIBA. Only playable files are listed.

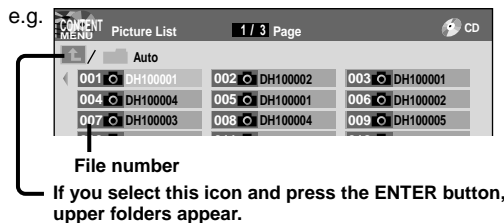

“All”: For CD other than above. All files are listed.



• Some CDs may not comply with the above.

#### 2) Press ▲ / ▼ / ◀ / ▶ to select a folder or photo.

Pressing the PICTURE SEARCH (◀▶) button turns the pages.

If you press the ★ button, the list changes to thumbnail view (“CONTENT MENU Pictures”).



Pressing the ANGLE button rotates the picture. The rotation of pictures is kept until the CD is ejected.

To return to the previous list, press the ★ button again.

#### 3) Press ENTER.

If you select a folder at step 2), repeat steps 2) and 3) until your favorite file appears.

The selected photo appears in full screen.

## Notes

- The “CONTENT MENU Picture List” cannot show all the files in a disc, but only ones regarded as objects of regular play of the disc.
- The larger the file size is, the longer the thumbnail takes time to appear.
- Letters of a file/folder name overflowing the given space are not displayed.

## ● Direct input of a photo number

#### 1) During playback or stop, press T.SEARCH.

An input window appears.

e.g.



#### 2) Input a photo number using the number buttons or ADJUST.

#### 3) Press ENTER.

The selected photo appears in full screen.

## ■ To change the playback order

#### 1) During playback (slide show) or stop, press QUICK MENU.

#### 2) Press ▲ / ▼ to select an item, then press ENTER.

To shift the cursor, press the ▲ / ▼ buttons.

- Reverse** : To reverse the order.
- Repeat** : To repeat the current folder.

#### 3) Press ENTER.

Playback in the selected mode starts.

## JPEG files compatibility

Discs whose compatibility with this recorder has been confirmed by TOSHIBA are as follows.

CANON QuickCD  
FUJICOLOR CD  
Kodak Picture CD  
NORITSU QSS CD

JPEG disc compatibility with this recorder is limited as follows:

- Playable discs:
  - CD-ROM, CD-R
  - CD-RW is not recommendable.
- CD physical format:
  - Mode 1, Mode 2 XA Form 1
- File system:
  - ISO9660 Level 1, 2 or Joliet
- File name:
  - A file name should be in alphabet and numerals only, and must incorporate “JPG” extension.
  - e.g. “\*\*\*\*\*.JPG”
- Total number of folders:
  - Less than 256
- Total number of files:
  - Less than 1000

Some files may not display their own entire image depending on the size.

Some discs may not permit this operation. Especially, the following conditions of included files will increase the disc’s disability.

1. Pixels over 5000 x 5000 in height and/or width
2. File format except Exif

# Playing MP3/WMA files

You can play MP3/WMA files that have been recorded on a CD-R or CD-ROM on this recorder.

## ■ Preparations

- Make sure that a disc you want to play is compatible with this recorder. See ➔ page 79.
- Set “Priority contents” (➔ page 160) to “Audio”.

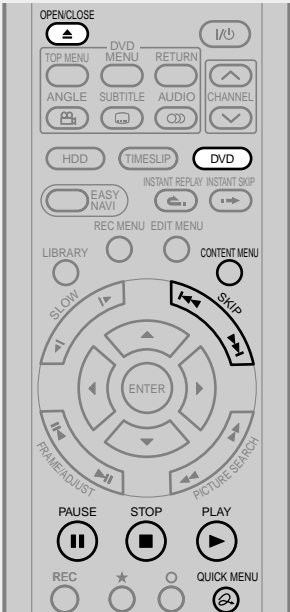

**1 Press DVD.**

DVD

---

**2 Load a CD that contains MP3/WMA files.**

OPEN/CLOSE

Playback starts from the first track of a current folder. If playback does not start, press the PLAY button.

## Notes

- WMA tracks copy-protected cannot be played.
- The DIGITAL AUDIO OUT BITSTREAM/PCM jack outputs MP3/WMA sounds in the linear PCM format regardless of the current “Audio out select” (➔ page 158) selection.
- You cannot change the playback speed of MP3/WMA playback.

## ■ To stop playback

### Press STOP.

If you press the PLAY button after pressing the STOP button, playback will start from the beginning of the track.

## ■ To pause playback

### Press PAUSE.

To resume, press the PAUSE button again or press the PLAY button.

## ■ To skip tracks

During playback, press SKIP repeatedly.

▶▶: To skip forward.

◀◀: To skip backward.

## ■ Selecting a track in the disc

2 ways are available:

## On the “CONTENT MENU Audio List”

### 1) Press the CONTENT MENU button.

The “CONTENT MENU Audio List” appears.

e.g.

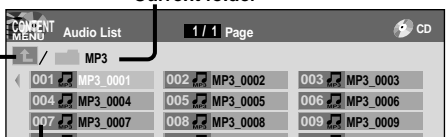

**Current folder**

**File number**

If you select this icon and press the ENTER button, upper folders appear.

e.g.

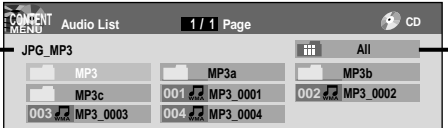

**Disc name**

The recorder creates temporary folder “All”, which contains all playable files.

## 2) Press ▲ / ▼ / ◀ / ▶ to select a track or folder.

Pressing the PICTURE SEARCH (◀◀ / ▶▶) button turns the pages.

## 3) Press ENTER.

If you select a folder at step 2), repeat steps 2) and 3) until your favorite file appears.

### Notes

- The "CONTENT MENU Audio List" cannot show all the tracks in a disc, but only ones regarded as objects of proper play of the disc.
- Letters of a file/folder name overflowing the given space are not displayed.

### Direct input of a track number

#### 1) During playback or stop, press T.SEARCH.

An input window appears.

e.g.



#### 2) Input a track number using the number buttons or the ADJUST button.

#### 3) Press ENTER.

### ■ To change the playback order

#### 1) During playback or stop, press QUICK MENU.

#### 2) Press ▲ / ▼ to select "Special playback mode", then press ENTER.

e.g.

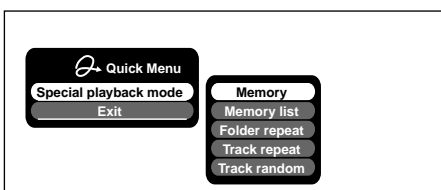

#### 3) Press ▲ / ▼ to select an item, then press ENTER.

**Memory list** : To play favorite tracks only in a favorite order.

Input a track number by using the number buttons or the ADJUST button.

To shift the cursor, press the ▲ / ▼ buttons.

**Folder repeat** : To repeat the current folder.

**Track repeat** : To repeat the current file.

**Track random** : To play files in the current folder in a random order.

### Notes

- To cancel these modes, stop the playback or select the cancel command from the Quick Menu.

## Playable files

MP3/WMA disc compatibility with this recorder is limited as follows:

- Playable discs:
  - CD-ROM, CD-R
  - CD-RW is not recommendable.
- Sampling Frequency / Bitrate:
  - WMA: 32 kHz / 48 kbps (CBR), VBR
  - 44.1 kHz / 48-192 kbps (CBR), VBR
  - 48 kHz / 128-192 kbps (CBR), VBR
  - MP3: 8 kHz, 11.025 kHz, 12kHz, 16 kHz, 22.05 kHz, 24 kHz / 8-160 kbps (CBR), VBR
  - 32 kHz, 44.1 kHz, 48 kHz / 32-320 kbps (CBR), VBR
- CD physical format:
  - Mode 1, Mode 2 XA Form 1
- File system:
  - ISO9660 Level 1, 2 or Joliet
- File name:
  - A file name should be in alphabet and numerals only, and must incorporate "MP3" or "WMA" extension.
  - e.g. "\*\*\*\*\*.MP3", "\*\*\*\*\*.WMA"
- Total number of folders:
  - Less than 256
- Total number of files:
  - Less than 1000
- WMA codec version:
  - V7, V8, V9

\* This recorder supports ID3v2 (ID3 Tag Version 2) of MP3, to display text data such as names of title and artist. Some characters may be displayed properly.

This recorder requires discs/recordings to meet certain technical standards in order to achieve optimal playback quality. Pre-recorded DVDs are automatically set to these standards. There are many different types of recordable disc formats (including CD-R containing MP3/WMA files). Given the fact that technology in this area is still maturing, Toshiba cannot guarantee that all genre of recordable discs will produce optimal playback quality. The technical criteria set out in this owner's manual are meant as a guide only.

Customers should also note that permission is required in order to download MP3/WMA files and music from the internet. Toshiba has no right to grant such permission. Permission should always be sought from the copyright owner.

Microsoft, Windows Media, and the Windows Logo are trademarks or registered trademarks of Microsoft Corporation in both the United States and other countries.



# Checking the current status and settings

You can confirm operational status and setting details.

## Operational status and setting details



### 1 Press DISPLAY.

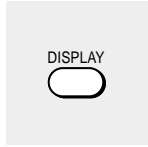

The following on-screen display appears. (The actual display varies depending on the disc.)

e.g. while playing a DVD-RAM disc

**Elapsed time of a title/  
Elapsed time of a chapter    Mode indicator**

**Title No./  
Chapter No.                      Playback  
mode                              Operating disc**

**Status display                      Receiving  
channel**

e.g.

▶ Title	002: 00:10:29	Title	DVD	3
Chapter	0005: 00:05:15	repeat		Stereo

### 2 Press DISPLAY again.



An expanded display appears. (Actual display varies depending on the disc.)

**Remaining time**

e.g.

▶ Title	002: 00:22:01	Title	DVD	3
Chapter	0005: 00:00:07	repeat		Stereo
Virtual surround : Off Picture Quality : SP Audio Quality : Audio : <input checked="" type="checkbox"/> Stereo R Original Audio Output : Bitstream Subtitle : -- Off				

### 3 Press DISPLAY again to turn the display off.

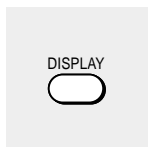



## Using the time bar

The time bar shows the current progress in playback or recording.

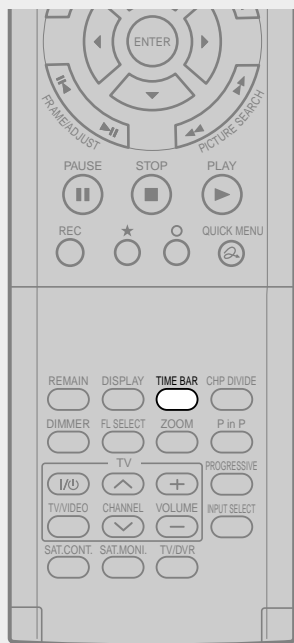

### 1 During playback or recording, press TIME BAR.

The time bar appears. (The actual display varies depending on the disc.)

TIME BAR



e.g. Playback Locator (Shows the current location.)

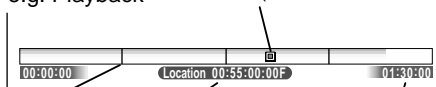

Chapter division

Elapsed time

Total playing time of a current title  
(In the case of a VIDEO CD or  
audio CD, it shows the total  
playing time of the disc.)

e.g. Recording Locator (Shows the current location.)



Elapsed time

Elapsed recording time (per 30 minutes)  
(Recording end time if it comes within 30  
minutes.)

#### Note

- Time display is an approximation.

#### ■ Changing the location of the time bar

While the time bar is displayed, press ▲ / ▼.  
The time bar shifts up and down.

#### ■ Turning off the time bar

Press TIME BAR.

# Functions in the Quick Menu

Besides these examples, various other ones are introduced on respective pages for your convenience. See  page 24 on how to operate the Quick Menu.

## ■ To play repeatedly (Repeat playback)

HDD DVD-RAM DVD-RW DVD-R DVD-VIDEO VCD CD

You can repeat a desired section.

- 1) During playback, press **QUICK MENU**.
- 2) Press **▲ / ▼** to select “Special playback mode”, then press **ENTER**.

### Special playback mode

The sub-menu appears. Select the next item by pressing the **▲ / ▼** buttons and the **ENTER** button.

#### A-B repeat

You can designate a portion in a title or track to repeat continuously.

If you select “A-B repeat” and press the **ENTER** button, the following display appears. Perform steps 1 and 2 below.

e.g.



To cancel the procedure, press the **O** button.

- 1) Press **ENTER** at the beginning of the segment (point A) you want to repeat.  
The location of point A is memorized.  
The display changes to “Set B”.
- 2) Press **ENTER** at the end of the segment (point B).  
The location of point B is memorized, and repeat playback begins between point A and B.

#### Title repeat

To repeat the same title.

#### Chapter repeat

To repeat the same chapter.

#### Track repeat

To repeat the same track.

#### Disc repeat

To repeat the entire disc.

#### Repeat all ORG titles

To repeat all original titles in a disc.

#### Repeat all PL titles

To repeat all playlist titles in a disc.

#### Cancel repeat

(in Repeat playback mode)

To resume normal playback.

Playback of the HDD or a DVD-RAM disc stops.

### Notes

- Some discs may not permit repeat operation.
- You cannot use the repeat playback function in conjunction with the random playback function.
- If you press the **STOP** button during repeat playback, this operation is canceled.
- While you are performing repeat playback on the HDD or a DVD-RAM disc, other operations ( pages 64 to 66) except pause play are not available.

## ■ To play in random order (Random play)

DVD-RW DVD-R DVD-VIDEO VCD CD

You can play sections in random order.

- 1) During playback or stop, press **QUICK MENU**.
- 2) Press **▲ / ▼** to select “Special playback mode”, then press **ENTER**.

### Special playback mode

The sub-menu appears. Select the next item by pressing the **▲ / ▼** buttons and the **ENTER** button.

#### Title random

Plays all titles in a loaded disc in random order.

Each title is played beginning from chapter 1.

#### Chapter random

Plays all chapters in a current title in random order.

#### Track random

Plays all tracks on a loaded disc in random order.

**Cancel random** (in Random play mode)

Resumes normal playback.

**Notes**

- Some discs may not permit random playback operation.
- You cannot use the random playback function in conjunction with the memory playback function.
- You cannot use the random playback function in conjunction with the repeat playback function.
- Pressing the STOP button during operation cancels random playback.

**To play in favorite order (Memory playback)**

DVD-RW DVD-R DVD-VIDEO VCD CD

You can select 30 titles, chapters, or tracks and play them in favorite order.

(To play contents in the HDD or a DVD-RAM disc in favorite order, make a playlist. For details, see "Editing" on  page 86.)

- 1) During playback or stop, press QUICK MENU.
- 2) Press **▲ / ▼** to select "Special playback mode", then press ENTER.

**Special playback mode**

The sub-menu appears. Select the next item by pressing the **▲ / ▼** buttons and the ENTER button.

**Memory list**

If you select this and press the ENTER button, the following display appears. Perform the steps below.

e.g.

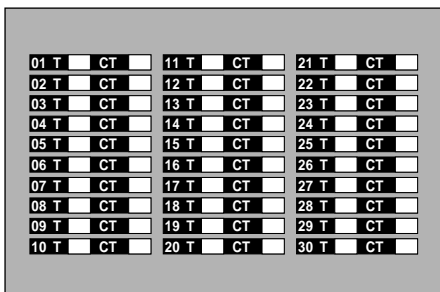

- 1) Input numbers of titles, chapters, or tracks by using the number buttons, in favorite order.

Input each 3-digit number.

To input a 1- or 2-digit number, first input 0.

(e.g. "0", "0", "3".)

To cancel the numbers, press the CLEAR button.

To input a chapter number, press the **◀ / ▶** buttons to shift the cursor.

- 2) Press **▲ / ▼** to select the next box, then perform step 1).

To select another chapter in the same title, you do not need to select the title number.

Repeat these steps if necessary.

You can program up to 30 selections into memory.

- 3) Press ENTER.

Memory playback starts.

**Memory** (in normal playback mode)

(in normal playback mode)

To display an entry box for one program selection.

**Memory release** (in memory playback mode)

(in memory playback mode)

To resume normal playback.

**Memory repeat** (in memory playback mode)

(in memory playback mode)

To repeat a current memory playback.

**Notes**

- Some discs may not permit memory playback operation.
- Inputting numbers of titles, chapters or tracks that a disc does not contain will result in error.
- You cannot program/change selections during memory playback. To change selections, cancel memory playback by pressing the STOP button.
- When you turn off the power, the selected memory is erased.
- You can exit the memory playback display by pressing the O button.

■ **To display the current bit rate**

HDD DVD-RAM DVD-RW DVD-R DVD-VIDEO VCD

- 1) During playback, press QUICK MENU.
- 2) Press ▲ / ▼ to select “Bit rate”, then press ENTER.

Bit rate

**Note**

- To turn off the bit rate display, select this item again.

■ **To check information on a title**

HDD DVD-RAM DVD-RW DVD-R

- 1) During playback, press QUICK MENU.
- 2) Press ▲ / ▼ to select “Title information”, then press ENTER.

Title information

■ **To exit the Quick Menu**

HDD DVD-RAM DVD-RW DVD-R DVD-VIDEO VCD CD

Press QUICK MENU again.

or

Press ▲ / ▼ to select “Exit”, then press ENTER.

Exit

# Editing

You can create your own movie from your assembled scenes. Save your favorite videos in DVD discs.

- **Before editing**
- **Creating chapters**
- **Playlist editing**
- **Creating thumbnails**
- **Before dubbing**
- **High speed Library dubbing**
- **Dubbing selected items**
- **Rate conversion dubbing**
- **Line-U dubbing**
- **Deleting selected items**
- **Combine Original titles**
- **Creating a DVD-Video using DVD-R/RW**
- **DVD-Video finalizing process**
- **DV recording**

# Before editing

**Be sure to read before performing any editing.**

## For better use the HDD of this recorder

When you save necessary scenes from recorded contents, it may not be a good method to delete unnecessary portions from a recorded title in the HDD, then copy the remainder to a DVD-RAM disc.

Repeating this method increases blank spaces in the HDD, on which contents will be recorded discontinuously (fragmentation in the HDD), resulting in slowdown of the system or incomplete deleting operation, in the worst case, the system may refuse any commands for play or recording, to protect the damaged HDD.

To delete unnecessary scenes from a title to save, first make a Playlist (virtual title) by collecting necessary scenes, then copy the Playlist to change it into a new title, finally delete the original one. This method is more simple and can save your time and reduce possibility of such fragmentation troubles of the HDD.

To avoid HDD fragmentations, it is also recommended that you execute periodically deletion of all titles in the HDD or initialization of the HDD. Before initializing the HDD, be sure to copy necessary contents to DVD-RAM discs, because initializing erases all data in the HDD. Library (▶ page 140) data are also recorded in the HDD. If you do not want to erase them, copy them into DVD-RAM discs before initializing the HDD. Load the backup DVD-RAM disc into the recorder after initializing the HDD, copy the data back to the HDD.

## Editing on this recorder

### Basic steps of editing

Creating chapters → Programming a Playlist → Dub (Copy) the Playlist (this will create an Original title of the desired scenes)

Editing is executed by a title and a chapter. Titles and chapters are classified into "Original" and "Playlist." First, specify a desired scene by dividing a title (Original) into chapters. Then compile the necessary chapters (Original) in desired order by programming a Playlist. Then dub (copy) the Playlist on the same disc. This creates a title (Original). Refer to the following examples about "Playlist" and "Original."

Example: Creating your own music compilation by collecting songs from music programmes you record from Monday to Friday.

#### ● You can create one title for one recording.

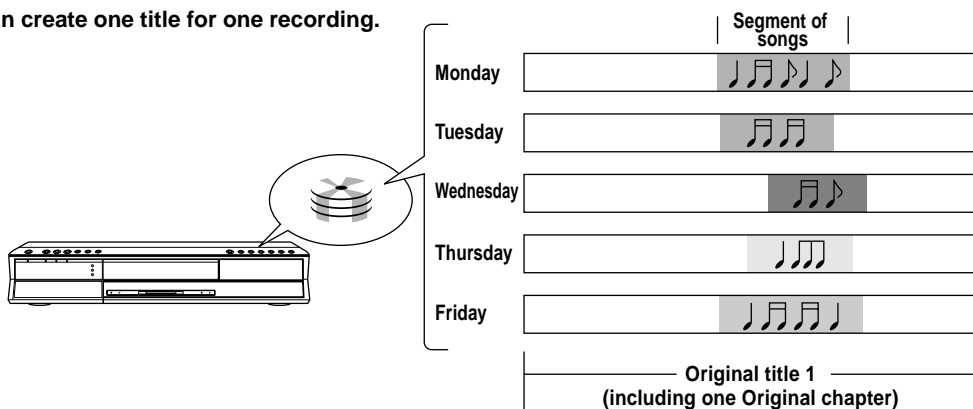

In the example above, five titles are created, as you recorded programmes five times from Monday to Friday. **The content you recorded** is called "**Title (Original)**". All chapters in a title (Original) are chapters (Original).



#### ● Specify the range (a favorite song) you need in each title (Original).

To specify the range, create a chapter. A segment of a song becomes one chapter by creating divisions in a chapter at the beginning and end of a song. In the example to the right, three chapters (Original) are created in one title (Original).

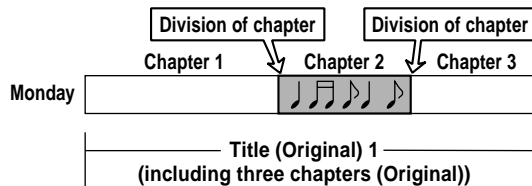



● **Compile chapters in a desired order.**

You can select any chapter or order of chapters, as you want. Also you can assign a title to multiple chapters.

Each element to be compiled is called a part. In the example to the right, the three chapters in Wednesday, Friday, and Monday are the parts. When compiled, the source chapter (Original) remains as it is in the title (Original).

A new part is not created by copying the source chapter (Original). It does not contain actual recorded content but only exists as an informational sub-set of the chapter name and the playback order (in the right example, the chapter names are “Monday, Wednesday, and Friday” and the playback order is “Wednesday→Friday→Monday”).

For actual playback, the contents of the source chapter (Original) are played. Basically, it is a list for the recorder to go and find the content.

You can create a part from the Original as many times as you want and you can make different titles with the same parts by changing the combination or order.

For parts, you can use not only chapters like in the example, but also titles (Original) and other Playlist.

You can play the actual recorded content, such as titles (Original) and chapters (Original), or by managing the Originals and parts, you can virtually create a variety of titles without increasing the use of disc space.

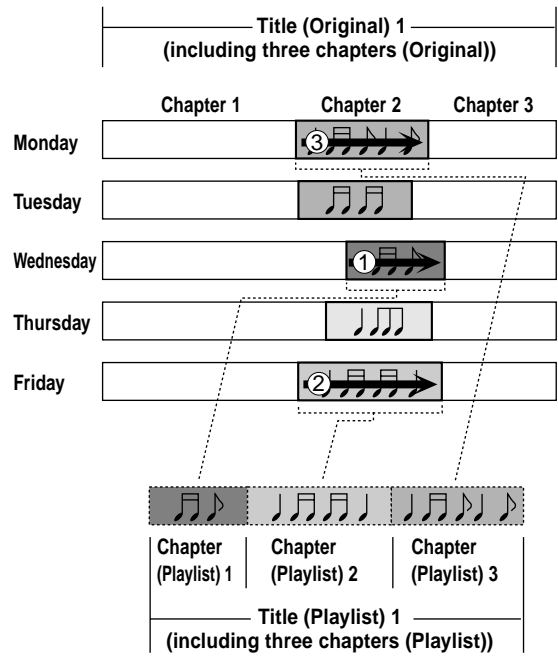

When title (Playlist) 1 is played, ①, ② and ③ are played in order.

These **virtual titles or chapters** are called “**Title (Playlist)**” or “**Chapter (Playlist)**” respectively.

In order to differentiate titles (Playlist) from titles (Original), an Original is displayed on screen as “ORG” and a Playlist is displayed as “PL”.





● **Make the compiled chapters into a title (Original).  
(Dubbing)**

If you just want to play the compiled chapters in desired order, you only play the Playlist. If you want to delete a title (Original) which contains unnecessary chapters, be sure to dub (copy) the Playlist and make it into a title (Original).

You are now converting the virtual file (playlist) into an actual file that will become a new Original file.

**Playlist**



Chapter (Playlist) 1	Chapter (Playlist) 2	Chapter (Playlist) 3
-------------------------	-------------------------	-------------------------

———— Title (Playlist) 1 ————



Dubbing (Copying)

**Title**



Chapter (Original) 1	Chapter (Original) 2	Chapter (Original) 3
-------------------------	-------------------------	-------------------------

———— Title (Original) 1 ————

**Notes**

- A title (Playlist) or a chapter (Playlist) is based on a title (Original) or a chapter (Original). Therefore changing or deleting a title (Original) or a chapter (Original) will affect the related title (Playlist) or chapter (Playlist).
- Some recorded content cannot be edited (for example, a title including still images).
- The boundary of the title with unnecessary part deleted and titles (Playlist) having different parts cannot be played back seamlessly (without break).

**Proceed to the practical operations.**

See “Creating chapters” (➡ page 90) and “Playlist editing (Collecting desired scenes)” (➡ page 95).

For the dubbing procedure, see “High speed Library dubbing” (➡ page 106).

# Creating chapters

A recording makes 1 title, which includes 1 chapter. By dividing it into several chapters, it will be easier to access a desired scene, and your editing or playback will be much easier.

To create chapters in a title, insert a chapter mark. Playback the content, locate a point where you want to divide, then press the **CHP DIVIDE** button. You can insert a chapter mark also while recording, by pressing the **CHP DIVIDE** button. (A chapter will also be placed in the recording when you pause.)

The point divides the chapter (into two). You can create multiple chapters by repeating the above operation.

## Notes

- Chapters cannot be created in the following modes:  
Dubbing / Fast-reverse, Fast-forward / Slow-motion
- You cannot divide a title of a DVD-R/RW disc into chapters. It is possible to create chapters in a DVD-R/RW disc by pressing the **CHP DIVIDE** button during recording at the desired points, or by selecting an option that inserts chapter marks automatically during recording at regular intervals. (▶ page 162)

If you want to modify the chapter division, or want to place a chapter mark more precisely monitoring the frame counter, follow the procedures below.

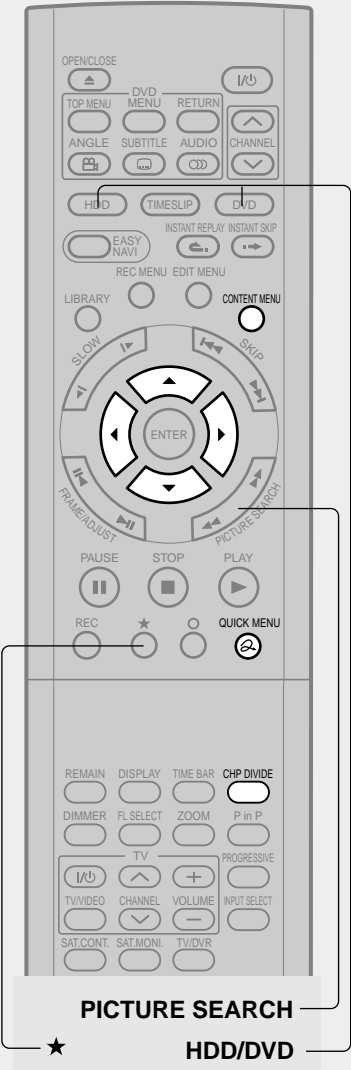

**1** During stop, playback or recording, press **CONTENT MENU**.

The "CONTENT MENU Title List" appears.

Pressing the HDD or DVD button can switch the drives.

**2** Press **▲ / ▼ / ◀ / ▶** to select a title.

- To go to the next or previous page, press the **PICTURE SEARCH (◀◀ / ▶▶)** button.
- To select a chapter, first highlight the title that contains the chapter you want, then press the **★** button. The display changes to "CONTENT MENU Chapter List". To go back to the title display, press the **★** button again.

**3** Press **QUICK MENU**.

The Quick Menu appears.

e.g.

Quick Menu			1 / 2 Page	HDD
Title information				
Create thumbnail	7:00	0002	2004/06/08 23:00	
High speed dubbing			Ch:6	(0:29:50)
Rate conversion dubbing	3:45			(Original)
Chapter function				
Edit function	9:00	0006	2004/07/11 7:00	
Special playback mode			Ch:8	(Original)
Save captured images	2:40			(0:54:30)
Disc information				(Original)
Display changeover	23:00	0000	2004/07/12 21:00	
Specific page jump			Ch:10	(0:51:28)
Title delete	0:08			(Original)
Exit				

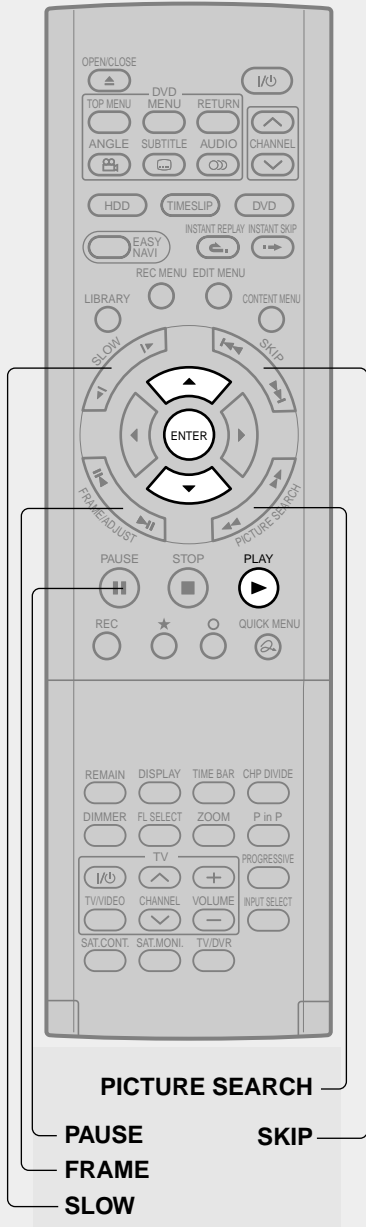

## 4 Press ▲ / ▼ to select “Chapter function”, then press ENTER.

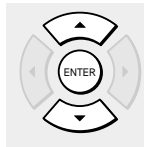

The sub-menu appears.

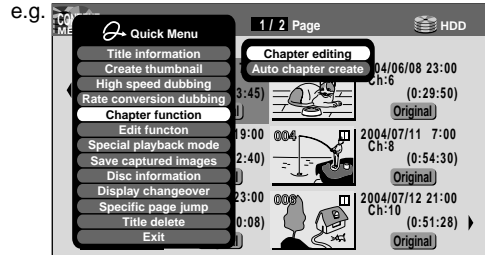

## 5 Press ▲ / ▼ to select “Chapter editing”, then press ENTER.

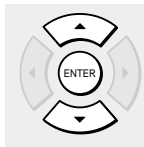

The EDIT MENU Chapter Editing display appears.

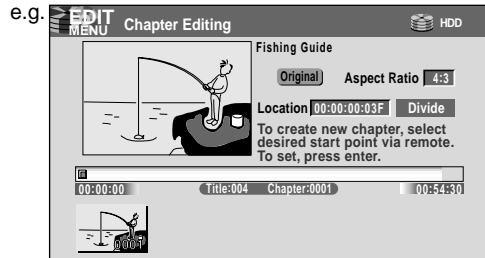

## 6 Press PLAY to start playback.

PLAY



Locate a scene where you want to insert a chapter mark.

You can use the following buttons.  
PICTURE SEARCH, SLOW, SKIP, PAUSE,  
FRAME/ADJUST, etc.

The locator shows the current position on the time bar.  
And the live video plays in the upper left.

- To access other chapters:  
Press the ▲ / ▼ buttons to move to the thumbnail display, then press the ◀ / ▶ buttons to select a desired thumbnail.  
To go to the next page, press the PICTURE SEARCH button.
- You can confirm the first and last scenes of a chapter.  
Select a thumbnail and press the ENTER button.  
3 seconds of the first and last scenes are played.



## 7 At a point where you want to make a chapter division, press PAUSE.



The picture pauses.

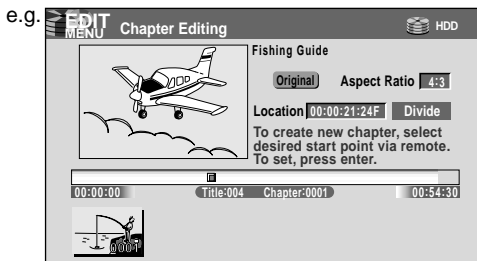

## 8 Press ▲/▼/◀/▶ to select “Divide,” then press ENTER.

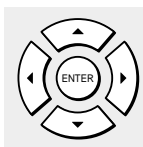

A chapter division is created at the selected location, and the first scene of the new chapter is registered as a chapter thumbnail.

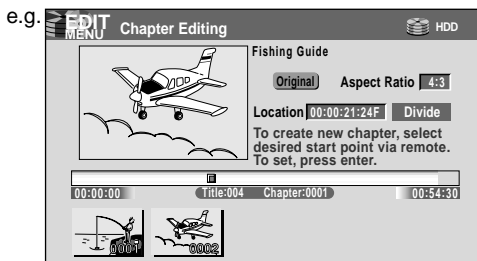

## 9 Repeat steps 6 to 8.

Locations of chapter division are indicated by the markers on the time bar.

To erase a chapter division, see “Merging chapters” (➔ page 94).

## 10 When all chapter divisions have been made, press ○.

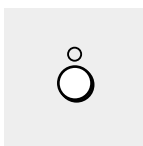

The recorder displays a message, and starts saving the chapter divisions on the time bar.

When complete, the CONTENT MENU returns.

## Notes

- This recorder supports a limited number of chapters on a disc. If exceeded, a message appears. In this event, reduce the number of chapters by merging chapters. (➡ page 94)
- The “EDIT MENU Chapter Editing” can also be viewed by selecting “Chapter Editing” from the “EDIT MENU Main Menu”.

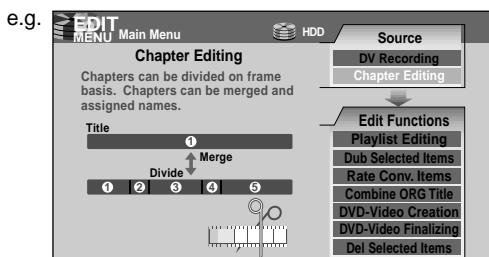

- To exit the “EDIT MENU Main Menu”, press the EDIT MENU button.
- Making chapters in a title (Original) does not affect the related titles (Playlist).
- There may be a small difference between a location you marked and a chapter division actually played.
- Pausing a recording automatically creates a chapter division.
- During relay recording (➡ page 48), a chapter division is automatically created at the start point of relay record.
- During an A-B recording (➡ page 48), if the recorder has to record all content onto the HDD, a chapter division is automatically created at a point that corresponds to the beginning of side of a DVD-RAM disc.
- If you create chapters in a title which is stored in the HDD and copy the title to a DVD-R/RW, the chapter divisions may shift.

## ■ Creating chapters automatically when recording

You can create chapter marks from the beginning of a title at regular intervals automatically. (Chapter marks are added to those already existing.) This is convenient for long programs, such as live sports games.

- 1) Perform steps 1 to 4 on ➡ pages 90 to 91.
- 2) Press ▲ / ▼ to select “Auto chapter create”, then press ENTER.
- 3) Press ▲ / ▼ to select a chapter division interval, then press ENTER.

Chapter divisions are automatically marked at the selected intervals.

## ■ Editing chapter break

You can adjust positions of chapter marks. You can shift the beginning of a chapter currently selected.

- 1) Perform steps 1 to 5 on ➡ page 90 to 91.
- 2) Press QUICK MENU.
- 3) Press ▲ / ▼ to select “Chapter break edit mode”, then press ENTER.
- 4) Press ▲ / ▼ to select the item, then press ENTER.

### “by frame (VR mode)”

The chapter mark shifts by one frame.

For contents which will be copied to DVD-RAM discs.

### “by GOP (Video mode)”

The chapter mark shifts by a GOP (about 0.5 second), which is a unit of editing in DVD-Video format.

For contents which will be copied to DVD-R/RW.

- 5) Press ◀ / ▶ to select a chapter whose beginning you want to shift.
- 6) Press FRAME (II◀ / ▶II) repeatedly until a desired scene appears.
 

Select a point while monitoring the thumbnail, which changes as you press the button. To operate other chapters, press the ◀ / ▶ buttons to select another, then follow the above steps.
- 7) When complete, press QUICK MENU, and select “Chapter break edit mode off (by frame)” or “Chapter Break Edit Mode off (by GOP)” then press ENTER.
 

The recorder exits the adjusting mode.

## Notes

- You cannot shift a chapter mark beyond the adjacent chapter marks or a logical gap on recorded data within a chapter.
- Shifting a chapter mark restores a thumbnail to the beginning of a chapter. This may occur also on the previous chapter depending on the data condition.

## ■ Merging chapters

- 1) Perform steps 1 to 5 on  pages 90 to 91, to view the EDIT MENU Chapter Editing display.
- 2) Press **▲ / ▼ / ◀ / ▶** to highlight a chapter.  
Pressing the PICTURE SEARCH button can access preceding or following pages.
- 3) Press QUICK MENU.

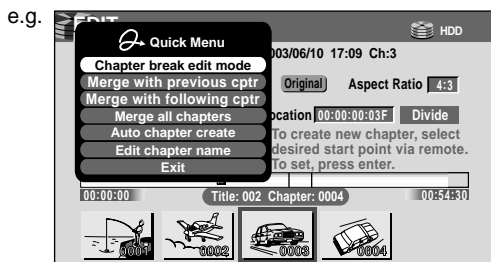

- 4) Press **▲ / ▼** to select an item.

### Merge with previous cptr:

To delete the chapter division between the selected chapter and the previous one.

### Merge with following cptr:

To delete the chapter division between the selected chapter and the succeeding one.

### Merge all chapters:

To merge all chapters in the title.

- 5) Press ENTER.

e.g. When “Merge with previous cptr” is selected:  
The selected chapter is merged into the previous chapter and its thumbnail is erased.

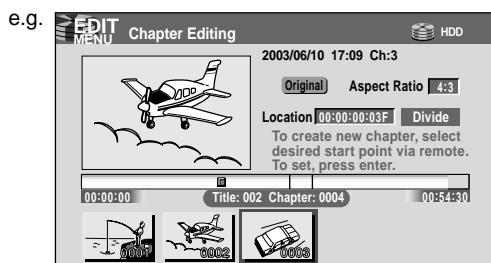

## Notes

- To turn off the “EDIT MENU Main Menu”, press the EDIT MENU button.
- When chapters are merged, the numerical value of following chapters will decrease correspondingly.
- Merging chapters does not affect the related titles (Playlist). You can also merge chapters in the title (Playlist). In this case, the title (Original) is not affected.
- You can access the feature of merging chapters also from the Quick Menu on the “CONTENT MENU Chapter List”.

## ■ Naming a chapter

- 1) From the “EDIT MENU Chapter Editing”, select a chapter which you want to name.
- 2) Press QUICK MENU.
- 3) Press **▲ / ▼ / ◀ / ▶** to select “Edit Chapter Name”, then press ENTER.

A keyboard appears.

Enter a name following the on-screen icon guides.

## Notes

- There is a limit to the number of chapters which can be named. If exceeded, a message appears.
- You can also access the keyboard to enter a chapter name by selecting a chapter with the PICTURE SEARCH button on the “CONTENT MENU Title Information”, and by selecting “Edit chapter name” from the Quick Menu on the “CONTENT MENU Chapter List”.
- You can change chapter names also on a DVD-R/RW disc, if the disc is not finalized yet.

# Playlist editing (Collecting desired scenes)

Create a "Playlist" to omit unnecessary scenes for dubbing, or compile desired scenes.



HDD/DVD

## 1 During stop, playback or recording, press CONTENT MENU.

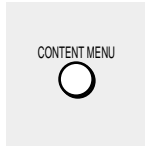

The "CONTENT MENU Title List" appears.

Pressing the HDD or DVD button can switch the drives.

## 2 Press QUICK MENU.



The Quick Menu appears.

e.g.

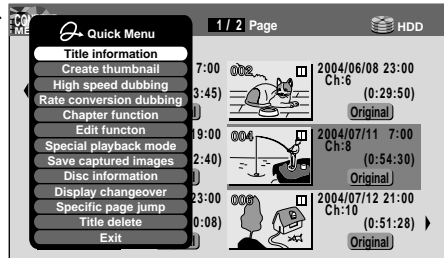

## 3 Press ▲ / ▼ to select "Edit function", then press ENTER.

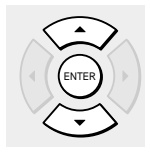

The sub-menu appears.

e.g.

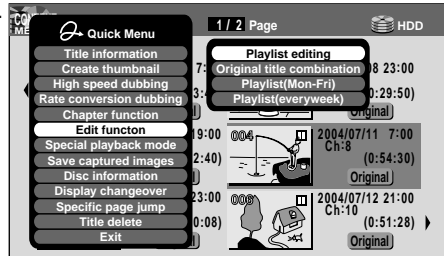

(Continued)

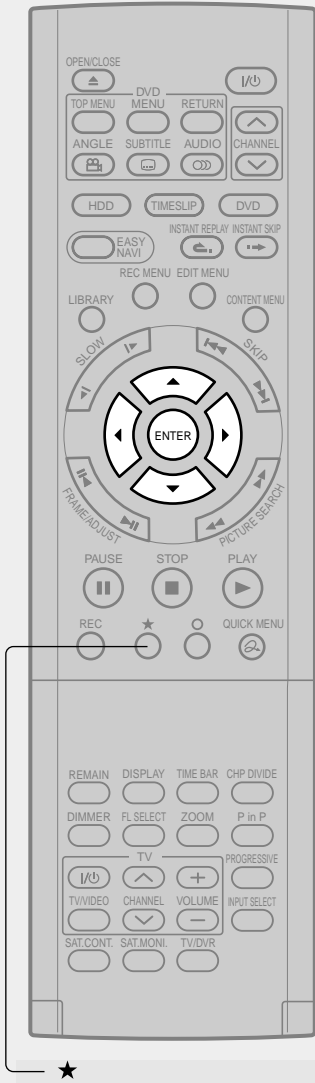

## 4 Press ▲ / ▼ to select “Playlist editing”, then press ENTER.

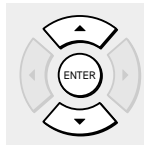

The “EDIT MENU Playlist Editing” appears.

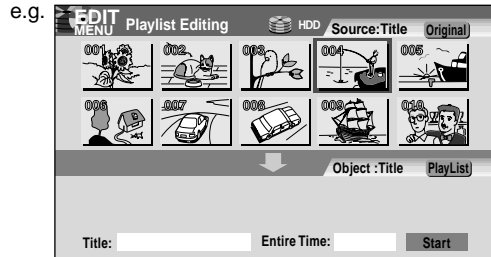

## 5 Press ▲ / ▼ / ◀ / ▶ to select a title or chapter.

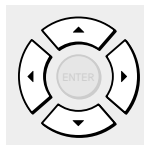

To select between titles and chapters, press the ★ button.



## 6 Press ENTER.



A cursor appears, indicating the point where the selected item will be inserted.

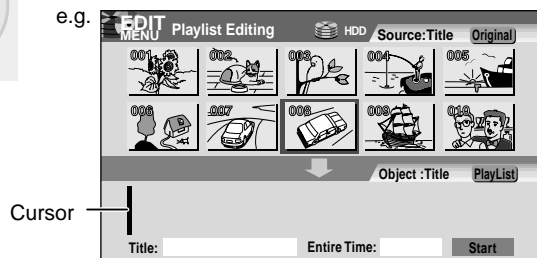





## 7 Press ◀/▶ to select a point where you want to insert the item, then press ENTER.

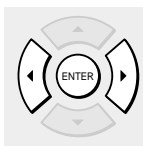

If there are no parts in the lower area, leave the cursor to the left and press the ENTER button.

The selected part is inserted at the location of the cursor.

e.g.

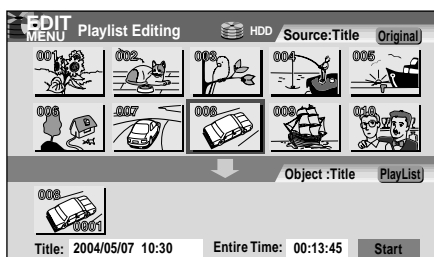

## 8 Repeat steps 5 to 7 to insert items.

To cancel the selection, see “Cancelling selection of a part” (▶ page 98).

## 9 When all items have been inserted, press ○.

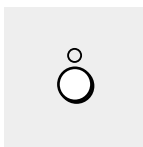

The recorder displays a message, and starts saving the Playlist.

When complete, the “CONTENT MENU” returns.

### Notes

- You can access the “EDIT MENU Playlist Editing” also by selecting “Playlist Editing” on the “EDIT MENU”.
- If you delete titles and chapters (Original), the corresponding titles and chapters (Playlist) are also deleted. Contrarily, if you delete titles and chapters (Playlist), the corresponding titles and chapters (Original) are not deleted.
- Playback may pause if a gap between the content is played.
- There may be a small difference between the chapter boundary and the actual playback picture.
- A title or chapter which is being edited cannot be selected as an item.
- You cannot add a title of still pictures, or a title or a chapter which contains both still and moving pictures, to a playlist.
- By copying (dubbing) a Playlist, a title (Original) of the same contents is created.
- You cannot program a Playlist of contents recorded on a DVD-R/RW disc. To make a Playlist using contents of DVD-RW discs, copy them to the HDD beforehand.
- Down arrow on the thumbnails means: Orange: This title already selected. Green trimmed: Some chapters in this title already selected. Green: This chapter already selected.
- A black thumbnail with “Recording” means that the title is being recorded or its recording will start within 15 seconds. This thumbnail cannot start playback.

### ■ Cancelling selection of a part

- 1) From the “EDIT MENU Playlist Editing”, press ▲ / ▼ / ◀ / ▶ to select a part to cancel.
- 2) Press QUICK MENU.  
The Quick Menu appears.
- 3) Press ▲ / ▼ to select “Cancel selected title”, then press ENTER.  
The part you have selected is cancelled.

### ■ Confirming the first and last scenes of a part or a Playlist

You can play the first and last 3 seconds of a scene (Preview). (If a title contains several chapters, the first and last scenes of the chapters are also played.)

Preview of a part:

- 1) At step 5 on ➞ page 96, select a title or a chapter, then press QUICK MENU.
- 2) Press ▲ / ▼ to select “Preview”, then press ENTER.

Preview of all parts:

- 1) Move the cursor to an any part (in the lower area), then press QUICK MENU.
- 2) Press ▲ / ▼ to select “Preview all playlists”, then press ENTER.

### ■ Confirming the title information

- 1) At step 5 on ➞ page 96, select a title or a chapter, then press QUICK MENU.
- 2) Press ▲ / ▼ to select “Title information” then press ENTER.

### ■ Correcting a Playlist

You can add or delete parts to correct a Playlist.

- 1) From the CONTENT MENU, select a Playlist to correct.
- 2) Press QUICK MENU.
- 3) Press ▲ / ▼ to select “Playlist re-editing” and then press ENTER.

The “EDIT MENU Playlist Editing” appears.

Follow the procedure from steps 5 on ➞ page 96, add or delete parts as necessary.

### Note

- You cannot edit a title (Playlist) of still pictures, or a title (Playlist) which contains both still and moving pictures.

### ■ Using a part in a Playlist also in another Playlist

- 1) In play or stop mode of a Playlist title, press EDIT MENU.  
The “EDIT MENU Main Menu” appears.
- 2) Press ▲ / ▼ / ◀ / ▶ to select “Playlist editing,” then press ENTER.  
The “EDIT MENU Playlist Editing” appears.
- 3) Press ▲ / ▼ / ◀ / ▶ to select “Start” then press ENTER.  
The areas of title name and part selection become blank.
- 4) Following the procedures outlined on ➞ page 96, make a Playlist.

### ■ Naming a title (Playlist)

- 1) From the “EDIT MENU Playlist Editing”, move a cursor to the lower side (selected parts) then press QUICK MENU.
- 2) Press ▲ / ▼ to select “Edit title name,” then press ENTER.  
A keyboard appears.
- 3) Following the procedures outlined on ➞ page 30, enter a title name.

### Note

- You can name a title also while viewing its information. From the “CONTENT MENU Title List”, select a title and press the QUICK MENU button then select “Title information” by the ▲ / ▼ buttons and the ENTER button. Further press the QUICK MENU button, and select “Edit title name” by the ▲ / ▼ buttons and the ENTER button.

---

■ **Making a Playlist of recorded contents where starting times are the same (i.e. daily or weekly recordings)**

This will help to sort serials.

- 1) From the “CONTENT MENU Title List”, press **QUICK MENU**.
- 2) Press **▲ / ▼** to select “Edit function”, then press **ENTER**.
- 3) Press **▲ / ▼** to select the item.

**“Playlist(Mon-Fri)”**

To sort out programs recorded on the same time on Monday to Friday to make a Playlist.

**“Playlist(every week)”**

To sort out programs recorded on the same time of the same day of the week to make a Playlist.

- 4) Press **ENTER**.

**Notes**

- Only titles (Original) can be sorted.
- The maximum number of sorted titles is 99.
- If you modify the recording start time or date of one of the recorded serials, the title will not be sorted out. Contrarily, any program can be sorted if its channel, recording start time and date are modified as the same as others.
- “Playlist(Mon-Fri)” can sort titles even if they are not complete 5 collections of Monday to Friday, on condition that they have the same channel and recording start time, and any recording date except Saturday and Sunday.

# Creating thumbnails (Changing the picture on the "CONTENT MENU")

You can register your favorite scene as a thumbnail displayed on the "CONTENT MENU".  
On a finalized DVD-R/RW disc, this feature is not available.

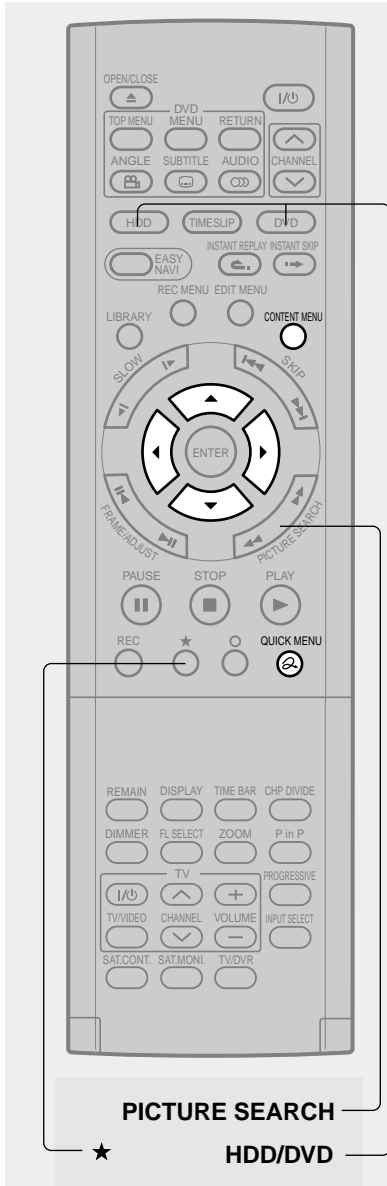

## 1 During stop or playback, press CONTENT MENU.

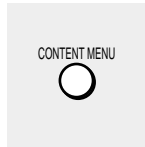

The "CONTENT MENU Title List" appears.

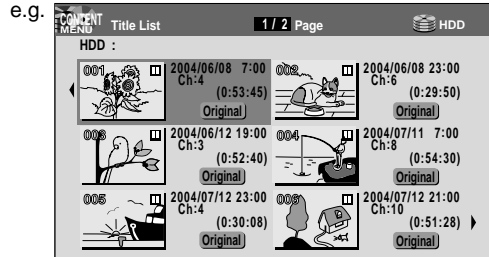

Pressing the HDD or DVD button can switch the drives.

## 2 Press ▲ / ▼ / ◀ / ▶ to select a title whose thumbnail you want to change.

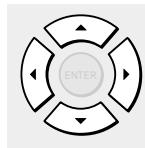

- To go to the next or previous page, press the PICTURE SEARCH (◀◀ / ▶▶) button.
- To select a chapter, select a title and press the ★ button. The "Chapter List" appears.  
By pressing the ★ button again, you can return to the Title List.

## 3 Press QUICK MENU.

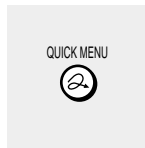

The Quick Menu appears.

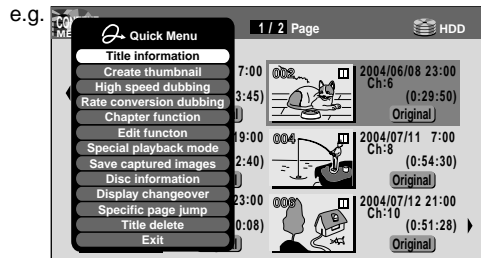

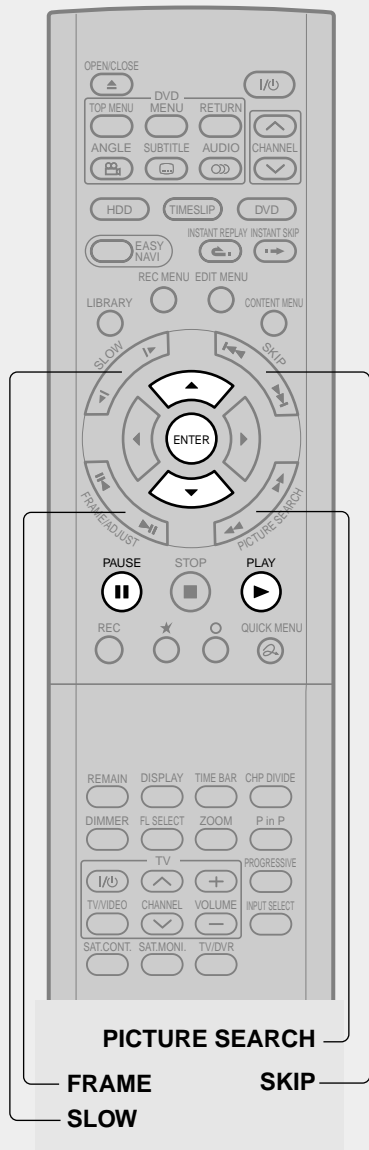

## 4 Press ▲ / ▼ to select “Create thumbnail” (or “Create CHP thumbnail” if selected a chapter at step 2), then press ENTER.

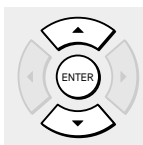

The “CONTENT MENU Create thumbnail” display appears.

e.g.

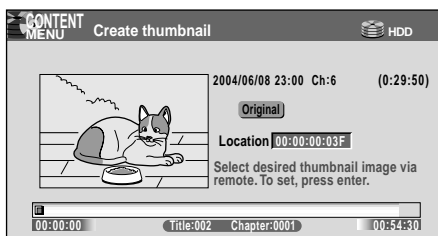

## 5 Press PLAY to start playback.



Locate a scene you want to capture as a thumbnail. You can use the following buttons. PICTURE SEARCH, FRAME, SLOW, SKIP, PAUSE, etc.

## 6 At the point where you want to capture a thumbnail image, press PAUSE.



e.g.

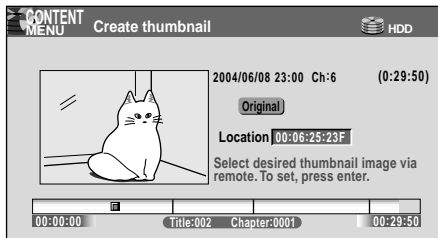

## 7 Press ENTER.

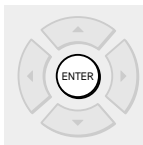

The “CONTENT MENU” returns. The selected scene is displayed as a thumbnail.

e.g.

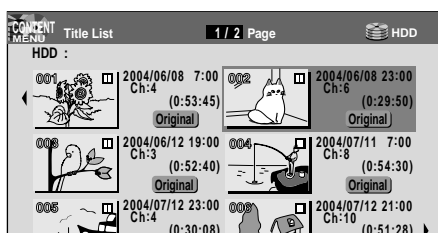

### Note

- There may be a small difference between a thumbnail made on the “Create thumbnail” display and that displayed in the “CONTENT MENU”. Operation with the PICTURE SEARCH button may extend the difference.

### Creating thumbnails (Continued)

#### Notes

- You cannot create thumbnails of chapters in a title that contains a still picture.
- If you create a chapter thumbnail, and then shift the chapter mark (▶ page 93) or record or edit the disc on other devices, the chapter thumbnail may return to the top of the chapter.

# Before dubbing

You can dub (copy or move) contents recorded in the HDD or DVD-RAM/R/RW, between HDD and DVD-RAM drive or within the same drives.

The following contains information and notes about dubbing. Read carefully before dubbing.

## ■ Dubbing operations

This recorder has the following dubbing functions.

### ● High speed dubbing

You can copy recorded contents without changing the picture and sound quality.

“High speed” means the dubbing time is shorter than the actual time of the content.

Use this function on the purposes such as the followings:

- when you copy a whole title to a DVD-RAM/R/RW disc.
- when you convert a Playlist into an Original title (produce an Original title from a Playlist)
- when you copy contents recorded in DVD-VR mode from a DVD-RW to the HDD.

### ● High speed dubbing of several contents - “Dub selected items”

You can select titles and chapters and copy them all at once.

### ● Rate conversion dubbing

You can copy a content, changing its data size to a different data one with which the content was recorded.

Use this function on the purposes such as the followings:

- When you have recorded a content on the HDD at a high rate (“MN (Manual)”), and you cannot copy it to a DVD-RAM disc because the data size is too large. (→ Reduce the data size.)

- When you recorded a content while “DVD compatible mode” (▶ page 162) was set to “Off”, and you cannot copy it to a DVD-R/RW in the DVD-Video format; or when a DVD-RAM disc was recorded with the other equipment which is not compatible with this recorder’s recording format, and you want to copy it to a DVD-R/RW (→ Set “DVD compatible mode” to “On (Mode I)” or “On (Mode II)”.)

### ● Rate conversion dubbing of several parts

You can select titles and chapters and change the data size and copy them all at once.

Use this function when you unify the compatibility of several titles and contents all at once.

### ● Line-U dubbing

You can record pictures recorded which is being played.

Use this function when you want to copy contents in DVD-R/RW recorded on other device, which cannot show thumbnails in a “CONTENT MENU Title List”, to the HDD.

All the above functions can copy data as original digital signals. “Rate conversion dubbing” and “Line-U dubbing”, however, needs data processing and may deteriorate the original picture and sound quality. Also, it is not possible to improve the picture and sound quality by the Rate conversion dubbing at increased bit rate.

From	To	High speed Library dubbing	High speed Library dubbing of several parts	Rate conversion dubbing	Rate conversion dubbing of several parts	Line-U dubbing
HDD	HDD	Yes	Yes	Yes	Yes	Yes
	DVD-RAM	Yes	Yes	Yes	Yes	Yes
	DVD-R/RW (Not finalized yet)	Yes	Yes	Yes	Yes	Yes
DVD-RAM	HDD	Yes	Yes	Yes	Yes	Yes
	DVD-RAM	Yes	Yes	No	No	No
DVD-R/RW	HDD	Yes	Yes	Yes	Yes	Yes
	DVD-R/RW	No	No	No	No	No

- It is not possible to copy to a DVD-RW of DVD-VR mode.
- “High speed dubbing” between the HDD and a DVD-R/RW recorded on other equipment is not possible.
- “High speed dubbing” to a finalized DVD-R/RW is not possible.
- “Line-U dubbing” using a DVD-R/RW which was recorded on other equipment and is not finalized yet is not possible.

### ■ “Copy” and “Move”

This recorder’s “Dubbing” has the following two definitions:

#### **Copy:**

The original programme remains after the operation is completed.

#### **Move:**

The moved programme will be erased from the original location after the operation is completed.

Whether or not you select either command depends entirely on the given situation. The command may be predetermined in some situations.

You cannot “move” contents in the following situations. (Instead, you will want to “copy” them.)

- The content is protected (➡ page 50).
- A specified portion of the title (chapter) is copy-protected, in which case, you cannot move from DVD-RAM to the HDD.
- You cannot move a Playlist. (➡ page 87) Only copying is permitted. When you copy a Playlist to a disc, it will be treated as Original on the disc. The original Playlist does not change to an Original.

Also, you cannot “move” or “copy” contents in the following situations:

- The recorded content contains a programme that permits a single copy only.
- The title (Playlist) contains a portion that prohibits copying. Edit the title from the Original and create a new Playlist.













### Notes

- If either the HDD or DVD-RAM is not in optimum physical condition, an error may occur when you execute “Move” and some titles or chapters may be lost. If you want to “Move” non-copy-protected titles and chapters, it is recommended for safety that you first “Copy” them to the opposite drive and confirm they have been copied properly. Then delete the titles and chapters to which you have executed “Move”.
- The recorder cannot copy/move the following discs:
  - DVD-VIDEO
  - VIDEO CD
  - Audio CD
  - CD-R
  - CD-RW
- If you cannot copy/move for some other reason, such as insufficient disc capacity, etc., a message will appear on screen. In such a case, follow the instructions in the message.
- Depending on the content, associated information such as data management may not be copied/moved.
- You cannot copy/move titles containing still pictures.
- Dubbing to DVD-R/RW may divide the original title depending on the contents. Also, the DVD-Video format recording (➡ page 122) may shift thumbnails.
- A part with aspect ratio 16:9 recorded at bit rate 1.4Mbps cannot be dubbed to a DVD-R/RW. Change the aspect ratio to 4:3.
- “High speed dubbing” (➡ page 106) and “Dub selected items” (➡ page 108) procedures always comply with “Aspect ratio(video mode)” setting (➡ page 162).



## ■ Recording and playback during a dubbing

Dubbing process by “High speed dubbing” and “Dub selected items” procedures will allow you to make a recording or playback of other titles.

	 <b>HDD</b> Playback	 <b>HDD</b> Recording	 <b>DVD</b> Playback	 <b>DVD</b> Recording
 <b>HDD</b> →  <b>DVD</b>	Available	Available	Not available	Not available
 <b>DVD</b> →  <b>HDD</b>	Not available	Not available	Not available	Not available
 <b>HDD</b> →  <b>HDD</b>	Not available	Not available	Available	Available
 <b>DVD</b> →  <b>DVD</b>	Available	Available	Not available	Not available

### Notes

- Timer programmed recording have priority over other operations. Dubbing may be stopped if a timer program recording starts.
- While recording during dubbing, the “CONTENT MENU” and the “LIBRARY MENU” cannot appear.
- Playing a recorded title while recording another on the same disc (➡ page 36), is not possible while dubbing.

# High speed Library dubbing (Dubbing only a specified part)

This section explains how to dub a specific title or chapter. To select several parts and dub them all at once, refer to page 108.

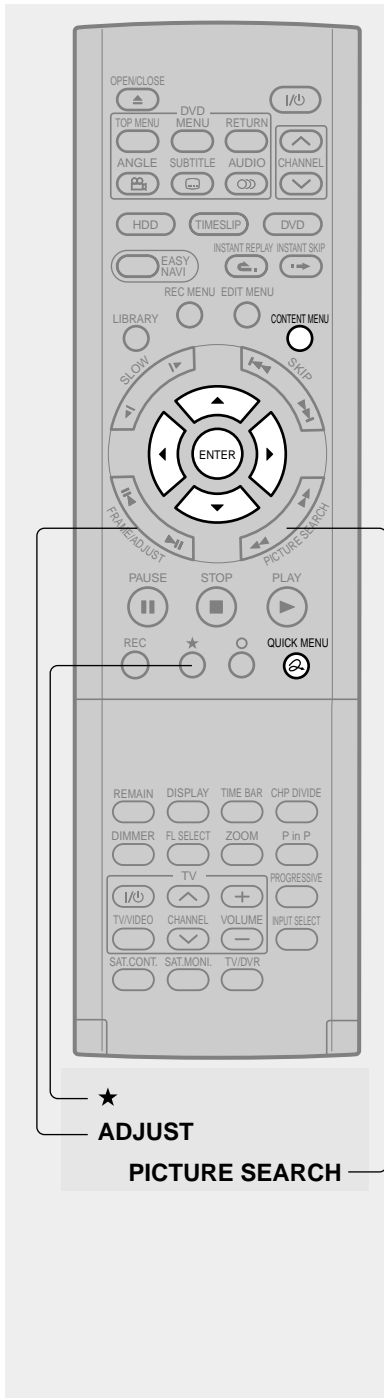

## 1 During playback or stop, press CONTENT MENU.

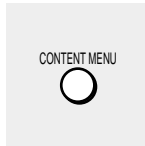

The "CONTENT MENU Title List" appears.

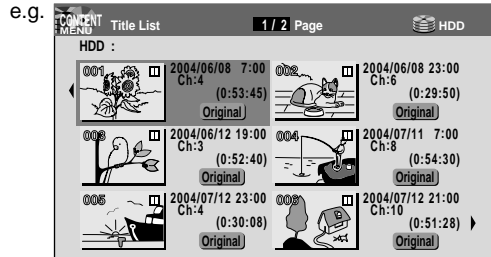

## 2 Press ▲/▼/◀/▶ to select a part (a title or chapter) to copy or move.

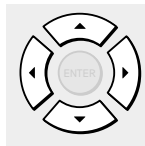

- You can go forward/back to pages by pressing the PICTURE SEARCH (◀◀/▶▶) button. You can jump to a page by specifying the page number. Press the QUICK MENU button, select "Specific page jump". Use the ADJUST button to change the page number.
- To select a chapter, highlight a title and press the ★ button. If you press the button again, the title list reappears.

## 3 Press QUICK MENU then select "High speed dubbing" by pressing ▲/▼ from the Quick Menu, then press ENTER.



The "CONTENT MENU High Speed Library Dubbing" appears.

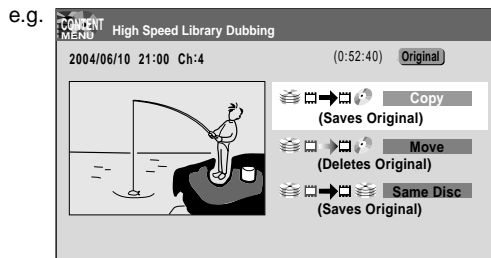

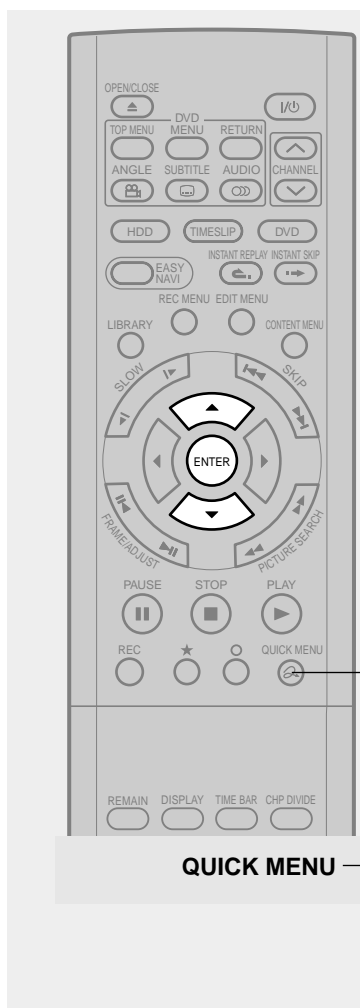

## 4 Press ▲/▼ to select “Copy”, “Move” or “Same Disc”.

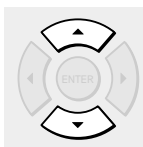

### Copy:

After the operation is completed, a specified part will remain on the disc where it was previously located.

### Move:

A part will move to the opposite disc and will be erased from the disc where it was previously located.

### Same Disc:

A part will be copied to the same disc and the copied part will become another title. This operation is useful to change a Playlist to Original.

“Copy” or “Move” is automatically selected in the following cases.

### Copy:

When a specified title (or chapter) is a Playlist. When a specified title (or chapter) is locked (👉 page 50).

### Move:

When a specified title (or chapter) is copy-protected.

## 5 Press ENTER.

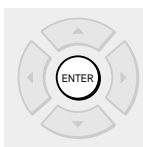

Copying starts.

The job progress is displayed on the screen and the front panel display.

When the job finishes, the graph disappears and the buzzer sounds.

You can set the recorder to turn off automatically when the job finishes.

- (1) During the operation, press the QUICK MENU button.
- (2) Press the ▲/▼ buttons to select “Auto power off”.
- (3) Press the ENTER button.

### Notes

- A title or a chapter becomes a title by being copied.
- “Same Disc” job using a DVD-RAM disc will take a longer time.
- “Same Disc” is not available on DVD-R/RW.
- “Move” is not available between the HDD and DVD-R/RW.
- Some parts in DVD-R/RW may be divided if dubbed.
- For a copy-once permitted content, only moving from the HDD to a DVD-RAM disc is available. Executing this will delete the original content in the HDD, and the one moved to a DVD-RAM will not be able to moved or copied.
- “High speed dubbing” is not available between the HDD and DVD-R/RW recorded on other equipment.
- If you record a title directly onto a DVD-R/RW in the DVD-Video mode on this recorder and execute “High speed dubbing” on the title to the HDD, the recorder may display a message to initialize the HDD. In this case, delete the title or execute “All HDD titles delete” (👉 page 163).

### ■ To cancel copying halfway through the operation

- 1) During copying, press QUICK MENU.  
The Quick Menu appears.
- 2) Press ▲/▼ to select “Cancel dubbing”, then press ENTER.

### Notes

- Cancellation of a copying operation will result in deletion of a portion of the title or chapter already copied.
- Cancellation of a copying to a DVD-R cannot restore the disc space in the DVD-R.

# Dubbing selected items (Dubbing specified parts together)

This section explains how to copy several specific titles or chapters. Assigned names of titles/chapters or other information can also be copied. A title or chapter becomes a title by being copied.

## ■ Preparation

- Press the HDD or DVD button to select a disc that contains titles or chapters you want to copy.



HDD/DVD

### 1 During playback or stop, press EDIT MENU.



The "EDIT MENU Main Menu" appears.

### 2 Press ▲ / ▼ to select "Dub Selected Items".

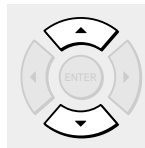

### 3 Press ENTER.



The "EDIT MENU Dub Selected Items" appears.

e.g.

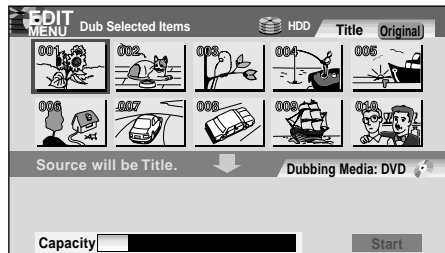

Thumbnails of the parts in the disc are displayed in the upper area.

To change the dubbing destination:

- 1) Press the QUICK MENU button.
- 2) Press the ▲ / ▼ buttons to select "Change media to HDD" or "Change Media to DVD".
- 3) Press the ENTER button.

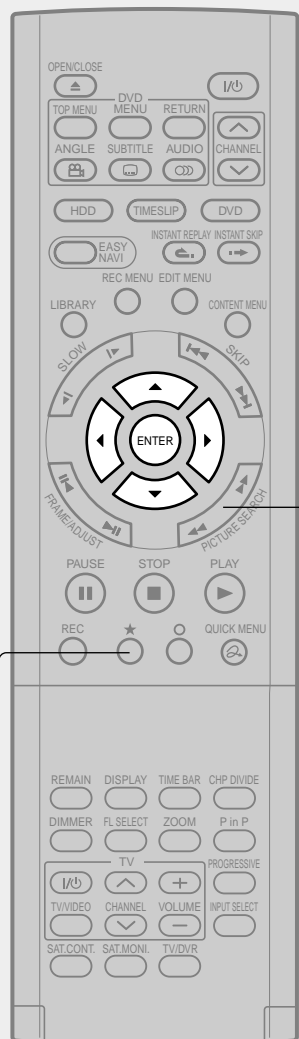

★  
PICTURE SEARCH

## 4 Press ▲/▼/◀/▶ to select a part (a title or chapter) to copy.

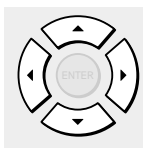

- To go to the next or previous page, press the PICTURE SEARCH (◀◀/▶▶) button.
- To select a chapter, first select the title that contains the chapter you want, then press the ★ button. To go back to the title display, press the ★ button again.

e.g.



## 5 Press ENTER.

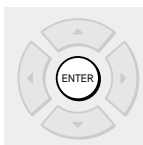

A cursor appears in the lower area (destination media).

e.g.

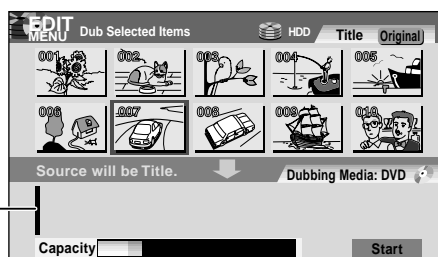

Cursor

## 6 Press ◀/▶ to select a location to place the selected part, then press ENTER.

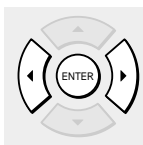

If there are no parts in the lower area, leave the cursor to the left and press the ENTER button.

The selected part is inserted into the location of the cursor.

e.g.

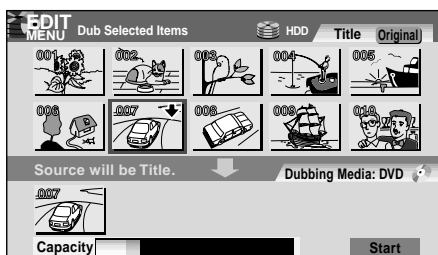

(Continued)

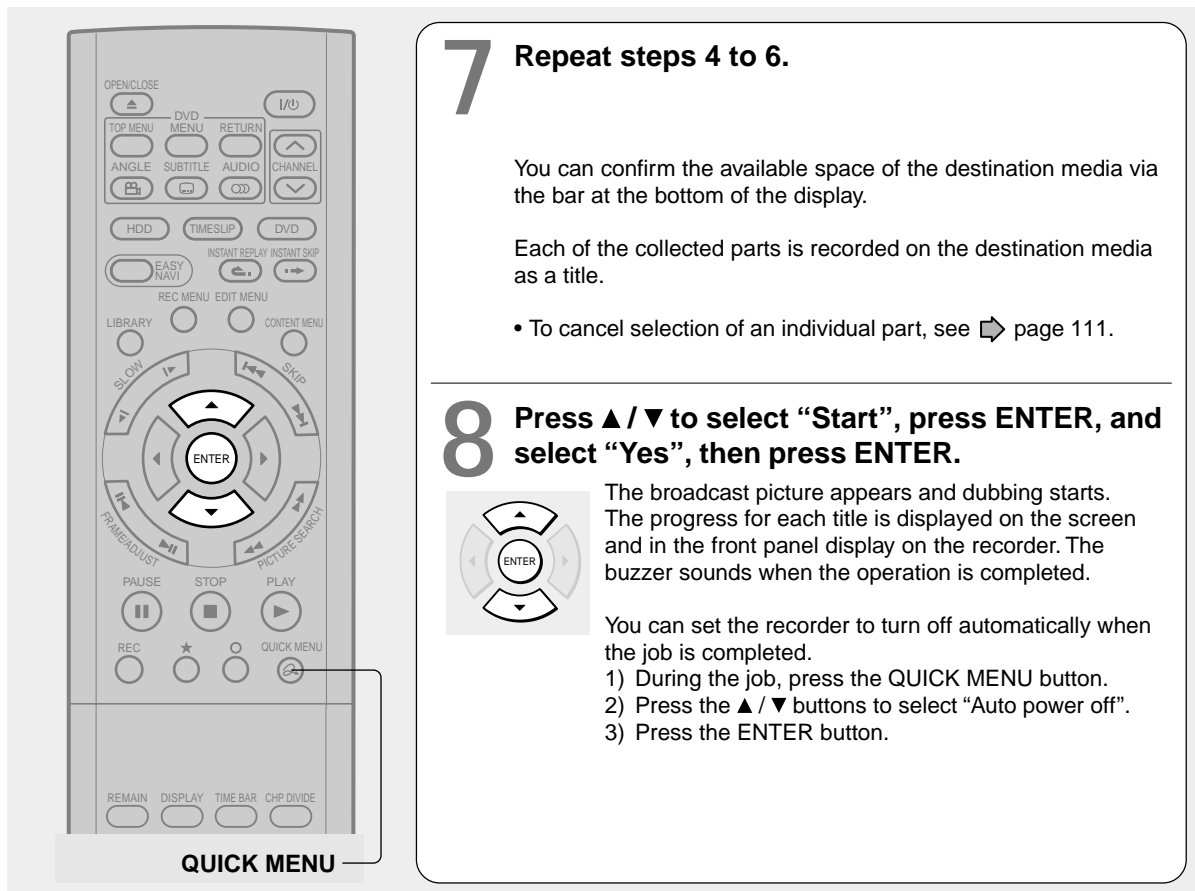

**7 Repeat steps 4 to 6.**

You can confirm the available space of the destination media via the bar at the bottom of the display.

Each of the collected parts is recorded on the destination media as a title.

- To cancel selection of an individual part, see ➡ page 111.

---

**8 Press ▲ / ▼ to select “Start”, press ENTER, and select “Yes”, then press ENTER.**

The broadcast picture appears and dubbing starts. The progress for each title is displayed on the screen and in the front panel display on the recorder. The buzzer sounds when the operation is completed.

You can set the recorder to turn off automatically when the job is completed.

- 1) During the job, press the QUICK MENU button.
- 2) Press the ▲ / ▼ buttons to select “Auto power off”.
- 3) Press the ENTER button.

**Notes**

- This procedure of “Dub Selected Items” of specified parts does not move them. If you do not want to leave the items on the original disc, delete them in the procedure for “Deleting selected items” (➡ page 118).
- To confirm the contents of an item, first select the item by using the ▲ / ▼ / ◀ / ▶ buttons and press the QUICK MENU button to display the Quick Menu. Press the ▲ / ▼ buttons to select “Preview” (or “Title information”) then press the ENTER button.
- Each part, when selected, shows its name at the bottom of the menu for about 2 seconds.
- “High speed dubbing” is not available between the HDD and DVD-R/RW recorded on other equipment.
- Dubbing procedures to DVD-R/RW always comply with “Aspect ratio(Video mode)” setting (➡ page 162).
- Some parts in DVD-R/RW may be divided if dubbed.
- If you record a title directly onto a DVD-R/RW in the DVD-Video mode on this recorder and execute “High speed dubbing” on the title to the HDD, the recorder may display a message to initialize the HDD. In this case, delete the title or execute “All HDD titles delete” (➡ page 163).

## ■ Cancelling selection of an item

- 1) Press **▲ / ▼ / ◀ / ▶** to select an item then press **QUICK MENU**.

The Quick Menu appears.

e.g.

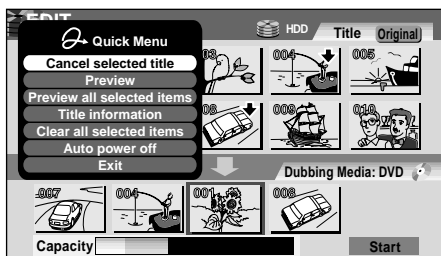

- 2) Press **▲ / ▼** to select “Cancel selected title” (or “All clear” for cancelling selection of multiple items at a time).

- 3) Press **ENTER**.

## ■ Changing the position of an item

Follow the procedure above to cancel selection of the item, then repeat steps 4 to 6 on page 109 to insert the item into its desired location.

## ■ Cancelling during dubbing

Press **QUICK MENU** to display the Quick Menu.

Press **▲ / ▼** to select “Cancel dubbing”, then press **ENTER**.

### Note

- This procedure copies items according to their order indicated in the lower area. Therefore, there may be a case that some items have already been copied at the time you cancel dubbing.

# Rate conversion dubbing (Dubbing at a modified bit rate)

You can reduce the recorded picture or sound rate when copying. This procedure enables content originally recorded onto the HDD at high rate setting to be dubbed onto a DVD-RAM disc at a reduced bit rate.

## Use the Rate conversion dubbing when

- you recorded a lengthy content on the HDD using the manual high rate, and it is too large to dub in the DVD-RAM disc.
- you recorded a title with setting the “DVD compatible mode” (▶ page 162) to “Off”, and you want to make a DVD-R/RW disc for that title, or you used another recorder to record a title in a DVD-RAM disc, and you want to create a DVD-R/RW disc for that title (Set “DVD compatible mode” to “On (Mode I)” or “On (Mode)” then execute this procedure).

The Rate conversion dubbing can be performed in two different ways: **part by part** or **multiple parts in one time**. (To dub multiple parts in one time, the same rate is applied to all parts. You cannot set different rate to each part.)

## ■ Preparation

- Press the HDD or DVD button to select a disc containing the parts that you want to dub.

### Rate conversion dubbing for part by part

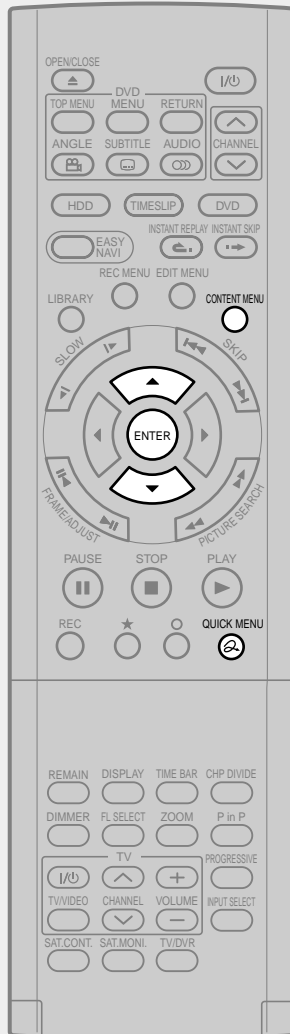

**1** Perform steps 1 and 2 on ▶ page 106.

**2** Press QUICK MENU.

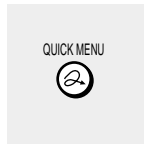

The Quick Menu appears.

**3** Press ▲ / ▼ to select “Rate conversion dubbing”, then press ENTER.

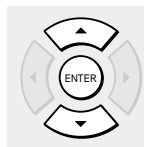

The “CONTENT MENU Rate conversion dubbing” appears.

e.g.

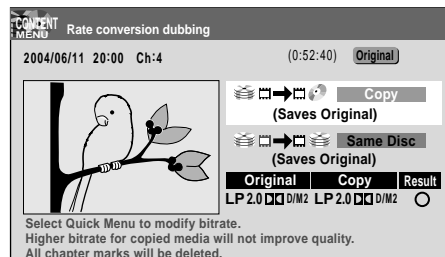



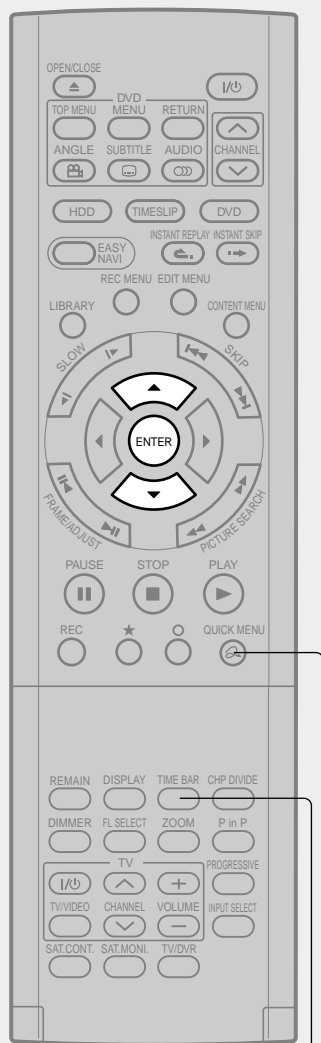

TIME BAR  
QUICK MENU

## 4 Press ▲ / ▼ to select “Copy” or “Same Disc”.

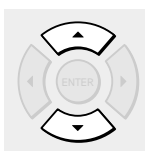

### Copy:

After the operation is completed, a specified part will remain on the disc where it was previously located.

### Same Disc:

A part will be copied to the same disc and the copied part will become another title.

## 5 Confirm picture and sound rates.

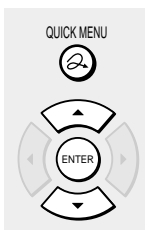

To make changes, follow the procedure below.

- 1) Press the QUICK MENU button to display the Quick Menu.

e.g.

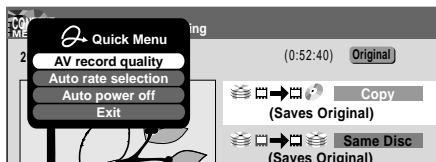

- 2) Press the ▲ / ▼ buttons to select an item then press the ENTER button.

### AV record quality:

The current settings you have made (▶ page 161) are listed. Press the ADJUST (◀▶) button to select a desired setting.

### Auto rate selection:

The recorder automatically selects the highest possible rate, calculating from current unoccupied volume on the disc. (This operation does not insure full recording of any length program or whole use of unoccupied volume.)

## 6 Press ENTER.



Copying starts.

To confirm the job progress, press the TIME BAR button to display the time bar. (The time bar cannot be copied.) When copying is completed, the buzzer sounds and the current broadcast picture appears.

Pictures and sounds displayed during copying are for monitoring purposes only. Recorded picture quality may vary.

## Rate conversion dubbing for multiple parts

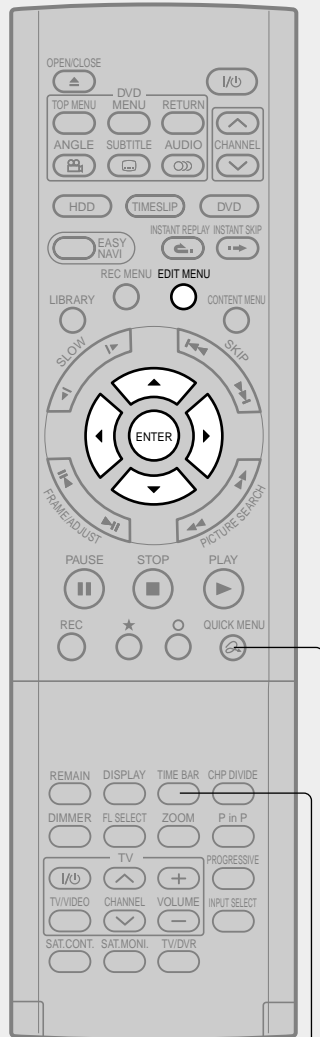

TIME BAR  
QUICK MENU

### 1 During playback or stop, press EDIT MENU.

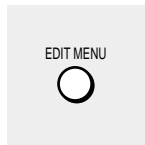

The "EDIT MENU Main Menu" appears.

### 2 Press ▲/▼ to select "Rate Conv. Items", then press ENTER.

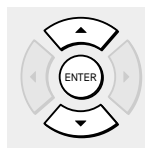

The "EDIT MENU Rate Conv. Items" appears.

e.g.

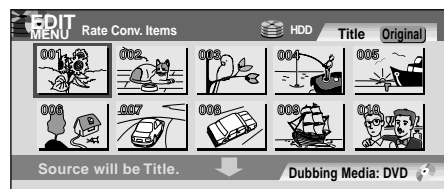

### 3 Collect parts to be dubbed, using steps 4 to 6 on [page 109](#).

Each of the collected parts is recorded on the destination media as a title.

You can cancel selection of an individual part.

- 1) Press the ▲/▼/◀/▶ buttons to select an item then press the QUICK MENU button.  
The Quick Menu appears.
- 2) Press the ▲/▼ buttons to select "Cancel selected title" (or "All clear" for cancelling selection of multiple items at a time).
- 3) Press the ENTER button.

### 4 Check the rate for picture and sound quality.

To change the setting, perform the following steps.

- 1) Press the QUICK MENU button to display the Quick Menu.
- 2) Press the ▲/▼ buttons to select "AV record quality" and press the ENTER button.
- 3) Press the ADJUST (◀◀/▶▶) button to select the setting number and press the ENTER button.

When "Copy" on the bottom shows "X", the selected parts are beyond the disc capacity. Change the rate for picture and sound quality or reduce parts to dub.

## 5 Press ▲/▼ to select “Start”, and select “Yes”, then press ENTER.

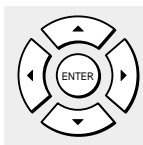

Copying starts.

To confirm the job progress, press the TIME BAR button to display the time bar. (The time bar cannot be copied.) When copying is completed, the buzzer sounds and the current broadcast picture appears.

Pictures and sounds displayed during copying are for monitoring purposes only. Recorded picture quality may vary.

### ■ Cancelling dubbing during rate conversion dubbing

- 1) Press QUICK MENU.
- 2) Press ▲ / ▼ to select “Cancel dubbing”.
- 3) Press ENTER.

#### Note

- A portion of content from the start of recording to the moment you cancel dubbing will be copied.

### ■ Turning off the power automatically after dubbing

- 1) During dubbing, press QUICK MENU.
- 2) Press ▲ / ▼ to select “Auto power off”.
- 3) Press ENTER.

#### Notes

- Unlike High speed dubbing, Rate conversion dubbing may cause slight deterioration in picture and sound quality of recorded content. The time required for dubbing is about the same as the playback time of the content.
- Quality will not be improved even if you select a rate higher than original content.
- Chapter marks are not copied.
- Rate conversion dubbing to the same DVD-RAM/R/W disc is not possible.
- The recorder automatically inserts a black picture for a moment before and after the new title produced by this recording process.
- You cannot use the Rate conversion dubbing for copying from a DVD-RAM disc to another DVD-RAM disc.
- During Rate conversion dubbing, the relay recording function (▶ page 48) is disabled even if “Relay recording” (▶ page 162) is set to “On”.
- During Rate conversion dubbing, switching the audio channel is not possible.
- Audio processed under the Rate conversion dubbing is recorded in stereo.

- When you record a NICAM programme and play it back, the left and right channels are output at the same time. Select the sound by pressing the AUDIO button.
- When you set “DVD compatible mode” to “On (Mode I)” or “On (Mode II)” (▶ page 162), only a selected sound (the left and right channels) of the NICAM programme is recorded. (Stereo broadcasting is recorded as stereo).
- If you perform the Rate conversion dubbing for a Playlist, containing a chapter that is the beginning of the Original title at recording, one frame at the beginning will be removed.
- During Rate conversion dubbing, P in P function (▶ page 69), zoom function (▶ page 72), “Custom picture select” (▶ page 157) and “Play DNR” (▶ page 158) are disabled.
- Rate conversion dubbing to DVD-R/RW selects aspect ratio according to the first title of dubbed items.
- Each part, when selected, shows its name at the bottom of the menu for about 2 seconds.

# Line-U dubbing (Recording pictures while viewing them)

You can record the picture being played back in either disc, or to the other disc, if the content is not copy-protected. This procedure can be used also to copy contents of a DVD-R/RW you created (➔ page 122), back to the HDD.

## ■ Preparation

- Make sure that the destination disc has adequate available remaining space.
- When you want to copy to the HDD, load a disc you want to play.

**Example: To copy from a DVD-RAM disc to the HDD**



## 1 Press INPUT SELECT or CHANNEL repeatedly to select "LineU."

A black screen appears.

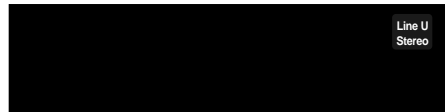

## 2 Press HDD.



## 3 Press REC.

Recording starts.



## 4 Press DVD.



## 5 Start playing.



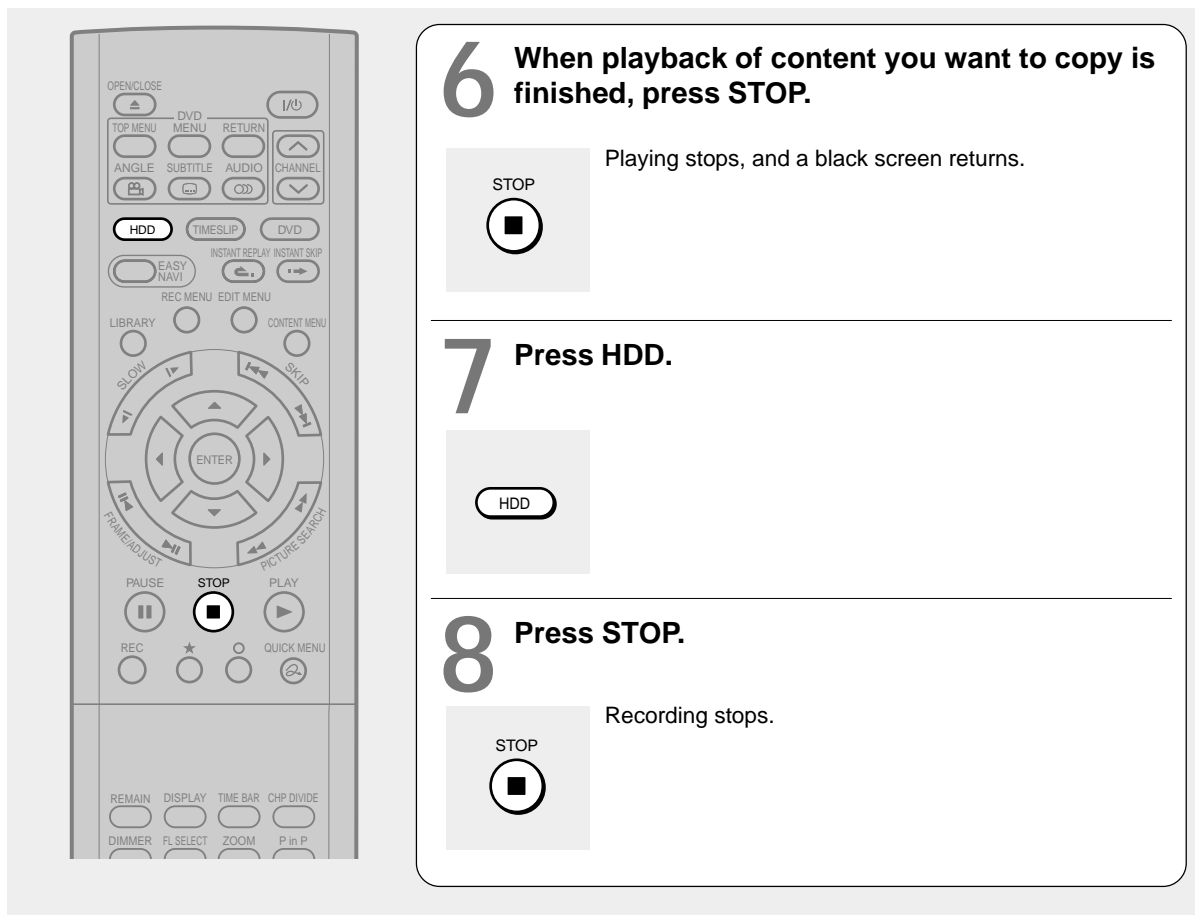

### Notes

- The following combinations of a source and a destination disc are possible.  
HDD to HDD, HDD to DVD-RAM, HDD to DVD-R/RW, DVD-RAM to HDD, DVD-R/RW to HDD
- A title dubbed by this procedure has black pictures at both the beginning and the end of the title. Therefore thumbnails in the "CONTENT MENU" may be black. If you change the thumbnail, see [➡ page 100](#).
- You can record still pictures and slow pictures during playback.
- Contents of DVD VIDEO, VIDEO CD, and audio CD cannot be recorded with Line-U dubbing.
- Line-U dubbing may cause slight deterioration in picture and sound quality of contents.
- Screen menus such as "CONTENT MENU" or "REC MENU" cannot be recorded with Line-U dubbing.
- "Line-U dubbing" cannot be set as programme recording.
- When doing this procedure, programme recording must not be initiated. If you display the "REC MENU", playback is automatically cancelled.
- When setting the input to "Line-U", audio output is set to stereo automatically. You cannot switch the audio channel. During Line-U dubbing, you can change the audio output.
- Accompanying audio content to be recorded with Line-U dubbing is always in stereo.
- During Line-U dubbing, the virtual surround function ([➡ page 158](#)) is disabled.
- Even if "Relay recording" is set to "On" ([➡ page 162](#)), the relay recording function is disabled during Line-U dubbing.
- For Line-U dubbing, a scene permitting copy-once cannot be copied.
- During Line-U dubbing, P in P function ([➡ page 69](#)), zoom function ([➡ page 72](#)), "Custom picture select" ([➡ page 157](#)) and "Play DNR" ([➡ page 158](#)) are disabled.

# Deleting selected items (Deleting multiple specified parts)

This section explains how to simultaneously delete unnecessary titles and chapters.  
 On a finalized DVD-R/RW disc, this feature is not possible.

## ■ Preparation

- Press the HDD or DVD button to select a disc that contains titles or chapters you want to delete.



HDD/DVD

## 1 During playback or stop, press EDIT MENU.



The "EDIT MENU Main Menu" appears.

## 2 Press ▲ / ▼ to select "Del Selected Items".

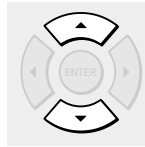

e.g.

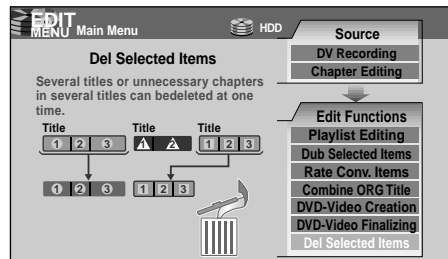

## 3 Press ENTER.

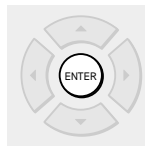

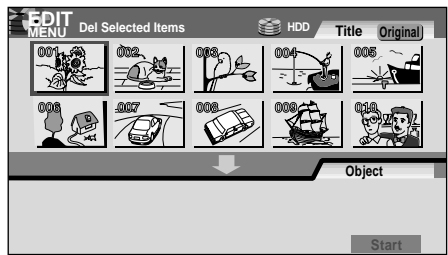

The "EDIT MENU Del Selected Items" appears.

e.g.

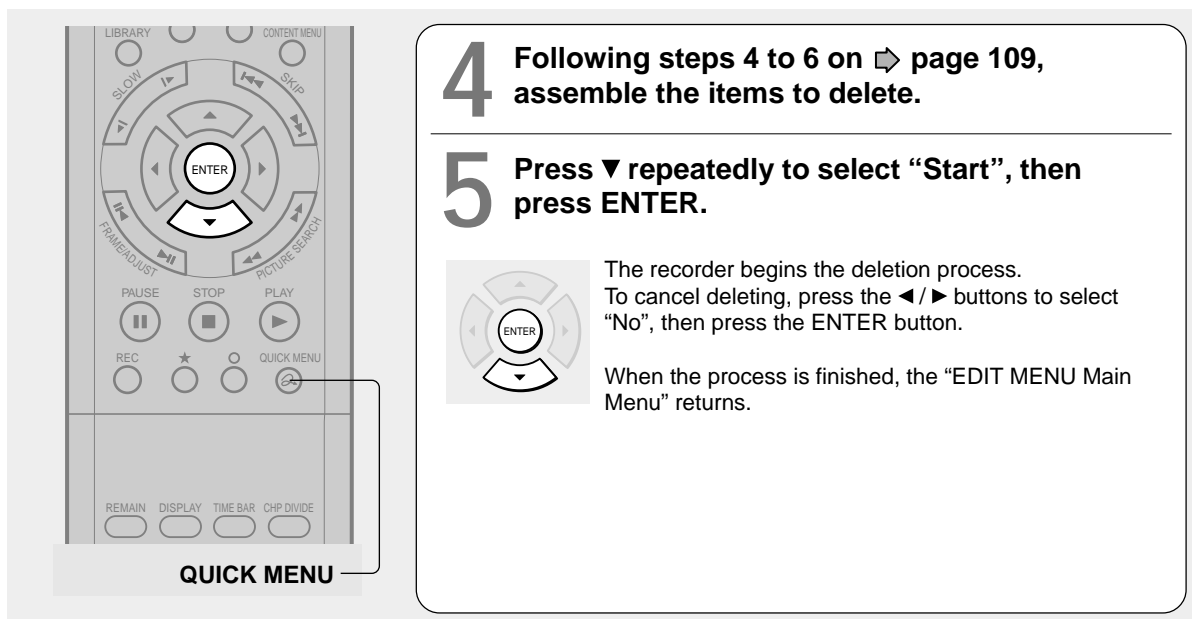

Thumbnails of the parts in the disc are displayed in the upper area.



**4** Following steps 4 to 6 on  page 109, assemble the items to delete.

**5** Press ▼ repeatedly to select “Start”, then press ENTER.

The recorder begins the deletion process. To cancel deleting, press the ◀/▶ buttons to select “No”, then press the ENTER button.

When the process is finished, the “EDIT MENU Main Menu” returns.

**QUICK MENU**

### Notes

- To confirm the first and last scenes of an item, first select an item then press the QUICK MENU button. Press the ▲ / ▼ buttons to select “Preview” (or “Title information”) then press the ENTER button. This is available only on contents recorded in the HDD or DVD-RAM discs.
- Titles and chapters show their names for about 2 seconds at the bottom of the screen when they are selected.
- On a DVD-RW disc, deleting can restore the disc space only by deleting the last recorded title.
- Deleting cannot be cancelled once started. Be careful when executing the deletion process.
- If you select a title for the part to be removed, you cannot select chapters in that title.
- Chapters in DVD-R/RW discs cannot be selected to delete.

# Combine Original titles (Combine two titles into one)

Use this feature to combine two titles into one. The second title is deleted as the second title is added to the end of the first title.

## ■ Preparation

- Press the HDD or DVD button to select a disc that contains titles or chapters you want to merge.

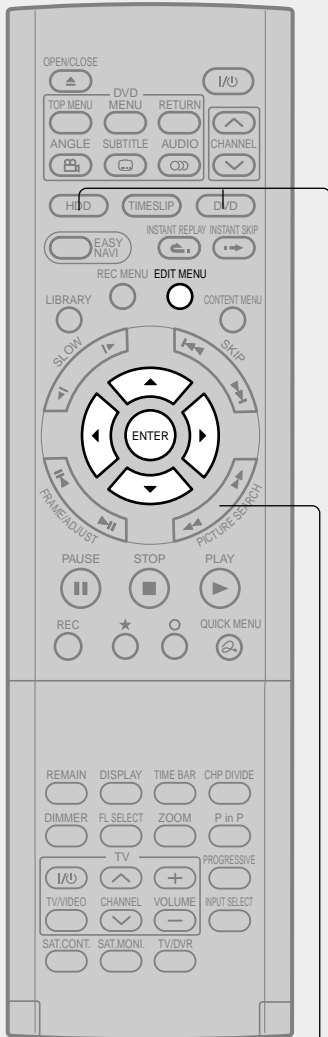

PICTURE SEARCH

HDD/DVD

## 1 During playback or stop, press EDIT MENU.



The "EDIT MENU Main Menu" appears.

## 2 Press ▲/▼ to select "Combine ORG Title", then press ENTER.

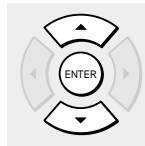

The "EDIT MENU Combine ORG Title" display appears.

e.g.

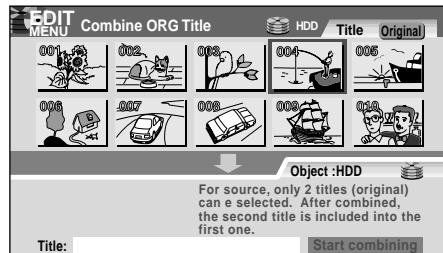

## 3 Press ◀/▶ to select the first title to merge.

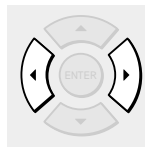

Press the PICTURE SEARCH button to move to the previous or next page.

## 4 Press ENTER.



The cursor appears in the lower area of the screen (the title to merge to).

Cursor

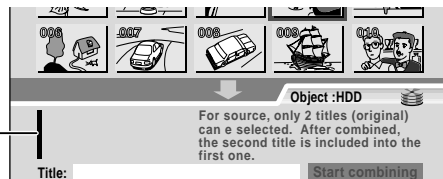



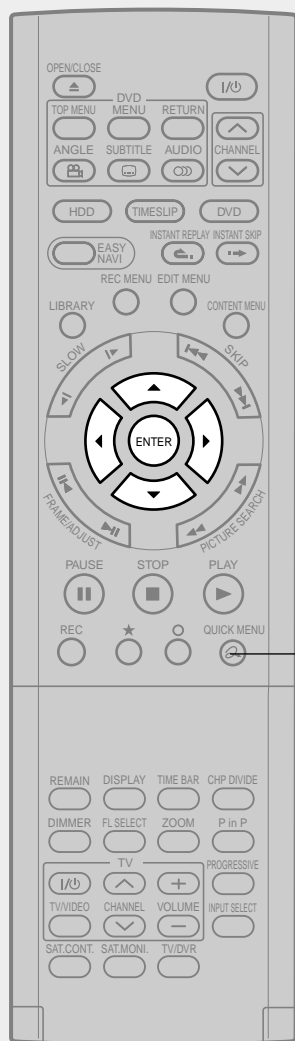

QUICK MENU

## 5 Press ◀/▶ to select the location to put the part and press ENTER.

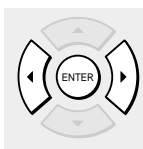

It is fixed at the left side at the beginning. Press the ENTER button. The selected part moved into the location of the cursor.

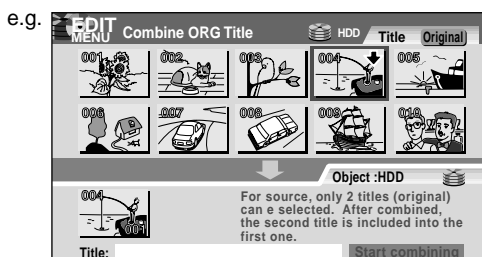

## 6 Perform steps 3 to 5 and select the second title.

You cannot select the same title.

To cancel the registered part:

- 1) Select the part that you want to cancel, and press the QUICK MENU button to display the Quick Menu.
- 2) Press the ▲/▼ buttons to select “Cancel selected title” (or “Clear all selected items” for cancelling the selection of multiple items at a time).
- 3) Press the ENTER button.

## 7 Press ▲/▼ to select “Start combining” and press ENTER, then select “Yes” and press ENTER.



The combining process starts.

### Notes

- You cannot stop the combining process after it has started.
- You cannot combine titles if their length will exceed 8 hours.
- You cannot combine a protected title or a title containing still pictures.
- The title name of the first title is given to the title after combining.
- The second title is combined into the first title, maintaining the chapter divisions and chapter names.
- Titles and chapters show their names for about 2 seconds at the bottom of the screen when they are selected.

# Creating a DVD-Video using DVD-R/RW

Content stored on the HDD of the recorder can be edited and copied to a DVD-R, a popular media for distribution, and played on a compatible DVD video player. Rewriteable DVD-RW are also available.

## Caution

- **Beforehand confirm the content in the disc.**

If you use a DVD-R, prepare a new one. This DVD-Video creation procedure is possible only once per disc on this recorder. Once you have copied to a DVD-R, you cannot redo it, add, delete, or correct the copied contents in the disc. If you start copying then cancel the job, you cannot re-use the DVD-R.

If you use a DVD-RW, be sure to confirm contents in it. This procedure overwrites a whole disc, and all contents in a DVD-RW will be lost. If you want to add contents to a DVD-RW, do not use this procedure. Record directly or make a dubbing to the DVD-RW, then execute the finalization (➡ page 132). This procedure includes the finalizing process, and you will not be able to add, delete, or correct contents to a DVD-RW later, as it will have been finalized. If a finalized DVD-RW has remaining space, you can add contents there if you cancel the finalizing process of the DVD-RW (➡ page 135).

- **Do not start copying to a DVD-R/RW when a programmed recording is scheduled to begin shortly.**

Copying entirely to a DVD-R/RW will take 1 hour and a half (variable depending on the contents). (This does not include time for "Writing Test". This option requires more time. Actual time for "Writing Test" depends on the contents to test, and may be longer than the playing time of the contents if the disc contains too little contents or too many quality and picture settings, etc.)

If a start time of a programmed recording comes during this procedure, the recording is made onto the HDD. However, while making a menu theme, the recording is not executed. Also, programmed recordings to DVD media with "Off" setting of "Relay recording" (➡ page 162) are not executed.

If a programmed recording starts during this procedure, you cannot continue to make one more discs after completion of the first disc.

- **Ensure the compatibility of a disc.**

Refer to the ➡ page 9.

- \* Discs made by this procedure will comply with the DVD-Video standard. However, it is not guaranteed to play properly on all DVD video players (including TOSHIBA products).

Depending on the disc, there may be a difference of data capacity between DVD-R and DVD-RW. It may be possible that contents you have just recorded onto a DVD-R cannot be recorded onto a DVD-RW. (DVD-RW capacity may be smaller.)

- **Follow the instructions on handling of the disc.**

## ■ Preparation

- Record contents which you want to copy to DVD-R/RW to make DVD-Video, to the HDD with the following settings:
  - "DVD compatible mode" (➡ page 162): "On (Mode I)" or "On (Mode II)".
  - Bit rate of 4.0 or more.
- Load a new DVD-R or a DVD-RW. (Follow the instructions on handling of the disc.)
- Press the HDD button to select the HDD mode.

## Notes

- If you recorded a title while setting "DVD compatible mode" (➡ page 162) to "Off" or you used another recorder to record a title in a DVD-RAM disc, and you want to copy such a title to a DVD-R/RW to create a DVD-Video, first set "DVD compatible mode" to "On (Mode I)" or "On (Mode II)" then execute the procedure of "Rate conversion dubbing" (➡ page 112).
- Depending on the disc, DVD-R 4X speed compatibility may be disabled.

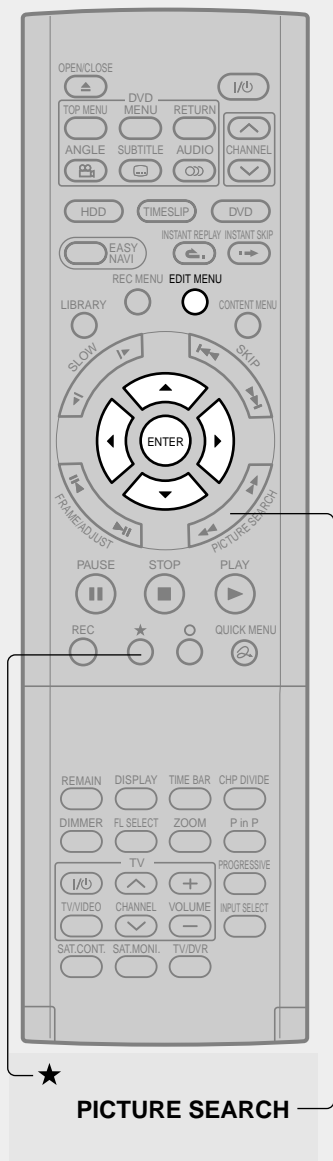

# 1 Press EDIT MENU.

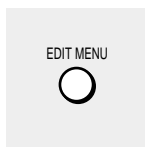

The "EDIT MENU Main Menu" appears.

e.g.

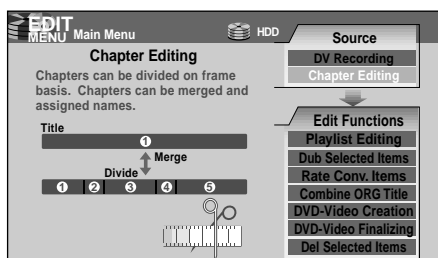

# 2 Press ▲/▼ to select "DVD-Video Creation", then press ENTER.

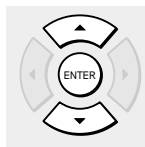

The "EDIT MENU DVD-Video Create (Selected Items)" appears.

e.g.

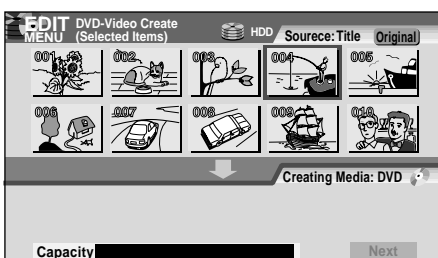

Thumbnails of titles on the HDD are displayed in the upper area.

# 3 Press ▲/▼/◀/▶ to select a part (a title or chapter) to copy to the DVD-R/RW.

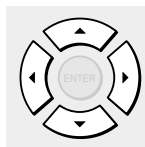

- To go to the preceding or following page, press the PICTURE SEARCH button.
- To select a chapter, first select the title that contains the chapter you want, then press the ★ button. To return to the title display, press the ★ button again.

e.g.

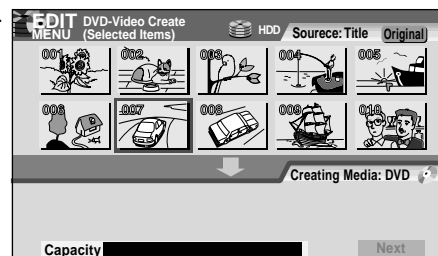

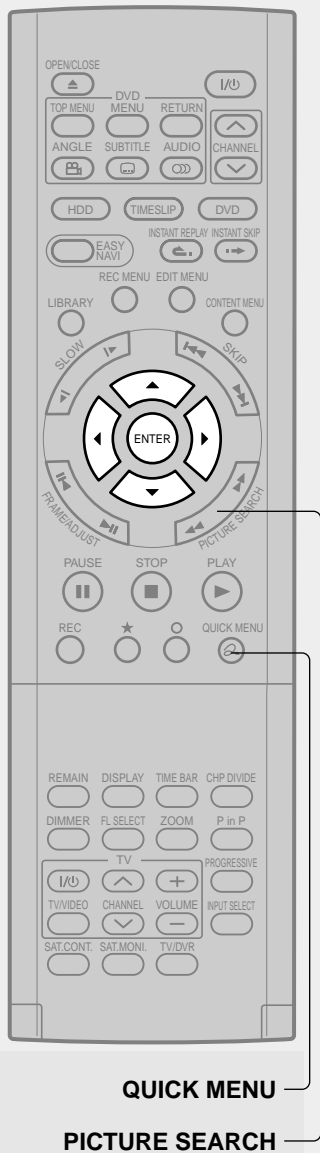

## 4 Press ENTER.



A cursor appears in the lower area (destination media).



Cursor

## 5 Press ◀/▶ to select a location to place the selected part, then press ENTER.

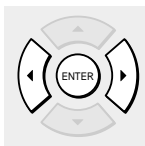

If there are no parts in the lower area, leave the cursor to the left and press the ENTER button.

The selected part is inserted into the location of the cursor.



## 6 Repeat steps 3 to 5.

You can confirm the available volume of a DVD-R/RW on the bar at the bottom of the menu.

Each of the assembled parts is recorded onto the destination media as a title.

- To cancel selection of a part, see ➡ page 130.
- To change the title/chapter name or thumbnail before selection:
  - 1) Select the part that you want to change, and press the QUICK MENU button.
  - 2) Press the ▲/▼ buttons to select “Edit title name” or “Modify title thumbnail” to change the title, or “Edit chapter name” or “Modify chapter thumbnail” to change the chapter, and press the ENTER button.
  - 3) Use the entry screen to change the title or chapter name. To change a title thumbnail or a chapter thumbnail, see the steps on ➡ page 100.



## 7 Press ▲ / ▼ to select “Next”, then press ENTER.

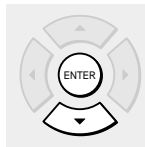

A screen is displayed to select options.

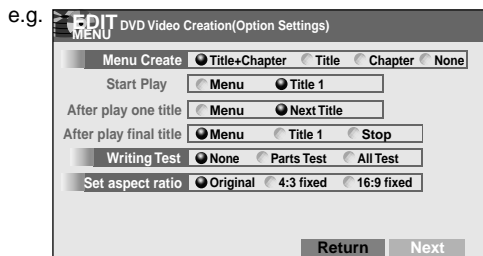

## 8 Press ▲ / ▼ / ◀ / ▶ to set the items.

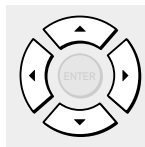

For the instruction of setting, see the description shown at selection.

- When you have selected “Parts Test” or “All Test” for “Writing Test”, extra time is required for pre-writing test. “All Test” requires more time than “Parts Test”. If a DVD-RW is used, the recorder regards “All Test” selection as “Parts Test” to execute the test.

If you select “None” for “Menu Create”:  
The setting of “Start Play” and “After play one title” is skipped automatically.

## 9 Press ▲ / ▼ to select “Next”, then press ENTER.

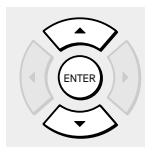

A screen is displayed to confirm the information you are going to write.



Press the ▲ button to select “Edit Name” and press the ENTER button to go to the character entry screen. The number of characters is limited for the disc name you can enter.

If you selected “None” for “Menu Create” at step 8, select “Writing” on the bottom right corner, and press the ENTER button. Skip to step 14.

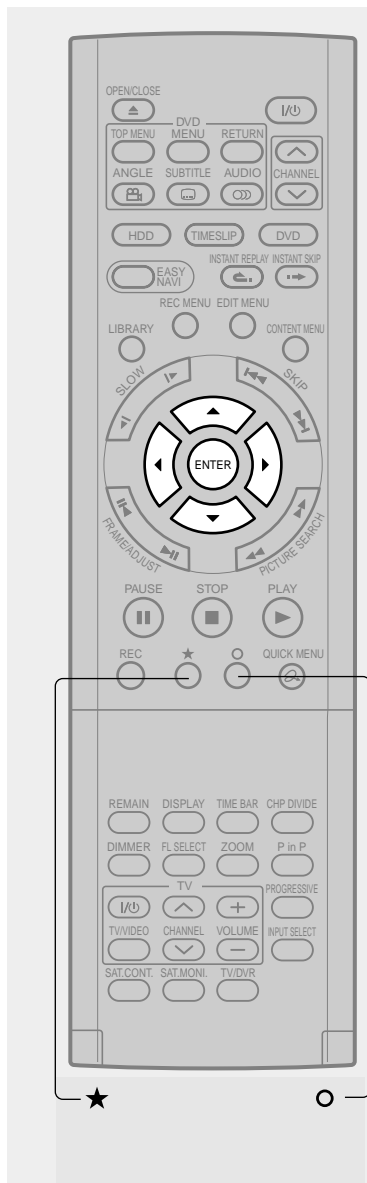

## 10 Press ▼ to select “Next”, then press ENTER.



A display of title menu selection appears if “Menu Create” is set to “Title+Chapter” or “Title” at step 7.

To view your captured images (➡ page 129), go to the next page.

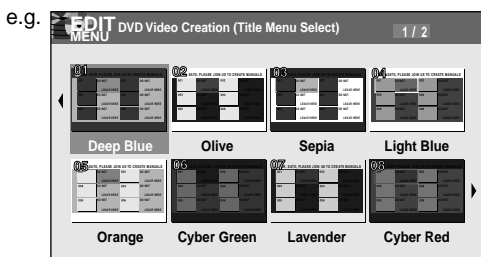

If you press the ★ button, you can preview the selected menu. To return, press the O button.

While displaying a preview screen of your captured image, you can access the other menu to correct colour (➡ page 129) by pressing the ★ button.

## 11 Press ▲ / ▼ / ◀ / ▶ to select the menu, then press ENTER.

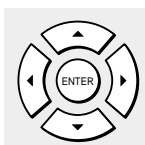

If you have set “Menu Create” to “Title+Chapter” or “Chapter” at step 7, a screen is displayed to select a chapter menu.

## 12 Press ▲ / ▼ / ◀ / ▶ to select the chapter menu.

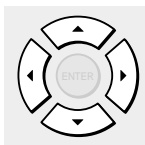

The selected menu is set for all chapters. You cannot set it for each chapter individually.

If you press the ★ button, you can preview the selected menu. To return, press the O button.

If you press the ▼ button to select “Return” while previewing and press the ENTER button, you will return to the preview of the title menu. To go back to the chapter menu, press the ▲ / ▼ / ◀ / ▶ button to select a number next to “Chapter Menu” on the bottom center.

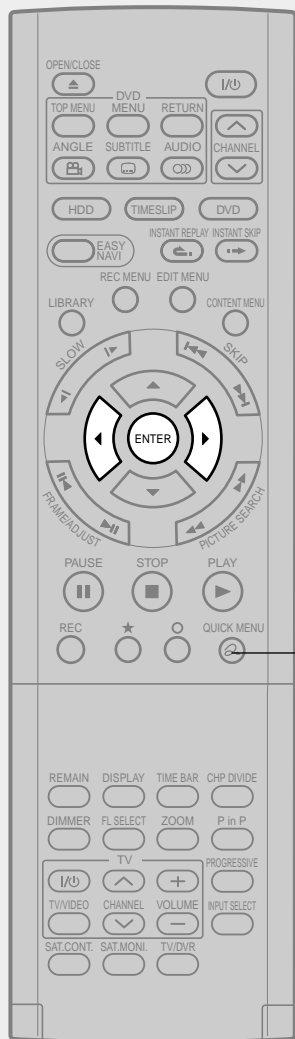

**QUICK MENU**

## 13 Press ENTER on the “EDIT MENU DVD Video Creation (Chapter Menu Select)” display.

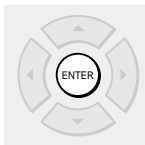

A confirmation message is displayed.

## 14 Press ◀/▶ to select “Yes”, then press ENTER.

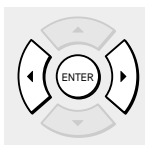

The current broadcast picture appears and dubbing starts. The progress is displayed on the screen and in the front panel display on the recorder.

When copying is completed, a finalizing process follows. This enables the disc to be played on a DVD video player.

When the process is completed, a message “Create another DVD-Video now?” appears (except when “Auto power off” (see below) is set). If you select “Yes”, you can make one more DVD-R/RW of the same content. If you select “No”, you can complete creating the DVD-Video.

- You can set the recorder to turn off automatically when the job finishes.
  - 1) During the job, press the QUICK MENU button.
  - 2) Press the ▲/▼ buttons to select “Auto power off”.
  - 3) Press the ENTER button.

**Notes**

- The number of titles that you can write on a DVD-R/RW is limited (99 titles. Each title should have 99 chapters or less). If you have a large number of titles or chapters, you may not be able to write due to the limitation of the DVD specifications. Also, even if the number of titles and chapters is within the limit, you may not be able to write if you have a large number of menu items.
- Due to standard differences, the number of chapters and their position may change slightly after DVD-Video creation. (For chapters generated on the DVD-R/RW, the same thumbnail for the Original chapter is displayed.)
- Due to standard limitation, DVD-R/RW may contain unnecessary scenes after creation.
- If you select items of various types of video outputs, aspect ratios or other properties, or if you select an item recorded with different settings, they may be divided into titles. (For titles generated on the DVD-R/RW, the same thumbnail for the Original title is displayed.)
- Content based on a complicated Playlist or composed of too many items may not be copied properly.
- Copy-once permitted contents cannot be copied to a DVD-R/RW, even if they are recorded onto the HDD while "DVD compatible mode" is set to "On (Mode I)" or "On (Mode II)" (➡ page 162).
- Content recorded on a recorder other than this recorder (including TOSHIBA products) cannot be copied to a DVD-R/RW using High speed dubbing. First set "DVD compatible mode" to "On (Mode I)" or "On (Mode II)" and record them onto the HDD. Then perform "Rate conversion dubbing" (➡ page 112) to copy to the HDD.
- When a content is recorded with manual rate 1.4 Mbps and is including a 16:9 picture shape scene, the DVD creation of the content may failure. In this case, set "Set aspect ratio" to "4:3 fixed" on the menu "(Option Settings)".
- Even if the title is recorded with "DVD compatible mode" set to "On (Mode I)" or "On (Mode II)", using a recorder other than this may cause failure when recording to a DVD-R/RW.
- If the DVD-R creating fails to be completed, most of the discs cannot be used again.
- If an error occurs while a DVD-Video is created, the error code "ERR-\*\*" (\*\* indicates the error code) is shown in the front panel display of the recorder. (➡ page 169) To clear this display, press the DISPLAY button.
- There may be a difference between a specified thumbnail of menu in the DVD-Video creation procedure and the one on displayed in the "CONTENT MENU".

**■ Selecting the items displayed on the menu**

You can hide items on the menu if necessary.

**To hide a disc name**

Leave "Disc Name" blank. Display the on-screen keyboard and press the CLEAR button to delete letters, then press the ★ button to save.

**To hide a page number**

Leave "Disc Name" blank. Follow the above method.

**To hide a disc name and show a page number**

Enter one more space in "Disc Name".

**To hide a title/chapter name**

On the "CONTENT MENU" or a display of item selection, select a title/chapter and display the on-screen keyboard from the Quick Menu. Erase all characters of the name.

You can hide a time also using the same manner.

- "Chapter 0001" . . . on the "CONTENT MENU" means that the chapter is given no characters as its name. Such a chapter does not show the name on the menu.
- A chapter menu shows the title name at the top right corner. If you hide the title name, no character appears in this area.

**To hide a title/chapter name and show a time**

Enter one more space and save it as the title/chapter name.

**Note**

- You cannot hide items other than above.



## ■ Using a favorite scene as a menu

You can select favorite scenes from the recorded contents and use them as menus of DVD-Video Created (➡ page 126) DVD-R/RW.

- 1) During stop or playback, press **CONTENT MENU**.
- 2) Press **▲ / ▼ / ◀ / ▶** to select a title which contains a scene to use as menus.
- 3) Press **QUICK MENU**.
- 4) Press **▲ / ▼** to select “Save captured images”.
- 5) Select a scene.  
Locate a scene using the buttons such as PLAY, SLOW, FRAME or PAUSE, etc.
- 6) Press **▲ / ▼** to select “Loading” and press **ENTER**.

e.g.

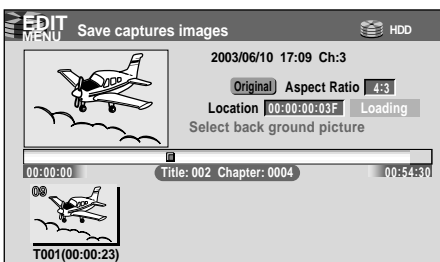

### Note

- You cannot capture copy-protected contents.
- The maximum number of pictures which can be saved varies depending on the data size.

## ● To name a captured image

Press **▲ / ▼ / ◀ / ▶** to select an image to name then press **QUICK MENU**. Press **▲ / ▼** to select “Enter DVD-Video menu name” then press **ENTER**.

e.g.

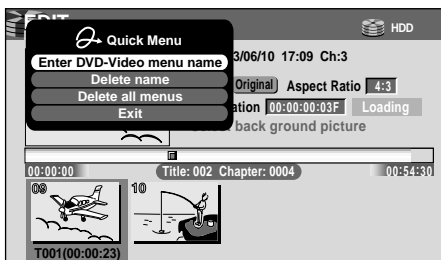

The on-screen keyboard appears.  
Enter a name.

## ● To delete a captured image

Press **▲ / ▼ / ◀ / ▶** to select an image to delete then press **QUICK MENU**. Press **▲ / ▼** to select “Delete menu” then press **ENTER**. Follow the message to operate.

To delete all captured images, select “Delete all menus”.

## ■ Selecting colour options on menus

Several options are available: a translucent background for better legibility, character colour and cursor colour selections.

- 1) At step 10 (➡ page 126), go to the next page and select a captured image by **▲ / ▼ / ◀ / ▶**, then press **★**.

The preview screen appears.

- 2) Press **★**.

A colour setting display appears.

e.g.

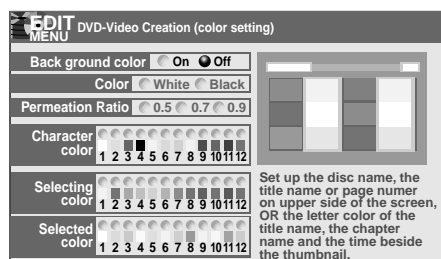

- 3) Set each item by **▲ / ▼ / ◀ / ▶**, referring to the guidance on the right half of the display, finally press **○** to exit.

The preview screen returns.

- **To improve legibility of characters on menus**  
Press ▲ / ▼ / ◀ / ▶ to set "Back ground color" to "On". Then select "Color" ("White" or "Black") according to the menu's tone, and set "Permeation Ratio", which sets how translucent the selected Back ground color is. The higher the ratio, the Back ground color will be more translucent but the lower legibility of characters.

- **To change the character colour**  
Press ▲ / ▼ / ◀ / ▶ to select from 12 colours. When you select "White" back ground colour, dark colour should be a better choice.

- **To change the cursor colour**  
"Selecting Color" is a colour for moving cursor. "Selected Color" is one for press of the ENTER button.

- **To preview your selections**  
Press the O button to return to the preview screen. If you correct your selections, repeat steps 2) and 3) (➡ page 129).

### ■ Cancelling selection of an item

- 1) Press ▲ / ▼ / ◀ / ▶ to select an item then press **QUICK MENU**.

The Quick Menu appears.

e.g.

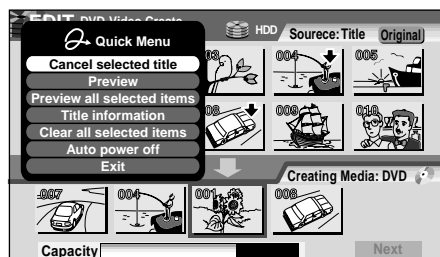

- 2) Press ▲ / ▼ to select "Cancel selected title" (or "Clear all selected items" for cancelling selection of all items at a time).

- 3) Press **ENTER**.

The selected item disappears.

### ■ Changing the location of an item

Follow the procedure above to cancel selection of the item, then repeat steps 3 to 5 to re-insert the item in a desired location (➡ page 123, 124).

### ■ Confirming the content in the lower area

Select an item and press **QUICK MENU**. Then press ▲ / ▼ to select "Preview" and press **ENTER**.

#### Notes

- Each time an item is selected, its name appears at the bottom of the screen.
- You can also confirm the content by selecting "Title information" from the Quick Menu.

### ■ Cancelling dubbing process

Press **QUICK MENU** to display the Quick Menu. Press ▲ / ▼ to select "Stop creating DVD video", then press **ENTER**.

#### Notes

- To cancel creating a DVD-R will render the loaded DVD-R useless.
- Cancelling is not always possible.

### ■ If a message appears while selecting a part

You may receive a message, such as "Selection of Writing Test in the next option setting is recommended to check whether Aspect Ratio coexists". If a copy-prohibited content is included, or if the aspect ratio is changed meanwhile, cancel the selection. If you are not sure, select "Writing Test" ("Parts Test" or "All Test").

#### Note

- Depending on selection or condition of items, copying may result in failure. If a message appears, be sure to, prior to step 7, press the QUICK MENU button. Then press the ▲ / ▼ buttons to select "Cancel selected title", and press the ENTER button. If you do not do this and continue the copying process, an error may occur and the disc will be rendered useless.

## Playing a created DVD-Video

You can play the DVD-R/RW in the same manner as you would play a DVD video disc.

See ➡ page 60.

### ■ If you want to correct the contents of a DVD-RW after the DVD-Video creation procedure

Cancel the finalization of the DVD-RW (➡ page 135). It is possible only on DVD-RW recorded on this recorder.

After cancelling, you can delete titles. However, you cannot re-use the whole disc, since only the last title can restore the disc space.

### ■ If you want to delete all contents of a DVD-RW after the DVD-Video creation procedure

Load the DVD-RW into the recorder and initialize it, then execute the procedure of DVD-Video creation (➡ page 122).

# DVD-Video finalizing process

The recorder processes recorded data in a DVD-R/RW disc so that it can be played on other compatible devices.

## Important

- You cannot rewrite data onto a disc after you execute the DVD-Video finalizing process. However, the disabled rewritability of a DVD-RW disc can be restored by cancelling the process of the disc (▶ page 135). On DVD-R discs, cancelling of the DVD-Video finalizing process is not available.
- Cancelling of the DVD-Video finalizing process is available only on DVD-RW recorded or copied contents on this recorder.

## ■ Preparation

- Press the DVD button to select the DVD mode.
- Load a DVD-R/RW disc you want to execute the finalizing process.



## 1 During playback or stop, press EDIT MENU.



The "EDIT MENU Main Menu" appears.

## 2 Press ▲ / ▼ to select "DVD-Video Finalizing".

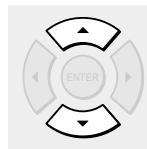

e.g.

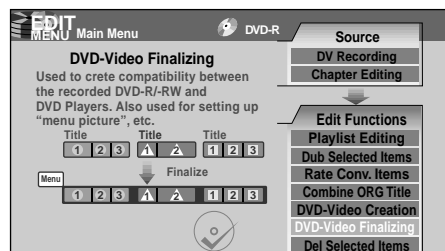

## 3 Press ENTER.



A display of option settings appears.

e.g.

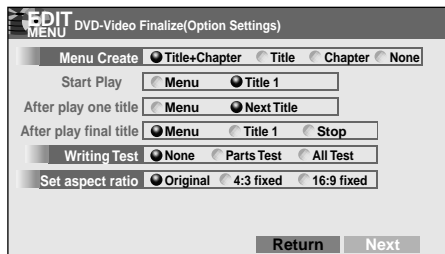

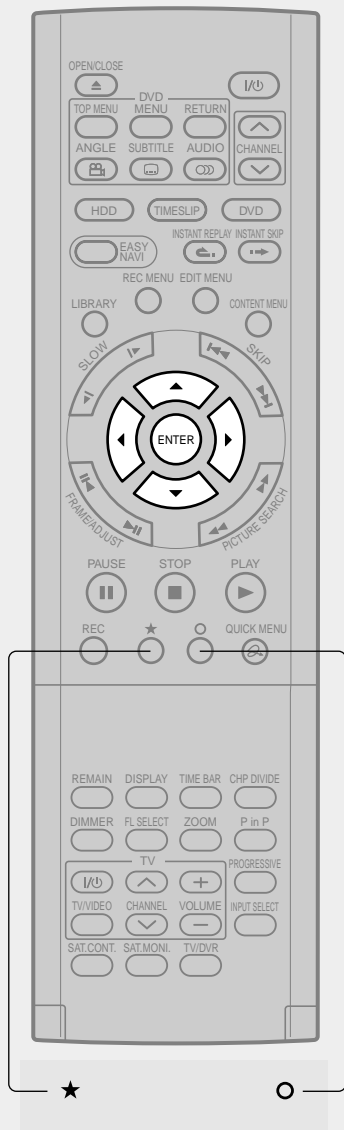

## 4 Press ▲/▼/◀/▶ to select.

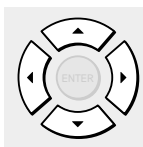

As you select each item, its function is explained.

When “Menu Create” is set to “None”:  
“Start play” and “After play one title” are automatically omitted.

## 5 Press ▲/▼ to select “Next”, then press ENTER.

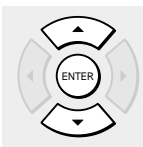

Information on data to be processed appears.

e.g.

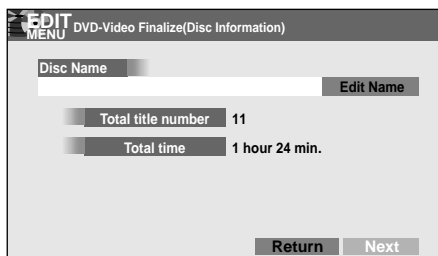

If you press the ▲ button to select “Edit Name” then press the ENTER button, a keyboard appears so that you can enter a title name.

When “Menu Create” is set to “None”:  
Select “Writing” at the right bottom by the ▲/▼/◀/▶ buttons and press the ENTER button. Skip to step 10.

## 6 Press ▼ to select “Next”, then press ENTER.



When “Menu Create” is set to “Title+Chapter” or “Title”, a display of title menu selection appears.

To view your captured images (➡ page 129), go to the next page.

e.g.

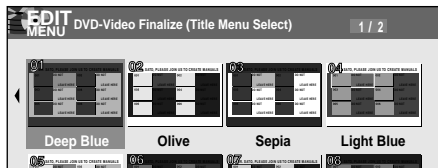

If you press the ★ button, you can preview the selected menu. To return, press the O button.

While displaying a preview screen of your captured image, you can access the other menu to correct colour (➡ page 129) by pressing the ★ button.

(Continued)

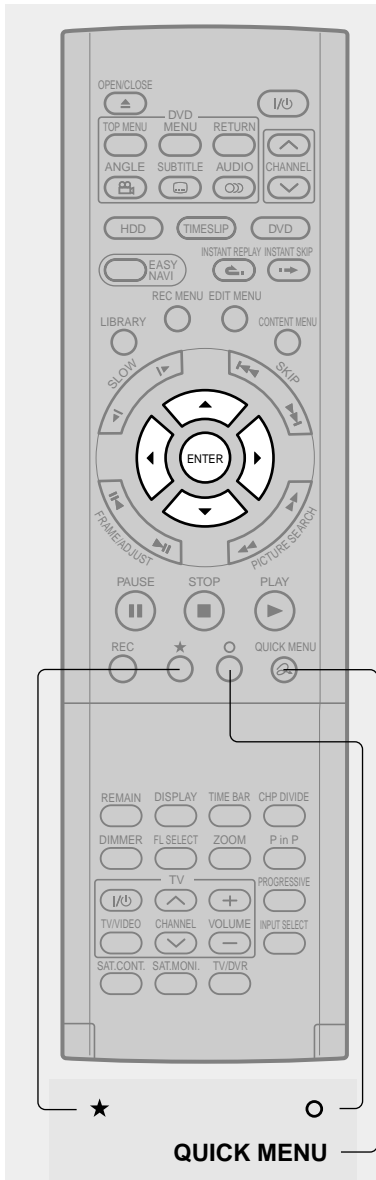

**7** Press **▲/▼/◀/▶** to select the title menu, then press **ENTER**.

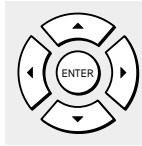

A display of chapter menu selection appears if “Menu Create” is set to “Title+Chapter” or “Chapter” at step 3.

**8** Press **▲/▼/◀/▶** to select the chapter menu.

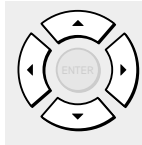

A selected menu is applied to all chapters. You cannot allocate a menu to each chapter.

If you press the **★** button, you can preview the selected menu. To return, press the **O** button.

If you press the **▼** button during preview, to select “Return” then press the **ENTER** button, you can go to the preview of the selected title menu. To return to the preview of chapter menu, press the **▲/▼/◀/▶** buttons to select a number next to “Chapter Menu” then press the **ENTER** button.

**9** Press **ENTER** on the “**EDIT MENU DVD-Video Finalize (Chapter Menu Select)**” display, and select “Yes” by **◀/▶**, then press **ENTER**.

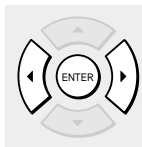

A message appears to ask you if you want the power to turn off automatically or not when the process is completed.

**10** Press **◀/▶** to select “Yes” or “No”, then press **ENTER**.

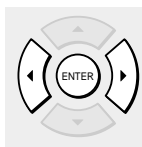

A message disappears and the finalize process starts. The progress is displayed on the screen and in the front panel display on the recorder.

**Notes**

- DVD-R/RW discs recorded on this recorder may not be recognized on other devices unless you execute DVD-Video finalizing process to them.
- You can record onto a DVD-R disc additionally to the limit of the disc capacity, unless you execute the DVD-Video finalizing process to it. Deleting of recorded titles is also possible, however, the disc space cannot be restored.
- You can record additional content onto a DVD-RW disc additionally to the limit of the disc capacity unless you execute the DVD-Video finalizing process to it. Deleting of recorded titles is also possible, however, the disc space can be restored only by the volume of the title last recorded.
- On DVD-RW discs, it is possible to cancel the DVD-Video finalizing process or to initialize for a new use.
- If a start time of a programmed recording comes during finalizing process, the recording is made onto the HDD. However, while making a menu, the recording is not executed. Also, when "Relay recording" is set to "Off" the recording will not start.

**■ To cancel the finalize process DVD-RW**

You can cancel the DVD-Video finalizing process executed to a DVD-RW disc so that the disc can be recordable again.

**1) During stop, press QUICK MENU.**

A quick menu appears.

**2) Press ▲ / ▼ to select "Disc management" then press ENTER.****3) Press ▲ / ▼ to select "Cancel finalization" then press ENTER.****4) Read the message, and press ◀ / ▶ to select "Yes", then press ENTER.**

The process starts.

**Notes**

- While the recorder is ready to start a programmed recording, you cannot cancel the DVD-Video finalizing process.
- You cannot cancel the DVD-Video finalizing process executed on a DVD-RW disc recorded on other device.
- You cannot cancel the DVD-Video finalizing process executed on a DVD-RW disc if the disc is protected.
- Cancelling the DVD-Video finalizing process may shift the thumbnails of titles/chapters.

# DV recording (Recording from a digital video camera)

You can connect a DV format digital video camera to the DV terminal to record from it.

## ■ Preparation

- Press the HDD or DVD button to select a recording media.
- Connect a DV format digital video camera to the DV terminal on the front panel.

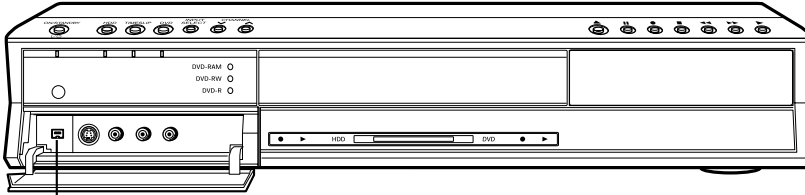

DV terminal



HDD/DVD

### 1 During playback or stop, press EDIT MENU.

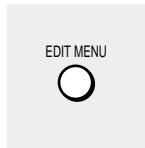

The "EDIT MENU Main Menu" appears.

### 2 Press ▲ / ▼ to select "DV Recording".

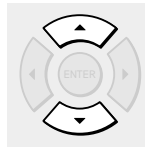

e.g.

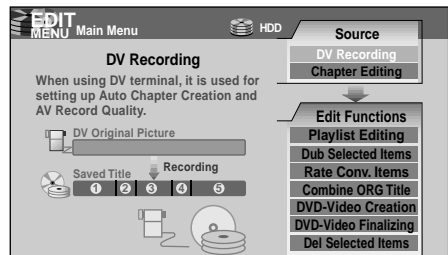

### 3 Press ENTER.



The "EDIT MENU DV Recording (Option Setting)" appears.

e.g.



This display will also appear when a DV format digital video camera connected to the DV terminal is turned on.



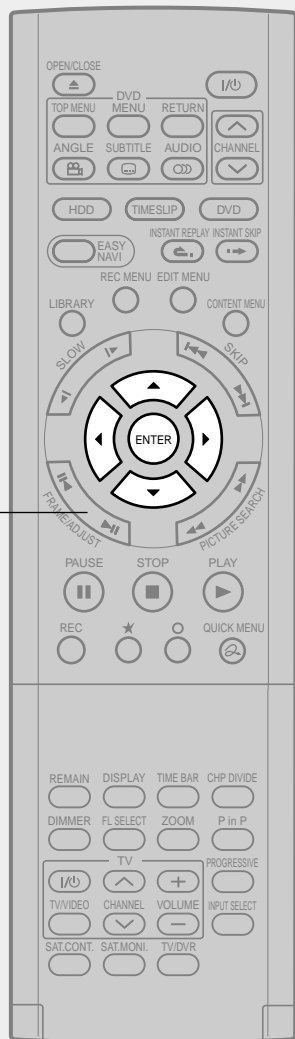

ADJUST

## 4 Press ▲/▼/◀/▶ to make the settings.

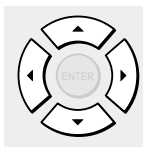

As you select each item, an explanation is provided.

To change the picture and sound rates:

- 1) Press the ▲/▼ buttons to select "Change" then press the ENTER button.
- 2) On the "AV record quality" display, press the ADJUST button to select a setting number.
- 3) Press the ENTER button.

## 5 Press ▲/▼/◀/▶ to select "Next", then press ENTER.

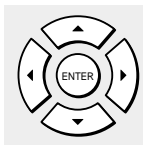

Details on the recording appears.

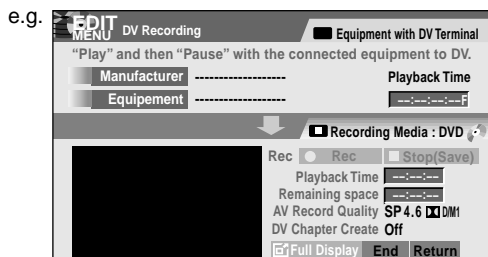

## 6 Play the connected DV format digital video camera and pause the play at a desired scene.

## 7 Press ▲/▼/◀/▶ to select "Rec", then press ENTER.

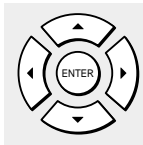

Recording starts.

- To pause the recording, select "Pause" by the ▲/▼/◀/▶ buttons then press the ENTER button.
- To stop the recording, select "Stop (Save)" by the ▲/▼/◀/▶ buttons then press the ENTER button.

**Notes**

- The DV terminal of this recorder supports only input from a DV format digital video camera. It cannot output to a connected device. Some models of DV format digital video cameras may be not compatible.
- At step 5, you can enlarge the video image by selecting “Full Display”, then pressing the ENTER button.
- If “DV Chapter Create” is set to “Off” and you record onto a DVD-R/RW disc, chapters are automatically made according to the “DVD-Video:CHP create” setting (➡ page 162). The number of chapters has the limit. Chapters are divided with a margin of about 0.5 second or less according to the DVD-Video standard.
- DV recording does not start in the following cases:
  - While recording or in the time slip mode.
  - While operating a “REC MENU”, “CONTENT MENU” or “LIBRARY MENU”.
  - If the recorder’s clock is not set yet.
  - Within 5 minutes before a programmed recording starts, or during a programmed recording.
- If a DV recording overlaps with a programmed recording, the DV recording will stop 5 minutes before the programmed recording starts, and the programmed recording will be executed.
- DV recording does not work if the DV terminal is connected equipment other than DV format digital video camera, such as a PC.
- Depending on the connected DV format digital video camera, the display at step 5 may not show “Manufacturer” or “Equipment”.
- If the DV terminal is connected to more than one DV format digital video camera, DV recording may not work properly. For proper functioning of DV recording, connect only one device to the DV terminal.
- DV recording is not compatible with Relay recording.
- Do not keep the DV terminal connected unless you record from a DV format digital video camera, as it may give influence on the recorder if operated.
- If you leave the “EDIT MENU DV Recording” unoperated for about 15 minutes, it switches to the full mode if “Screen protector” (➡ page 159) is set to “On.”
- When you want to record both stereo 1 and stereo 2 sounds from a DV format digital video camera, additionally make a connection to the audio input jacks on this recorder using cables such as audio/video cables supplied with the DV format digital video camera. (➡ page 37)
- If a DV format digital video camera is not recognized, pull out the plug and connect it again.
- Some models of DV format digital video cameras may support a different compression format. From such equipment, recording is not possible.
- Depending on the models of DV format digital video cameras, recording may not work properly or some functions may be disabled.
- On an input source from a DV tape which is partly recorded over, chapters may not made properly.

# Library

To facilitate your collecting.

- **Using Library data**
- **Searching for a desired title**
- **Viewing the Library data**
- **Checking remaining space**

# Using Library data

The recorder has a “Library Management” database which memorizes various properties of recordings made on this recorder, including date, media, title, genre, etc. Using this database, you can search for desired or available discs.

You can utilize Library data as follows.

- To search for a DVD-RAM disc that contains a desired title.
- To check or change information of title or disc.
- To check the remaining space of a DVD-RAM disc.

## Basic operation of the Library system

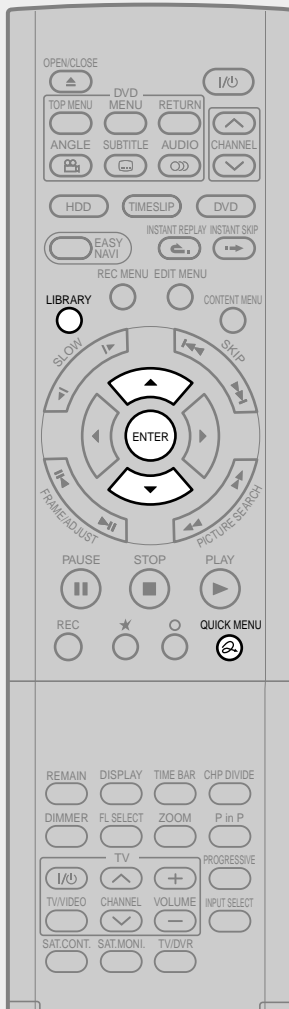

### 1 Press LIBRARY.

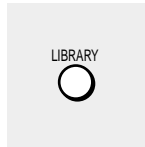

The “LIBRARY MENU Title Summary (All Titles)” appears.

e.g.

No.	Date	Day	Time	CH	Genre	Title Name
HDD 2004/ 6/20	Su	19:00	5			2004/06/20 19:00 Ch:5
HDD 2004/ 6/19	Sa	23:00	4			2004/06/19 23:00 Ch:4
HDD 2004/ 6/18	Fr	19:00	3			2004/06/18 19:00 Ch:3
HDD 2004/ 6/17	Th	21:00	3			2004/06/17 21:00 Ch:3

### 2 Press QUICK MENU.

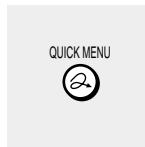

A Quick Menu appears.

e.g.

Quick Menu	CH	Genre	Title Name
DVD space remaining	0	5	2004/06/20 19:00 Ch:5
DVD all disc No.	0	4	2004/06/19 23:00 Ch:4
Title information	0	3	2004/06/18 19:00 Ch:3
Arrange	0	3	2004/06/17 21:00 Ch:3
Narrowing	0	2	2004/06/13 23:00 Ch:4
Jump	0	2	2004/06/13 23:00 Ch:4
Disc information	0	4	2004/06/13 21:00 Ch:3
Library management	0	L1	2004/06/11 21:00 Ch:3
Exit	0	L1	2004/06/ 9 21:00 Ch:3

### 3 Press ▲ / ▼ to select an item, then press ENTER.

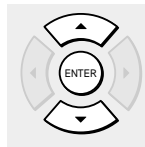

For details on each item, see from the next page.

#### Notes

- To cancel this procedure, press the LIBRARY button.
- The Library system does not support DVD-R/RW discs.
- Selecting a title on the “LIBRARY MENU Title Summary (All Titles)”, and pressing the ENTER button begins playback of the title if the disc containing the title is loaded.
- For proper function of the Library system, use DVD-RAM discs that shows a statement on its package such as “This disc can copy images that permit copying once.” If you use a DVD-RAM disc without such a statement, and then operate it on other device, the library data of the disc may not function properly.
- The “LIBRARY MENU” may not display all characters of a registered name of a disc.

# Searching for a desired title

From the "LIBRARY MENU Title Summary (All Titles)", you can select a title by using the ▲ / ▼ buttons. If you change the listing order or sort the titles, search may be easier.

## Changing the listing order

### Arrange

- 1) From the Quick Menu, select "Arrange" by ▲ / ▼ then press ENTER.

The sub-menu appears.

e.g.

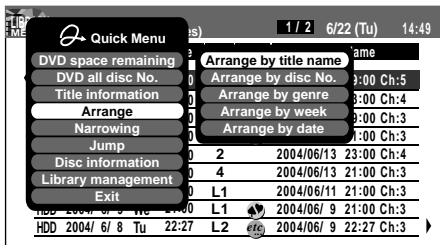

- 2) Press ▲ / ▼ to select the listing order, then press ENTER.

Titles are arranged in selected order.

### Notes

- If you repeat the selection of different types of the listing order, the old one precedes the new one. For example, when you select "Arrange by genre" then "Arrange by disc No.", the order of genre is produced in the order of disc number.

## Searching

### Narrowing

- 1) From the Quick Menu, select "Narrowing" by ▲ / ▼ then press ENTER.

The sub-menu appears.

e.g.

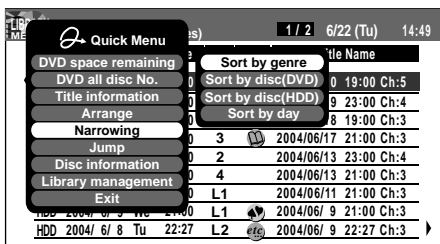

- 2) Press ▲ / ▼ to select a narrowing condition, then press ENTER.

### Sort by genre

The sub-menu appears.

Press the ▲ / ▼ buttons to select a genre, then press the ENTER button.

Titles within the selected genre are sorted.

### Sort by disc(DVD)

An input window appears.

e.g.

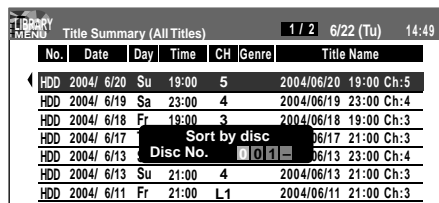

Follow steps 1) and 2) below.

- 1) Press ◀ / ▶ to select a location, then press ADJUST or ▲ / ▼ to enter the disc number.

- 2) Press ENTER.

Titles in the specified disc are sorted. For example, if you enter "001-", titles in discs 001, 001A and 001B are listed.

### Sort By Disc(HDD)

Titles in the HDD are sorted.

### Sort by day

The sub-menu appears.

Press the ▲ / ▼ buttons to select the day, then press the ENTER button.

Titles recorded on the selected day are listed.

### Notes

- Press the O button to go back to the display for the previous narrowing condition.
- If you want to display all titles, press the QUICK MENU button, then press the ▲ / ▼ buttons to select "Cancel narrowings" and press the ENTER button.

## Jumping

### Jump

- 1) From the Quick Menu, select "Jump" by ▲ / ▼ then press ENTER.

The sub-menu appears.

e.g.

Title Summary (All Titles)							1 / 2	6/22 (Tu)	14:49
No.	Date	Day	Time	CH	Genre	Title Name			
HDD 2004/ 6/20	Su	19:00	5		2004/06/20	19:00 Ch:5			
HDD 2004/ 6/19	Sa	23:00	4		2004/06/19	23:00 Ch:4			
HDD 2004/ 6/18	Fr	19:00	3		2004/06/18	19:00 Ch:3			
HDD 2004/ 6/17	Th	21:00	3		2004/06/17	21:00 Ch:3			
HDD 2004/ 6/13	Su	23:00	2		2004/06/13	23:00 Ch:4			
HDD 2004/ 6/13	Su	21:00	4		2004/06/13	21:00 Ch:3			
HDD 2004/ 6/11	Fr	21:00	L1		2004/06/11	21:00 Ch:3			
HDD 2004/ 6/ 9	We	21:00	L1		2004/06/ 9	21:00 Ch:3			
HDD 2004/ 6/ 8	Tu	22:27	L2		2004/06/ 8	22:27 Ch:3			

- 2) Press ▲ / ▼ to select the jump method, then press ENTER.

### Appoint character

An input window appears.

e.g.

Title Summary (All Titles)							1 / 2	6/22 (Tu)	14:49
No.	Date	Day	Time	CH	Genre	Title Name			
HDD 2004/ 6/20	Su	19:00	5		2004/06/20	19:00 Ch:5			
HDD 2004/ 6/19	Sa	23:00	4		2004/06/19	23:00 Ch:4			
HDD 2004/ 6/18	Fr	19:00	3		2004/06/18	19:00 Ch:3			
HDD 2004/ 6					Specific character jump	21:00 Ch:3			
HDD 2004/ 6					Character String:	Jump	23:00 Ch:4		
HDD 2004/ 6/13	Su	21:00	4		2004/06/13	21:00 Ch:3			
HDD 2004/ 6/11	Fr	21:00	L1		2004/06/11	21:00 Ch:3			
HDD 2004/ 6/ 9	We	21:00	L1		2004/06/ 9	21:00 Ch:3			
HDD 2004/ 6/ 8	Tu	22:27	L2		2004/06/ 8	22:27 Ch:3			

Perform steps 1) to 3) below.

- 1) Put the cursor on the input area, and press ENTER.  
The on-screen keyboard appears.
- 2) Enter the first characters (up to three characters) of the title you are looking for.
- 3) Press ► to select "Jump" and press ENTER.  
The title that starts with the specified characters is selected.

#### Note

- The input window of "Specific character jump" can be shifted by pressing the ▲ / ▼ buttons.

### Appoint disc No.

The on-screen keyboard appears.

e.g.

Title Summary (All Titles)							1 / 2	6/22 (Tu)	14:49
No.	Date	Day	Time	CH	Genre	Title Name			
HDD 2004/ 6/20	Su	19:00	5		2004/06/20	19:00 Ch:5			
HDD 2004/ 6/19	Sa	23:00	4		2004/06/19	23:00 Ch:4			
HDD 2004/ 6/18	Fr	19:00	3		2004/06/18	19:00 Ch:3			
HDD 2004/ 6/17					Specific Disc No. Jump	06/17 21:00 Ch:3			
HDD 2004/ 6/13					Disc No.	06/13 23:00 Ch:4			
HDD 2004/ 6/13	Su	21:00	4		2004/06/13	21:00 Ch:3			
HDD 2004/ 6/11	Fr	21:00	L1		2004/06/11	21:00 Ch:3			
HDD 2004/ 6/ 9	We	21:00	L1		2004/06/ 9	21:00 Ch:3			
HDD 2004/ 6/ 8	Tu	22:27	L2		2004/06/ 8	22:27 Ch:3			

Perform steps 1) and 2) below.

- 1) Press ◀ / ▶ to select the position to enter and press ADJUST or ▲ / ▼ to enter the disc number.  
Input 3 digits, and, if necessary A or B of disc. If you input "--", you can leave the digit and the lower unspecified to search. For example, when "1 0 --" is input, titles of disc number such as 100, 100A, 102 are searched, and a title list starting from the first found one appears. It is recommended that you execute "Arrange by disc No." beforehand.
- 2) Press ENTER.  
The titles of the selected number disc are displayed.

### Specific page

An input window appears.

e.g.

Title Summary (All Titles)							1 / 2	6/22 (Tu)	14:49
No.	Date	Day	Time	CH	Genre	Title Name			
HDD 2004/ 6/20	Su	19:00	5		2004/06/20	19:00 Ch:5			
HDD 2004/ 6/19	Sa	23:00	4		2004/06/19	23:00 Ch:4			
HDD 2004/ 6/18	Fr	19:00	3		2004/06/18	19:00 Ch:3			
HDD 2004/ 6/17					Specific page jump	06/17 21:00 Ch:3			
HDD 2004/ 6/13					Page Number	06/13 23:00 Ch:4			
HDD 2004/ 6/13	Su	21:00	4		2004/06/13	21:00 Ch:3			
HDD 2004/ 6/11	Fr	21:00	L1		2004/06/11	21:00 Ch:3			
HDD 2004/ 6/ 9	We	21:00	L1		2004/06/ 9	21:00 Ch:3			
HDD 2004/ 6/ 8	Tu	22:27	L2		2004/06/ 8	22:27 Ch:3			

Perform steps 1) and 2) below.

- 1) Press ▲ / ▼ or ADJUST to enter the page number.
- 2) Press ENTER.  
The selected page is displayed.

# Viewing Library data

This section explains how to check and maintain the Library data.

## Viewing title information

### Title information

- 1) From the Quick Menu, select "Title information" by ▲ / ▼ then press ENTER.

You can view information about the selected title.

e.g.

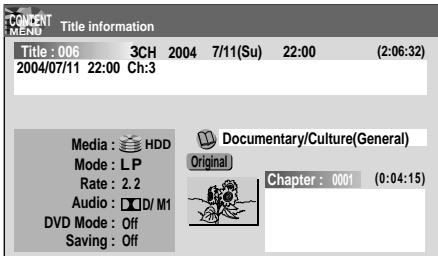

You can do the following operations with the Quick Menu.

(Press the QUICK MENU button to display the Quick Menu. Press ▲ / ▼ buttons to select an item and press ENTER.)

e.g.

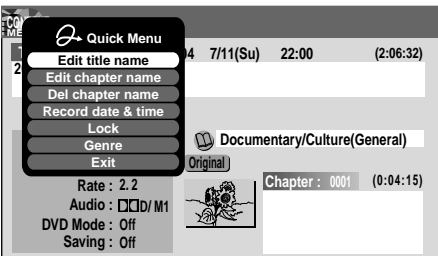

"Edit title name":

The on-screen keyboard appears.

Following the procedure on ➡ page 30, enter a new name for the title.

"Edit chapter name":

(Press the PICTURE SEARCH (◀◀/▶▶) button to display the chapter that you want to put a name for, and select the chapter.)

The on-screen keyboard appears.

Following the procedure on ➡ page 30, enter a new name for the chapter.

"Del chapter name":

(Press the PICTURE SEARCH (◀◀/▶▶) button to display the chapter that you want to put a name for, and select the chapter.)

"Record date & time":

The cursor moves to the date so that you can correct it.

"Lock"

Set the protection for the currently selected title. The protection icon "🔒" appears.

"Genre":

The sub-menu appears.

Press the ▲ / ▼ buttons to select a genre, then press the ENTER button.

A name of the selected genre and the icon appear.

**Note**

- When you change settings of a DVD-RAM disc, load the DVD-RAM disc.

## Viewing disc information

### Disc information

- 1) From the Quick Menu, select "Discs information" by ▲ / ▼ then press ENTER.

You can view information about the loaded disc.

e.g.

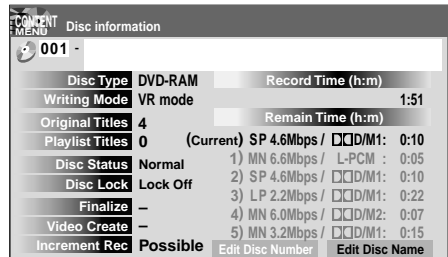

To change the number or name of the DVD-RAM disc:

- 1) Press ◀ / ▶ to select "Edit Disc Number" or "Edit Disc Name", then press the ENTER button.
- 2) Following the procedure on ➡ page 30, enter a new name for the disc.

To change the disc number, press the ADJUST button.

**Note**

- You can also change a disc name of a DVD-RW if it is not finalized yet.

## Maintenance of Library data

The recorder usually controls the Library database system automatically. However, in the following cases, you must maintain and create data manually.

- **When you want to add information about a title,** (for example **when you use a DVD-RAM disc recorded on another device, etc.**), to the Library system of the recorder.  
→ “Registering a disc manually” (➡ page 144).
- **When the Library database memory is full.** (Up to 3000 entries can be registered. When you reach this limit, a message will appear and further additions to the Library database will be rejected. Erase unnecessary data to make space.)  
→ “Erasing unnecessary data” (➡ page 145).
- **When you want to rearrange the whole Library information from the beginning.**  
→ “Deleting all the Library information only” (➡ page 145).
- **When you save the Library data in another DVD-RAM disc.**  
→ “Saving the Library data in a DVD-RAM disc” (➡ page 146).
- **When you import saved Library data back into the recorder.**  
→ “Re-installing the backup data” (➡ page 146).

### Note

- Save your Library data on a DVD-RAM disc. Importing Library data replaces all current database information in the recorder, including any data added after you saved the data onto a DVD-RAM disc.

## ■ Registering a disc manually

- 1) Load a DVD-RAM disc that contains information you want to add.
- 2) Press **LIBRARY**.
- 3) Press **QUICK MENU**.
- 4) Press **▲ / ▼** to select “Library management”, then press **ENTER**.  
A sub-menu appears.

e.g.

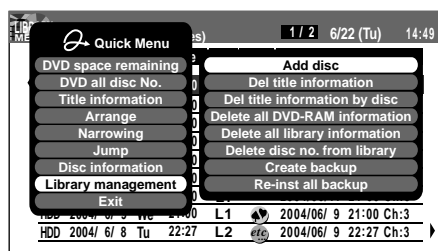

- 5) Press **▲ / ▼** to select “Add disc”, then press **ENTER**.
- 6) Press **◀ / ▶** to select “Yes”, then press **ENTER**.  
To cancel, select “No”.  
All title information is registered.

### Notes

- To use title information in a DVD-RAM disc recorded on another device, as the Library data of the recorder, be sure to follow the procedure of “Registering a disc manually” to add said data to the Library system. This information cannot be added automatically.
- If you record content on a DVD-RAM disc on the recorder and edit the content on the other device, Library data of the disc may be lost or the disc may not function properly.
- Unless a DVD-RAM disc is registered to the recorder, information of current or future titles recorded on the disc, will not be registered.
- By registering a disc manually, several discs in same number consequently may be registered. In this case, the remaining time is displayed per disc or page. Execution of “Edit Disc Number” (➡ page 143) is recommended.



### ■ Erasing unnecessary data

When the Library database is full (3000 entries). → Select "Del title information".

- 1) Press LIBRARY.
- 2) Press ▲ / ▼ to select a title.
- 3) Press QUICK MENU.
- 4) Press ▲ / ▼ to select "Library management" then press ENTER.
- 5) Press ▲ / ▼ to select "Del title information", then press ENTER.
- 6) Press ◀ / ▶ to select "Yes", then press ENTER.  
Library data of the title selected in step 2) is erased.  
To cancel, select "No".

To delete information of all titles in the specified data  
→ Select "Del title information by disc".

- 1) Press LIBRARY.
- 2) Press ▲ / ▼ to select a title.
- 3) Press QUICK MENU.
- 4) Press ▲ / ▼ to select "Library management" then press ENTER.
- 5) Press ▲ / ▼ to select "Del title information by disc", then press ENTER.
- 6) Press ◀ / ▶ to select "Yes", then press ENTER.  
Library data of all titles in the disc you selected in step 2) is erased.  
To cancel, select "No".

### ■ Deleting all the Library information only

Use this feature when you want to rearrange the whole Library information from the beginning.

- 1) Press LIBRARY.
- 2) Press QUICK MENU.
- 3) Press ▲ / ▼ to select "Library management" and press ENTER.
- 4) Press ▲ / ▼ to select "Delete All DVD-RAM information" or "Delete all library information".  
**Delete all DVD-RAM information:**  
Deletes all Library information from the DVD-RAM disc, leaving the Library information on the HDD.  
**Delete all library information:**  
Deletes all Library information from the HDD and DVD-RAM disc.
- 5) Press ENTER.
- 6) Press ◀ / ▶ to select "Yes" and press ENTER.

### ■ Forced deletion of disc numbers

A number of an inactive disc can be deleted from the Library Management, so that it can be assigned to a new disc.

- 1) Press LIBRARY.
- 2) Press QUICK MENU.
- 3) Press ▲ / ▼ to select "Library management", then press ENTER.
- 4) Press ▲ / ▼ to select "Del disc no. from Library", then press ENTER.
- 5) Press ADJUST to select a number to delete, then press ENTER.

#### Note

- Deleting a disc number also deletes data of all titles in the disc.

Viewing Library data (Continued)

■ Saving the Library data in a DVD-RAM disc

- 1) Load a DVD-RAM disc to save the Library data.
- 2) Press LIBRARY.
- 3) Press QUICK MENU.
- 4) Press ▲ / ▼ to select “Library management”, then press ENTER.
- 5) Press ▲ / ▼ to select “Create backup”, then press ENTER.
- 6) Press ◀ / ▶ to select “Yes”, then press ENTER.  
To cancel, select “No”.

■ Re-installing the backup data

- 1) Load the DVD-RAM disc containing the Library database.
- 2) Press LIBRARY.
- 3) Press QUICK MENU.
- 4) Press ▲ / ▼ to select “Library management”, then press ENTER.
- 5) Press ▲ / ▼ to select “Re-inst all backup”, then press ENTER.
- 6) Press ◀ / ▶ to select “Yes”, then press ENTER.  
To cancel, select “No”.

**Note**

- Do not use a DVD-RAM disc which contains Library Management data registered to another recorder for backup data storage. Library Management format may vary depending on the model. Adding data of a new format onto the said disc may prevent the data of the older format from being re-installed.

# Checking remaining space

You can check the remaining space of each disc prior to recording.

## Viewing a number and space of a disc

### DVD all disc No.

- 1) From the Quick Menu, select "DVD all disc No." by ▲ / ▼ then press ENTER.

You can view numbers, names and estimated remaining spaces about all the registered discs.

To recheck the remaining space for a different "AV record quality" setting

- 1) Press QUICK MENU.

The Quick Menu appears.

- 2) Press ▲ / ▼ to select "AV record quality" then press ENTER.

e.g.

No.	Setting	Mode	Rate	Audio quality	Estimated
001	Sp	Manual	6.6	L-PCM	20min.
002	Sp	Manual	6.6	L-PCM	10min.
003	Mc	SP	4.6	DQD/M1	5min.
004	Liv	LP	2.2	DQD/M1	2min.
		Manual	6.0	DQD/M2	
		Manual	3.2	DQD/M1	

Total recording time: approx. 122 min.  
(with 4.7 GB unused)

- 3) Press ADJUST and select the setting (➡ page 161).

- 4) Press ENTER.

### Note

- It is recommended that beforehand you select a desired title or disc by "arrange" selection then execute "DVD space remaining", because the recorder lists the remaining space from the specified disc or the one which contains the specified title.

## Viewing remaining space

### DVD space remaining

- 1) From the Quick Menu, select "DVD space remaining" by ▲ / ▼ then press ENTER.

You can view the recording titles and the estimated space remaining per disc.

### Note

- You can rearrange the list by selecting "Arrange", "Narrowing" or "Jump" from the Quick Menu.



# Function Setup

You can change the default settings to customize performance to your preference.

- **Customizing the function settings**

# Customizing the function settings

You can change the default settings to customize performance to your preference.

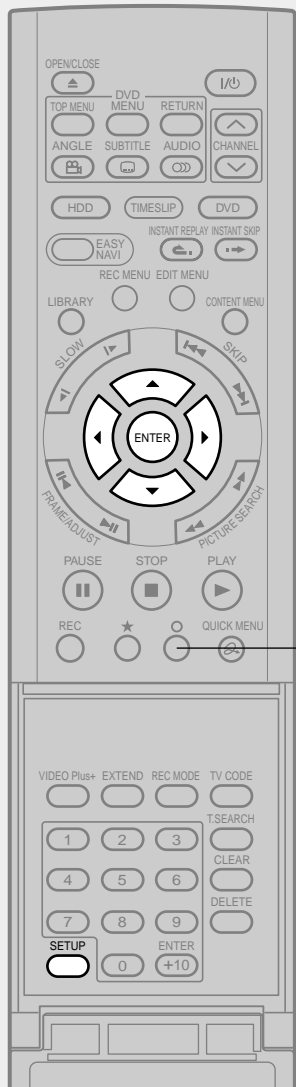

Open the lid.

**Notes**

- The SETUP button can function even during normal playback. However some items may be grayed out and they cannot be selected. In this case, try again after playback is stopped.
- The SETUP button does not function during recording, Recorded Title Play, Chase Play or Pause TV modes.

## 1 During stop, press SETUP.



The following setup display appears.

e.g.

DVD player settings	
DVD disc menu language	English
DVD audio language	English
DVD subtitle language	No subtitle

## 2 Press ◀/▶ to select the icon of a group that contains a desired item, then press ENTER.

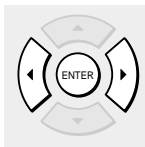

For details on each setting, see the next page.

e.g. When "Display settings" is selected:

e.g.

Display settings	
TV shape	4:3LB
On screen display	On
Transparency	25%
Startup screen	On
Screen protector	On
Background	Blue

## 3 Press ▲/▼ to select a desired item, then press ENTER.

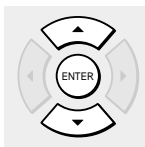

## 4 Refer to the explanations on pages beginning from 154, to change the selection by ▲/▼ or other buttons, then press ENTER.

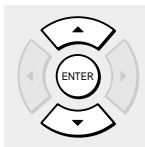

- To select another item in the same group, repeat steps 3 to 4.
- To shift to another group, press the O button then repeat steps 2 to 4.

## 5 Press SETUP.



The setup display disappears and the setting is completed.

Setting	Details	Page
<b>DVD player settings</b>		
<b>DVD disc menu language</b> DVD-VIDEO	To select a preferred language for disc menus.	154
<b>DVD audio language</b> DVD-VIDEO	To select a preferred language for the sound track.	154
<b>DVD subtitle language</b> DVD-VIDEO	To select a preferred language for subtitles.	154
<b>DVD dynamic range control</b> HDD DVD-RAM DVD-RW DVD-R DVD-VIDEO	To turn on or off a function that makes faint sounds easier to hear even if you lower the volume during late-hour playback.	155
<b>Karaoke vocal</b> DVD-VIDEO	To turn on or off the vocal output during DVD KARAOKE disc playback.	155
<b>DVD parental lock</b> DVD-VIDEO	To turn the parental lock function on or off.	155
<b>DVD title stop</b> DVD-RW DVD-R DVD-VIDEO	To turn on or off a feature that automatically stops playback after a title has been viewed.	156
<b>PBC</b> VCD	To use the menu screen when playing a PBC-controllable VIDEO CD.	156
<b>Picture/audio settings</b>		
<b>PAL/Auto</b> HDD DVD-RAM DVD-RW DVD-R DVD-VIDEO VCD	To select the video system of a disc.	157
<b>Pause/still</b> HDD DVD-RAM DVD-RW DVD-R DVD-VIDEO	To select the resolution of still pictures. (Field/Frame)	157
<b>Custom picture select</b> HDD DVD-RAM DVD-RW DVD-R DVD-VIDEO VCD	To select from standard or three customized picture settings.	157
<b>Custom picture setting</b> HDD DVD-RAM DVD-RW DVD-R DVD-VIDEO VCD	To customize picture quality settings and store them.	157
<b>Progressive conversion</b> HDD DVD-RAM DVD-RW DVD-R DVD-VIDEO VCD	To select the system of output signal. (Only when connected to a PROGRESSIVE TV.)	157
<b>Play DNR</b> HDD DVD-RAM DVD-RW DVD-R DVD-VIDEO VCD	To select a setting for playback at a reduced noise level.	157
<b>Audio out select</b> HDD DVD-RAM DVD-RW DVD-R DVD-VIDEO VCD CD	To select an output sound format corresponding to your system connection.	158
<b>Virtual surround</b> HDD DVD-RAM DVD-RW DVD-R DVD-VIDEO	To turn on or off expansive virtual surround sound effects from just two speakers.	158
<b>NICAM</b> HDD DVD-RAM	To select a sound type for NICAM programme.	158

(Continued)

Setting	Details	Page
<b>Display settings</b>		
<b>TV shape</b> <input type="checkbox"/> HDD <input type="checkbox"/> DVD-RAM <input type="checkbox"/> DVD-RW <input type="checkbox"/> DVD-R <input type="checkbox"/> DVD-VIDEO <input type="checkbox"/> VCD	To select a picture size according to the aspect ratio of your TV.	159
<b>On screen display</b> <input type="checkbox"/> HDD <input type="checkbox"/> DVD-RAM <input type="checkbox"/> DVD-RW <input type="checkbox"/> DVD-R <input type="checkbox"/> DVD-VIDEO <input type="checkbox"/> VCD <input type="checkbox"/> CD	To turn on or deactivate the operational status display (e.g., ►) on the TV screen.	159
<b>Transparency</b> <input type="checkbox"/> HDD <input type="checkbox"/> DVD-RAM <input type="checkbox"/> DVD-RW <input type="checkbox"/> DVD-R <input type="checkbox"/> DVD-VIDEO <input type="checkbox"/> VCD <input type="checkbox"/> CD	To select the transparency of the GUI relative to background pictures.	159
<b>Startup screen</b>	To turn on or off the start-up screen setting that makes the background picture appear automatically when turning on the power.	159
<b>Screen protector</b> <input type="checkbox"/> HDD <input type="checkbox"/> DVD-RAM <input type="checkbox"/> DVD-RW <input type="checkbox"/> DVD-R <input type="checkbox"/> DVD-VIDEO <input type="checkbox"/> VCD <input type="checkbox"/> CD	To turn the screen saver on or off.	159
<b>Background</b>	To select a display status when no video signals are present.	159
<b>Operational settings</b>		
<b>Operation beep</b> <input type="checkbox"/> HDD <input type="checkbox"/> DVD-RAM <input type="checkbox"/> DVD-RW <input type="checkbox"/> DVD-R <input type="checkbox"/> DVD-VIDEO <input type="checkbox"/> VCD <input type="checkbox"/> CD	To turn on or off the confirmation beeper announcing when each remote command is received.	160
<b>Recording complete beep</b> <input type="checkbox"/> HDD <input type="checkbox"/> DVD-RAM <input type="checkbox"/> DVD-RW <input type="checkbox"/> DVD-R	To select whether or not a buzzer sounds when dubbing and so forth is finished.	160
<b>IR code</b>	To switch the codes that operate the recorder.	160
<b>Instant skip interval</b> <input type="checkbox"/> HDD <input type="checkbox"/> DVD-RAM <input type="checkbox"/> DVD-RW <input type="checkbox"/> DVD-R <input type="checkbox"/> DVD-VIDEO <input type="checkbox"/> VCD <input type="checkbox"/> CD	To set the width to skip when the INSTANT SKIP button is pressed once.	160
<b>Instant replay interval</b> <input type="checkbox"/> HDD <input type="checkbox"/> DVD-RAM <input type="checkbox"/> DVD-RW <input type="checkbox"/> DVD-R <input type="checkbox"/> DVD-VIDEO <input type="checkbox"/> VCD <input type="checkbox"/> CD	To set the width to go back when the INSTANT REPLAY button is pressed once.	160
<b>Title thumbnail point</b> <input type="checkbox"/> HDD <input type="checkbox"/> DVD-RAM <input type="checkbox"/> DVD-RW <input type="checkbox"/> DVD-R	To select the position of the thumbnail image counting from the beginning of the title that has been recorded.	160
<b>HDD/RAM title play</b> <input type="checkbox"/> HDD <input type="checkbox"/> DVD-RAM	To activate resume play per title or continuous play.	160
<b>Still group interval</b> <input type="checkbox"/> DVD-RAM	To select an interval of still picture display.	160
<b>Priority contents</b>	To select the playback priority between JPEG (picture) files and MP3/WMA (audio) files.	160



Setting	Details	Page
<b>DVD recorder operation</b>		
<b>AV record quality</b> HDD DVD-RAM DVD-RW DVD-R	To select a set of picture and sound quality settings for manual programme recording.	161
<b>Picture record mode</b> HDD DVD-RAM DVD-RW DVD-R	To make further setting when you cannot adjust the image quality with “Custom picture setting” of the “Picture/audio settings”.	161
<b>Audio input level</b> HDD DVD-RAM DVD-RW DVD-R	To adjust the level of recording sound.	161
<b>Aspect ratio(video mode)</b> DVD-RW DVD-R	To set the aspect ratio for DVD-R/RW recording.	162
<b>DVD compatible mode</b> HDD DVD-RAM DVD-RW DVD-R	To set the audio for DVD-R/RW recording.	162
<b>DVD-Video:CHP create</b> DVD-RW DVD-R	To set whether or not chapters are to be automatically created at a specified interval for DVD-R/RW recording.	162
<b>Relay recording</b> HDD DVD-RAM	To turn on or off a function that makes a recording automatically onto the HDD when the remainder of the DVD-RAM disc becomes less than 10 minutes or when a disc is not loaded.	162
<b>Management settings</b>		
<b>Genre setting</b> HDD DVD-RAM DVD-RW DVD-R	To register the frequently used genre in the menu.	163
<b>Eco. mode</b>	To set the front panel display to turn on/off in the standby mode.	163
<b>HDD auto stop</b> HDD	To turn on or off a power saving function that stops the HDD after a certain period of inactivity.	163
<b>All HDD titles delete</b> HDD	To delete all the titles recorded on the HDD, leaving the Library information on the DVD-RAM disc.	163
<b>HDD format</b> HDD	To initialize the HDD.	164
<b>DVD-RAM physical format</b> DVD-RAM	To perform physical formatting of a DVD-RAM disc.	29
<b>Software version</b>	To display the version of the software. The version is only displayed and cannot be set.	
<b>DVD drive software</b>	To display the version of the DVD drive software. The version is only displayed and it cannot be set.	
<b>Initial settings</b>	See  page 28, “INSTALLATION GUIDE”.	

## DVD player settings

### DVD disc menu language

DVD-VIDEO

#### English:

To display disc menus in English.

#### French:

To display disc menus in French.

#### German:

To display disc menus in German.

#### Spanish:

To display disc menus in Spanish.

#### Italian:

To display disc menus in Italian.

#### Others:

To make a further language choice.

After pressing the ENTER button, follow steps 1) – 4) below.

e.g.



- 1) Obtain the language code of the preferred language from the Language code list (➡ page 171).
- 2) Select the first character by pressing the ▲ / ▼ buttons (or the ADJUST button).
- 3) Press the ◀ / ▶ buttons to shift. Select the second character by pressing the ▲ / ▼ buttons (or the ADJUST button).
- 4) Press the ENTER button.

#### Note

- Some DVD video discs may not include your preset language. In this case, the recorder automatically displays disc menus consistent with the disc's initial language setting.

### DVD audio language

DVD-VIDEO

#### English:

To play sound tracks recorded in English.

#### French:

To play sound tracks recorded in French.

#### German:

To play sound tracks recorded in German.

#### Spanish:

To play sound tracks recorded in Spanish.

#### Italian:

To play sound tracks recorded in Italian.

#### Others:

To make further choices.

After pressing the ENTER button, follow steps 1) - 4) below.

e.g.

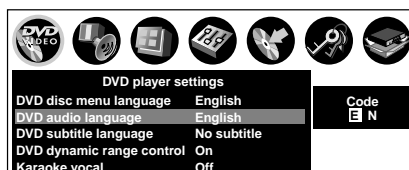

- 1) Obtain the language code of the preferred language from the Language code list (➡ page 171).
- 2) Select the first character by pressing the ▲ / ▼ buttons (or the ADJUST button).
- 3) Press the ◀ / ▶ buttons to shift. Select the second character by pressing the ▲ / ▼ buttons (or the ADJUST button).
- 4) Press the ENTER button.

#### Note

- Some DVD video discs may be played in a different language from that you selected. A prior language may be programmed by the disc.

### DVD Subtitle Language

DVD-VIDEO

#### English:

To display subtitles in English.

#### French:

To display subtitles in French.

#### German:

To display subtitles in German.

#### Spanish:

To display subtitles in Spanish.

#### Italian:

To display subtitles in Italian.

#### No subtitle:

To disable subtitles.

**Others:**

To make a further choice.

After pressing the ENTER button, follow steps 1) – 4) below.

e.g.



- 1) Obtain the language code of the preferred language from the Language code list (➡ page 171).
- 2) Select the first character by pressing the ▲ / ▼ buttons (or the ADJUST button).
- 3) Press the ◀ / ▶ buttons to shift. Select the proceeding character by pressing the ▲ / ▼ buttons (or the ADJUST button).
- 4) Press the ENTER button.

**Notes**

- Some DVD video discs may be set to display subtitles in a different language from that you selected. A prior subtitle language may be programmed by the disc.
- Some DVD video discs allow you to change subtitle selections only via the disc menu. In this case, press the MENU button and choose the appropriate subtitle language from the selection on the disc menu.

**DVD dynamic range control**

HDD DVD-RAM DVD-RW DVD-R DVD-VIDEO

Turns on or off a function that makes faint sounds easier to hear even if you lower the volume during late-hour playback.

**Off:**

The DVD dynamic range control does not function.

**On:**

The DVD dynamic range control functions.

**Notes**

- This function is available only for a disc recorded in Dolby Digital format.
- Depending on the disc you play back, the actual effect of this function differs.

**Karaoke vocal**

DVD-VIDEO

**Off:**

The main vocal sound is not output.

**On:**

The main vocal sound is output.

**Notes**

- This function is available only for a DVD KARAOKE disc recorded in Dolby Digital Multi Channel format.
- If you want to enjoy the KARAOKE function, connect an amplifier or other such device to this recorder.

**DVD parental lock**

DVD-VIDEO

DVD video discs equipped with the Parental Lock function have a predetermined limitation level. The limitation level or limitation method may differ depending on the disc. For example the total disc may not be played back, or an extreme violent scene maybe cut or replaced automatically by another scene.

**Important**

- Depending on discs, it may not be evident whether the disc is compatible with the Parental Lock function. Make sure that the Parental Lock function you set is activated correctly.

**On:**

Select this to activate the Parental Lock function or to change the setting.

After pressing the ENTER button, follow steps 1) – 3) below.

**Off:**

Deactivate the Parental Lock function.

After pressing the ENTER button, follow steps 1) below.

- 1) Enter a 4-digit password by using the number buttons, then press the ENTER button.

If you make a mistake entering your password, press the CLEAR button before pressing the ENTER button, and re-enter the correct password.

- 2) Press the ▲ / ▼ / ◀ / ▶ buttons to move the cursor. Then press the ADJUST button to enter the code of a country/area whose standards were used to rate the DVD video disc, referring to the following list (next page).

(Continued)

Country/Area	Code
AUSTRALIA	AU
BELGIUM	BE
CANADA	CA
CHINA	CN
CHINA HONG KONG	HK
DENMARK	DK
FINLAND	FI
FRANCE	FR
GERMANY	DE
INDONESIA	ID
ITALY	IT
JAPAN	JP
MALAYSIA	MY
NETHERLANDS	NL
NORWAY	NO
PHILIPPINES	PH
RUSSIAN FEDERATION	RU
SINGAPORE	SG
SPAIN	ES
SWEDEN	SE
SWITZERLAND	CH
TAIWAN	TW
THAILAND	TH
UNITED KINGDOM	GB
UNITED STATES	US

3) Select the desired limitation level by pressing the ▲ / ▼ buttons, and then press the ENTER button.

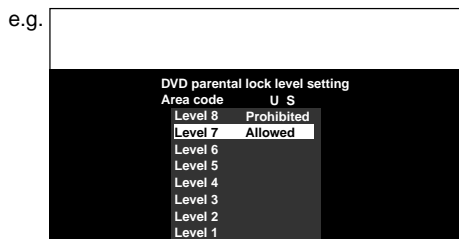

Unless the Parental Lock function is set to “Off”, a disc that has a higher limitation level than your selected limitation level cannot be played back. For example, if you select level 7, discs exceeding level 8 are locked and cannot be played back.

When “US” is selected, its limitation level corresponds to the following settings.

Level 7 : NC-17      Level 3 : PG  
Level 6 : R          Level 1 : G  
Level 4 : PG13

■ To change the limitation level of the Parental Lock function

Follow step 1) - 3) above.

■ To change the password

1) Press the STOP button 4 times after selecting “On” and “Off” in order, and then press the ENTER button.

The password is cleared.

2) Enter a new 4-digit password by using the number buttons.

3) Press the ENTER button.

DVD title stop

DVD-RW | DVD-R | DVD-VIDEO

Off:

Plays back all following titles on the disc after the current title has been viewed.

On:

Recorder is stopped after playback of current title being viewed is completed.

PBC

VCD

Off:

Selects normal playback without using the menu screen of a PBC-controllable VIDEO CD.

On:

Selects playback using the menu screen of a PBC-controllable VIDEO CD.

## Picture/Audio settings

### PAL/Auto

HDD DVD-RAM DVD-RW DVD-R DVD-VIDEO VCD

#### PAL:

To play a PAL disc. Connect a PAL TV to view a picture.

#### Auto:

The recorder automatically identifies PAL or NTSC video system of a disc. Connect a multisystem TV (PAL/NTSC compatible) to view a picture. A playback picture may be distorted when detected a signal change between PAL and NTSC on the disc.

#### Note:

Alert message is displayed when detected both PAL and NTSC video system on the same disc.

### Pause/Still

HDD DVD-RAM DVD-RW DVD-R DVD-VIDEO

#### Auto:

Normal setting. Pause the moving image without blurring.

#### Frame:

Displays high resolution still image.

### Custom picture select

HDD DVD-RAM DVD-RW DVD-R DVD-VIDEO VCD

Select from between 4 picture settings (Normal, Setting 1-3) you stored in the memory.

### Custom picture setting

HDD DVD-RAM DVD-RW DVD-R DVD-VIDEO VCD

You can adjust fine picture quality and store up to 3 custom picture settings in the memory of the recorder.

- 1) Press the **▲ / ▼** button to select a desired setting from 3 settings, and then press the **ENTER** button.

e.g.

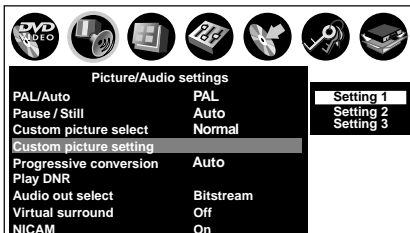

- 2) Press the **▲ / ▼** buttons to select adjustable items, and then press the **◀ / ▶** buttons to select each parameter.

#### Brightness

(0) Darker ⇔ Brighter (7)

#### Contrast

(-7) Lower ⇔ Higher (0)

#### Color

(-7) Duller ⇔ Brighter (0)

#### Edge enhance

(OFF) Normal ⇔ Sharp (ON)

- 3) After adjusting the items, press the **ENTER** button.

### Progressive conversion

HDD DVD-RAM DVD-RW DVD-R DVD-VIDEO VCD

There are two types of source content in pictures recorded in DVD video discs: film content (pictures recorded from films at 24 frames per second) and video content (video signals recorded at 25 frames in PAL (30 frames in NTSC) per second). Make this selection according to the type of content being viewed.

#### Auto:

Select this position normally.

The recorder automatically detects source content, film or video, of playback source, and converts that signal in the progressive output format in an appropriate method.

#### Video:

The recorder filters video signal, and converts it in the progressive output format appropriately. Suitable for playback of video content pictures.

#### Film:

The recorder converts film content pictures in the progressive output format appropriately. Suitable for playback of film content pictures. The progressive output feature will be most effective under this selection.

#### Note

- Depending on the disc, pictures may be cut off or doubled.

Customizing the function settings (Continued)

**Play DNR**

HDD DVD-RAM DVD-RW DVD-R DVD-VIDEO VCD

Selects a setting for playback at a reduced noise level. Press the ▲ / ▼ buttons to select an item then select “On” or “Off” using the ◀ / ▶ buttons.

**3D-DNR:**

**Off:**  
Not activated.

**On:**  
Reduces the noise levels of brightness signals and color signals present in the video signal during playback.

**Mosquito NR:**

**Off:**  
Not activated.

**On:**  
Reduces mosquito (flicker) noise occurring in the contour sections of images.

**Block NR:**

**Off:**  
Not activated.

**On:**  
Reduces noise that appears in the form of blocks (block noise) in a portion of the screen during playback of images with rapid movement.

DNR is the abbreviation for Digital Noise Reduction.

**Notes**

- DNR effects vary depending on the disc.
- Detailed images may no longer be visible depending on the scene due to the effects of DNR.
- Depending on the disc or scene, “On” may produce undesirable picture artifacts or increase noises on contours. In this instance, select “Off.”
- While you are using the zoom feature, “DNR” does not function.

**Audio out select**

HDD DVD-RAM DVD-RW DVD-R DVD-VIDEO VCD CD

Selects an output sound format corresponding to your audio system connection.

For details about output sound selection, see ➡ page 75.

**Bitstream:**

Select this when an amplifier equipped with built-in Dolby Digital, DTS or MPEG1 decoder is connected to this recorder.  
When you play back a disc recorded in Dolby Digital, DTS or MPEG1 format, digital audio signal is output.

**Analog 2ch:**

Select this when a TV or other audio device is connected to this recorder via the ANALOG output connectors.

**PCM:**

Select this when a 2ch digital stereo amplifier is connected to this recorder. When you play back a disc recorded in Dolby Digital or MPEG1 format, the sound is converted to the PCM (2ch) format and output.

**Virtual surround**

HDD DVD-RAM DVD-RW DVD-R DVD-VIDEO

This lets you playback discs with acoustic effects having greater depth and presence even when using only two speakers.

**Off:**  
Virtual surround effect not activated.

**On:**  
Virtual surround effect activated.

**Notes**

- This function is only activated when playing back a disc recorded with Dolby Digital.
- This function is only activated when “Audio Out Select” is set to “PCM” if the BITSTREAM/PCM jack of this DVD recorder is connected to an amplifier or similar device.
- When the virtual surround effect is activated, Dolby Progressive Sound may be deactivated or sound differently than usual.
- When the virtual surround effect is activated, the volume may sound differently than usual.
- Set “Virtual surround” to “Off” if the audio sounds distorted.

Manufactured under license from QSound Labs, Inc. U.S. patent Nos. 5,105,462, 5,208,860 and 5,440,638 and various foreign counterpart. Copyright QSound Labs, Inc. 1998-2002. QXpander™ is a trademark of QSound Labs, Inc. All rights reserved.

**NICAM**

HDD DVD-RAM

NICAM programmes are divided into 3 types. NICAM Stereo, NICAM Mono and Mode I/Mode II (transmission in another language). NICAM programmes are always accompanied by a standard mono sound broadcast and you can select the desired sound on the screen (for recording).

**Off:**  
Only set at this position to record the standard mono sound during a NICAM broadcast if the stereo sound is distorted due to inferior reception conditions.

**On:**  
Normally set at this position.

## Display settings

### TV Shape

HDD DVD-RAM DVD-RW DVD-R DVD-VIDEO

Select a picture size according to the aspect ratio of your TV.

For details on this setting, see “TV shape setting” (➡ page 50, “INSTALLATION GUIDE”).

### On screen display

HDD DVD-RAM DVD-RW DVD-R DVD-VIDEO VCD CD

#### Off:

Deactivates the operational status display (e.g., ►) on the TV screen.

#### On:

Activates the operational status display (e.g., ►) on the TV screen.

### Transparency

HDD DVD-RAM DVD-RW DVD-R DVD-VIDEO VCD CD

Selects the transparency of the GUI and its relationship to the background image.

0% : 25% : 50%

### Startup screen

#### Off:

The startup screen is not displayed.

#### On:

The startup screen appears automatically when turning on the power.

### Screen protector

HDD DVD-RAM DVD-RW DVD-R DVD-VIDEO VCD CD

To reduce TV screen damage (image burn), this function disengages the pause mode of a playback image. The display returns to the normal TV screen when the recorder remains idle for more than 15 minutes. In time slip mode, the playback pause is released.

If this function is set to “On”, the recorder, if freezes, may return to the normal by leaving it for about 15 minutes or longer.

#### Off:

Deactivates the screen protector function.

#### On:

Activates the screen protector function.

#### Note

- Toshiba does not guarantee that this function protects the TV screen by all means.

### Background

Selects a screen colour when receiving no video signals such as selecting a non-broadcasting channel.

#### Off:

No colour.

#### Black:

Black is displayed.

#### Blue:

Blue is displayed.

### Important

- Depending on signal reception, the Background setting may be cleared. To prevent this, set this function to “Off”.

## Operational settings

### Operation beep

HDD DVD-RAM DVD-RW DVD-R DVD-VIDEO VCD CD

Turn on or off a confirmation beeper announcing when a command is received.

#### Off:

Turns off the beep sound.

#### On:

Turns on the beep sound.

#### Note

- You cannot turn off beeps for alerts irrespective of this setting.

### Recording complete beep

HDD DVD-RAM DVD-RW DVD-R

This is used to set whether or not a buzzer sounds when dubbing and so forth is finished.

#### Off:

Buzzer does not sound.

#### On:

Buzzer sounds.

#### Note

- You cannot turn off beeps for alerts irrespective of this setting.

### IR Code

Switches the codes to operate the recorder. If you use the second and third TOSHIBA HDD/DVD video recorders, set the different remote codes for each recorder to avoid confusion in the response of the recorders.

For details about this setting, refer to "Operating the second and third TOSHIBA HDD/DVD video recorders with the remote control of this recorder" (➡ page 54, "INSTALLATION GUIDE").

**DR 1 : DR 2 : DR 3**

### Instant skip interval

HDD DVD-RAM DVD-RW DVD-R DVD-VIDEO VCD CD

Sets how much time is skipped when the INSTANT SKIP button is pressed.

**5 sec. : 10 sec. : 30 sec. : 5 min.**

### Instant replay interval

HDD DVD-RAM DVD-RW DVD-R DVD-VIDEO VCD CD

Sets how far back is replayed when the INSTANT REPLAY button is pressed.

**5 sec. : 10 sec. : 30 sec. : 5 min.**

### Title thumbnail point

HDD DVD-RAM DVD-RW DVD-R

For recorded titles, sets how far a scene from the start is set as the title thumbnail.

**0 sec. : 3 sec. : 10 sec. : 35 sec. : 1 min. : 5 min.**

#### Note

- Thumbnails can also be changed to other scenes. See ➡ page 100.

### HDD/RAM title play

HDD DVD-RAM

Sets the resume play per title.

#### Title resume:

Remembers the point where you stop playback. Allows you to resume the playback from that point.

#### Serial playback:

You can play back titles (Original, Playlist) stored in the HDD or a DVD-RAM continuously. Because there is no division between titles, the recorder remembers only the last point where you stopped playback.

### Still group interval

DVD-RAM

Sets an interval for display of still pictures (in seconds) when playing back a collection of still images.

**1 sec. : 2 sec. : 3 sec. : 5 sec. : 10 sec. : Default**

### Priority Contents

To select the playback priority between JPEG (picture) files and MP3/WMA (audio) files.

**Photo:** JPEG files take priority over MP3/WMA files.

**Audio:** MP3/WMA files take priority over JPEG files.

#### Notes

- If this selection does not correspond to disc contents, the recorder will take a longer time to start playback of the disc.
- To change this setting to a loaded disc, open the disc tray after the setting, then close the disc tray to have the recorder read the disc again.



## DVD recorder operation

### AV record quality

HDD DVD-RAM DVD-RW DVD-R

You can select from 5 combined picture and sound quality recording settings prior to actual recording. Actual selection applied becomes the default setting for the normal recording or programmed recording.

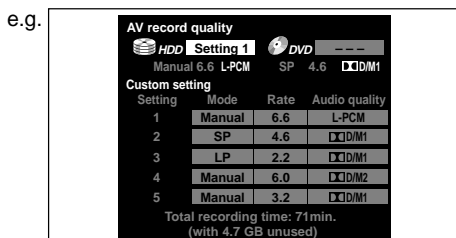

#### • To make a combination of picture and sound quality settings.

- 1) Press the ▲ / ▼ / ◀ / ▶ buttons to select the desired item (“Mode”, “Rate”, or “Audio quality”).
- 2) Press the ADJUST button to change the setting of each item.

#### • To apply the combination of picture and sound quality settings.

- 1) Press the ▲ / ▼ / ◀ / ▶ buttons to select a media to record on (HDD or DVD).
- 2) Press the ADJUST button to change the setting.

You can confirm the available recording time for the selected setting on the bottom screen.

- 3) Press the ENTER button.

#### Notes

- A combination of picture and sound quality settings can be set for HDD and DVD-RAM respectively.
- You can change the combination of picture and sound quality settings also by displaying the Quick Menu on a “LIBRARY MENU” or during stop mode, then selecting “AV record quality”. Either of the above methods updates the setting of this recorder.
- If you set “SP” or “LP”, you cannot select “L-PCM”.
- Depending on the sound quality settings, the upper limit for the picture quality setting differs.
- You can adjust the manual rate for picture quality by 0.2 Mbps from 2.0 to 9.2. (You cannot set the rate from 1.4 to 2.0.)

### Picture record mode

HDD DVD-RAM DVD-RW DVD-R

Adjusts problems with the brightness of video signals of TV broadcasts or other external input.

Press the ▲ / ▼ buttons to select the source, and the ◀ / ▶ buttons to select the mode.

(Only use this setting when you cannot adjust the brightness satisfactorily with the “Custom picture setting” in the “Picture/Audio settings” (▶ Page 157) of this recorder.)

#### Important:

- This setting changes the video signal to record and the recorded signal is not returned to the original state even when this setting is changed after recording. When duplicating from VHS tape, if you can check the video recording state beforehand, we recommend first playing back for a while and checking the overall brightness tendency, then setting an appropriate mode.

#### Standard:

The recorder records video signals of TV broadcasts or other external input without adjusting their brightness. Use this mode normally.

#### Mode 1:

The brightness of signals received with this recorder and external input signals is adjusted automatically.

#### Mode 2:

This setting is used to record the signals darker when the screen is too bright.

#### Mode 3, 4:

As the number rises, the signals are recorded brighter. Use these modes to adjust the brightness.

### Audio input level

HDD DVD-RAM DVD-RW DVD-R

Sets the audio input level of recorded sound. Press the ▲ / ▼ buttons to select the desired item, and then press the ◀ / ▶ buttons to adjust the input level.

#### RF (L):

Sets the input level for the left channel.

#### (R):

Sets the input level for the right channel.

#### Line, AV 1, AV 2 (L):

Sets the input level for the left channel of the external input connectors.

#### (R):

Sets the input level for the right channel of the external input connectors.

#### Aspect ratio(video mode)

DVD-RW DVD-R

To set the aspect ratio when recording onto a DVD-R/RW disc.

##### 4:3:

Fixes the aspect ratio at 4:3.

##### 16:9:

Fixes the aspect ratio at 16:9.

##### Note

- When the bit rate on "AV record quality" is set to "1.4(Mbps)", pictures are recorded in 4:3 aspect ratio even if "16:9" is selected.

#### DVD compatible mode

HDD DVD-RAM DVD-RW DVD-R

To set whether or not recording is to be performed in the format for which recording is allowed by the DVD-Video standard (video, audio and other data) during recording.

This selection is important for contents when recorded on this recorder, if they will be copied to DVD-R/RW.

##### Off:

For recording of contents which will not be copied to DVD-R/RW.

Both the left and right channel sounds are recorded. When recording directly on a DVD-R/RW disc, this is ineffective. The recorder will automatically regard this as "On (Mode I)," and record sound of the main channel only in stereo. Select "On (Mode I)" or "On (Mode II)" for a DVD-R/RW recording.

##### On (Mode I):

Records sound of the left channel only in stereo.

##### On (Mode II):

Records sound of the right channel only in stereo.

##### Notes

- When you select the manual rate of the picture quality between 3.0 and 3.8 and set this mode to "On (Mode I)" or "On (Mode II)", the picture quality may become lower than when you set this mode to "Off".
- You can change the setting from the Quick Menu.
- It is no use to make this selection when dubbing. Select when recording.

#### DVD-Video:CHP create

DVD-RW DVD-R

To set whether chapters are to be automatically created at a selected interval during DVD-R/RW recording.

##### Off:

Chapters are not set.

##### 5 min. : 10 min. : 15 min. : 20 min.

To set the interval at which chapters are automatically created to 5, 10, 15 or 20 minutes.

##### Note

- The number of chapters has the upper limit, which varies depending on the disc condition. If the number reaches it, no more chapters are created.

#### Relay recording

HDD DVD-RAM

Turn on or off a function that makes a recording automatically onto the HDD when the remaining space of a DVD-RAM disc is Reduced to less than 10 minutes or when a disc is not loaded.

##### Off:

Deactivates this function.

##### On:

Activates this function.

##### Notes

- The Relay recording does not function during the Rate conversion dubbing or Line-U dubbing.
- Even if you set "Relay recording" to "Off", A-B programmed recording will be performed on the HDD.
- During playback of the HDD when you start Relay recording and the "CONTENT MENU" is displayed, playback stops.
- During Relay recording, HDD Title Playback is not available.
- When the remaining space on the HDD is small, Relay recording does not function.
- Time slip function (▶ page 63) is not possible while "On" is selected.

## Management settings

### Genre setting

HDD DVD-RAM DVD-RW DVD-R

This registers a frequently used genre name onto the menu. Genre names registered here are displayed in the "Genre" on the Quick Menu.

- 1) Press the ▲ / ▼ buttons to select a position in the "Current genre list" you want to change, then press the ENTER button.

A list of genres appears.

You can turn the pages using the ► button.

- 2) Press the ▲ / ▼ buttons to select a genre, then press the ENTER button.

A list of genre names appears.

- 3) Press the ▲ / ▼ buttons to select a genre name, then press the ENTER button.

The selected genre name replaces the previous one of the position you selected at step 1).

- 4) Repeat steps 1) to 3) to register genre names.

- 5) When genre names are registered, press the O button to return to the "Management settings" menu.

### Eco. mode

To set the front panel display to turn on/off in the standby mode.

#### Off:

Sets the front panel display to turn on in the standby mode.

#### On:

Sets the front panel display to turn off in the standby mode.

### HDD auto stop

HDD

#### Off:

Turns off an HDD auto stop mode.

#### On:

Turns HDD drive off after recorder is idle for approximately 5 minutes.

When the PLAY or REC button is pressed for the HDD while the HDD drive is turned off, it takes a little longer time to play or record.

### All HDD titles delete

HDD

This deletes all the titles on the HDD. Only the recorded contents are deleted, so the DVD-RAM disc Library information and reservation history are left as is and can continue to be used.

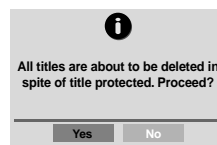

- 1) Press the ◀ / ▶ buttons to select "Yes", then press the ENTER button.

- 2) Confirm the message, press the ◀ / ▶ buttons to select "Yes" and then press the ENTER button.

Deletion of all titles starts.

If you want to cancel the deleting, select "No".

#### Note

- If you periodically execute All HDD titles delete, this holds down fragmentation (increased complexity) of the disc and maintains good operability.

### HDD Format

**HDD**

Initializes the HDD.  
 Normally it is not required to initialize the HDD. However when the HDD does not function correctly, initializing the HDD may solve the situation. If you initialize the HDD, all titles and Library information stored in the HDD are permanently deleted.

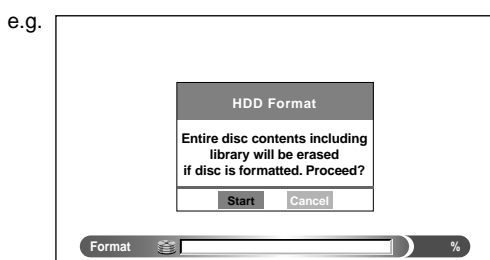

- 1) Press the ◀/▶ buttons to select “Start”, then press the ENTER button.
- 2) Confirm the message, press the ◀/▶ buttons to select “Start”, and then press the ENTER button.

Initialization of the HDD starts.  
 If you want to cancel the initializing, select “Cancel”.

### DVD-RAM physical format

**DVD-RAM**

See ➡ page 29.

## Setting of picture and sound quality for recording

	Sound setting					
	D/M1		D/M2		L-PCM	
Picture quality setting	DVD	HDD	DVD	HDD	DVD	HDD
SP	Yes	Yes	Yes	Yes	No	No
LP	Yes	Yes	Yes	Yes	No	No
MN	Yes	Yes	Yes	Yes	Yes	Yes
Auto	Yes	Yes	Yes	Yes	Yes	Yes

# Others

- Before calling service personnel
- Error codes on the display window
- Recording duration
- Language code list
- Specification

# Before calling service personnel

If you experience any of the following difficulties while using this unit, check the list below before consulting your nearest Toshiba dealer.

## Power

### ■ The power is not turned on.

- The power cord is not connected securely.  
→ Connect the power cord securely.

## Connection to your TV

### ■ There is no TV picture.

- The video cable to this recorder and your TV is not connected securely.  
→ Connect the video cable to this recorder and your TV securely.
- The input select on your TV is not set properly.  
→ Select the input to which this recorder is connected.

## TV reception

### ■ There is no picture.

- The antenna cable is not connected securely.  
→ Reconnect the antenna cable securely.

### ■ There is poor reception.

- Channel settings are not completed.  
→ Set the channel settings.
- The antenna cable is not connected securely.  
→ Reconnect the antenna cable securely.
- Antenna signal is poor.  
→ Consult your dealer for adjustment.

## Playback

### ■ A DVD or CD does not play.

- The format of the recorded data does not correspond to this recorder, or the region number is neither "1" nor "ALL".  
→ Check the disc.
- A defective or dirty disc is inside.  
→ Change the disc.
- The HDD mode is selected.  
→ Press the DVD button.

### ■ The HDD does not play.

- The DVD mode is selected.  
→ Press the HDD button.

### ■ During playback, picture noise appears.

- Picture noise may appear in the following cases. It is not a malfunction.  
→ There is picture noise in the original recording.  
→ Weather, reception conditions may cause noise.  
→ The data transmission rate is set to low.  
→ The image data processing of this recorder cannot follow dynamic movement on the screen. (Low video data rate)  
→ A physical error has occurred on the DVD disc.

If an error occurs during reading data of a disc, block-noises may be produced there. Repeated reading of this location where the error occurred (retry) can decrease the generation of block noise. However, it can also raise the possibility of unintended delays or stops of playback. In order to prevent them, the recorder limits the number of times of retry.

## Recording

### ■ Cannot be recorded on a DVD-RAM disc.

- The disc is protected from deleting data.  
→ Set the write-protect tab to the opposite of "PROTECT" (➡ page 8).
- The disc is protected by a PC or the recorder.  
→ Disable the protection on the device which protected the disc.
- The disc space is not sufficient.  
→ Delete unwanted data (➡ page 50) or prepare a new disc.
- The disc is not initialized.  
→ Initialize the disc (➡ page 28).
- The disc may contain errors.  
→ Complete the physical format on the disc (➡ page 29).
- The physical format on the disc is not completed.  
→ Complete the physical format on the disc (➡ page 29).
- The disc has been recorded in the NTSC system.  
You can replay a title that has been recorded in the NTSC system, but you cannot display it in the thumbnail or use the edit or dubbing functions.  
→ You can use the recorder to initialize the disc to use it with this recorder, but the contents will be lost. If you do not want to initialize the disc, you can still play it, but no other functions are available.

### ■ Cannot be recorded on the HDD.

- The DVD mode is selected.  
→ Press the HDD button.
- The disc space of the HDD is not sufficient.  
→ Delete unwanted data (➡ page 50) or move the contents to DVD-RAM discs (➡ page 106).
- Some causes such as power failure may set the recorder to reject the operation to protect the HDD.  
→ Copy necessary contents recorded in the HDD to a DVD-RAM disc, and initialize the HDD.

## Program

### ■ Timer programming cannot be completed.

- Clock setting has not been completed.  
→ Complete the clock setting (➡ page 30, "INSTALLATION GUIDE").
- The programs list is full.  
→ Cancel unwanted programs (➡ page 43).

### ■ VIDEO Plus+ recording does not work properly.

- Guide channel setting is not completed.  
→ Complete the guide channel setting (➡ page 37, "INSTALLATION GUIDE").

## Remote control

### ■ The remote control does not work.

- The batteries in the remote control are exhausted.  
→ Replace all the batteries in the remote control (➡ page 12, "INSTALLATION GUIDE").
- The light emitter of the remote control is not pointed at the receptor of this recorder.  
→ Point the emitter of the remote control at the receptor of this recorder.
- The receptor of this recorder is located too far away from the remote control.  
→ Operate the remote control within 7 meters (23 ft) from the receptor of this recorder.
- There are obstacles between the remote control and this recorder.  
→ Remove any obstacles.
- The receptor is disturbed by sunlight or fluorescent light.  
→ Change the place of this recorder or shield the light.
- The remote control mode is not appropriate.  
→ Adjust the remote control mode of the remote control and this recorder (➡ page 54, "INSTALLATION GUIDE").

## Clock

### ■ The clock blinks.

- Complete the initial setting again (➡ page 30, "INSTALLATION GUIDE").

### ■ The clock does not keep time.

- Set the time and date manually (➡ page 35, "INSTALLATION GUIDE").



# Error codes on the display window

The recorder display shows error codes in addition to the message screen.

Main examples are as follows.

The "\*\*\*" in the "ERR - \*\*\*" message indicates an error code. To delete this display, press the DISPLAY button on the remote control.

Error code	Description	
ERR-01	Error detected in the physical format.	
ERR-10	Exceeded volume detected.	• When creating a DVD-Video
ERR-11	Exceeded number of titles detected.	
ERR-12	Exceeded number of chapters detected.	
ERR-13	Copy protection information detected.	
ERR-14	DVD disc access error detected.	
ERR-15	Other errors detected.	
ERR-16	HDD access error detected.	
ERR-17	Wide image recorded at 1.4 Mbps detected.	
ERR-18	Different aspects detected in the same part.	
ERR-19	Different resolutions detected in the same part.	
ERR-1A	Different sound quality modes detected in the same part.	
ERR-1B	Invalid control information detected.	
ERR-1C	Parts created in other recorder.	
ERR-1D	Parts created with "DVD compatible mode = Off" detected.	
ERR-1E	Invalid parts detected.	• When creating a DVD-Video • When recording on DVD-R/RW • When dubbing to DVD-R/RW
ERR-1F	Unexpected error detected.	
ERR-2E	Menu encode error detected.	
ERR-2F	Overflow of the menu size detected.	
ERR-30	Exceeded maximum number of menus detected.	
ERR-31	Recovery writing executed from compatibility of drive and disc.	• When recording on DVD-R/RW
ERR-32	Incompatibility of disc format detected.	
ERR-33	Disc protected.	
ERR-34	Disc protected or system control data error detected.	
ERR-35	Exceeded volume in disc budget calculation detected.	
ERR-36	Recording failed. (Title not saved.)	
ERR-31	Recording failed. (Title saved.)	
ERR-38	Writing failed. (Title not reserved)	
ERR-39	Writing failed. (Title saved.)	
ERR-3A	Unexpected error detected.	
ER-7000	Possible error detected in the HDD.	

## Note

- If you find an error code other than listed above, consult your nearest TOSHIBA dealer.

# Recording duration

Sound rate	D/D/M1(192kbps)				D/D/M2(384kbps)				L-PCM				Remarks
	HDD		DVD-RAM		HDD		DVD-RAM		HDD		DVD-RAM		
	Hour	Minute	Hour	Minute	Hour	Minute	Hour	Minute	Hour	Minute	Hour	Minute	
1.4	106	30	06	04	95	21	05	26	58	33	03	19	
<b>2.0</b>	76	17	04	20	70	23	04	00	48	04	02	43	Picture quality rate for LP with D/D/M2.
<b>2.2</b>	70	10	03	59	65	08	03	42	45	34	02	35	Picture quality rate for LP with D/D/M1.
2.4	64	57	03	41	60	37	03	26	43	18	02	27	
2.6	60	27	03	26	56	41	03	13	41	16	02	20	
2.8	56	32	03	12	53	14	03	01	39	24	02	13	
3.0	53	06	03	01	50	10	02	50	37	42	02	07	
3.2	50	04	02	50	47	27	02	41	36	08	02	02	
3.4	47	21	02	41	45	00	02	33	34	42	01	57	
3.6	44	55	02	32	42	48	02	25	33	22	01	53	
3.8	42	43	02	25	40	48	02	18	32	09	01	48	
4.0	40	43	02	18	38	59	02	12	31	00	01	44	
4.2	38	54	02	12	37	19	02	06	29	56	01	41	
<b>4.4</b>	37	15	02	06	35	47	02	01	28	57	01	37	Picture quality rate for SP with D/D/M2.
<b>4.6</b>	35	43	02	01	34	22	01	56	28	01	01	34	Picture quality rate for SP with D/D/M1.
4.8	34	19	01	56	33	04	01	52	27	08	01	31	
5.0	33	01	01	51	31	52	01	47	26	19	01	28	
5.2	31	49	01	47	30	44	01	43	25	33	01	26	
5.4	30	42	01	43	29	42	01	40	24	49	01	23	
5.6	29	39	01	40	28	43	01	37	24	08	01	21	
5.8	28	41	01	36	27	48	01	33	23	29	01	19	
6.0	27	46	01	33	26	56	01	30	22	52	01	16	
6.2	26	54	01	30	26	08	01	28	22	17	01	14	
6.4	26	06	01	28	25	22	01	25	21	44	01	12	
6.6	25	21	01	25	24	39	01	23	21	12	01	11	
6.8	24	38	01	22	23	59	01	20	20	42	01	09	
7.0	23	57	01	20	23	20	01	18	20	13	01	07	
7.2	23	19	01	18	22	44	01	16	19	45	01	06	
7.4	22	42	01	16	22	09	01	14	19	19	01	04	
7.6	22	08	01	14	21	36	01	12	18	54	01	03	
7.8	21	35	01	12	21	05	01	10	18	30	01	01	
<b>8.0</b>	21	03	01	10	20	35	01	09	18	07	01	00	Manual maximum setting for L-PCM.
8.2	20	34	01	08	20	06	01	07					
8.4	20	05	01	07	19	39	01	05					
8.6	19	38	01	05	19	13	01	04					
8.8	19	12	01	04	18	48	01	02					
9.0	18	47	01	02	18	24	01	01					
<b>9.2</b>	18	23	01	01	18	01	01	00					Maximum value for the manual mode.

- The recording duration listed above is reference only. Not guaranteed.
- This recording duration applies to the DVD-RAM disc in its initialized condition. The display may vary depending on the disc.
- If you subtract the actual recording duration from the duration listed in this table, the calculated time period does not represent the remaining time.
- The consumption of space may vary depending on the picture and sound conditions of the recorded content.
- Use the remaining disc space display feature to see the remaining space in the DVD-RAM disc.

For D/D/M1 and D/D/M2, the digital recording technology for consumer products of Dolby Laboratories is used. Setting 1 (D/D/M1) records in Dolby Digital at 192 kbps, and Setting 2 (D/D/M2) records at 384 kbps.

# Language code list

**Table of languages and their abbreviations**

Abbreviation	Language	Abbreviation	Language	Abbreviation	Language
---	No alternate language	GN	Guarani	PT	Portuguese
CHI (ZH)	Chinese	GU	Gujarati	QU	Quechua
DUT (NL)	Dutch	HA	Hausa	RM	Rhaeto-Romance
ENG (EN)	English	HI	Hindi	RN	Kirundi
FRE (FR)	French	HR	Croatian	RO	Rumanian
GER (DE)	German	HU	Hungarian	RU	Russian
ITA (IT)	Italian	HY	Armenian	RW	Kinyarwanda
JPN (JA)	Japanese	IA	Interlingua	SA	Sanskrit
KOR (KO)	Korean	IE	Interlingue	SD	Sindhi
MAY (MS)	Malay	IK	Inupiak	SG	Sango
SPA (ES)	Spanish	IN	Indonesian	SH	Serbo-Croatian
AA	Afar	IS	Icelandic	SI	Singhalese
AB	Abkhazian	IW	Hebrew	SK	Slovak
AF	Afrikaans	JI	Yiddish	SL	Slovenian
AM	Amharic	JW	Javanese	SM	Samoan
AR	Arabic	KA	Georgian	SN	Shona
AS	Assamese	KK	Kazakh	SO	Somali
AY	Aymara	KL	Greenlandic	SQ	Albanian
AZ	Azerbaijani	KM	Cambodian	SR	Serbian
BA	Bashkir	KN	Kannada	SS	Siswati
BE	Belorussian	KS	Kashmiri	ST	Sesotho
BG	Bulgarian	KU	Kurdish	SU	Sundanese
BH	Bihari	KY	Kirghiz	SV	Swedish
BI	Bislama	LA	Latin	SW	Swahili
BN	Bengali, Bangla	LN	Lingala	TA	Tamil
BO	Tibetan	LO	Laotian	TE	Telugu
BR	Breton	LT	Lithuanian	TG	Tajik
CA	Catalan	LV	Latvian, Lettish	TH	Thai
CO	Corsican	MG	Malagasy	TI	Tigrinya
CS	Czech	MI	Maori	TK	Turkmen
CY	Welsh	MK	Macedonian	TL	Tagalog
DA	Danish	ML	Malayalam	TN	Setswana
DZ	Bhutani	MN	Mongolian	TO	Tongan
EL	Greek	MO	Moldavian	TR	Turkish
EO	Esperanto	MR	Marathi	TS	Tsonga
ET	Estonian	MT	Maltese	TT	Tatar
EU	Basque	MY	Burmese	TW	Twi
FA	Persian	NA	Nauru	UK	Ukrainian
FI	Finnish	NE	Nepali	UR	Urdu
FJ	Fiji	NO	Norwegian	UZ	Uzbek
FO	Faroese	OC	Occitan	VI	Vietnamese
FY	Frisian	OM	(Afan) Oromo	VO	Volapük
GA	Irish	OR	Oriya	WO	Wolof
GD	Scottish Gaelic	PA	Panjabi	XH	Xhosa
GL	Galician	PL	Polish	YO	Yoruba
		PS	Pashto, Pushto	ZU	Zulu

# Specification

## ■ Power requirement during operation

41W

## ■ Power requirement at standby

3.7W (Eco mode: off)

1.9W (Eco mode: on)

## ■ Power supply

230 - 240V AC, 50/60 Hz

## ■ Mass

4.7kg

## ■ External dimension

Width 430 x Height 78 x Depth 325mm

## ■ Tuner

System: Frequency synthesizer

Channel coverage: PAL I VHF: A-J, 11, 13, E2-E12

UHF: E21-E69

CATV: X, Y, Z, S1-S41, 1-53  
(48MHz to 464MHz, 8MHz steps)

Stereo: NICAM-I

## ■ Antenna input/output terminal

VHF/UHF: 75Ω, IEC Connector

## ■ Signal system

Standard PAL Colour TV system

## ■ Laser

Semiconductor laser, Wavelength: 650nm/780nm

## ■ Format

DVD-VR format

DVD-Video format

## ■ Image recording system

MPEG2

## ■ Sound recording system

Dolby Digital M1, M2, Linear PCM

## ■ VIDEO input

1.0Vp-p (75Ω), Sync signal negative,

Pin jack x 1 system, 1 in front

SCART socket x 2 at rear

## ■ VIDEO output

1.0Vp-p (75Ω), Sync signal negative,

Pin jack x 1 system, 1 at rear

SCART socket x 2 at rear

## ■ S-VIDEO input

(Y) 1.0Vp-p (75Ω), Sync signal negative,

(C) 0.286Vp-p (75Ω), 1 in front

Mini DIN4 Pin x 1 system

SCART socket x 1 at rear

## ■ S-VIDEO output

(Y) 1.0Vp-p (75Ω), Sync signal negative,

(C) 0.286Vp-p (75Ω), 1 at rear

Mini DIN4 Pin x 1 system

SCART socket x 1 at rear

## ■ COMPONENT output (Y, P<sub>B</sub>, P<sub>R</sub>)

Y output (green), 1.0Vp-p (75Ω),

Sync signal negative, Pin jack x 1 system

P<sub>B</sub>, P<sub>R</sub> output (blue, red), 0.7Vp-p (75Ω),

Pin jack x 1 system each

## ■ RGB input

(R) 0.7Vp-p (75Ω)

(G) 0.7Vp-p (75Ω)

(B) 0.7Vp-p (75Ω)

SCART socket x 1 at rear (AV2 only)

## ■ RGB output

(R) 0.7Vp-p (75Ω)

(G) 0.7Vp-p (75Ω)

(B) 0.7Vp-p (75Ω)

SCART socket x 1 at rear (AV1 only)

## ■ AUDIO input

2.0V (rms), 50kΩ or below, pin jack

(L, R) x 1 system

1 in front

SCART socket x 2 at rear

## ■ AUDIO output

2.0V (rms), 200Ω or above, pin jack

(L, R) x 1 system

1 at rear

SCART socket x 2 at rear

## ■ DIGITAL AUDIO OUTPUT BITSTREAM/PCM (OPTICAL terminal)

Optical connector x 1 system

## ■ DIGITAL AUDIO OUTPUT BITSTREAM/PCM (COAXIAL terminal)

0.5Vp-p (75Ω), pin jack x 1 system

## ■ CHANNEL CHANGE IR jack

This is for connection of the supplied IR control cable only.

## ■ DV input

4-pin x 1 in front

## ■ Remote control

Wireless remote control (SE-R0132)

## ■ Operating conditions

Temperature: 5°C ~ 35°C,  
Position: Horizontal

## ■ Clock display

24 hour digital display

## ■ Clock accuracy

Quartz (monthly deviation: approximately ±30 seconds)

## ■ Supplied Accessories

- Remote control ..... 1
  - Batteries (R03) ..... 2
  - Power cord ..... 1
  - Coaxial cable ..... 1
  - Video/Audio cable ..... 1
  - IR control cable ..... 1
  - OWNER'S MANUAL (INSTALLATION GUIDE) ..... 1
  - OWNER'S MANUAL (OPERATIONS) ..... 1
  - Quick Reference ..... 1
- The design and specifications may change without prior notice.
  - The Illustrations and screens described in this manual may be exaggerated or simplified for easy recognition and may be slightly different from the actual unit.

---

# *Memo*

---

# Memo

Introduction

Recording

Playback

Editing

Library

Function setup

**Others**