

TOSHIBA

LIQUID CRYSTAL
DISPLAY FEATURES
DIGITAL
TELEPHONE
USER GUIDE

BUSINESS
ELECTRONICS
SOLUTIONS



STRATA[®] DK

DIGITAL KEY
TELEPHONE SYSTEMS
STRATA DK280



Strata[®] **DK280**

LIQUID CRYSTAL DISPLAY FEATURES DIGITAL TELEPHONE USER GUIDE

© COPYRIGHT 1993 TOSHIBA AMERICA INFORMATION SYSTEMS, INC.

All rights reserved. No part of this manual may be reproduced in any form or by any means — graphic, electronic, or mechanical, including recording, taping, photocopying, or the use of information retrieval systems — without express written permission of the publisher of this material.

Issue 1, June 1993

TRADEMARKS AND SERVICE MARKS

The following trademarks and service marks are used in this document:

- STRATA? registered trademark of Toshiba America information Systems, Inc.

In accordance with U.S. Copyright Law, a license may be required from the American Society of Composers, Authors, and Publishers, or other similar organization, if radio or television broadcasts are used for the **Music-on-Hold** feature of this telecommunications system. Toshiba America Information Systems, Inc. disclaims any liability arising out of the failure to obtain such a license.

Toshiba America Information Systems, Inc. reserves the right to change any of this information including, but not limited to, product characteristics and operating specifications, without prior notice.

	Subject	Page
INTRODUCTION		
	General Description	iii
	Purpose.....	iii
	Organization.....	iii
	How to Use This Guide.....	iii
CHAPTER 1		
	LIQUID CRYSTAL DISPLAY.....	1-1
	Mode Definitions	
	Summary of LCD Functions.....	1-3
CHAPTER 2		
	FEATURE OPERATION.....	2-1
	Date/Time/Day Adjustment.....	2-1
	Call Forward Display.....	2-2
	To Set Call Forward.....	2-2
	Station-to-Station Message Waiting	2-3
	Voice Mail (VM).....	2-4
	Busy Field Display.....	2-5
	Mode Exit.....	2-5
	DISA Security Code: Add/Delete/Change	2-5
	Toll Restriction Override/Traveling Class Code Change.....	2-6
	Verified Account Code Change.....	2-7
CHAPTER 3		
	SOFT KEY OPERATION	3-1
	General Description.....	3-1
	How to Use Soft Keys	3-1
	Using Soft Keys to Make a Conference Call.....	3-1
	Soft Key Prompt Definitions.....	3-4
	Soft Key Activation.....	3-5
	Soft Key Deactivation	3-5
CHAPTER 4		
	MESSAGES AND MEMOS	
	LCD AlphaNumeric Messages, Names, Memos	4-1
	Storing a Message In Memory.....	4-1
	Recording a Message.....	4-1
	Recording a Message, Name, or Memo.....	4-1
	Preprogramming System Messages	4-3
	Adding to Preprogrammed Messages.....	4-3
	Messaging	4-3
	Calling Station Messaging.....	4-3
	Cancelling a Calling Station Message.....	4-4

Subject	Page
Setting/Changing Calling Station Messages	4-4
Storing LCD Name/Number Display	4-4
Speed Dial Memo	4-7
Timed Reminders With Memo	4-8
Message Sending	4-9
Called Station Messaging	4-9
Group Called Station Messaging	4-10
Remote Calling Station Messaging	4-10
Busy Station Messaging	4-11
INDEX	Index-I

FIGURE LIST

Figure	Title	Page
I-1	Sample Page	v
I-2	20-button Digital Speakerphone with Liquid Crystal Display	vi
4-1	Dialpad Information	4-2

GENERAL DESCRIPTION

The STRATA% DK 2000-series Digital Liquid Crystal Display (LCD) telephone provides you with display information and feature prompting to make call handling more efficient.

The LCD Feature Prompting with Soft Keys provides a quick and easy way to access frequently-used features. -If this feature is activated at your station, abbreviated feature prompts help guide you through the steps to performing specific tasks.

In addition, the LCD telephones provide you with Alphanumeric Messaging, Busy Lamp Field (BLF) Identification, Central Office (CO) Line, identification, Timed Reminders with Messaging, Speed Dial Memo Directory Dialing, Intercom User Name/Number Display, Call Duration Display, and Date/Time of Day Display.

PURPOSE

This document is designed as a feature operating guide for users of the 2000-series LCD telephones, as well as the 1000-series LCD telephones (models DKT201 O-SD, DKT2020-SD, and DKT1020-SD). This guide only covers the LCD functions of the digital telephone. It should be used in conjunction with the STRATA DK Digital Telephone User Guide.

An overview of this user guide will acquaint you with the various features that are available to your telephone, and will provide you with the necessary instructions to perform each feature.

ORGANIZATION

This user guide is divided into four main chapters. The first chapter explains the Liquid Crystal Display (LCD), including a summary of LCD functions and sample screens. The second chapter explains the operation of each specific calling feature. Operating instructions are provided in an easy-to-follow, step-by-step method. The third chapter explains the operation and use of the Soft Key feature, including a list of Soft Key prompt definitions. The fourth chapter details the message and memo features. An index is also included at the back of this user guide, allowing you to reference material quickly and easily.

HOW TO USE THIS GUIDE

Your telephone's specific calling allowances are determined by its Class of Service, as determined by system programming. Your system administrator can inform you which features are actually accessible from your specific telephone. Once you are aware of the features that are available to your telephone, review each feature's description and operational procedure contained in this guide.

To assist you in achieving greater performance efficiency, the information in this user guide is divided into distinct areas of content. Instructions for various procedures are referred to as Action Text and appear in the left-hand column of the page. Instructions appear in numerical sequence, enabling you to quickly perform a specific task. More detailed descriptions of these procedures, or explanations of their effects, are located in the right-hand column. The following illustration shows you the structure followed in each Feature Operation section.

ACTION TEXT

SPECIFIC INSTRUCTIONS ON HOW TO PERFORM A PROCEDURE ARE NUMBERED AND ENTERED IN THE LEFT-HAND COLUMN.

STRATA DK280 DIGITAL LCD TELEPHONE	FEATURE OPERATION
To Use Station-to-Station Message Waiting:	<p>3. XX ■ The amount of time (08-60 seconds) that the telephone will ring before Call Forward-No Answer or Call Forward-Busy-No Answer is invoked. The ring time does not have to be entered each time Call Forward is set—only when you want to change the number of seconds the telephone rings before it forwards.</p> <p>4. ■ Call forward is set:</p> <ul style="list-style-type: none"> ■ Central Office (CO) lines that ring at your station only will forward (CO lines that ring into more than one station will not forward). ■ CO line calls transferred to your station will forward. ■ Intercom calls will forward. ■ Call forward redirects the station hunt feature.
<p>1. Lift the handset.</p> <p>2. Dial the desired station number.</p> <p>3. The calling station user presses the Msg button to set the Msg LED on the called station.</p> <p>4. To answer the Msg LED indication from the called station, press the Msg button.</p> <p>5. To clear the Msg LED from the calling station, press the Intercom button, dial the station number and press the Msg button twice (or 7 7).</p> <p>6. To clear the Msg LED from the called station, press Intercom button, dial # 4 0 9.</p>	<p>STATION-TO-STATION MESSAGE WAITING</p> <p>If there is no answer (busy or DND), press the Msg button (or dial 7). This causes the Msg LED at the called station to flash. The called station's LCD displays the calling station's number.</p> <p>When the returned call is answered, the flashing Msg LED will turn off.</p> <p>NOTE: Up to four message waiting displays may be stored on the LCD. The station number in the left-most position will be called when the Msg button is pressed. To rotate the station numbers, press the Scroll button. The fourth message is reserved for the Message Center.</p>

- CHAPTER TITLES

- FIRST LEVEL HEADINGS

■ RESULTS OR DETAILS EXPLANATIONS OR DETAILS OF THE ACTION TEXT.

■ NOTES AND WARNING MESSAGES

figure I-1
Sample Page

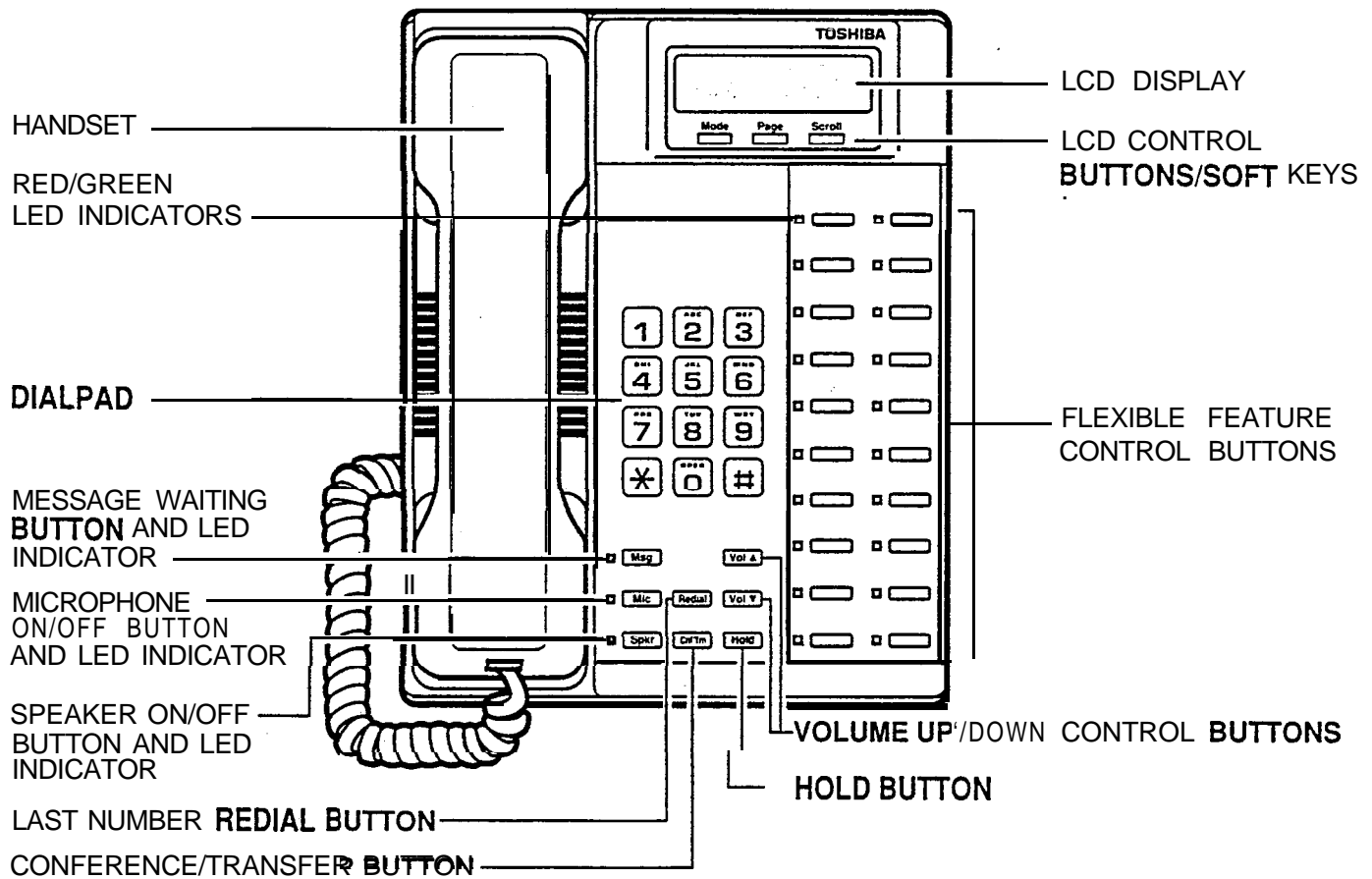
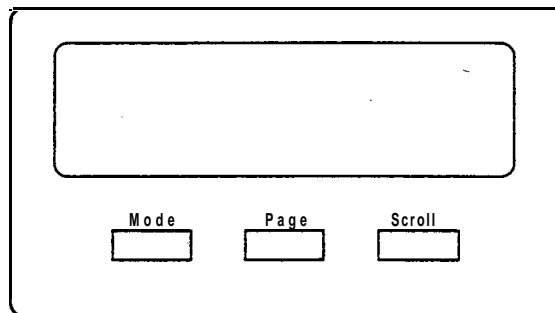

Figure I-2
20-button Digital Speakerphone with Liquid Crystal Display

LIQUID CRYSTAL DISPLAY

In its idle state, the 32-character Liquid Crystal Display (LCD) feature on your digital telephone gives you an accurate desk clock and calendar combination. When you have an outside call in progress, an elapsed time display gives a constant reminder of the call duration.. In addition, a variety of information displays and feature prompting makes your call handling more efficient. Alphanumeric messaging capability is also provided. All display functions occur automatically as call processing proceeds.



The uses of the three buttons shown above are:

Mode: 1. To enter/exit various mode functions (see "Mode Definitions" later in this chapter).

2. To cancel the beeping tone when using timed reminders.

Page: 1. Changes Busy Field groups.

2. Used by station 200 to record a user NAME/NUMBER for another station. Station 200 must be an LCD digital electronic telephone to record a NAME/NUMBER display for any other station type.

3. Changes displays (date/time, elapsed time, message, call forward, dialed number).

4. Scrolls through speed dial numbers when using Mode 8.

Scroll: 1. Scrolls through message waiting numbers.

2. Scrolls through the speed dial digits (if more than 16 digits) when in Mode 8.

NOTE:

If your telephone has the Soft Key feature turned on (Mode 71), the Mode, Page, and Scroll functions are not active when the telephone is busy on a CO line or Intercom call. Mode, Page, and Scroll are only used when the telephone is idle.

MODE DEFINITIONS

- MODE 0: Used to exit another mode and return to clock/calendar display.
- MODE 1: Busy Field display.
- MODE 2: Busy station messaging.
- MODE 4: Called station messaging.
- MODE 8: Speed dial number check and memo dialing.
- MODE 71: Soft key ON.
- MODE 70: Soft key OFF.
- MODE 94: Remote called station messaging.
- MODE 95: Remote calling station messaging.

SUMMARY OF LCD FUNCTIONS

IMPORTANT NOTE!

All Liquid Crystal Display (LCD) examples in this user guide are shown with soft keys turned OFF: If your telephone has soft keys turned ON, the displays may be different, but they will still allow you to follow the steps in this guide. Generally, the information shown on line 2 will display on line 1.

NOTE:

"NNN" in the display, as used here, represents either the called or calling extension or phone number of the other party. "1 -144" represents the line number used for the example.

Account Codes:

ND. NNN ENTER ACCT CODE 1

When you press a Central Office (CO) line that requires a forced (verified or nonverified) account code; or dial Speed Dial + 5 0, or press the Account Code button to enter a voluntary (verified or nonverified) account code.

NO. NNN CODE NOT VALID

When you dial a verified voluntary account code that is not valid.

NO. NNN CODE VERIFIED

When you correctly dial a verified voluntary account code that is set in the system account code memory.

NO. NNN DIAL RESTRICTED

When you dial a verified forced account code that is not valid.

N D. NNN DIAL TEL NUMBER

After you dial a verified forced account code that is valid.

Auto Busy Redial (ABR):

HOLD LINE NN ABR SET 1

After setting auto busy redial, your display prompts you that it has been set.

NO. NNN P 5 8 3 3 7 0 0

When the system dials the call, your display shows the dialed number. The system inserts a pause (P) before redialing the number.

When the called telephone is ringing, your station's Central Office (CO) LED (or Intercom LED) and Spkr LED will flash, and a warning beep will sound for 30 seconds after the call is completed.

NO. NNN LINE NNN ACB

Your station will display the called number, followed by "LINE NNN ACB", 30 seconds later.

**Automatic Callback
(ACB):**

NO. NNN
INT NNN ACB SET

When you set automatic callback at a busy station, its number is displayed.

NO. NNN
NNN ACB

When you receive an automatic callback, the station number you called is displayed.

NO. NNN
LINE 10 ACB

When you receive an automatic callback for a Central Office (CO) line, the seized line's number is displayed.

Automatic Line Selection:

1. Intercom Line

NO. NNN
INT

If your station automatically accesses an intercom line when you go off-hook, INT is displayed.

2. CO Line

NO. NNN
USING LINE 111

If your station automatically accesses a Central Office (CO) line when you go off-hook, the number of the seized CO line is displayed.

3. Dial Access Code

NO. NNN
USING LINE 20

When you access a Central Office (CO) line by dialing a CO line group access code, the accessed CO line number is displayed.

Alphanumeric Messages:

BACK AT 2PM-CALL
MEETING FOR 3PM

Messages of up to 32 characters may be used in alphanumeric messaging. Messages may either be programmed or set as one-time messages. (Messages may also be used with a timed reminder.)

Busy Field:

00 0...5...
107...

The Busy Field display indicates, in groups of 10, the last two digits of the station numbers that are busy or set for Do Not Disturb (DND). The top display indicates that stations X00, X05, and X17 are either in use or in DND mode; the bottom display indicates the same for stations X27, X32, X34, and X39. If the **Page** button is pressed, the 00/10 group will change to 10/20, and the busy/DND states of that group of stations will be displayed. The station groups will increment each time the **Page** button is pressed, thereby eventually displaying all stations..

207...
30 ..2.4....9

Forward:

CALL FORWARD TO

This LCD display appears when you initiate any type of call forward.

After you set call forward, the station number to which your calls will be forwarded is displayed, along with one of the following abbreviations:

- "CF-AC (Call Forward-All Calls)
- "CF-BUSY (Call Forward-Busy)
- "CF-NA" (Call Forward-No Answer)
- "CF-B/NA (Call Forward-Busy/No Answer)
- "CF-FIXED" (Call Forward-Fixed)
- "CF-EXT (Call Forward External)

NOTE:

CF-EXT has priority over all other Call Forward Displays.

When your call is forwarded to another station, the station you called is shown first. It then changes to the station to which your call was forwarded.

When a call is forwarded to your station, the calling station number is displayed on the left and the station called is displayed on the right.

NO. NNN
NNN

NO. NNN
NNN CALL NNN

Call Pickup:

NO. NNN
200 CALL 201

When you pick up an intercom call, the calling station's number is displayed on the left and the station number called is displayed on the right.

NO. NNN
NNN PICKUP NNN

Your LCD telephone displays information noting that your call to station NNN was picked up by station NNN.

Calling Number-Intercom:

NO. NNN
NNN CALLING

When you receive an intercom call, the calling station's number is displayed.

CO Line Identification:

TOSHIBA TELECOM

The Central Office (CO) lines can be programmed to display an identifying name of up to 16 characters. The name will be displayed on outgoing and incoming calls.

WATS LINE 3

CO Line Number:

1. Incoming Call

NO. NNN
LINE 10 RINGING

Incoming Central Office (CO) call-if your station is programmed for incoming ringing on that CO line.

2. When Call Is Answered

NO. NNN
ANSWERED LINE 3

Transferred CO call---CO line is transferred to your station in the ringing state by another station.

Camped-on CO call-CO line was camped-on to your busy station and rings your station when you hang up.

The display changes to indicate calling status.

3. Hold

HOLD LINE 10
JAN 01 SUN 12:18

You have put a CO line call on hold at your station.

4. Hold Recall

HOLD LINE NNN
LINE 10 RECALL

Held call automatically recalls your station after a programmed period of time.

5. Outgoing

NO. NNN
USING LINE 6

When you manually select a CO line, it is displayed. This display is replaced by the dialed number as you dial.

6. CO Line Queuing (Callback)

NO. NNN
LINE 3 ACE

When the CO line queuing feature rings back to your station with an available **CO line**, that line number will be displayed.

Date/Time:

NO. NNN
MAY 24 MON 12:05

1. Press the Page button to display date/time when talking on a Central Office (CO) line (Soft Keys must be off before the call is started).
2. The date/time is adjusted on a system-wide basis by the station located in port 00 (usually station 200).

Dialed Number:

1. CO Line

NO. INNN
5551374

The digits are displayed as you dial over either a Central Office (CO) line or the intercom using:

- Manual dialing
- Automatic dialing
- Repeat last number dialed
- Saved number redial

2. intercom

NO. NNN
201

NOTE:

If you are calling on a CO line, the display will automatically change from dialed number to elapsed time after a programmed period of time.

Door Phone/Monitor:

NO. NNN
DOOR PHONE 1A

When you are called from a door phone, its designating characters are displayed.

NO. NNN
DOOR PHONE 1A

When you call a door phone, its designating characters are displayed.

NOTE:

The door phone designators are NA, NB, and/or NC (N = 1~ 4, and indicate which of the 12 possible door phones is calling or is being called).

Elapsed Time:

NO. NNN
00:13:23

While you are making an outgoing Central Office (CO) line call, the elapsed time of the call is displayed. Elapsed time automatically replaces the dialed number on the display after a programmed period of time. (Timing begins when a LINE button is pressed.)

NOTES:

1. On a CO line call, the display can be alternated between date/time, elapsed time, and dialed number by pressing the Page button (Soft Keys must be off before the call is started).
2. Elapsed time is displayed for 15 seconds after you hang up, and then changes automatically to date/time.

Intercom Number
Display:

INT = NNN

To find out what your intercom or extension number is if does not appear on your display, press intercom # 4 0 1 or CONF # 4 0 1 when on a CO or Intercom Call and the intercom number will be displayed.

LCD Name/Number

Display:

1. Idle Station

NAME/NUMBER
DATE DAY TIME

A name or title may be set in memory for each station. When an LCD station is idle, the name displays on the top line of the LCD. When a station calls an LCD station, the name of the calling station displays on the bottom line of the called station's LCD.

2. Called Station

NO. NNN
NAME/NUMBER

Least Cost Routing
(LCR):

NO. NNN
DIAL TEL NUMBER 1

When you are making a call via Least Cost Routing (LCR), your display will prompt you to dial a number by displaying "Dial Tel Number".

NO. NNN
5833700

As you dial the number, it is shown on your display.

MessageWaiting:

NO. NNN
INT NNN MW SET I

When you set message waiting at another station, the number of that station is displayed.

SENT NNN
JAN 01 SUN 12:19

When you hang up after setting message waiting at another station, a reminder is shown on the top row of your display.

NO. NNN
CALL 203 201 2001

Your display will show the numbers of up to three stations that have left messages for you. Four numbers may be stored in message memory (see Recalling Station).

MessageWaiting/Voice Mail:

ND. NNN
CALL 200 216V+

When a message waiting voice mail is displayed, a "V" will follow the station number. A "+" indicates that there is a station message in memory. Press the Scroll button to rotate through more numbers.

Off-hook Call Announce:

NO. NNN
NNN

When you off-hook call announce to a busy station, your LCD displays the number of that station.

NO. NNN
NNN BUSY OVR

When another station off-hook call announces to your station, your LCD displays the number of that station.

Overrides:**1. Busy Override**

NO. NNN
NNN BUSY OVR

When you activate the override feature after calling a busy station, the station number and the feature are displayed.

2. Executive Override

NO. NNN
NNN BUSY OVR

Your LCD telephone displays the number of a station initiating override when you are on the telephone. The number will remain displayed until override is disconnected.

NO. NNN
NNN EXEC OVRD

When you initiate executive override, your LCD telephone displays the number of the station that is overridden. The station that receives the override displays your station number. The number will remain displayed until the call is ended.

Do Not Disturb
(DND)Override

NO. NNN
INT NNN DND

The station you have called is in the Do Not Disturb (DND) mode.

NO. NNN
NNN DND DVR

When you initiate Do Not Disturb override, the station number you have overridden is displayed.

NO. NNN
NNN DND DVR

When another station overrides Do Not Disturb at your station, its number is displayed. (The display remains until the end of override.)

4. Privacy Override

NO. NNN
NNN PRV DVRD

When a station presses a busy line button to enter an existing conversation, the station that initiates the override displays the Central Office (CO) line identification on the LCD. The overridden station's LCD displays the initiating station's number. (The display remains until the end of the call.)

Recalling Station:

HOLDLINE 2
LN 2 RECALL NNN

When a transferred call goes unanswered, it will recall to the station that transferred it. The display shows the Central Office (CO) line number and the station number to which it was originally transferred.

Speed Dial Memo:

*11 TOSHIBA
7145833700

When using Speed Dial Memo (Mode 8), the name and number are displayed.

TOSHIBA is the memo (up to 12 characters).
714 583 3700 is the number (up to 16 digits).

Toll Restriction Override Codes:

NO. NNN
OVERRIDE CODE

After you access a Central Office (CO) line and press **Cnf/Trn # 4 7** to dial a complete toll restriction override or traveling class code, your LCD display will prompt you to dial a code.

Two-CO Line Calls:

1. Tandem

TRK - TRK N₁N₂
JAN 10 THU 11:57

After you establish a two-Central Office (CO) line conference call and then release, N₁ and N₂ identify the connected CO lines.

2. Conference

NO. NNN
C D N F LINE N₁ N₂

When you are talking with two external parties on two CO lines, N₁ and N₂ identify the connected CO lines.

DATE/TIME/DAY ADJUSTMENT

This operation is possible from pot-t 00 only (usually station 200), and allows you to set the date, time, and day.

To Set the Date:

1. Place handset on-hook.
2. Dial Intercom # 6 5 1.
3. Dial the date
4. Press the Redial button.
5. Press the Spkr button.

Dial year/month/day in the format YYMMDD. Enter a leading 0 for any single-digit month or day.

You will hear a confirmation tone.

To Set the Time:

1. Place handset on-hook.
2. Dial Intercom # 6 5 2.
3. Dial the time
4. Press the Redial button.
5. Press the Spkr button.

Dial hour/minute/second in the 24-hour clock format HHMMSS. Enter a leading 0 for any single digit entered.

You will hear a confirmation tone.

To Set the Day:

1. Place handset on-hook.
2. Dial Intercom # 6 5 3.
3. Dial the day
4. Press the Redial button.
5. Press the Spkr button.

- 1** = Sunday
- 2** = Monday
- 3** = Tuesday
- 4** = Wednesday
- 5** = Thursday
- 6** = Friday
- 7** = -Saturday

You will hear a confirmation tone.

CALL FORWARD DISPLAY

TO SET CALL FORWARD

When any type of call forward is initiated, the 'CALL FORWARD TO' prompt displays on the lower row of the LCD.

When your station has call forward set, the LCD displays as shown on the left (NNN = the forward-to number).

Call Forward Displays:

1. Call Forward-All Calls

CF-AC TO: NNN
JAN 26 TUE 01:43

Press Intercom # 6 0 **1** + N N N + Spkr
(or **Call Frwd All** Calls + N N N + Call Frwd All Calls).

2. Call Forward-Busy

CF-BUSY TO: NNN
JAN 26 TUE 01:43

Press Intercom # 6 0 2 + N N N + Spkr
(or Call Frwd Busy + N N N + Call Frwd Busy).

3. Call Forward-No Answer

CF-NA TO: NNN
JAN 26 TUE 01:43

Press intercom # 6 0 3 + N N N + Speed Dial X X³ + **Redial** + Spkr
(or Call Frwd No Answer + N N N + X X³ + **Call Frwd No Answer**).

4. Call Forward-Busy/No Answer

CF-B/NA TO: NNN
JAN 26 TUE 01:43

Press intercom # 6 0 4 + N N N + Speed Dial X X³ + Redial + Spkr
(or Call Frwd **NAns** + N N N + X X + **Call Frwd NAns**).

5. Call Forward-Fixed

CF-FIXED TO: NNN
JAN 26 TUE 01:43

Press the **Call Frwd to:** button.

6. Call Forward-External

CF-EXT
JAN 26 TUE 01:43

Press Intercom # 6 7 0 or Press the CF-EXT button. Destination for **CF-EXT** is stored in Speed dial Memory *4 9.

NOTES:

- To cancel all types of Call Forward except Call Forward-fixed and Call Forward-external, press Intercom # 6 0 1 Spkr (or press the Call Forward button used to set Call Forward).
- To cancel Call Forward External press Intercom # 6 7 0 or press the **CF-EXT** button; to cancel **CF-FIXED**, press the Call Fwd To: button.

3. *XX = The amount of time (08~60 seconds) that the telephone will ring before Call Forward-No Answer or Call Forward-Busy/No Answer is invoked. The ring time does not have to be entered each time Call Forward is set-on/y when you want to change the number of seconds the telephone rings before it forwards.*
4. *if call forward is set:*
 - *Central Office (CO) lines-that ring at your station only will forward (CO lines that ring into more than one station will not forward).*
 - *CO fine calls transferred to your station will forward.*
 - *Intercom calls will forward.*
 - *Call forward redirects the station hunt feature.*

STATION-TO-STATION MESSAGE WAITING

To Use Station-to-Station Message Waiting:

1. Lift the handset.
2. Dial the desired station number.
3. The calling station user presses the **Msg** button to set the Msg LED on the called station.
4. To answer the Msg LED indication from the called station, press the **Msg** button.
5. To clear the Msg LED from the calling station, press the **Intercom** button, dial the station number and press the **Msg** button twice (or 7 7).
6. To clear the Msg LED from the called station, press **Intercom** button, dial # 4 0 9.

If there is no answer (busy or DND), press the Msg button (or dial 7). This causes the Msg LED on the called station to flash. The called station's LCD displays the calling station's number.

When the returned call is answered, the flashing Msg LED will turn off

NOTE:

*Up to four message waiting displays may be stored on the LCD. The station number in the left-most position will be called when the **Msg** button is pressed. To rotate the station numbers, press the Scroll button. The fourth message is reserved for the Message Center.*

VOICE MAIL (VM)

Whenever your station is call forwarded to voice mail, certain digits will automatically be sent to the voice mail unit to direct the call to your mailbox. These codes must only be stored one time; they remain in memory until changed. They do not have to be stored each time you Call Forward your telephone.

Setting your mailbox number (where calls will go when you forward to the Toshiba VP voice mail system).

The LCD displays "6 5 6 ID CODE SET".

The LCD displays the digits and pauses. These digits include special voice mail codes and your mail box number. For example, for Toshiba VP Systems dial 91 NNN, where NNN is your mail box-number.

You will hear a confirmation tone-the LCD displays "DATA PROGRAMED".

Assigning a mailbox to store messages:

1. Press the Intercom button.
2. Dial # 6 5 6.

6 5 6 ID CODE SET

3. Dial the digits (up to 16) and pauses to be sent.
4. Press the Redial button to store data.

DATA PROGRAMED

Assigning a mailbox for message retrieval:

1. Press the Intercom button.
2. Dial # 6 5 7.
3. Dial the required digits and pauses to be sent.
4. Press the **Redial** button to store data.

When you want to retrieve your messages from voice mail, certain digits will automatically be sent to the voice mail unit to play back your messages.

The LCD displays "6 5 7 ID CODE SET".

The LCD displays the data as it is entered. These digits include special voice mail codes and your mail box number. For example, for Toshiba VP Systems dial 92NNN, where NNN is your mail box number.

You will hear a confirmation tone-the LCD displays "DATA PROGRAMED".

To Retrieve Messages:

Press the Intercom and Msg buttons.

To Clear All Digits:

1. Press the Intercom button.
2. Dial # 6 5 6 or # 6 5 7.
3. Press the Redial button.

To Display Busy Field Status:

1. Press the **Mode** button.

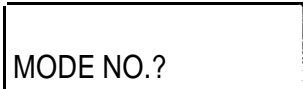

2. Dial 1.
3. Press the **Page** button to rotate Busy Field groups.

To Exit Any Mode:

1. Press the **Mode** button.
2. Dial 0.

BUSY FIELD DISPLAY

Your telephone must be idle to use the **Mode** button when Soft Keys are turned ON.

NOTE:

The Busy Lamp Field (BLF) mode will stop all other displays from appearing on your telephone LCD.

Refer to the figure in Chapter 1 Summary of LCD Functions.

MODE EXIT

The LCD displays "MODE NO.?" Your telephone must be idle to use the **Mode** button when Soft **Keys** are turned ON.

The LCD displays date/day/time.

DISA SECURITY CODE: ADD/DELETE/CHANGE

Direct Inward System Access (DISA) security codes can be added, deleted, and changed from designated station(s) only. For security purposes, the 3-digit access code is not given in this guide. It is available from your telephone system administrator.

To change or delete the DISA security code, these steps must be performed from a station that was selected in system programming.

You will hear a confirmation tone.

The DISA security code can be 1 ~ 15 digits.

To Store New DISA Security Code:

1. Press the **Intercom** button and dial the 3-digit access code.
2. Dial the new DISA security code.

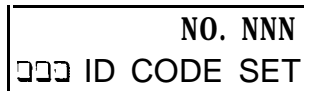

3. Press the Redial button.

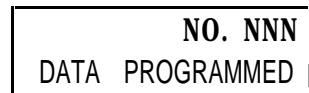

You will hear a confirmation tone.

- To cancel the DISA code, complete Steps 1 and 3, skipping Step 2.

If the DISA code is canceled, outgoing access of CO lines on DISA calls will not require a security code.

TOLL RESTRICTION OVERRIDE/TRAVELING CLASS CODE CHANGE

From selected stations the Toll Restriction override or Traveling Class codes can be changed, added, or deleted.

To add, delete, or change override for Traveling Class Code, the following steps must be performed from a station that was selected in system programming.

**To Add, Delete, or Change
Override/Traveling Class Codes:**

- Press **Intercom** and dial the three-digit toll restriction override change access code.

You will hear a confirmation tone.

NO. NNN
ENTER OVR CODE

- Dial the four-digit override code.

You should hear a dial tone. For security reasons, the change access code is not provided in this guide. It is available from your telephone system administrator.

NO. NNN
ENTER OVR CODE □□□□

- Press the **Redial** button to store the code.

You will hear a confirmation tone, and the code will be stored in memory. Press **RDL** or # if your telephone is not equipped with a **Redial** button.

_____, _____, _____, _____

- Repeat steps 1 ~ 4 to enter up to four traveling class codes or two toll restriction override codes.

➤ Add, Delete, or Change Verified Account Codes:

1. Press Intercom and dial the verified account code change access code.

NO. NNN
VERIFY ACC SET |

2. Dial the three-digit verified account code number (000 ~ 299).

NO. NNN
VERIFY ACC SET 000

3. Dial the verified account code (4 ~ 15 digits).

NO. NNN
000.000000000000

- . Press the **Redial** button to store code.

NO. NNN
DATA PROGRAMMED

5. Repeat steps 1 ~ 4 to enter more verified account codes.

VERIFIED ACCOUNT CODE CHANGE

To add, delete, or change a verified account code, these steps must be performed from a station that was selected in system programming.

For security reasons, the change access code is not provided in this guide. It is available from your telephone system maintenance provider.

The account code digit length is set in system programming.

You will hear a confirmation tone.

I

GENERAL DESCRIPTION

The Soft Key feature provides a quick and easy way to access frequently-used features. If the Soft Key feature is activated at your station, abbreviated feature prompts will appear on the LCD above the **Mode**, **Page**, and **Scroll** keys while you are on a call (or you are ringing another station or outside telephone number). You can access the feature represented by the feature prompt just by pressing the **Mode**, **Page**, or Scroll key beneath the prompt.

If the Soft Key feature is activated at your station, you can still access features with feature buttons (fixed or flexible) or with access codes.

When your telephone is idle, Soft Keys do not display and the **Mode**, **Page**, and **Scroll** keys function as normal. If your telephone is in use, Soft Key functions replace the **Mode**, **Page**, and Scroll functions.

HOW TO USE SOFT KEYS

This section provides an example of how to use Soft Keys to make a Conference call by adding a station to an outside call. Other features that can be accessed with Soft Keys include Transfer, Paging, and more.

USING SOFT KEYS TO MAKE A CONFERENCE CALL

1. While on an outside call with CO line (line 3 for this example) your LCD will display the following prompts:

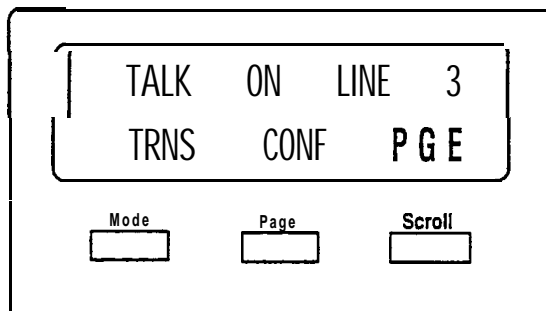

NOTE:

Once the Soft Key prompts appear (in this case, the Soft Keys are TRNS, CONF, and PGE for Transfer, Conference, and Page), the buttons below them now stand for Transfer, Conference, and Page instead of **Mode**, **Page**, and Scroll. In the following steps of this example, only the Soft Key displays will be shown since **Mode**, **Page**, and Scroll no longer apply while Soft Keys are active.

- If you initiated the call, the "TRNS" prompt will appear 30 seconds after the first digit of the telephone number is dialed-the "ABR" prompt for Automatic Busy Redial (ABR) will appear during this first 30 seconds (if it does not appear, then this feature was not assigned in system programming). If the call is an incoming call, the "TRNS" prompt will appear immediately when you answer the call.

TALK ON LINE 3
TRNS CONF PGE

2. Press the CONF Soft Key to initiate the Conference.
 - The outside call will be placed on hold and the LCD will appear as follows after you press the CONF Soft Key in Step 2.

LINE OR STATION?
LINE STA. RTRN

3. To transfer to a station, press the STA. Soft Key.
 - Whenever the RTRN Soft Key appears, you can terminate the operation and return to the outside call by pressing the RTRN Soft Key.

DIAL STATION NO.
RTRN

4. Dial a station number when the following LCD appears:
5. After you dial the station number (203 in this example), you will see one of the displays below for about three seconds. The display will then change to the display in Step 6.

CALLING
203

or

CALLING
TOM BROWN 203

Called station (203) has "user name" turned off.

Called station (203) has "user name" turned on.

6. After three seconds the user's name (or number) is replaced with the following display and you can voice announce to station 203;

ANNOUNCE. TO 203
TRNS RING RTRN

(voice first signalling)

or, when in TONE mode the following is displayed:

RINGING 203
MESGTALK RTRN

- You could stop the called station voice announce and make station 203 ring by pressing the RING Soft Key.
 - instead of proceeding with the Conference, you could transfer the call by pressing the **TRNS Soft** Key.
 - You could terminate the operation and return to the outside call by pressing the **RTRN Soft** Key.
7. The LCD will appear as follows after the called station answers. Your station is connected to Station 203 and the outside call remains on hold. Press the JOIN Soft Key to join all parties in a Conference.

TALK WITH 203
TRNS JOIN RTRN

- Instead of proceeding with the Conference, you could transfer the call by pressing the **TRNS Soft** Key.
 - You could terminate the operation and return to the outside call by pressing the RTRN Soft Key.
8. The LCD will appear as follows after you press the JOIN Soft Key in Step 5 and all parties will be conferenced.

LN3 + 203
EXIT CONF

- “LN 3 + 203” indicates that you are in a Conference with CO line 3 and Station 203.
- You can exit the Conference and the other parties will remain connected if you press the EXIT Soft Key.
- You can add another station or CO line by pressing the CONF Soft Key.

NOTE:

If the Soft Key feature is activated at your station, incoming call information will not display on your LCD while your station is busy. To display this information, you must either disconnect the existing call or place it on hold.

SOFT KEY PROMPT DEFINITIONS

The following list provides definitions of all of the Soft Key prompts that could appear on your LCD.

TRNS—Press this Soft Key to initiate or complete a Transfer while on an outside call. TRNS can cause an immediate or announced transfer, depending on how the feature is set in system programming.

CONF—Press this Soft Key to initiate or complete a Conference.

PGE—Press this Soft Key to park an outside call and to gain access to a menu of Page options.

RING—Press this Soft Key to make a called station ring when making a voice announce call to the station.

TALK—Press this Soft Key to make a voice announcement to a called station that is ringing.

MESG—Press this Soft Key to set a message waiting indication at a busy or unanswered station.

OVRD—Press this Soft Key to gain access to override options or to override a station that is busy or in the Do Not Disturb mode.

BUSY—(Busy Override) Press this Soft Key to send a call-waiting tone to a busy station.

EXEC—(Executive Override) Press this Soft Key to break into the conversation of a busy called station.

ACB—Press this Soft Key to activate Automatic Callback after reaching a busy station, CO line, or CO Line group.

ABR—Press this Soft Key to activate Automatic Busy Redial after dialing a busy outside telephone number.

RLS-Press this Soft Key to disconnect a call and to return to the idle state.

RTRN-Press this Soft Key to terminate a feature operation and to return to a previously displayed state.

LINE-Press this Soft Key to add a CO line to an existing call while in the Conference mode. The LCD will prompt you to access a CO line after you press this key.

STA.-Press this Soft Key to add a station to an existing call while in the Conference mode. The LCD will prompt you to dial a station number after you press this key.

JOIN-Press this Soft Key while on a conference call to join all parties to a Conference.

EXIT-Press this Soft Key to exit from a Conference and to leave the remaining parties connected.

To activate Soft Keys at your station:

1. Make sure your telephone is idle. Do not lift the handset.
2. Press the **Mode** key below the LCD.
3. Dial 7 1.

To deactivate Soft Keys at your station:

1. Make sure your telephone is idle. Do not lift the handset.
2. Press the **Mode** key below the LCD.
3. Dial 7 0.

SOFT KEY ACTIVATION

Your telephone must be idle before you follow the steps on the left to activate or deactivate the Soft Key feature at your station.

Soft keys are **now** activated and the appropriate feature prompts will display when your phone is in use. The Soft Key feature will remain on until you turn it off. In other words, you can perform numerous telephone functions and the Soft Keys will not be cancelled unless you deactivate them.

S&T KEY DEACTIVATION

Your telephone must be idle before you follow the steps on the left to activate or deactivate the Soft Key feature at your station.

Once you deactivate the Soft Keys, the feature prompts will no longer appear on the telephone display.

LCD ALPHANUMERIC MESSAGES, NAMES, MEMOS

The LCD on your telephone can be used to send or receive messages to or from other LCD telephone users. The LCD can also display the names/numbers of the person calling your telephone or the name of the person you are calling. Names and memos can also be set to display with speed dial numbers and timed reminders.

STORING A MESSAGE IN MEMORY

To Store a Message in Memory:

1. Press the **LCD Msg Select** (or **Intercom # 6 8**) button.

MSG NO.?

2. Dial the 2-digit message number to be stored.
3. Use the Recording a Message procedure to enter the message characters.
4. Press the **LCD Msg Select** (or **Spkr**) button.
5. Press the **LCD Msg Select** (or **Intercom # 6 8 Spkr**) button.

The LCD Msg Select LED flashes.

Personal message (10 ~ 19); system message (60 ~ 99 port 00 only). The current message, if any, will be displayed.

The LCD Msg Select LED lights steadily, and the LCD displays the message. The message will now be stored in system memory.

The LCD Msg Select LED goes out, and the message will no longer appear on the LCD, but it will remain in memory.

RECORDING A MESSAGE

RECORDING A MESSAGE, NAME, OR MEMO

Use this procedure to enter the characters of a personal message (10 ~ 19) or system message (60 ~ 99, Station 200 only), to add to a preprogrammed message, or to edit and set a new message. After calling up a message on your display (see Storing a Message in Memory, Steps 1 and 2 above), perform one of the following procedures:

To Record a Message:

1. Press the # button to access alpha characters. Refer to Figure 4-1 for an explanation of the dialpad buttons.
2. Press * or 1 to move the cursor (-) to the desired position (the left edge of the display for a new message, or two spaces to the right of the preprogrammed message to add information).
3. Press the button that has the letter you want to enter. Use the 0 button to shift from letter to letter on the button.
4. If you want to enter a number, press the # button to change to numeric characters. Press the # button again to return to alpha characters.
5. The following special characters are set by pressing 1 and then pressing 0 to step through the available characters: Q, Z, :, -, +, /.

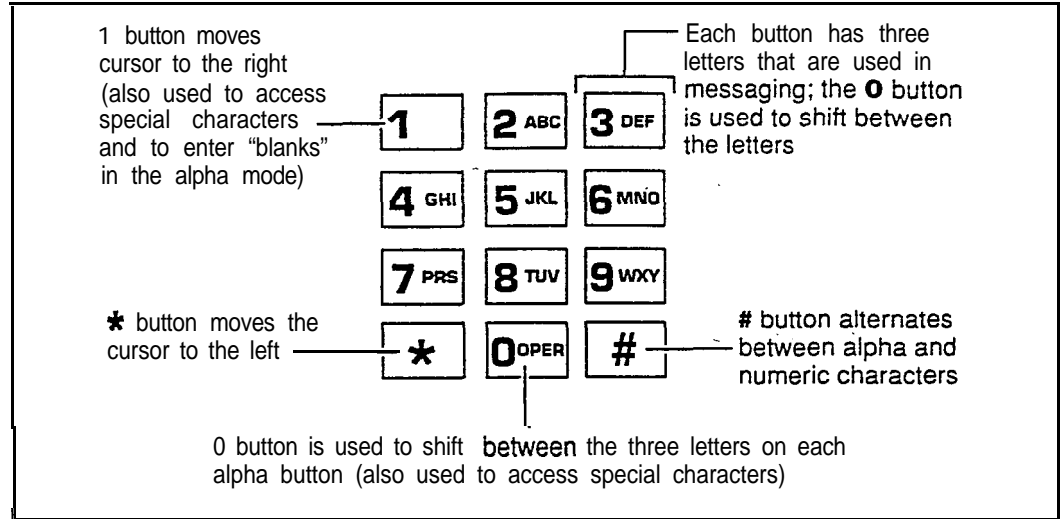

Figure 4-1
Dialpad information

For example: If you press 3, a "D" will be displayed. By pressing 0, the "D" is changed to "E". By pressing 0 again, the "E" is changed to "F". Press 0 again and the "F" changes to "D". To enter a space, press 1.

Numbers are also entered on the dialpad.

PREPROGRAMMING SYSTEM MESSAGES

System messages can only be programmed or permanently changed at port 000, station number (usually 200). Five preprogrammed messages are automatically stored in memory when the Alphanumeric Messaging with LCD feature is initialized.

- 60) OUT TO LUNCH
- 61) IN A MEETING
- 62) CALL _____
- 63) BACK AT _____
- 64) RETURN ON _____

You can use these messages and add 35 more messages designed specifically for your system, or you can overwrite the initialized messages and program up to 10 of your own. Any messages programmed at port 00 will remain in memory until canceled from port 00 or until the system is reinitialized. After reinitialization, only the original five messages will be in memory. System messages are written and stored in memory as explained in Storing a Message.

ADDING TO PREPROGRAMMED MESSAGES

When you select a message, it appears on your station display. A cursor (-) also appears immediately to the right of the last letter in the message. You can now input additional information (up to a total of 32 digits for each message). Some system messages may expect you to add more information. For example:

- 1. CALL _____
 - Add a station or outside telephone number.
- 2. BACK AT _____
 - Add the time you will return.
- 3. RETURN AT _____
 - Add the date you will return.

NOTE:

Refer to Recording a Message for adding to a preprogrammed message.

MESSAGING**CALLING STATION MESSAGING**

You can set a message that will appear on the LCD of telephones that call your telephone by following the instructions on the left.

The LCD Msg Select LED flashes, and the LCD displays "MSG NO.?"

**To Create an LCD
Message for Phones that
Call Yours:**

- 1. Press the LCD **Msg**
Select button (or
Intercom # 6 8).

MSG NO. ?

2. Dial the number of the message you want.
3. Press the **LCD Msg Select (or Spkr)** button.

Personal message (10 ~ 19) and system message (60 ~ 99). The selected message is displayed. (To add to this message, use the procedure for "Recording A Message," found earlier in this chapter.)

The LCD Msg Select LED lights steadily, and the selected message will be set. The message will be sent to LCD telephones that call your telephone.

CANCELLING A CALLING STATION MESSAGE

To Cancel a Message that Has Been Set at Your Station:

Press the **LCD Msg Select** button.

The LCD Msg Select LED goes out.

To Cancel a Message if You Do Not Have a LCD Msg Select Button:

1. Press the **Intercom** button.
2. Dial # 6 8.
3. Press the **Spkr** button.

The Intercom LED lights.

The Intercom LED goes out. A personal message (10 ~ 19) will remain stored in memory.

SETTING/CHANGING CALLING STATION MESSAGES

You can set a completely new, personalized message by overwriting any of the existing preprogrammed messages. To do this, simply call up one of the messages as explained previously. When the cursor appears to the right of the message, shift it to the left margin and write your new message over the preprogrammed one. The new message will remain on your station until canceled. It will then be erased and the original preprogrammed message will be restored.

NOTES:

1. Refer to *Recording a Message*-for leaving a new message at your station.
2. Messages 60 ~ 99 will be erased. Messages 10 ~ 79 will remain in memory until changed. The preprogrammed messages are never erased; only the user-added messages are erased.

STORING LCD NAME/NUMBER DISPLAY

This feature allows you to use your telephone to store a title (such as your name, telephone number, location, etc.) in system memory. This title (e.g., LOBBY) will display on your station's LCD while it is idle, and it will appear at other stations' LCDs when they are called from your station. Your NAME will display on other telephone LCDs when they are used to call your telephone (Soft Keys must be

To Enter Name/Number information:

1. Press the **Intercom** button and dial **# 6 2 1**.

USER NAME?

2. Enter the new information via the dialpad.

3. Press the **Spkr** button.

TOSHIBA EXT.200
DATE DAY TIME

To Clear Name/Number Display:

Press the **Intercom** button, dial **# 6 2 0** and press the **Spkr** button.

During clear:

NO. NNN
USER NAME RESET 1

After clear:

NO. 200
DATE DAY TIME

To Enter Name/Number Information for Other Stations/Devices:

1. Turn off Soft Keys by pressing **Mode 7 0**, when telephone is idle.

turned on). Name display information for non-LCD telephones or voice mail/auto attendant devices may be stored from station 200. When NAME/NUMBER is recorded for non-LCD telephones or other devices, their NAME/NUMBER is displayed on LCD telephones when called.

“USER NAME?” will appear on the upper line of the LCD.

Current information will appear on the lower line of the LCD.

Refer to “Recording a Message” earlier in this chapter for dialpad instructions. Up to 16 characters can be recorded. It is recommended that you enter the station number along with the user’s name (as shown in Step 3).

The new information is stored and will appear on the top line of the display. For example, if you entered “TOSHIBA EXT. 200,” that will appear above the date/day/time on the display.

You will hear a confirmation tone, then a busy tone.

NOTES:

1. Your title will appear on the LCD during direct intercom, forwarded, and hunted calls. On override or OCA calls, the LCD will not display the title.
2. After a name is cleared, it may be redisplayed at any time by dialing **Intercom # 6 2 1**.
3. A name is displaced by message and call forward settings if they are set.
4. To erase NAME/NUMBER information from memory, repeat Steps 1~3 above and enter blanks in Step 2. Blanks are entered by pressing **1** in the alpha mode.

Entering Name/Number information for other stations or devices is only allowed from Station 200.

2. Press the **Intercom** button and dial # 6 2 1.

USER NAME?

3. Press the **Page** button.

DEST EKT NO.?

4. Dial the intercom number (N N N) of the station for which the NAME/NUMBER information is to be recorded.

DEST EKT NO.NNN

5. Press the **Page** button.

USER NAME?

6. Enter the new information via the **dialpad** (refer to Recording a Message for method)
7. Press the **Spkr** button.
8. Repeat steps 2 ~ 7 to enter more names/numbers.
9. To turn Soft Keys on, press **Mode 7 1** when your telephone is idle.

“USER NAME?” will appear on the upper line of the LCD. Current information for station 200 will appear on the lower line of the LCD.

In this particular display, “EKT” stands for the intercom number of the digital, electronic or standard telephone.

“USER NAME?” will appear on the upper line of the LCD, and current information for station NNN will appear on the lower line of the LCD.

Up to 16 characters can be recorded. It is recommended that you enter the station number along with the user's name.

The new information is stored and appears on the top line of station NNN's LCD. Station 200's LCD returns to the normal idle display.

NOTES:

- To erase the NAME/NUMBER information of another station from station ZOO, repeat Steps 1 ~ 6 above and enter blanks in Step 5. Blanks are entered by pressing 1 in the alpha mode.
- Station NNN may set and clear the NAME/NUMBER feature anytime:
 - Set: **Intercom # 6 2 1.**
 - Clear: **Intercom # 6 2 0.** “Clear” eliminates the display when calling, but does not erase it from memory.

SPEED DIAL MEMO

This feature allows an LCD user to program a 12-character name for each of his/her 40 personal speed dial numbers. The memo pad of names may be stepped through to select the appropriate party. Memos may also be added to the 40 or 100 system speed dial codes, depending on your system's size, via the station connected to port 000, station number _____ (usually 200).

To Program Speed Dial Names and Numbers:

1. Press the **Redial** button, then the **Speed Dial** button.
2. Dial the desired speed dial code.

* NN SPEED DIAL

3. Press the **Mode** button.

* 10 NAME
SPEED DIAL

4. Enter the name or memo (refer to Recording a Message for method).
5. Press the **Mode** button.
6. Enter the desired telephone number (16 digits maximum).
7. Press the **Redial** button to record data in memory.
8. Repeat steps 2-7 to enter more memos.

To Dial a Speed Dial Number:

1. Press the **Mode** button when telephone is idle.

Press **SDS** or ***** if your telephone is not equipped with a **Speed Dial** button.

NN or NNN = Speed Dial Code. (10~49 station) or (60-99 or 600 ~ 699, depending on your particular system size, from station 200 only)

If a name was previously stored on this code, it will display on the top line of the LCD.

The name will appear on the bottom line of the LCD as you enter it.

The number will appear on the top line of the LCD as you enter it.

The LCD displays "MODE NO.?"

2. Dial 8 NN (NN = **1 0 ~ 4 9**, **6 0 ~ 9 9** or **NNN = 6 0 0 ~ 6 9 9**).

3. Press the **Page** button to scan the directory for the appropriate number/memo.
4. Press any available CO button.
5. The number is dialed.

The speed dial number appears with name or memo. Personal speed dial code numbers are 10 ~ 49, and system numbers, stored from station 200 only, are 60 ~ 99 or 600 ~ 699, depending on your system size.

To Check a Speed Dial Number:

1. Press **Mode 8** when telephone is idle.
2. Dial a 2-digit speed dial number.
3. Press the **Page** button to scan the directory for the appropriate number/memo.

NOTE:

The station must be enabled via system programming for LCD message memory

Personal speed dial number (10 ~ 49) or system number (600 ~ 699).

If the number is longer than 16 digits, a "+" will appear in the far right corner of the display. Press the Scroll button to display the remaining digits.

TIMED REMINDERS WITH MEMO

This feature allows **five** separate messages to be set at each LCD station. These messages will be displayed at the times (hour and minute) set by the station user. They can either be displayed just once or repeated on a daily basis.

To Set a Timed Reminder with Memo:

1. Press the **Intercom** button.
2. Dial a 3-digit reminder number (**# 6 0 5 ~ # 6 0 9**).
3. Enter the desired time for the message to be displayed.
4. Dial 0 if the message is to be repeated every day, or 1 if it is a one-time message only.

The 3-digit reminder number may be # 6 0 5 ~ # 6 0 9.

The message time must be in 24-hour clock format (i.e., HHMM).

Enter the desired message number, or 00 if no message should be stored.

6. Press the **Redial** button to record the data in memory.

Personal message (10 ~ 19) and system (60 ~ 99). The message does not display when setting a timed reminder—it displays when the reminder activates. Messages are set using the Record a Message method.

The LCD displays “DATA PROGRAMED”. You will hear a confirmation tone. The message will be displayed at the specified time, and a beeping tone will be heard for **30** seconds (or until it is canceled by pressing the **Mode** button and then dialing 0).

MESSAGE SENDING

The Alphanumeric Messaging feature on your LCD digital telephone enables you to set short text (up to 32 characters) at your station to ensure that you do not miss important calls. Any station may record a message; however, only stations with the LCD are able to display messages. Stations that do not use Soft Keys (Soft Keys Off: Mode 7 0) may send messages “live” to other LCD station users. To record messages, see the Recording a Message section in this guide.

Your system has up to 40 preprogrammed messages that may be sent to other LCD digital or electronic telephones. You can temporarily add to or change any of these messages, in order to leave a personalized message at your station (see Note below).

Some stations may record and save up to 10 personal messages to be used for all types of station messaging. This is a station option that is enabled in system programming.

CALLED STATION MESSAGING

Your station number and a message indication may be sent to another LCD station. When that station responds, it will receive the message. Soft Keys must be off (MODE 70) at the sending station for this feature to operate.

To Set a Called Station Message:

1. Dial the station number (station does not answer or is busy).
2. Press the **Mode** button.
3. Dial 4.
4. Enter the desired message number.
5. Press the **Msg** button.
6. Press the **Spkr** button to release.

The LCD displays “MODE?”

The LCD displays “MW TO STNNN MSG NO?”

Personal message (10 ~ 19), system message (60 ~ 99). The LCD displays the message.

“CALL NNNM” is displayed at the called station and the Msg LED flashes; “SENT NNNM” is displayed at your station. N = Station Number, M indicates that a message has been sent.

To Receive a Called Station Message:

Press the **Msg** button.

Press these buttons when your telephone MSG LED is flashing

To Set a "Called Station" Message for Another Station or Group of Stations:

1. Press the **Mode** button .
The LCD displays "MODE?"
2. Dial 9 **4**.
The LCD displays "MODE 94 DEST EKT NO. NNN?."
3. Dial the "destination" station's number (or enter # 3 0 for all stations, or # 3 1 ~ # 3 8 for page groups).
The LCD displays "MODE 94 DEST EKT NO.NNN" or the Station Group number. Enter #30 for all stations, or #31 ~ #38 to send the message to a group of stations.
4. Press the **Page** button.
The LCD displays "MODE 94 ORG EKT NO.?"
5. Dial the "originating" station's number.
Your number or another station number. The LCD displays "MODE 94 ORG EKT NO.NN".
6. Press the **Page** button.
The LCD displays "MSG NO.?"
7. Enter the desired message's number.
The LCD displays the message.
8. Press the **Page** button.
The LCD displays "MSG NO.?"
9. Press the **Mode** button.
The LCD displays "MODE NO.?"
10. Dial 0.
At originating station, the LCD displays date/day/time, and then displays "SENT NNNM". At the destination station, the LCD displays the originating station number and a message indication

Receive a Called &ion Message:

1. Press the Msg button.

REMOTE CALLING STATION MESSAGING

To Set a Calling Station Message for Another Station:

1. Press the **Mode** button when your telephone is idle.
2. Dial 9 5.
3. Dial the 'destination' station number.
4. Press the 'Page' button.
5. Enter the desired message number.
6. Press the **Page** button.

The LCD displays "MODE?"

The LCD displays "MODE 95 DEST EKT NO.?"

The LCD displays "MODE 95 DEST EKT NO.NN".

The LCD displays "MSG NO.?"

The LCD displays the message.

The LCD displays "MSG NO.?"

NOTE:

Group calling station messaging allows you to set a calling station message for only one station at a time.

Press the Mode
button.

The LCD displays "MODE NO.?"

8. Dial 0.

Your LCD shows the time and date. The message is displayed at the "destination" station. Any station calling the "destination" station receives the message.

BUSY STATION MESSAGING

When reaching a busy LCD station, a message can be sent to that station (an audible tone will be heard). The busy station may also return a message to the calling station's LCD. The two stations may continue this procedure to carry on a "silent" conversation. Soft Keys must be off (Mode 70) at the sending and receiving stations for this feature to operate.

To Send a Message to a Busy Station:

1. Call the desired station.
2. Press the **Mode** button.
3. Dial 2.

Listen for a busy tone.

The LCD displays "MODE NO.?"

The LCD displays "OVER TO STNN MSG NO?"

4. Enter the desired message number.
5. Press the **Page** button.

Personal message (10 ~ 19) and system message (60 ~ 99). The LCD display the message.

The LCD displays "MSG SEND". The destination station beeps four times and the message is displayed for 30 seconds, or until the originating station hangs up.

To Return a Message (within 30 seconds) from the Busy Station After Receiving a "Busy Station" Message:

1. Press the **Mode** button.
2. Dial 2.
3. Enter the desired message number.
4. Press the **Page** button.

The LCD displays "MODE NO?"

The LCD displays "OVER TO STNN MSG NO?"

Personal message (10 ~ 19) and system message (60 ~ 99). The LCD displays the message.

The LCD displays "MSG SEND".

- A
 - Account Code
 - Calls 1-3
 - Changes 2-6, 2-7
 - Alphanumeric Messages 1-4, 4-1
 - Auto Busy Redial Display 1-3
 - Automatic Callback Display 1-4
 - Automatic Line Selection Display 1-4
- B
 - Busy Field Display 1-4, 2-5
 - Busy Override Display. See Override Displays
 - Busy Station Messaging 4-1 1
- C
 - Call Forward 1-5, 2-2
 - All Calls 2-2
 - Busy 2-2
 - Busy/No Answer 2-2
 - Display 1-5
 - External 2-2
 - Fixed 2-2
 - No Answer 2-2
 - Setting 2-2
 - Call Number-Intercom Display 1-5
 - Call Pickup Display 1-5
 - Called/Calling Station Messaging. See Messages and Memos
 - Conference Calls 3-1
 - CO Line Identification Display 1-5
 - CO Line Number Display 1-5
- D
 - Date/Time/Day
 - Adjustment 2-1
 - Display 1-6
 - Dialed Number Display 1-6
 - Dialpad Information 4-2
 - Direct inward System Access (DISA) Security Code 2-5
 - Do Not Disturb Override Display. See Override Displays
 - Door Phone/Monitor Display 1-7
- E
 - Elapsed Time Display 1-7
 - Executive Override Display. See Override Displays
- G
 - Group Called Station Messaging. See Messages and Memos
- I
 - intercom Number Display 1-7
- L
 - Liquid Crystal Display
 - Feature Buttons 1-1
 - Functions 1-1, 1-3
 - Name/Number 1-7, 4-5
 - Least Cost Routing Display 1-7
- M
 - Message Waiting
 - Display 1-8
 - Use of 2-3
 - Messages and Memos 4-1
 - Busy Station Messaging 4-1 1
 - Called Station Messaging 4-9
 - Calling Station Messaging 4-3
 - Group Called Station Messaging 4-10
 - Preprogrammed 4-3
 - Recording 4-1
 - Remote Calling Station Messaging 4-10
 - Sending 4-9
 - Storing 4-1
 - System Messages 4-3
- Mode
 - Button 1-1
 - Definitions 1-2
 - Exit 2-5
- O
 - Off-hook Call Announce Display 1-8
 - Override Displays 1-8
- P
 - Page Button 1-1
 - Privacy Override Display. See Override Displays
 - Preprogrammed Messages. See Messages and Memos
- R
 - Recalling Station Display 1-9
 - Recording a Message. See Messages and Memos
 - Remote Calling Station Messaging. See Messages and Memos
- S
 - Scroll Button 1-1
 - Soft Keys 3-1
 - Prompt Definitions 3-4
 - Activation/Deactivation 3-5
 - Speed Dial
 - Display 1-9
 - Use of 4-7
 - Station to Station Message Waiting. See Message Waiting
 - Store a Message. See Messages and Memos
 - System Messages. See Messages and Memos
- T
 - Timed Reminders 4-8
 - Toll Restriction Override/Traveling Class Codes
 - Display 1-9
 - Setting 2-6
 - Two-CO Line Call Displays 1-9
- V
 - Verified Account Code 2-7
 - Voice Mail (Message Waiting)
 - Display 1-8
 - Use of 2-4