

Electromagnetic Flowmeter Converter

LF232 Type

INSTRUCTION MANUAL

TOSHIBA CORPORATION**NOTES**

Before using the equipment, please read this manual carefully and understand the contents, and then use the equipment correctly.

- NEVER attempt to operate the equipment in any ways that are not described in this instruction manual.
- After reading this manual, store it with care in a place where it can be referred to whenever needed.
- Please be sure that this manual is delivered to the personnel who will use this product.

NOTICE

Thank you very much for your purchase of our LF232 Type Electromagnetic Flowmeter Converter.

This instruction manual describes about the precautions required when using the LF232 converter, installation, configuration and maintenance. It is intended for the personnel in charge of the installation, operation and maintenance.

To use this product properly and safely, read this manual carefully before using this product. After reading this manual, store it in a place where it can be referred to whenever needed.

Toshiba LF232 electromagnetic flowmeter converters can be used in combination with various types of electromagnetic flowmeter detectors.

For the notes on usage, piping, installation, configuration and maintenance of the combined detector, check the model number of the combined detector and read the instruction manual of the relevant detector.

About **Safety Precautions**

Read the Safety Precautions described at the front carefully and understand the contents before using this product.

The “**Safely symbols**” used in the “**Safety Precautions**” are shown in a location such as in the margin to the left of the corresponding commentary in the main text.

This product does not conform to standards for overseas specific areas such as CE mark used in the EU market. Be careful that this product cannot be shipped to such areas where those standards are required.

NOTES

1. The reproduction of the contents of this Manual in any form, whether wholly or in part, is not permitted without explicit prior consent and approval.
2. The information contained in this Manual is subject to change or review without prior notice.
3. Be sure to follow all safety, operating and handling precautions described in this Manual and the regulations in force in the country in which this product is to be used.



SAFETY PRECAUTIONS

Safety signs and labels affixed to the product and/or described in this manual give important information for using the product safely. They help prevent damage to property and obviate hazards for persons using the product.

Make yourself familiar with signal words and symbols used for safety signs and labels. Then read the safety precautions that follow to prevent an accident involving personal injury, death or damage to property.

Explanation of signal words

The signal word or words are used to designate a degree or level of hazard seriousness. The signal words used for the product described in this manual are **WARNING** and **CAUTION**.



 WARNING	Indicates a potentially hazardous situation which, if not avoided, could result in death or serious injury .
 CAUTION	Indicates a potentially hazardous situation which, if not avoided, may result in minor to moderate injuries or in property damage .

Notes:

- 1 “Serious injury” refers to an injury such as loss of sight, physical damage, burns (high temperature or low temperature) electric shock, bone fracture and poisoning and the after effect of the injury remains or the injury requires hospitalization or long periods of outpatient treatment.
- 2 “Minor to moderate injuries” refers to burns, electric shocks, and so on, that do not require the injured person to be hospitalized or go to a hospital for a long period of time for medical treatment. “Property damage” includes all kinds of damage to property, equipment or materials.

Safety symbols

The following symbols are used in safety signs and labels affixed to a product and/or in the manual for giving safety instructions.

	Indicates an action that is prohibited. Simply DON'T do this action. The prohibited action is indicated by a picture or text inside or next to the circle
	Indicates an action that is mandatory. DO this action. The mandatory action is indicated by a picture or text inside or next to the circle.
	Indicates a potential hazard. The potentially hazardous situation is indicated by a picture or text inside or next to the triangle.













Color explanation

WARNING  Background color: Yellow and Red, Border: Black, Picture display: Black

CAUTION  Background color: Yellow, Border: Black, Picture display: Black







SAFETY PRECAUTIONS (continued)

Safety Precautions for Installation and Wiring

 CAUTION	
<p>■ Do not use the LF232 in an explosive atmosphere.</p> <p> Using this product in an explosive atmosphere can cause explosion.</p> <p>DON'T</p>	<p>■ Use an appropriate device to carry and install the LF232.</p> <p> If this product falls to the ground, injury, or malfunction of or damage to the product, can be caused.</p> <p>DO</p>
<p>■ Install a switch and fuse to isolate the LF232 from mains power.</p> <p> Power supply from mains power can cause electric shock or circuit break-down.</p> <p>DO</p>	<p>■ Do not modify or disassemble the LF232 unnecessarily.</p> <p> Modifying or disassembling this product can cause electric shock, malfunction of or damage to this product.</p> <p>DON'T</p>
<p>■ Turn off mains power before conducting wiring work.</p> <p> Wiring while power is applied can cause electric shock.</p> <p>DO</p>	<p>■ Ground the LF232 independently from power equipment. Type D (100 ohm or less ground resistance)</p> <p> Operating this product without grounding can cause electric shock or malfunction.</p> <p>DO</p>
<p>■ Turn off mains power before working on pipes.</p> <p> Working on pipes while power is applied can cause electric shock.</p> <p>DO</p>	<p>■ Use crimped terminal lugs for the terminal board and GND terminal.</p> <p> Loose connections can cause electric shock, fire from excessive current or system malfunction.</p> <p>DO</p>
<p>■ Do not conduct wiring work with bare hands.</p> <p> Remaining electric charge even if power is turned off can still cause electric shock.</p> <p>DON'T</p>	<p>■ Do not work on piping and wiring with wet hands.</p> <p> Wet hands may result in electric shock.</p> <p>DON'T</p>
<div style="border: 1px dashed black; padding: 10px; width: fit-content; margin: 0 auto;"> <p> The label shown left is placed near the terminal board for power supply on the converter.</p> <p>Be alert to electric shock.</p> </div>	

SAFETY PRECAUTIONS (continued)

Safety Precautions for Maintenance and Inspection

 CAUTION	
<p>■ Do not touch the LF232 main body when high temperature fluid is being measured.</p> <p> The fluid raises the main body temperature and can cause burns when touched.</p> <p>DON'T</p>	<p>■ Do not conduct wiring work when power is applied.</p> <p> Wiring while power is applied can cause electric shock.</p> <p>DON'T</p>
<p>■ Do not conduct wiring work with wet hands.</p> <p> Wet hands may result in electric shock.</p> <p>DON'T</p>	<p>The label shown left is placed near the terminal board for power input. (A black border and symbol on yellow triangle)</p> <p></p> <p>Be alert to electric shock.</p>
<p>■ Do not use a fuse other than the one specified.</p> <p> Using a fuse other than the one specified can cause system failure, damage or malfunction.</p> <p>DON'T</p>	<p>Use a rated fuse as follows:</p> <p>Fuse rating:</p> <ul style="list-style-type: none"> • 1A/250V for 100 to 240Vac or 110Vdc • 2A/250V for 24 Vdc or large meter size spec. 100Vac or partially filled pipes spec. 100Vac <p>Dimensions: Diameter 5.2 mm × 20 mm</p> <p>Melting time characteristic: Normal blow</p>

Usage limitation

- (1) This product is **not manufactured for applying to a system requiring safety directly involved human life as follows**. Please contact your nearest Toshiba representative if there is a possibility of using this product for such use.
 - **Main control systems of nuclear power plants, safety protection systems in nuclear facilities or other important systems requiring safety**
 - **Medical control systems relating to life support**
- (2) This product is **not approved for explosion-proof applications. Please do not use this product in an explosive atmosphere (explosion protection area)**.

Warranty and Limitation of Liability

Toshiba does not accept liability for any damage or loss, material or personal, caused as a direct or indirect result of the operation of this product in connection with, or due to, the occurrence of any event of force majeure (including fire or earthquake) or the misuse of this product, whether intentional or accidental.

Handling Precautions

To obtain the optimum performance from the LF232 converter for years of continuous operation, observe the following precautions.

(1) **Do not store or install** the flowmeter in:

- **Places where there is direct sunlight.** If this is unavoidable, use an appropriate **sunshade**. If the control keys (infrared switches) are exposed to direct sunlight, **they may not function correctly**.
- Places where there is snow and ice
Infrared switches may not function correctly.
- Places where **excessive vibration or mechanical shock** occurs.
- Places where **high temperature or high humidity** conditions obtain.
- Places where **corrosive atmospheres** exit.
- **Places that can be submerged under water.**
- **Place where there is slop floor.** To put the flowmeter temporarily on the floor, **place it carefully with something, such as stopper, to support it so that the flowmeter will not topple over.**
- **Places where there is following factors.**
 - ◆ Factors to impede infrared switch to operate properly
 - Intense light such as direct sunlight and reflected sunlight by window glass or metal plate
 - Place where brightness changes suddenly such as ON/OFF of lighting
 - Dense smoke or steam near the control panel
 - Those attached on the control panel such as rain (dew drop), snow, ice, mud and oil, and haze due to their attachment
 - Light reflecting object near the control panel, or reflecting object such as metal plate placed opposing to the control panel

When any of above factors is considered, take a measure for the proper operation of infrared switch such as to place a cover or to secure a space for at least a person to stand in front of the control panel.

When unable to avoid above factors, operate the EMF converter removing the factor by covering the control panel by hand so that light does not shine on it, by cleaning those attached on the control panel, or by standing in-between the reflecting object and the control panel to block the light.

(2) Wire cables **correctly and securely**.

Be sure to ground at the combined converter side (**class D grounding (grounding resistance 100Ω or less)**). Avoid a common ground **used with other equipment** where earth current may flow. An **independent ground** is preferable.

(3) The cable lead-in section must be tightened securely to keep air tightness.

(4) Keep the fluid to be measured from freezing.(This may damage the detector tube.)

(5) To prevent liquid leaks caused by corrosion, select materials appropriate for applicable fluids.

Handling Precautions (continued)

- (6) The converter housing **covers and the cable connections are tightened securely** at the time of shipment. Do not remove these covers or connections unless it is necessary to wire new cables or replace old ones. Otherwise, **gradual deterioration of circuit isolation or damage** to this product can be caused.
- (7) **Observe the following precautions when you open the converter housing cover:**
 - **Do not open the cover in the open air unprotected against rain or wind.** This can cause **electric shock** or cause **damage to the flowmeter electronics**.
 - **Do not open the cover under high ambient temperature or high humidity conditions or in corrosive atmospheres.** This can cause **deterioration of system accuracy** or cause **damage to the flowmeter electronics**.
- (8) This product may cause **interference to radio and television sets** if they are used near the installation site. **Use metal conduits etc. for cables to prevent this interference.**
- (9) Radio transmitters such as transceivers or cellular phones may cause interference to the flowmeter if they are used near the installation site. Observe the following precautions when using them:
 - **Close a transmitter cover** before using a transceiver.
 - Do not use a transceiver whose output power is more than **5 W**.
 - Move the antenna of a transceiver or a cellular phone **at least 50 cm** away from the flowmeter and signal cables when using it.
 - **Do not use a radio transmitter or a cellular phone near the flowmeter** while it is operating online. The transmitter or cellular phone's output impulse noise may interfere with the flowmeter.
 - **Do not install a radio transmitter antenna** near the flowmeter and signal cables.
- (10) For reasons of flowmeter failure, inappropriate parameters, unsuitable cable connections or poor installation conditions, the flowmeter may not operate properly. To prevent any of these problems causing a system failure, **it is recommended that you have preventive measures designed and installed on the flowmeter signal receiving side.**
- (11) **For piping and installation of the combined detector, check the model number of detector and read the instruction manual of the relevant detector.**

* We assume no responsibility for nonconformity caused by violation of precautions described in this manual or used in violation of the installation method and the operation method stipulated in a relevant ordinance or other regulations.

Table of Contents

1. Product Inspection and Storage	10
1.1 Product Inspection.....	10
1.2 Storage.....	10
2. Overview	11
3. Names of Parts	12
4. Installation	15
4.1 Cautionary Notes on Selecting the Installation Location	16
4.2 How to Install the Converter	17
5. Wiring	19
5.1 Installation Cables	20
5.2 External Connections	21
5.3 Cautionary Notes on Wiring.....	22
5.3.1 Cautionary Notes on Wiring between Detector and Converter.....	22
5.3.2 Cautionary Notes on Wiring between Instruments and Converter.....	22
5.4 Wiring Method	23
5.4.1 Terminal Treatment of Cable	23
5.4.2 Cable Connection.....	25
5.4.3 Grounding.....	27
5.5 Digital I/O Connections.....	29
5.6 Cautionary Notes on Replacing Converter.....	30
5.6.1 Replacing the LF230 Converter.....	30
5.6.2 Combination with an Existing Detector (for Large Meter Size).....	31
5.6.3 Replacement of partially filled pipes type	32
6. Operation	34
7. Display and Controls	36
7.1 Names and Functions of Display and Controls	37
7.2 Display Format	40
7.3 Basic Operations (Mode Switching, Setting Mode Operation, Total Counter Operation).....	43
7.3.1 Mode Switching	43
7.3.2 Setting Mode Operation.....	46
7.3.3 Password Input.....	49
7.3.4 Totalizer Operation	51
7.3.5 Maintenance Menu	53
7.4 Setting Menu List.....	54

8.	Parameter Settings / Adjustment	55
8.1	Parameter Setting Items.....	55
8.2	Parameters Check / Change	56
8.2.1	Exciting Current Value	56
8.2.2	Meter Size	58
8.2.3	Exciting Frequency.....	60
8.2.4	Flow Direction.....	62
8.2.5	Password Setting.....	64
8.2.6	Normal Indicating Unit	66
8.2.7	Custom Unit.....	69
8.2.8	Span Value (Range)	72
8.2.9	Damping Constant.....	79
8.2.10	Low Cutoff value.....	81
8.2.11	Current Output Setting Used When an Alarm Occurs	83
8.2.12	Display low cut On/Off	85
8.2.13	Output Low Limit Setting	87
8.2.14	Digital I/O Function	89
8.2.15	Count Rate (Pulse Rate) and Pulse Width	93
8.2.16	Preset Counter	98
8.2.17	Flow Rate High/Low limit Alarm.....	101
8.2.18	Fluid Empty Alarm	105
8.2.19	Self-Diagnosis Function.....	107
8.2.20	Rate-of-Change Limit Value and Control Time	110
8.3	Initial Settings When Shipped from the Factory	112
8.4	Fixed Value Output (Loop Check)	114
8.5	Zero Adjustment	118
8.5.1	Still Water Zero Adjustment	118
8.5.2	Zero Offset Adjustment.....	120
9.	Mag-Prover Calibration	122
9.1	Calibration Items.....	122
9.2	Converter Check / Calibration	123
9.2.1	0% Flow Rate Calibration (Zero Calibration)	123
9.2.2	50% Flow Rate Calibration	124
9.2.3	100% Flow Rate Calibration (Span Calibration)	125
9.2.4	Checking the Exciting Current Value	126
10.	Function Description	127
10.1	Digital I/O Specifications.....	128
10.2	Totalizer and Pulse Output	129
10.3	Multi-Range Functions.....	132

10.4	Flow Rate High/Low Limit Alarm Output.....	138
10.5	Fluid Empty Alarm Output.....	141
10.6	Preset Counter Output Function.....	142
10.7	Remote Still Water Zero Adjustment.....	146
10.8	Remote Selection of Fixed Value Output.....	147
10.9	Converter Error Alarm Output.....	148
11.	Communications Function	149
11.1	Connection with the HHT terminal.....	149
11.2	Procedure for Communication with HHT.....	151
11.3	Cautionary Notes on Communications.....	152
12.	Diagnosis and Alarms	153
12.1	Diagnostic messages.....	153
12.2	Output When an Error or Alarm Occurs.....	156
13.	Maintenance and Inspection	157
13.1	Maintenance.....	157
13.2	Troubleshooting.....	159
13.2.1	Flow rate is not indicated.....	159
13.2.2	Flow rate indication is not correct.....	160
13.2.3	Flow rate indication is not stable.....	161
14.	Principle of Operation	163
15.	Specifications	164
15.1	Specifications.....	164
15.2	Model Number Table.....	169
16.	Outline Drawing	171

1. Product Inspection and Storage

1.1 Product Inspection

The LF232 electromagnetic flowmeter is shipped in a cardboard box filled with cushioning materials. Open the package and check the following items:

- Are the following items included?

Electromagnetic flowmeter main unit	1 unit
Instruction manual	1 copy
Adjusting capacitor	1 piece (only for large meter size specification)

- Isn't there any damage to the main unit?
- Is the specification the same as when you placed an order?

If you find anything defective and unclear, contact the sales office from which you purchased the product or your nearest Toshiba representative.

The capacitor attached for large meter size specification can be used to improve the performance when combining the converter with an old type detector. This capacitor is usually not used. For details, see 5.3.1 "Cautionary Notes on Wiring between Detector and Converter"

1.2 Storage

Regarding the storage after the flowmeter is delivered and before starting installation work, be careful about the following items:

CAUTION

- Do not leave the flowmeter in a place such as outdoors where direct sunlight hits or a place exposed to rain and wind.
- Avoid places where humidity is extremely high or the temperature is extremely high or low and store the flowmeter in a well ventilated place.

<ul style="list-style-type: none">• Humidity range: 10 to 90% RH (no condensation)• Storage temperature range: -13 to 149 °F (-25 to 65 °C)
--

- Store the flowmeter in a place where vibration and shock does not occur.
- If the cover of the converter is left open while being stored, insulation may be deteriorated. Do not open the cover until the time of wiring for the converter.
- To place the flowmeter temporarily on the floor, use a stopper, etc. when needed to prevent it from rolling over.

2. Overview

The electromagnetic flowmeter is an instrument to measure the volumetric flow rate of conductive fluids using Faraday's law of electromagnetic induction.

The flowmeter consists of a detector which generates a signal of electromotive force proportional to the flow rate of the fluid and detects this signal, and a converter which converts the signal detected by the detector to a unified signal output.

● Features

The electromagnetic flowmeter has features such as:

- No pressure loss by piping
- Flow measurement can be made not affected by conditions such as fluid temperature, pressure, density and flow condition.
- It is easy to read the flow indication because a liner relation exists between the flow rate and output signal.

The LF232 converter has additional features described below:

- (1) High accuracy measurement of $\pm 0.5\%$ of rate can be obtained in the velocity range of 1.0ft/s to 32.8ft/s (0.3m/s to 10m/s). (Measurement range and accuracy are different by detector.)
- (2) Stable measurement can be made even with fluids containing solids (sludge and slurry).
 - The unique Noise-Sentry filter circuit and arithmetic logic unit (ALU) enables you to obtain a stable output.
- (3) The converter is equipped with various display and output functions.
 - Various display and output functions can be easily set by switch operation.
 - The converter is equipped with worldwide standard HART* protocol communication.
- (4) Use of infrared switches
 - Use of infrared switches allows you to perform various operations without opening the converter housing cover.
- (5) Easy-to-read liquid crystal display (16 characters \times 2 lines)
 - It is easy to read the indication even in a dark place by means of backlight.

* HART protocol.....“HART” stands for Highway Addressable Remote Transducer and is a communication protocol recommended by HCF (HART communication Foundation) for industrial sensors.

3. Names of Parts

● Appearance

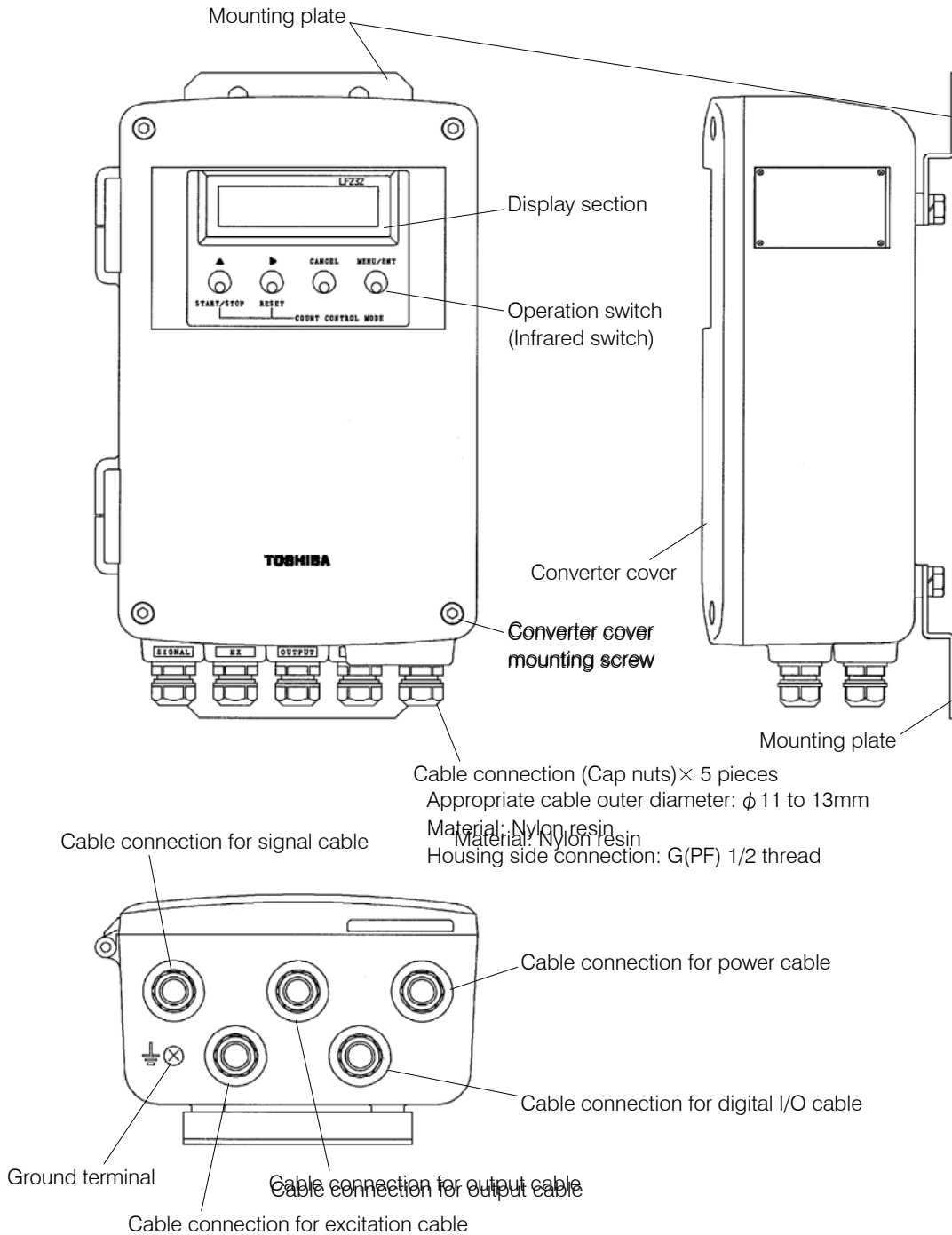

● Internal structure (with converter cover opened)

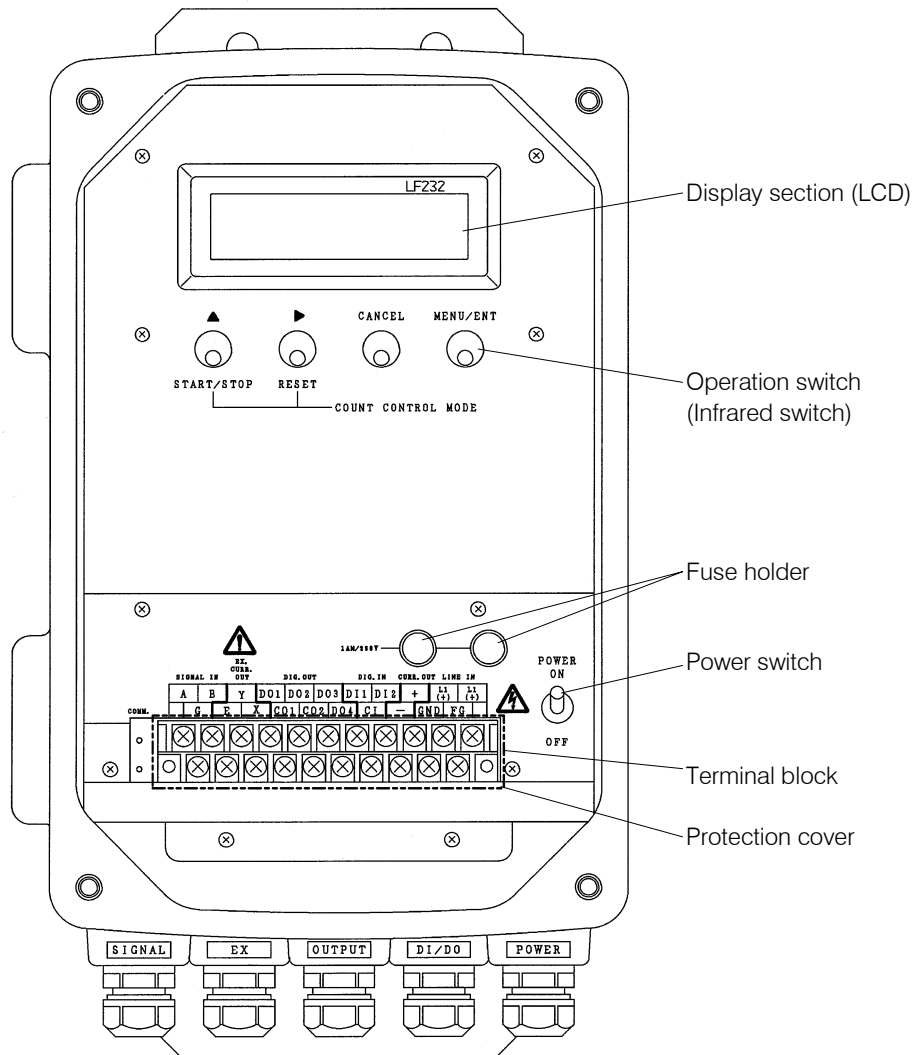

● Terminal block construction

⚠ CAUTION





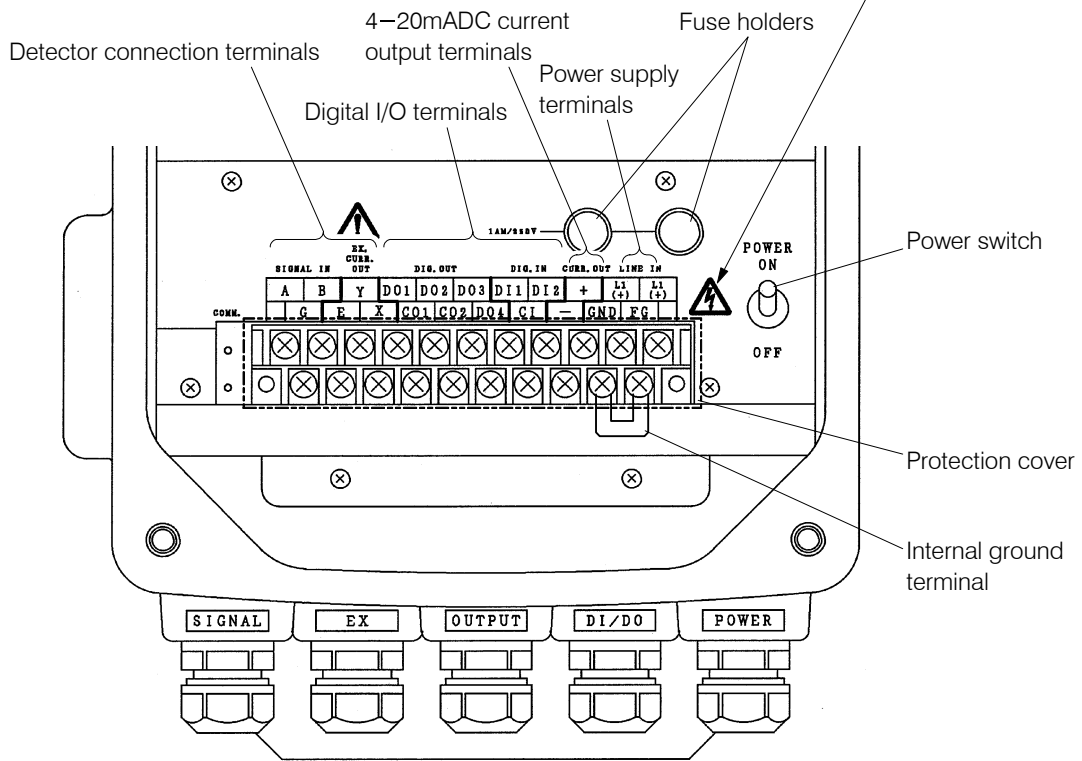

The label shown left is placed near the terminal board for power supply on the converter.

Be alert to **electric shock**.



4. Installation

● Cautionary notes on installation

 CAUTION	
<p>■ Do not use the LF232 in an explosive atmosphere.</p> <p> Using this product in an explosive atmosphere can cause explosion.</p> <p>DON'T</p>	<p>■ Use an appropriate device to carry and install the LF232.</p> <p> If this product falls to the ground, injury, or malfunction of or damage to the product, can be caused.</p> <p>DO</p>
<p>■ Do not modify or disassemble the LF232 unnecessarily.</p> <p> Modifying or disassembling this product can cause electric shock, malfunction of or damage to this product.</p> <p>DON'T</p>	<p>■ Ground the LF232 independently from power equipment. Type D (100 ohm or less ground resistance)</p> <p> Operating this product without grounding can cause electric shock or malfunction.</p> <p>DO</p>
<p>■ Do not work on piping and wiring with wet hands.</p> <p> Wet hands may result in electric shock.</p> <p>DON'T</p>	<p>The label shown left is placed near the terminal board for power input. (A black border and symbol on yellow triangle)</p> <p></p> <p>Be alert to electric shock.</p>

4.1 Cautionary Notes on Selecting the Installation Location

CAUTION

- (1) Avoid places within the immediate proximity of the equipment producing interference to measurement (such as motors, transformers, radio transmitters, electrolytic cells, or other equipment causing electromagnetic or electrostatic interference).
- (2) Avoid places where excessive vibration occurs.
- (3) Avoid places where there is direct sunlight as much as possible. If this is unavoidable, provide a sunshade, etc.
- (4) Avoid places where high corrosive atmosphere or high humidity condition exists.
- (5) Avoid places of too great an elevation or constricted areas and install the flowmeter in a place easy for necessary work.
- (6) The standard length of the cable that connects the detector and the converter is 30m. Select a converter installation location so that the distance of the detector and the converter will not exceed 30m.
- (7) If direct sunlight hits the display and the operation section or if there is something nearby that easily reflects light, this kind of light becomes disturbance light and the switch operation may not work correctly. Be careful about the installation location and angle, or take measures such as providing a sunshade or shield plate so that disturbance light does not hit the operation section directly.
- (8) Places where there is following factors.
 - ◆ Factors to impede infrared switch to operate properly
 - Intense light such as direct sunlight and reflected sunlight by window glass or metal plate
 - Place where brightness changes always such as ON/OFF of lighting
 - Dense smoke or steam near the control panel
 - Those attached on the control panel such as rain (dew drop), snow, ice, mud and oil, and haze due to their attachment
 - Light reflecting object near the control panel, or reflecting object such as metal plate placed opposing to the control panel

When any of above factors is considered, take a measure for the proper operation of infrared switch such as to place a cover or to secure a space for at least a person to stand in front of the control panel.

When unable to avoid above factors, operate the EMF converter removing the factor by covering the control panel by hand so that light does not shine on it, by cleaning those attached on the control panel, or by standing in-between the reflecting object and the control panel to block the light.

4.2 How to Install the Converter

The converter can be mounted on a panel, wall or on a pipe stand. Install the converter so that the front of the converter cover stays vertically straight and the cable ports of the converter stay at the bottom. Figure 4.1 shows an example of panel and wall mounting installation and Figure 4.2 shows an example of pipe stand installation.

Unit: inch (mm)

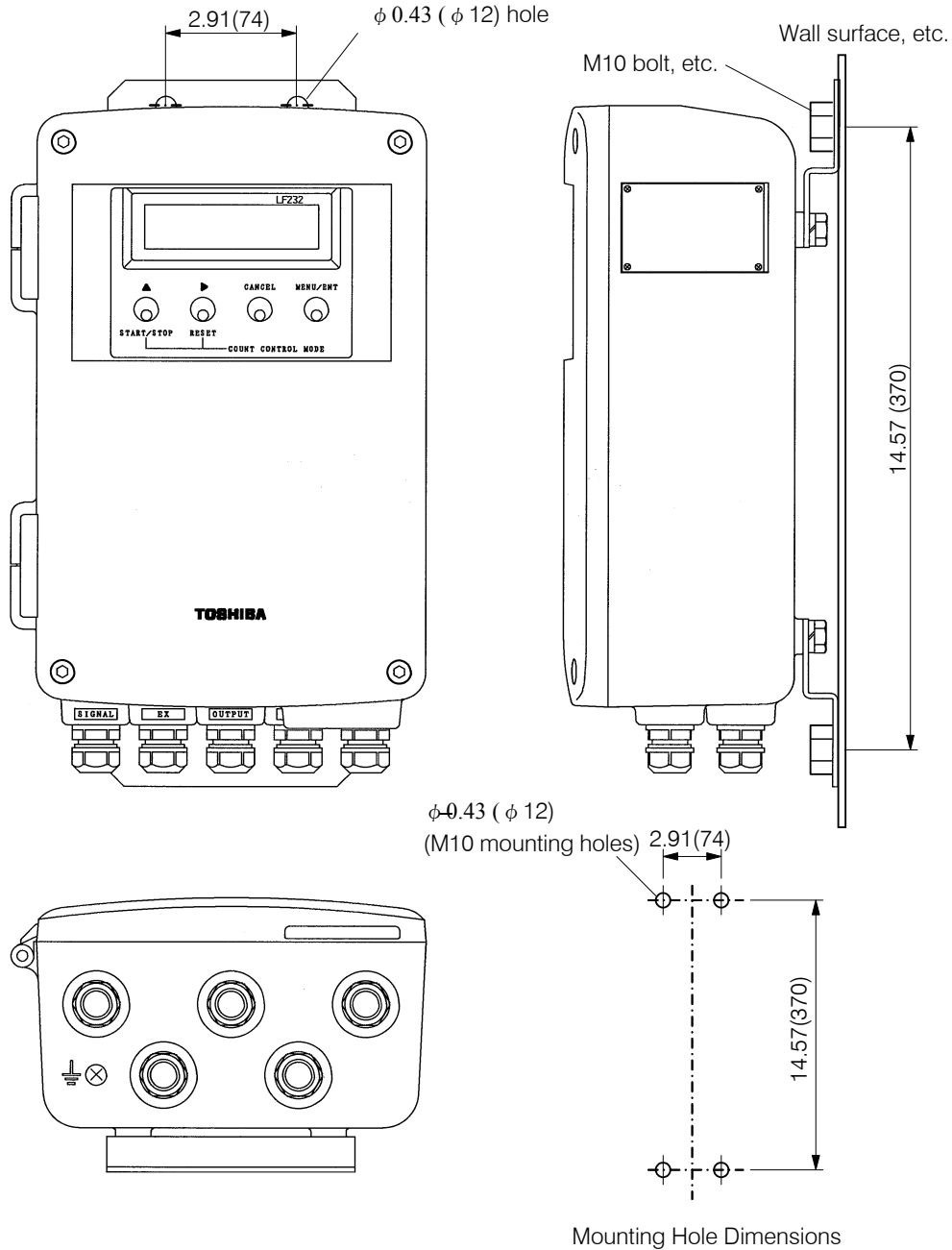

Figure 4.1 Example of Panel and Wall Mounting

Unit: inch (mm)

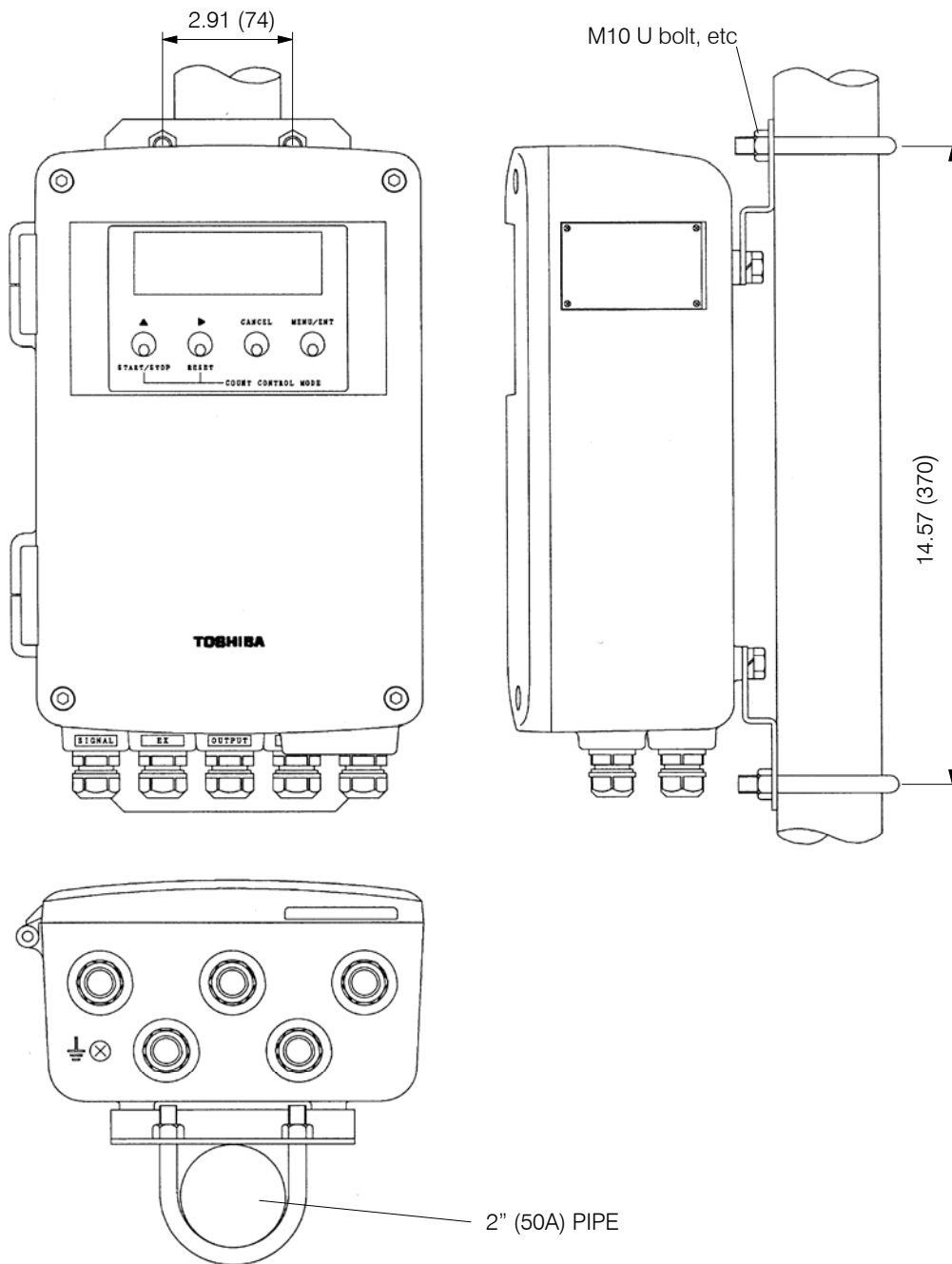











Figure 4.2 Example of Pipe Mounting

5. Wiring

● Cautionary notes on wiring

 CAUTION	
<p>■ Turn off mains power before working on pipes.</p> <p> Working on pipes while power is applied can cause electric shock.</p> <p>DO</p>	<p>■ Install a switch and fuse to isolate the LF232 from mains power.</p> <p> Power supply from mains power can cause electric shock or circuit break-down.</p> <p>DO</p>
<p>■ Do not work on piping and wiring with wet hands.</p> <p> Wet hands may result in electric shock.</p> <p>DON'T</p>	<p>■ Ground the LF232 independently from power equipment. Type D (100 ohm or less ground resistance)</p> <p> Operating this product without grounding can cause electric shock or malfunction.</p> <p>DO</p>
<p>■ Do not conduct wiring work with bare hands.</p> <p> Remaining electric charge even if power is turned off can still cause electric shock.</p> <p>DON'T</p>	<p>■ Use crimped terminal lugs for the terminal board and GND terminal.</p> <p> Loose connections can cause electric shock, fire from excessive current or system malfunction.</p> <p>DO</p>
<p>■ Do not modify or disassemble the LF232 unnecessarily.</p> <p> Modifying or disassembling this product can cause electric shock, malfunction of or damage to this product.</p> <p>DON'T</p>	<div style="border: 1px dashed black; padding: 5px;"> <p> The label shown left is placed near the terminal board for power input. (A black border and symbol on yellow triangle)</p> <p>Be alert to electric shock.</p> </div>

Flowmeter performance may be affected by the way wiring is carried out. Proceed with correct wiring by observing the following items.

CAUTION

- (1) For cable route, avoid places near electrical equipment (such as motors, transformers or radio transmitters) which cause electromagnetic or electrostatic interference.
- (2) If the converter interior or cable ends get wet or humidified, deterioration of insulation occurs and this may cause malfunction or noise problems. Avoid a rainy day if wiring is carried out outdoors. Even indoors, make arrangements to prevent water from splashing over the converter and try to finish the wiring as quickly as possible
- (3) Since the excitation cable and the flow rate signal cable carry very small signals, pass each of the cables separately through a thick steel conduit and keep them away from large current wiring as much as possible, and do not install them in parallel.

- (4) If the converter needs to be installed in a location where watertight installation is required, make unused cable ports watertight. (Be careful that the attached blind plate is used for dustproof purpose and it is not effective for watertight installation.)
- (5) The converter has a surge arrestor/protector installed inside. Therefore, do not conduct a withstand voltage test for the converter. In addition, to check the insulation of the converter, use a voltage of 250VDC or less.
- (6) When wiring is completed, be sure to install the protection cover of the terminal block.

5.1 Installation Cables

Use the kind of cables shown in Table 5.1 to connect to the converter.

Table 5.1 Installation Cables

Name	Cable name	Nominal cross-sectional area	Overall diameter	Description
Flow rate signal cable	2-core shielded chloroprene cabtyre cable (Rubber covered cable)	0.75mm ²	0.433–0.512 inch (11–13mm)	JIS C 3327 or equivalent
Excitation cable	3-core chloroprene cabtyre cable (Rubber covered cable)	2mm ² 1.25mm ²	0.433–0.512 inch (11–13mm)	JIS C 3327 or equivalent
Power cable	3-core vinyl sheathed cable or 2-core vinyl sheathed cable	2mm ²	0.433–0.512 inch (11–13mm)	CVV JIS C 3401 or equivalent
Output signal cable	The number of insulated conductors the cable contains differs depending on the specification of the output signal cable. Use a shielded cable of overall diameter 0.433 to 0.512 inch (11 to 13mm) with nominal cross-sectional area of 1.25mm ² .			CVV-S JCS-258-C or equivalent

5.2 External Connections

The external connections of the converter are shown in Figure 5.1. See 5.4 “Wiring Method” to connect the cables correctly

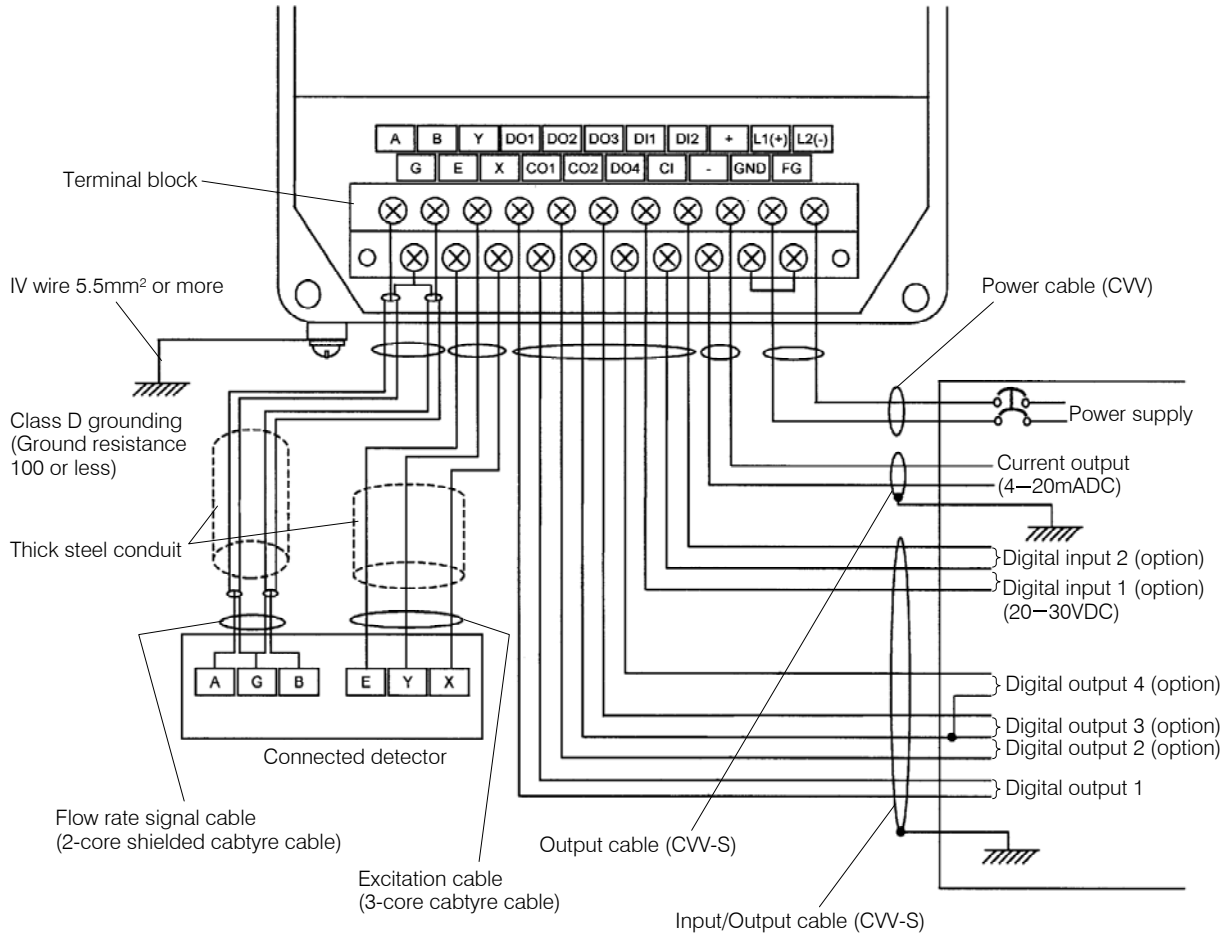

5.1 External Wiring Connection Diagram

5.3 Cautionary Notes on Wiring

5.3.1 Cautionary Notes on Wiring between Detector and Converter

- Flow rate signal cable and excitation cable are attached to the detector.

Be sure to use the attached cables.



Note: If the length of the cables exceeds 30m, the cables may not be attached. Check whether the cables are attached or not referring to the specification.

- The allowable cable length between the detector and the converter differs depending on the conductivity of the fluid to be measured. Refer to the Instruction Manual of the detector combined.
- The end of the attached cable to connect to the converter is covered with cap to prevent entry of humidity. Do not remove this cap from the cable until the cable is ready to be connected to the converter.
- When you connect cables between the detector and the converter, connect the excitation cable first and then the flow rate signal cable.
- Since the input signal cable carries very small signals, be sure to install the excitation cable and the input signal cable in separate thick steel conduit (0.87 inch (22mm)) and separate them from other large current wiring as much as possible and do not install them in parallel. The cable connection port is G (PF) 1/2 female thread.
- The detector side of the attached cable is already connected when shipped from the factory. In addition, since the terminal box of the detector has airtight structure, avoid removing the wired cable from the detector.
- To replace the flow rate signal cable and excitation cable, refer also to the Instruction Manual of the detector. Before you replace these cables, place an order for packing of the detector terminal box cover as well as packing for the cable connection to Toshiba or Toshiba representative and make sure to replace these packings when you replace the cables.

5.3.2 Cautionary Notes on Wiring between Instruments and Converter

- To avoid 2-point grounding, ground the shield of the output cable at the receiving instrument side as a rule.
- Use a grounding wire of IV wire 5.5mm² or more. The size of the screw for external grounding terminal is M4. In addition, do not share the grounding wire with other equipment where grounding current may flow. (An independent grounding is preferable.)
- Power cable
When a 3-core cable is used, ground the shield of the cable using the FG terminal.
When a 2-core cable is used, ground the shield of the cable using the external ground terminal and make it as short as possible.
- When you replace the Toshiba LF230 flowmeter converter with this converter, be careful that the cable connection is changed.

5.4 Wiring Method

 CAUTION	
<p>■ Do not conduct wiring work when power is applied.</p> <p>  DON'T </p> <p>Wiring while power is applied can cause electric shock.</p>	<p>■ Do not work on piping and wiring with wet hands.</p> <p>  DON'T </p> <p>Wet hands may result in electric shock.</p>

5.4.1 Terminal Treatment of Cables

Proceed as follows to treat the terminals at the converter side of the flow rate signal and excitation cable and to connect these cables to the terminal block. Use appropriate cables referring to 5.1 "Installation Cables." Attach and crimp a round type M4 insulated crimping terminal to the end of each cable.

● **Excitation cable**

Strip the sheath from the end of each wire as shown in Figure 5.2 and attach and crimp an M4 crimping terminal with insulated sleeve to the end of each wire and then connect the crimped terminals to X and Y of the terminal block. Connect the terminal of red wire to E of the terminal block.

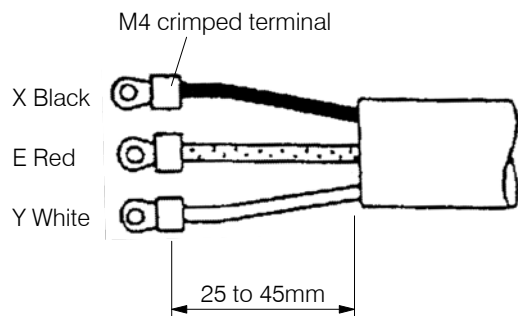

Figure 5.2 Terminal Treatment of Excitation Cable

● **Connecting the input signal cable**

Strip the sheath from the end of each wire of a 2-core individually shielded cable as shown in Figure 5.3 and attach and crimp an M4 crimping terminal with insulating sleeve to the end of each wire. Connect the crimped terminals to the A and B terminals of the terminal block. Twist the shields of the two wires and cover them with a thermal contraction tube or vinyl tube so that the shields do not make contact with the case or the core wires. Then attach and crimp an M4 crimping terminal with insulated sleeve to the end of the twisted shields. Connect the crimped terminal to the G terminal of the detector and the converter.

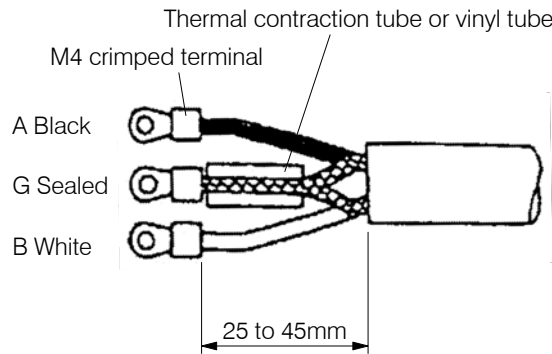

Figure 5.3 Terminal Treatment of Flow Rate Signal Cable

● **Cautionary notes on terminal treatment for shields of the signal cable**

- When stripping external sheath, intermediate and insulation sheath, be careful not to scratch or cut the internal conductors and the shield mesh.
- Do not unravel the shield mesh and treat it as shown in Figure 5.4.

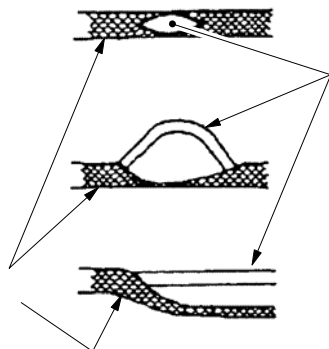

Figure 5.4 How to Treat the Shield Mesh of Signal Cable

● **Power cable, current output cable and digital I/O cables**

Necessary cables should be purchased and prepared by the agent in charge of installation.

Strip the sheath from the end of each wire and attach and crimp an M4 crimping terminal with insulated sleeve to the end of each wire.

- Connect the power cable terminals to L1 and L2 of the terminal block.
- Connect the current output cable terminals to (+) and (-) of the terminal block.
- Connect the digital I/O cable terminals to the required terminals among the terminals of DI, DO1 – CO1, (CO2 to DO4) – CO2, (DI1, DI2) – CI.

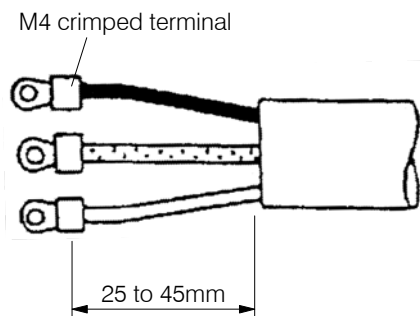

Figure 5.5 Terminal Treatment of Power Cable, Current Output Cable and Digital I/O Cables

5.4.2 Cable Connection

Connect and install the terminal-treated cables to the terminal block in the procedure below.

* Connect the cables to the terminal block securely. A loose connection may cause incorrect measurement. After connecting each cable, try to pull it to check whether it has been connected securely.

Remove the cap nut for tightening the cable connection and attach the removed cap nut, seal ring and packing onto the terminal-treated cable in this order and then lead the cable into the converter.

(The blind plate is used for dustproof protection during storage. Remove it when connecting a cable because it is not needed.)

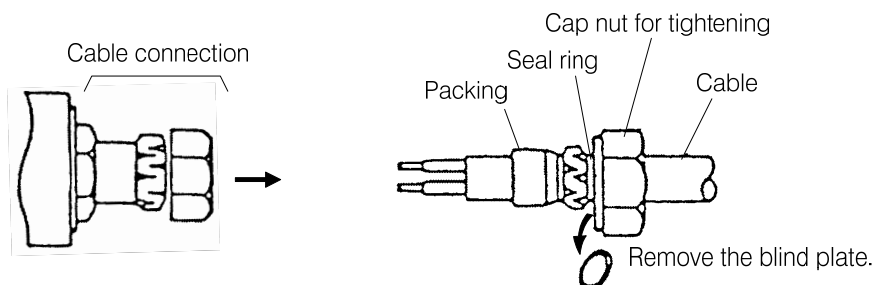

Figure 5.6 Cable Connection

Referring to 5.2 "External Connections," connect each cable to the terminal block. Tighten the screws of the terminal block tightly to make them securely connected. A loose connection may cause incorrect measurement. After connecting each cable, try to pull it to check whether it has been connected securely.

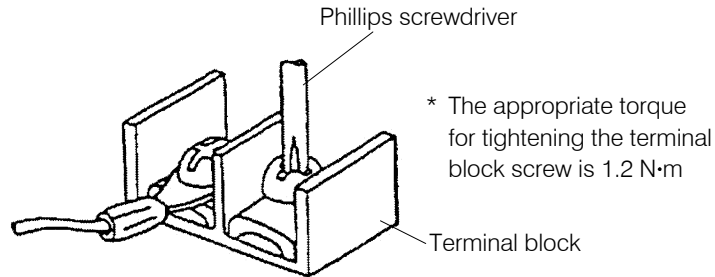

Figure 5.7 Connection to Terminal Block

After connecting the cables to the terminal block, take up the slack of the cables and tighten the cap nut.

At this time, be careful that if the sheath-removed portion of the cable comes to the packing area, air tightness may not be kept.

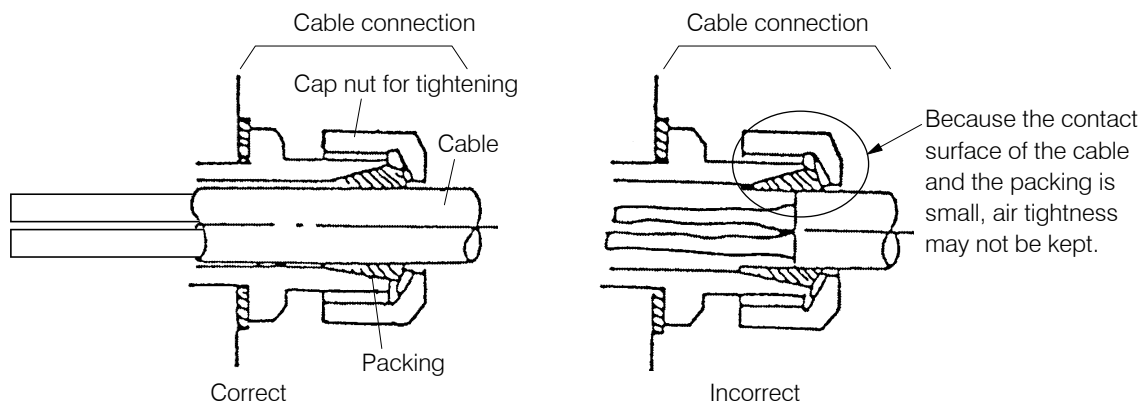

Figure 5.8 Cable Tightening

5.4.3 Grounding

The external ground terminal of the detector and the FG terminal of the converter (or external ground terminal of the converter) must be grounded securely with Class D grounding (grounding resistance 100Ω or less). Use an IV wire 5.5mm² or more for grounding wire.

In addition, do not share the grounding wire with other equipment where grounding current may flow. (An independent grounding is preferable.)

If it is difficult to carry out grounding work at the detector side due to a pit installation or other reasons, use a 3-core cable for the excitation cable and connect the E terminal of the detector to the E terminal or other reasons as shown in Figure 5.9(b), of the converter. (The E terminal of the converter is internally connected to the FG terminal and the converter housing.)

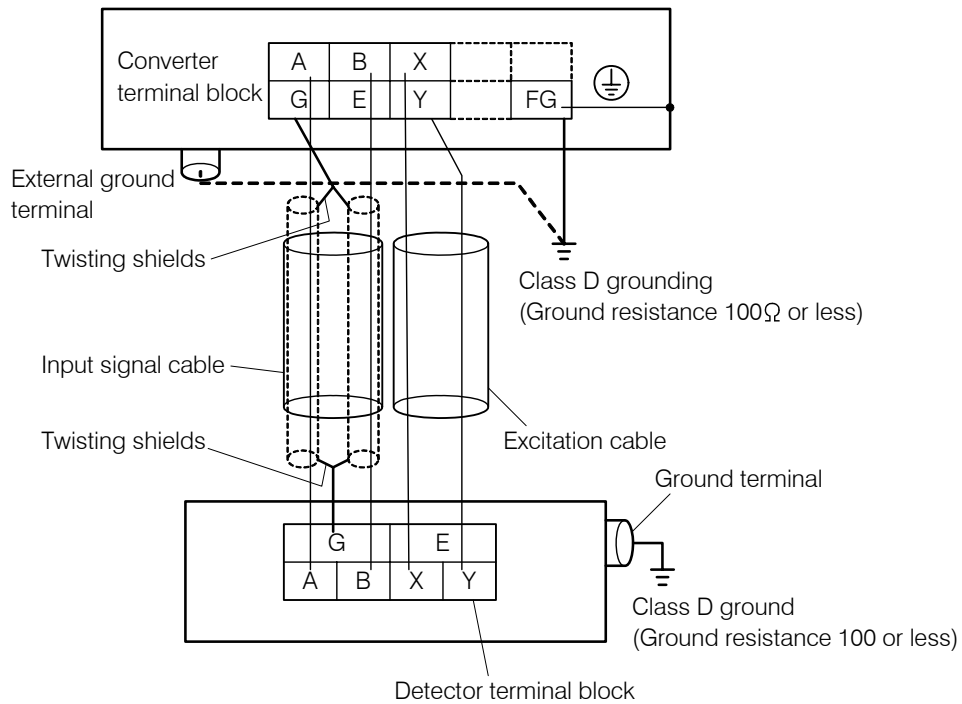

Figure 5.9(a) Wiring between Detector and Converter

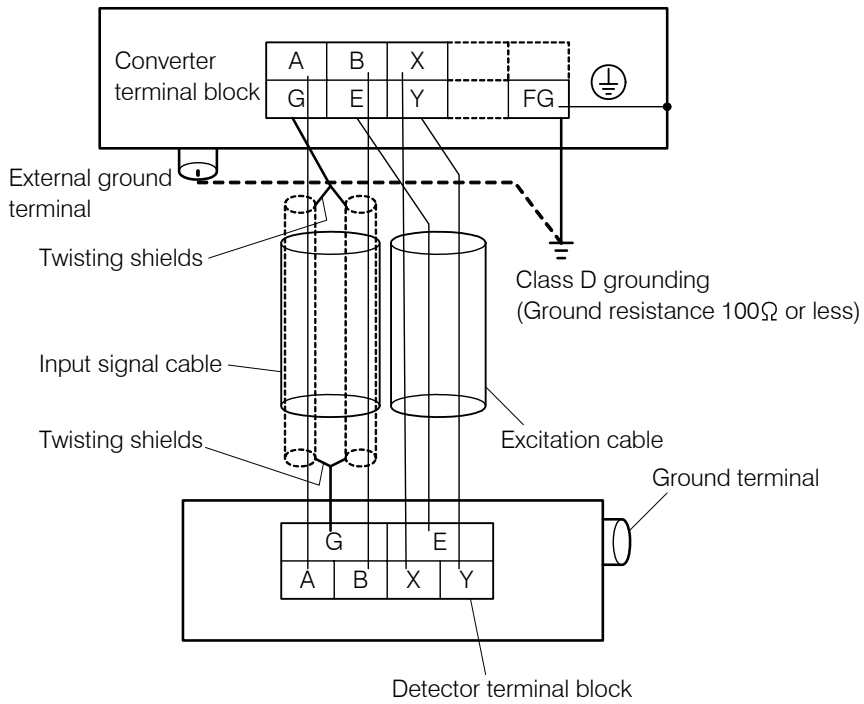
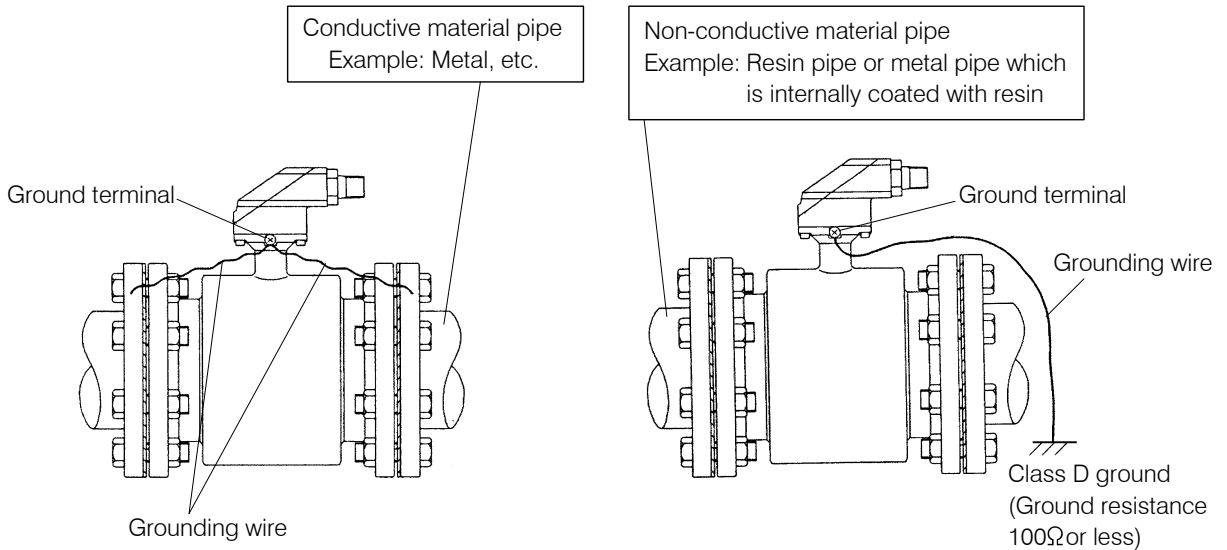

Figure 5.9 (b) Wiring between Detector and Converter (when grounding for detector is difficult)



- When piping material is conductive
Connect the grounding wires to both ends of the piping flange.

- When piping material is non-conductive
Carry out class D grounding work (grounding resistance 100Ω or less).

Figure 5.10 Detector Grounding Method

5.5 Digital I/O Connections

Digital I/O terminals consist of four contact output terminals (DO1 to DO4) and two voltage signal input terminals (DI1 and DI2), and each terminal is isolated from internal circuits.

The terminal CO2 is the signal common for DO2 to DO4 and the terminal CI is the signal common for DI1 and DI2. For details, see 10. "Function Description."

The function of each terminal can be selected by settings.

For details, see 10. "Function Description."

To drive an electromagnetic relay or electromagnetic counter using a digital output, connect a surge-absorbing diode into the input circuit of the relay or the counter. Figure 5.11 shows a connection example.

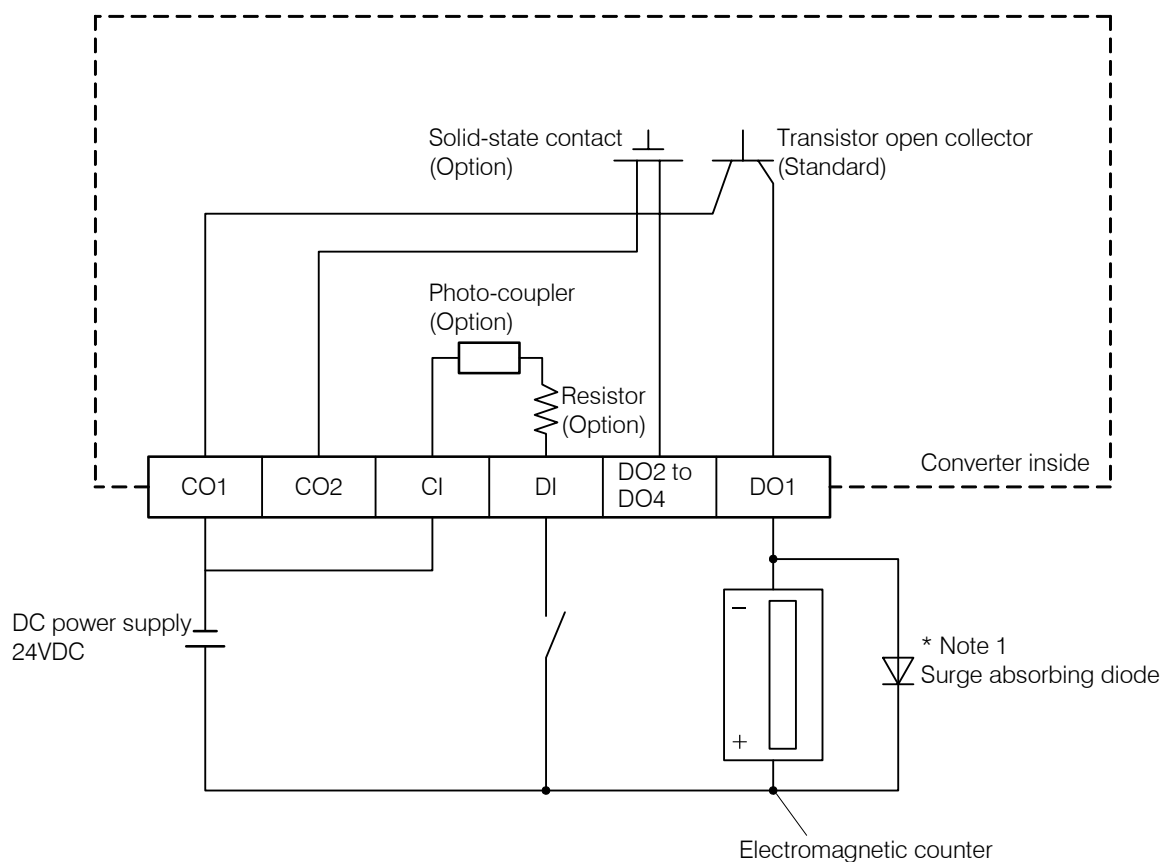

* Note 1 Use a surge-absorbing diode of rated current 1A and rated withstand voltage 200 V minimum.

* Note 2 In the case of standard specification (without Digital I/O), the solid-state contact, photo-coupler and resistor are not built in. Leave DO2 to DO4, CO2, DI, DI2 and CI unconnected.

Figure 5.11 Connection Example of Electromagnetic Counter

5.6 Cautionary Notes on Replacing Converter

5.6.1 Replacing the LF230 Converter

The following precautions must be taken to replace the conventional type LF230 with LF232.

● **Installation**

- Since the hole diameter and pitch for mounting fitting, and the dimensions of the LF232 converter main unit are the same as those of the LF230 converter, it is possible to replace the converter without changing the mounting panel, installation space, etc.
- The operation switches of the LF232 are infrared switches. If direct sunlight hits the display and the operation section or if there is something nearby that easily reflects light, this kind of light becomes disturbance light and the switch operation may not work correctly. Be careful about the installation location and angle, or take measures such as providing a sunshade or shield plate so that disturbance light does not hit the operation section directly.

● **Wiring**

- The positions of the LF232 cable ports are the same as those of the LF230.
- The specifications of the cable ports differ as shown in the table below.

Table 5.2 Comparison of Cable Port Specifications

		LF230	LF232
Ports on the housing		M27 fine pitch thread Depth 0.433 inch (11mm)	G1/2 Depth 0.433 inch (11mm)
Attached cable connection specifications	Material	Stainless steel	Nylon resin
	Waterproof grade	IP67	IP67
	Appropriate cable diameter	Excitation and DI/DO cables φ0.433–0.512 inch (φ11–13mm) Other cables φ0.394–0.472 inch (φ10–12mm)	φ0.433–0.512 inch (φ11–13mm)
	Conduit connection port	R (PT) 1/2 male thread	Not provided
	Blind plate (seal plate)	Waterproof blind plate attached	Dustproof blind plate attached * (Note)

Note: The blind plate is not a waterproof type. If it is necessary to install the converter where waterproof structure is needed, take waterproof measures for unused cable ports such as using sealing plugs sold on the market.

- Since the terminal block specification of the LF232 is M4 screws, the same as that of the LF230, it is possible to connect the cables without changing the cable terminals.

5.6.2 Combination with an Existing Detector (for Large Meter Size)

When the LF232 flowmeter converter (LF232*B for large meter size) is combined with an existing detector of commercial power excitation method, the excitation current may not become stable because of the difference of the excitation method.

(Example of symptoms)

- When the excitation current is checked in the CAL mode, the excitation current is not displayed exactly as set for the converter.
- The indicated value of the excitation current does not stabilize in the CAL mode and the minimum digit cannot be read.
- The zero point of flow rate at the time of still water measurement is not stable.

If this happens, connect an adjusting capacitor provided for the detector (only for large meter size) between the terminals X and Y of the terminal block for converter cable as shown below.

This capacitor is not needed if you combine with a detector of square-wave excitation method (guideline date: manufacture date is 1981 or later).

In addition, if the symptom does not improve when the capacitor is connected, stop using the capacitor.

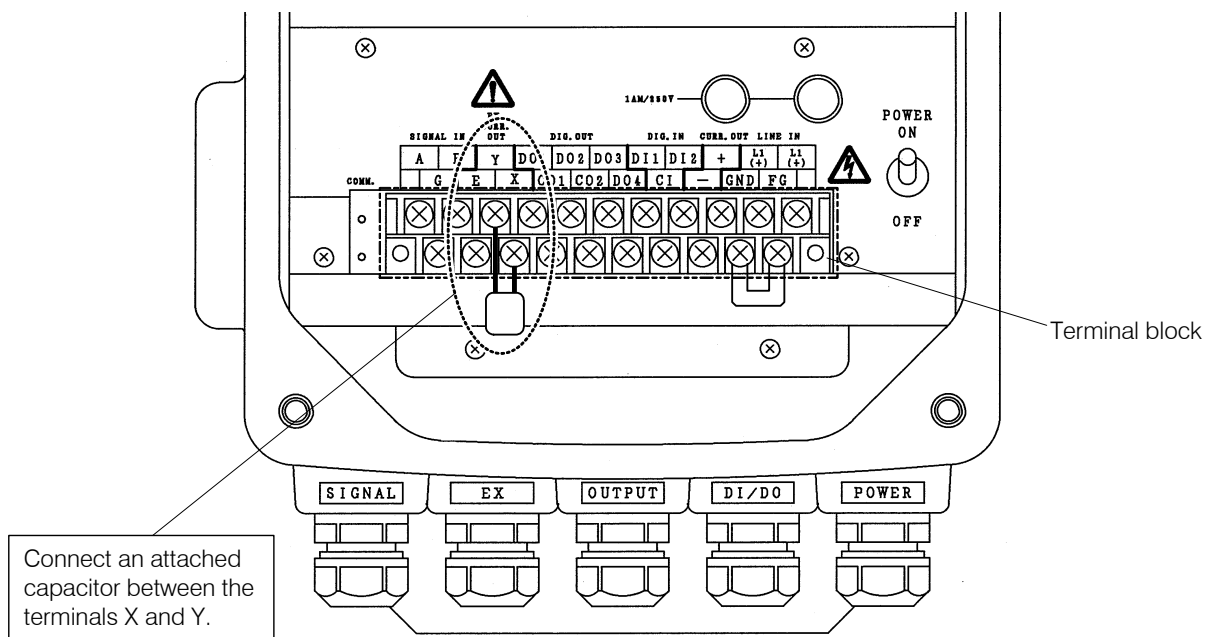

Note: If any symptom described above does not occur when connected with an existing detector, do not connect this capacitor.

Figure 5.12 How to Connect an Adjusting Capacitor

5.6.3 Replacement of partially filled pipes type

When detector of partially filled pipes type is replaced from LF502 or LF502(FS2 type) to LF232*F, please be careful to the following points.

- Installing

In the case of replacement from LF502(FS2 type):

The diameter of hole, width of installation metal fittings of LF232, an external size of the body of converter are the same. In the installation panel processing, the built-in space, a change is unnecessary.

Because switch of LF232 is the infrared switch, please avoid a place with the following factor.

- ◆ Factors to impede infrared switch to operate properly

- Intense light such as direct sunlight and reflected sunlight by window glass or metal plate
- Place where brightness changes always such as ON/OFF of lighting
- Dense smoke or steam near the control panel
- Those attached on the control panel such as rain (dew drop), snow, ice, mud and oil, and haze due to their attachment
- Light reflecting object near the control panel, or reflecting object such as metal plate placed opposing to the control panel

When any of above factors is considered, take a measure for the proper operation of infrared switch such as to place a cover or to secure a space for at least a person to stand in front of the control panel.

When unable to avoid above factors, operate the EMF converter removing the factor by covering the control panel by hand so that light does not shine on it, by cleaning those attached on the control panel, or by standing in-between the reflecting object and the control panel to block the light.

Table 5.3 Case specifications comparison list (Partially filled pipes type)

Model	LF502	LF502 (FS2 type)	LF232*F
Width of installation (W×H)	220×200	74×370	
Size of body(W×H×L) (Note)	325×426×264	234.5×370×150	

Note: Cable ground, installation metal fittings are removed from height.

• Wirering

- Hole position of cable connection mouth of LF232* F is the same as LF502 (type FS2).
- Because specifications of cable connection mouth are different in the following points, Please be careful.

**Table 5.4 Cable connection mouth specification comparison list
(Partially filled pipes type)**

Model	LF502	LF502 (type FS2)	LF232*F	
Joint of case side	(Please use only an attached cable ground)	M27 slim screw Depth 0.433 inch (11mm)	G1/2 Depth 0.433 inch (11mm)	
specifications of attached cable ground	Materials	Stainless steel	Stainless steel	
	Grade of waterproofing	IP67	IP67	
	Diameter of conformity cable	Excitation, optional cable ϕ 0.433~0.512 inch (ϕ 11~13mm) Others ϕ 0.394~0.472 inch (ϕ 10~12mm)	Excitation, DI/DO cable ϕ 0.433~0.512 inch (ϕ 11~13mm) Others ϕ 0.394~0.472 inch (ϕ 10~12mm)	ϕ 0.433~0.512 inch (ϕ 11~13mm)
	Joint of conduit	Rc(PT)3/4 male screw	R(PT)1/2 male screw	None
	Blind	Attached waterproofing blind	Attached waterproofing blind	Attached protection against dust blind (Note)

(Note) There is not waterproofing of a blind. When converter needs waterproofing, please set waterproof the cable connection mouth.

Terminal block specifications of LF232 are M4 screw terminals same as LF502.
Change of terminal processing of cable is unnecessary.

6. Operation

⚠ CAUTION	
<p>■ Do not touch the LF232 main body when high temperature fluid is being measured.</p>	
 DON'T	<p>The fluid raises the main body temperature and can cause burns when touched.</p>

For operation, follow the procedure described below.

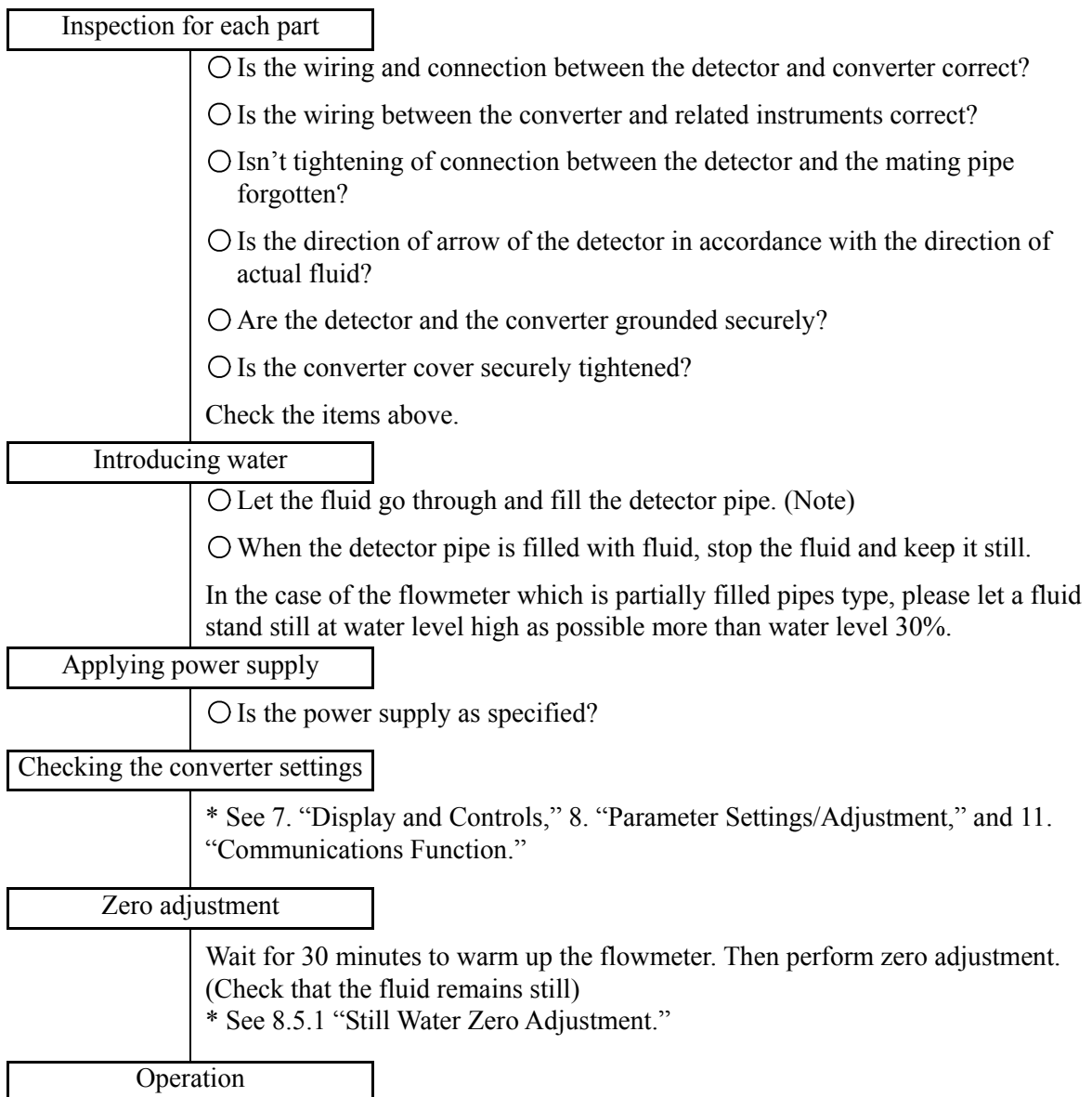

After checking the items and performing adjustment listed above, let the fluid go through the detector pipe. Then the outputs such as current output (4 to 20mADC) directly proportional to the flow rate can be obtained.

Note: If the fluid to be measured is not filled in the detector pipe (When detector is partially filled pipes type, water level is not enough), flow rate becomes inconsistent and measurement cannot be performed correctly.

Be sure to use the flowmeter while the fluid to be measured is filled in the detector pipe.

7. Display and Controls

For the LF232 converter, the measured value can be displayed and the parameters can be checked or set using the LCD display and operation switches.

The operation switches are non-contact type (infrared method) and can be operated without opening the converter cover (operable also while the cover is opened).

CAUTION

Observe the following precautions when you open the converter cover:

- Do not allow the converter exposed to rain and wind.
Adjustment in the rain may cause damage to the parts and may cause electric shock and it is very dangerous.
In addition, if wind-blown dust enters the electronic circuits in the converter, this may cause malfunction of the converter.
- Do not open the converter cover under high humidity condition
Opening the converter cover under high humidity condition can cause deterioration of system accuracy or cause damage to the flowmeter parts.

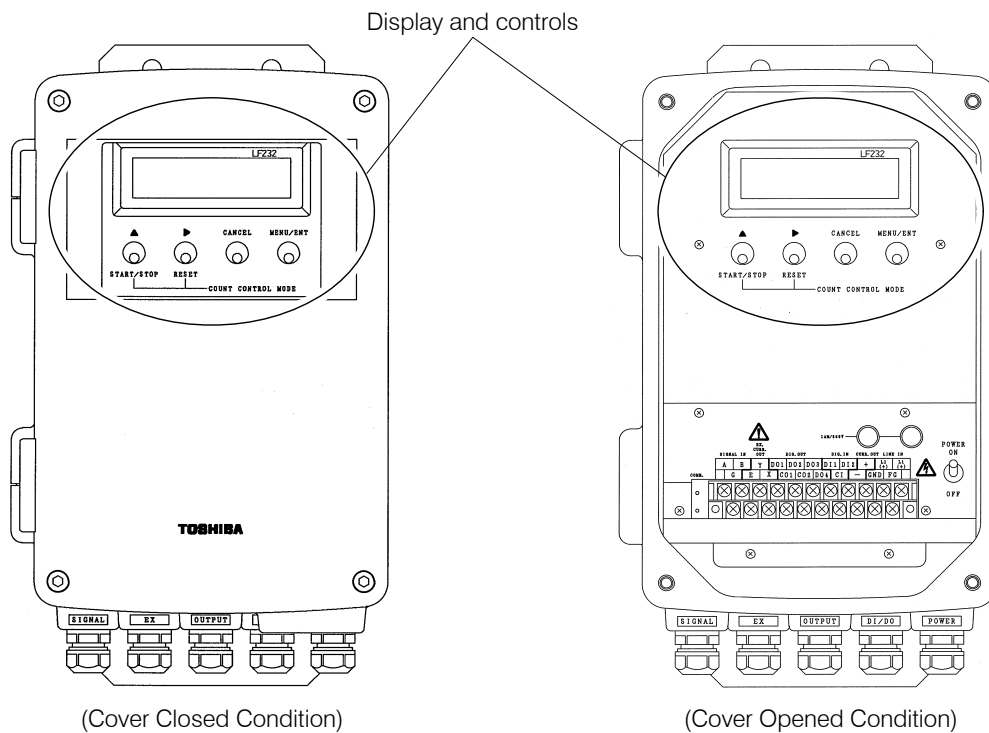

Figure 7.1 Display and Controls

7.1 Names and Functions of Display and Controls

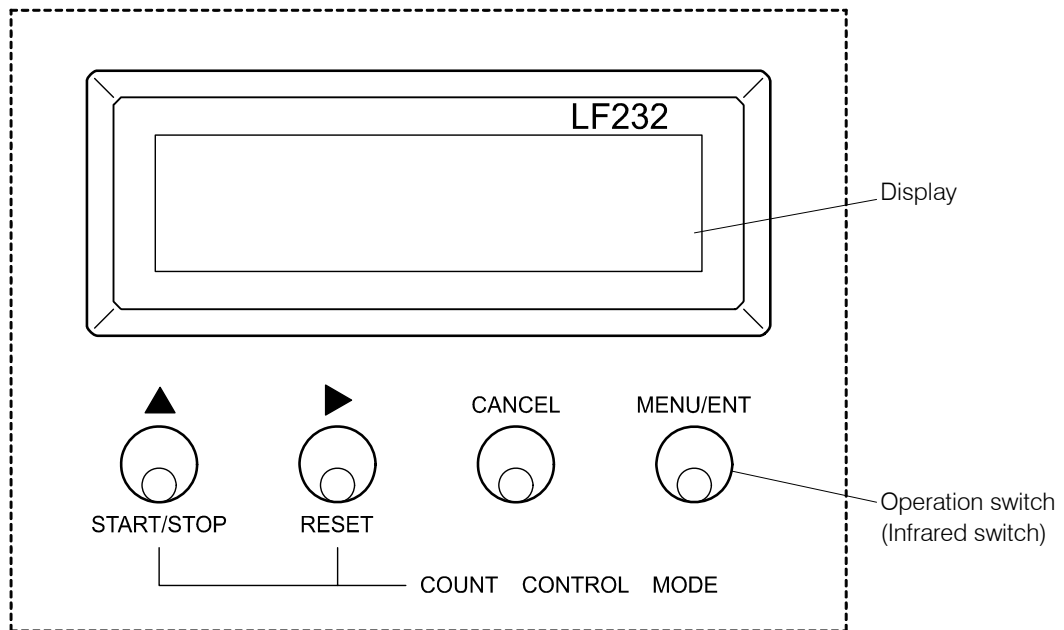

Figure 7.2 Display and Controls

- **LCD display**

A 16-character × 2-line liquid crystal display with backlight is used.

Instantaneous flow rate and total flow, and various constants such as parameters can be displayed. In addition, the backlight is always lit and data can be read clearly even in a dark place.

- **Operation switch (infrared switch)**

Operation switches are infrared switches and the operation can be carried out without opening the housing cover and operable also with the cover opened.

⚠ CAUTION Instructions

The operation principle of infrared switch is to irradiate infrared to the front of control panel and detect the reflection from finger when operating.

Normal operation is impeded depending on the conditions such as disturbing light from surroundings or stain attached to the control panel. When unable to avoid such condition, operate the EMF converter in the following manner.



Remove the factor to impede proper operation of infrared switch as below:

- Cover the control panel by hand so that light does not shine on it
- Clean the stain attached on the control panel
- Clean the stain on the finger or the gloves to operate the EMF converter, or wear gloves in light color
- When there is a reflecting object placed opposing to the control panel, stand in-between the reflecting object and the control panel to block the light

Following are considered as the factors to impede infrared switch to operate properly.

- Intense light such as direct sunlight and reflected sunlight by window glass or metal plate
- Place where brightness changes always such as ON/OFF of lighting
- Dense smoke or steam near the control panel
- Those attached on the control panel such as rain (dew drop), snow, ice, mud and oil, and haze due to their attachment
- Operation of the control panel by hands wearing gloves in dark color or stained fingers and gloves
- Light reflecting object near the control panel, or reflecting object such as metal plate placed opposing to the control panel

● Functions of each switch

Switch	Basic function
<p>MENU/ENT</p> 	<ul style="list-style-type: none"> Moves the mode from the measurement mode to menu display <div style="display: flex; align-items: center; justify-content: space-around;"> <div style="border: 1px solid black; padding: 5px; text-align: center;"> 10.00 m/s 100.0 % (Measurement mode) </div> <div style="font-size: 2em;">⇒</div> <div style="border: 1px solid black; padding: 5px; text-align: center;"> ENTER 111 (*note) 000 (Menu lock cancellation screen) </div> </div>
	<ul style="list-style-type: none"> Moves the mode to the setting, calibration or measurement mode <div style="display: flex; align-items: center; justify-content: space-around;"> <div style="border: 1px solid black; padding: 5px; text-align: center;"> A1:EX CURR (Menu display) </div> <div style="font-size: 2em;">⇒</div> <div style="border: 1px solid black; padding: 5px; text-align: center;"> A1:EX CURR 0.2100A (Setting mode) </div> </div>
	<ul style="list-style-type: none"> Writes data in the setting mode. <div style="display: flex; align-items: center; justify-content: space-around;"> <div style="border: 1px solid black; padding: 5px; text-align: center;"> B1:UNIT 1 % (Data being changed) </div> <div style="font-size: 2em;">⇒</div> <div style="border: 1px solid black; padding: 5px; text-align: center;"> B1:UNIT 1 % (Data has been changed) </div> </div>
	<ul style="list-style-type: none"> Changes the numeric value or items in menu display and in the setting, calibration or measurement mode. <div style="display: flex; align-items: center; justify-content: space-around;"> <div style="border: 1px solid black; padding: 5px; text-align: center;"> C2:RANGE 1 02.000 m/s (Data 0.2000m/s) </div> <div style="font-size: 2em;">⇒</div> <div style="border: 1px solid black; padding: 5px; text-align: center;"> C2:RANGE 1 03.000 m/s (Data 0.3000m/s) </div> </div>
	<ul style="list-style-type: none"> Starts or stops the totalizer (total value and pulse output) in the totalizer control mode. <div style="display: flex; align-items: center; justify-content: space-around;"> <div style="border: 1px solid black; padding: 5px; text-align: center;"> COUNT CTRL F 1000 m³ (Count stops) </div> <div style="font-size: 2em;">⇒</div> <div style="border: 1px solid black; padding: 5px; text-align: center;"> COUNT CTRL F 1000 m³ C (Count starts) </div> </div>
	<ul style="list-style-type: none"> Enables the converter to change the setting value in the setting or calibration mode and the cursor appears. <div style="display: flex; align-items: center; justify-content: space-around;"> <div style="border: 1px solid black; padding: 5px; text-align: center;"> D1: DAMPING 00.5 S (Setting mode) </div> <div style="font-size: 2em;">⇒</div> <div style="border: 1px solid black; padding: 5px; text-align: center;"> D1: DAMPING <u>0</u>0.5 S (Enabled to change the setting value) </div> </div>
	<ul style="list-style-type: none"> Moves the cursor (digit) in menu display and in the setting mode <div style="display: flex; align-items: center; justify-content: space-around;"> <div style="border: 1px solid black; padding: 5px; text-align: center;"> G1: COUNT RATE 1.23E-4 m³ (Cursor at the position of "1") </div> <div style="font-size: 2em;">⇒</div> <div style="border: 1px solid black; padding: 5px; text-align: center;"> G1: COUNT RATE 1.2<u>3</u>E-4 m³ (Cursor at the position of "2") </div> </div>
	<ul style="list-style-type: none"> Resets the totalizer (total value) in the totalizer control mode <div style="display: flex; align-items: center; justify-content: space-around;"> <div style="border: 1px solid black; padding: 5px; text-align: center;"> COUNT CTRL F 1000 m³ C (Counter in operaiton) </div> <div style="font-size: 2em;">⇒</div> <div style="border: 1px solid black; padding: 5px; text-align: center;"> COUNT CTRL F 0 m³ C (Resets the counter) </div> </div>

Note : There is not this screen to the converter before serial No.072320999.
 (Menu screen is displayed. Menu lock cancellation screen is not displayed.)

Switch	Basic function
CANCEL 	<ul style="list-style-type: none"> • Returns the screen from the parameter display screen to the menu display screen.
	<ul style="list-style-type: none"> • Returns the screen from the parameter input screen (Cursor ON) or adjustment wait screen to the parameter display screen.
	<ul style="list-style-type: none"> • Cancels the parameter input check screen (screen blinks) and returns to the parameter input screen.
	<ul style="list-style-type: none"> • If pressed while menu display screen is displayed, Function [MEAS MODE] to return to the measurement mode appears. (If MENU/ENT is pressed under that condition, the mode returns to the measurement mode.)

7.2 Display Format

In the measurement mode, the measured data is displayed in the unit set by UNIT 1 and UNIT 2 in the setting mode. (To set the unit, see 8.2.6 " Normal Indicating Unit ")

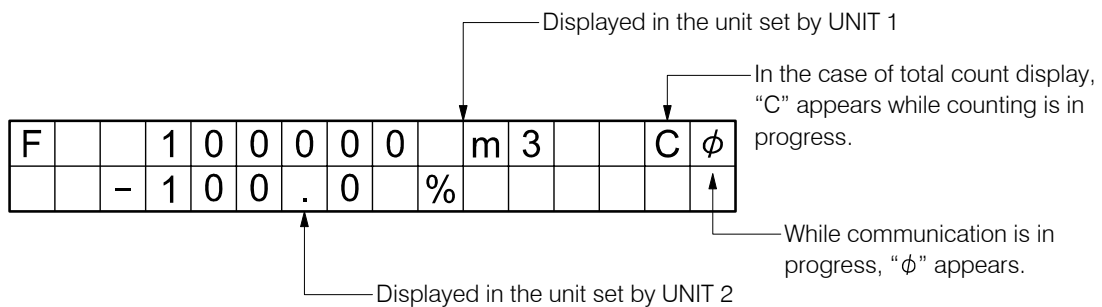

● Measured value display format

(1) Flow velocity value and instantaneous flow rate display

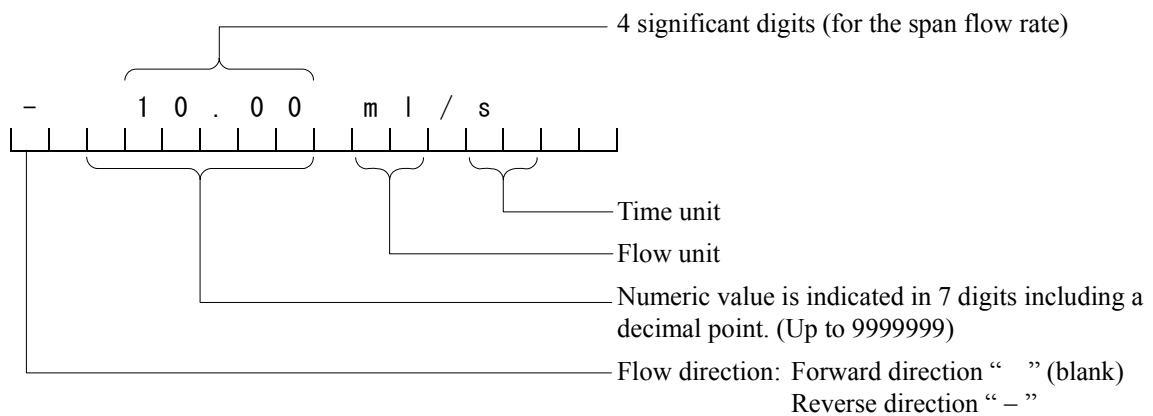

(2) Total count display

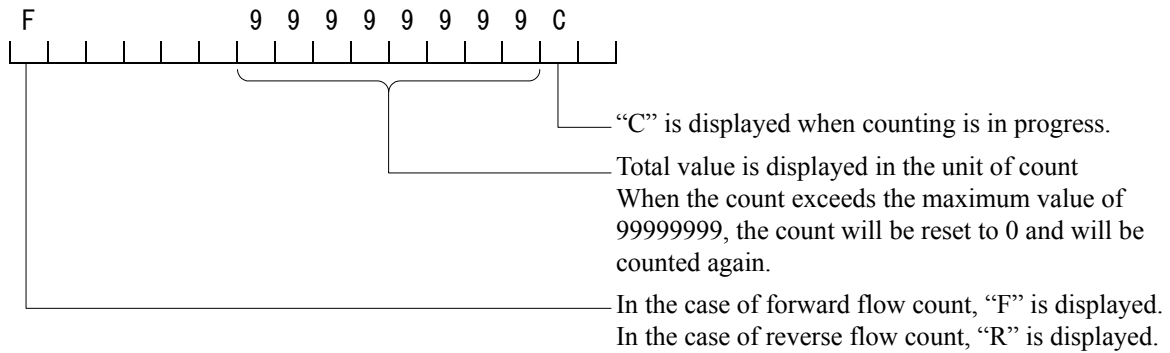

(3) Total flow value display

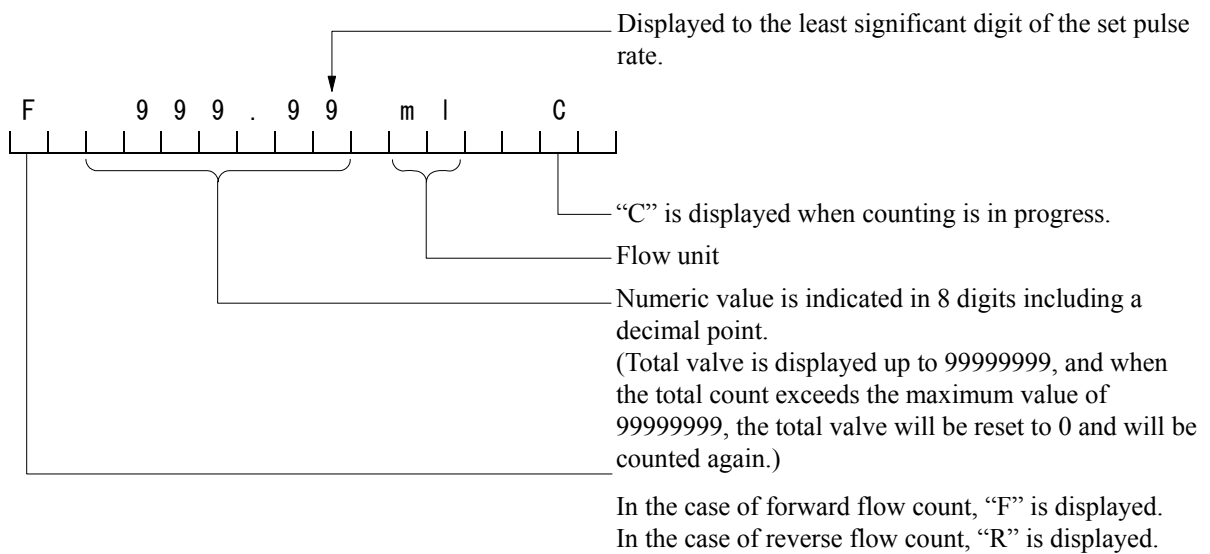

(4) Total difference flow value display

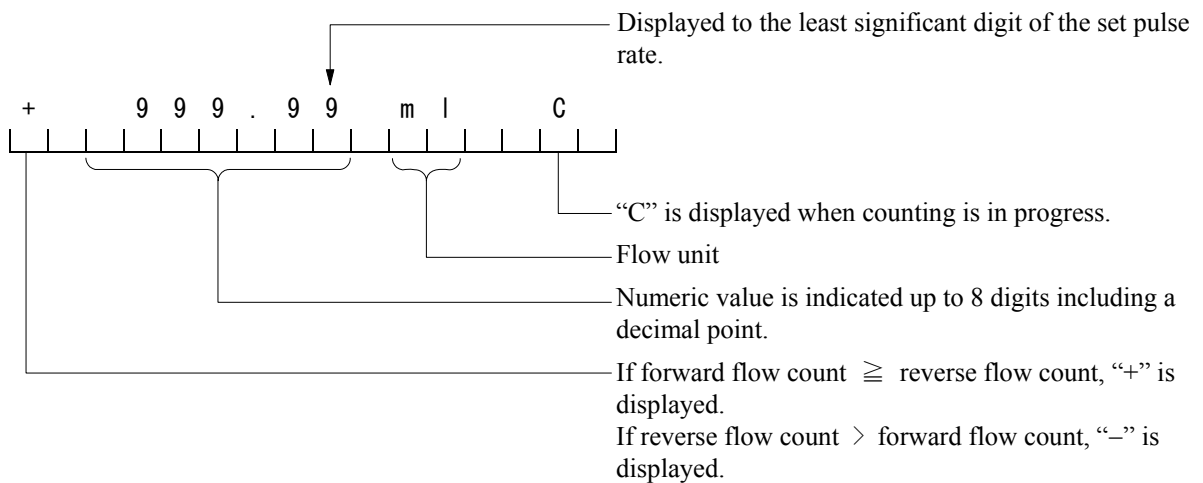

For total difference flow value, the difference between the forward direction value and the reverse direction value is displayed.

Notes on total flow value display

Note 1: The total flow value and the total difference flow value are displayed to the least significant digit of the set count rate.

Example: When the set count rate is 0.0001 m³
 Total flow / total difference flow display becomes 000.0000m³ and the value increases in increments of 0.0001 m³.

If the value reaches 999.9999m³, the display changes to 1000.0000m³ at the next count.

In the end, the display becomes 99999999m³.

When the set count rate is 10 m³

The display becomes 00000000m³ and the value increases in increments of 10 m³.

Note 2: In the case of total difference flow display, if the forward direction total flow value or reverse direction total flow value exceeds 9,999,999, only the total value that exceeded 9,999,999 will be reset to 0 and the count continues.

Example: When the forward direction value returns to zero after it reaches the maximum value

Forward direction: 1000	Forward	direction:	Forward direction: 0
Reverse direction: -100	→	99999999	→ Reverse direction: -100
Flow difference: 900		Reverse direction: -100	Flow difference: -100
		Flow difference: 99999999	

* In an example shown above, if the forward direction flow value is reset to zero after reaching 99999999, flow difference indication changes from 99999899 to -100 and the count continues.

(5) Percent display

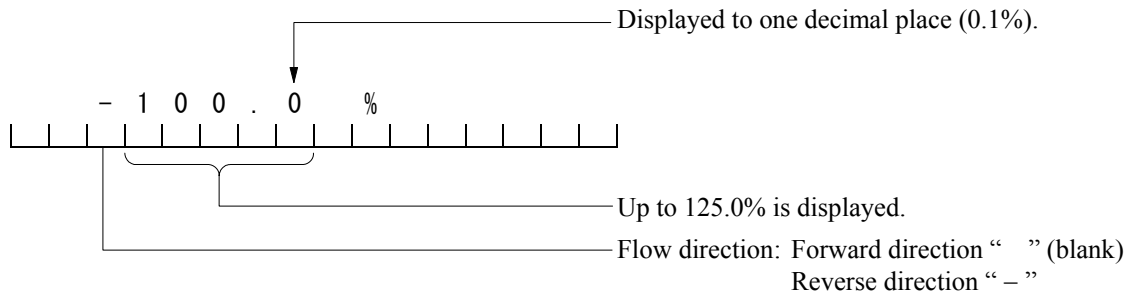

(6) Custom unit display

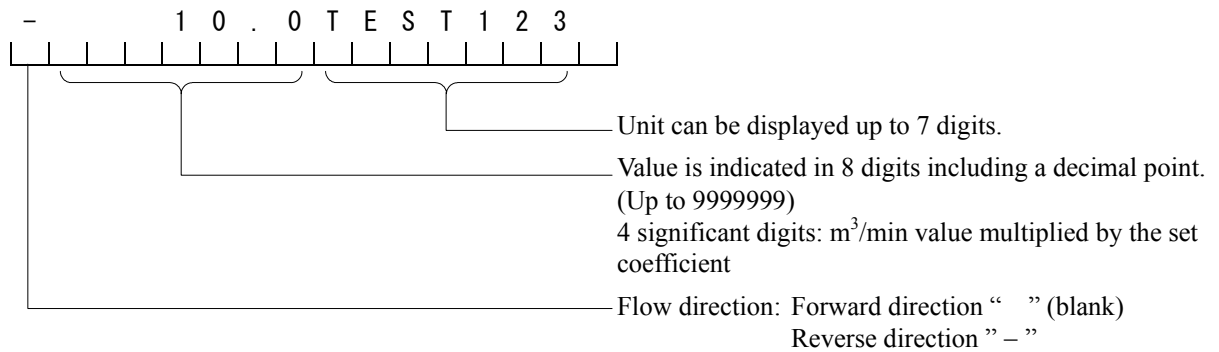

(7) Error message / other message display

E X C U R R E N T O P E N
 | | | | | | | | | | | | | |

If an error or alarm condition occurs, a message is displayed in the 2nd line.

(8) Fixed output display

* F I X O U T 2 0 . 0 m A
 | | | | | | | | | | | | | |

In the fixed output mode, a message is displayed in the 2nd line.

7.3 Basic Operations (Mode Switching, Setting Mode Operation, Total Counter Operation)

7.3.1 Mode Switching

(1) Types of mode

The following operation modes are provided in the LF232 converter and they can be changed by operation switches.

- Measurement mode: This is the mode used at the time of flow measurement
 The process value is displayed and output.
 The flowmeter first goes to this mode when power is turned on.
- Totalizer operation mode: Totalizer can be started, stopped and reset.
 For output, the process value is output in the same way as in the measurement mode.
 For details, see 7.3.4 “Totalizer Operation.”
- Setting mode: This is the mode to check or set various parameters.
 Parameters can be selected from function menu.
 Though various parameters are shown on the display, the process value is output in the same way as in the measurement mode.
 For details, see 8.2 “Parameter Check/Change.”

The following mode can also be selected using menu in the setting mode.

- Fixed value output mode (loop check): This is the mode in which 4 to 20mA output and the totalizer pulse output frequency can be fixed to a preset value.
 For details, see 8.4 “Fixed Value Output (Loop Check).”
- Zero adjustment mode: This is the mode in which zero adjustment can be performed.
 The process value is output in the same way as in the measurement mode.
 For details, see 8.5 “Zero Adjustment.”
- Calibration mode: This is the mode to check the circuits of the converter unit.
 Zero point and span can be checked using the internal generator circuit that generates simulation signals. Excitation current can also be checked.
 The current output becomes the value corresponding to the simulation signal.
 For digital output, the last value before entering the calibration mode will be held.
 For details, see 9. “Mag-Prover Calibration.”

Note 1: If password is set, the password selection screen appears.
For details, see 7.3.3, "Password Input."

Note 2: If no operation is performed for one minute while the mode selection screen or the setting mode menu screen is displayed, the screen returns to the measurement screen





Note 3: There is not this screen to the converter before serial No.072320999.
There is not software version (V****) to the converter before version V0109.

7.3.2 Setting Mode Operation



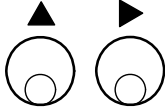

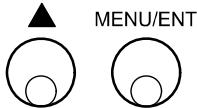
Proceed as follows to select the desired item and check or change the setting values.

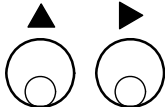
* Switch operation indicates the switches to press.

● Moving to the menu display

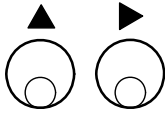
Switch operation	Display example	Description
—	10.00 m/s 100.0 %	Measured value being displayed (measurement mode)
Note1 MENU/ENT 	ENTER111 000 V****	Pressing [MENU/ENT] in the measurement mode for 3 seconds or more, the screen moves to the menu lock cancellation screen. * Pressing [CANCEL] in the mode selection screen, the mode returns to the measurement mode.
Note1 	ENTER111 111 V****	Set the menu lock cancellation cord [111] by pressing [▲] and [▶] . * Pressing [CANCEL] in the mode selection screen, the mode returns to the measurement mode.
MENU/ENT 	>1:SET 2:CNT CTRL	Pressing [MENU/ENT] in the measurement mode for 3 seconds or more, the screen moves to the mode selection screen.
	A1:EX CURRENT	Select 1:SET in the mode selection screen and press [MENU/ENT] . Then the menu screen appears. * Pressing [CANCEL] in the mode selection screen, the mode returns to the measurement mode.
	B1:UNIT 1	Pressing [▲] , the function number (a combination of a letter and a number) changes.
	B1:UNIT 1	Pressing [▶] , the cursor moves. * If the cursor is positioned at the digit of number, pressing [▲] moves the cursor to the digit of letter.
	G2:RANGE 1	Likewise, set the function number to the one you want to check or change by pressing [▲] and [▶] .

● To return from the menu display to the measurement mode

Switch operation	Display example	Description
	CO: MEAS MODE	Set the digit of number for function number to “0” by pressing  and  (Note2). The digit of letter can be set to any letter.
<p>MENU/ENT</p> 	<p>10.00 m/s</p> <p>100.0 %</p>	The mode returns to the measurement mode (measured value display screen).





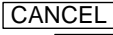





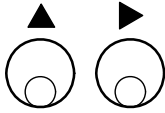









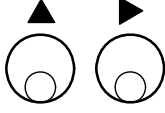

Note1: There is not this screen to the converter before serial No.072320999.

There is not software version (V****) to the converter before version V0109.

Note2: Pressing  changes the digit of number to “0” (*0:MEAS MODE).

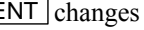
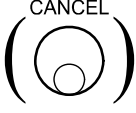
Then pressing  under that condition brings you back to the measurement mode with minimum operations.

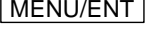
● Checking or changing the setting values

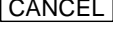
Switch operation	Display example	Description
	C2: RANGE 1	Menu display Select the desired item to check or change using  and  . C2 (RANGE 1) in this example.
MENU/ENT 	C2: RANGE 1 2. 00000 m/s	Press  to decide the item to check or change. The cursor disappears and the currently set value appears for you to check. Pressing  under this condition brings you back to the previous screen.
	C2: RANGE 1 2. 00000 m/s	Pressing  , the cursor appears at the position of the set value and enables the set value to be changed. Pressing  under this condition, the cursor disappears and the screen returns to the setting value check screen (previous screen).
	C2: RANGE 1 3. 00000 m/s	Setting value changeable condition Pressing  , the setting value increases. * If the cursor is positioned at the unit, pressing  moves the unit to the next unit.
	C2: RANGE 1 3. 0000 m/s	Pressing  , the cursor moves to the next digit.
	C2: RANGE 1 5. 00000 m/s	Press  and  to change the setting value. In this example, set the value to 5.000m/s.
MENU/ENT 	C2: RANGE 1 5. 00000 m/s	Pressing  changes to the condition that data is temporarily set and the entire data blinks.
CANCEL 	C2: RANGE 1 2. 00000 m/s	If you want to cancel the data change such as when the temporarily set data has an error, press  and then the temporarily set data returns to the previously set value and the screen returns to the setting value changeable condition.
MENU/ENT 	C2: RANGE 1 5. 00000 m/s	Pressing  confirms the data and the changed data appears.
CANCEL 	C2: RANGE 1	Pressing  returns you to the menu screen.

7.3.3 Password Input

The password function is provided in the LF232 converter to prevent some functions that affect the flow measurement from being used or adjusted. If password is set, totalizer cannot be reset.

For the setting menu limited by the password, see 7.4 “Setting Menu List.”

In addition, for how to set password, see 8.2.5 “Password Setting.”



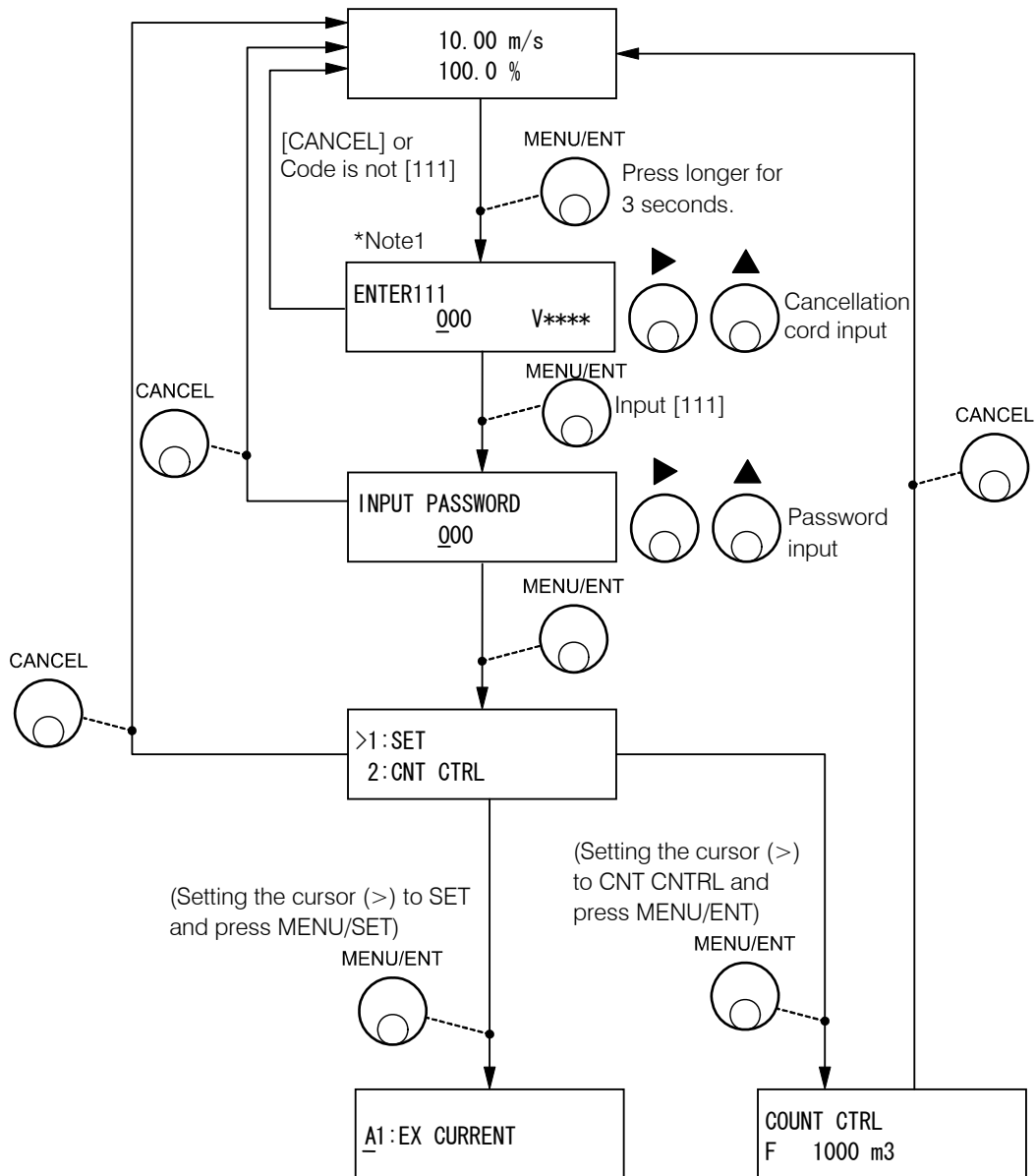

● Mode switching flow when password is set

If password is set, when the mode moves from the measurement mode to the menu screen, the password input screen appears.

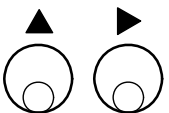

Note1: There is not this screen to the converter before serial No.072320999.
There is not software version (V****) to the converter before version V0109.

● Example of password input (mode selection: SET and password: 123)

Switch operation	Display example	Description
<p>MENU/ENT</p> 	<p>INPUT PASSWORD 000</p>	<p>The password input screen appears from the measurement mode. The cursor appears. Pressing [CANCEL], the screen returns to the mode selection screen.</p>
	<p>INPUT PASSWORD 100</p>	<p>Press [▲] to change the value to 1.</p>
	<p>INPUT PASSWORD 100 120 123</p>	<p>Change the number. To change the number of other digit, press [▶] to move the cursor to that digit and press [▲] to change the number there. Repeat this operation until 123 appears on the screen.</p>
<p>MENU/ENT</p> 	<p>INPUT PASSWORD 123</p>	<p>The display blinks and the set value is displayed for conformation. Pressing [MENU/ENT] again, the password will be written.</p>
<p>MENU/ENT</p> 	<p>>1: SET 2: CNT CTRL</p>	<p>Regardless of whether the password input is correct or not, the screen changes to the mode selection screen. However, if the password input is erroneous, the setting value cannot be changed and calibration cannot be performed.</p>

7.3.4 Totalizer Operation









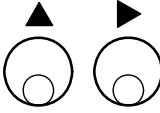

In the totalizer operation mode, the totalizer can be started, stopped and reset.

If password is set (if password input does not match), the totalizer can be started or stopped but it cannot be reset.

Note: To operate the totalizer, it is necessary to set necessary settings for the totalizer.

For details of how to set necessary settings for the totalizer, see 10. "Function Description."

● Example of totalizer operation

Switch operation	Display example	Description
	10.00 m/s 100.0%	(Measurement mode)
Note1 	ENTER111 000 V****	Pressing MENU/ENT in the measurement mode for 3 seconds or more, the screen moves to the menu lock cancellation screen. * Pressing CANCEL in the mode selection screen, the mode returns to the measurement mode.
Note1 	ENTER111 111 V****	Set the menu lock cancellation cord [111] by pressing ▲ and ▶ . * Pressing CANCEL in the mode selection screen, the mode returns to the measurement mode.
	>1: SET 2: CNT CTRL	Press MENU/ENT longer for 3 seconds.
	1: SET >2: CNT CTRL	Select CANCEL in the mode selection screen.
	COUNT CTRL F 1000 m3	The totalizer operation screen appears.
	COUNT CTRL F 1000 m3 C	Pressing ▲ when the totalizer is stopped, the totalizer starts. * "C" mark appears indicating that the totalizer has started.
	COUNT CTRL F 1000 m3	Pressing ▲ while the totalizer is in operation, the totalizer stops. * "C" mark disappears.
	COUNT CTRL F 0 m3	Pressing ▶ , the totalizer will be reset to zero. * If the totalizer is reset, the count value cannot be returned to the previous value.
	10.00 m/s 100.0 %	Pressing CANCEL returns you to the measurement mode.

Note1: There is not this screen to the converter before serial No.072320999.

There is not software version (V****) to the converter before version V0109.







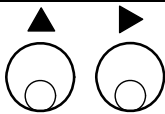

7.3.5 Maintenance Menu

If you enter the service code to release the protection, the maintenance specific items in the setting mode that are not displayed normally can be accessed and the parameters that are normally prohibited to be rewritten can be changed.

This function is mainly used by service personnel, it is not necessary for general customers to enter this function.

If erroneously operated and the service code input screen appears, either press [CANCEL] to return to the measurement mode or press [MENU/ENT] to go on to the setting menu. (In this case, protection will not be released.)

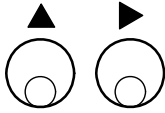
● Example to move to the maintenance menu

Switch operation	Display example	Description
—	10.00 m/s 100.0 %	Measured value being displayed (measurement mode)
Note1 MENU/ENT 	ENTER111 000 V****	Pressing [MENU/ENT] in the measurement mode for 3 seconds or more, the screen moves to the menu lock cancellation screen. * Pressing [CANCEL] in the mode selection screen, the mode returns to the measurement mode.
Note1 	ENTER111 111 V****	Set the menu lock cancellation cord [111] by pressing  and  . * Pressing [CANCEL] in the mode selection screen, the mode returns to the measurement mode.
MENU/ENT 	>1:SET 2: CNT CTRL	Pressing [MENU/ENT] for 3 seconds or more in the measurement mode, the screen moves to the mode selection screen.
 MENU/ENT 	INPUT SRV_CODE 000	Select 1:SET in the mode selection screen and press [MENU/ENT] for 5 seconds or more, then the screen appears that is used to enter the service code to release the protection. Pressing [CANCEL] in the mode selection screen brings you back to the measurement mode.
 MENU/ENT 	A1:EX CURR	Enter the service code and if it is correct, the maintenance specific items in the setting menu can be accessed. Pressing [CANCEL] in the service code input screen brings you back to the mode selection screen.

Note1: There is not this screen to the converter before serial No.072320999.

There is not software version (V****) to the converter before version V0109.

7.4 Setting Menu List

The constants set in the LF232 converter can be checked or changed in the order shown in the table below.

The details of each item are described in the following sections:

- Setting items (A to M): Chapter 8. “Parameter Settings / Adjustment”
- Calibration item (N): Chapter 9. “Mag-Prover Calibration”

	0	1	2	3	4	5	6	7	8
A		Exciting current setting *1	Meter size *1	Exciting frequency *1	Flow direction setting *1	Password *1			
B		Main display unit	Sub display unit	Custom coefficient *1	Custom unit *1				
C		Range type *1	Range 1 *1	Range 2 *1	Range 3 *1	Range 4 *1	Hysteresis *1		
D		Damping constant	Low cutoff value	Current output setting for alarm *1	Display low cut On/Off	Output low limit setting *1			
E		Still water zero adjustment							
F		Digital output 1 *1	Digital output 2 *1	Digital output 3 *1	Digital output 4 *1	DO1 alarm output state *1	DO2 alarm output state *1	DO3 alarm output state *1	DO4 alarm output state *1
G	Return to measurement mode	Digital input 1 *1	Digital input 2 *1	DI1 control signal level setting *1	DI2 control signal level setting *1				
H		Count rate *1	Pulse width setting mode *1	Pulse width *1					
I		Preset count value *1	Preset output setting *1						
J		High limit alarm On/Off *1	High limit value setting *1	Low limit alarm On/Off *1	Low limit value setting *1				
K		High high limit alarm On/Off *1	High high limit value setting *1	Low low limit value On/Off *1	Low low limit value setting *1				
L		Fluid empty alarm *1	Self-diagnosis On/Off *1	Alarm output preset *1					
M		Rate-of-change limit	Control time						
N		Fixed value output *1	Fixed current *1	Fixed pulse *1					
O		Zero offset							
P		0% Flow value calibration *1	50% Flow value calibration	100% Flow value calibration *1	Exciting current monitor				

Note 1: For items marked by *1 in the table above, if you enter a wrong password, you can check the setting value but you cannot change or adjust the setting value.

8. Parameter Settings / Adjustment

8.1 Parameter Setting Items

To check or change each constant set in the LF232 converter, first select the desired setting item described in 7.3.2, “Setting Mode Operation.”

For setting mode items, follow the explanation below to perform the settings.

No.	Setting item	Display example	
8.2.1	Exciting current value	A1: EX CURR	0.2100 A
8.2.2	Meter size	A2: METER SIZE	50 mm
8.2.3	Exciting frequency	A3: EX FREQ	24 Hz
8.2.4	Flow direction	A4: FLOW DIRCTN	1:NORMAL
8.2.5	Password setting	A5: PASSWORD	123
8.2.6	Normal display unit	B1: UNIT 1	m ³ /h
8.2.7	Custom unit setting	B3: CUSTOM DATA B4: CUSTOM UNIT	12340.00 TEST123
8.2.8	Range type Span value Hysteresis	C1: RANGE TYPE C2: RANGE 1 C6: RANGE HYST	1:SINGLE 01.000 m ³ /h 05.0 %
8.2.9	Damping constant	D1: DAMPING	05.0 s
8.2.10	Low cutoff value	D2: LOW CUT	05.0 %
8.2.11	Current output setting for alarm	D3: ALM mA SET	2: 4.0mA
8.2.12	Display low cut On/Off	D4: DSP LOW CUT	1: ON
8.2.13	Output low limit setting	D5: LOW LIMIT	1: 4.0mA
8.5.1	Still water zero adjustment	E1: ZERO ADJUST	0.1 %
8.2.14	Digital output function Alarm output state	F1: DO1 FUNCT F5: DO1 ALM STS	1:HIGH ALM 1:NORMAL CLOSE
	Digital input function Control signal level setting	G1: DI1 FUNCTN G3: DI1 DET LV	2:CNT STA/STP 2:H LEVEL
8.2.15	Count rate Pulse width mode Pulse width	H1: COUNT RATE H2: PLS MODE H3: PLS WIDTH	1.00000 m ³ 1:AUTO 020 ms

No.	Setting item	Display example	
8.2.16	Preset count value Output function setting	I1: PRESET CNT I2: PRESET FNC	00009000 1:HOLD
8.2.17	High/Low limit alarm On/Off High/Low limit alarm value	J1: H ALM SET J2: H ALM VAL	1:ON +100.0 %
	High high/Low low limit alarm On/Off High high/Low low limit alarm value	K1: HH ALM SET K2: HH ALM VAL	1:ON +110.0 %
8.2.18	Fluid empty alarm	L1: EMPTY ALM	1:NORMAL
8.2.19	Self-diagnosis On/Off	L2: SELF CHECK	1:ON
	Alarm output factor setting	L3: ALM PRESET	1:WITHOUT EMP
8.2.20	Rate-of-change limit value Control time	M1: LIMIT RATE M2: LIMIT TIME	05.5 % 01 s
8.4	Fixed value output (Loop check)	N1: FIXED OUT N2: FIXED CURR N3: FIXED PULSE	OFF 20.0 mA 1000 pps
8.5.2	Zero offset adjustment	O1: MANUAL ZERO	-000.1 %



8.2 Parameters Check / Change

8.2.1 Exciting Current Value

The exciting current value is already adjusted when the product is shipped from the factory. Normally the exciting current value is set to the same value as described on the detector nameplate.

● Checking the exciting current value







Proceed as follows to check or change the exciting current value.

Switch operation	Display example	Description
MENU/ENT 	A1: EX. CURR. 0.2100A	Select A1: EX. CURR. from the setting item selection menu. The currently set exciting current value appears.
CANCEL 	A1: EX. CURR.	Returns to the menu of setting item selection.

● Changing the exciting current value

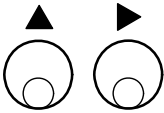
To change the exciting current value, proceed as follows. However, the exciting current value is already adjusted when the product is shipped from the factory. Do not change the exciting current value unless the value is different from the one described on the detector nameplate. If you change this value to other value, this may cause an error.

The following is an example to change the exciting current value from 0.1900A to 0.2150A.

Switch operation	Display example	Description
<p>MENU/ENT</p> 	A1: EX. CURR. 0. 1900A	Select A1:EX. CURR. from the setting item selection menu. The currently set exciting current value (0.1900A in this example) appears.
	A1: EX. CURR. <u>0.</u> 1900A	The cursor appears. Press  further to move the cursor to the desired digit.
	A1: EX. CURR. 0. <u>2</u> 900A 0. 2 <u>1</u> 00A 0. 21 <u>5</u> 0A	Change the number of the digit. To change the number of other digit, press  to move the cursor to that digit and change the number there. Repeat this operation until 0.2150A appears on the display.
<p>MENU/ENT</p> 	A1: EX. CURR. 0. 2150A	The display blinks and the set value is displayed for confirmation. Press  again to write the data. Then the cursor disappears and the display returns to the condition that the setting value is displayed.
<p>CANCEL</p> 	<u>A</u> 1: EX. CURR.	Returns to the menu of setting item selection.

Note: Set the exciting current value within the range shown below:



- For small and medium meter size detectors (LF232*A) 0.0500A to 0.2300A
- For large meter size detectors (LF232*B) 0.0500A to 3.000A
- For partially filled pipes detectors (LF232*F) 0.0500A to 1.500A

If you set an exciting current value outside of the settable range, a message such as *H. OVER SPEC. appears and the value returns to the previous value. Try to set a new value again.

8.2.2 Meter Size







● Checking the meter size of the detector

Proceed as follows to check or change the meter size of the detector.

Switch operation	Display example	Description
MENU/ENT 	A2: METER SIZE 50 mm	Select A2: METER SIZE from the setting item selection menu. The currently set meter size of the detector appears.
CANCEL 	<u>A</u> 2: METER SIZE	Returns to the menu of setting item selection.

● Changing the meter size of the detector

The following is an example to change the meter size from 50mm to 10mm.

Switch operation	Display example	Description
MENU/ENT 	A2: METER SIZE 50 mm	Select A2: METER SIZE from the setting item selection. The currently set meter size (50mm in this example) appears.
	A2: METER SIZE 5 <u>0</u> mm	The cursor appears.
	A2: METER SIZE 1 <u>0</u> 0 mm	Change the set value for meter size to 100mm. The set value for meter size can be changed using  switch. (Note 1)
MENU/ENT 	A2: METER SIZE 100 mm	The display blinks and the set value is displayed for confirmation. Press  again to write the data. Then the cursor disappears and the display returns to the condition that the setting value is displayed.
CANCEL 	<u>A</u> 2: METER SIZE	Returns to the menu of setting item selection.

Note 1: The meter size is displayed cyclically as shown below:

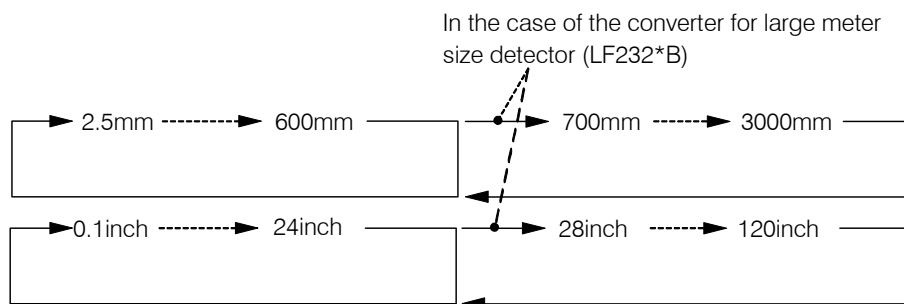

* For partially filled pipes detectors (LF232*F) : 6~24inch (150~600mm)

Note 2: If the setting value for meter value is changed, the setting value by flow unit and the setting value for exciting frequency of no concern may be rewritten.

After the meter size is set, be sure to check the setting values of Range, Count (Pulse) Rate and Exciting Frequency.

8.2.3 Exciting Frequency

The exciting frequency can be selected from 6Hz, 12Hz and 24Hz. Since the features shown below are apparent depending on the exciting frequency, select an appropriate exciting frequency.

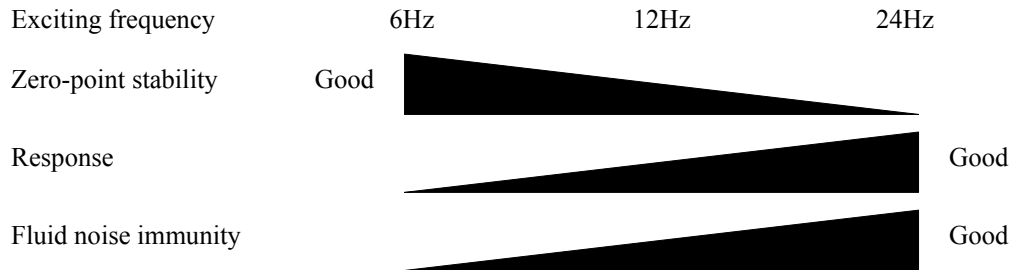

However, the range of usable exciting frequency depending on the detector to be combined is shown below.



Detector combined	Meter size	Corresponding exciting frequency		
		6Hz	12Hz	24Hz
LF470	1/10",1/6",1/4" (2.5 to 6 mm)	○	○	◎
LF150	26" to 120" (500 to 3000 mm)	◎	—	—
335	All sizes	◎	—	—

* Partially filled pipes type LF232*F : Useable only 6Hz

- ◎ Factory setting
- Combination allowed
- Combination not allowed





● Checking the exciting frequency

Proceed as follows to check or change the setting value for exciting frequency.

Switch operation	Display example	Description
MENU/ENT 	A3: EX. FREQ. 24 Hz	Select A3: EX. FREQ. from the setting item selection menu. The currently set exciting frequency appears.
CANCEL 	<u>A</u> 3: EX. FREQ.	Returns to the menu of setting item selection.

● Changing the setting value for exciting frequency.

The following is an example to change the exciting frequency from 24Hz to 12Hz.

Switch operation	Display example	Description
MENU/ENT 	A3: EX. FREQ. 24 Hz	Select A3: EX FREQ. from the setting item selection menu. The currently set exciting frequency (24Hz in this example) appears.
	A3: EX. FREQ. 2 <u>4</u> Hz	The cursor appears.
	A3: EX. FREQ. 1 <u>2</u> Hz	Change the exciting frequency to 12Hz. The exciting frequency appears cyclically between 6Hz, 12Hz and 24Hz. (Note 1)
MENU/ENT 	A3: EX. FREQ. 12 Hz	The display blinks and the set value is displayed for confirmation. Press MENU/ENT again to write the data. Then the cursor disappears and the display returns to the condition that the setting value is displayed.
CANCEL 	<u>A</u> 3: EX. FREQ.	Returns to the menu of setting item selection.

Note 1: The exciting frequency is displayed cyclically as shown below.

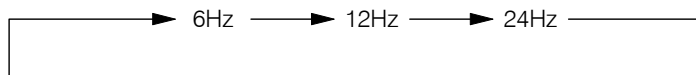

* Partially filled pipes type LF232*F : Useable only 6Hz

8.2.4 Flow Direction



The flow direction of fluid can be set.

Normally use the flowmeter under the condition of NORMAL.

Selection item	Description
1: NORMAL	The flow is a direct flow when the fluid flows in the direction indicated by the arrow on the detector.
2: SWITCH	The flow is a direct flow when the fluid flows in the reverse direction of the arrow on the detector.





● **Checking the flow direction.**

Proceed as follows to check or change the setting value for direction flow.

Switch operation	Display example	Description
MENU/ENT 	A4: FLOW DIRCTN 1: NORMAL	Select A4: FLOW DIRCTN from the setting item selection menu. The currently set flow direction appears.
CANCEL 	<u>A</u> 4: FLOW DIRCTN	Returns to the menu of setting item selection.

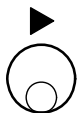
● Changing the flow direction.

The following is an example to show how to change the flow direction from NORMAL to SWITCH.

Switch operation	Display example	Description
MENU/ENT 	A4: FLOW DIRCTN 1:NORMAL	Select A4: FLOW DIRCTN from the setting item selection menu. The currently set flow direction (NORMAL in this example) appears.
	A4: FLOW DIRCTN <u>1</u> :NORMAL	The cursor appears.
	A4: FLOW DIRCTN <u>2</u> :SWITCH	Change the flow direction to SWITCH.
MENU/ENT 	A4: FLOW DIRCTN 2:SWITCH	The display blinks and the set value is displayed for confirmation. Press MENU/ENT again to write the data. Then the cursor disappears and the display returns to the condition that the setting value is displayed.
CANCEL 	<u>A</u> 4: FLOW DIRCTN	Returns to the menu of setting item selection.

8.2.5 Password Setting

The password function is provided to prohibit the settings and adjustment for the functions that affect the flow measurement. See 7.4 “Setting Menu List” for the functions limited by the password function.



If other than “000” is set for password and the mode is returned to the measurement mode, the password function becomes valid. If “000” is set, there is no limitation such as setting is prohibition by password.

● **Checking the password**

Proceed as follows to check the password.











However, if other than “000” is set for password, you cannot check the password when you move to the setting mode unless you enter the correct password.

(If you enter a wrong password, *** appears for password.)

Switch operation	Display example	Description
MENU/ENT 	A5: PASSWORD 123	Select A5: PASSWORD from the setting item selection menu. The currently set password appears.
CANCEL 	A5: PASSWORD	Returns to the menu of setting item selection item.

● Changing the password

The following is an example to show how to change the password from 123 to 453.

Switch operation	Display example	Description
MENU/ENT 	A5: PASSWORD 123	Select A5: PASSWORD from the setting item selection menu. The currently set password data (123 in this example) appears. However, if a wrong password is entered when you move from the measurement mode to the setting mode, *** appears.
	A5: PASSWORD <u>1</u> 23	The cursor appears.
	A5: PASSWORD <u>4</u> 23	Press  to change the number of the 3rd digit of the password from the right to 4.
	A5: PASSWORD <u>4</u> 23	Move the cursor to the 2nd digit.
	A5: PASSWORD <u>4</u> 53	Press  switch to change the number of the 2nd digit of the password to 5.
MENU/ENT 	A5: PASSWORD 453	The display blinks and the set value is displayed for conformation. Press  again to writer the data. Then the cursor disappears and the display returns to the condition that the setting value is displayed.
CANCEL 	<u>A</u> 5: PASSWORD	Returns to the menu of setting item selection.

Note: If password is set, be sure so manage the system so that the password is protected and not forgotten.

If you forgot your password, you can check the password using the maintenance menu. For the procedure to move to the maintenance menu, see 7.3.5 “Maintenance Menu.” The service code to check the password is “800”.

For the management method including the method to read the password, use the management method conforming to the management standard of the system used.



8.2.6 Normal Indicating Unit

You can select one of the units listed below as normal indicating unit for 2 types of units, main unit (UNIT 1) and sub unit (UNIT 2) to be displayed in the measurement mode.

- Flow velocity unit: m/s, ft/s
 - Flow rate unit: m³/s, m³/min, m³/h, m³/d
 l/s, l/min, l/h, l/d
 ml/s, ml/min, ml/h, ml/d
 gal/s, gal/min, gal/h, gal/d
 bbl/s, bbl/min, bbl/h, bbl/d
 pt/s, pt/min, pt/h, pt/d
 qt/s, qt/min, qt/h, qt/d
 - Volumetric flow: m³, l, ml, gal, bbl, pt, qt
 - Other units: %, COUNT, RANGE, CUSTOM
 - %: Indicates the value in percent of the setting range
 When multi-range is selected, the value is in percent of the range in operation.
 - COUNT: Indicates the count of the totalizer.
 - RANGE: Indicates the range number of the range in operation when multi-range is selected.
 - CUSTOM: Indicates the flow rate value in the unit defined in 8.2.7 “Custom Unit.”
 If the unit is set to volumetric flow or COUNT, the flow direction for total flow can be set.
- If the indicating unit is set to volumetric flow or COUNT, the flow direction for total flow can also be set.
- Volumetric flow direction: F: Forward direction, R: Reverse direction
 B: Forward/Reverse automatic switching, D: Total difference flow indication











● Checking the normal indicating unit

Proceed as follows to check the normal indicating unit.
Here, only about the main unit (UNIT1) is explained. For sub unit (UNIT2), select the function number “B2”.

Switch operation	Display example	Description
MENU/ENT 	B1: UNIT 1 %	Select B1: UNIT 1 from the setting item selection menu. The currently set main indicating unit appears.
CANCEL 	<u>B</u> 1: UNIT 1	Returns to the menu of setting item selection.

● **Checking the normal indicating unit**

The following is an example to change the main indicating unit (UNIT1) from % to ml/s.
 In the case of sub unit (UNIT2), select the function “B2: UNIT 2.”

Switch operation	Display example	Description
MENU/ENT 	B1: UNIT 1 %	Select B1: UNIT 1 from the setting item selection menu. The currently set main indicating unit (% in this example) appears.
 	B1: UNIT 1 <u>%</u>	The cursor appears.
 	B1: UNIT 1 ml B	Change the volumetric unit to ml. (Note 1)
 	B1: UNIT 1 ml <u>_</u> B	Move the cursor to the position of time unit.
 	B1: UNIT 1 ml/ <u>s</u>	Change the time unit to s. (Note 2)
MENU/ENT 	B1: UNIT 1 ml/s	The display blinks and the set value is displayed for confirmation. Press MENU/ENT again to write the data. Then the cursor disappears and the display returns to the condition that the setting value is displayed.
CANCEL 	<u>B</u> 1: UNIT 1	Returns to the menu of setting item selection.

Note 1: Volumetric unit is displayed cyclically as follows:

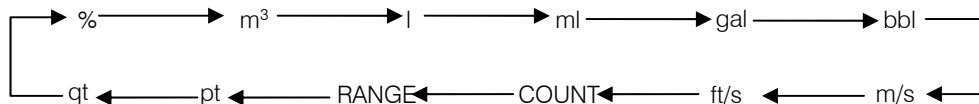

Note 2: Time unit is displayed cyclically loops as follows:

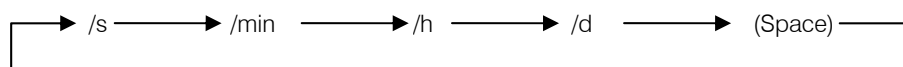











● Changing the flow direction for total flow

Proceed as follows to change the flow direction for total flow.

The following is an example to show how to change the main indicating unit from Forward flow (F) to Forward/Rverse automatic switching (B).

In the case of sub unit (UNIT2), select the function “B2: UNIT 2.”

Switch operation	Display example	Description
MENU/ENT 	B1: UNIT 1 m ³ F	Select B1: UNIT 1 from the setting item selection menu. The currently set main indicating unit (m ³ F in this example) appears.
 	B1: UNIT 1 <u>m</u> ³ F	The cursor appears.
 	B1: UNIT 1 m ³ <u>_</u> F	Move the cursor to the position of time unit.
 	B1: UNIT 1 m ³ <u>F</u>	Move the cursor to the position of flow direction for total flow.
 	B1: UNIT 1 m ³ <u>B</u>	Change the flow direction for total flow to B (forward/reverse automatic switching). (Note 1)
MENU/ENT 	B1: UNIT 1 m ³ B	The display blinks and the set value is displayed for conformation. Press MENU/ENT again to write the data. Then the cursor disappears and the display returns to the condition that the setting value is displayed.
CANCEL 	<u>B</u> 1: UNIT 1	Returns to the menu of setting item selection.

Note 1: The flow direction for total flow is displayed cyclically as follows:

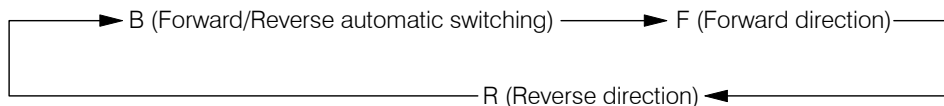

8.2.7 Custom Unit

The custom unit, which indicates the flow rate multiplied by an arbitrary coefficient, can be defined. The flow rate indication using the custom unit defined here can be used by selecting CUSTOM in the indicating unit setting.

The custom unit consists of an coefficient and a unit string

● Coefficient of custom unit

A coefficient to determine the numeric value for indication by custom unit

The indicated value is calculated in the following equation:

$$\text{Custom unit indication (numeric value)} = \text{Measured value in m}^3/\text{min} \times \text{Custom coefficient}$$

The custom coefficient can be set in a numeric value of 6 digits including a decimal point.

● Unit string of custom unit

The unit to be used for indication by custom unit

A string of up to 7 characters using the following codes can be set.

Alphabetic letters (lower case letters) : a – z

Alphabetic letters (upper case letters) : A – Z



Number: 0 – 9

Symbol:

()	Parentheses
%	Percent
.	Period (dot)
.	Point
:	Colon
=	Equal sign
-	Minus (hyphen)
*	Asterisk
/	Slash
□	Space (blank)







● **Checking the coefficient of custom unit**

Proceed as follows to check the coefficient of custom unit.

Switch operation	Display example	Description
MENU/ENT 	B3: CUSTOM DATA 12340.00	Select B3: CUSTOM DATA from the setting item selection menu. The currently selected coefficient appears.
CANCEL 	<u>B</u> 3: CUSTOM DATA	Returns to the menu of setting item selection.

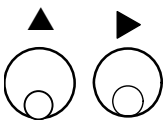

● **Changing the coefficient of custom unit**

The following is an example to show how to change the coefficient from 1.00 to 1.25.

Switch operation	Display example	Description
MENU/ENT 	B3: CUSTOM DATA 1.000000	Select B3: CUSTOM DATA from the setting item selection menu. The currently set coefficient appears.
	B3: CUSTOM DATA <u>1</u> .000000	The cursor appears. Press  further to move the cursor to the desired digit to change.
	B3: CUSTOM DATA 1. <u>2</u> 00000 ↓ 1.2 <u>5</u> 0000	Change the number of the digit. To change other digit, press  to move the cursor to that digit and change the number there. Repeat this operation until 1.250000 appears on the display.
MENU/ENT 	B3: CUSTOM DATA 1.250000	The display blinks and the set value is displayed for confirmation. Press  again to write the data. Then the cursor disappears and the display returns to the condition that the setting value is displayed.
CANCEL 	<u>B</u> 3: CUSTOM DATA	Returns to the menu of setting item selection.







● **Checking the unit string of custom unit**

Proceed as follows to check the unit string of custom unit.

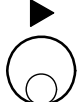
Switch operation	Display example	Description
MENU/ENT 	B4: CUSTOM UNIT AAA/BBB	Select B4: CUSTOM DATA from the setting item selection menu. The currently set unit appears.
CANCEL 	<u>B</u> 4: CUSTOM UNIT	Returns to the menu of setting item selection.

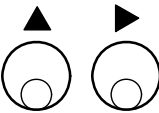
● **Changing the unit string of custom unit**

The following is an example to show how to change the unit string from AAA/BBB to XXX/ZZZ.

Switch operation	Display example	Description
MENU/ENT 	B4: CUSTOM UNIT AAA/BBB	Select B4: CUSTOM UNIT from the setting item selection menu. The currently set unit appears.
	B4: CUSTOM UNIT <u>A</u> AA/BBB	The cursor appears. Press  further to move the cursor to the desired digit to change.
	B4: CUSTOM UNIT <u>X</u> AA/BBB ↓ XXX/ZZ <u>Z</u>	Change the character of the digit. (Note 1) To change other digit, press  to move the cursor to that digit and change the character there. Repeat this operation until XXX/ZZZ appears on the display.
MENU/ENT 	B4: CUSTOM UNIT XXX/ZZZ	The display blinks and the set value is displayed for confirmation. Press  again to write the data. Then the cursor disappears and the display returns to the condition that the set value is displayed.
CANCEL 	<u>B</u> 4: CUSTOM UNIT	Returns to the menu of setting item selection.

Note 1: The selectable characters are displayed cyclically as shown below:

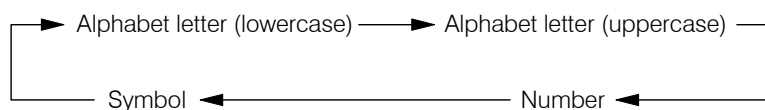

8.2.8 Span Value (Range)

The following constants are set here.

- (1) Range type
- (2) Span unit (changeable only for Range 1)
- (3) Span value
- (4) Hysteresis

● Range type

By selecting the range type, the multi-range function can be used in which the range in operation is switched between the multiple ranges depending on whether the flow rate is value large or small, or the flow direction is forward or reverse.

If it is not necessary to use the multi-range function, set the Range type to Single range.

RANGE TYPE	RANGE TYPE	
1: SINGLE	Single range	
2: 4F-0R	Single direction, 4 ranges	Internal automatic switching
3: 2F-2R	Forward/reverse direction, 2 ranges	Internal automatic switching
4: EXT. 2F-0R	Single direction, 2 ranges	External signal switching
5: EXT. 2F-2R	Forward/reverse direction, 2 ranges	External signal switching
6: EXT. 4F-0R	Single direction, 4 ranges	External signal switching

Note: To use the multi-range function, the following DO and DI are required:

In the case of internal automatic switching ranges

2 ranges, forward/reverse range.....1 Digital Output

3 ranges or more, forward/reverse 2 ranges.....2 Digital Outputs

In the case of external signal switching ranges

2 ranges, forward/reverse range.....1 Digital Inputs

3 ranges or more, forward/reverse 2 ranges.....2 Digital Inputs

● Span value

The span value can be set using the actual flow rate unit (m³/h, etc.) and flow velocity unit (m/s).

(1) Setting range

The span value can be set within the range of 0 – 1.0 ft/s to 0 – 32.8 ft/s (0.1m/s to 10m/s) in terms of flow velocity

(The range that detector can measure changes with detector type. The details please refer to Chapter 15 "specifications")

If you try to set a span value outside of this range, either of the following messages appears depending on whether it is a high limit or low limit error:

* H. OVER SPEC. (if a value exceeding 32.8 ft/s (10 m/s) is set)

* L. OVER SPEC. (if a value of less than 1.0 ft/s (0.1 m/s) is set)

Try to set a new value again.

In the case of Single range setting, select Range 1 only.

(2) Multi-range setting

To use the multi-range function, select Ranges 1 to 4.

When you set these ranges, the following condition must be observed:

Range 1 > Range 2 > Range 3 > Range 4 (in the case of single direction, multiple ranges)

Range 1 > Range 2, Range 3 > Range 4 (in the case of forward/reverse direction, multiple ranges)

If you try to set the ranges not conforming to the above condition, the following message appears:

* MULTI RNG ERR

Try to set the ranges again.

In addition, set "0" for the ranges not used.

(3) Influence on count rate (pulse rate)

If the range is changed when the count rate (pulse rate) is already set, pulse output at the time of 100% output may exceed the allowable output range.

If this happens, either of the following messages appears after the ranges are set and the system goes to the count rate setting.

* H. OVER C RATE or * L. OVER C RATE

Try to set the count rate (pulse rate) again referring to 8.2.15 "Count Rate (pulse rate) and Pulse Width."

● Unit of span

Range 1 is used to set the unit of span. The unit applies automatically to other ranges of Range 2 to Range 4 and it is not necessary to set the unit for these ranges separately.

The setting units can be selected from the following units:

● Flow velocity unit: m/s

● Flow rate unit: m³/s, m³/min, m³/h, m³/d, l/s, l/min, l/h, l/d, ml/s, ml/min, ml/h, ml/d

If you change the unit, the new span value based on the newly set unit will be automatically displayed.

● Hysteresis

The dead band, which is used to switch the ranges in the case of internal automatic switching multi-range, is set here.

It is not necessary to set hysteresis in other range types. (The set value will be ignored.)

The hysteresis can be set within the range of 0 to 25% in increments of 0.1%.

● Span value (range) setting flow

The setting sequence of span value (range) is shown below.

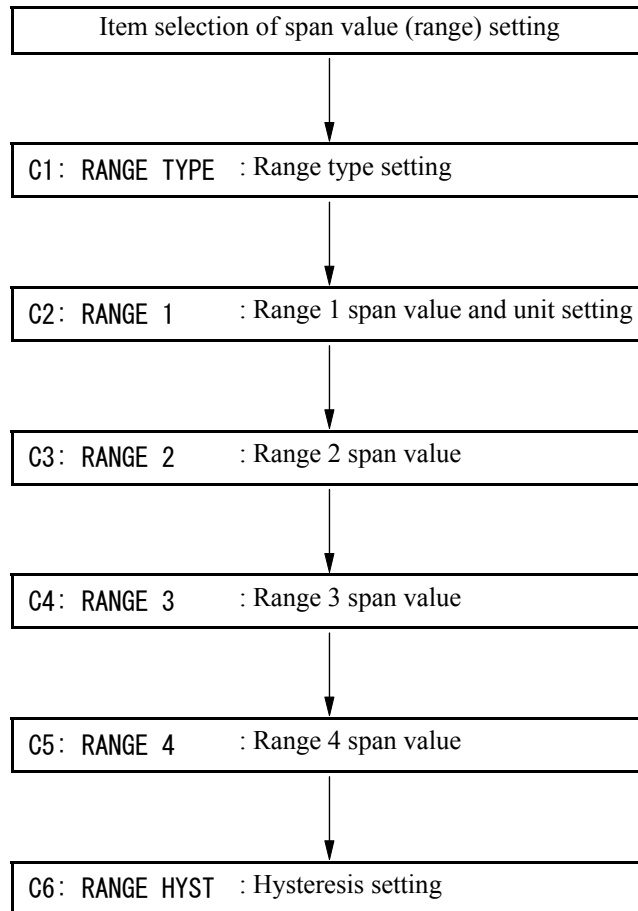

● Checking each constant

How to check the Range 1 is shown here.

To check other setting values, select the following function numbers:



Range type C1: RANGE TYPE

Range 2 span value C3: RANGE 2

Range 3 span value C4: RANGE 3

Range 4 span value C5: RANGE 4





Hysteresis C6: RANGE HYST

Switch operation	Display example	Description
MENU/ENT 	C2: RANGE 1 02.000 m/s	Select C2:RANGE 1 from the setting item selection menu. The currently set Range 1 span value appears.
CANCEL 	C2: RANGE 1	Returns to the menu of setting item selection.

● Changing the range type

Before changing the span value, Rang type must be set.











The following is an example to show how to change the range type from Single range (1:SINGLE) to the bidirectional internal signal switching multi-range (3:2F-2R).

Switch operation	Display example	Description
MENU/ENT 	C1: RANGE TYPE 1:SINGLE	Select C1: RANGE TYPE from the setting item selection menu. The currently set range type (1:SINGLE) appears.
	C1: RANGE TYPE <u>1</u> :SINGLE	The cursor appears.
	C1: RANGE TYPE <u>3</u> :2F-2R	Select the range type 3:2F-2R.
MENU/ENT 	C1: RANGE TYPE 3:2F-2R	The display blinks and the set value is displayed for confirmation. Press MENU/ENT again to write the data. Then the cursor disappears and the display returns to the condition that the set value is displayed.
CANCEL 	<u>C</u> 1: RANGE TYPE	Returns to the menu of setting item selection.

● **Changing the span value**

The span value for each range is set.

The following is an example to show how to change the span value of Range 1 from 2.0m³/h to 100 l/min.

Switch operation	Display example	Description
MENU/ENT 	C2: RANGE 1 2.0000 m ³ /h	Select C2: RANGE 1 from the setting item selection menu. The currently set span value for Range 1 (2.0 m ³ /h in this example) appears.
	C2: RANGE 1 <u>2</u> .0000 m ³ /h	The cursor appears. Press  further to move the cursor to the digit of volumetric unit.
	C2: RANGE 1 2000.0 <u>l</u> /h ↓ 33.333 <u>l</u> /min	Change the volumetric unit to l. Press  to move the cursor to the digit of time unit and likewise change the unit to min. (Note) (The span value will be automatically changed as this unit is changed.)
	C2: RANGE 1 <u>33</u> .333 l/min	Move the cursor to the desired digit to change.
	C2: RANGE 1 <u>13</u> .333 l/min ↓ 100. <u>00</u> l/min	Change the number of the digit. To change other digit, press  under this condition to move the cursor to that digit and change the number there.
MENU/ENT 	C2: RANGE 1 100. <u>00</u> l/min	The display blinks and the set value is displayed for confirmation. Press  again to write the data. The cursor disappears and returns to the condition that the set value is displayed.
CANCEL 	<u>C2</u> : RANGE 1	Returns to the menu of setting item selection.

Note: The items of unit are displayed cyclically as shown below:

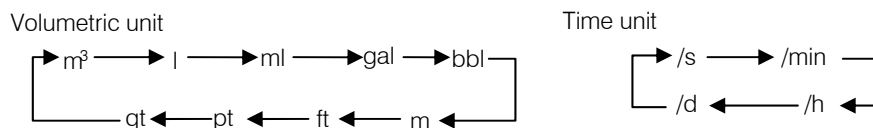









- A combination of m/min, m/h, m/d, ft/min, ft/h and ft/d cannot be selected.

● Changing the hysteresis

The hysteresis value is set to 3% unless otherwise specified when the converter is shipped from the factory.

The following is an example to show how to change the hysteresis value from 3% to 5%.

Switch operation	Display example	Description
MENU/ENT 	C6: RANGE HYST 03.0 %	Select C6: RANGE HYST from the setting item selection menu. The currently set hysteresis value appears. (Note)
	C6: RANGE HYST <u>0</u> 3.0 %	The cursor appears.
	C6: RANGE HYST 0 <u>3</u> .0 %	Move the cursor to the desired digit to change.
	C6: RANGE HYST 0 <u>5</u> .0 %	Change the number of the digit. To change other digit, press  under this condition to move the cursor to that digit and change the number there.
MENU/ENT 	C6: RANGE HYST 05.0 %	The display blinks and the set value is displayed for confirmation. Press  again to write the data. Then the cursor disappears and the display returns to the condition that the setting value is displayed.
CANCEL 	<u>C</u> 6: RANGE HYST	Returns to the menu of setting item selection.

Note: If you try to set a value exceeding 25.0%, *H. OVER SPEC.* appears and the value returns to the previously set value. Try to set a new value again.

8.2.9 Damping Constant

The damping constant is set to average out the output fluctuations. (The larger the damping constant, the more the output is averaged and the fluctuations can be reduced but the response becomes slower.)

The damping constant can be set from 0.0sec, 0.5sec, and 1 to 60sec (1sec each).



(If detector is partially filled pipes type, the damping constant can be set from 0.0sec, 5sec, and 10 to 600sec (1sec each).)

Note: If 0.0 sec is set, the damping constant becomes a value equivalent to 0.1 sec.

If you set a value exceeding 60s, it is forcibly changed to 60s before data is written.









● Checking the damping constant

Proceed as follows to check the damping constant.

Switch operation	Display example	Description
MENU/ENT 	D1: DAMPING 02.0 s	Select D1: DAMPING from the setting item selection menu. The currently set damping constant appears.
CANCEL 	<u>D</u> 1: DAMPING	Returns to the menu of setting item selection.

● Changing the damping constant

The following is an example to show how to change the damping constant from 0.5 sec to 10 sec.

Switch operation	Display example	Description
MENU/ENT 	D1: DAMPING 00.5 s	Select D1: DAMPING from the setting item selection menu. The currently set damping constant (0.5 s in this example) appears.
	D1: DAMPING <u>0</u> 0.5 s	The cursor appears. Press  further to move the cursor to the desired digit to change.
	D1: DAMPING 1 <u>0</u> .5 s 10. <u>0</u> s	Change the number of the digit. To change other digit, press  under this condition to move the cursor to that digit and change the number these.
MENU/ENT 	D1: DAMPING 10.0 s	The display blinks and the set value is displayed for confirmation. Press  again to write the data. Then the cursor disappears and the display returns to the condition that the setting value is displayed.
CANCEL 	<u>D</u> 1: DAMPING	Returns to the menu of setting item selection.

Note: If you set a value exceeding max value, it is forcibly changed to max value before data is written.

8.2.10 Low Cutoff value



The low cutoff is the function to forcefully fix the current output to 0% when the flow rate becomes equal or below the low cutoff value set near 0%.

The low cutoff value can be set from 0 to 10% and in increments of 0.1%.

If 0% is set, the low cutoff function does not work.









● **Checking the low cutoff value**

Proceed as follows to check the low cutoff value.

Switch operation	Display example	Description
MENU/ENT 	D2: LOW CUT 01.0 %	Select D2: LOW CUT from the setting item selection menu. The currently set low cutoff value appears.
CANCEL 	<u>D</u> 2: LOW CUT	Returns to the menu of setting item selection.

● Changing the low cutoff value

The following is an example to show how to change the low cutoff value from 1.0% to 3.0%.

Switch operation	Display example	Description
MENU/ENT 	D2: LOW CUT 01.0 %	Select D2: LOW CUT from the setting item selection menu. The currently set low cutoff value (1.0 % in this example) appears.
	D2: LOW CUT <u>0</u> 1.0 %	The cursor appears. Press  further to move the cursor to the desired digit to change.
	D2: LOW CUT 0 <u>3</u> .0 %	Change the number of the digit. To change another digit, press  under this condition to move the cursor to that digit and change the number there.
MENU/ENT 	D2: LOW CUT 03.0 %	The display blinks and the set value is displayed for confirmation. Press  again to write the data. Then the cursor disappears and the display returns to the condition that the setting value is displayed.
CANCEL 	<u>D</u> 2: LOW CUT	Returns to the menu of setting item selection.

Note: If you try to set a value exceeding 10.0%, *H. OVER SPEC.* appears and the value returns to the previously set value. In that case, try to set a new value again.

8.2.11 Current Output Setting Used When an Alarm Occurs

The current output value setting used when an alarm occurs is the function to fix the current output to a pre-selected value if a fluid empty alarm or a self-diagnosis alarm occurs.

For the type of alarms to fix the current output, see the alarm output factor setting in 8.2.19 “Self-Diagnosis Function.”



Select the current output value used when an alarm occurs from the table shown below.

● **Current output setting function used when an alarm occurs**

Selection	Current output value when an alarm occurs
1: UNDER 3.0mA	3.0mA or less
2: 4.0mA	4.0mA
3: HOLD	Fixed to the current output
4: OVER 24.0mA	24.0mA or more







● **Checking the current output value used when an alarm occurs**

Proceed as follows to check the current output value used when an alarm occurs.

Switch operation	Display example	Description
MENU/ENT 	D3: 4-20 ALM. OUT 2: 4.0mA	Select D3: 4-20 ALM. OUT from the setting item selection menu. The currently set current output value used when an alarm occurs appears.
CANCEL 	<u>D</u> 3: 4-20 ALM. OUT	Returns to the menu of setting item selection.

● Changing the current output value used when an alarm occurs

The following is an example to show how to change the current output value, which is used when an alarm occurs, from 4.0mA (2: 4.0mA) to 24.0mA or more (4: OVER 24.0mA).

Switch operation	Display example	Description
MENU/ENT 	D3: 4-20 ALM. OUT 2: 4.0mA	Select D3: 4-20 ALM. OUT from the setting item selection menu. The currently set alarm output value used when an alarm occurs appears.
	D3: 4-20 ALM. OUT <u>2</u> : 4.0mA	The cursor appears.
	D3: 4-20 ALM. OUT 4: OVER 24.0mA	Press  to select 4: OVER 24.0mA.
MENU/ENT 	D3: 4-20 ALM. OUT 4: OVER 24.0mA	The display blinks and the set value is displayed for confirmation. Press  again to write the data. Then the cursor disappears and the display returns to the condition that the setting value is displayed.
CANCEL 	<u>D</u> 3: 4-20 ALM. OUT	Returns to the menu of setting item selection.



8.2.12 Display low cut On/Off

When the low output is cutoff by the setting in 8.2.10 “Low cutoff value,” whether the instantaneous flow rate, flow velocity and % value should be set to zero or not can be selected.

Selection	Display low cutoff
1: ON	Display low cut is effective (On) Display (instantaneous flow rate, flow velocity and %) will be set to zero when the low output is cutoff.
2: OFF	Display low cut is not effective (Off) Measured value will be output even if the low output is cutoff.







● **Checking whether the display low cut is On or Off**

Proceed as follows to check whether the display low cut is On or Off.

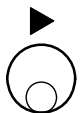
Switch operation	Display example	Description
MENU/ENT 	D4: DSP LOW CUT 2: OFF	Select D4: DSP LOW CUT from the setting item selection menu. The currently set display low cut On/Off status appears.
CANCEL 	<u>D</u> 4: DSP LOW CUT	Returns to the menu of setting item selection.

● Changing the display low cut On/Off setting.

The following is an example to show how to change the display low cut setting from 2:OFF to 1:ON.

Switch operation	Display example	Description
MENU/ENT 	D4: DSP LOW CUT 2:OFF	Select D3: 4-20 ALM. OUT from the setting item selection menu. The currently set alarm output value used when an alarm occurs appears.
	D4: DSP LOW CUT <u>2</u> :OFF	The cursor appears.
	D4: DSP LOW CUT <u>1</u> :ON	Press  to select 1:ON.
MENU/ENT 	D4: DSP LOW CUT 1:ON	The display blinks and the set value is displayed for confirmation. Press  again to write the data. Then the cursor disappears and the display returns to the condition that the set value is displayed.
CANCEL 	<u>D</u> 4: DSP LOW CUT	Returns to the menu of setting item selection.

8.2.13 Output Low Limit Setting

The low limit for 4 to 20mA output can be selected.

If 3.2mA or 2.4mA is selected, the output value of less than 4mA (0%) can be output when the flow is in reverse direction.

The output low limit setting can be selected from the items shown in the table below.

● Output low limit value



Selection	Output low limit value
1:4.0mA	4.0mA(0%)
2:3.2mA	3.2mA (-5%)
3:2.4mA	2.4mA (-10%)

* To set the output low limit to other than 4.0mA, set the low cutoff value to 0% in 8.2.10 “Low Cutoff Value.”

If the low cutoff value is set to other than 0%, the output low limit value becomes 4.0mA fixed regardless of the value of the output low limit setting.







● Checking the output low limit value setting.

Proceed as follows to check the output low limit value.

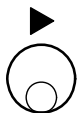
Switch operation	Display example	Description
MENU/ENT 	D5: LOW LIMIT 1:4.0mA	Select D5: LOW LIMIT from the setting item selection menu. The currently set output low limit value appears.
CANCEL 	D5: LOW LIMIT	Returns to the menu of setting item selection.

● Changing the output low limit value setting.

The following is an example to change the output low limit setting from 4.0mA (1: 4.0mA) to 3.2mA (2: 3.2mA).

Switch operation	Display example	Description
MENU/ENT 	D5: LOW LIMIT 1:4.0mA	Select D5: LOW LIMIT from the setting item selection menu. The currently set output low limit value appears.
	D5: LOW LIMIT <u>1</u> :4.0mA	The cursor appears.
	D5: LOW LIMIT <u>2</u> :3.2mA	Press  to select 2:3.2mA.
MENU/ENT 	D5: LOW LIMIT 2:3.2mA	The display blinks and the set value is displayed for confirmation. Press  again to write the data. Then the cursor disappears and the display returns to the condition that the setting value is displayed.
CANCEL 	<u>D</u> 5: LOW LIMIT	Returns to the menu of setting item selection.

8.2.14 Digital I/O Function

Digital I/O functions can be selected.

Select the digital I/O functions from the items shown below.

For details of digital I/O functions, see 10. “Function Description.”

● Digital output functions (corresponding to each terminal)

DO FUNCT.	Digital output functions	DO1	DO2	DO3 to DO4
1: NO USE	Not used	○	○	○
2: HIGH ALM	High limit alarm output★	○	○	○
3: HH ALM	High-high limit alarm output★	○	○	○
4: LOW ALM	Low limit alarm output★	○	○	○
5: LL ALM	Low-low limit alarm output★	○	○	○
6: RNG SIG 1	Range output No.1	○	○	○
7: RNG SIG 2	Range output No.2	○	○	○
8: PRESET	Preset counter output	○	○	○
9: CONV. ALM	Converter error alarm output★ (Note 3)	○	○	○
A: EMPTY ALM	Fluid empty alarm output★	○	○	○
B: PULSE OUT	Pulse output (Note 1)	○	○(Note 2)	—
C: PULSE FRD	Forward flow pulse output	○	○(Note 2)	—
D: PULSE REV	Reverse flow pulse output	○	○(Note 2)	—

○: Enabled — : Disabled

Note 1: When the range type is set to the forward/reverse multi-range, and the pulse output (8: PULSE OUT) is selected, pulse output can be sent out in either forward current or reverse current flow.

Note 2: Pulse output using the DO2 can be sent out up to 100pps.

When the pulse output is sent out using the DO2, set the count rate so that the pulse output for full scale value does not exceed 100pps.

For count rate setting, see 8.2.15 “Count Rate (Pulse Rate) and Pulse Width.”

Note 3: For the types of alarms to output, see the alarm output factor setting in 8.2.19 “Self-Diagnosis Function.”

● Digital output state (only when alarm output is set)

For alarm output function (items indicated by★above), alarm output operation can be selected independently for each DO terminal.

DO ALM ACT	Alarm output operation
1: NORMAL CLOSE	Normal: Contact closed, When alarm occurs: Contact open
2: NORMAL OPEN	Normal: Contact open, When alarm occur: Contact closed

● Digital Input Function

DI FUNCT.	Digital input function
1: NO USE	Not used
2: C STA/STP	Totalizer Start/Stop control★
3: C RES/STA	Totalizer Reset/Start control★
4: RANGE SW1	Multi-range external switching signal 1
5: ZERO ADJ	Still water zero adjustment start
6: FIXED OUT	Fixed-value output mode control
7: RANGE SW2	Multi-range external switching signal 2

● Level setting for digital input control signal (for totalizer control only)

For totalizer control (items indicated by★above), the operating level (active level) for input control signal can be selected for each DI terminal.

DI DET LEVEL	Control signal level
1: L LEVEL	Low level active
2: H LEVEL	High level active



The operation for control signal input is shown below depending on the active level setting.

Digital input function setting	Control signal level setting	Operation when control signal is input
CNT STA/STP (Totalizer Start/Stop)	L LEVEL	High signal: Totalization Stop Low signal: Totalization Start
	H LEVEL	High signal: Totalization Start Low signal: Totalization Stop
CNT RES/STA (Totalizer Reset/Start)	L LEVEL	High signal: Totalization Start Low signal: Totalization Reset
	H LEVEL	High signal: Totalization Reset Low signal: Totalization Start

● Checking each setting for digital I/O

The following is an example to show how to check the function setting of Digital Output 1. To check other setting values, select the following function numbers.

- | | |
|--------------------------------------|-----------------|
| Digital Output 1 | F1: D01 FNCTN |
| Digital Output 2 | F2: D02 FNCTN |
| Digital Output 3 | F3: D03 FNCTN |
| Digital Output 4 | F4: D04 FNCTN |
| Digital Output alarm state 1 | F5: D01 ALM STS |
| Digital Output alarm state 2 | F6: D02 ALM STS |
| Digital Output alarm state 3 | F7: D03 ALM STS |
| Digital Output alarm state 4 | F8: D04 ALM STS |
| Digital Input 1 | G1: D11 FNCTN |
| Digital Input 2 | G2: D12 FNCTN |
| Digital Input control signal level 1 | G3: D11 DET LEV |
| Digital Input control signal level 2 | G4: D12 DET LEV |





Switch operation	Display example	Description
MENU/ENT 	F1: D01 FNCTN 1:HIGH ALM	Select F1: DO1 FNCTN from the setting item selection menu. The currently set function of Digital Output 1 appears.
CANCEL 	F1: D01 FNCTN	Returns to the menu of setting item selection.

● Changing each setting for digital I/O

The following is an example to show how to change the function of Digital Output 1 from High limit alarm output (2:HIGH ALM) to Fluid empty alarm (A:EMPTY ALM).

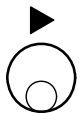
To change other setting values, select the following function numbers.

- | | |
|--------------------------------------|-----------------|
| Digital Output 1 | F1: D01 FNCTN |
| Digital Output 2 | F2: D02 FNCTN |
| Digital Output 3 | F3: D03 FNCTN |
| Digital Output 4 | F4: D04 FNCTN |
| Digital Output alarm status 1 | F5: D01 ALM STS |
| Digital Output alarm status 2 | F6: D02 ALM STS |
| Digital Output alarm status 3 | F7: D03 ALM STS |
| Digital Output alarm status 4 | F8: D04 ALM STS |
| Digital Input 1 | G1: D11 FNCTN |
| Digital Input 2 | G2: D12 FNCTN |
| Digital Input control signal level 1 | G3: D11 DET LEV |
| Digital Input control signal level 2 | G4: D12 DET LEV |

Switch operation	Display example	Description
MENU/ENT 	F1: D01 FNCTN 1:HIGH ALM	Select F1: DO1 FNCTN from the setting item selection menu. The currently set function of Digital Output 1 appears.
	F1: D01 FNCTN <u>1</u> :HIGH ALM	The cursor appears.
	F1: D01 FNCTN <u>A</u> :EMPTY ALM	Select the output function A:EMPTY ALM.
MENU/ENT 	F1: D01 FNCTN A:EMPTY ALM	The display blinks and the set value is displayed for confirmation. Press [MENU/ENT] again to write the data. Then the cursor disappears and the display returns to the condition that the setting value is displayed.
CANCEL 	<u>F</u> 1: D01 FNCTN	Returns to the menu of setting item selection.

8.2.15 Count Rate (Pulse Rate) and Pulse Width

Totalizer is incremented each time a volumetric flow set for predetermined count rate enters and one pulse is sent out through DO output.

It is necessary to set the count rate and pulse width when the total volumetric flow or count value indication is selected or when pulse output is used.

The following parameters can be set here:

- (1) Count rate (Pulse rate)
- (2) Pulse width mode
- (3) Pulse width

Notes

- To use the pulse output, it is necessary to set the DO function for output.
For how to set the DO function, see 8.2.14 “Digital I/O Function.”
If the pulse output is not used and only the total volumetric flow or count value indication is used, it is not necessary to set the DO function.
- To use the total volumetric flow indication or count value indication, it is necessary to set the indicating unit.
For how to set the indicating unit, see 8.2.6 “Normal Indicating Unit.”
Even if the pulse output only is used, it is recommended that you set a total volumetric flow unit or a count value unit as indicating unit to check the operation.

● **Count rate**

A volumetric value per 1 count (1 pulse) for the totalizer is set.
The total volumetric flow is the totalizer count multiplied by the count rate.

- The count rate must be set so that the pulse output at 100% output stays within a range of 3.6 to 3,600,000 pulses/h. If you try to set a value outside of this range, an error message *H. OVER SPEC* or *L. OVER SPEC* appears and the value returns to the previously set value. Try to set a new value again.

Example: When the range is 3,600m³/h (1m³/s), the settable count rate is as follows:
 Minimum value: 3,600m³/h ÷ 3,600,000 pulses/h = 0.001m³ = 1 l (liter)
 Maximum value: 3,600m³/h ÷ 3.6 pulses/h = 1,000m³

● **Pulse width mode**

Whether the pulse width of the totalizer pulse output should be set automatically or a specified pulse width is set can be selected.

Selection	Pulse width setting
1:AUTO	Pulse width automatic setting Automatically set to the settable maximum pulse width according to the set count rate.
2:MANUAL	Pulse width manual setting Pulse width set by pulse width setting

Note: If the total volumetric flow indication or count value indication is used, and the pulse output is not used, it is recommended that you select the pulse width automatic setting.

● Pulse width

The pulse width for totalizer pulse output is set.

If Automatic setting (1:AUTO) is selected for pulse width mode, it is not necessary to set the pulse width.

- The pulse width must be set to a value within the range of 0.3ms to 500ms. If you try to set a value exceeding 500 ms, the value will be forcibly changed to 500ms.
- The pulse width must be set to 40% or less of the pulse period at 100% output. If a value exceeding this limit is tried to set, regardless of the range described above, an error message * H. OVER SPEC appears and the value returns to the previously set value. Try to set a new value again. If the pulse width is set to 0, it will be automatically set to 40% of the pulse period at 100% output. However, if the calculation result exceeds 100ms, it will be forcibly set to 100ms.

Example 1 In the case of the following:

Range: 3,600m³/h (1m³/s)

Count rate: 0.001m³

Since the count rate is $3,600 \text{ m}^3/\text{h} \div 0.001(\text{m}^3) = 3,600,000 \text{ pulses/h}$ (1000 pulses/s), the full-scale period is $1\text{s} \div 1000 = 1\text{ms}$.

Therefore, the pulse width can only be set to $1\text{ms} \times 0.4 = 0.4\text{ms}$.

Example 2 In the case of the following:

Range: 3,600m³/h (1m³/s)

Count rate: 1000m³

Since the pulse count is $3,600\text{m}^3/\text{h} \div 1000\text{m}^3 = 3.6 \text{ pulses/h}$ (0.001 pulse/s), the full-scale period is $1\text{s} \div 0.001 = 1000\text{s}$.

Therefore, the pulse width becomes $1000\text{s} \times 0.4 = 400\text{s}$. However, since the maximum value is 500ms, the pulse width becomes 500ms.

Example 3 In the case of the following:

Range: 3,600m³/h (1m³/s)

Count rate: 1m³

Pulse width is set to 0ms

Since the pulse count is $3,600\text{m}^3/\text{h} \div 1\text{m}^3 = 3600 \text{ pulses/h}$ (1 pulse/s), the full-scale period is $1\text{s} \div 1 = 1\text{s}$.



Therefore, the pulse width becomes $1\text{s} \times 0.4 = 400\text{ms}$. However, in the case of automatic setting, since the maximum value is 100ms, the pulse width becomes 100ms.

● **Checking the count rate and pulse width**

How to check the count rate setting is shown below.









To check other setting values, select the following function numbers:

Pulse width mode H2: PLS MODE
 Pulse width H3: PLS WIDTH

Switch operation	Display example	Description
MENU/ENT 	H1: COUNT RATE 1.00000 m3	Select H1: COUNT RATE from the setting item selection menu. The currently set count rate appears.
CANCEL 	<u>H</u> 1: COUNT RATE	Returns to the menu of setting item selection.

● **Changing the count rate**

The following is an example to change the count rate from 0.01m³ to 200 l (liter).





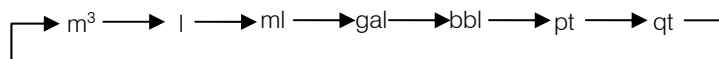

Switch operation	Display example	Description
MENU/ENT 	H1: COUNT RATE 1.00000 m3	Select H1: COUNT RATE from the setting item selection menu. The currently set count rate appears.
	H1: COUNT RATE 1.00000 <u>m</u> 3	The cursor appears. Press  further to move the cursor to the digit of unit.
	H1: COUNT RATE 1000.00 l ↓ 200.000 l	Change the unit to l. Then press  to move the cursor to the desired digit to change and change the number there. Repeat this operation until 200 l appears on the display.
MENU/ENT 	H1: COUNT RATE 200.000 l	The display blinks and the set value is displayed for confirmation. Press  again to write the data. Then the cursor disappears and the display returns to the condition that the set value is displayed.
CANCEL 	<u>H</u> 1: COUNT RATE	Returns to the menu of setting item selection.

Note: The indicating units for count rate are displayed cyclically as shown below.











● Changing the pulse width mode setting

The following is an example to change the pulse width mode setting from 2:MANUAL to 1:AUTO.

Switch operation	Display example	Description
<p>MENU/ENT</p> 	<p>H2: PLS MODE 2:MANUAL</p>	<p>Select H2: PLS MODE from the setting item selection menu. The currently set pulse width mode setting appears.</p>
	<p>H2: PLS MODE <u>2</u>:MANUAL</p>	<p>The cursor appears.</p>
	<p>H2: PLS MODE <u>1</u>:AUTO</p>	<p>Press  to select 1:AUTO.</p>
<p>MENU/ENT</p> 	<p>H2: PLS MODE <u>1</u>:AUTO</p>	<p>The display blinks and the set value is displayed for confirmation. Press  again to write the data. Then the cursor disappears and the display returns to the condition that the set value is displayed.</p>
<p>CANCEL</p> 	<p><u>H</u>2: PLS MODE</p>	<p>Returns to the menu of setting item selection.</p>

● Changing the pulse width

The following is an example to change the pulse width from 100ms to 250ms.

Switch operation	Display example	Description
MENU/ENT 	H3: PLS WIDTH 100.0 ms	Select H3: PLS WIDTH from the setting item selection menu. The currently set pulse width appears.
	H3: PLS WIDTH <u>1</u> 00.0 ms	The cursor appears. Press  further to move the cursor to the desired digit to change.
	H3: PLS WIDTH 200.0 ms ↓ 2 <u>5</u> 0.0 ms	Change the number of the digit. To change other digit, press  under this condition to move the cursor to that digit and change the number there.
MENU/ENT 	H3: PLS WIDTH 250.0 ms	The display blinks and the set value is displayed for confirmation. Press  again to write the data. Then the cursor disappears and the display returns to the condition that the set value is displayed.
CANCEL 	H3: PLS WIDTH	Returns to the menu of setting item selection.

Note: If you try to set a value exceeding the settable range, *H. OVER SPEC. appears and the value returns to the previously set value. Try to set a new value again.

8.2.16 Preset Counter

Preset counter is the function to output a signal through DO when the totalized count reaches a preset value.

For details of preset counter function, also see 10. “Function Description.”

The following parameters can be set here:

- (1) Preset count value
- (2) Preset output function

Notes

- Preset counter works only for forward direction flow count.
- To use the preset counter, it is necessary to set the DO function for output. For how to set the DO function, see 8.2.14 “Digital I/O Function.”
- To use the preset counter, it is recommended that you set a total volumetric flow unit or a count value unit as indicating unit to check the operating condition. For how to set the indicating unit, see 8.2.6 “Normal Indicating Unit.”

● Preset count value

Preset value for preset counter is set.
 Preset count value can be set within the range of 0 to 99999999.

● Preset output function

The operation of DO output when the preset counter reaches the preset value can be selected. You can select the operation of DO output from the items shown in the table below:



PRESET FUNCT.	Preset output function
1: HOLD	Output level is held
2: 50ms PULSE	One-shot pulse output of 50ms pulse width
3: 500ms PULSE	One-shot pulse output of 500ms pulse width

Note: If the preset output function is set to “50ms PULSE” or “500ms PULSE,” select the preset count value to become 1, 2, 5, 25 or 125×10^n . (If a value not satisfying this condition is set, the preset output timing may be shifted when the totalizer overflows.)

● **Checking the preset counter setting**







How to check the preset count value is shown below.

To check the preset output function, select the function “I2: PRESET FNC.”

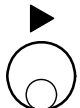
Switch operation	Display example	Description
MENU/ENT 	I1: PRESET CNT 00000300	Select H1:PRESET from the setting item select menu. The currently set preset count value appears.
CANCEL 	<u>I</u> 1: PRESET CNT	Returns to the menu of preset item selection.







● **Changing the preset count value**

The following is an example to show how to change the preset value from 500 (count) to 1000 (count)

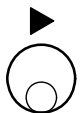
Switch operation	Display example	Description
MENU/ENT 	I1: PRESET 00000500	Select I1:PRESET from the setting item selection menu. The currently set preset count value (500 counts in this example) appears.
	I1: PRESET <u>0</u> 0000500	The cursor appears. Press  further to move the cursor to the desire digit to change.
	I1: PRESET 0000 <u>1</u> 500 00001 <u>0</u> 00	Change the number of the digit. To change other digit, press  under this condition to move the cursor to that digit and change the number there
MENU/ENT 	I1: PRESET 00001000	The display blinks and the set value is displayed for confirmation Press  again to write the data. Then the cursor disappears and the display returns to the condition the setting value is displayed.
CANCEL 	<u>I</u> 1: PRESET	Returns to the menu of setting item selection.

● Changing the preset output function

The following is an example to show how to change the preset output function from Output state hold (1/HOLD) to One-shot pulse output (2:50ms PULSE).

Switch operation	Display example	Description
MENU/ENT 	I2: PRESET FNC 1:HOLD	Select I2:PRESET FNC from the setting item selection menu. The currently set preset count output function (HOLD in this example) appears.
	I2: PRESET FNC <u>1</u> :HOLD	The cursor appears.
	I2: PRESET FNC <u>2</u> :50ms PULSE	Press  to select the setting code 1:50ms PULSE.
MENU/ENT 	I2: PRESET FNC 2:50ms PULSE	The display blinks and the set value is displayed for confirmation Press  again to write the data. Then the cursor disappears and the display returns to the condition that the setting value is displayed.
CANCEL 	<u>I</u> 2: PRESET FNC	Returns to the menu of setting item selection.

8.2.17 Flow Rate High/Low limit Alarm

The flow rate high/low limit alarm is the function to generate an alarm when the instantaneous flow rate exceeds a preset high limit value (or low limit value).

When an alarm is generated, an alarm message is displayed and a signal can be output through DO. Two outputs are provided each for high limit value and low limit value (4 outputs in total of high limit, high-high limit, low limit and low-low limit) and an alarm output can be sent out separately.

The following parameters can be set here:

- (1) High limit alarm On/Off
- (2) High limit value
- (3) Low limit alarm On/Off
- (4) Low limit value
- (5) High-high limit alarm On/Off
- (6) High-high limit value
- (7) Low-low limit alarm value On/Off
- (8) Low-low limit value

Note

- To output a high/low limit alarm through DO, it is necessary to set the DO function for output. For how to set the DO function, see 8.2.14 “Digital I/O Function.”

● **High/low limit alarm On/Off**

Whether the high/low limit alarm is used or not can be selected

Selection	Alarm operation
1: ON	Alarm function provided If the flow rate exceeds a selected high limit value (or low limit value), an alarm is generated.
2: OFF	Alarm function not provided The selected alarm will not be generated.

● **High/low limit value**

A flow rate value (high/low limit value) to generate an alarm is set in percent of the maximum range (Range 1) flow rate value.

The high/low limit alarm value can be set within the range of -10% to 110% in increments of 0.5%.



● **Checking the high/low limit alarm setting**

Proceed as follows to check the high/low limit alarm setting.

The following is how to check whether the high limit alarm is provided (On) or not (Off).

To check other setting values, select the following function numbers:





High limit value	J2: H ALM VAL
Low limit alarm On/Off	J3: L ALM SET
Low limit value	J4: L ALM VAL
High-high limit alarm On/Off	K1: HH ALM SET
High-high limit alarm	K2: HH ALM VAL
Low-low limit alarm On/Off	K3: LL ALM SET
Low-low limit value	K4: LL ALM VAL

Switch operation	Display example	Description
MENU/ENT 	J1: H ALM SET 1:ON	Select J1: H ALM SET from the setting item selection menu. The currently set high limit alarm On/Off setting appears.
CANCEL 	<u>J</u> 1: H ALM SET	Returns to the menu of setting item selection.

● Changing the high/low limit alarm On/Off

The following is an example to change the high limit alarm setting from OFF to ON.
 To change other high/low limit alarm On/Off setting, select the following functions.

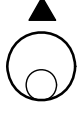





- | | |
|------------------------------|----------------|
| High limit alarm On/Off | J1: H ALM SET |
| Low limit alarm On/Off | J3: L ALM SET |
| High-high limit alarm On/Off | K1: HH ALM SET |
| Low-low limit alarm On/Off | K3: LL ALM SET |

Switch operation	Display example	Description
MENU/ENT 	J1: H ALM SET 2:OFF	Select J1: H ALM SET from the setting item selection menu. The currently set On/Off setting for high limit alarm appears.
	J1: H ALM SET <u>2</u> :OFF	The cursor appears.
	J1: H ALM SET <u>1</u> :ON	Change the setting.
MENU/ENT 	J1: H ALM SET 1:ON	The display blinks and the set value is displayed for confirmation. Press MENU/ENT again to write the data. Then the cursor disappears and the display returns to the condition that the setting value is displayed.
CANCEL 	J1: H ALM SET	Returns to the menu of setting item selection

● **Changing the high/low limit value**

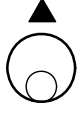
The following is an example to change the high limit value from +105% to +103%.
 To change other high/low limit value setting, select the following functions.

Low limit value	J4: L ALM SET
High-high limit value	K2: HH ALM SET
Low-low limit value	K4: LL ALM SET

Switch operation	Display example	Description
MENU/ENT 	J2: H ALM VAL +105.0%	Select J2: H ALM VAL from the setting item selection menu. The currently set high limit alarm value appears.
	J2: H ALM VAL +105.0%	The cursor appears. Press  further to move the cursor to the digit to change.
	J2: H ALM VAL +103.0%	Change the number of the digit. To change other digit, press  under this condition to move the cursor to that digit and change the number there.
MENU/ENT 	J2: H ALM VAL +103.0%	The display blinks and the set value is displayed for conformation Press  again to write the data. Then the cursor disappears and the display returns to the condition that the setting value is displayed.
CANCEL 	<u>J</u> 2: H ALM VAL	Returns to the menu of setting item selection.

Note: If a value of 10% or less, or a value of 110% or more is tried to set, *L. Over SPEC. or *H. OVER SPEC. appears and the value returns to the previously set value.
 Try to set a new value again.

8.2.18 Fluid Empty Alarm

Fluid empty alarm is the function to generate an alarm when a condition is detected in which fluid is not filled or water level is not enough in the measuring pipe of the flowmeter.

If an alarm is generated, an alarm message is displayed and a signal can be output through DO.

Note

- To output a fluid empty alarm through DO, it is necessary to set the DO function for output. For how to set the DO function, see 8.2.14 “Digital I/O Function.”
- In the case of LF232*F; Fluid empty alarm function is not usable. Set this function 'OFF'.

● Setting the fluid empty alarm



Whether the fluid empty alarm should be used or not, and its detection sensitivity can be selected.

EMPTY	Fluid empty alarm setting	
1: OFF	Fluid empty alarm not used Fluid empty condition is not detected.	
2: NORMAL	Fluid empty alarm used If a fluid empty condition is detected, an alarm will be output.	Sensitivity: Standard Detection sensitivity is set to the standard level.
3: SENSITIVE		Sensitivity: High Detection sensitivity is set to high sensitivity level.
4: SENSITIVE-H		Sensitivity: Higher Detection sensitivity is set to higher sensitivity level.

* To use the fluid empty alarm, normally select 2:NORMAL (standard detection sensitivity). Select 3:SENSITIVE or 4:SENSITIVE-H only when the fluid empty alarm is difficult to detect due to the condition of the fluid to be measured or its piping condition.







● Checking the fluid empty alarm On/Off setting

Proceed as follows to check whether the fluid empty alarm is used (On) or not (Off).

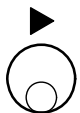
Switch operation	Display example	Description
MENU/ENT 	L1: EMPTY ALM 1: NORMAL	Select L1:EMPTY ALM from the setting item selection menu. The currently set fluid empty alarm On/Off setting appears.
CANCEL 	<u>L</u> 1: EMPTY ALM	Returns to the menu of setting item selection.

● Changing the fluid empty alarm On/Off setting.

The following is an example to change the fluid empty alarm setting from Alarm On (1:NORMAL) to Alarm Off (0:OFF).

Switch operation	Display example	Description
MENU/ENT 	L1: EMPTY ALM 1:NORMAL	Select L1:EMPTY ALM from the setting item selection menu. Then the fluid empty alarm On/Off setting appears.
	L1: EMPTY ALM <u>1</u> :NORMAL	The cursor appears.
	L1: EMPTY ALM <u>2</u> :OFF	Press  to select the fluid empty alarm Off
MENU/ENT 	L1: EMPTY ALM 2:OFF	The display blinks and the set value is displayed for confirmation. Press  again to write the data. Then the cursor disappears and the display returns to the condition that the setting value is displayed.
CANCEL 	<u>L</u> 1: EMPTY ALM	Returns to the menu of setting item selection.

8.2.19 Self-Diagnosis Function

Self-diagnosis function is the function to generate an alarm if an error is found from the result of diagnosis of internal circuits, memory, etc.

If an alarm is generated, an alarm message is displayed and a signal can be output through DO.

The following parameters can be set here:

- (1) Self-diagnosis alarm On/Off
- (2) DO alarm output factor setting

NOTE

- To output a self-diagnosis alarm through DO, it is necessary to set the DO function for output. For how to set the DO function, see 8.2.14 “Digital I/O Function.”

● Self-diagnosis function On/Off setting

Whether or not to use the self-diagnosis function can be selected.

Selection	Self-diagnosis alarm is used or not
1: ON	Self-diagnosis function is used An alarm is generated if an error is detected.
2: OFF	Self-diagnosis function is not used Self-diagnosis will not be carried out.

● Alarm output factor setting

When the diagnosis alarm is output through DO, whether a fluid empty alarm should be added to the condition for alarm output can be selected.

Selection	Diagnosis error alarm factor
1: WITHOUT EMP	Fluid empty alarm is not included
2: WITH EMP	Fluid empty alarm is included

List of alarm output factors

Diagnosis error items to output as a diagnosis alarm through DO are shown below.

Diagnosis error item	Diagnosis alarm output (DO)	
	WITHOUT EMP	WITH EMP
RAM error	○	○
ROM error	○	○
Exciting current value error	○	○
Exciting circuit wire broken	○	○
ADC error (flow measurement circuit error)	○	○
Parameter error	○	○
Fluid empty alarm	—	○

○: Diagnosis alarm is output through DO when an error is detected.



—: Diagnosis alarm is not output through DO even if an error is detected.
(However, an error message is displayed)

● Checking the self-diagnosis alarm setting

Proceed as follows to check the self-diagnosis function setting.

The following is how to check whether the self-diagnosis alarm is used (On) or not (Off).







To check the alarm output factors, select the function “L3: ALM PRESET.”

Switch operation	Display example	Description
MENU/ENT 	L2: SELF CHECK 1:ON	Select <u>L</u> 2: SELF CHECK from the setting item selection menu. Whether the self-diagnosis alarm is used (On) or not (Off) appears.
CANCEL 	<u>L</u> 2: SELF CHECK	Returns to the menu of setting item selection.

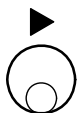
● **Changing the self-diagnosis function setting**

The following is an example to change the self-diagnosis function from Self-diagnosis function On (1:ON) to Self-diagnosis function Off (2:OFF).

To change the setting for alarm output factors, select the function “L3: ALM PRESET.”

Switch operation	Display example	Description
MENU/ENT 	L2: SELF CHECK 1:ON	Select L2: SELF CHEK from the setting item selection menu. Whether the self-diagnosis function is used (On) or not (Off) appears.
	L2: SELF CHECK <u>1</u> :ON	The cursor appears.
	L2: SELF CHECK <u>2</u> :OFF	Press  to set the self-diagnosis function to OFF.
MENU/ENT 	L2: SELF CHECK 2:OFF	The display blinks and the set value is displayed for confirmation. Press  again to write the data. Then the cursor disappears and the display returns to the condition that the setting value is displayed.
CANCEL 	<u>L</u> 2: SELF CHECK	Returns to the menu of setting item selection.

8.2.20 Rate-of-Change Limit Value and Control Time

The rate-of-change limit is the function to prevent a sudden change in flow indication of the converter when the measurement flow signal contains excessive noise.

Damping constant is also effective to prevent indication variations by increasing its value but the rate of change limit control is effective against a sudden change in flow indication that the damping constant cannot eliminate.

The following parameters can be set here:

- (1) Rate-of-change limit value
- (2) Rate-of-change control time

Note: To use the rate-of-change limit function, it is necessary to set both (1) and (2).

If either one is set to zero (factory setting value), this function does not work

When not using the rate-of-change limit function, set zero to either one of these items.

● Rate-of-change limit value

Indication change is controlled within the limit value* against variations of measurement flow signals.

* Indication variation per approx. 40ms will be controlled to within the limit value (in percent of span).

The rate-of-change limit value can be set within the range of 0 to 30% in increments of 0.1%.

In the case of multi-range setting, the value is indicated in percent of the range in operation.

If 0 is set, the rate-of-change limit function does not work.

● Rate-of-change control time

If the time used to control the indication against variations of measurement flow signal exceeds the control time, the rate-of-change control will be turned off. (Flow indication will be output directly without the rate-of-change limit function.)

Control time can be set within the range of 0 to 20s in increments of 1s.



If 0 is set, the rate-of-change limit function does not work.

● Checking the rate-of-change limit setting

Proceed as follows to check the rate-of-change limit setting.









How to check the limit value is shown below.

To check the control time, select the function “M2: LIMIT TIME.”

Switch operation	Display example	Description
MENU/ENT 	M1: LIMIT RATE 05.0 %	Select M1: LIMIT RATE from the setting item selection menu. The currently set rate-of-change limit value appears.
CANCEL 	M1: LIMIT RATE	Returns to the menu of setting item selection.

● Changing the rate-of-change limit setting

The following is an example to change the limit value from 1.0% to 1.5%.
To change the control time, select the function “M2: LIMIT TIME.”

Switch operation	Display example	Description
MENU/ENT 	M1: LIMIT RATE 1.0 %	Select M1: LIMIT RATE from the setting item selection menu. The currently set rate-of change limit value appears.
	M1: LIMIT RATE <u>1</u> .0%	The cursor appears. Press  further to move the cursor to the desired digit to change.
	M1: LIMIT RATE 1. <u>5</u> %	Change the number of the digit. To change other digit, press  under this condition to move the cursor to that digit and change the number there.
MENU/ENT 	M1: LIMIT RATE 1.5 %	The display blinks and the set value is displayed for confirmation. Press  again to write the data. Then the cursor disappears and the display returns to the condition that the setting value is displayed.
CANCEL 	<u>M1</u> : LIMIT RATE	Returns to the menu of setting item selection.

Note: If a value outside of the settable range is tried to set, *H. OVER SPEC. appears and the value returns to the previously set value. Try to set a new value again.

8.3 Initial Settings When Shipped from the Factory

Initial settings used when shipped from the factory unless otherwise specified are shown below.

No.	Parameter name	Initial setting values		
A1	Exciting current	Adjusted value when shipped from the factory (described on the detector nameplate)		
A2	Meter size	Specified meter size when ordered (described in the Test Record)		
A3	Exciting frequency	Recommended value for the detector combined (See 8.2.3 "Exciting Frequency.")		
A4	Flow direction	NORMAL		
A5	Password	000		
B1	Indicating unit setting (main unit)	m ³ /h (If any range is specified, the same unit as that of the range)		
B2	Indicating unit setting (sub display)	% (If count rate is specified, the same unit as that of the count rate)		
B3	Custom coefficient	0		
B4	Custom unit	" " (7 blank spaces)		
C1	Range type	Range type specified when ordered (If multi-range is not specified, Single range is set)		
C2 to 4	Ranges 1 to 4	Values specified when ordered (described in the Test Record. If not specified, Range 1 is the Toshiba standard range and Ranges 2 to 4 are zeros)		
C5	Hysteresis	3.0 %		
D1	Damping factor	Meter size 16" (400mm) or less	Range of 1m/s or more	1.0s
			Range of less than 1m/s	3.0s
		Meter size 20" (500mm) or more		
		For partially filled pipes detectors		10s
D2	Low cutoff value	1.0 %		
D3	Output when an alarm occurs	4mA output		
D4	Display low cut	OFF		
		For partially filled pipes detectors: ON		
D5	Output low limit setting	4mA		
F1	Digital Output 1	PULSE OUT (Pulse Output)		
F2 to 4	Digital Outputs 2 to 4	NO USE (Not used)		
F5 to 8	Digital Output 1 to 4 states	NORMAL OPEN		
G1 to 2	Digital Inputs 1 to 2	NO USE (Not used)		
G3 to 4	Digital inputs 1 to 2 detection levels	H LEVEL		

No.	Parameter name	Initial setting values	
H1	Count rate	Meter size 1/10" to 1/4" (2.5 to 6 mm)	1L
		Meter size 1/2" to 1 1/2" (15 to 40 mm)	0.01m ³
		Meter size 2" to 4" (50 to 100mm)	0.1m ³
		Meter size 6" to 24" (150 to 600mm)	1m ³
		Meter size 28" to 120" (700 to 3000mm)	10m ³
H2	Pulse width setting mode	AUTO	
H3	Pulse width	100 ms	
I1	Preset count value	00000000	
I2	Preset output function	HOLD	
J1	High limit alarm setting	OFF	
J2	High limit alarm value	0.0 %	
J3	Low limit alarm setting	OFF	
J4	Low limit alarm value	0.0 %	
K1	High-high limit alarm setting	OFF	
K2	High-high limit alarm value	0.0 %	
K3	Low-low limit alarm setting	OFF	
K4	Low-low limit alarm value	0.0 %	
L1	Fluid empty alarm	ON Detection level: NORMAL (In the case of LF232*F; OFF)	
L2	Self-diagnosis function	ON	
L3	Alarm output factor setting	WITHOUT EMP (fluid empty alarm not included)	
M1	Rate-of-change limit	0.0 %	
		For partially filled pipes detectors: 10 %	
M2	Control time	0 s	
		For partially filled pipes detectors: 10 s	
N1	Fixed value output function	OFF	
O1	Zero offset	0.0 %	

8.4 Fixed Value Output (Loop Check)

The fixed value output is the function to output a fixed current and/or a fixed pulse output independently of the flow rate signal.

The following parameters can be set here:

- (1) Fixed value output On/Off setting
- (2) Fixed current output value
- (3) Fixed pulse output value

Notes

- Fixed pulse output can be sent out only when DO1 or DO2 is set for pulse output.
- When the mode is switched to the fixed output mode by DI function, the preset values of items (2) and (3) above will be output.
- In the fixed output mode, the condition of DO output (other than pulse output) will be maintained.

● Fixed value output On/Off setting

Fixed output mode can be selected by the setting as follows.

Selection	Mode
1: ON	Fixed value output mode On Current output and pulse output become fixed output values.
2: OFF	Fixed value output mode Off Fixed output mode will be turned off and the mode goes to the normal measurement mode.

When the fixed value output is set to ON, the main indicating unit only is displayed and the current output set value is displayed in the lower line in the measurement mode.

Display example:

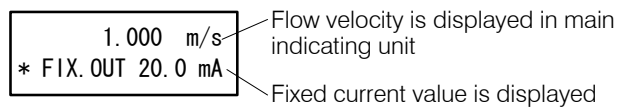

Note: When power is turned off and on again, the fixed output On/Off setting will be turned off.

● Fixed current output value

The current value used in the fixed output mode is set.

Fixed current output value can be set in the range of 3 to 24mA in increments of 0.1mA.

● **Fixed pulse output value**

The pulse frequency is set, which is used to output in the fixed output mode through the DO terminal where the pulse output function is set.

The fixed pulse output value can be set within the range of 0 to 1000pps in increments of 1pps.

Note: When the pulse output is sent out from DO2 terminal, up to 100pps can be output.



● **Checking the fixed output function setting**

Proceed as follows to check the fixed output function.

How to check the fixed value out On/Off setting is shown here.

To check other settings, select the following functions:

Fixed current output value	N2: FIX CURR
Fixed pulse output value	N3: FIX PULSE

Switch operation	Display example	Description
MENU/ENT 	N1: FIXED OUT 1:ON	Select N1: FIXED OUT from the setting item selection menu. The currently set fixed value output On/Off setting appears.
CANCEL 	<u>N</u> 1: FIXED OUT	Returns to the menu of setting item selection.

● **Changing the fixed output function**









The following is an example to change the fixed output function from Fixed value output OFF to ON and then go on to set the current output value and the pulse output value. To change the current output value or pulse output value independently, select the following function:

Fixed current output value

N2: FIX CURR

Fixed pulse output value









N3: FIX PULSE

Switch operation	Display example	Description
MENU/ENT 	N1: FIXED OUT 2: OFF	Select N1: FIXED OUT from the setting item selection menu. The currently set fixed value output On/Off setting appears.
	N1: FIXED OUT <u>2</u> : OFF	The cursor appears.
	N1: FIXED OUT <u>1</u> : ON	Select the fixed value output: ON.
MENU/ENT 	N2: FIX. CURR. <u>10</u> . 0 mA	The display blinks and the set value is displayed for conformation. Press [MENU/ENT] again to write the data. The cursor disappears and then the current output set value can be changed.
	N2: FIX. CURR. <u>10</u> . 0 mA	Move the cursor to the desired digit to change.
	N2: FIX. CURR. <u>20</u> . 0 mA	Change the number of the digit. To change other digit, press [▶] under this condition to move the cursor to the desired digit and change the number there.
MENU/ENT 	N3: FIX. PULSE <u>100</u> PPS	The display blinks and the set value is displayed for conformation. Press [MENU/ENT] again to write the data. The cursor disappears and then the pulse output set value can be changed.
MENU/ENT 	N3: FIX. PULSE 100 PPS	The display blinks and the set value is displayed for conformation. Press [MENU/ENT] again to write the data. Then the cursor disappears and the display returns to the condition that the setting value is displayed.
CANCEL 	<u>N3</u> : FIX. PULSE	Returns to the menu of setting item selection.

Note. If a value outside of the settable range is tried to set, the upper limit or lower limit value of the settable range will be forcibly set.

● Changing the fixed output constant

The following is an example to change the fixed pulse output value from 50pps to 100pps. To change the fixed current output value, select the function “L2: FIX. CURR.”







Switch operation	Display example	Description
MENU/ENT 	L3: FIX. PULSE 0050 pps	Select L3: FIX. PULSE from the setting item selection menu. The currently set fixed pulse output value appears.
	L3: FIX. PULSE 0 <u>0</u> 50 pps	The cursor appears. Press  further to move the cursor to the desired digit to change.
	L3: FIX. PULSE 0 <u>1</u> 50 pps ↓ 01 <u>0</u> 0 pps	Change the number of the digit. To change other digit, press  under this condition to move the cursor to that digit and change the number there.
MENU/ENT 	L3: FIX. PULSE 0100 pps	The display blinks and the set value is displayed for confirmation. Press  again to write the data. Then the cursor disappears and the display returns to the condition that the setting value is displayed.
CANCEL 	<u>L</u> 3: FIX. PULSE	Returns to the menu of setting item selection.

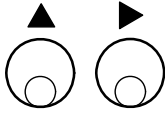

Note: If you try to set a value outside of the settable range, the value will be forcibly set to the upper limit or the lower limit of the settable range.

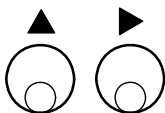
8.5 Zero Adjustment

8.5.1 Still Water Zero Adjustment

Still water zero adjustment must be performed when the fluid in the measuring pipe of the detector stays still.

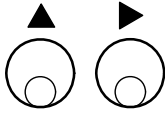
	Switch operation	Display example	Description
	—	10.00 m/s 100.0 %	Measured value being displayed (measurement mode)
Note2	MENU/ENT 	ENTER111 000	Pressing MENU/ENT in the measurement mode for 3 seconds or more, the screen moves to the menu lock cancellation screen. * Pressing CANCEL in the mode selection screen, the mode returns to the measurement mode.
Note2		ENTER111 111	Set the menu lock cancellation cord [111] by pressing ▲ and ▶ . * Pressing CANCEL in the mode selection screen, the mode returns to the measurement mode.
	MENU/ENT 	>1:SET 2: CNT CTRL	Press MENU/ENT for 3 seconds or more in the measurement mode and then the mode changes to the mode selection screen.
	MENU/ENT 	A1:EX CURRENT	Select 1:SET in the mode selection screen and then the menu screen appears.
		E1: ZERO ADJUST	Press ▲ and ▶ so that the function number becomes E1: ZERO ADJUST.
	MENU/ENT 	E1: ZERO ADJUST 01.0%	The current flow rate measured value in % unit appears. (Check that the fluid to be measured stays still.)
		ADJUST READY 01.0%	ADJUST READY appears and the system is ready for adjustment. (If “CANCEL” is pressed, Adjustment ready condition will be cancelled.)
	MENU/ENT 	E1: ZERO ADJUST * ZERO ADJUST	About 3 to 6 seconds later, the still water zero adjustment ends and the measured flow value after adjustment appears.
	—	E1: ZERO ADJUST 00.0%	Returns to the menu of setting item selection.
	CANCEL 	E1: ZERO ADJUST	Press ▲ and ▶ so that the number digit of the function number becomes 0.

	<p>E0: MEAS MODE</p>	<p>Returns to the measurement mode (measured value display screen).</p>
<p>MENU/ENT</p> 	<p>10.00 m/s 100.0 %</p>	<p>Note1: If the flow rate value is outside of the range of ± 1.25 m/s, the adjustment result will not be reflected on the flow rate measured value.</p>

Note1: If the flow rate value is outside of the range of ± 1.25 m/s, the adjustment result will not be reflected on the flow rate measured value.

Note2: There is not this screen to the converter before serial No.072320999.

8.5.2 Zero Offset Adjustment

This function is used to perform zero adjustment simply by comparing the output of the flowmeter with other process value without stopping the process flow.

If zero adjustment can be performed with still water condition, it is not necessary to set this adjustment value.

● **How to calculate the zero offset value**

Zero offset is performed by setting the adjustment value.

The adjustment value can be obtained by the following equation:

$$\text{Adjustment value (\%)} = \{(\text{Actual flow rate}) - (\text{LF232 measured value})\}$$

* Calculate the value in percent of the setting range of Range 1.
(See the example below.)

(Example)

	Flow rate	Value in percent of the set span
Actual flow rate obtained from other process value	10.0 m ³ /min	50.0 %
LF232 measured value	10.5 m ³ /min	52.5 %
Zero offset adjustment value		-2.5 %



(If zero offset adjustment value is set to -2.5 %, the output of LF232 is shifted by -2.5% and 50.0 % output can be obtained.)

The zero offset adjustment value can be set within the range of ±0.410ft/s (0.125 m/s) (±1.25% of the maximum range 32.8ft/s (10 m/s))

Note: If you perform still water zero adjustment, zero offset adjustment value becomes zero.









● **Checking the zero offset adjustment value**

Proceed as follows to check the zero offset adjustment value.

Switch operation	Display example	Description
MENU/ENT 	01: MANUAL ZERO +002.5 %	Select 01: MANUAL ZERO from the setting item selection menu. The currently set zero offset adjustment value appears.
CANCEL 	01: MANUAL ZERO	Returns to the menu of setting item selection.

● Changing the zero offset adjustment value

Changing the zero offset adjustment value from +1.0% to -2.5%.

Switch operation	Display example	Description
<p>MENU/ENT</p> 	<p>01: MANUAL ZERO +001. 0%</p>	<p>Select 01: MANUAL ZERO from the setting item selection menu. The currently set zero offset adjustment value appears.</p>
	<p>01: MANUAL ZERO ±001. 0%</p>	<p>The cursor appears. Press  further to change the cursor to the desired digit to change.</p>
	<p>01: MANUAL ZERO -001. 0% ↓ -002. 5%</p>	<p>Change the number of the digit. To change other digit, press  under this condition to move the cursor to that digit and change the number there.</p>
<p>MENU/ENT</p> 	<p>01: MANUAL ZERO -002. 5%</p>	<p>The display blinks and the set value is displayed for confirmation. Press  again to write the data. Then the cursor disappears and the display returns to the condition that the setting value is displayed.</p>
<p>CANCEL</p> 	<p>01: MANUAL ZERO</p>	<p>Returns to the menu of setting item selection.</p>

Note: If you try to set a value outside of the settable range, an error message of *H. OVER SPEC or *L. OVER SPEC appears. Try to set a new value again.

9. Mag-Prover Calibration

9.1 Calibration Items

The calibration mode of the LF232 flowmeter converter is used to check or perform zero and span calibration of the converter and check the exciting current. To change the mode to the calibration mode, select the setting item in accordance with the procedure in 7.3.2 “Setting Mode Operation.”

The procedure on the following pages is used to check or perform zero and span calibration of the converter and check the exciting current.

However, these values are already checked and calibrated when shipped from the factory. Do not change these settings unless it is necessary to calibrate in the field, etc.



No.	Setting item	Display example	
9.2.1	0 % flow rate calibration	P1:FLOW CAL 0	0.0 %
9.2.2	50 % flow rate calibration	P2:FLOW CAL 50	50.0 %
9.2.3	100 % flow rate calibration	P3:FLOW CAL100	100.0 %
9.2.4	Checking the exciting current output value	P4:EX CURR DSP	0.2100 A

9.2 Converter Check / Calibration





9.2.1 0% Flow Rate Calibration (Zero Calibration)

Using Mag-Prover internal calibration circuit, 0% flow rate (hereafter called zero point) calibration can be performed.

● Checking the zero point

Switch operation	Display example	Description
MENU/ENT 	P1:FLOW CAL 0 0.0 %	Select P1:FLOW CAL 0 from the calibration item selection menu. Zero point using the simulation input appears.
CANCEL 	P1:FLOW CAL 0	Returns to the menu of calibration item selection.

● Calibrating the zero point

Switch operation	Display example	Description
MENU/ENT 	P1:FLOW CAL 0 0.1 %	Select P1:FLOW CAL 0 from the calibration item selection menu. Zero point using the simulation input appears.
	ADJUST READY 0.1 %	Press  . Then the display shown left appears and the system is ready for zero calibration. (Note 1)
MENU/ENT 	P1:FLOW CAL 0% * CAL. 0% ADJ.	The display shown left appears and zero calibration starts.
—	P1:FLOW CAL 0 0.0 %	About 3 to 6 seconds later (Note 2), the zero calibration ends and a new zero point appears.
CANCEL 	P1:FLOW CAL 0%	Returns to the menu of calibration item selection.

Note 1: To cancel the adjustment from the condition of ADJUST READY, press **CANCEL**. The display returns to the condition where zero point using the simulation input is displayed.

Note 2: Calibration time differs depending on the exciting frequency.

9.2.2 50% Flow Rate Calibration

50% flow rate value can be checked only.



● Checking the 50% flow rate value

Switch operation	Display example	Description
MENU/ENT 	P2:FLOW SIG 50 50.1 %	Select P2:FLOW SIG 50 from the calibration item selection menu. 50% flow rate value using the simulation input appears.





9.2.3 100% Flow Rate Calibration (Span Calibration)

Using the Mag-Prover internal calibration circuit, 100% flow rate value (hereafter called the span value) calibration can be performed.

● **Checking the span value**

Switch operation	Display example	Description
MENU/ENT 	P3:FLOW CAL100 100.1 %	Select P3:FLOW CAL 100 from the calibration item selection menu. Span value using the simulation input appears.
CANCEL 	P3:FLOW CAL100	Returns to the menu of calibration item selection.

● **Calibrating the span value**

Switch operation	Display example	Description
MENU/ENT 	P3:FLOW CAL100% 100.1 %	Select P3:FLOW CAL 100 from the calibration item selection menu. Span value using the simulation input appears.
	ADJUST READY 100.1 %	Press  . Then the display shown left appears and the system is ready for span calibration. (Note 1)
MENU/ENT 	P3:FLOW CAL100 * CAL. 100% ADJ.	The display shown left appears and the span calibration starts.
—	P3:FLOW SCAL100 100.0 %	About 3 to 6 seconds later (Note 2), the span calibration ends and a new span value appears.
CANCEL 	P3:FLOW CAL100	Returns to the menu of calibration item selection.



Note 1: To cancel the adjustment from the condition of ADJUST READY, press **CANCEL**. The display returns to the condition where 100% flow rate value using the simulation input is displayed.

Note 2: Calibration time differs depending on the exciting frequency.

9.2.4 Checking the Exciting Current Value

The monitor value of the exciting current can be checked.

● Checking the exciting current value

Switch operation	Display example	Description
MENU/ENT 	P4:EX CURR DSP 0.2100 A	Select P4:EX CURR DSP from the calibration item selection menu. Span value using the simulation input appears.
CANCEL 	P4:EX CURR DSP	Returns to the menu of calibration item selection.

* The exciting current value is adjusted when shipped from the factory. Contact your nearest Toshiba representative if any change is necessary.

10. Function Description

The LF232 flowmeter converter is equipped with 4 digital outputs and 2 digital inputs (1 digital output as standard), enabling you to use these as various functions such as pulse output and alarm outputs.

Digital I/O functions are described below.

Functions	Description
Flow totalization	Totalizes flow volume in volumetric unit. For totalized flow, a pulse output per each unit of flow volume can be sent out. The operation to start, stop and reset the totalizer and pulse output can be controlled with Digital Input.
Multiple ranges	Measuring ranges can be switched in accordance with flow rate. Measuring ranges can be switched automatically or by control using Digital Inputs.
Forward and reverse ranges	Forward and reverse direction flows can be measured. Forward and reverse ranges can be combined with multiple ranges.
Flow rate High/Low limit (High-high limit/Low-low limit) alarms	If the flow rate exceeds or lowers below the preset value, an alarm will be output. 2 high limit alarm outputs and 2 low limit alarm outputs, 4 alarm outputs in total, can be sent out.
Fluid empty alarm	If the fluid to be measured flows out from the measuring pipe of the detector, an alarm is output. (In the case of LF232*F, fluid empty alarm function is not usable.)
Preset counter	If the count of the totalizer exceeds the preset value, a signal is output.
Remote still water zero adjustment	Still water zero adjustment can be controlled using Digital Inputs.
Fixed value output (loop output)	Fixed value for current output and pulse output can be sent out to perform a loop check for output lines. The fixed value output mode can also be switched by control using Digital Inputs.
Converter error alarm	If an error is detected such as memory error or excitation circuit error, an alarm is output.

10.1 Digital I/O Specifications

The specifications of the digital I/O terminals of the LF232 converter are as follows:

● Digital Outputs:

(DO1)	Output type	Transistor open collector (standard)
	Number of outputs	1
	Capacity	30 VDC, 200 mA maximum
(DO2 to DO4)	Output type	Solid-state contact output (non polarity) (option)
	Number of outputs	3
	Capacity	150 VDC, 150 mA maximum 150 VAC (peak value), 100 mA maximum

● Digital Input (option):

(DI1, DI2)	Signal type	Voltage signal of 20 to 30 VDC
		<ul style="list-style-type: none"> • High input level: 20 to 30 VDC • Low input level: 2 VDC maximum
	Input resistance	Approx. 2.7 kΩ
	Number of inputs	2

- Each terminal can be set to select each function.
- Terminal “CO2” is the common terminal of DO2 to DO4 and “CI” is the common terminal of DI1 and DI2.
- Each terminal is isolated from internal circuit.
(Output terminals are not isolated between them.)
- In the case of the standard specification (without digital I/O specification), a solid-state contact, photo-coupler and resistor are not provided internally.

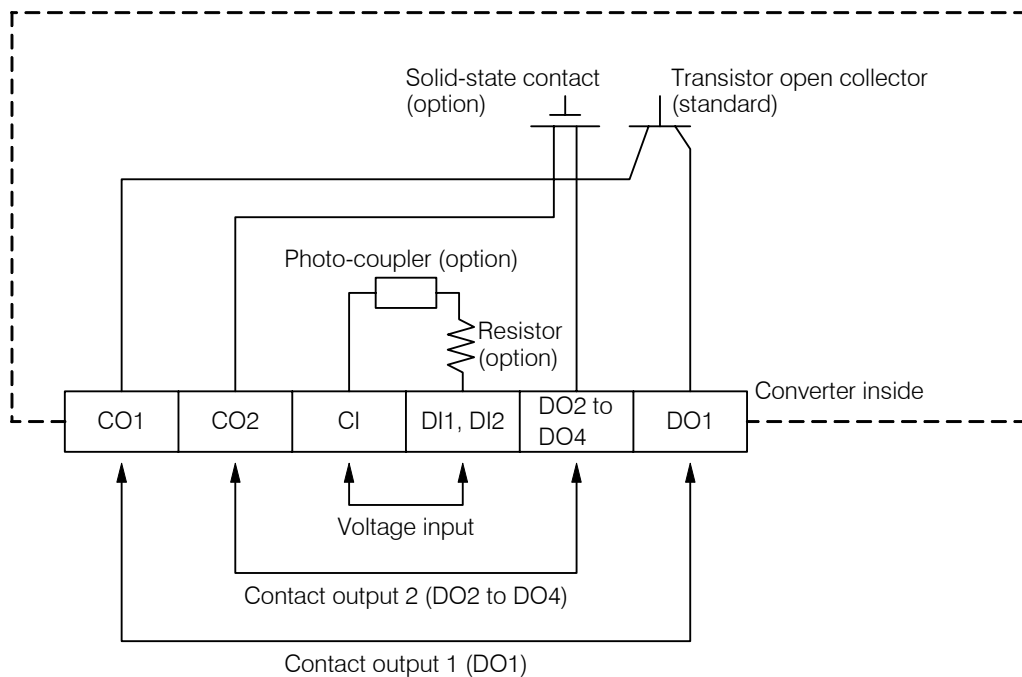

10.2 Totalizer and Pulse Output

Proceed as follows to use the totalizer and pulse output.

Count Rate and Pulse Width Settings

Follow the procedure in 8.2.15 “Count Rate (Pulse Rate) and Pulse Width” and set the flow rate per 1 count (1 pulse) (count rate), pulse width mode and pulse width.

* Count rate can be set within the range of 3.6 to 3,600,000 pulses/h (1/1000 to 1000 pulses/s) with respect to the set range. (Note 2)

* Pulse width will be set automatically if the pulse width mode is set to AUTO. If you want to set the pulse width manually, the pulse width can be set between 0.3ms and 500ms. However, the pulse width must be 40% or less of the full-scale period. (Note 3)

For pulse width, check the acceptable signal width of the receiving instruments when you set the pulse width.

If the pulse output is not used, pulse width setting is not needed.

DO Setting

Follow the procedure in 8.2.14 “Digital I/O Function” and set the Digital Output 1 (DO1) or Digital Output 2 (DO2) for pulse output.

If the pulse output is not used, DO setting is not needed.

DI Setting

Follow the procedure in 8.2.14 “Digital I/O Function” and set the Digital Input (DI) function.

In the case of the converter without Digital Input (9th digit of the product code is “1”), set “NO USE” (factory setting).

Indicating Unit Setting

Follow the procedure in 8.2.6 “Normal Indicating Unit” and set a totalization unit (m³, l, ml, gal, bbl, pt, qt or COUNT) for indicating unit.

If only the pulse output is used, pulse output can be sent out without setting an indicating unit but it is recommended that you set a totalization unit as indicating unit to check the operating condition.

Switching to the Measurement Mode

Follow the procedure in 7.3.1 “Mode Switching” and put the mode back to the measurement mode.

* To be continued to the next page.

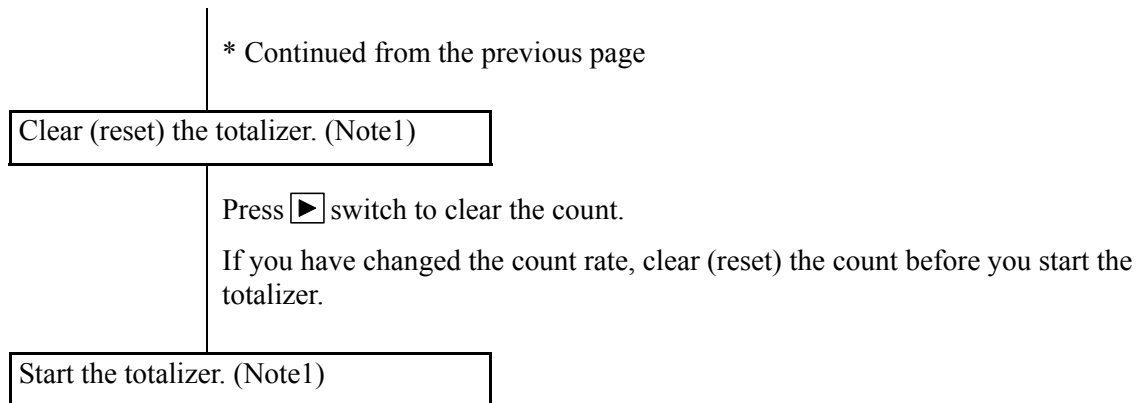

- Press  to start the totalizer.
Check that “C” is shown on the display indicating that counting is in progress.

Note 1: The LF232 converter has the function to start/stop the totalizing operation or clear the internal totalizer.

For details of how to operate the totalizer, see 7.3.4 “Totalizer Operation.”

Note 2: Example of count rate setting range

Count rate can be set in the range of minimum value (3,600,000 pulses/h) to maximum value (3.6 pulses/h) with respect to the set range

Example: When the range is 3,600m³/h (1m³/s), settable count rate is as follows:

Minimum value: $3,600\text{m}^3/\text{h} \div 3,600,000 \text{ pulses/h} = 0.001\text{m}^3 = 1 \text{ l (liter)}$

Maximum value: $3,600\text{m}^3/\text{h} \div 3.6 \text{ pulses/h} = 1,000\text{m}^3$

Note 3: Example of pulse width setting range (in the case of manual setting)

Pulse width can be set within the range of 0.3ms to 500ms in increments of 0.1ms. However, the pulse width must be 40% or less of the full-scale period.

Example 1: In the case of the following:

Range: 3600m³/h (1m³/s)

Count rate: 0.001m³

Since the count rate is $3,600 \text{ m}^3/\text{h} \div 0.001(\text{m}^3) = 3,600,000 \text{ pulses/h}$ (1000 pulse/s), the full scale period is $1\text{s} \div 1000 = 1\text{ms}$.

Therefore, pulse width can only be set to $1\text{ms} \times 0.4 = 0.4\text{ms}$.

Example 2: In the case of the following

Range: 3,600m³/h (1m³/s)

Count rate: 1000m³

Since the count rate is $3,600\text{m}^3/\text{h} \div 1000\text{m}^3 = 3.6 \text{ pulses/h}$ (0.001 pulse/s), the full scale period is $1\text{s} \div 0.001 = 1000\text{s}$.

Therefore, pulse width becomes $1000\text{s} \times 0.4 = 400\text{s}$.

However, since the maximum value is 500ms, pulse width becomes 500ms.

Example 3: In the case of the following

Range: 3,600m³/h (1m³/s)

Count rate: 1m³

Pulse width is set to 0ms

Since the count rate is $3,600\text{m}^3/\text{h} \div 1\text{m}^3 = 3600 \text{ pulses/h}$ (1 pulse/s), the full scale period is $1\text{s} \div 1 = 1\text{s}$.

Therefore, pulse width becomes $1\text{s} \times 0.4 = 400\text{ms}$.

However, since the maximum value is 100ms, pulse width becomes 100ms.

● **Totalizer operation using digital input signals**

Totalizer and pulse output can be operated.

Remote operations of the totalizer and pulse output can be performed using the Digital Input signals. Follow the procedure in 8.2.14 “Digital I/O Function” and set the Digital Input (DI) functions.

Operation using Digital Input signals (Standard product, Control signal level: High level)

Digital Input function	DI input	Totalizer, pulse output operation
Totalizer Start/Stop	Low level	Stops
	High level	Outputs
Totalizer Reset/Start	High level	Clears (resets) the totalizer and stops
	Low level	Outputs

It is possible to reverse the DI control signal levels by setting the digital input control signal levels.

- When high level (1:H LEVEL) is selected: The operation with the signal level is the same as the standard product shown in the above table.
- When low level (0:L LEVEL) is selected: The operation with the signal level becomes as shown below.

Operation using Digital Input signals (Control signal level: Low level)

Digital input function	DI input	Totalizer and pulse output operation
Totalizer Start/stop	Low level	Outputs
	High level	Stops
Totalizer Reset/Start	High level	Outputs
	Low level	Clears (resets) the totalizer and stops.

10.3 Multi-Range Functions

Five types of multi-range functions can be set using the Range Type:

	Range Typ	
(1)	Single direction, 4 ranges	Internal automatic switching
(2)	Forward and reverse directions, 2 ranges	Internal automatic switching
(3)	Single direction, 2 ranges	External signal switching
(4)	Forward and reverse directions, 2 ranges	External signal switching
(5)	Single direction, 4 ranges	External signal switching

To use the multi-range function, proceed as follows to set.

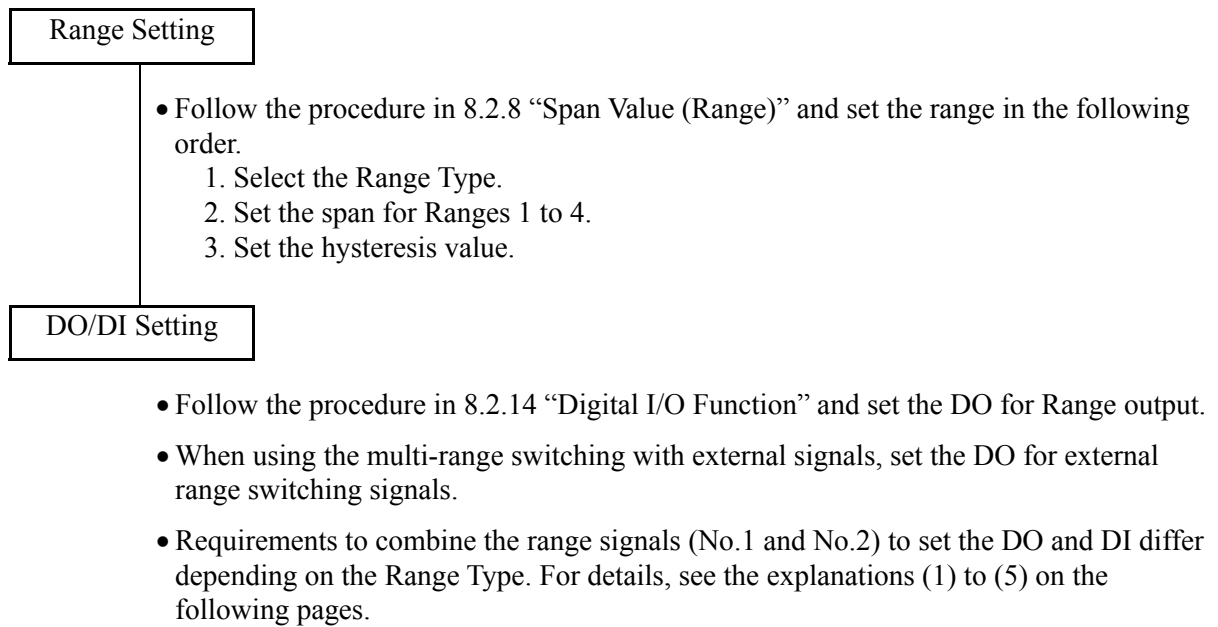

Output performance when multiple ranges are used

(1) Single direction (internal automatic switching), 4 ranges

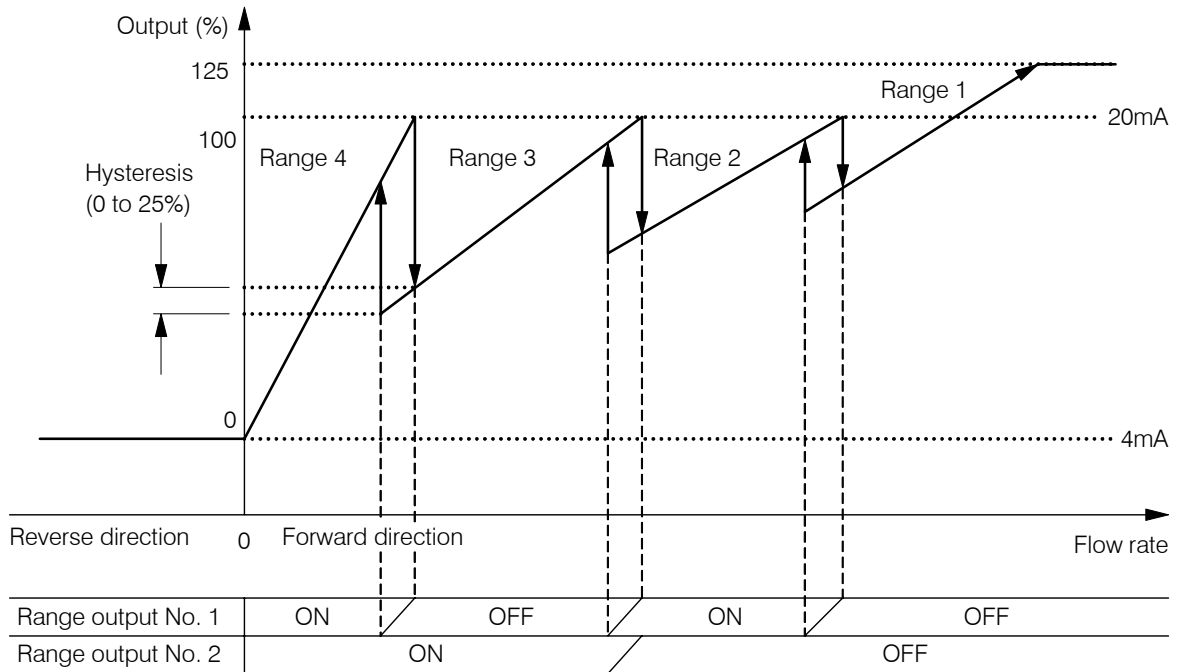

- Current output is 4mA as standard when fluid flows in reverse direction.
When the low cutoff function is not used (low cutoff setting is 0), it is possible to output the current output signal in linear scale up to 3.2mA or 2.4mA when fluid flows in reverse direction.

(2) Forward and reverse directions (internal automatic switching), 2 ranges

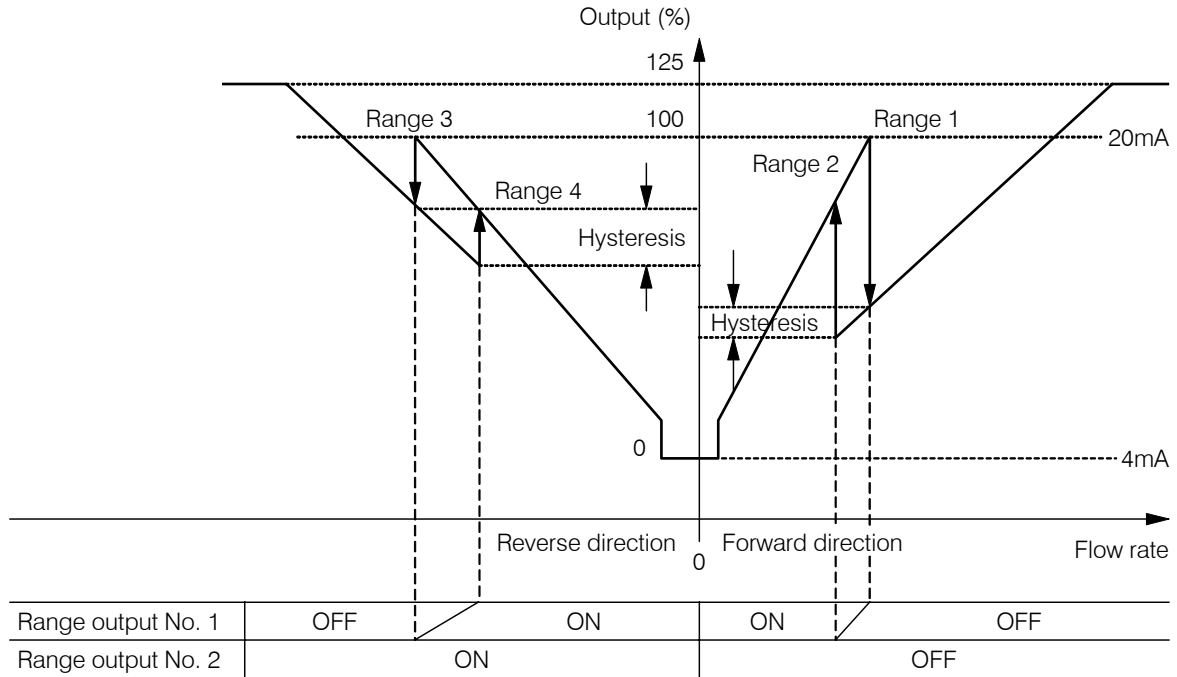

● Output when switched from Reverse to Forward direction

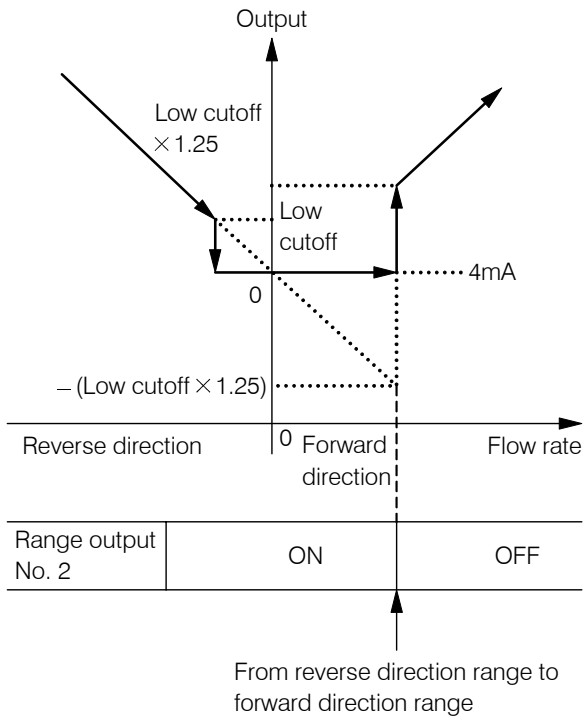

● Output when switched from Forward to Reverse direction

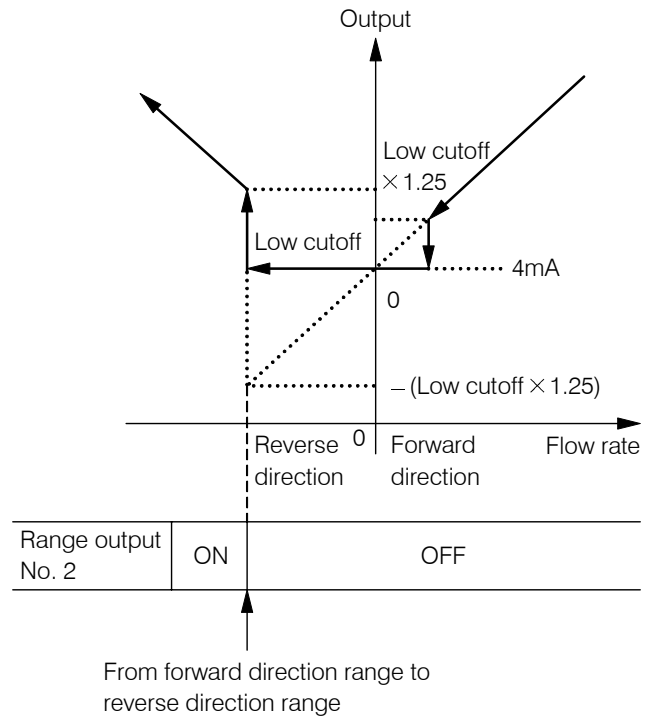

(3) Single direction (external signal switching), 2 ranges

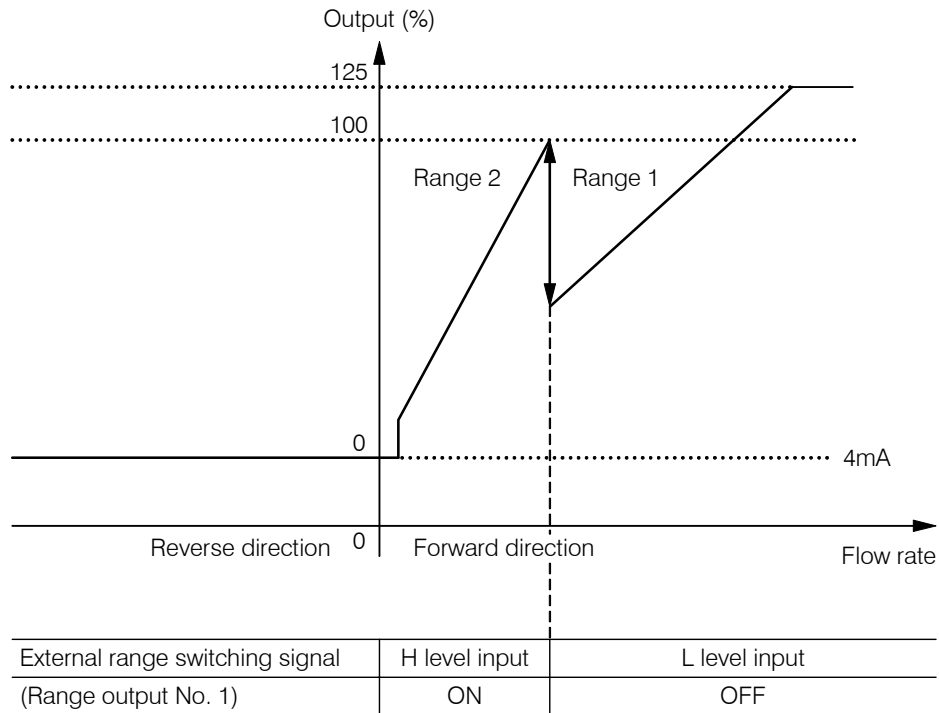

- Current output is 4mA as standard when fluid flows in reverse direction. When the low cutoff function is not used (low cutoff setting is 0), it is possible to output the current output signal in linear scale up to 3.2mA or 2.4mA when fluid flows in reverse direction.
- Works even if the range output is not used.

(4) Forward and reverse directions (external signal switching), 2 ranges

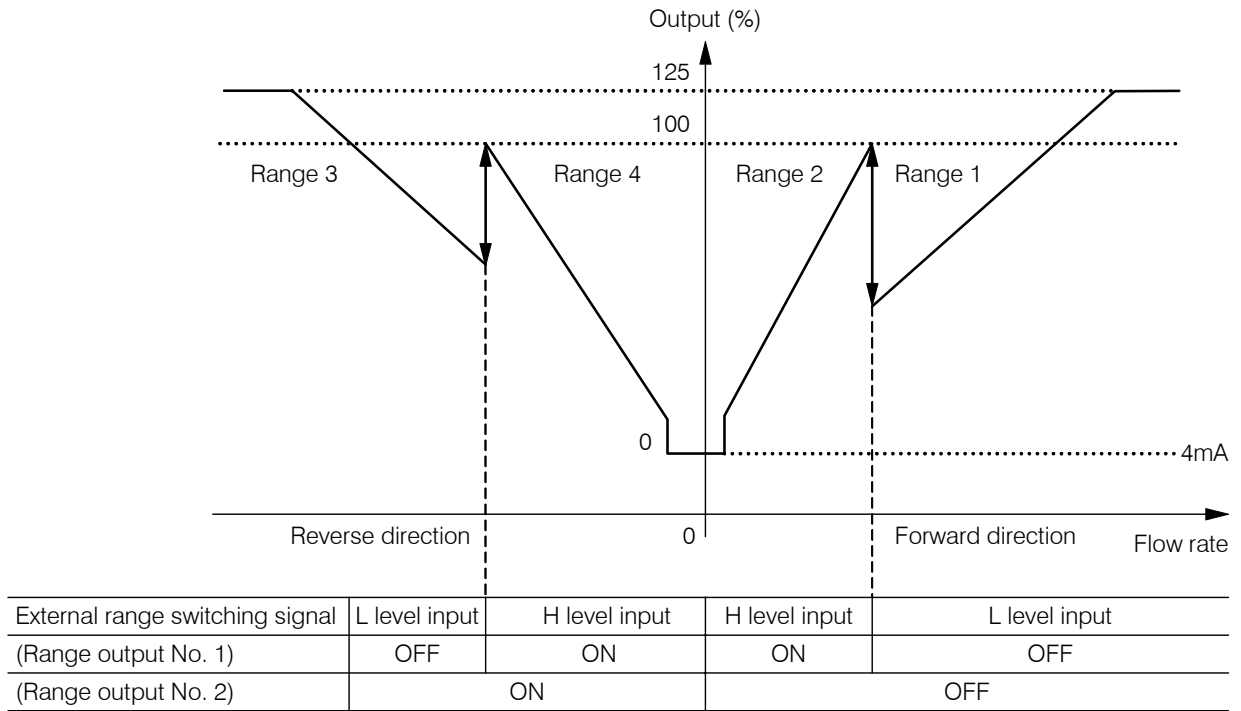

• Works even if the range output is not used.

● Output when switched from Reverse to Forward direction

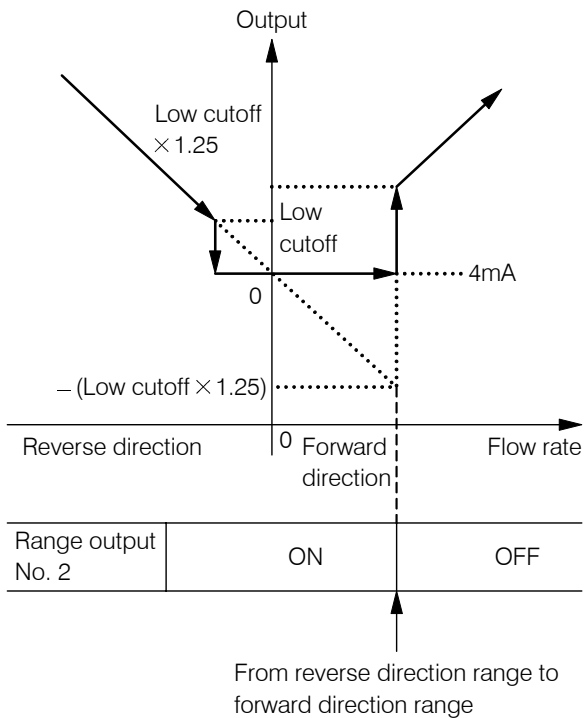

● Output when switched from Forward to Reverse direction

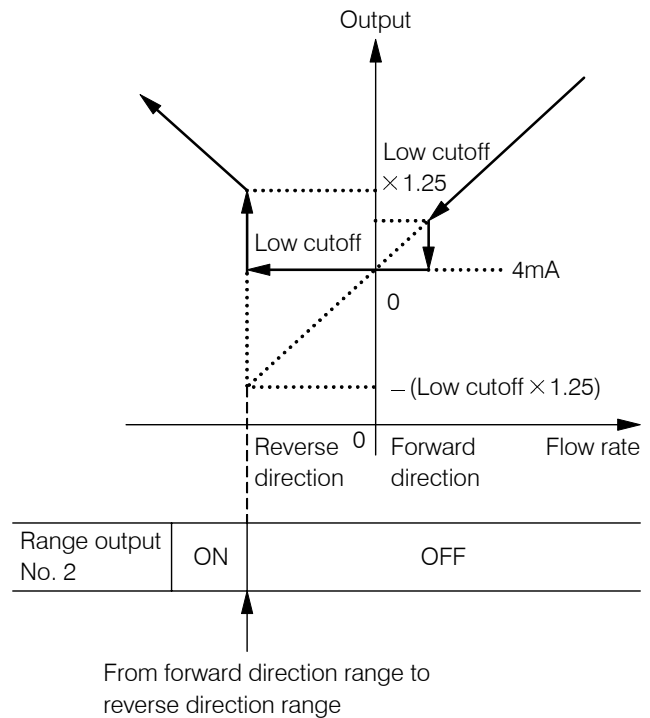

(5) Single direction (external signal switching), 4 ranges

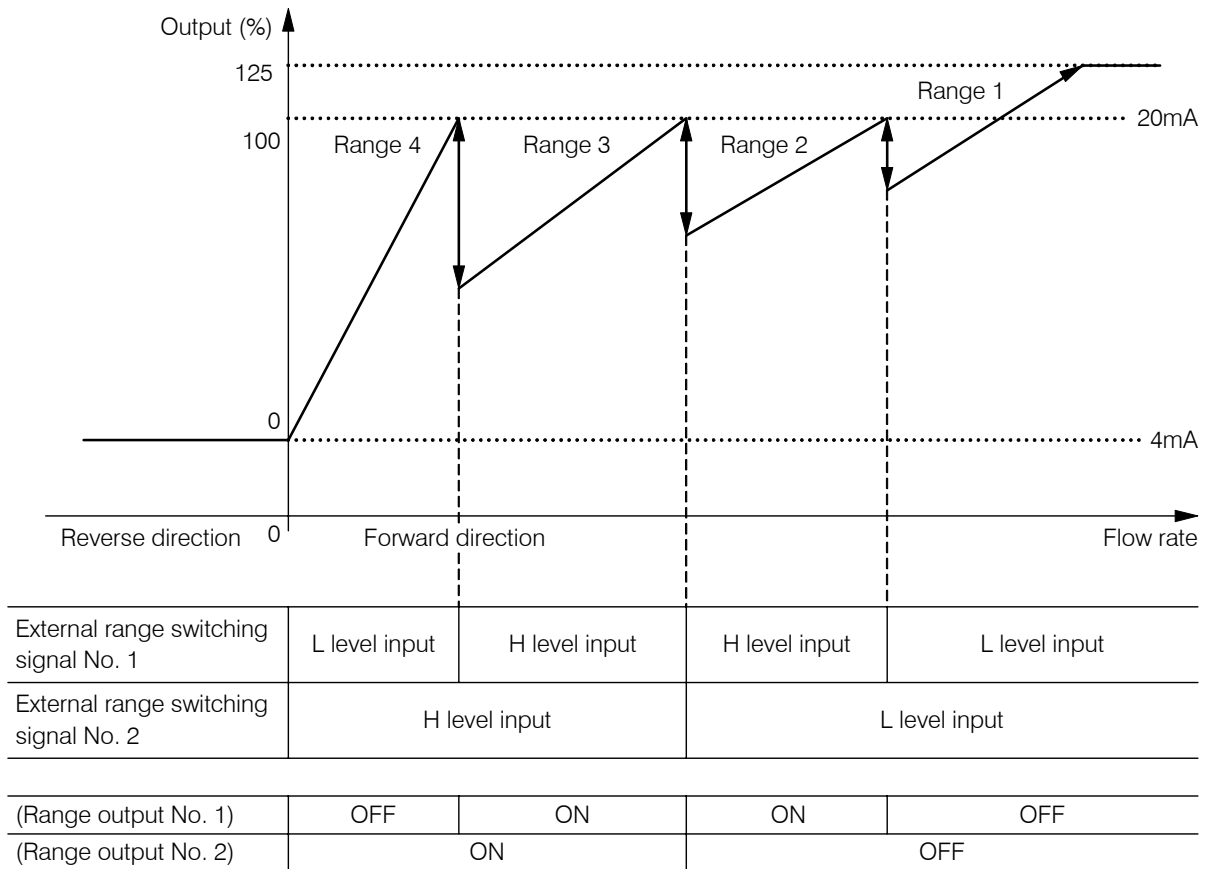

- Current output is 4mA as standard when fluid flows in reverse direction.
When the low cutoff function is not used (low cutoff setting is 0), it is possible to output the current output signal in linear scale up to 3.2mA or 2.4mA when fluid flows in reverse direction.
- Works even if the range output is not used.

10.4 Flow Rate High/Low Limit Alarm Output

Proceed as follows to use the flow rate high/low limit alarm.

High/Low Limit Alarm Value Setting

- Follow the procedure in 8.2.17 “Flow Rate High/Low alarm” and set the high limit alarm, high-high limit alarm, low limit alarm or low-low limit alarm to ON and set the alarm value.

For the alarm not used, set OFF to that alarm setting.

DO Setting

- Follow the procedure in 8.2.14 “Digital I/O Function” and set the Digital Output (DO) for high limit output, high-high limit alarm output, low limit alarm output or low-low limit alarm output. In addition, for alarm output state, select Normally Open or Normally Closed.

Flow rate high/low limit alarm output performance

- In the case of Single range

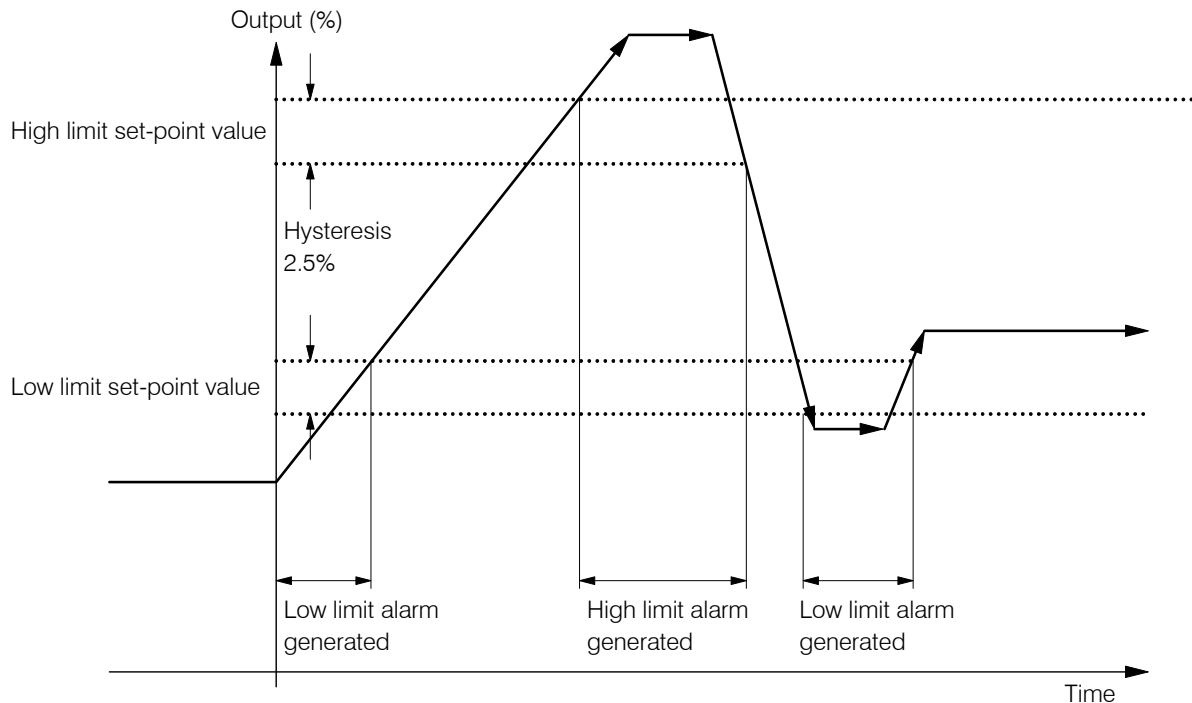

* The output state when an alarm occurs becomes the state set for alarm output of digital output. When the power supply of the converter is turned off, the contact is open.

- In the case of Multi-range setting

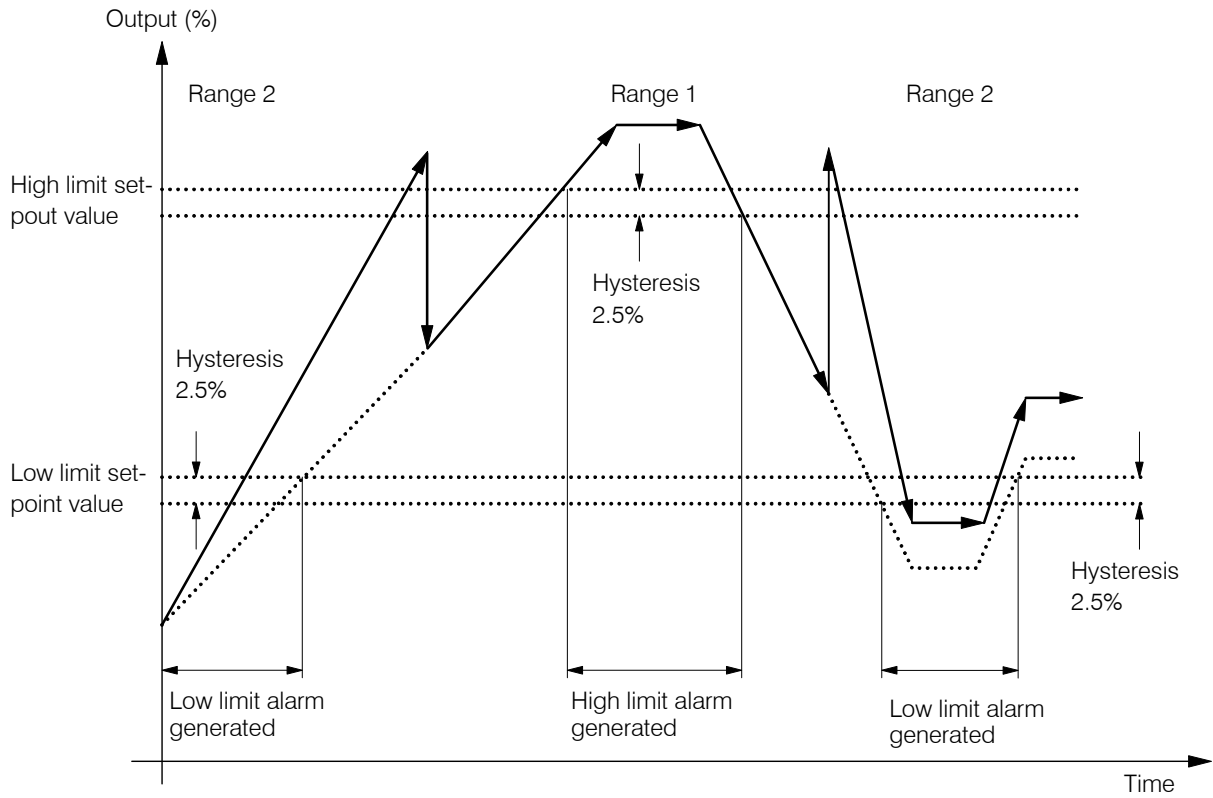

- * High/low limit alarm set-point value is a value indicated in percent of the Range 1.
- * The output state when an alarm occurs becomes the state set for alarm output of digital output. When the power supply of the converter is turned off, the contact is open.

- In the case of 2 high limit alarm points (high limit and high-high limit)

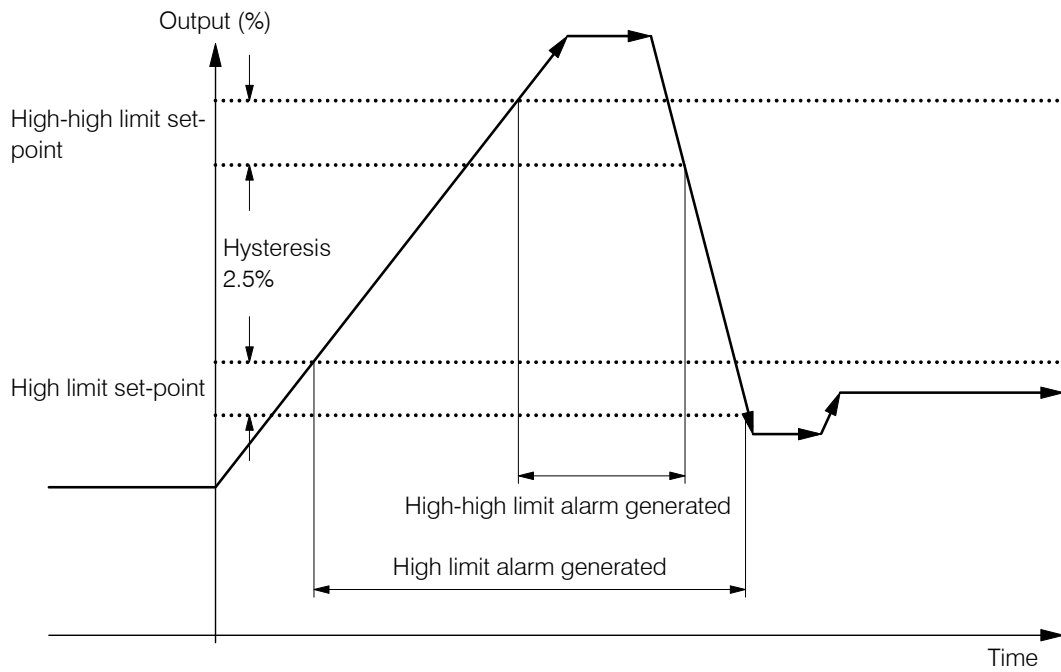

* The output state when an alarm occurs becomes the state set for alarm output of digital output. When the power supply of the converter is turned off, the contact is open.

10.5 Fluid Empty Alarm Output

Proceed as follows to use the fluid empty alarm.

(Note: In the case of LF232*F; Fluid empty alarm function is not usable. Set this function 'OFF'.)

Alarm Output Setting

- Follow the procedure in 8.2.18 “Fluid Empty Alarm” and set the fluid alarm setting to ON (NORMAL, SENSITIVE or SENSITIVE-H).

DO Setting

- Follow the procedure in 8.2.14 “Digital I/O Function” and set the Digital Output (DO) for fluid empty alarm output.
In addition, for alarm output state, select Normally Open or Normally Closed.
If only the fluid empty detection function is used and external contact output is not used, DO setting is not needed.

● Output when an alarm is generated

- 4 to 20mA output: 4mA (standard)
* Current output value when an alarm is generated can be set by referring to 8.2.11 “Current Output Setting Used When an Alarm Occurs.”
- Totalizer, pulse output: Totalizing operation and pulse output stopped
- Measured value display: Instantaneous flow rate is zero.
- Contact output: When an alarm occurs, output contact closes (standard).
* Contact operation when an alarm occurs can be set according to the alarm output state described in 8.2.14 “Digital I/O Function”

Note: When the power supply of the converter is turned off, the contact is open.

* For how to use the fluid empty alarm, see Precautionary notes in 12. “Diagnosis and Alarms.”

10.6 Preset Counter Output Function

A contact signal is output when the totalized flow count exceeds the preset value (preset count value).

Proceed as follows to use the preset counter output.

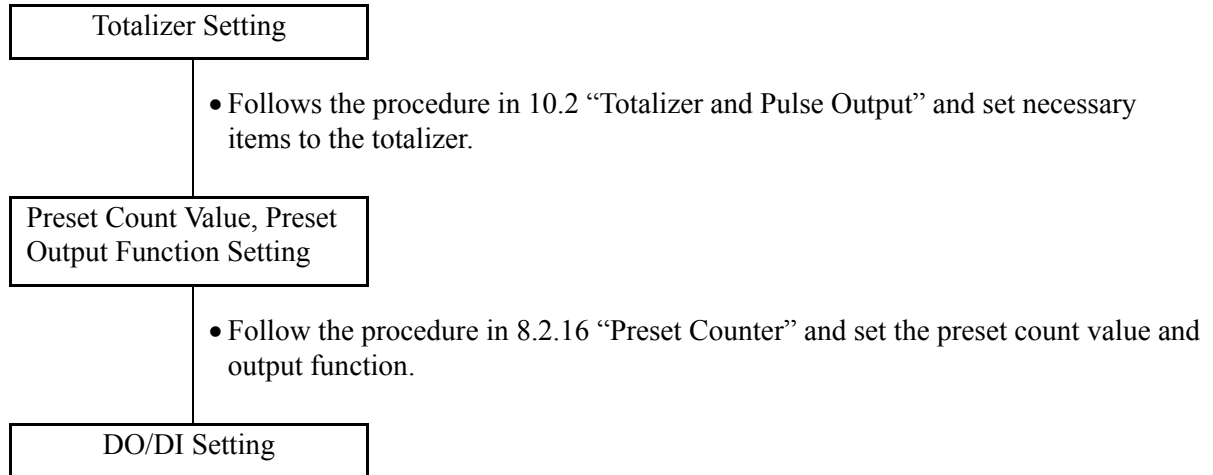

- Follow the procedure in 8.2.14 “Digital I/O Function” and set the digital output (DO) for use as a preset counter output.

In addition, if you want to reset the totalizer by an external signal, set the DI for the totalizer counter Reset/Start signal. (Set F3: DI FUNCTN to 2: C RES/STA.)

* Operation for the totalizer control signal can be set using the control signal level setting described in 8.2.14 “Digital I/O Function.”

When the operation switch in the converter is used to reset the counter, the digital input function (DI) setting is not needed.

Preset counter output performance

- Example to reset the totalizer using an external signal input
(When preset output level hold (Contact ON) is set)

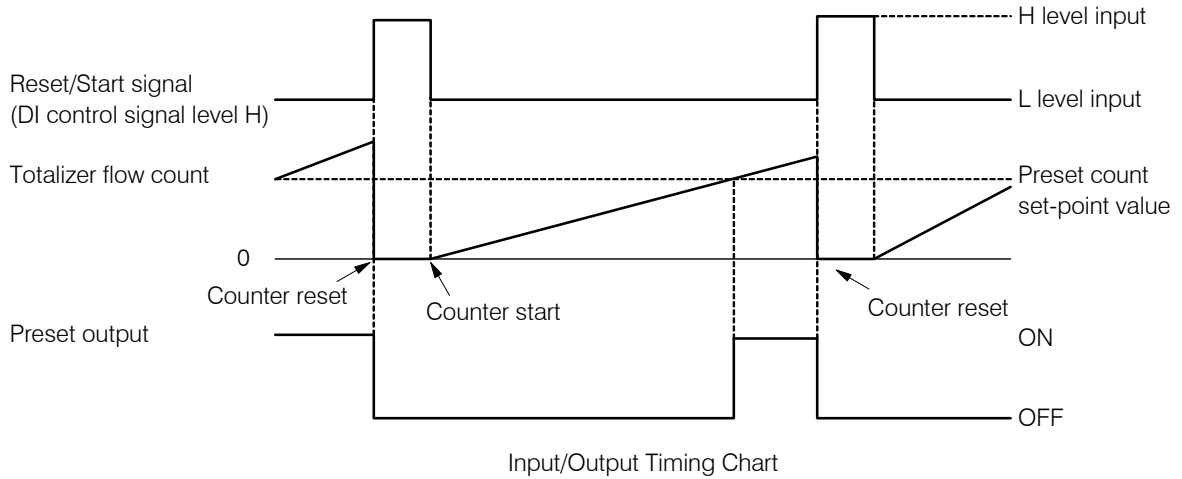

* When the Reset/Start signal is in H level (DI counter control signal level: H), the totalizer is reset to zero and stops counting. When the Reset/Start signal goes to L level, the totalizer starts counting. The preset output goes ON when the totalizer count exceeds the preset value, and the output goes OFF when the totalizer is reset to zero.

- Example to reset the totalizer using an external signal input (When one-shot pulse output is set)

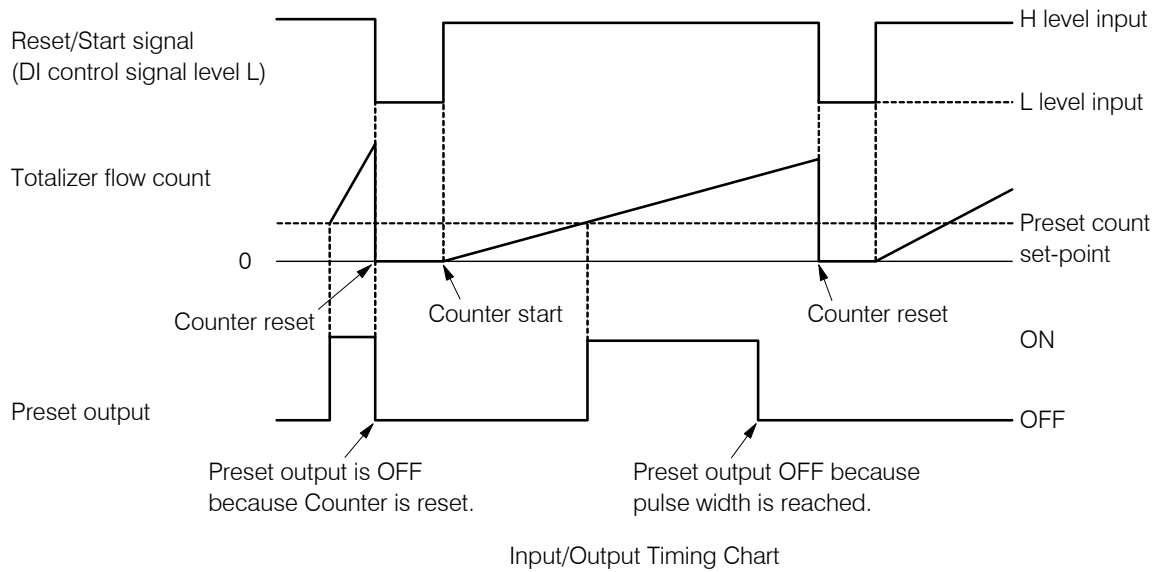

* When the Reset/Start signal is in L level (DI counter control signal level: L), the totalizer is reset to zero and stops counting. When the Reset/Start signal goes to H level, the totalizer starts counting. The preset output goes ON when the totalizer count exceeds the preset value, and the output goes OFF when the pulse width is reached or the totalizer is reset to zero.

• Output example of one-shot pulse output

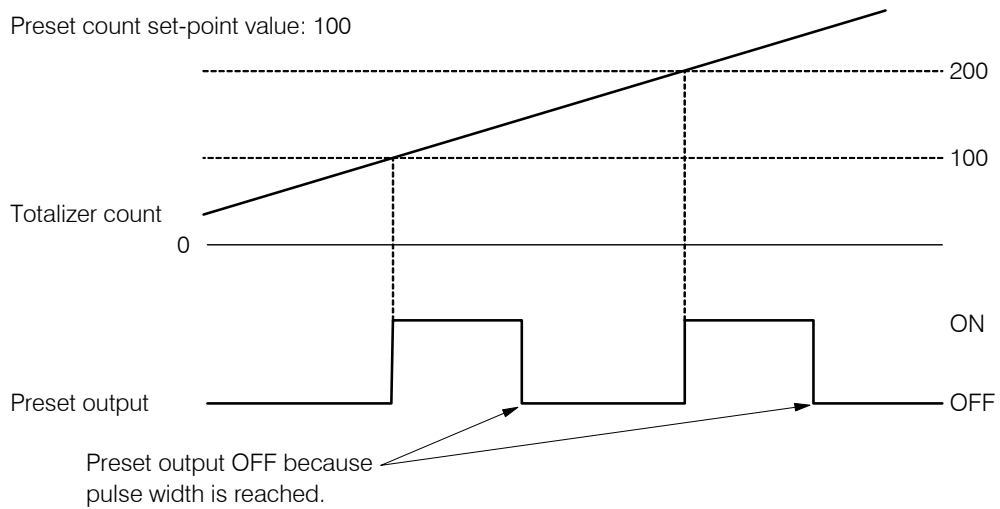

Input/Output Timing Chart

* Preset output goes ON when the count value exceeds the preset value of 100 and the preset output goes OFF when its width reaches the set pulse width.

When the preset value exceeds 100, the preset value is changed to 200 (adding the preset count of 100 to the current preset value of 100).

Then, the preset output goes ON when the count value exceeds the preset value of 200, and the preset output goes OFF when its width reaches the set pulse width.

When the preset value exceeds 200, the preset value is changed to 300 (adding the preset count of 100 to the current preset value of 200).

Note: When the one-shot pulse output function is selected, if its pulse width is large compared with the update interval of the preset value, the output stays ON. To make sure to output a one-shot pulse, set the preset value so that the conditions in the table below are satisfied.

Pulse width setting	Preset count value condition Interval that the preset value reaches	Example: Count rate: 0.01 l Flow velocity: 10 l/s Count-up rate: 1ms/COUNT
50ms	100ms or more	Preset count value: 100 or more
500ms	1000ms or more	Preset count value: 1000 or more

10.7 Remote Still Water Zero Adjustment

Still water zero adjustment can be performed using an external signal.

To use this function, follow the procedure in 8.2.14, “Digital I/O Function” and set the DI as a zero adjustment start signal.

[Signal input condition]

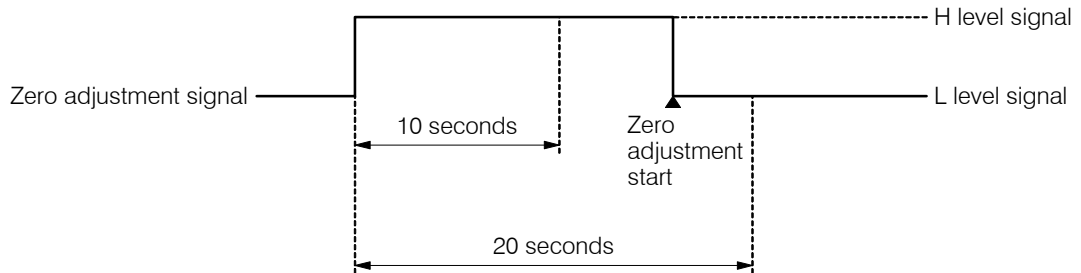

- * The signal must be set to H level first and then it must go to L level 10 seconds later but not more than 20 seconds, and then zero adjustment starts at the falling edge of the signal. If the signal stays in H level less than 10 seconds or more than 20 seconds, the signal will be ignored.

10.8 Remote Selection of Fixed Value Output

4 to 20mA output and pulse output can be set to a fixed preset value using a remote signal input. Proceed as follows to use this function.

Fixed Output Value Setting

- Follow the procedure in 8.4 “Fixed Value Output (Loop Check)” and set the current output value and pulse output value to be used at the time of fixed output. Set OFF for fixed output switching. If the pulse output is not used, it is not necessary to set the pulse output value.

DI Setting

- Follow the procedure in 8.2.14 “Digital I/O Function” to set the Digital Input (DI) to use it as fixed output mode control signal.

Signal input condition

External signal input	4 to 20mA and pulse output
L level input	Measured value is output.
H level input	Fixed preset value is output.

10.9 Converter Error Alarm Output

If one or more of the following errors occur in a self-diagnosis sequence, an alarm signal will be output using contact signals.

List of Alarm Output Factors

Diagnosis error item	Diagnosis error alarm output (DO)	
	WITHOUT EMP	WITH EMP
RAM error	○	○
ROM error	○	○
Exciting current value error	○	○
Exciting current wire broken	○	○
ADC error (error of flow measurement circuit)	○	○
Parameter error	○	○
Fluid empty alarm	—	○

- : If an error is detected, DO diagnosis error alarm is output.
- : Even if an error is detected, DO diagnosis error alarm will not be output.
(Alarm message is displayed)

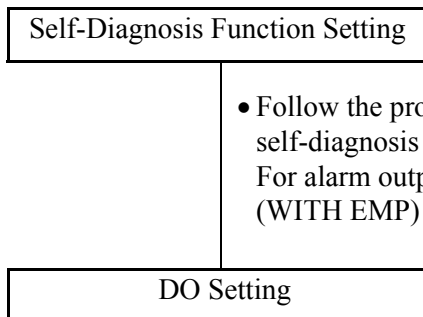

To use the converter error alarm output, follow the procedure in 8.2.14 “Digital I/O Function” and set the Digital Output (DO) for converter error alarm output. In addition, for alarm output state, select Normally Open or Normally Closed.

If the self-diagnosis function only is used and external contact output is not used, DO setting is not needed.

- Contact output operation
 - NORMAL OPEN : If an error occurs, contact closes
 - NORMAL CLOSE : If an error occurs, contact opens

Note: When power supply is turned off, the contact is OFF (contact opens).

11. Communications Function

The LF232 Series Converters are equipped with HART^{*1} protocol to transmit digital signals over the 4 to 20mA output line. The AF900 hand-held terminal (hereafter called HHT) can be used to check or change various parameters, calibrate the flowmeter or monitor the measured value from a remote place.

For the detailed operation and specification of HHT, refer to the "Hand-held Terminal for Sensor with Communication Function AF900 Instruction Manual" (6F8A0849).

^{*1} HART protocol: The "HART protocol", which stands for Highway Addressable Remote Transducer, is the name of the communication protocol for industry sensors that is recommended by HCF (HART Communication Foundation).

11.1 Connection with the HHT terminal

Connect the probe cable of the HHT terminal in parallel with the load resistor which is wired from the current output terminals (+ and -) of the flowmeter. Since the tip end of the probe cable is a pair of clips, use a junction terminal or a terminal block, etc. to connect with the clips of the probe. To connect the HHT directly to the flowmeter, use the terminals + and - of the converter main unit terminal block. Though the current output terminal has polarity, the HHT connection cable has no polarity.

See Figure 11.1 and 11.2 for connection examples.

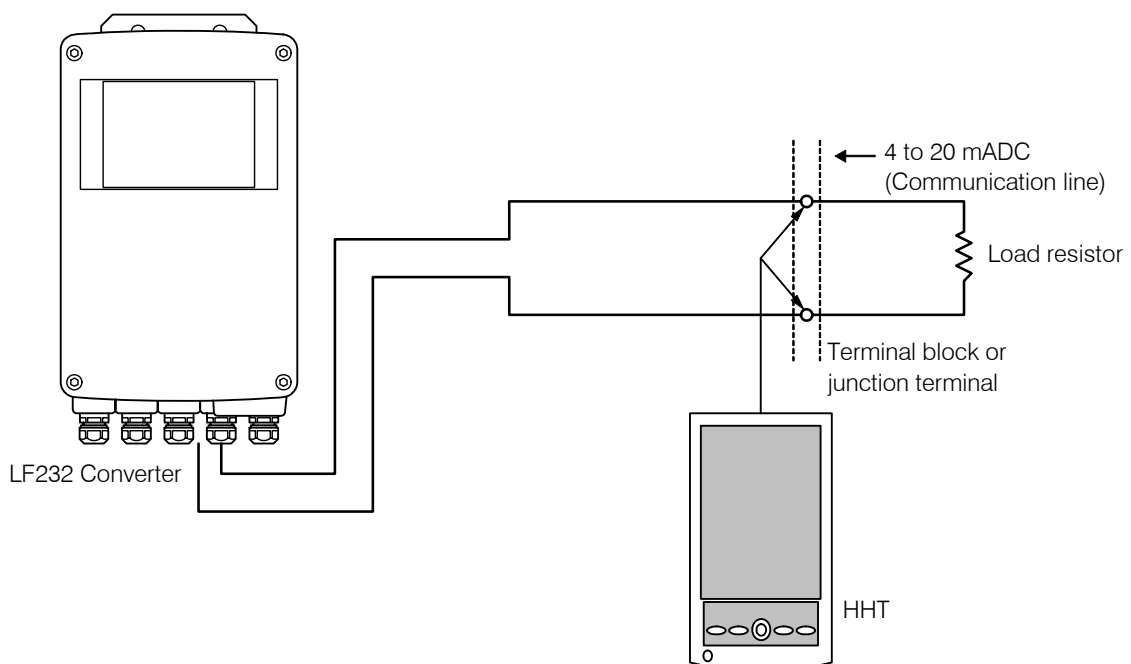

Figure 11.1 Connections to the Current Output Line

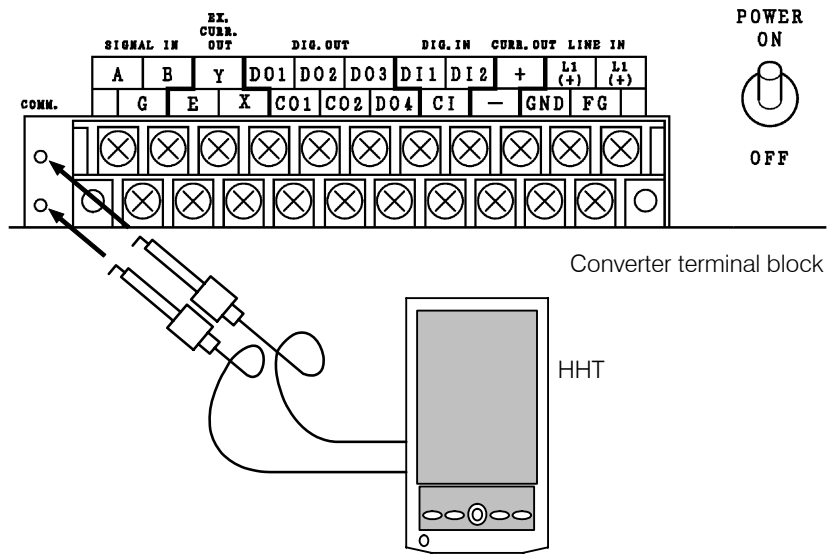

Figure 11.2 Connection to the Converter Main Unit

11.2 Procedure for Communication with HHT

This section describes the HHT basic operations for communication between the flowmeter and HHT. For details, refer to the HHT instruction manual.

* Carrying out the following preparatory operations to a commercially available PDA (OS: Windows CE), the PDA can be used as a HHT.

Procedure	Operation
① Prepare a hand-held terminal (1)	Install the AF900 application software to a commercially available PDA (OS: Windows CE) main unit. Then insert the serial interface card supplied with AF900 to the card slot of the PDA.
② Prepare a hand-held terminal (2)	Connect the HART interface cable and serial interface card supplied with AF900 to each other.
③ Connect the HHT	Connect the alligator clips at the end of the HART interface cable to the current output line of the converter via a load resistor.
④ Start the HHT	Turn on the power supply of the PDA to start the AF900 application software.
⑤ Preliminary communication	Execute [sensor communication]. The model name of the connected sensor product is automatically identified and the converter menu screen appears.
⑥ Check or change the data	Press the relevant parameter button and check or change the desired data.
⑦ Exit the communication	When all of the operations are complete, press the [Exist Application] in the top screen to turn off the power supply of the PDA.

11.3 Cautionary Notes on Communications

Observe the following limitations when you communicate with flowmeter using HHT.

● Current output load

- (1) Load resistance: 240Ω to $1k\Omega$ (including communications line resistance)
- (2) Load capacitance: $0.25\ \mu\text{F}$ maximum (including communications line capacitance)
- (3) Load inductance: 4mH maximum (including communications line inductance)
(For maximum cable length, about 2km is a guideline length when CVV-S 1.25mm^2 is used.)

● Wiring cable

Use a shielded cable (CVV-S, etc) for wiring.

● Interference on 4 to 20mA current signal

To communicate with the flowmeter, a digital signal (amplitude 0.4 to 0.8 V in the case of 500Ω load resistance) with a frequency of 1.2 to 2.2 kHz is superimposed on the 4 to 20mA current signal. If a receiving instrument with fast response time is connected to the analog current output line, the superimposed communications signal may interfere with the output. To prevent this interference, put a low-pass filter with a time constant of about 100 ms into the input circuit of the receiving instrument.

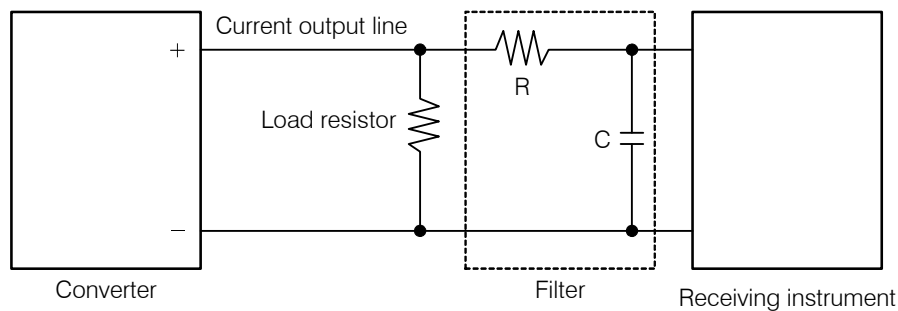

Figure 11.3 Filter Connection Example

12. Diagnosis and Alarms

12.1 Diagnostic messages

The LF232 converter is equipped with the function to diagnose such errors as setting errors, I/O errors or internal errors of the instrument and shows the error messages on the LCD display or on the HHT through communications. The diagnostic messages and their corrective actions are described below.

● **Setting error**

If you try to set a constant or a unit exceeding the specified range in the setting mode, an error is displayed to prevent erroneous setting.

LCD display	Description	Corrective action
* H. OVER SPEC.	Setting value exceeds the settable range.	Try to set a value within the settable range again.
* L. OVER SPEC.	Setting value is below the settable range.	
* H. OVER C RATE	Count rate exceeds the settable range.	
* L. OVER C RATE	Count rate is below the settable range.	
* MULT I RNG ERR	Span value setting does not satisfy the multi-range requirements.	Try to set a span value that satisfies the requirements.

● **High/low limit alarm**

An alarm message appears if the flow rate indication goes out of the set range.

If the alarm is set to OFF, this function does not work. For how to set this function, see 8.2 “Parameter Check/Change.”

LCD display	Description	Corrective action
HIGH ALARM	Flow rate is above the high limit set-point value.	Adjust so that the flow rate stays below the set-point value.
H-HIGH ALARM	Flow rate is above the high-high limit set-point value.	Adjust so that the flow rate stays below the set-point value.
L ALARM	Flow rate is below the low limit set-point value.	Adjust so that the flow rate stays below the set-point value.
L-LOW ALARM	Flow rate is below the low-low limit set-point value.	Adjust so that the flow rate stays below the set-point value.

● **Process error alarm**

LCD display	Description	Corrective action
OVER 125%	The measured value is above the 125% of the span.	The setting range for measured value is narrow or the flow rate is unexpectedly large. Check whether the set value is correct or not and check that there is no problem in the process.
UNDER -125%	The measured value is below the -125% of the span	The setting range of measured value is narrow or the flow rate is unexpectedly large. Check whether the set value is correct or not and check that there is no problem in the process.

● **Fluid empty alarm**

Detects that the fluid in the measuring pipe of the detector is empty and an alarm will be displayed.

If the alarm is set to OFF, this function does not work. For how to set this function, see 8.2 “Parameter Check/Change.”

(Note: In the case of LF232*F; Fluid empty alarm function is not usable. Set this function 'OFF'.)

LCD display	Description	Corrective action
EMPTY	Fluid is not filled in the measuring pipe of the detector.	Take measures to fill the pipe with fluid.

Precautionary notes when using the fluid empty alarm

- (1) Since the fluid empty alarm is detected using the impedance between the signal wires connected to a pair of electrodes in the detector as well as the input signal level, a false alarm may be detected by the following factors:
 - Signal wire is broken or loose connection exists
 - A large amount of air bubbles are mixed in the fluid
 - Insulating materials are accumulated on the electrode
- (2) In an environment where grounding is incomplete or excessive noise enters from the outside, the fluid empty alarm may not work correctly.
 In addition, under the condition like this, reliability of flow measurement itself decreases. Take necessary measures to prevent the entry of noise such as making the ground complete (independent Class D ground with grounding resistance 100Ω or less) or reviewing the cable wiring route.
- (3) If the fluid still remains in the measuring pipe or deposits of conductive materials remain in the measuring pipe, the impedance between the signal wires does not increase and the fluid empty alarm may not work. In this case, use other method (such as a pump stop signal or a signal from valves) to check the fluid empty condition.

● Self-diagnosis error

The converter performs an operation check immediately after power is turned on and if an error is found, a self-diagnosis error is generated.

If more than one error occurs at the same time, the contents of those errors will be displayed cyclically. The diagnosis about excitation is carried out using the internal ADC function. Therefore, if an error of No.6 internal ADC occurs, Excitation wire of No.4 and Excitation circuit of No.5 cannot be diagnosed correctly.

In addition, since the entire checking system is based on the CPU, if the CPU fails, accurate diagnosis and indication cannot be obtained.

No.	LCD display	Description	Corrective action
1	* ROM ERROR *	ROM error occurred	Internal parts or printed-circuit board must be repaired or replaced. Contact your nearest Toshiba representative.
2	* RAM ERROR *	RAM error occurred	
3	PARAMETER FAIL	An error occurred in the internal parameters in the memory	
4	EX. CURR. OPEN	Excitation wires are not connected.	Connect the excitation wires correctly.
5	EX. CURR. ERROR	An error occurred in the excitation circuit.	Internal parts or printed-circuit board must be repaired or replaced. Contact your nearest Toshiba representative.
6	ADC. ERROR	An error occurred in the ADC circuit	
7	INVALID TOTAL	Totalized data in the memory was destroyed caused by the entry of noise. (No message appears if the data is not displayed in an indicating unit of totalization.)	The error message disappears if you press the reset key to clear the totalized data.

Note 1: Diagnosis for No. 1, No.2 and No. 3 is performed only immediately after power is turned on. If any of these errors is indicated, the converter does not start measurement operation. If these errors occur after power is turned on, the converter cannot detect these errors. In addition, if this happen, the indication and output of the converter may become uncertain.

Note 2: Errors No. 4 to No. 6 may not be detected even if those errors cause accuracy problems because of the characteristic variations in components constituting the circuits used for judgment standard to determine these errors.

Note 3: CPU error cannot be detected. If the CPU stops, the watchdog timer resets the hardware and the flowmeter starts again from the initial power-on condition. Depending on the condition of CPU error, the indication and output of the converter may become uncertain.

12.2 Output When an Error or Alarm Occurs

Error indication	Measured value display	Current output (4 to 20mA)	Totalizer pulse output	Remarks
ROM ERROR (Note 1)	—	4mA (standard) (Note 3)	Stopped	After power-up, measurement does not start.
RAM ERROR	—	4mA (standard) (Note 3)	Stopped	After power-up, measurement does not start.
PARAMETER FAIL (Note 2)	Zero	4mA (standard) (Note 3)	Stopped	—
EX. CURR OPEN	Zero	4mA (standard) (Note 3)	Stopped	Still water zero adjustment cannot be conducted.
EX. CURR ERROR	Zero	4mA (standard) (Note 3)	Stopped	—
ADC ERROR	Zero	4mA (standard) (Note 3)	Stopped	—
EMPTY	Zero	4mA (standard) (Note 3)	Stopped	Still water zero adjustment cannot be performed.
INVALID TOTAL	Measured value	Measured value	Measured value	The error message disappears if you clear (reset) the totalizer.
HIGH ALARM	Measured value	Measured value	Measured value	—
H-HIGH ALARM	Measured value	Measured value	Measured value	—
L ALARM	Measured value	Measured value	Measured value	—
L-LOW ALARM	Measured value	Measured value	Measured value	—



Note 1: The display and output may be uncertain depending on the nature of the ROM error.

Note 2: If a parameter failure relating to the current output occurs, the current output may not become exactly the set value of the current output used when an alarm occurs.

Note 3: The output becomes the value selected in 8.2.11 “Current Output Setting Used When an Alarm Occurs.”

Note 4: If the fluid empty alarm not included (WITHOUT EMP) is selected (standard) in the setting for alarm output factors in 8.2.19 “Self-Diagnosis Function,” the output becomes 4mA and if the fluid alarm included (WITH EMP) is selected, the output becomes the same as the above in Note 3.

13. Maintenance and Inspection

 CAUTION	
<p>■ Do not conduct wiring work when power is applied.</p> <p> Wiring while power is applied can cause electric shock.</p> <p>DON'T</p>	<p>■ Do not touch the LF232 main body when high temperature fluid is being measured.</p> <p> The fluid raises the main body temperature and can cause burns when touched.</p> <p>DON'T</p>

13.1 Maintenance

● Mag-Prover Calibration / Check

The LF232 converter has a built-in reference signal calibration and verification circuit that allows you to re-verify the original flowmeter flow lab calibration without the need for external devices. This reference signal can be used to check and adjust the circuit to perform zero and span calibration of the converter itself and for the purpose of maintenance and periodical inspection. See 9. “Mag-Prover Calibration.”

● Check / Replacement of fuse

Fuse can be taken out by turning the top of the fuse holder counterclockwise. Check that the fuse is not damaged. In addition, fuse has its own life and it must to be replaced periodically. (Recommended replacement cycle is about 3 years.)

Type of fuse used: Glass tube fuse (normal blow type)

Rating: In the case of power supply 100 to 240 VAC and 110VDC
1A, 250V 2 pieces

In the case of power supply 24VDC and 100 to 120 VAC for large meter size detector

2A, 250V 2 pieces

In the case of power supply 24VDC for large meter size detector and 24VDC for partially filled pipes detector

3A, 250V 2 pieces

Dimensions: Diameter 5.2 mm × 20 mm

● Check / Replacement of display unit

If the characters displayed on the LCD become thin or blots come out, the life of the LCD is reached. Replace the display unit with a new one. In order to use the display unit stably for a long time, it is preferable to replace it early. For inspection and replacement, please contact your nearest Toshiba representative.

● Check / Replacement of power supply unit

In general, electronic components deteriorate faster if the ambient temperature is high. The life of the power supply unit is about 10 years if the ambient temperature is 40°C, and 5 to 6 years if the temperature is 50°C or more. To extend the life of the flowmeter, it is recommended that you replace the power supply unit early.

Contact your nearest Toshiba representative for a flowmeter inspection or unit replacement.

● Product disposal

The main body or parts of the converter must be disposed of, according to the rules and regulations of your local government.

Especially if you dispose of electrolytic capacitors to replace parts, have it done by an agency which is licensed to handle industry waste materials.

● Operative life

The operative life of this flowmeter is 10 years from the date of shipment.

The life of the flowmeter differs depending on the environmental conditions and the way it was used. To extend the life of the flowmeter, inspect the flowmeter periodically and clean or replace components if necessary.

13.2 Troubleshooting

If a problem occurs, you may find a cause of the problem by performing the simple inspection. Before you call repair service personnel, inspect the flowmeter using the flowcharts shown below.

13.2.1 Flow rate is not indicated

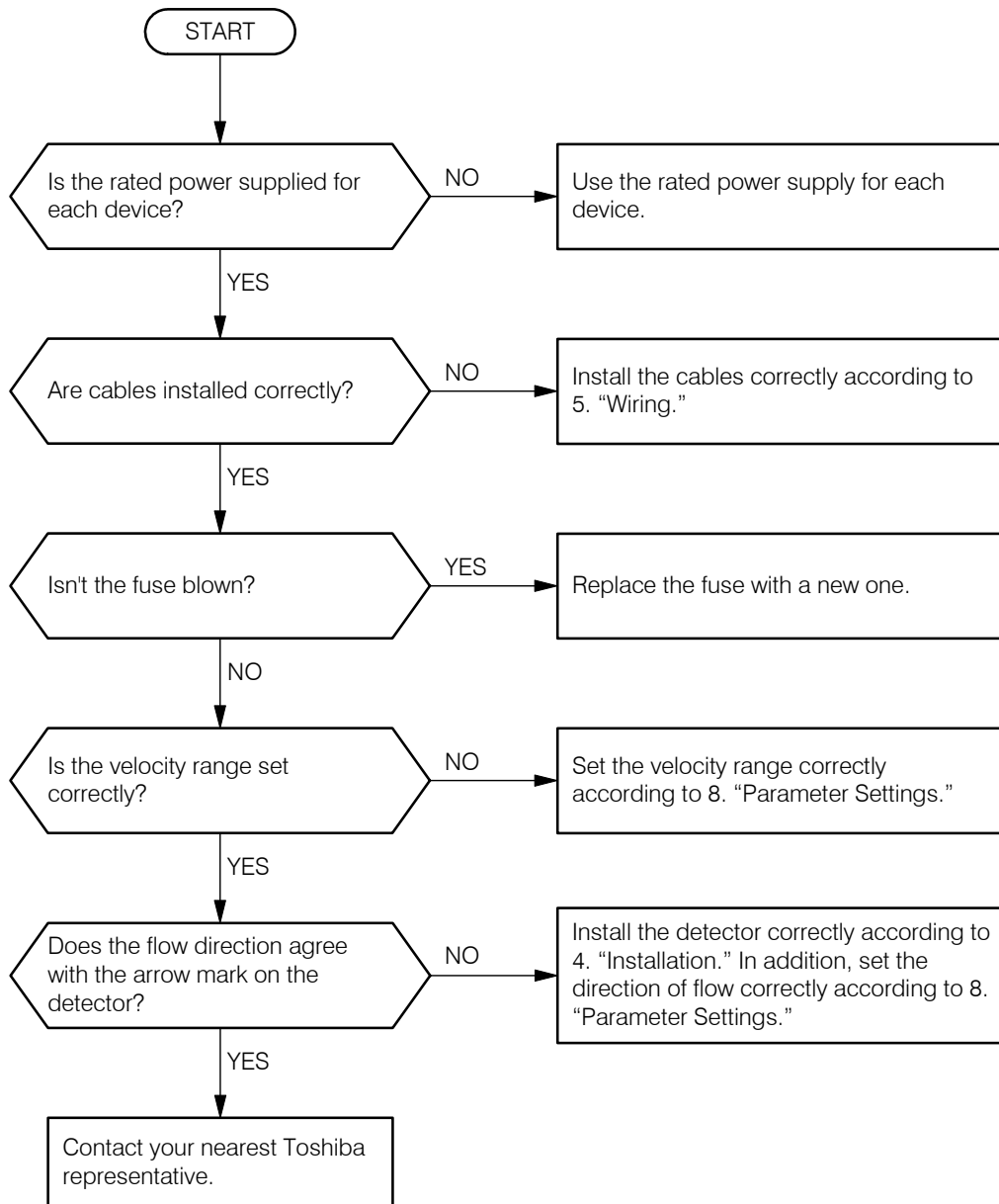

13.2.2 Flow rate indication is not correct

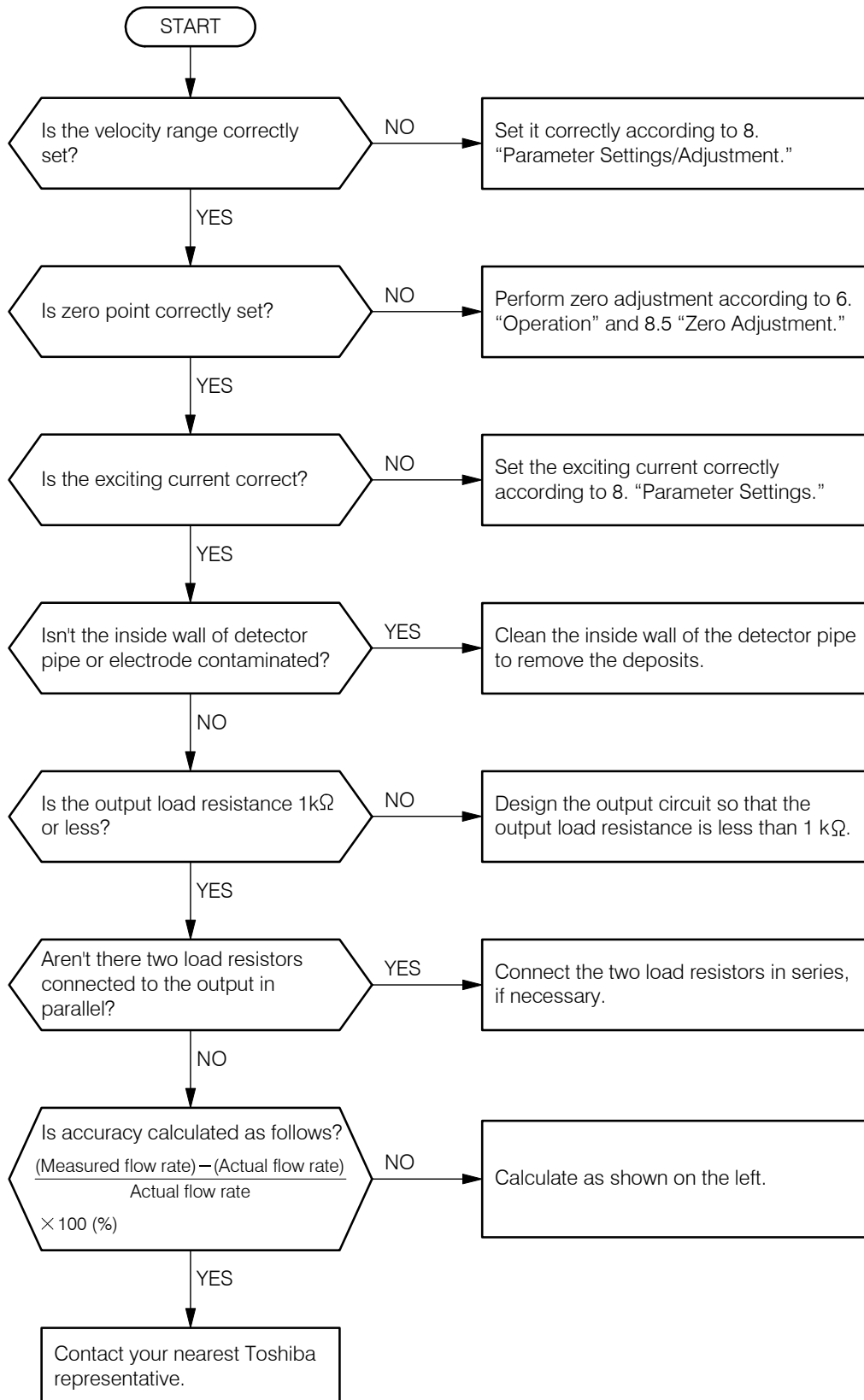

13.2.3 Flow rate indication is not stable

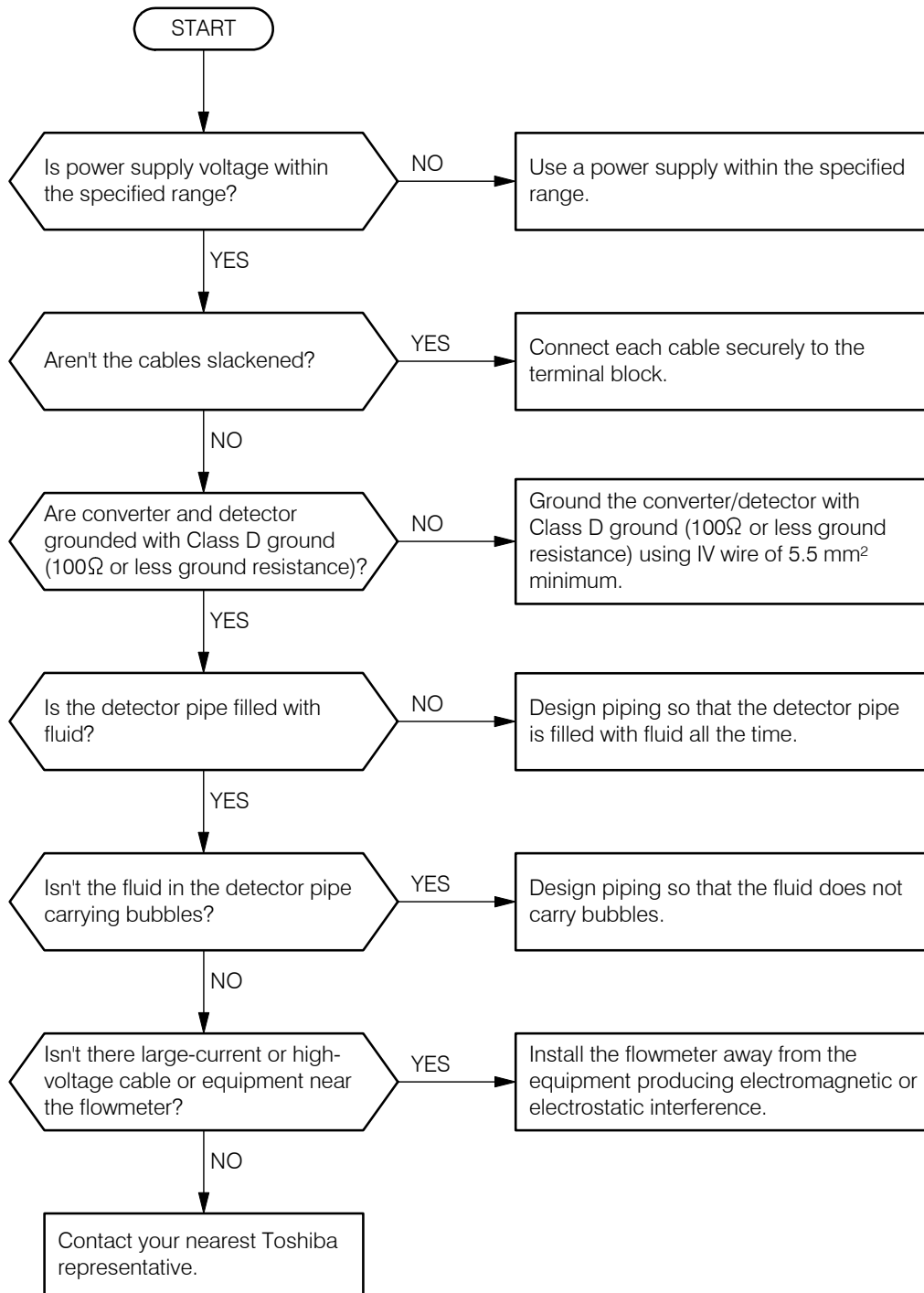

13.2.4 When switch operation is unable

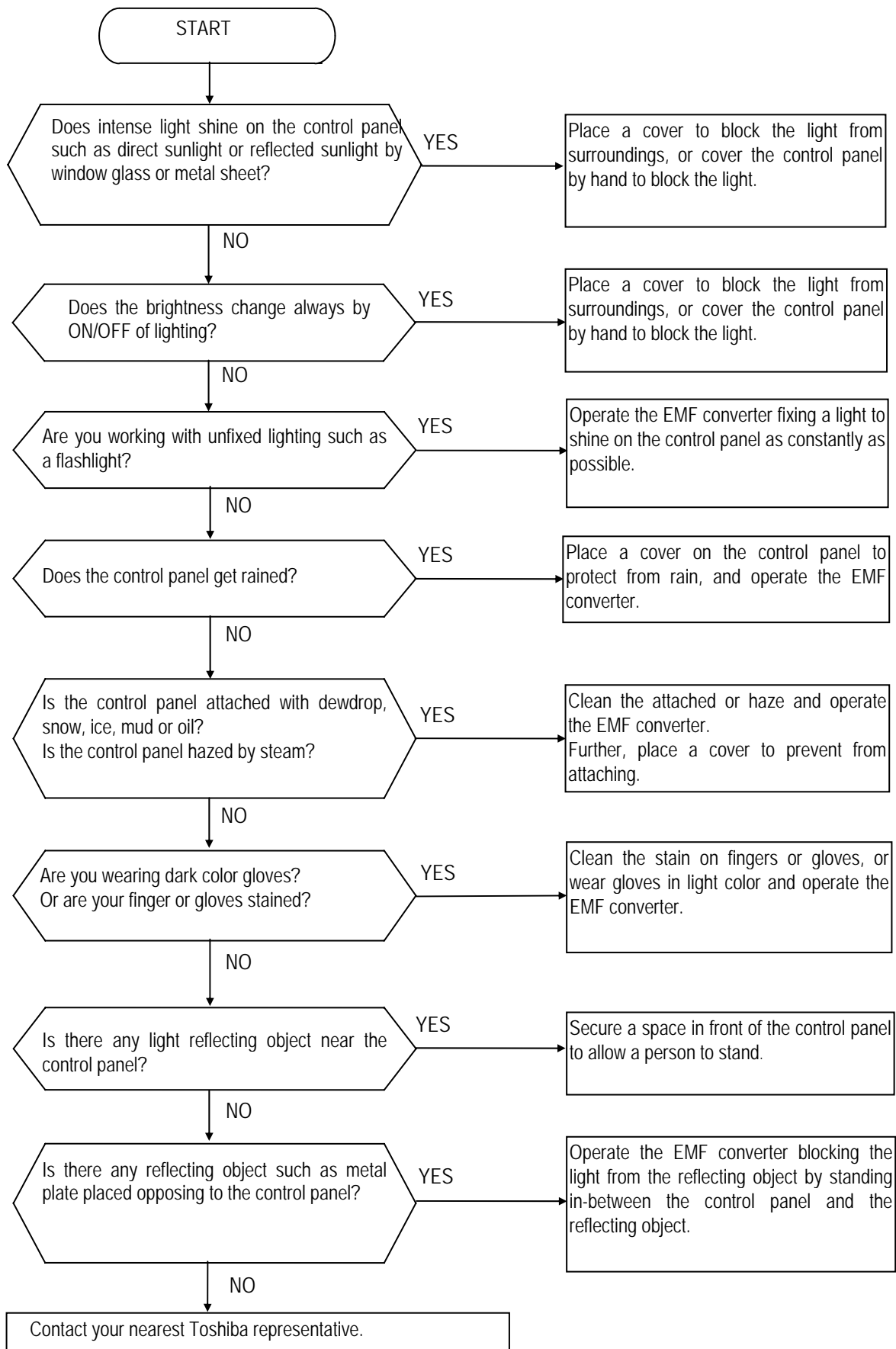

14. Principle of Operation

The operating principle of the electromagnetic flowmeter is based on Faraday's Law of electromagnetic induction. The principle of operation is that an insulated pipe with inner diameter D is placed vertically to the direction of a magnetic field with flux density B (see Figure 14.1). When an electrically conductive fluid flows in the pipe, an electromotive force signal E is induced between a pair of electrodes placed at right angles to the direction of magnetic field. The electromotive force signal E is directly proportional to the average fluid velocity V and this voltage signal is detected.

The following expression is applicable to the voltage.

$$E = K \times B \times D \times V \text{ [V]} \dots\dots\dots(\text{Eq. 14.1})$$

E : Electromotive force signal [V]
 K : Constant
 B : Magnetic flux density [T]
 D : Meter pipe inner diameter [m]
 V : Fluid velocity [m/s]

Volumetric flow rate Q [m³/s] of fluid is:

$$Q = \frac{\pi \times D^2}{4} \times V \dots\dots\dots(\text{Eq. 14.2})$$

Thus, we can obtain the equation below using Eq.14.1 and Eq.14.2,

$$E = K \times B \times D \frac{4}{\pi \times D^2} \times Q$$

$$E = \frac{4 \times K \times B}{\pi \times D} \times Q \dots\dots\dots(\text{Eq. 14.3})$$

Therefore, the electromotive force signal E proportional to the flow rate can be obtained.

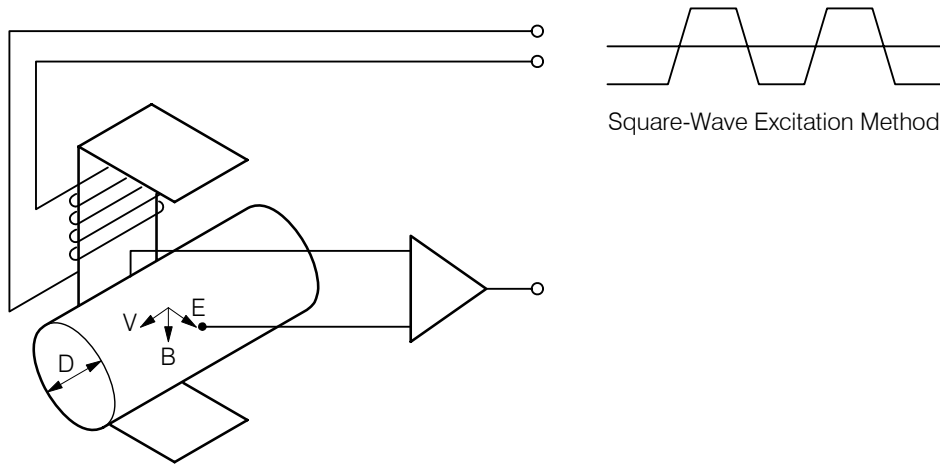

Figure 14.1 Principle of Operation

The LF232 electromagnetic flowmeter converter uses the square-wave excitation method, which provides long-term stable operations without being affected by electrostatic and electromagnetic interferences.

15. Specifications

15.1 Specifications

● **Detector Combined Specifications**

1. Measuring range: (measuring range in terms of flow velocity)

0 – 1.0 ft/s to 0 – 32.8 ft/s (0 – 0.3 m/s to 0 – 10 m/s)

For partially filled pipes detectors (Combined detector is LF502)

Meter	Measurement range
6" (150mm)	0 – 264 GPM(std) to 0 – 1320 GPM (0 – 60 m ³ /h to 0 – 300 m ³ /h)
8" (200mm)	0 – 484 GPM(std) to 0 – 2420 GPM (0 – 110 m ³ /h to 0 – 550 m ³ /h)
10" (250mm)	0 – 770 GPM(std) to 0 – 3850 GPM (0 – 175 m ³ /h to 0 – 875 m ³ /h)
12" (300mm)	0 – 1100 GPM(std) to 0 – 5500 GPM (0 – 250 m ³ /h to 0 – 1250 m ³ /h)
14" (350mm)	0 – 1540 GPM(std) to 0 – 7700 GPM (0 – 350 m ³ /h to 0 – 1750 m ³ /h)
16" (400mm)	0 – 1980 GPM(std) to 0 – 9900 GPM (0 – 450 m ³ /h to 0 – 2250 m ³ /h)
20" (500mm)	0 – 3124 GPM(std) to 0 – 15620 GPM (0 – 710 m ³ /h to 0 – 3550 m ³ /h)
24" (600mm)	0 – 4400 GPM(std) to 0 – 22000 GPM (0 – 1000 m ³ /h to 0 – 5000 m ³ /h)

(Above flow rate is almost 0 – 3.28 ft/s (std) to 0 – 16.4 ft/s (0 – 1 m/s to 0 – 5 m/s) flow velocity.)

2. Measurement accuracy: (Accuracy when combined with detector)

- Combined detector: LF470 (Meter size 1/10" to 1/4" (2.5 to 6mm))

Flow rate to the range (%)	Range	
	1.0-3.3ft/s (0.3-1.0m/s)	3.3-32.8ft/s (1.0-10m/s)
0 to 50 %	± 0.8 % FS	± 0.4 % FS
50 to 100 %	± 0.8 % FS	± 0.8 % of rate

- Combined detector: LF150 (Meter size 20" to 120" (500 to 3000mm))

±0.5 % of Rate*

- * This error is pulse output results calibrated under standard operating conditions at Toshiba's flow calibration facility.
- * Individual meter's measurement error may vary up to ± 0.8 % of Rate at 3.28 ft/s (1.0 m/s) or more and ± 0.4% of Rate ±0.157 inch/s (4mm/s) at 3.28 ft/s or less.
- * Refer to individual calibration data for each meter's measurement error.

- For partially filled pipes detectors (Combined detector is LF502)

± 2 % FS

Note: Accuracy is measured when detector and converter are newly combined under the basic operating conditions in the Toshiba calibration facility.

3. Other specifications

- Conductivity: 5 μ S/cm or more
(If detector is partially filled pipes type, conductivity is 100 μ S/cm or more)
- Power supply: 100 to 240VAC (allowable voltage range: 80 to 264VAC, 50/60Hz)^{*1} or 24VDC (allowable voltage range: 21 to 27VDC)^{*2}
- Power consumption: 17W (27VA) or less (when 7th digit of specification code is “A”)
35W (60VA) or less (when 7th digit of specification code is “B”)
30W (50VA) or less (when 7th digit of specification code is “F”)

^{*1} When the 7th digit of specification code is “B” and “F”, power supply is 100 to 120VAC (allowable voltage range is 80 to 132VAC, 50/60Hz)

^{*2} When the 7th digit of specification code is “B” and “F”, 24VDC cannot be selected.

- For partially filled pipes detectors:

Fluid water level range:

Meter size 6”-12” (150-300mm) : Water level 1 1/4(30mm) to state to be filled with water

Meter size 14”-24” (350-600mm) : 10% of meter size to state to be filled with water

Note) State to be filled with water is water level 100%

Necessary straight pipe length:

Upstream side : 10D or more

Downstream side: 5D or more

Note) D is meter size.

● Converter specifications

1. Input signal: Flow rate proportional signal from the detector
2. Output signal: 4 to 20mADC (current signal, load resistance 0 to 1k Ω)
- 3 Digital Input/Output

- Digital Output

Digital Output 1: Output type	Transistor open collector
Number of outputs	1
Capacity	30VDC, 200mA max.

Digital Output 2 (option: added when 9th digit of specification code is “3”) :

Output type	Solid-state contact output
Number of outputs	3
Capacity	150VDC, 150mA max. 150VAC (peak value), 100mA max.

* For digital output function, either of the following functions can be selected.

Digital Output function

- Totalizer pulse output DO1 or DO2 can be selected
(Forward direction pulse and reverse direction pulse can be assigned independently)

In the case of DO1	Pulse rate 3.6 to 3,600,000 pulses/h
Pulse width	Settable within the range of 0.3 to 500ms
In the case of DO2	Pulse rate 3.6 to 360,000 pulses/h
Pulse width	Settable within the range of 4 to 500ms

- Range switching output One Digital Output (DO) is used
 - Single direction, 2-range switching signal
 - Forward/reverse direction switching signal
 Two Digital Outputs (DO) are used
 - Single direction, 4-range switching signals
 - Forward/reverse 2-range switching signals
- High/low limit alarm output

An alarm is output when flow rate goes above or below the set-point value

Setting range -10 to 110% of the settable maximum range

High limit 2 points, low limit 2 points can be set

At the time of alarm output, Normally Open or Normally Closed contact can be selected
- Preset counter output

Contact ON when totalizer count exceeds the set value

Setting range 1 to 99999999 count
- Converter error alarm

An alarm is output when an operation error is detected by self-diagnosis.

At the time of alarm output, Normally Open or Normally Closed contact can be selected
- Digital Input (option: added when 9th digit of specification code is “3”): 2 Digital Inputs

Signal type: Voltage signal of 20 to 30 VDC (H level: 20 to 30 VDC, L level: 2 VDC : or less)

Input resistance: About 2.7 k Ω

* For digital input function, either of the following functions can be selected.

Digital Input function

- Range switching input One Digital Input is used: switching between large and small ranges of forward/reverse, 2-range measurement
Two Digital Inputs are used: switching between ranges of single direction, 4-range measurement
- Totalizer control input Totalizer Start/Stop control or Reset/Start
- Output hold input Fixed with set value for current output and pulse output (loop check)
- Zero adjustment input Performs still water zero adjustment

4. Communication function

- Communication signal: Digital signal is superimposed on 4 to 20mA signal line (conforms to HART*¹ protocol)
 - Load resistance 240 Ω to 1k Ω
 - Load capacitance 0.25 μ F or less
 - Load inductance 4mH or less
- (For maximum cable length, about 2km is a guideline length when CVV-S 1.25mm² is used under standard installation condition.)

*1 HART: “HART” stands for Highway Addressable Remote Transducer and is the name of the communication protocol for industry sensors that is recommended by HCF (HART Communication Foundation).

5. Display/setting items

- Output display: 16-character × 2-line dot-matrix LCD (with back light)
Indicating unit: 2 units can be selected from the flowing units: flow velocity, instantaneous flow rate, total flow (forward/reverse/difference flow), total count, %, custom unit.
- Setting: Various parameters can be set without opening the converter housing using 4 infrared switches (password can be set)
Settable also with AF900 Handheld terminal
- Damping: 0.5 to 60 seconds (settable in increments of 1 second)
- Zero adjustment: Adjustable with infrared switches
- “Field re-verification” **Mag-Prover** – Toshiba’s Zero span calibration tool :
Allows unit to be re-calibrated and verified using internal software program
(for more information contact Toshiba International Corp.)
- Operation at power failure: Various setting values are stored in non-volatile memory.

Current output	0mA
Digital Output	OFF (contact open)
Display	Unlit

6. Other items

- Mass: Approx. 18 lb (8kg) (including a mounting fitting)
- Ambient temperature: -4 to 140 °F (-20 to 60 °C)
(storage temperature: -13 to 149 °F (-25 to 65 °C))
- Arrester: Included in the power supply circuit, current signal output circuit and digital I/O circuit.
- Terminal block structure: 21-pole, screw connection type (M4 screw)
- Housing material: Aluminum alloy
- Painting: Acryl resin baked painting with pearl gray color
- Structure: IP 67
- Cable ports: G (PF) 1/2 female thread with cable connection
Adaptable cable diameter: ϕ 0.433 to 0.512 inch (ϕ 11 to 13mm)
Material: Nylon 66
- Vibration resistance: No resonance point exists when the following vibration is applied:
10 to 55Hz with amplitude of 0.07mm,
No problem occurs when vibration of 30Hz, 29.4m/s² is applied in each direction for 4 hours each.

Note: If the flowmeter is intended to be used in a location where vibration is applied constantly, contact Toshiba.

15.2 Model Number Table

LF232*A, LF232*B Converter model number table

Model number					Specification code							Description	
1	2	3	4	5	6	7	8	9	10	11	12		
L	F	2	3	2									Separate type converter
					A								Purpose Standard
					A								Compatible detector (Note 1) (Note 2) (Note 3) Medium to small size (Meter size: 1/10" to 18" (2.5 to 450mm))
					B								Large size (Meter size 20" to 120" (500 to 3000mm))
						C							Mounting nuts and bolts Panel, wall mounting (BNP material: SUS304)
						E							Pipe mounting (BNP material: SUS304)
								1					Digital input/output Current output + Digital outputs points (1 point)
								3					Current output + Digital outputs points (4 point) + Digital nputs points (2 point)
								1					Communication function HART communication
									1				Power supply 100 to 240VAC, 50/60Hz (Note 2)
									2				24VDC (Note 3)
										A			Standard

- Note 1: For applicable detector code, select one from the following table.
To combine with an existing detector, select one depending on the type of replaceable converters.
For combination with detectors not listed below, contact Toshiba.

Applicable detector code	Applicable detector	Applicable detector (discontinued model)	Replaceable converters
A	LF470 type	334, 335 type (Converters of types shown right)	372, LF200, LF220, LF420, LF230* A type
B	LF150 type	337, 335 type (Converters of types shown right)	373, 378, LF230* B type

- Note 2: When the 7th digit is "B" and power supply specification code is "1", power supply specification is 100 to 120VAC.
- Note 3: 24VDC can be specified only when the 7th digit is "A".

LF232*F (for partially filled pipes detectors) Converter model number table

Model number					Specification code							Description	
1	2	3	4	5	6	7	8	9	10	11	12		
L	F	2	3	2									Separate type converter
					A								Purpose Standard
					F								Compatible detector For Partially-filled pipes (Meter size : 6" to 24" (150mm to 600mm))
						C							Mounting nuts and bolts Panel, wall mounting (BNP material: SUS304)
						E							Pipe mounting (BNP material: SUS304)
								1					Digital input/output Current output + Digital outputs points (1 point)
								3					Current output + Digital outputs points (4 point) + Digital nputs points (2 point)
									1				Communication function HART communication
										1			Power supply 100 to 120VAC, 50/60Hz
											A		Standard

16. Outline Drawing

● Electromagnetic Flowmeter Converter LF232 Type

Gross mass: approx. 18 lb(8kg)
(including a mounting plate)

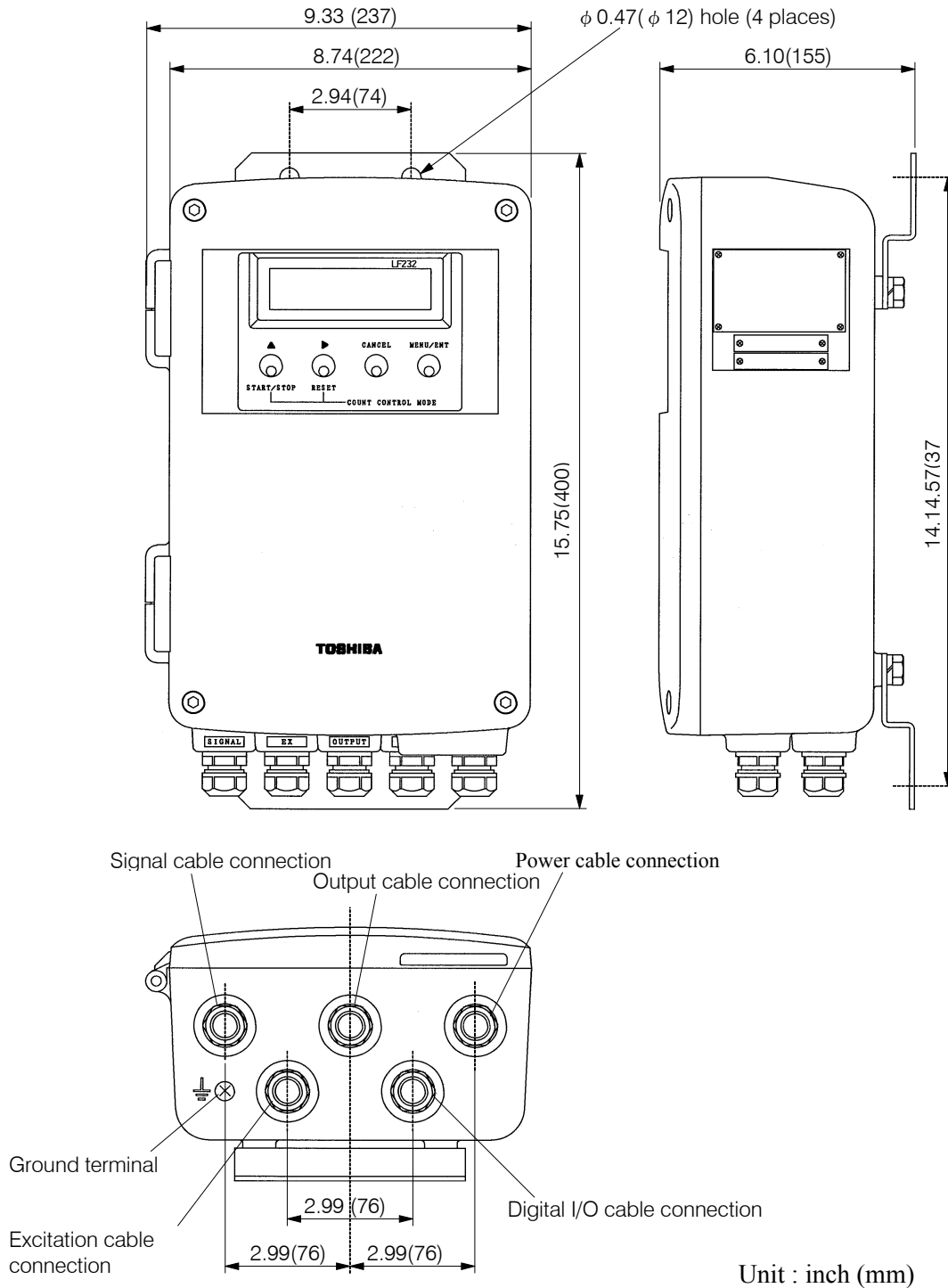

Figure 16.1 Outline of Electromagnetic Flowmeter Converter 232 Type

Write down the address and phone number of the distributor from which you purchased this product, the product code, SER.NO. and so on.

Distributor	Address	_____
	Name	_____
	Phone number	() -
Product code	LF	_____
SER. NO.		_____

TOSHIBA CORPORATION
