

TOSHIBA

Leading Innovation >>>

RV75* Digital Series
SL75* Digital Series
WL75* Digital Series

> IN NEED OF HELP



IF YOU ARE EXPERIENCING
ANY DIFFICULTIES PLEASE VISIT
WWW.TOSHIBA.CO.UK/FAQ



OR CONTACT THE TOSHIBA
CUSTOMER HELPLINE ON
0844 856 0730

REGZA



Contents

INSTALLING YOUR TV

Difference List between RV75, SL75 and WL75 Series	4
Safety Precautions	5
Installation and important information	6
The remote control	7
CT-90344 (for RV series)	7
Inserting batteries and effective range	7
The remote control	8
CT-90345 (for SL/WL series)	8
Inserting batteries and effective range	8

CONNECTING YOUR TV

Connecting external equipment	9
Connecting an HDMI® or DVI device to the HDMI input	10
To connect an HDMI device	10
To connect a DVI device	10
REGZA-LINK connection	11
Connecting a computer	12
To connect a PC to the RGB/PC terminal ...	12
To connect a PC to the HDMI terminal	12
Connecting a home network	13
To connect the TV to a home network	
- Wired	13
To connect the TV to a home network with an internet connection - Wireless	13
Controls and input connections	14
Switching on	14
Using the remote control	14
Using the controls and connections	14

SETTING UP YOUR TV

Startup Application	15
Quick Setup	15
Ant/Cable In (if available)	16
Auto Tuning	17
ATV Manual Tuning	17
Tuning	17
Skip	19
Sorting positions	19
DTV Manual Tuning	20
Manual Tuning	20
Manual Tuning for DVB-C	20
DTV Settings	20
Channels	20
Standby Channel Update	21
DVB Character Set	21
Dynamic Scan	21
Location setting	21
Analogue switch-off	21

CONTROLS AND FEATURES

General controls	22
Quick Menu	22
Selecting positions	22
The Time Display – analogue only	22
Stereo and Bilingual transmissions	22
Sound controls	23
Volume controls and mute sound	23
Dual	23
Balance, Bass and Treble	23
Sound Navi (SL/WL series only)	23
Surround Settings	24
Dolby Volume®	24
Dynamic Range Control	24
Audio Level Offset	24
TV Speakers (SL/WL series only)	24
Headphone Settings	25
Audio Description	25
Widescreen viewing	26
Picture controls	28
Picture Mode	28
Picture preferences	28
Reset	28
3D Colour Management	28
Base Colour Adjustment	29
Colour Temperature	29
Auto Brightness Sensor Settings	29
Active Backlight Control	30
Black/White Level	30
Static Gamma	30
MPEG NR – Noise Reduction	30
DNR – Digital Noise Reduction	30
Resolution+	30
Active Vision M100 (SL series only)	30
Active Vision M200 Pro (WL series only)	31
Film Stabilization (WL series only)	31
Film Stabilization (SL series only)	31
Expert Mode	31
Resetting the advanced picture settings	31
Control Visualization	31
Automatic Format (Widescreen)	32
4:3 Stretch	32
Blue Screen	32
Picture Position	32
Picture still	32
HDMI Information Display	32
Using your home network	33
Setting up the Network	34
Wireless Setup	34

Advanced Network Setup	36	Common Interface	59
DNS Setup	37	Software Upgrade and Licences	60
Network Connection Test	38	Auto Upgrade	60
Using the software keyboard	38	Searching for New Software	60
Setting up the Media Renderer feature	39	Network Upgrade	60
Installation	39	Software Licences	60
Media Renderer	39	System Information and Reset TV	61
Device Name Setup	39	System Information	61
Web Password Setup	40	Reset TV	61
Media Controller Setup	40	PC Settings	61
Maximum Volume Setup	40	Horizontal and Vertical Position	61
Using YouTube™ (WL series only)	41	Clock Phase	61
Using the Function Menu	41	Sampling Clock	62
Using the Media Player	43	Reset	62
Basic operation	44	Input selection and AV connections	62
Viewing photo files	45	Input selection	62
Viewing movie files (on a DLNA CERTIFIED™ Server or USB device)	47	External input skip	63
Playing music files (on a DLNA CERTIFIED™ Server or USB device)	49	Input signal selection	63
Using the Photo Frame feature	50	Labeling video input sources	64
To open Photo Frame	50	Woofer setting	64
Setting the features	51	PC Audio	64
Other features	52	HDMI 3 Audio	64
Panel Lock	52	HDMI Settings	65
TOSHIBA Illumination	52	Digital Audio Output	65
The timers	53	Using REGZA-LINK	66
Programme Timers – digital only	53	Enable REGZA-LINK	66
On Timer	53	TV Auto Power	66
Sleep Timer	54	Auto Standby	66
Energy Saving Settings	54	Amplifier Control	66
Automatic Power Down	54	Speaker Preference	66
No Signal Power Down	54	REGZA-LINK input source selection	66
Digital on-screen information and Programme Guide	55	REGZA-LINK playback device control	67
Information	55	REGZA-LINK one touch play	67
Guide	56	REGZA-LINK system standby	67
Genre selection/searching	56	REGZA-LINK system audio control	67
Digital settings – parental control	57	Toshiba PC compatible with REGZA-LINK	67
Setting the PIN	57	TEXT SERVICES	
Parental Setup	57	Text services	68
Network Lock	57	Selecting modes	68
Digital settings – Channel Options	58	Text information	68
Selecting favourite channels	58	Navigating pages using Auto	68
Favourite Channel Lists	58	Navigating pages using LIST	68
Skip channels	58	Control buttons	69
Locking channels	58	PROBLEM SOLVING	
Digital settings – other settings	59	Questions and Answers	70
Subtitles	59	INFORMATION	
Audio languages	59	License Information	73
		Information	75
		Specifications and accessories	77

Difference List between RV75, SL75 and WL75 Series

Please confirm your TV's specifications in the following table.

NOTE: The model number is on the back of your TV.

Feature	RV75	SL75	WL75
Picture			
Active Vision M100/	—	●	—
Film Stabilization	—	●	—
Active Vision M200 Pro/	—	—	●
Film Stabilization	—	—	●
Sound			
Audyssey EQ	—	●	●
Sound Navi	—	●	●
Panel Spec.			
LED Back Light	—	●	●
Terminal			
MP3 Player (USB)	—	—	●
DivX Player (USB)	—	—	● (SD)
SD Card Slot (Photo Viewer)	—	●	●
Variable Woofer Out	—	●	●
Variable Audio Out	—	●	●
YouTube for TV	—	—	●
TOSHIBA Dual Band WLAN Adaptor WLM-10U2 with Gooseneck Cable	Not supplied	Not supplied	Supplied
Remote Control	CT-90344	CT-90345	CT-90345

NOTE: The illustrations of the menu display in this manual show the WL753 as an example.

Safety Precautions

This equipment has been designed and manufactured to meet international safety standards, but like any electrical equipment, care must be taken to obtain the best results and for safety to be assured. Please read the points below for your own safety. They are of a general nature and are intended to help with all electronic consumer products. Some points may not apply to the goods you have just purchased.

Air Circulation

Leave more than 10cm clearance around the television to allow adequate ventilation. This will prevent overheating and possible damage to the television. Dusty places should also be avoided.

Heat Damage

Damage may occur if the television is left in direct sunlight or near a heater. Avoid places subject to extremely high temperatures or humidity. Place in a location where the temperature remains between 5°C (41°F) min. and 35°C (94°F) max.

Mains Supply

The mains supply required for this equipment is 220-240v AC 50/60Hz. Never connect to a DC supply or any other power source. DO ensure that the television is not standing on the mains lead. Use only the supplied lead.

DO NOT cut off the mains plug from this equipment. The plug incorporates a special Radio Interference Filter, the removal of which will impair its performance.

In the UK, the fuse fitted in the plug is approved by ASTA or BSI to BS1362. It should only be replaced by a correctly rated and approved type and the fuse cover must be refitted.

IF IN DOUBT, PLEASE CONSULT A COMPETENT ELECTRICIAN.

Do

DO read the operating instructions before you attempt to use the equipment.

DO ensure that all electrical connections (including the mains plug, extension leads and inter-connections between pieces of equipment) are properly made and in accordance with the manufacturers' instructions. Switch off and withdraw the mains plug before making or changing connections.

DO consult your dealer if you are ever in doubt about the installation, operation or safety of your equipment.

DO be careful with glass panels or doors on equipment.

DO NOT REMOVE ANY FIXED COVERS AS THIS WILL EXPOSE DANGEROUS AND 'LIVE' PARTS.

THE MAINS PLUG IS USED AS A DISCONNECTING DEVICE AND THEREFORE SHOULD BE READILY OPERABLE.

Do not

DO NOT obstruct the ventilation openings of the equipment with items such as newspapers, tablecloths, curtains, etc. Overheating will cause damage and shorten the life of the equipment.

DO NOT allow electrical equipment to be exposed to dripping or splashing or objects filled with liquids, such as vases, to be placed on the equipment.

DO NOT place hot objects or naked flame sources, such as lighted candles or nightlights, on or close to equipment. High temperatures can melt plastic and lead to fires.



WARNING: To prevent the spread of fire, keep candles or other open flames away from this product at all times.

DO NOT use makeshift stands and NEVER fix legs with wood screws. To ensure complete safety, always fit the manufacturers' approved stand, bracket or legs with the fixings provided according to the instructions.

DO NOT leave equipment switched on when it is unattended, unless it is specifically stated that it is designed for unattended operation or has a standby mode. Switch off by withdrawing the plug, and make sure your family knows how to do this. Special arrangements may need to be made for people with disabilities.

DO NOT continue to operate the equipment if you are in any doubt about it working normally, or it is damaged in any way – switch off, withdraw the mains plug and consult your dealer.

WARNING – excessive sound pressure from earphones or headphones can cause hearing loss.

ABOVE ALL – NEVER let anyone, especially children, push or hit the screen, push anything into holes, slots or any other openings in the case.

NEVER guess or take chances with electrical equipment of any kind – it is better to be safe than sorry.

Installation and important information

Where to install

Locate the television away from direct sunlight and strong lights, soft, indirect lighting is recommended for comfortable viewing. Use curtains or blinds to prevent direct sunlight falling on the screen.

Place the TV on a stable, level surface that can support the weight of the TV. In order to prevent injury and maintain stability of this apparatus, secure the TV to the level surface using the strap if fitted, or to a wall using a sturdy tie to the P clips provided.

The LCD display panels are manufactured using an extremely high level of precision technology; however, sometimes some parts of the screen may be missing picture elements or have luminous spots. This is not a sign of a malfunction.

Make sure the television is located in a position where it cannot be pushed or hit by objects, as pressure will break or damage the screen. Also please be certain that small items cannot be inserted into slots or openings in the case.

Cleaning the screen and cabinet...

Turn off the power, and clean the screen and cabinet with a soft, dry cloth. We recommend that you **do not** use any proprietary polishes or solvents on the screen or cabinet as this may cause damage.

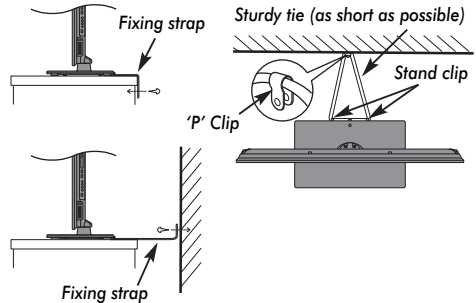

Stand style is dependent on model

Please take note

The digital reception function of this television is only effective in the countries listed in the "Country" section of the "SETUP" menu. Depending on country/area, some of this television's functions may not be available. Reception of future additional or modified services can not be guaranteed with this television.

If stationary images generated by 4:3 broadcasts, text services, channel identification logos, computer displays, video games, on screen menus, etc. are left on the television screen for any length of time, they could become conspicuous. It is always advisable to reduce both the brightness and contrast settings.

Very long, continuous use of the 4:3 picture on a 16:9 screen may result in some retention of the image at the 4:3 outlines. This is not a defect of the LCD TV and is not covered under the manufacturer's warranty. Regular use of other size modes (eg: Super Live) will prevent permanent retention.

EXCLUSION CLAUSE

Toshiba shall under no circumstances be liable for loss and/or damage to the product caused by:

- i) fire;
- ii) earthquake;
- iii) accidental damage;
- iv) intentional misuse of the product;
- v) use of the product in improper conditions;
- vi) loss and/or damage caused to the product whilst in the possession of a third party;
- vii) any damage or loss caused as a result of the owner's failure and/or neglect to follow the instructions set out in the owner's manual;
- viii) any loss or damage caused directly as a result of misuse or malfunction of the product when used simultaneously with associated equipment;

Furthermore, under no circumstances shall Toshiba be liable for any consequential loss and/or damage including but not limited to the following: loss of profit, interruption of business, the loss of recorded data whether caused during normal operation or misuse of the product.

NOTE: A Toshiba wall bracket or stand, where available, must be used to maintain the product's BEAB approval.

The remote control

CT-90344 (for RV series)

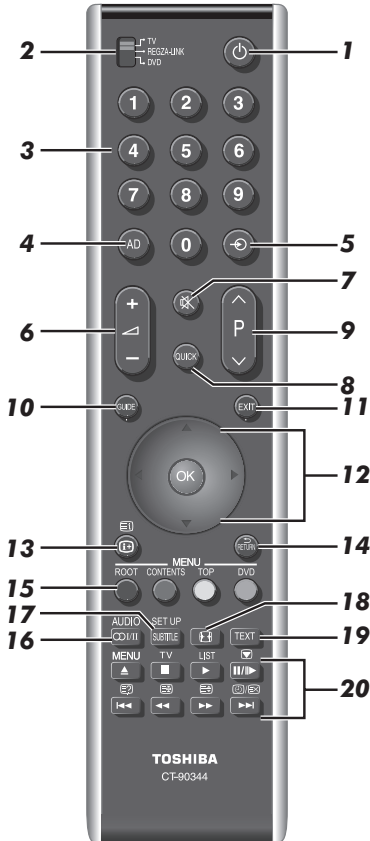

- 1 For On/Standby mode (T/R/D)*
- 2 To select device mode (T/R/D)
- 3 Number buttons (T/R/D)
- 4 Switch the Audio Description On/Off (T)
- 5 To select external input sources (T/R/D)
- 6 To alter the TV volume (T/R/D)
- 7 To mute the TV sound (T/R/D)
- 8 To access Quick Menu (T)
- 9 To change programme positions (T/R)
To change text pages (T)
- 10 To display the digital on-screen Programme Guide (T)
- 11 To exit menus (T)
- 12 When using menus, the arrows move the cursor on the screen up, down, left or right. Press **OK** to confirm your selection (T/R/D)

- 13 To display on-screen information (T/R/D)
To access index page in Text mode (T)
- 14 To return to previous menu (T/R/D)
- 15 **Colour buttons** Text and interactive service control buttons (T)
ROOT To display Root menu (R)
CONTENTS To display Contents menu (R)
TOP To access Top Menu (R/D)
DVD DVD menus (R/D)

- 16 **STEREO/II** Stereo/bilingual transmissions (T)
AUDIO To access Audio menu (R/D)
- 17 **SUBTITLE** Digital Subtitles or Analogue TEXT Subtitle pages if available (T)
SET UP To access Setup menu (R/D)

- 18 Widescreen viewing (T/R/D)

- 19 To call up text services (T)
[?] **[E]** **[S]** **[C]** **[X]** are available

20 When in TV mode:

- MENU** On-screen menus
- TV** To switch between ATV (analogue television) and DTV (digital television)
- LIST** To access the analogue or digital Channel List
Picture still
[C] **[X]** Analogue time display

When using the Programme Guide:

- [<<]** (- 24 hours) / **[>>]** (+ 24 hours)
- [<<<]** (- 1 page) / **[>>>]** (+ 1 page)

REGZA-LINK or DVD mode:

- [▲]** (EJECT) / **[■]** (STOP) / **[▶]** (PLAY) / **[||/II]** (PAUSE/STEP)
- [<<<]** (SKIP-BACK) / **[<<]** (REWIND) / **[>>>]** (FAST FORWARD) / **[>>]** (SKIP-FORWARD)

* T=TV mode, R=REGZA-LINK mode, D=DVD mode

Inserting batteries and effective range

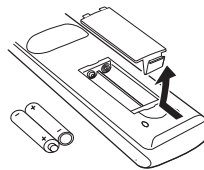

Remove the back cover to reveal the battery compartment and make sure the batteries are inserted the proper way. Suitable battery types for this remote are AAA, IEC R03 1.5V.

Do not combine a used, old battery with a new one or mix

battery types. Remove dead batteries immediately to prevent acid from leaking into the battery compartment. Dispose of them in accordance with instructions on page 74 of this manual. **Warning:** batteries must not be exposed to excessive heat such as sunshine, fire or the like.

The performance of the remote control will deteriorate beyond a distance of five metres or outside an angle of 30 degrees from the centre of the television. If the operating range becomes reduced, the batteries may need replacing.

The remote control

CT-90345 (for SL/WL series)

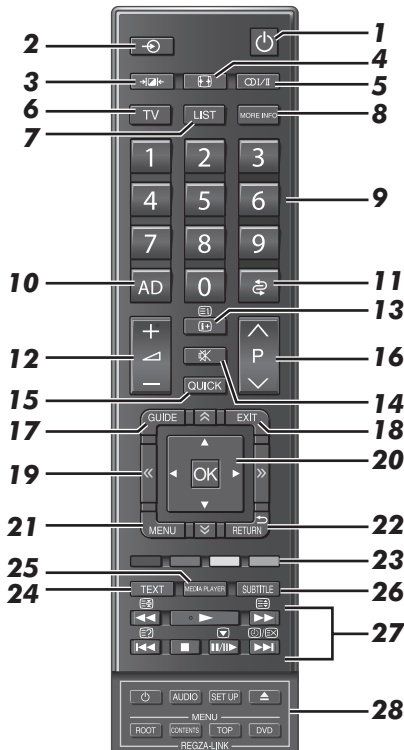

- 1 For On/Standby mode
- 2 To select external input sources
- 3 Selectable Picture preferences
- 4 Widescreen viewing
- 5 Stereo/bilingual transmissions
- 6 To select TV Mode
- 7 To access the analogue or digital Channel List
- 8 To access More Information Menu
- 9 Number buttons
- 10 Switch the Audio Description On/Off
- 11 To return to previous programme position
- 12 To alter the TV volume
- 13 To display on-screen information
To access the index page in Text mode
- 14 To mute the TV sound
- 15 To access Quick Menu
- 16 To change programme positions
To change TEXT pages
- 17 To display the digital on-screen Programme Guide

- 18 To exit menus
- 19 To page up, down, left or right
- 20 When using menus, the arrows move the cursor on the screen up, down, left or right. Press to confirm your selection
- 21 On-screen Menus
- 22 To return to previous Menu
- 23 **Colour buttons:** Text and interactive service control buttons
- 24 To call up text services
- 25 To access Media Player Menu
- 26 Digital Subtitles or Analogue TEXT Subtitle pages if available
- 27 **When in TV mode:**
 - Picture still
 - Analogue time display
- When in Text mode:**
 - To reveal concealed text
 - To hold a wanted page
 - To enlarge text display size
 - To select a page whilst viewing a normal picture
- When using Programme Guide:**
 - 24 hours
 - + 24 hours
 - 1 page
 - + 1 page
- During Playback:**
 - To PLAY
 - To STOP
 - To PAUSE/STEP
 - To SKIP-BACK
 - To REWIND
 - To FAST FORWARD
 - To SKIP-FORWARD
- 28 **When using REGZA-LINK:**
 - To turn On/Standby
 - AUDIO** To access **AUDIO** Menu
 - SET UP** To access **SET UP** Menu
 - To EJECT
 - ROOT** To access **ROOT** Menu
 - CONTENTS** To access **CONTENTS** Menu
 - TOP** To access **TOP** Menu
 - DVD** To access **DVD** Menu

Inserting batteries and effective range

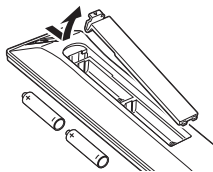

Remove the back cover to reveal the battery compartment and make sure the batteries are inserted the proper way. Suitable battery types for this remote are AAA, IEC R03 1.5V.

Do not combine a used, old battery with a new one or mix

battery types. Remove dead batteries immediately to prevent acid from leaking into the battery compartment. Dispose of them in accordance with instructions on page 74 of this manual. **Warning:** batteries must not be exposed to excessive heat such as sunshine, fire or the like.

The performance of the remote control will deteriorate beyond a distance of five metres or outside an angle of 30 degrees from the centre of the television. If the operating range becomes reduced, the batteries may need replacing.

Connecting external equipment

Before connecting any external equipment, turn off all main power switches. If there is no switch, remove the mains plug from the wall socket.

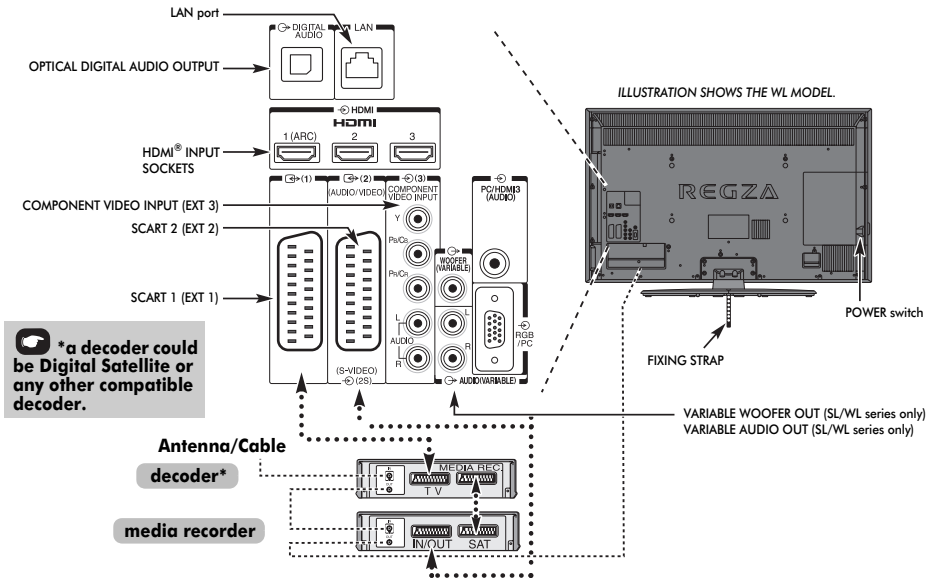

Aerial cables:

Connect the aerial to the socket on the rear of the television. If you use a decoder* and/or a media recorder, it is essential that the aerial cable is connected through the decoder and/or through the media recorder to the television.

SCART leads:

Connect the video recorder **IN/OUT** socket to the television. Connect the decoder **TV** socket to the television. Connect the media recorder **SAT** socket to the decoder **MEDIA REC.** socket.

Before running **Auto Tuning**, put your decoder and media recorder to **Standby**.

The phono sockets alongside the COMPONENT VIDEO INPUT sockets will accept L and R audio signals.

The Digital Audio Output socket enables the connection of a suitable surround sound system. **NOTE: this output is always active.**

HDMI® (High-Definition Multimedia Interface) is for use with a DVD decoder or electrical equipment with digital audio and video output.

For acceptable video or PC signal formats through the HDMI terminals, see page 76.

NOTE: Although this television is able to connect to HDMI equipment, it is possible that some equipment may not operate correctly.

LAN port is used to connect the TV to your home network. This TV can play digital content stored on a DLNA CERTIFIED™ product with server function.

A wide variety of external equipment can be connected to the back of the television; therefore, the relevant owner's manuals for all additional equipment must be referred to for exact instructions.

We recommend **SCART 1** for a decoder and **SCART 2** for a media recorder.

If connecting S-Video equipment, set **EXT 2** Input mode to **S-VIDEO**. See page 63.

The **VARIABLE AUDIO OUT** sockets allow you to listen to your TV's audio through your audio system.

The **VARIABLE WOOFER OUT** socket allows you to connect an external Sub-Woofers.

If the television automatically switches over to monitor external equipment, return to normal television by pressing the desired programme position button. To recall external equipment, press  to select between **DTV**, **EXT 1**, **EXT 2**, **EXT 3**, **EXT 4**, **HDMI 1**, **HDMI 2**, **HDMI 3**, **HDMI 4**, **PC** or **ATV**.

When the external input mode is selected while viewing DTV mode, the SCART socket does not output video/audio signals.

Connecting an HDMI® or DVI device to the HDMI input

The HDMI input on your television receives digital audio and uncompressed digital video from an HDMI source device or uncompressed digital video from a DVI (Digital Visual Interface) source device.

This input is designed to accept HDCP (High-Bandwidth Digital-Content Protection) programme material in digital form from EIA/CEA-861-D-compliant ^[1] consumer electronic devices (such as a set-top box or DVD player with HDMI or DVI output). For acceptable video signal formats, see page 76.

NOTE:

- Some early HDMI equipment may not work properly with your latest HDMI TV, due to the adoption of a new standard. Please unplug your HDMI cable first and then try setting the **INSTAPORT™** and **Enable Content Type** options to "Off". Your early HDMI source should operate properly with your television. See page 65.
- Supported Audio format: Linear PCM, sampling rate 32/44.1/48kHz.

To connect an HDMI device

Connect an HDMI cable (type A connector) to the HDMI terminal.

For proper operation, it is recommended that you use an HDMI cable with the HDMI Logo ().

- If your HDMI connection is capable of 1080p and/or your television is capable of refresh rates greater than 50Hz, you will need a Category 2 cable. Conventional HDMI/DVI cable may not work properly with this mode.
- HDMI cable transfers both video and audio. Separate analogue audio cables are not required (see illustration).
- See "HDMI 3 Audio" on page 64.

The HDMI 4 terminal is located on the side of the television.

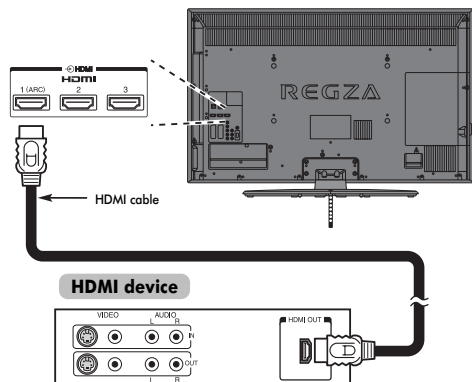

To view the HDMI device video, press the  button to select HDMI 1, HDMI 2, HDMI 3 or HDMI 4 mode.

To connect a DVI device

Connect an HDMI-to-DVI adaptor cable (HDMI type A connector) to the HDMI 3 terminal and audio cables to the PC/HDMI 3 (AUDIO) socket (see illustration).

- The recommended HDMI-to-DVI adaptor cable length is 6.6 ft (2m).
- An HDMI-to-DVI adaptor cable transfers video only. Separate analogue audio cables are required.
- See "HDMI 3 Audio" on page 64.

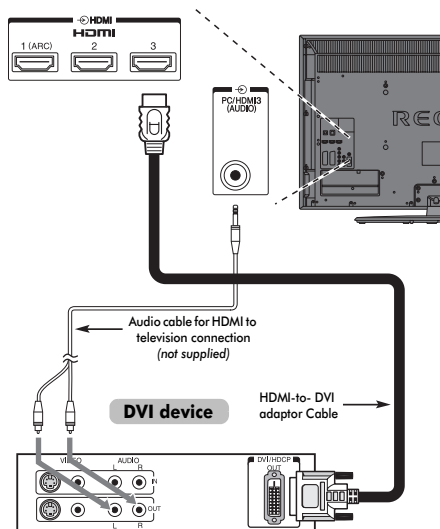

NOTE:

To ensure that the HDMI or DVI device is reset properly, it is recommended that you follow these procedures:

- When turning on your electronic components, turn on the television first, and then the HDMI or DVI device.
- When turning off your electronic components, turn off the HDMI or DVI device first, and then the television.

REGZA-LINK connection

You can control the basic functions of connected audio/video devices using the television's remote control if you connect a REGZA-LINK compatible AV amplifier or playback device. For an explanation of setup and operations, see pages 66–67.

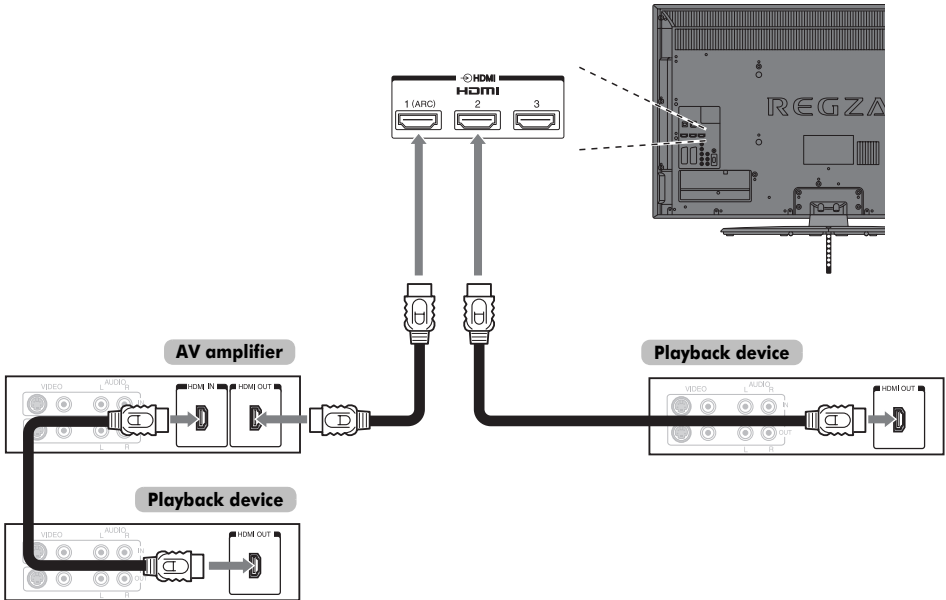

For the setup shown above, you will need three HDMI cables.

NOTE:

- If several devices are connected, the REGZA-LINK feature may not operate properly.
- For proper operation, it is recommended that you use HDMI cables with the HDMI Logo (HDMI).
- The HDMI 4 terminal is located at the side of the television.
- This function is available with one PC and one AV amplifier. This function is available when one PC and one AV amplifier are connected separately. However, it may not operate properly if the PC is connected via the AV amplifier.

Before controlling the device(s):

- After completing the above connections, set the REGZA-LINK Setup menu as you desire (see page 66).
- The connected devices must also be set. For details, see the operation manual for each device.
- The REGZA-LINK feature uses CEC technology as regulated by the HDMI standard.
- This feature is limited to models incorporating Toshiba's REGZA-LINK. However, Toshiba is not liable for those operations. Refer to individual instruction manuals for compatibility information.

Connecting a computer

With either an RGB/PC or an HDMI connection, you can watch your computer's display on the television and hear the sound from the television's speakers.

To connect a PC to the RGB/PC terminal

When connecting a PC to the RGB/PC terminal on the television, use an analogue RGB (15-pin) computer cable and a PC audio cable for the PC/HDMI 3 (AUDIO) socket. Select **PC** from the **PC/HDMI 3 Audio** options in the **AV Connection** menu located in the **SETUP** menu.

the back of your television

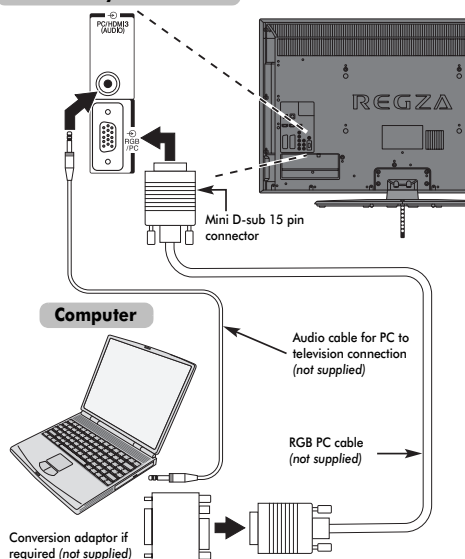

To use a PC, set the monitor output resolution on the PC before connecting it to the television. For acceptable PC signal formats, see page 75.

To display the optimum picture, use the PC setting feature (see page 61).

NOTE:

- The PC audio input terminal on the television is shared with the HDMI 3 analogue audio input terminal (see page 64).
- Some PC models cannot be connected to this television.
- An adaptor is not needed for computers with a compatible mini D-sub 15-pin terminal.
- Depending on the DVD's title and the specifications of the PC on which you are playing the DVD-Video, some scenes may be skipped or you may not be able to pause during multi-angle scenes.
- A band may appear at the edges of the screen or parts of the picture may be obscured. This is due to scaling of the picture by the set, it is not a malfunction.

- When PC input mode is selected, some of the television's features will be unavailable e.g. **Colour System** in the **SETUP** menu.
- If connecting a certain PC model with a unique PC signal, the PC signal may not be detected correctly.

To connect a PC to the HDMI terminal

When connecting a PC to the HDMI terminal on the television, use an HDMI-to-DVI adaptor cable and an analogue audio cable.

If connecting a PC with an HDMI terminal, use an HDMI cable (type A connector). A separate analogue cable is not necessary.

the back of your television

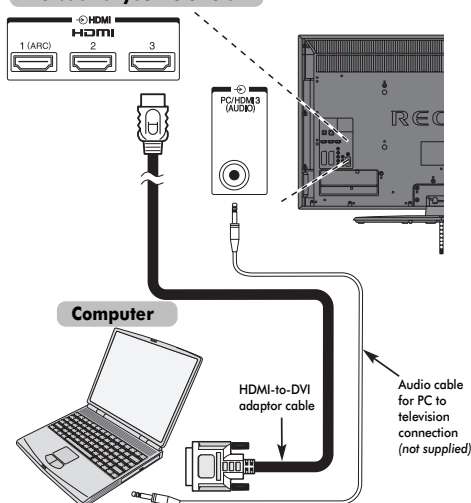

For acceptable PC and video signal formats, see page 76.

NOTE:

- The edges of the images may be hidden.
- If connecting a certain PC model with a unique PC signal, the PC signal may not be detected correctly.

Connecting a home network

The LAN port allows your Toshiba TV to connect to your home network. You can use this revolutionary home entertainment networking system to access photo, video and audio files that are stored on a DLNA CERTIFIED™ server and play/display them on your TV.

NOTE:

- If you connect to a shared-network outside your home, please use the router, and use DLNA in a private network environment.
- If you use a Hub or switch to connect the TV to your home network, you may not be able to use the automatic setup and will have to manually set up the network address. See page 37.
- If you use a router with built-in DHCP functionality, use the automatic setup. Manual setup may not work.
- If you connect the TV and PC directly, use a crossover LAN cable.

To connect the TV to a home network - Wired

the back of your television

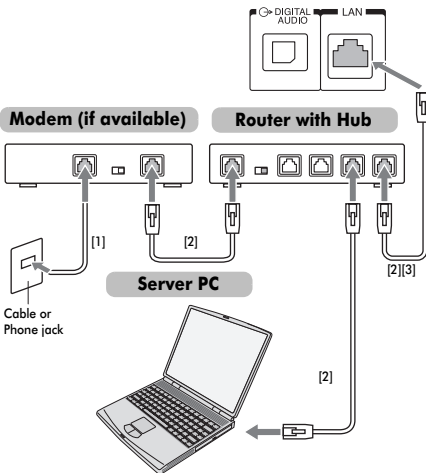

[1] Coaxial or telephone cable (depending on your modem type)

[2] Standard LAN cable

[3] Do NOT connect a phone jack directly to the TV's LAN port.

To connect the TV to a home network with an internet connection - Wireless

Please refer to "Wireless Setup" section on page 34.

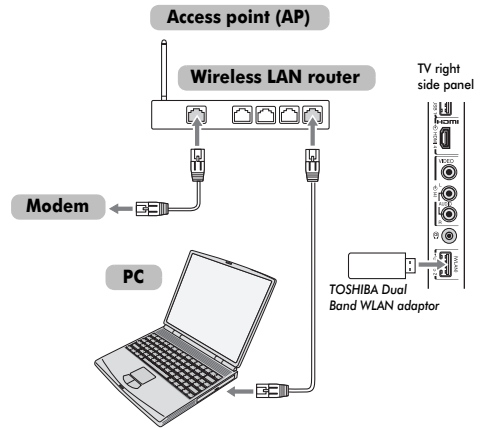

If you use the Gooseneck cable to connect the WLAN adaptor;

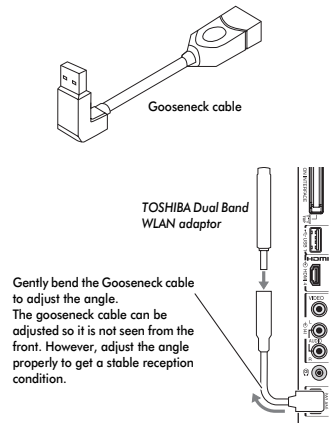

The transmission speed over the wireless LAN and the distance over which wireless LAN can reach may vary depending on surrounding electromagnetic environment, obstacles, access point design and configuration, and client design and software/hardware configurations. The actual transmission speed will be lower than the theoretical maximum speed.

Controls and input connections

A wide variety of external equipment can be connected to the input sockets on the side of the television. Whilst all the necessary adjustments and controls for the television are made using the remote control, the buttons on the television may be used for some functions.

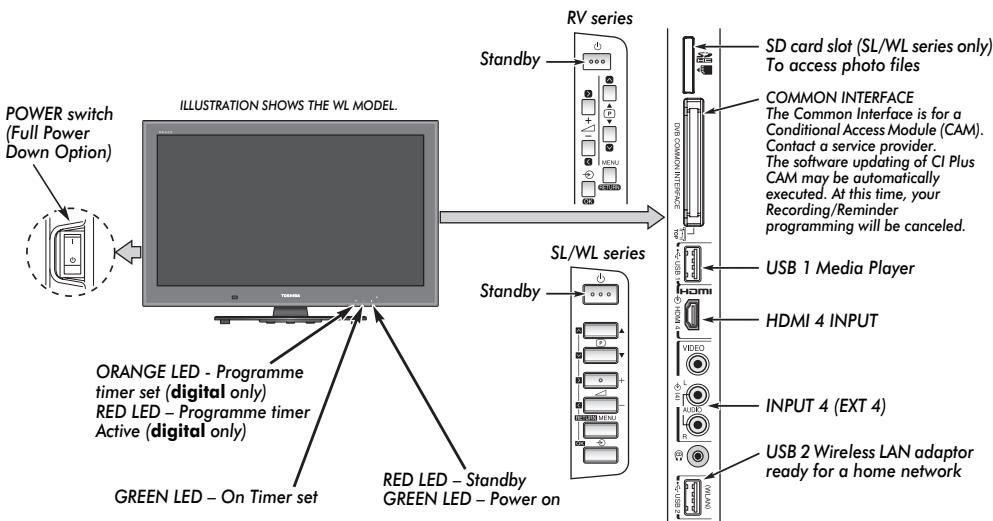

Switching on

If the RED LED is not lit, check that the mains plug is connected to the power supply and press the \odot /I (POWER) button on the left side of the television to switch the television on. If the picture does not appear, press \odot on the remote control; it may take a few moments. The GREEN LED will be lit.

To put the television into Standby, press \odot on the remote control. To view the television, press \odot again. The picture may take a few seconds to appear.

For energy saving:

We recommend that you use the television with the factory settings. The factory settings are for energy saving. Turning the television off at its mains supply, or un-plugging it, will cut energy use to nearly zero for all televisions. This is recommended when the television is not being used for a long time, e.g. when on holiday. Reducing the brightness of the screen will reduce energy use. Energy efficiency cuts energy consumption and thus saves money by reducing electricity bills.

NOTE: Putting the television into standby mode, will reduce energy consumption, but will still draw some power.

Using the remote control

Press **MENU** on the remote control to display the menu.

The menu appears as a list of five topics. As each symbol is selected by pressing \blacktriangleleft or \blacktriangleright on the remote control, its respective options will appear below.

NOTE: The same menu is displayed in DTV (Digital TV) and ATV (Analogue TV) modes; however, where some items are not available in a mode, they will appear greyed out.

To use the option, press \blacktriangle and \blacktriangledown on the remote control to move up and down and press \blacktriangleleft or \blacktriangleright to select your desired setting. Follow the on-screen instructions. The functions of each menu are described in detail throughout the manual.

Using the controls and connections

To alter the volume press $-$ \triangle $+$.

To alter the programme position press \blacktriangledown **P** \blacktriangle .

Press **MENU** and \blacktriangleleft , \blacktriangleright , \wedge or \vee to control the sound and picture options.

Press **MENU** to finish.

The Media Player feature provides access to photo files stored on a USB storage device or SD memory card.

For WL series only, the Media Player feature allows for music and movies to be played from USB 1.

NOTE: The USB socket has limited functionality and Toshiba can take no responsibility for damage to other connected equipment.

The USB 2 socket has to be used with the "TOSHIBA Dual Band WLAN Adaptor WLM-10U2" in order to access a wireless network.

You must use the TOSHIBA Wireless LAN device to ensure correct operation of this feature. This feature is available only when the "TOSHIBA Dual Band WLAN Adaptor" is used.

NOTE: As of May 2010, the TOSHIBA Dual Band WLAN Adaptor is not licensed to be sold in Russia.

To select an external input, press \odot until the appropriate input source is selected.

Please always refer to the owner's manual of the equipment to be connected for full details.

Startup Application

Before switching on the television, put your decoder and media recorder, if applicable, to **Standby**. To set up the television, use the buttons on the remote control as detailed on page 7.

Quick Setup

- 1 Press the **⏻** button. The **Menu Language** screen will appear. This screen will appear the first time that the television is switched on and each time **Reset TV** is selected.
- 2 Press **▲**, **▼**, **◀**, or **▶** to select the menu language, and then press **OK**.
- 3 Highlight **Country** and **◀** or **▶** to select. The television is now set to tune the stations for your country.

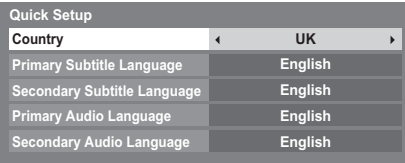

NOTE:

- The following display menus will differ slightly according to the country you selected.
- If there is not a country that you want to select in the list, select **Others**.

- 4 Press **OK**, and the **Location** screen will appear.

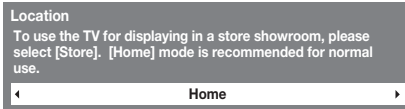

- 5 Press **◀** or **▶** to select **Home** or **Store**. For normal home use, select **Home**.
- 6 Press **OK**. If **Store** is selected in step 5, a **Store mode** confirmation window will appear. If you select **Yes** from that window, the TV will proceed to the **Auto Demo** setup screen.

- 7 Press **OK**, and the **TV Mounting** screen will appear, press **◀** or **▶** to select **Stand** or **Wall**.



- 8 Press **OK**, and the **AutoView** screen will appear, press **◀** or **▶** to select **Yes** or **No**.

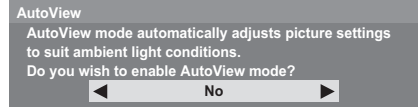

- 9 Press **OK**. If the **Ant/Cable** screen appears, press **▲** or **▼** to select **Antenna** or **Cable**, and then press **OK** to check (✓).

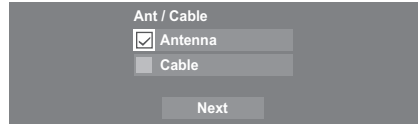

- 10 Select **Next** and press **OK**. The **Auto Tuning** start up screen will appear with the option to select between **DTV and ATV**, **DTV** or **ATV** if available. Use **◀** or **▶** to select the appropriate mode.

- 11 Press **▲** or **▼** to highlight **Start Scan**, and then press **OK**.

The television will start to search for available **DTV** and/or **ATV** channels. The progress bar will indicate the scan status.

You must allow the television to complete the search.

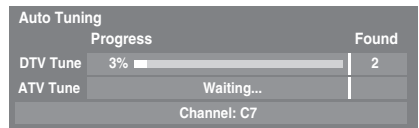

When the search is complete, the television will automatically select position one.

The **Auto Tuning** screen will display the total number of services found.

- 12 Press **◀** or **▶** to view the **DTV** (digital channel) or **ATV** (analogue channel) lists.

- 13 Use ▲ or ▼ to move through the list to select a channel, and then press (OK) to view.

In **ATV** mode, some areas may receive duplicate stations. There may not be a clear picture or the signal may be weak, so the station order can be changed using **ATV Manual Tuning**.

REMEMBER: Press **TV** at any time to select between **ATV** and **DTV** (DTV TV/DTV RADIO/DTV TEXT if available) modes.

NOTE: The time will be set automatically by transmission but can be advanced or decreased by using **Local Time Setting** in the **DTV Settings** screen.

PLEASE NOTE

The **Reset TV** menu can also be accessed at any time from the **SETUP** menu.

Ant/Cable In (if available)

From this menu, you can set the RF input configuration to cable.

- 1 Press **MENU**, and select **SETUP** menu.
- 2 Use ▼ to highlight **Ant/Cable In** and use ◀ or ▶ to select **Antenna** or **Cable**.
NOTE: When you attempt to change the **Ant/Cable In** setting, a warning message will appear followed by PIN entry (if PIN has been set) and a prompt for **Auto Tuning**.
- 3 When **Ant/Cable In** is set to **Cable**, the following setting options will be provided in the **Auto Tuning** screen.

Press ▲ or ▼ to select an item, and then press ◀ or ▶ to select your desired option.

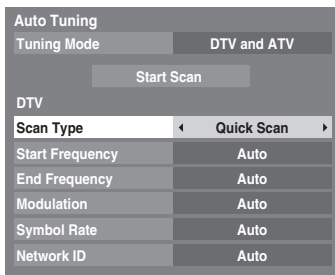

With the exception of **DTV Scan Type** and **DTV Modulation** items, all of the following items will have 2 operating modes. The first is **Auto** where the values for each item are preset by the system. The second is an **Input** mode where you will be able to enter a single value in place of the pre-set value. If no channel is currently tuned and the **Input** state is chosen, a system default value will be shown. However, if a channel is currently tuned when the item is accessed, the value of the current channel will be displayed.

DTV Scan Type:

This item determines whether a **Quick Scan** or a **Full Scan** will be executed. The **Quick Scan** is a simplified version of the **Full Scan** that is designed to complete in less time.

DTV Start Frequency:

This sets the frequency from which the scan will begin.

DTV End Frequency:

This sets the frequency at which the scan will end.
* Valid entry range for frequency items is 113.000-858.00 for C-Book/Other and 114.000-858.00 for Nordig-C. If numbers outside of this range are entered, the values will automatically be set to the min. or max. valid value as appropriate.

DTV Modulation:

You can choose from five QAM modulation settings.

DTV Symbol Rate:

This is the baud rate (KS/s) of the scan.
* Valid entry range for Symbol Rate is 4000-7200. If a number outside of this range is entered, the value will be automatically set to the min. or max. valid value as appropriate.

DTV Network ID:

This is the Network ID to be utilized for the scan. This item is greyed out when DTV Scan Type is set to "Full Scan".
* Valid entry range for Network ID is 1-65535. If a number outside of this range is entered, the value will be automatically set to the min. or max. valid value as appropriate.

Auto Tuning

NOTE: As new services are broadcast, it will be necessary to re-tune the television in order to view them.

Auto Tuning will completely re-tune the television and can be used to update the channel list. **It is recommended that Auto Tuning is run periodically to ensure that all new services are added.** All current channels and settings, i.e. locked channels, will be lost.

- 1 Press **MENU** and use ◀ or ▶ to select **SETUP** menu. Use ▼ to highlight **Auto Tuning**. Press **OK**.

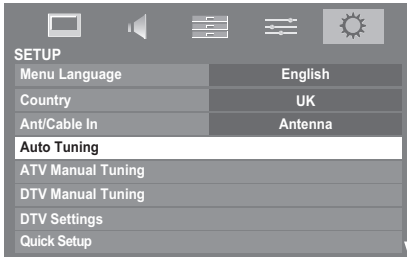

- 2 A screen will appear warning that previous programmes and settings will be deleted.

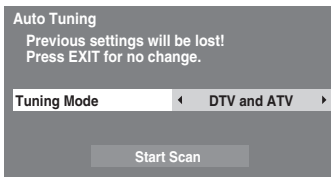

Use ◀ or ▶ to select **DTV and ATV**, **DTV** or **ATV**, if available, then highlight **Start Scan** and press **OK** to continue with the **Auto Tuning**.

NOTE: If you have selected "Others" for the **Country** field in the **SETUP** menu, and selected a tuning mode other than "**DTV**", choose the optimum ATV broadcasting system (B/G, I, D/K or L).

The television will start to search for all available DTV and/or ATV services.

You must allow the television to complete the search.

When the search is complete, the **Auto Tuning** screen will display the services found.

- 3 Use ▼ or ▲ to move through the list to select a channel, and then press **OK** to view.

ATV Manual Tuning

Tuning

The television can be tuned-in manually using **ATV Manual Tuning**. For example, you might use the feature if the television cannot be connected to a media recorder/decoder with a SCART lead or when you want to tune-in a station on another **System**.

Use ◀ and ▶ to move across the screen and select any of the ATV Manual Tuning options. Then use ▲ or ▼ to adjust the settings.

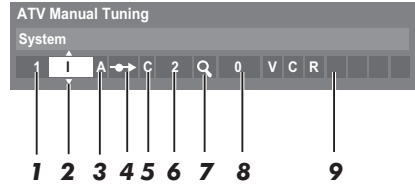

- 1 **Position**
The number to be pressed on the remote control to tune the channel.
 - 2 **System**
Specific to certain areas.
 - 3 **Colour System**
Factory set to Auto, should only be changed if problems are experienced, i.e. NTSC input from external source.
 - 4 **Skip**
Set Skip to On (☞) or Off (☜) for the selected channel. See page 19
 - 5 **Signal Class**
The channel classification.
 - 6 **Channel**
The channel number on which a station is being broadcast.
 - 7 **Search**
Search up and down for a signal.
 - 8 **Manual Fine Tuning**
Only used if interference/weak signal is experienced. See page 70.
 - 9 **Station**
Station identification. Use the ▲ or ▼ and ◀ or ▶ buttons to enter up to seven characters.
- To allocate a position on the television for a decoder and media recorder: turn the decoder on, insert a pre-recorded film in the media recorder, press **PLAY**, and then manually tune.

- 1 Press **MENU** and use ◀ or ▶ to select the **SETUP** menu. Press ▼ to highlight **ATV Manual Tuning** and press **OK** to select.

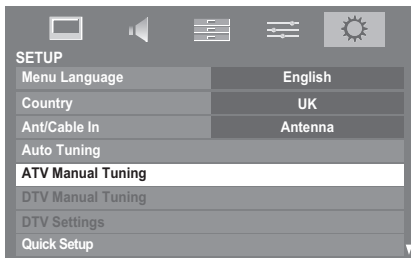

- 2 Use ▲ or ▼ to highlight the desired position. We suggest **Pos. 0** for a media recorder.

Pos.	Channel	Station
1	C2	
2	S10	
3	C7	
4	S40	
5	C22	
6	C25	
7	C28	
8	C30	

Different **Channel** numbers may be displayed.

- 3 Press **OK** to select. If the channel chosen for the media recorder is set to skip, Skip should be removed before storing.
- 4 Press ▶ to select **System** and use ▲ or ▼ to change if required.



- 5 Then press ▶ to select **Search**.
- 6 Press ▲ or ▼ to begin the search. The search symbol will flash.



- 7 Each signal will show on the television. If it is not your media recorder, press ▲ or ▼ again to restart the search.

- 8 When your media recorder signal is found, press ▶ to move along to **Station**. Use ▲, ▼, ◀ and ▶ to put in the required characters, e.g. **VCR**.



- 9 Press **OK** to save.
- 10 Repeat for each **position** you want to tune, or press **RETURN** to return to the list of channels and select the next number to tune.
- 11 Press **EXIT** when you have finished.

PLEASE NOTE

This television has direct channel entry if the channel numbers are known. Select the **ATV Manual Tuning** screen in **Step 3**. Enter the **Position number**, the **System**, then **C** for standard (terrestrial) channels or **S** for cable channels and the **Channel** number. Press **OK** to save.

Skip

To prevent certain channels from being viewed, positions can be skipped.

- 1 Select **ATV Manual Tuning** from the **SETUP** menu.
- 2 Use ▲ or ▼ to highlight the position to be skipped and press **OK** to select.

ATV Manual Tuning		
Pos.	Channel	Station
1	C2	
2	S10	
3	C7	
4	S40	ABC1
5	C22	ABC1
6	C25	
7	C28	
8	C30	

- 3 Press **▶** to select **Skip**.
- 4 Use ▲ or ▼ to turn **Skip** on.
Press **OK**.

↻ on the screen indicates a skipped position.

ATV Manual Tuning		
Skip: On		
1	I A ↻ C 2 Q 0	

- 5 Press **RETURN** and repeat from **Step 2** or press **EXIT**.

Each position has to be *individually* selected. To turn **Skip** off, repeat the procedure for each position.

Skipped positions **cannot** be selected by **P▲** and **P▼** or by the controls on the television but **can** still be accessed by the number buttons on the remote control.

Sorting positions

Channels may be moved and saved to the position of your choice.

- 1 Select **ATV Manual Tuning** from the **SETUP** menu.
- 2 With the list of channels showing, use ▲ or ▼ to highlight the channel you want to move and press **▶**.

ATV Manual Tuning		
Pos.	Channel	Station
2	S10	
3	C7	
4	C40	ABC1
5	C22	ABC1
1	C2	
6	C25	
7	C28	
8	C30	

- 3 Use ▲ or ▼ to move through the list to your preferred position. As you do so, the other channels will move to make room.
- 4 Press **◀** to save your move.
Repeat as necessary, and then press **EXIT**.

DTV Manual Tuning

NOTE: This feature varies depending on the **Ant/Cable In** setting.

Manual Tuning

This feature is available for service engineers or can be used for direct channel entry if the multiplex channel is known.

- 1 Select **DTV Manual Tuning** from the **SETUP** menu and press **OK**.

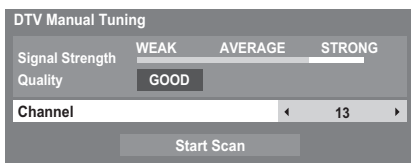

- 2 Enter the multiplex number using the number buttons or use **◀** or **▶** to adjust the number up or down.
- 3 Highlight **Start Scan**, and then press **OK**. The television will automatically search for that multiplex.

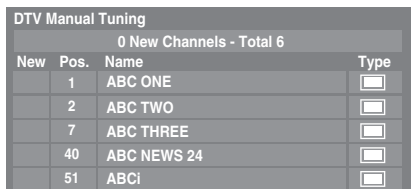

When the multiplex is found, any channels that are not currently in the channel list will be added and the channel information at the top of the screen will be updated.

- 4 Repeat as necessary. Press **EXIT** to finish.

Manual Tuning for DVB-C

When **Ant/Cable In** is set to **Cable**, **DTV Manual Tuning** items are as follows:

Frequency – input a specific frequency to be scanned

Modulation – choose from one of five QAM modulation options

Symbol Rate – input a specific baud rate (KS/s) to be used for the manual scan

DTV Settings

Channels

The channel order may be changed to suit your personal preference.

- 1 Select **DTV Settings** from the **SETUP** menu and press **OK**.
- 2 Select **Channels** and press **OK**.

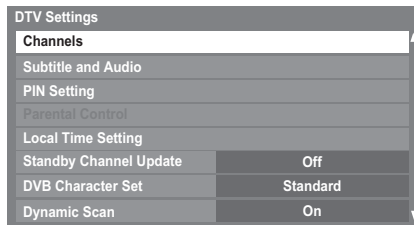

- 3 For your convenience, you can jump to specific places in the list by one of two methods.

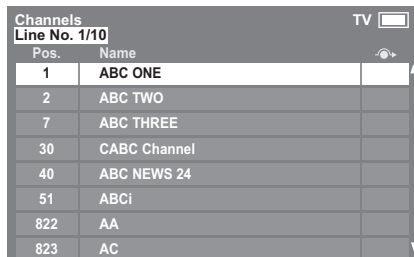

Line Number Jump — Use the **number buttons** (0-9) to input the line number you want to select, and then press **OK**.

Station Letter Jump — Press **◀◀** or **▶▶** to jump to the next station name with a different initial letter.

It is also possible to change the Position number of a particular channel.

Renumber — Press the **RED** button to renumber the highlighted channel. Edit the channel number using the **number buttons** and press **OK**.



Move — Press the **GREEN** button to activate the **Move** feature. Use the **▲** or **▼** buttons to select the channel you wish to move and press **OK** to check. If you wish to move multiple channels at once, select another channel and check in the same way. Repeat as necessary.

Once all desired channels have been checked, use the **▲** or **▼** buttons to place the focus at the position to which you wish to move the channels. The channels will be inserted above the highlighted channel. Press the **GREEN** button to execute the move.

Channels		TV	
Line No.	1/10	Pos.	Name
<input checked="" type="checkbox"/>	1		ABC ONE
<input type="checkbox"/>	2		ABC TWO
<input type="checkbox"/>	7		ABC THREE
<input type="checkbox"/>	30		CABC Channel
<input type="checkbox"/>	40		ABC NEWS 24
<input type="checkbox"/>	51		ABCi
<input type="checkbox"/>	822		AA
<input type="checkbox"/>	823		AC

Sort — Press the **YELLOW** button. A confirmation window will appear. Press **◀** or **▶** to select **Yes** and press **OK**.

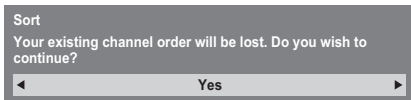

The **Sorting Type** selection window will appear.



Press **◀** or **▶** to set the sorting type.

A - Z Station name order (A to Z)

Channel Number Position No. order (numerical sequence)

Press **▼** to highlight **Sort** and press **OK**.

Standby Channel Update

If the **Standby Channel Update** is set to **On**, when the TV is in standby mode, Digital Tuning is automatically executed and any new channels are saved.

- 1 Select **DTV Settings** from the **SETUP** menu and press **OK**.
- 2 Press **▼** to select **Standby Channel Update** and use **◀** or **▶** to select **On**.

DVB Character Set

This feature allows you to manually select the character set (**Standard** = Table 0, **West** = Table 5 or **Latin alphabet 9**) to be used for DVB-C or DVB-T channels.

- 1 Select **DTV Settings** from the **SETUP** menu and press **OK**.
- 2 Press **▼** to select **DVB Character Set** and use **◀** or **▶** to select **Standard**, **West** or **Latin alphabet 9**.

Dynamic Scan

If the broadcast information has changed in your DVB-T receiving area, the TV screen will display the message "**Broadcast information has changed. Would you like to rescan now?**". Please follow the message. If you do not wish for the TV to detect changes and prompt you to rescan, you should set this feature to "**Off**".

- 1 Select **DTV Settings** from the **SETUP** menu and press **OK**.
- 2 Press **▼** to select **Dynamic Scan** and use **◀** or **▶** to select **On**.

Location setting

You can select either **Home** or **Store** mode. **Home** is recommended for normal home use. Select **Store** when using the television for displaying in a shop, etc.

- 1 Select **Location** from the **SETUP** menu.
- 2 Press **◀** or **▶** to select **Home** or **Store**.

Analogue switch-off

This is a **digital** television which is integrated to allow the use of both **digital** and **analogue** services. However, during the lifetime of this set it is very likely that **analogue** services will be switched off to allow for more new **digital** services.

This 'switch-off' will happen in a number of phases, which will be advertised in your area well in advance. It is recommended that at each phase the television is re-tuned to ensure that existing and new **digital** services can be viewed without disruption.

General controls

Quick Menu

Quick Menu helps you access some options quickly, such as **Picture Mode**, **Picture Size**, **More Information**, **Sleep Timer** etc.

Press **QUICK** to display the **Quick Menu** and use **▲** or **▼** to select the option.

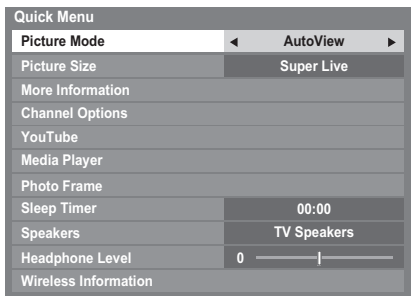

NOTE: **Quick Menu** items are different depending on the current mode.

Quick menu item example

Mode	Quick menu item	Description
When viewing a TV programme or pictures from the external input	Picture Mode	See page 28.
	Picture Size	See page 26.
	More Information	See page 55.
	Channel Options	See page 58.
	YouTube	See page 41.
	Media Player	See page 43.
	Photo Frame	See page 50.
	Sleep Timer	See page 54.
	Speakers	See page 66.
	Headphone Level	See page 25.
Wireless Information	See page 36.	
When using EPG	Genre Colour	See page 56.
	EPG Update/Cancel EPG Update	See page 56.
Media Player (Multi View, List View)	Sort	Page 46 - 50
	Interval Time	Page 46 - 50
	Repeat	Page 46 - 50
	Device Information	Page 46 - 50
	Wireless Information	See page 36.
Photo Frame	PICTURE	See page 28.
	Picture Size	See page 26.

Selecting positions

To select a position, use the numbered buttons on the remote control.

Positions can also be selected using **P▲** and **P▼**.

To display on-screen information such as position, input mode or stereo/mono signal, press **i+**. Press again to cancel.

The Time Display – analogue only

The time display facility allows the current (text service) time to be seen on the television screen.

Press **⏸/⏹** whilst watching a normal television broadcast to see the time display from the broadcaster. It will remain on screen for about 5 seconds.

NOTE: This display may not be available in some cases.

Stereo and Bilingual transmissions

For ATV programmes

If stereo or dual language broadcasts are transmitted, the word **Stereo** or **Dual** will appear on the screen each time positions are changed, disappearing after a few seconds. If the broadcast is not in stereo, the word **Mono** will appear.

Stereo... Press **⏸/⏹** to select **Stereo** or **Mono**.

Bilingual... Bilingual transmissions are rare. If they are transmitted, the word **Dual** will be displayed. Choose the required programme number, and if the word **Dual** appears, press **⏸/⏹** to select **Dual 1**, **Dual 2** or **Mono**.

For DTV programmes

For stereo or dual mono broadcasts, press **⏸/⏹** and use **◀** or **▶** to select settings.

Mode Display	Pressing ▶
⊕ Stereo	Stereo → Left → Right
●○ Dual mono	Dual 1 → Dual 2
○ Mono	-
⊕⊕ Multichannel	-

For multi-audio track broadcasts, press **⏸/⏹** repeatedly to change the audio language (see 'Audio language' on page 59).

Sound controls

Volume controls and mute sound

Volume

Press or to adjust the volume.

Sound Mute

Press once to turn the sound off and again to cancel.

Dual

If a programme or film is being broadcast with a soundtrack in more than one language, the **DUAL** feature allows selection between them.

- 1 Press **MENU** and or to select the **SOUND** menu.
- 2 Press to highlight **Dual**, and then press or to choose between **Dual 1** or **Dual 2**.

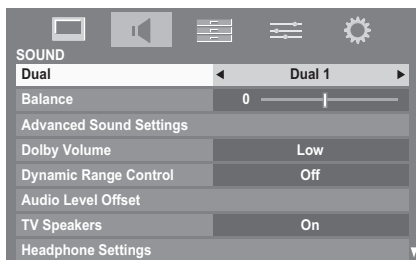

Balance, Bass and Treble

The sound controls are accessible in **digital and analogue** modes.

- 1 Select the **SOUND** menu.
- 2 Press to highlight **Balance**, and then press or to emphasize left or right speaker balance.

For RV series only

- 3 Press to highlight **Advanced Sound Settings**, and then press .
- 4 Press to highlight **Bass** or **Treble**, and then press or to adjust the settings.

Sound Navi (SL/WL series only)

You can customize current sound mode settings. Select the appropriate mode in accordance with the installation location of the TV (**Stand** or **Wall**) and adjust the equalizer on-screen as desired.

- 1 Select the **SOUND** menu.
- 2 Press to highlight **Advanced Sound Settings**, and then press .
- 3 Press to highlight **Sound Navi**, and then press .

Advanced Sound Settings	
Sound Navi	
Surround	Off
Voice Enhancement	On
Dynamic Bass Boost	High

- 4 Press or to select either **Stand** or **Wall** depending on how your TV is installed, and then press the **RED** button.
- 5 Press or to select the frequency range you want to adjust from the equalizer window, and then press or to adjust the level.

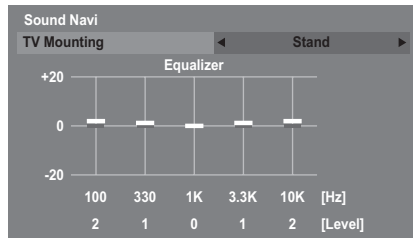

- 6 Repeat step 5 for other frequencies.

Surround Settings

Surround or **Stereo Extension**, **Voice Enhancement**, and **Dynamic Bass Boost** help to create an enhanced surround sound experience with deep, rich bass from stereo sound sources. Your TV's audio will sound fuller, richer, and wider.

- 1 In the **SOUND** menu, press ▼ to highlight **Advanced Sound Settings**, and then press (OK).
- 2 Press ▼ to highlight **Surround** (SL/WL series), and then press ◀ or ▶ to select **Off**, **Spatial** or **Cinema**.

Press ▼ to highlight **Stereo Extension** (RV series), and then press ◀ or ▶ to select **On**.

SL/WL series menu

Advanced Sound Settings	
Sound Navi	
Surround	◀ Off ▶
Voice Enhancement	On
Dynamic Bass Boost	High

RV series menu

Advanced Sound Settings	
Bass	0
Treble	0
Stereo Extension	◀ On ▶
Voice Enhancement	On
Dynamic Bass Boost	High

- 3 Press ▼ to highlight **Voice Enhancement**, and then press ◀ or ▶ to select **On**.
- 4 Press ▼ to highlight **Dynamic Bass Boost** and using ◀ or ▶ select the desired bass expansion level (**Off**, **Low** or **High**).

NOTE: For SL/WL series only, **Ext. Woofer** is displayed instead of **Dynamic Bass Boost** when **Woofer** is set to **External** in the **AV Connection** menu. See 'Woofer setting' section on page 64.

Dolby Volume®

This feature provides a consistent sound volume regardless of programmes, channels or input sources.

- 1 In the **SOUND** menu, press ▼ to highlight **Dolby Volume**.
- 2 Press ◀ or ▶ to select **Low**, **High** or **Off**.

NOTE:

- The **Dolby Volume** setting influences the **Dynamic Range Control** and **Digital Audio Output** settings.
- If **Dynamic Range Control** is set to **On**, this feature will be disabled.

Dynamic Range Control

This feature allows control of audio compression for some digital TV programmes (MPEG-1 and MPEG-2 audio programmes are not supported).

- 1 In the **SOUND** menu, press ▼ to highlight **Dynamic Range Control**.
- 2 Press ◀ or ▶ to select **On** or **Off**.

NOTE: This feature is disabled when **Dolby Volume** is set to **Low** or **High**.

Audio Level Offset

Sometimes there can be large changes in volume when switching from a DTV 5.1ch to a DTV 2ch, an ATV channel, or an external input. Using the **Audio Level Offset** feature reduces these volume differences.

- 1 Set the volume level usually used when watching a DTV 5.1ch programme.
- 2 Tune to a channel which is DTV 2ch, ATV or an external input.
- 3 In the **SOUND** menu, press ▼ to highlight **Audio Level Offset** and press (OK).
- 4 Press ▼ to highlight an option, and then use ◀ or ▶ to adjust the volume level.

Audio Level Offset	
DTV 2ch	-5
ATV	0
External Input	0

NOTE:

- The available item changes depending on the current input source. For example, while watching a DTV 2ch programme, only **DTV 2ch** is available and the other two items are greyed out in the menu. This allows you to easily adjust according to each condition.
- When watching a DTV 5.1ch programme, this feature is not available.

TV Speakers (SL/WL series only)

You can use this feature to turn off the TV speakers when you connect an audio system to the **VARIABLE AUDIO OUT** on your TV.

- 1 In the **SOUND** menu, press ▼ to select **TV Speakers**.
- 2 Press ◀ or ▶ to select **Off**.

To turn on the built-in speakers, select **On**.

Headphone Settings

This setting is used to set the sound output when headphones are connected.

Speaker Link	Headphone	Speakers
On	Sound is output (◀ - + is available.)	No sound
Off	Sound is output (Headphone level menu is available.)	Sound is output (◀ - + is available.)

- 1 In the **SOUND** menu, press ▼ to highlight **Headphone Settings**, and then press **OK**.
- 2 Press ▼ to highlight **Speaker Link** and use ◀ or ▶ to select **On** or **Off**.
- 3 If you select **Off**, then highlight **Headphone Level** and use ◀ or ▶ to adjust the headphone sound.

Headphone Settings	
Speaker Link	Off
Headphone Level	50 ———— —————

Audio Description

Audio Description is an additional narrative sound track for visually impaired individuals to understand and enjoy the story line more fully. The letters AD will be displayed in the channel banner when programmes contain AD content. You can choose to hear sound from the TV speakers and the headphone output or only from the headphone output.

- 1 In the **SOUND** menu, select **Audio Description** and press **OK**.
- 2 Highlight **Audio Description**, and then press ◀ or ▶ to select **On**.

Audio Description	
Audio Description	◀ On ▶
Mixing Level	50 ———— —————
Speaker Out	Off

The **AD** button on the Remote can also be used to toggle the **Audio Description** feature between On and Off.

- 3 To adjust the level of the audio description sound to the main sound, highlight **Mixing Level** and use ◀ or ▶.
- 4 Highlight **Speaker Out**, and then press ◀ or ▶ to select **On** or **Off**.

On: sound from both the headphone output and speakers.

Off: sound from the headphone output.

See "Headphone Settings" to adjust the headphone sound.

NOTE: This feature also applies to the sound from the DIGITAL AUDIO output and FIXED AUDIO output.

Widescreen viewing

Depending on the type of broadcast being transmitted, programmes can be viewed in a number of formats.

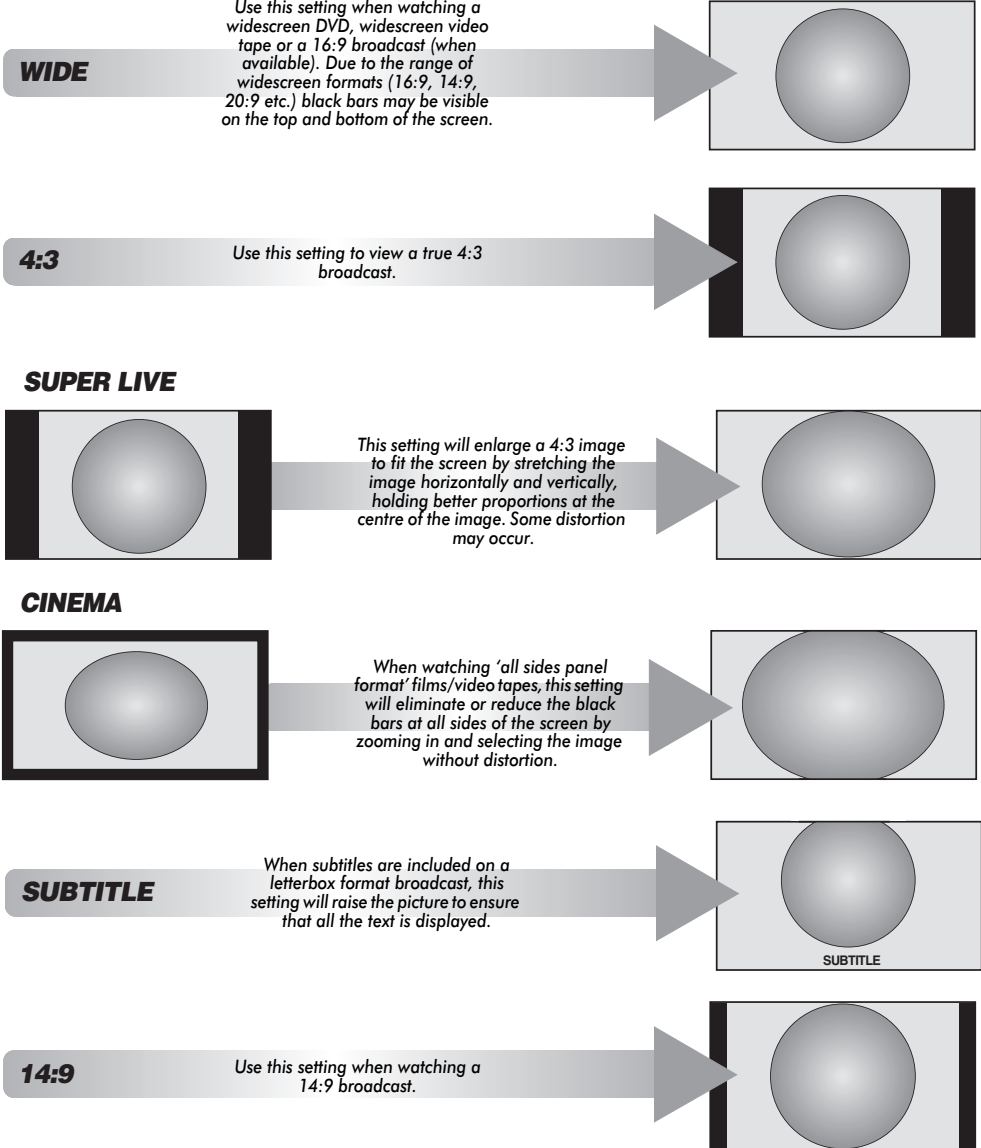

NATIVE

This setting will show the picture without overscan, i.e. WYSIWYG.

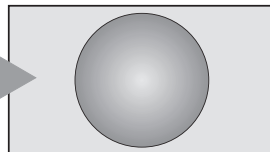
**PC NORMAL**

This setting will show the picture without overscan, i.e. WYSIWYG. This option is only available when watching a PC signal source via HDMI or PC terminal.

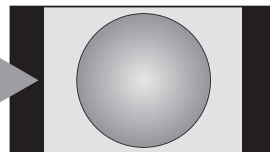
**PC WIDE**

This setting will show the picture without overscan or side panels. This option is only available when watching a PC signal source via HDMI or PC terminal.

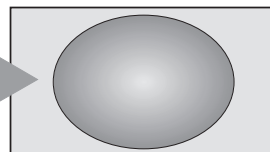
**Dot by Dot**

“Dot by Dot” is a non-scaling display. Depending on the input signal format, the picture is displayed with side panels and/or bars at the top and bottom (e.g. VGA input source).

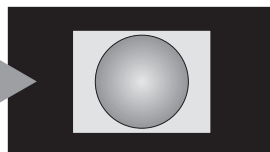

Press the  button on the Remote to display the list of available widescreen formats.

Press the button repeatedly to highlight the required format.

The **Quick Menu** feature can also be used to select **Picture Size**.

AV format

Picture Size
Native
Wide
4:3
Super Live
Cinema
Subtitle
14:9

PC format

Picture Size
Dot by Dot
PC Normal
PC Wide

Using the special functions to change the size of the displayed image (i.e. changing the height/width ratio) for the purposes of public display or commercial gain may infringe on copyright laws.

Picture controls

Most of the picture controls and functions are available in both **digital** and **analogue** modes.
PLEASE NOTE: features not available will be greyed out.

Picture Mode

This television offers the choice of personalising the picture style.

AutoView, Dynamic, Standard, Movie, Store, Game and **PC** are preset options and affect many features/settings within the television.

NOTE:

- Because the **AutoView** mode automatically adjusts picture settings based on ambient light conditions and input signal content, the **Auto Brightness Sensor** and **Expert Mode** menus are greyed out when it is selected.
- Store** mode is only available when **Location** is set to **Store**.
- Game** mode is available in external input mode (other than aerial input). When you select **Game** mode, suitable widescreen formats will be selected.
- PC** mode is available in RGB/PC input mode or HDMI input mode.

- 1 In the **PICTURE** menu, press ▼ to select **Picture Mode**.

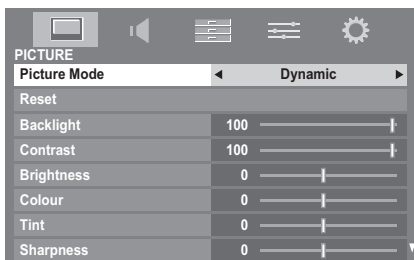

- 2 Press ◀ or ▶ to select the picture mode you prefer and press **OK**.

NOTE: The picture mode you select affects the current input only. You can select a different picture mode for each input.

Picture preferences

You can customize current picture mode settings as desired. For example, while selecting "**Dynamic**", if you change the following items, such as **Backlight, Contrast, Brightness, Colour, Tint, Sharpness** and the **Advanced Picture Settings** items, your new settings are saved for "**Dynamic**" picture mode.

- 1 In the **PICTURE** menu press ▼ to select either **Backlight, Contrast, Brightness, Colour, Tint** or **Sharpness** and press **OK**.
- 2 Press ◀ or ▶ to adjust the settings.

Reset

This feature resets all picture settings to the factory settings except **Picture Mode**.

NOTE: If no picture settings have been changed, **Reset** is not available.

- 1 In the **PICTURE** menu, press ▼ to select **Reset** and press **OK**.
- 2 A confirmation message will appear. Press ◀ or ▶ to select **Yes** and press **OK**.

3D Colour Management

When **3D Colour Management** is set to **On**, it allows the "Base Colour Adjustment" feature to become available.

- 1 In the **PICTURE** menu, press ▼ to select **Advanced Picture Settings** and press **OK**.
- 2 Press ▼ to select **3D Colour Management**.

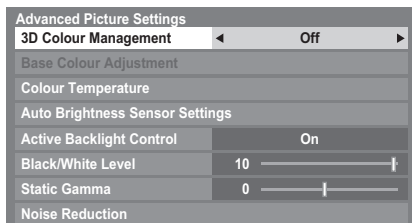

- 3 Press ◀ or ▶ to select **On** or **Off**, and then press **OK**.

Base Colour Adjustment

The **Base Colour Adjustment** feature allows the adjustment of individual colours to suit personal preference. This can be useful when using an external source.

- 1 In the **Advanced Picture Settings** menu, press **▼** to select **Base Colour Adjustment**, and then press **OK**.
- 2 Press **▲** or **▼** to select an option, and then press **▶** to move to the adjustment window.

Base Colour Adjustment			
	Hue	Saturation	Brightness
Red	0	0	0
Green	0	0	0
Blue	0	0	0
Yellow	0	0	0
Magenta	0	0	0
Cyan	0	0	0
Reset			

- 3 Press **◀** or **▶** to select **Hue**, **Saturation** or **Brightness**, and then press **▲** or **▼** to adjust the settings as required.

	Hue	Saturation	Brightness
Red	0	0	-1

- 4 Press **RETURN** to return to the previous menu.
To return to the factory settings, select **Reset** and press **OK**.

Colour Temperature

Colour Temperature increases the 'warmth' or 'coolness' of the picture by increasing the red or blue tint.

- 1 In the **Advanced Picture Settings** menu, press **▼** to select **Colour Temperature** and press **OK**.
- 2 Press **◀** or **▶** to select the **Colour Temperature** setting (0 (warm) -10 (cool)).

Colour Temperature	
Colour Temperature	5
Red-Offset	0
Green-Offset	0
Blue-Offset	0
Red-Gain	0
Green-Gain	0
Blue-Gain	0
Reset	

- 3 Press **▲** or **▼** to select an option you want to adjust, and then press **◀** or **▶** to adjust the settings.

- 4 Press **RETURN** to return to the previous menu.

To return the Colour Temperature settings to the factory defaults, select **Reset** and press **OK**.

NOTE: If **Picture Mode** is set to **AutoView**, you can adjust **Colour Temperature** only and the range will be -5 to +5.

Auto Brightness Sensor Settings

When the **Auto Brightness Sensor** is activated, it will automatically optimise the backlighting levels to suit ambient light conditions.

- 1 In the **Advanced Picture Settings** menu, press **▼** to select **Auto Brightness Sensor Settings** and press **OK**.
- 2 Press **◀** or **▶** to select **On** and press **OK**.

Auto Brightness Sensor Settings	
Auto Brightness Sensor	On
Backlight Adjustment Pro	

- 3 Press **▼** to select **Backlight Adjustment Pro** and press **OK**.
- 4 The **Backlight Adjustment Pro** window will appear. Press **OK** again to display the adjustment window.
- 5 Press **◀** or **▶** to select a point and press **▲** or **▼** to adjust the level.

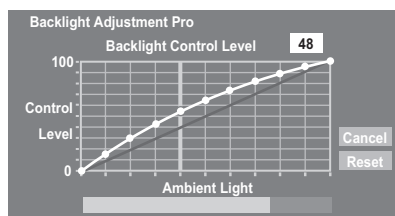

- 6 Press **OK** to fix the adjustment.

To cancel the adjustment when selecting a point, select **Cancel** and press **OK**.

To return the adjustments of all points to the factory defaults, select **Reset** and press **OK**.

Active Backlight Control

When **Active Backlight Control** is activated, it will automatically optimize the backlighting levels for dark scenes.

- 1 In the **Advanced Picture Settings** menu, press ▼ to select **Active Backlight Control**.
- 2 Press ◀ or ▶ to select **On** or **Off**.

Black/White Level

Black/White Level increases the strength of dark areas of the picture to improve the definition.

- 1 In the **Advanced Picture Settings** menu, press ▼ to select **Black/White Level**.
- 2 Press ◀ or ▶ to adjust the level. The effect depends on the broadcast and is most noticeable on dark colours.

Static Gamma

The **static gamma** feature allows you to adjust the levels of black in the picture.

- 1 In the **Advanced Picture Settings** menu, press ▼ to select **Static Gamma**.
- 2 Press ◀ or ▶ to adjust the level.

MPEG NR – Noise Reduction

When watching a DVD, the compression may cause some words or picture elements to become distorted or pixelated.

Using the **MPEG NR** feature reduces this effect by smoothing out the edges.

- 1 In the **Advanced Picture Settings** menu, press ▼ to select **Noise Reduction** and press OK.
- 2 Press ▼ to select **MPEG NR**.



- 3 Press ◀ or ▶ to select **Low**, **Middle**, **High** or **Off** to suit your preference.

DNR – Digital Noise Reduction

DNR allows you to 'soften' the screen representation of a weak signal to reduce the noise effect.

- 1 Select **DNR** from the **Noise Reduction** menu.
- 2 Use ◀ or ▶ to select **Low**, **Middle**, **High**, **Auto** or **Off**. The differences may not always be noticeable (for the best result use lower settings as picture quality can be lost if the setting is too high).

Resolution+

The **Resolution+** feature allows you to adjust the clarity levels for your desired picture settings.

- 1 In the **Advanced Picture Settings** menu, press ▼ to select **Resolution+** and press OK.
- 2 In the **Resolution+** field, select **On**.



- 3 Press ▼ to highlight **Level**, and then press ◀ or ▶ to adjust the level.

NOTE:

- This feature may not work properly depending on the content.
- Adjustable range varies according to the Picture Mode you set.
- Noise may appear in the picture depending on the device connected to the TV (e.g. a device with a specific enhancer function).

Active Vision M100 (SL series only)

This feature will reduce picture blur without decreasing image brightness, or adding flicker.

- 1 In the **Advanced Picture Settings** menu, press ▼ to select **Active Vision M100**.
- 2 Press ◀ or ▶ to select **On** or **Off**.

NOTE: When **Picture Mode** is set to **Game**, this feature will be grayed out and automatically set to **Off**.

Active Vision M200 Pro (WL series only)

This feature will reduce picture blur without decreasing image brightness, or adding flicker.

- 1 In the **Advanced Picture Settings** menu, press ▼ to select **Active Vision M200 Pro**.

- 2 Press ◀ or ▶ to select **On** or **Off**.

NOTE: When **Picture Mode** is set to **Game**, this feature will be grayed out and automatically set to **Off**.

Film Stabilization (WL series only)

The **Film Stabilization** feature allows the adjustment of motion smoothness.

- 1 In the **Advanced Picture Settings** menu, press ▼ to select **Film Stabilization**.

- 2 Press ◀ or ▶ to select **High**, **Middle**, **Standard**, or **Off**.

NOTE:

- When **Picture Mode** is set to **AutoView**, the **Film Stabilization** feature will have an additional "Auto" mode.
- When **Picture Mode** is set to **Game**, this feature will be grayed out and automatically set to **Standard**.

Film Stabilization (SL series only)

The **Film Stabilization** feature allows the adjustment of motion smoothness.

- 1 In the **Advanced Picture Settings** menu, press ▼ to select **Film Stabilization**.

- 2 Press ◀ or ▶ to select **Standard**, **Smooth** or **Off**.

NOTE:

- When **Picture Mode** is set to **AutoView**, the **Film Stabilization** feature will have an additional "Auto" mode.
- When **Picture Mode** is set to **Game**, this feature will be grayed out and automatically set to **Off**.

Expert Mode

This feature allows you to turn the colours red, green, and blue On/Off individually in order to adjust each colour more accurately.

NOTE: This feature is not available when **Picture Mode** is set to **AutoView**.

- 1 In the **Advanced Picture Settings** menu, press ▼ to select **Expert Mode** and press OK.

- 2 Press ▲ or ▼ to select either **Red**, **Green** or **Blue** and press ◀ or ▶ to select **On**. Select **Off** for the other two colours.

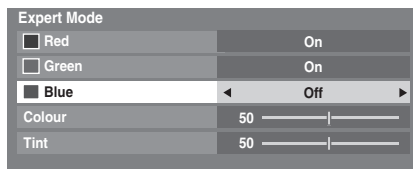

- 3 Press ▼ to select **Colour** or **Tint**, and then press ◀ or ▶ to adjust.

Resetting the advanced picture settings

This feature allows you to reset the current **Advanced Picture Settings** to the default values.

- 1 In the **Advanced Picture Settings** menu, press ▼ to select **Reset**.

- 2 Press OK.

Control Visualization

This feature displays the brightness histogram and control curve of each scene.

- 1 In the **PICTURE** menu, press ▼ to select **Control Visualization** and press OK. The histogram window will appear.

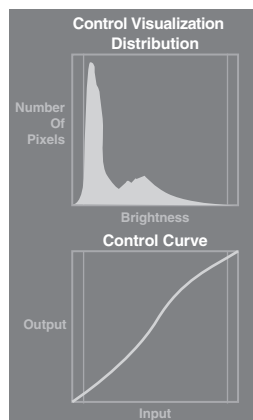

- 2 Press **RETURN** to return to the previous menu.

Automatic Format (Widescreen)

When this television receives a true Widescreen picture and **Auto format** is **On**, it will automatically be displayed in Widescreen format irrespective of the television's previous setting.

- 1 Press **MENU** and ◀ or ▶ to select the **PREFERENCES** menu.
- 2 Press ▼ to select **Display Settings** and press (OK).
- 3 Press ▼ to select **Auto Format**, and then press ◀ or ▶ to select **On** or **Off**.



4:3 Stretch

When **4:3 Stretch** is activated, the size switching system changes 4:3 programmes into full screen picture.

- 1 In the **PREFERENCES** menu, press ▼ to select **Display Settings**, and press (OK).
- 2 Press ▼ to select **4:3 Stretch**, and then press ◀ or ▶ to select **On** or **Off**.

Blue Screen

When **Blue Screen** is selected, the screen will turn blue and the sound will be muted on analogue channels and external input modes when no signal is received.

- 1 In the **PREFERENCES** menu, press ▼ to select **Blue Screen**.
- 2 Press ◀ or ▶ to select **On** or **Off**.

Picture Position

The picture position may be adjusted to suit personal preference and can be particularly useful for external inputs.

- 1 In the **PREFERENCES** menu, highlight **Display Settings** and press (OK).
- 2 In the **Display Settings** menu, highlight **Picture Position**.



- 3 Press (OK) to view the options available for the picture format that has been selected.
- 4 Press ▲ and ▼ to select an option, and then ◀ or ▶ to adjust the settings.

The options differ depending on the currently selected widescreen format and the input signal.

In **Cinema** mode:

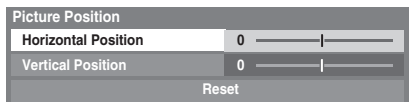

To return to the original factory settings, select **Reset** in the **Picture Position** menu and press (OK).

Picture still

This feature is used to hold a still image on the screen.

Press ▼ to hold an image on the screen, and press (cancel) again to cancel.

HDMI Information Display

When the **HDMI Information Display** feature is **On** and you are watching an **HDMI** input source, pressing the (Info) button displays the **HDMI** signal information banner.

- 1 In the **PREFERENCES** menu, press ▼ to select **HDMI Information Display**.
- 2 Press ◀ or ▶ to select **On**.

HDMI signal information is as follows:

Resolution, Scan Type, Frame Rate, Aspect, Bit Depth, Colour Space, RGB/YUV, Chroma Format, and Content Type (if available).

Using your home network

This TV is a DLNA CERTIFIED™ Player and Renderer. This TV can play digital content stored on a DLNA CERTIFIED™ product with server function. If you want to use this TV as a DLNA CERTIFIED™ Player or Renderer, you will have to configure the network on your TV (see page 13).

If you want to use your home network, you will have to configure the network on your TV. (see page 13) Change the network settings if necessary (see 'Setting up the Network' on page 34).

When using a wireless home network:

Wireless Interoperability

The TOSHIBA Dual Band WLAN Adaptor is designed to be interoperable with any wireless LAN product that is based on Direct Sequence Spread Spectrum (DSSS)/Orthogonal Frequency Division Multiplexing (OFDM) radio technology, and is compliant to:

- The IEEE 802.11 Standard on Wireless LANs (Revision a/b/g/n), as defined and approved by the Institute of Electrical and Electronics Engineers.
- The Wireless Fidelity (Wi-Fi®) certification as defined by the Wi-Fi Alliance®. The "Wi-Fi CERTIFIED™" logo is a certification mark of the Wi-Fi Alliance®.
- The TOSHIBA Dual Band WLAN Adaptor is intended for use with the RV75, SL75 and WL75 series LCD TV's and should not be used with any other devices.

Use of the WLAN Adaptor in other USB products may result in damage to the WLAN Adaptor and/or the equipment. Such use will void any warranty that may otherwise apply, and TOSHIBA will have no liability for any damage that may result from such use.

CAUTION

Bluetooth™ and Wireless LAN devices operate within the same radio frequency range and may interfere with one another. If you use Bluetooth™ and Wireless LAN devices simultaneously, you may occasionally experience a less than optimal network performance or even lose your network connection.

If you should experience any such problem, immediately turn off either your Bluetooth™ or Wireless LAN device.

Actual performance can vary, including lower wireless network capacity, data throughput rate, range and coverage.

Performance depends on many factors, conditions and variables, including distance from the access point, volume of network traffic, building materials and construction, operating system used, mix of wireless products used, interference and other adverse conditions.

Wireless LAN and your Health

Wireless LAN products, like other radio devices, emit radio frequency electromagnetic energy. The level of energy emitted by Wireless LAN devices, however, is far less than the electromagnetic energy emitted by wireless devices such as mobile phones.

Because Wireless LAN products operate within the guidelines found in radio frequency safety standards and recommendations, TOSHIBA believes Wireless LAN is safe for use by consumers. These standards and recommendations reflect the consensus of the scientific community and result from deliberations of panels and committees of scientists who continually review and interpret the extensive research literature.

In some situations or environments, the use of Wireless LAN may be restricted by the proprietor of the building or responsible representatives of the organization. Such restrictions may apply in environments where the risk of interference to other devices or services is perceived or identified as harmful.

If you are uncertain of the policy that applies to the use of wireless devices in a specific organization or environment, you are encouraged to ask for authorization to use the Wireless LAN device prior to turning on the equipment.

This Dual Band Wireless LAN Adaptor may be operated in the following countries:

AT	Austria	IS	Iceland
BE	Belgium	LI	Liechtenstein
CH	Switzerland	LT	Lithuania
CY	Cyprus	LU	Luxembourg
CZ	Czech Republic	LV	Latvia
DE	Germany	MT	Malta
DK	Denmark	NL	Netherlands
ES	Spain	NO	Norway
FI	Finland	PL	Poland
FR	France	PT	Portugal
GB	United Kingdom	SE	Sweden
GR	Greece	SI	Slovenia
EE	Estonia	SK	Slovakia
HU	Hungary	BG	Bulgaria
IT	Italy	RO	Romania
IE	Ireland	TR	Turkey

* As of May 2010, the TOSHIBA Dual Band WLAN Adaptor is not licensed to be sold in Russia.

How to use this Dual Band Wireless LAN Adaptor

- If this device is going to be operated in the frequency range of 5.15 GHz to 5.35 GHz, it is restricted to indoor use.
- If this device is going to be operated for 802.11 b/g/n function in the frequency range of 2.454 GHz to 2.4835 GHz in France, it is restricted to indoor use.
- A general authorization is required for using this device outdoors or in public places in Italy.
- This device is NOT ALLOWED to be used in the geographical area within a radius of 20km from the centre of Ny-Alesund in Norway.

Setting up the Network

You can select the Network Type.

- 1 In the **PREFERENCES** menu, highlight **Network Setup** and press **OK**.

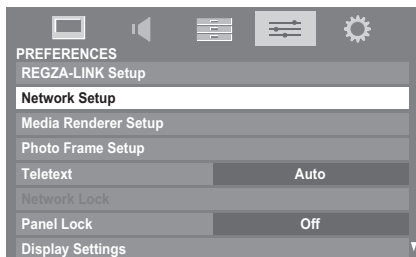

- 2 Press **▲** or **▼** to highlight **Network Type**, and then press **◀** or **▶** to select **Wired** or **Wireless**.

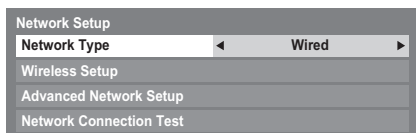

NOTE: If the Dual Band WLAN Adaptor is not connected, Wireless cannot be selected.

- 3 If you selected **Wired**, see "Advanced Network Setup" on page 36.

Wireless Setup

NOTE:

- This feature is grayed out when the Dual Band WLAN Adaptor is not connected or Network Type is set to Wired.
- Continued connection of AP (Access Point) is not guaranteed. The connection may be disconnected while watching TV.
- Do not remove the Dual Band WLAN Adaptor when **Network Type** is set to **Wireless** or wireless communication is active.

There are 3 methods for Wireless Setup:

Easy Setup (WPS)

If the AP supports WPS, this method can be used.

- WPS (Wi-Fi Protected Setup™) is an industry standard designed to make connection of wireless LAN equipment and security setup easy. WPS will automatically configure all wireless settings.

Assisted Setup (setup by using the AP's notification information)

Network Name, Authentication, and Encryption are decided based on information from the AP. You will manually set the Security Key.

Manual Setup (manual input of all settings)

Easy Setup using PBC (Push Button Configuration)

- 1 In the **PREFERENCES** menu, highlight **Network Setup** and press **OK**.
- 2 Press **▲** or **▼** to highlight **Wireless Setup**, and press **OK**.
- 3 Press **▲** or **▼** to highlight **Easy Setup**, and press **OK**.



- 4 Press **◀** or **▶** to select **PBC**.
- 5 Press **▼** to highlight **Start Scan**, and press **OK**.
- 6 Following the on-screen instructions, push the appropriate button on your AP.
- 7 When a window reporting that the setup is complete appears, press **OK**.

To cancel searching for the AP:

Press **RETURN** while searching for the AP. A message will appear, and then press **◀** or **▶** to select **Yes** and press **OK**.

Easy Setup using PIN (Personal Identification Number)

- 1 In the **PREFERENCES** menu, highlight **Network Setup** and press **OK**.
- 2 Press **▲** or **▼** to highlight **Wireless Setup**, and press **OK**.
- 3 Press **▲** or **▼** to highlight **Easy Setup**, and press **OK**.
- 4 Press **◀** or **▶** to select **PIN**.
- 5 Press **▼** to highlight **Start Scan**, and press **OK**.
- 6 Press **▲** or **▼** to select the desired AP and press **OK**.

NOTE: Check the MAC address on the label of the AP or in the manual, and select your AP.

- 7 When the PIN code window appears, enter the displayed PIN into your AP, and then press **Next** to continue the PIN Setup. When a message displays to report that the setup is complete, press **OK**.

To cancel searching for the AP:

Press **RETURN** while searching for the AP. A message will appear; then, press ◀ or ▶ to select **Yes** and press **OK**.

Assisted Setup

1 In the **PREFERENCES** menu, highlight **Network Setup** and press **OK**.

2 Press ▲ or ▼ to highlight **Wireless Setup**, and press **OK**.

3 Press ▲ or ▼ to highlight **Assisted Setup**, and press **OK**.



4 Press ▲ or ▼ to select the desired AP and press **OK**.

NOTE: Check the MAC address on the label of the AP or in the manual, and select your AP.

5 Highlight **Security Key** and press **OK**. The Software Keyboard window will appear.

6 Input the Security Key by using the Software Keyboard (see page 38). To save your setting, press the **BLUE** button.

NOTE:

- The Security Key must adhere to these conditions:
 - TKIP/AES: 8-63 ASCII or 64 Hex characters
 - WEP: 5 or 13 ASCII or 10 or 26 Hex characters
- There is only one key ID to set for WEP encryption.

7 Highlight **Done**, and then press **OK**.

NOTE: If **Network Name** is not displayed, see step 4 and 5 in **Manual Setup** below to set **Network Name** before pressing **Done**.

NOTE: Settings are not saved if **RETURN** is pressed before **Done** is selected.

Manual Setup

1 In the **PREFERENCES** menu, highlight **Network Setup** and press **OK**.

2 Press ▲ or ▼ to highlight **Wireless Setup**, and press **OK**.

3 Press ▲ or ▼ to highlight **Manual Setup**, and press **OK**.

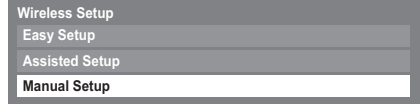

4 Press ▲ or ▼ to highlight **Network Name**, and press **OK**. The Software Keyboard window will appear.

5 Input the Network Name by using the Software Keyboard (see page 38). To save your setting, press the **BLUE** button.

6 Press ▲ or ▼ to highlight **Authentication**, and then press ◀ or ▶ to select **Open System**, **Shared Key**, **WPA-PSK** or **WPA2-PSK**.

7 Press ▲ or ▼ to highlight **Encryption**, and then press ◀ or ▶ to select **None**, **WEP**, **TKIP** or **AES**.

NOTE:

- Certain encryption types are only compatible with specific authentication types.
 - When Authentication is Open System, only WEP or None is compatible.
 - When Authentication is Shared Key, only WEP is compatible.
 - When Authentication is WPA-PSK or WPA2-PSK, only TKIP or AES is compatible.
- When incompatible Authentication/Encryption pairings are detected, a warning message will be displayed, and no connection attempt will be made until the incompatibility is resolved.
- There is only one key ID to set for WEP encryption.

8 Press ▲ or ▼ to highlight **Security Key**, and press **OK**.

9 Input the Security Key by using the Software Keyboard (see page 38). To save your setting, press the **BLUE** button.

NOTE: This item is grayed out when **Encryption** is **None**.

10 Highlight **Done**, and then press **OK**.

NOTE: When **Encryption** is **None**, a message will appear. Press ◀ or ▶ to select **Yes** and press **OK**.

NOTE: Settings are not saved if **RETURN** is pressed before **Done** is selected.

Wireless Information

The settings configured in *Wireless Setup* can be confirmed.

- Press **QUICK** to open the **Quick Menu**.
- Press **▲** or **▼** to select **Wireless Information** and press **OK**.

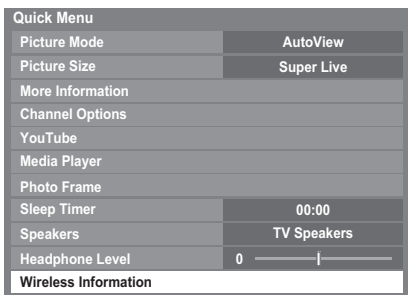

- The Wireless Information window will appear.

NOTE: Press the **RED** button to scan for all available APs.

Item	Description
Status	Connected is displayed when the TV is connected with the AP. Disconnected is displayed when the TV is not connected with the AP.
Signal	Connection signal strength with AP (STRONG/MEDIUM/WEAK)
Speed	Link with AP
Mode	Working mode (11a, 11b, 11g, 11n)
Channel	Channel in use (1-165)
Network Name	SSID set
Authentication	Authentication set
Encryption	Encryption set
Security Key	Security Key set
AP MAC Address	The AP's MAC address is displayed when the TV is connected with the AP.
USB MAC Address	The MAC address of the USB (Dual Band WLAN Adaptor) is displayed.
DHCP	Enabled is displayed when using DHCP. Disabled is displayed when not using DHCP.
IP Address	The TV's IP address
Subnet Mask	Value of the Subnet Mask
Default Gateway	Address of the Default GATEWAY
DNS	Address of the DNS

NOTE: Even if an AP for IEEE 802.11n is used when **Encryption** is set to **WEP** or **TKIP**, the Speed value might be low. It is recommended that **Encryption** be changed to **AES** (see "Manual Setup" on see page 35).

Notes on wireless LAN environment:

- The function of all IEEE802.11 is not supported.
- The ad-hoc mode is not supported.
- It is recommended to use IEEE 802.11a or IEEE 802.11n on 5 GHz for audio and SD video streaming.
- It is recommended to use IEEE 802.11n on 5 GHz for HD video streaming.
- It is recommended that the encoding rate for streaming video content is 20 Mps or less.
- It is not recommended to use 2.4 GHz for audio and video streaming.
- Content playback may be interrupted by various surrounding interference.

Advanced Network Setup

NOTE:

- When the DHCP function of the router connected with this TV is On, you can set **Auto Setup** to **On** or **Off**. (This should usually be set to **On**.)
- When the DHCP function of the router is Off, set **Auto Setup** to **Off**, and set the IP Address manually.

IP Address Setup

Auto Setup:

- In the **PREFERENCES** menu, highlight **Network Setup** and press **OK**.
- Press **▲** or **▼** to highlight **Advanced Network Setup**, and press **OK**.



- Press **▲** or **▼** to highlight **IP Address Setup**, and press **OK**.

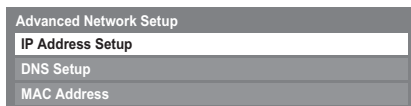

- 4 Highlight **Auto Setup**, and then press ◀ or ▶ to select **On**.

IP Address Setup				
Auto Setup	◀	On	▶	
IP Address	133	. 177	. 108	. 157
Subnet Mask	255	. 255	. 255	. 0
Default Gateway				

NOTE: Other items will be grayed out when **Auto Setup** is set to **On**.

Manual Setup:

- 1 In the **PREFERENCES** menu, highlight **Network Setup** and press **OK**.
- 2 Press ▲ or ▼ to highlight **Advanced Network Setup**, and press **OK**.
- 3 Press ▲ or ▼ to highlight **IP Address Setup**, and press **OK**.
- 4 Highlight **Auto Setup**, and then press ◀ or ▶ to select **Off**.

IP Address Setup				
Auto Setup	◀	Off	▶	
IP Address	133	. 177	. 108	. 157
Subnet Mask	255	. 255	. 255	. 0
Default Gateway				

- 5 Press ▲ or ▼ to highlight **IP Address**.
 - 6 Press ◀ or ▶ to highlight the field you want to change, and then use the number buttons to input the IP address. To save the setting, press **OK**.
- NOTE:** IP address field numbers must be between 0 and 255. After each field number has been set, press **OK** to store the entire address. If the entire IP Address is invalid, a warning message will appear after **OK** is pressed.
- 7 Press ▲ or ▼ to highlight **Subnet Mask**, and edit in the same way as IP Address.

IP Address Setup				
Auto Setup		Off		
IP Address	133	. 177	. 108	. 157
Subnet Mask	255	. 255	. 255	. 0
Default Gateway				

- 8 Press ▲ or ▼ to highlight **Default Gateway**, and edit in the same way as IP Address.

NOTE: If you manually set the IP address, you must not use the same IP address for any other device. The IP address you use should be a private address.

DNS Setup

NOTE: When the DHCP function of the router connected to this TV is **Off**, set **Auto Setup** to **Off**, and manually set the DNS address(es). Your internet service provider should have provided these to you.

Auto setup:

- 1 In the **PREFERENCES** menu, highlight **Network Setup** and press **OK**.
- 2 Press ▲ or ▼ to highlight **Advanced Network Setup**, and press **OK**.
- 3 Press ▲ or ▼ to highlight **DNS Setup**, and press **OK**.
- 4 Highlight **Auto Setup**, and then press ◀ or ▶ to select **On**.

NOTE: Other items will be grayed out when **Auto Setup** is set to **On**.

Manual setup:

- 1 In the **PREFERENCES** menu, highlight **Network Setup** and press **OK**.
- 2 Press ▲ or ▼ to highlight **Advanced Network Setup**, and press **OK**.
- 3 Press ▲ or ▼ to highlight **DNS Setup**, and press **OK**.
- 4 Highlight **Auto Setup**, and then press ◀ or ▶ to select **Off**.

DNS Setup				
Auto Setup	◀	Off	▶	
Primary DNS Address	133	. 177	. 108	. 157
Secondary DNS Address	255	. 255	. 255	. 0

- 5 Press ▲ or ▼ to highlight **Primary DNS Address**.
- 6 Press ◀ or ▶ to highlight the field you want to change, and then use the number buttons to input the Primary DNS Address. To save the setting, press **OK**.

NOTE: DNS address field numbers must be between 0 and 255. If you input an incompatible number and press **OK**, the field number will reset to the previous value.

- Press ▲ or ▼ to highlight **Secondary DNS Address**, and edit in the same way as Primary DNS Address.

MAC Address

You can view the fixed MAC address for the TV and for the Dual Band WLAN Adaptor, if one is installed.

- In the **PREFERENCES** menu, highlight **Network Setup** and press **OK**.
- Press ▲ or ▼ to highlight **Advanced Network Setup**, and press **OK**.
- Press ▲ or ▼ to highlight **MAC Address**, and press **OK**.

Network Connection Test

This function checks the Internet connectivity.

- In the **PREFERENCES** menu, highlight **Network Setup** and press **OK**.
- Press ▲ or ▼ to highlight **Network Connection Test**, and press **OK**.

A message will appear to indicate if the connection was successful or if it could not be completed.

NOTE: The result of Network Connection Test does not always guarantee the connection. Depending on the situation, YouTube may not be able to be used.

To cancel the Network Connection Test:

- Press **RETURN** while searching for the Internet connection.

Using the software keyboard

You can enter text by using the Software Keyboard. The Software Keyboard window will appear when you press **OK** on a field that accepts character input.

To enter text using the software keyboard:

- Highlight the desired character on the on-screen software keyboard.
- Press **OK**.
- Repeat steps 1 and 2 until you have entered all desired text.
- Press the **BLUE** button to close the software keyboard and return to the previous screen.

NOTE: If **RETURN** is pressed, changes are not saved and the software keyboard window is closed. The text will remain as it was before starting the keyboard.

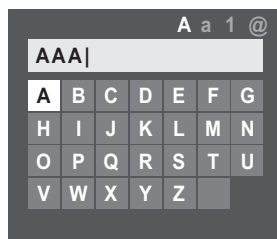

Input operation on the remote control:

Button	Description
OK	Inputs the selected character.
0-9	Inputs the number directly.
▲ ▼ ◀ ▶	Moves the character highlight.
◀ ▶ ▶ ▶	Moves the cursor.
◀ ◀	Moves the cursor to the head of a character string.
▶ ▶	Moves the cursor to the end of a character string.
RED	Deletes 1 character to the left of the cursor.
GREEN	Cycles through upper case, lower case, numbers, and symbols, if available.
YELLOW	Chooses an accented version of the current letter, if applicable.
BLUE	Saves changes and closes the Software Keyboard window.
RETURN	Closes the Software Keyboard window without saving changes.

Setting up the Media Renderer feature

Terminology:

DMS: DLNA CERTIFIED™ Server

DMR: DLNA CERTIFIED™ Renderer

DMC: DLNA CERTIFIED™ Controller

The TV can be configured as a DMR. When operating as a DMR, the TV displays content provided by a DMS. The selection of the media is done by the DMC - the TV does not select the input. The TV can play photo, movie, or audio files when operating as a DMR.

Installation

You can configure the DMR settings individually, or use Installation mode to be prompted for each setting in order.

- 1 In the **PREFERENCES** menu, highlight **Media Renderer Setup** and press **OK**.

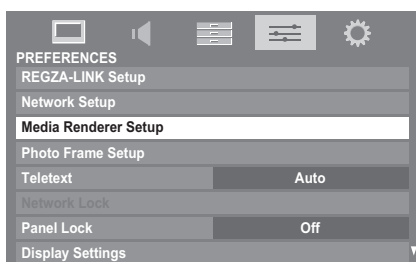

- 2 Press **▲** or **▼** to highlight **Installation**, and press **OK**.

- 3 Press **◀** or **▶** to select **On**, and press **OK**.

- 4 If you want to change the device name as a Renderer, highlight the **Device Name** field and press **OK**. The Software Keyboard window will appear.

- 5 Input the Device Name by using the Software Keyboard (see page 38). To save your setting, press the **BLUE** button.

NOTE: The Device Name can be up to 127 characters long.

- 6 Highlight **Done**, and then press **OK**.

- 7 If you want to change the password, press **◀** or **▶** to select **Yes**, and then press **OK**.

- 8 Change the password by using the Software Keyboard (see page 38), and then press the **BLUE** button.

NOTE: The Web Password can be up to 15 characters long.

- 9 Highlight **Done**, and then press **OK**.

- 10 If you want to limit access from unexpected DMCs, press **◀** or **▶** to select **On**, and then press **OK**.

- 11 If you want to proceed with registration of DMCs, press **◀** or **▶** to select **Yes**, and then press **OK**.

- 12 Press **▲** or **▼** to highlight the item you want to accept, and press **OK**. A check will appear in the box. To remove the check, press **OK** again.

- 13 Press **▶** to highlight **Done**, and then press **OK**.

- 14 The **Maximum Volume Setup** window appears. Press **◀** or **▶** to adjust to the desired volume. Then, press **OK**.

Media Renderer

- 1 In the **PREFERENCES** menu, highlight **Media Renderer Setup** and press **OK**.

- 2 Press **▲** or **▼** to highlight **Media Renderer**, and then press **◀** or **▶** to select **On** or **Off**.

Device Name Setup

The TV's device name as a DMR can change. The device name can be confirmed from the DMC.

- 1 In the **PREFERENCES** menu, highlight **Media Renderer Setup** and press **OK**.

- 2 Press **▲** or **▼** to highlight **Device Name Setup**, and press **OK**.

- 3 Highlight the **Device Name** field and press **OK**. The Software Keyboard window will appear.

- 4 Input the Device Name by using the Software Keyboard (see page 38). To save your setting, press the **BLUE** button.

NOTE: The Device Name can be up to 127 characters long.

- 5 Highlight **Done**, and then press **OK**.

Web Password Setup

This setup determines the password that is necessary for the DMC to access built-in web pages on the DMR.

- 1 In the **Media Renderer Setup** menu, highlight **Web Password Setup**, and press **OK**. Highlight the **Password** field and press **OK**. The Software Keyboard window will appear.

- 2 Change the password by using the Software Keyboard (see page 38), and then press the **BLUE** button.

NOTE:

- The Web Password can be up to 15 characters long.
- Only the password can be changed. User ID cannot be changed.

- 3 Highlight **Done**, and then press **OK**.

NOTE:

- Some DMCs can view or modify the device name of the DMR.
- Depending on the TV's state, it may not be possible to set the device name from the web page.
- Review the owner's manual of the DMC to confirm the method for accessing web pages.

Media Controller Setup

You can limit which DMC can control this TV.
If Access Control is enabled, only those DMCs with a check will be allowed to control the TV.

- 1 In the **Media Renderer Setup** menu, highlight **Media Controller Setup**, and press **OK**.
- 2 Press **▲** or **▼** to highlight **Access Control**, and then press **◀** or **▶** to select **On**.
- 3 Press **▲** or **▼** to highlight **Select Media Controller**, and press **OK**.
- 4 Press **▲** or **▼** to highlight the item you want to accept, and press **OK**. A check will appear in the box.

To remove the check, press **OK** again.

- 5 Press **▶** to highlight **Done**, and then press **OK**.

NOTE:

- You can select up to 8 DMC devices.
- If you would not like to limit the DMCs for this TV, set **Access Control** to **Off**.
- Devices other than DMCs may be displayed in the list. Confirm the MAC address of the DMC and set it.

Maximum Volume Setup

This feature allows you to set the maximum volume of the TV when it receives volume operation commands from a DMC.

- 1 In the **Media Renderer Setup** menu, highlight **Maximum Volume Setup**, and press **◀** or **▶** to adjust to the desired volume.

NOTE:

- The TV's remote control can set volume regardless of the value of **Maximum Volume Setup**.
- When DMR playback is ended, the TV volume will return to the value in effect when DMR playback is started.

Using YouTube™ (WL series only)

YouTube is a video-sharing service managed by YouTube, LLC.

This TV allows you to view YouTube contents.

NOTE:

- You need to configure a home network before using this feature (see page 13).
- If **Network Lock** is set to **On**, it will be necessary to enter your four-digit PIN code in order to access network features (see page 57).

- In the **APPLICATIONS** menu, highlight **YouTube** and press **OK**.

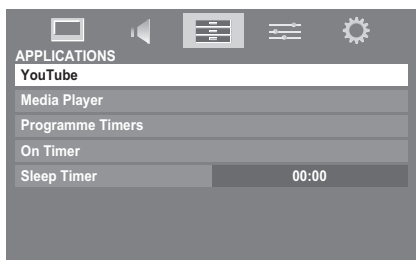

- Press **▲**, **▼**, **◀** or **▶** to select the file you want to view, and press **OK**.

To close YouTube:

- Press **EXIT**.

NOTE:

- This TV may not be able to perform the same operations that a computer can perform.
- Depending on network environment and the use situation, content may be difficult to view.
- Though the same volume value, an actual volume might be greatly different depending on contents.
- This TV might take time to the start-up and the playback of contents.
- The content of service and the screen that can be used may be changed without a previous notice.

Using the Function Menu

The **Function Menu** provides easy access to functions that are commonly used.

- Press the **BLUE** button while displaying YouTube. The **Function menu** window will appear.





- Press **◀** or **▶** to select the desired icon, and press **OK**.



Item	Description
Back	Returns to the previous page.
Forward	Moves to the forward page.
Reload/ Abort	Updates the displayed page./ Aborts update (X is displayed while reading, and ↻ is displayed in other case.)
Home	Returns to the top page of YouTube.
Pointer	Switches the pointer On/Off or drag mode.
Menu	Switches the frame or sets various settings.

Switching the pointer

The tool that operates the screen can be changed to pointer or drag mode.



- From the **Function menu**, press **◀** or **▶** to select **Pointer**, and then press **OK**.
- If you select , see "To use the Pointer: ON" on this page. If you select , see "To use the Drag Mode" on this page.

To use the Pointer: ON:

- Press **▲** or **▼** to select **Pointer: ON**, and press **OK**.
 -  will appear.
- Press **▲**, **▼**, **◀** or **▶** to the place where  changes to , and then press **OK**.

NOTE: When **Pointer: OFF** is selected and **▲**, **▼**, **◀** or **▶** is pressed, the highlight moves to linked areas.

To use the Drag Mode:

- 1 Press ▲ or ▼ to select **Pointer: ON**, and press **OK**.
- 2 Press the **BLUE** button.
- 3 From the Function menu, press ◀ or ▶ to select **Pointer**, and then press **OK**.
- 4 Press ▲ or ▼ to select **Drag Mode**, and press **OK**.
 -  will appear.
- 5 Press **OK**, and then  changes to .
- 6 Press ▲, ▼, ◀ or ▶ to move the selected item in the desired place.

Switching the frame

- 1 From the Function menu, press ◀ or ▶ to select **Menu**, and then press **OK**.
- 2 Press ◀ or ▶ to select **Page Tasks**.
- 3 Highlight **Switch Frames**, and press **OK**.

Setting the view feature

- 1 From the Function menu, press ◀ or ▶ to select **Menu**, and then press **OK**.
- 2 Press ◀ or ▶ to select **View**.
- 3 Press ▲ or ▼ to select the desired item, and press **OK**.
- 4 Press ▲ or ▼ to select the desired setting, and press **OK**.

Item	Settings
Display Mode	Normal: Displays YouTube page with the size as it is. Just-Fit Rendering: Displays YouTube page at a size that has been adjusted to precisely fit the width of your TV.
Text Size	Changes the font size of the screen. Select from Largest, Large, Medium, Small or Smallest . NOTE: This font size is effective only for the page.
Advanced Settings	See the next column.
Page Information	Displays the information of the page you are viewing.
Server Certificates	Displays the server certification.

To setup the Advanced Settings:

- 1 Press ▲, ▼, ◀ or ▶ to select the setting items, and press **OK**. A check will appear in the box. To remove the check, press **OK** again.
- 2 Press ▲, ▼, ◀ or ▶ to select OK field, and press **OK**.

Item	Description
Image	Sets display/non-display of images.
Table	Sets effect/non-effect of tables.
CSS	Sets effect/non-effect of CSS.
Pop-up window	Sets effect/non-effect of pop-up windows.
Animation	Sets display/non-display of animations.
JavaScript	Sets effect/non-effect of JavaScript.
Word wrap	Sets effect/non-effect of Word Wrap. If Word Wrap is enabled, a word not finished at the end of a line is shifted to the next line.
Rapid-Render	Sets effect/non-effect of Rapid-Render. If Rapid-Render is enabled, texts and links are displayed first, and the images and the tables, etc. are displayed afterward. The highlight can be moved with the text and the link displayed.

Setting other features

- 1 From the Function menu, press ◀ or ▶ to select **Menu**, and then press **OK**.
- 2 Press ◀ or ▶ to select **Settings**.
- 3 Press ▲ or ▼ to select the desired item, and press **OK**.
- 4 Press ▲ or ▼ to select the desired setting, and press **OK**.

Item	Settings
Security	When jumping from a protected page to an unprotected page, the message is displayed when the check is applied to Notify of secure/non-secure page changes . Apply the check to select SSL version from SSL Version to use (SSL2.0, SSL3.0, TLS1.0) . A content confirmation of the certification and a setting effect/non-effect can be done in Root Certificates and CA Certificates shown below.
Cookies	Accept all: Cookie is received, and it records in this TV. Reject all: Cookie is not received. Prompt before accepting: When Cookie is received, a message window will be displayed.
Delete Cookies	Deletes all recorded Cookies.
Cache	Use cache: When the check is applied to this, cache is used. Delete All Cache Data: Deletes all the cache preserved in the television.
Browser Information	Displays the information on a browser.

NOTE:

- Cookie is the technical information that a website leaves in this TV so that the website will recognize you when you use it again.
- Cache is a system used to shorten the display time by checking the past data preserved in this television when a page that you viewed before is seen again.

To confirm Root Certificates or CA Certificates:

- 1 Press **▲** or **▼** to select **Security** in step3 in **Setting other features**.
- 2 Press **▲**, **▼**, **◀** or **▶** to select **Root Certificates** or **CA Certificates**, and press **OK**.
- 3 Press **▲** or **▼** to select the desired certificate.
 - When **OK** is pressed, a detailed information window will appear.
 - When the **BLUE** button is pressed, **Disable** or **Enable** bar will appear. It changes whenever **BLUE** button is pressed.
- 4 Press **RETURN**.

Using the Media Player

The WL series TV allows you to enjoy movie (DivX), music (MP3) and photo files stored on a USB 1 device, or photo files on a SD memory card. The RV and SL series TV allows you to enjoy photo files stored on a USB device or SD memory card. Moreover, you can also play photos, movies or music files from your PC by connecting the TV to your home network.

Terminology:

DMP: DLNA CERTIFIED™ Player

DMS: DLNA CERTIFIED™ Server

DMR: DLNA CERTIFIED™ Renderer

DMC: DLNA CERTIFIED™ Controller

- DMP: The TV can control and play content from a DMS.
 - A DMS is a device that can function as a server for DMP or DMR.
- DMR: The TV can play content from a DMS. Playback is controlled by a DMC.
 - A DMC is a device that can instruct the TV to display content.

NOTE:

- Do not insert/remove USB device or SD Memory Card while in use.
- MENU is not available during playback.
- When you want to use your TV as a DMR, set Media Renderer to On (see "Media Renderer" on page 39).

Media Player Specifications**Device**

USB device: USB Mass Storage Class devices (MSC)

NOTE:

- Connectivity is not guaranteed for all devices.
- Do not use a USB Hub.

SD Memory Card: up to 2GB

SD High Capacity Memory Card (SDHC): 4 - 32GB

Supported file system

FAT12, FAT16 and FAT32

NOTE: Do not use any SD Memory Cards other than those specified.

DLNA CERTIFIED™ Server: Your PC (for example)

You must obtain any required permission from copyright owners to download or use copyrighted content. TOSHIBA cannot and does not grant such permission.

Basic operation

Using Media Player with a USB or SD Memory Card

When Auto Start is enabled, you will be asked if you want to start the Media Player whenever a USB or SD device is inserted. If Auto Start is disabled (or if you want to connect to a DMS on the network), you must manually start the Media Player from the menu.

To change the Auto Start setting:

- 1 Press **MENU** and **◀** or **▶** to select the **APPLICATIONS** menu.
- 2 Press **▼** to select **Media Player**, and press **OK**.

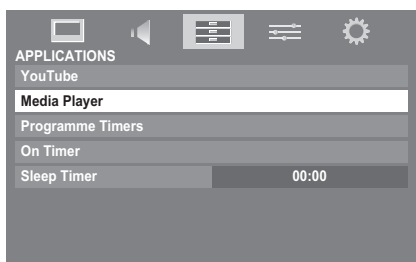

- 3 Press **▲** or **▼** to select **SETUP**, and press **OK**.
- 4 Press **▲** or **▼** to select **USB/SD Auto Start**, and then press **◀** or **▶** to select **On** or **Off**.



Auto Start:

- 1 Insert USB device into the USB socket or SD Memory Card into the SD card slot on the right side of the TV. A prompt will appear.
- 2 Press **◀** or **▶** to select **Yes**, and then press **OK**.
- 3 Press **▲** or **▼** to select **Photo** and press **OK**. The thumbnail view will appear.
- 4 Press **▲** or **▼** to select **USB** or **SD Memory Card** if the selection window is displayed.

NOTE: If **Auto Start** is set to **Off**, you can start the Media Player manually.

Manual Start:

- 1 Insert USB device into the USB socket or SD Memory Card into the SD card slot on the right side of the TV.
- 2 In the **APPLICATIONS** menu, select **Media Player**, and press **OK**.
- 3 Press **▲** or **▼** to select **Photo**, **Movie** or **Music** and press **OK**. The thumbnail will appear.

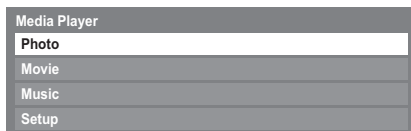

NOTE: If the selection window is displayed, press **▲** or **▼** to select **USB** or **SD Memory Card**.

To select a file in the list of contents:

- 1 Press **▲** or **▼** to select a file or folder.
- 2 Press **OK** to move to the next layer, or press **RETURN** to return to the previous layer.

To close the Media Player:

- 1 Press **EXIT**.

Using the Media Player with a DLNA CERTIFIED™ Server

You need to configure a home network before using this feature (see page 13).

- 1 In the **APPLICATIONS** menu, highlight **Media Player**, and then press **OK**.
 - 2 Press **▲** or **▼** to select **Photo**, **Movie**, or **Music** and press **OK**. The thumbnail (for Photo) or list of files (for Movie and Music) will appear.
- NOTE:** If there is more than one media server on the network, a list of all media servers will be displayed. Highlight the server you want to use, and press **OK**.
- 3 Press **▲** or **▼** to select a DMS if the selection window is displayed.

To select a file in the list of contents:

- 1 Press ▲ or ▼ to select a file or folder.
- 2 Press **OK** to move to the next layer, or press **RETURN** to return to the previous layer.

To close the Media Player:

- 1 Press **EXIT**.

To set the Media Server Setup:

You only need to complete the Media Server Setup if you want to store a list of DMSs to activate later from the TV.

- 1 In the **APPLICATIONS** menu, highlight **Media Player**, and then press **OK**.
- 2 Press ▲ or ▼ to highlight **Setup**, and press **OK**.
- 3 Press ▲ or ▼ to highlight **Media Server Setup**, and press **OK**. A list of currently available DMSs will appear.
- 4 Press ▲ or ▼ to select the desired device, and press **OK**. A check will appear in the box. To remove the check, press again.
- 5 Press ► to highlight **Done**, and then press **OK** to save.

NOTE:

- Up to 8 DMSes can be selected.
- If the device is checked, it will still be displayed (with gray out) in the **Select Device** window, even if it is currently powered off. When **OK** is pressed with the highlight on a grayed out item, a confirmation window for Wake-on-LAN will be displayed. If **Yes** is selected, the TV will attempt to power up ("wake up") the DMS. If the server supports Wake-on-LAN, it will start up.
- When several DMSs are connected, it may take some time for the list to be displayed. The following operations may help to improve the display time.
 - Close the device selection window, and open it again.
 - Press the **RED** button to update the list.

Viewing photo files

There are three types of viewing modes.

Multi View

This view allows you to search for photos in a grid format. The pictures are displayed using thumbnail data in each image file.

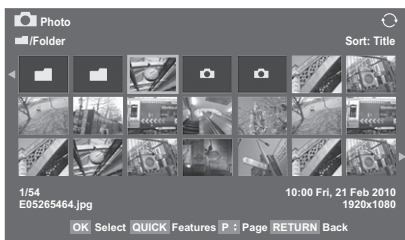

The initial highlighted position will be on the top left thumbnail in the Multi View.

- 1 Press ▲ ▼ ◀ ▶ to move the highlight in one window. If all of the photos will not fit in one screen, when pressing ◀ at the top left thumbnail, the screen will move to the previous page. Conversely, when pressing ▶ at the bottom right thumbnail, the screen will move to the next page.

▶ ◀ buttons can be used to page up/down the photo list when there are more photos than will fit onto one screen. When the ▶ ◀ buttons are pressed, the highlight shall be on the photo at the top left of Previous/Next list.
- 2 When you select a folder, press **OK** to move to the next layer. Press **RETURN** to move back to the previous layer.
- 3 Press **OK** to view the selected photo in Single View mode.

Single View

In this mode, only files located in the selected directory will be displayed. This view allows you to change the photo content manually. When moving from Multi View to Single View, the currently selected photo will be displayed.

- 1 Press **▶** to view the next photo. Press **◀** to view the previous photo.
- 2 Press **▲** to rotate the image 90° clockwise. Press **▼** to rotate the image 90° counterclockwise.
- 3 Press **[i+]** to display file status information (file number, photo title, date and time taken, resolution etc.).

NOTE: The information may not be correctly displayed depending on the content, DMC or DMS.

Slide Show

This view allows you to watch a slide show of your photos. In this mode, only files located in the selected directory will be played.

- 1 To start slideshow, press **[OK]** in the Single View mode.
- 2 Press **◀/▶** to view the previous/next photo.
- 3 Press **▲** or **▼** to rotate the photo.
- 4 Press **[i+]** to display file status information.

To set Interval Time and Repeat settings:

- 1 Press **QUICK** to open the **Quick Menu**.
- 2 Press **▲** or **▼** to select either **Interval Time** or **Repeat**.
- 3 Press **◀** or **▶** to adjust the setting and press **[OK]**.

To sort the folders and files

- 1 Press **QUICK** to open the **Quick Menu** from Multi View mode.
- 2 Press **▲** or **▼** to select **Sort**.

- 3 Press **◀** or **▶** to select **File Name** or **Title**, **New** or **Old** to set the sorting rule.

Item	Description
File Name or Title	File sorting rules: 1. Unicode priority 2. (0, 1, ..., 9), capital alphabet (A, B, ..., Z), small alphabet (a, b, ..., z) 3. Increasing order
New	From new to old according to the date and time when the picture was taken.
Old	From old to new according to the date and time when the picture was taken.

NOTE: Sorting may not be supported by some DMSs.

To display the device information

- 1 Press **QUICK** to open the **Quick Menu** from Multi View mode.
- 2 Press **▲** or **▼** to select **Device Information**.

NOTE: When the photos on the USB or SD card device are used, or the TV is used as a DMR, this feature is not available.

To close the Photo Viewer

- 1 Press **EXIT**. The television will return to the last viewed channel or external input.

File Compatibility

USB or SD card use:

Data compatibility: JPEG Exif ver 2.2

File format: JPEG

Maximum viewable resolution:

4096 x 4096 (HW decode) pixels

16384 x 16384 (SW decode) pixels

Maximum photo size: 9 MB

Maximum number of files: 2000 / folder

Content on DLNA CERTIFIED™ Server:

Data compatibility: JPEG EXIF Ver.1.x or later, JFIF 1.02a

File format: JPEG

Maximum viewable resolution:

4096 x 4096 pixels (DMP)

1024 x 768 pixels (DMR)

Maximum photo size: 6 MB

Maximum number of files: 2000 / folder

Viewing movie files (on a DLNA CERTIFIED™ Server or USB device)

You can select movies from a list of available files.

DLNA screen example

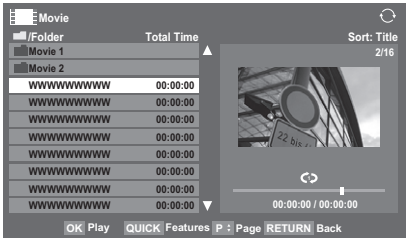

- 1 Press ▲ ▼ to select a file or folder. P ▲ P ▼ buttons can be used to page up/down the movie list when there are more files than will fit onto one screen.
- 2 When you select a folder, press OK to move to the next layer. Press RETURN to move back to the previous layer.
- 3 With the desired file selected, press OK or PLAY (▶) to start playback.

NOTE:

- On DLNA preview screen, if you highlight the file without pressing OK, the content is played on a preview screen. When OK is pressed, it is played in full screen mode.
- Depending on the file size, it may take some time to start playback.

- 4 Press ■ to stop playback.

NOTE:

- If playback finishes before ■ is pressed, the screen will return to the list of available file.
- Depending on the file size, it may take some time for playback to begin.

During playback:

- Press II/III to pause.
- You can move to the desired replay position by pressing ◀ or ▶ during PAUSE.
- PAUSE or operations during PAUSE may not be available depending on the content, DMC or DMS.
- To resume normal playback, press PLAY (▶).
- To play in fast reverse or fast forward directions, press ◀◀ or ▶▶ during playback. Each time you press the ◀◀ or ▶▶, the playback speed will change.
- To locate a specific file, press ◀◀ or ▶▶ repeatedly.
- Press [+] to display the file status information (content number, movie title, progress time etc.).

NOTE:

- The information may not be correctly displayed depending on the content, DMC or DMS.
- During playback, you can adjust the PICTURE, Picture Size and SOUND menu functions from the Quick Menu.

To select subtitle and audio languages

- Press SUBTITLE repeatedly to select your preferred subtitle language.
- Press AUDIO repeatedly to select your preferred audio language.

To set the repeat mode

- 1 Press QUICK to open the Quick Menu.
- 2 Press ◀ or ▶ to select Off, All or 1.

Mode	Description
Off	The file is played back only once.
All	Files in the same folder are repeatedly played back.
1	The same file is repeatedly played back.

- 3 Press RETURN.

NOTE: When the TV is used as a DMR, this feature is not available.

To close the Movie Viewer

- 1 Press EXIT.

To sort the folders and files (DLNA only)

- 1 Press **QUICK** to open the **Quick Menu** in list mode.
- 2 Press **▲** or **▼** to select **Sort**.
- 3 Press **◀** or **▶** to select **Title**, **New** or **Old** to set the sorting rule.

Item	Description
Title	File sorting rules: 1. Unicode priority 2. (0, 1, ..., 9), capital alphabet (A, B, ..., Z), small alphabet (a, b, ..., z) 3. Increasing order
New	From new to old according to the date and time when the contents were updated.
Old	From old to new according to the date and time when the contents were updated.

NOTE: Sorting may not be supported by some DMSs.

To display the device information

- 1 Press **QUICK** to open the **Quick Menu** in list mode.
- 2 Press **▲** or **▼** to select **Device Information**.

To close the Movie Viewer

- 1 Press **EXIT**.

File Compatibility

USB device use:

Profile: DivX Home Theater Profile v3.0

Video: DivX 3, 4, 5, 6

Audio: AC-3, 2-channel of MP2 and MP3

External subtitle: unsupported

Maximum video resolution:

720 x 480 (30 fps)

720 x 576 (25 fps)

Maximum number of files: 500 / folder

Content on DLNA CERTIFIED™ Server:

File format:

Video: MPEG2(PS) PAL, MPEG2(PS) NTSC, MPEG2(TS)

Audio: LPCM / MPEG1-Layer1 / MPEG1-Layer2 / MPEG2-Layer2 / Dolby Digital (AC-3)

Maximum number of files: 1000 / folder

To register your TV to a DivX® account (WL series only)

This TV allows you to play back files purchased or rented from DivX® VOD Video-On Demand (VOD) services. When you purchase or rent DivX® VOD files on the internet, you will be asked to enter a registration code.

- 1 In the **APPLICATIONS** menu, press **▼** to highlight **Media Player**, and then press **OK**.
- 2 Press **▲** or **▼** to highlight **DivX® VOD**, and then press **OK**.
- 3 Press **▲** or **▼** to highlight **DivX® VOD Registration**, and then press **OK**.



- 4 The **DivX® VOD** window will appear and you will see the registration code. For details on registration, please visit the DivX® website at

<http://vod.divx.com>

- 5 Copy the activation file to a memory device and play it on the TV.

To deactivate your device

- 1 In step 3 above, highlight **DivX® VOD Deactivation**, and then press **OK**.
- 2 A confirmation message will appear. Select **Yes**, and then press **OK**.
- 3 The **DivX® VOD** window will appear and you will see the deactivation code. For details on registration, please visit the DivX® website at

<http://vod.divx.com>

ABOUT DIVX VIDEO: DivX® is a digital video format created by DivX, Inc. This is an official DivX Certified device that plays DivX video. Visit www.divx.com for more information and software tools to convert your files into DivX video.

ABOUT DIVX VIDEO-ON-DEMAND: This DivX Certified® device must be registered in order to play DivX Video-on-Demand (VOD) content. To generate the registration code, locate the DivX VOD section in the device setup menu. Go to vod.divx.com with this code to complete the registration process and learn more about DivX VOD.

Playing music files (on a DLNA CERTIFIED™ Server or USB device)

You can listen to music from a list of available files.

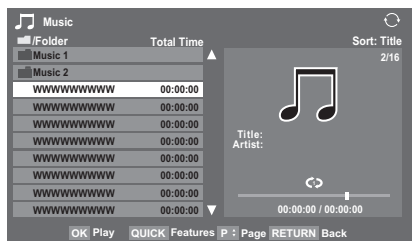

- 1 Press ▲ ▼ to select a file or folder. P ▲ P ▼ buttons can be used to page up/down the music list when there are more files than will fit onto one screen.
- 2 When you select a folder, press (OK) to move to the next layer. Press RETURN to move back to the previous layer.
- 3 With the desired file selected, press (OK) or PLAY (▶) to start playback.
- 4 Press ■ to stop playback.

NOTE:

- Depending on the file size, it may take some time for playback to begin.
- During playback, you can adjust the **SOUND** menu functions from the **QUICK Menu**.

During playback:

- Press II/II▶ to pause.
- To resume normal playback, press PLAY(▶).
- You can move to the desired replay position by pressing ◀ or ▶ during PAUSE.
- PAUSE or operations during PAUSE may not be available depending on the content, DMC or DMS (for DLNA only).
- To play in fast reverse or fast forward directions, press ◀◀ or ▶▶ during playback. Each time you press ◀◀ or ▶▶, the playback speed will change.

To set the repeat mode:

- 1 Press QUICK to open the Quick Menu.
- 2 Press ◀ or ▶ to select Off, All or 1.

Mode	Description
Off	USB: Files in the same folder are played back once. DLNA: A file is played back once.
All	Files in the same folder are repeatedly played back.
1	The same file is repeatedly played back.

- 3 Press RETURN.

NOTE: When the TV is used as a DMR, this feature is not available.

To close the Music Player:

- 1 Press EXIT.

To sort the folders and files (DLNA only)

- 1 Press QUICK to open the Quick Menu in list mode.
- 2 Press ▲ or ▼ to select Sort.
- 3 Press ◀ or ▶ to select Title, New or Old to set the sorting rule.

Item	Description
Title	Title--File sorting rules: 1. Unicode priority 2. (0, 1, ..., 9), capital alphabet (A, B, ..., Z), small alphabet (a, b, ..., z) 3. Increasing order
New	From new to old according to the date and time when the contents were updated.
Old	From old to new according to the date and time when the contents were updated.

NOTE: Sorting may not be supported by some DMSs.

To display the device information

- 1 Press QUICK to open the Quick Menu in list mode.
- 2 Press ▲ or ▼ to select Device Information.

To display the file status information (DLNA only)

- 1 Press **i+** during playback. The information will be displayed on the bottom of the screen.
- 2 Press **i+** again to remove the information.

NOTE: The information may not be correctly displayed depending on the content, DMC or DMS.

File Compatibility**USB device use:**

File format: MP3

Sampling frequency: 16 kHz, 22.05 kHz, 24 kHz, 32 kHz, 44.1 kHz, 48 kHz

Bit rate: from 8 to 320 kbps

Maximum number of files: 500 / folder

Content on DLNA CERTIFIED™ Server:

File format: Linear PCM, MP3

Sampling frequency: 32 kHz, 44.1 kHz, 48 kHz

Bit rate: from 32 to 320 kbps

Maximum number of files: 1000 / folder

Using the Photo Frame feature

You can use the TV screen as a digital photo frame. One image (pre-installed or user-installed) can be displayed. Date info can also be superimposed, if desired.

You can overwrite the photo file with a file from a USB storage device or SD card.

NOTE: This photo file cannot be imported from a DLNA CERTIFIED™ Server.

To open Photo Frame**Open from Menu**

- 1 Press **MENU** and ◀ or ▶ to select the **PREFERENCES** menu.
- 2 Press ▼ to select **Photo Frame Setup**, and then press **OK**.

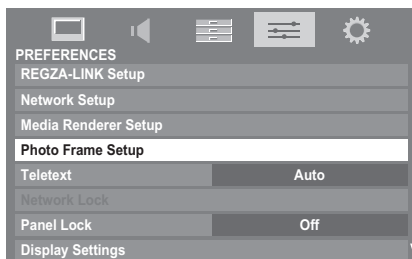

The preview screen will appear.

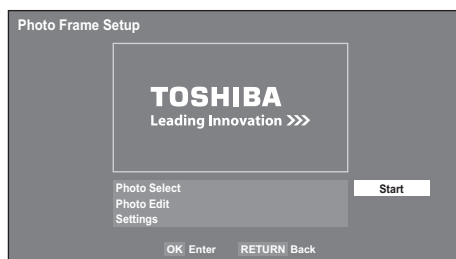

- Press **▶** to select **Start**, and then press **OK** to open **Photo Frame**.



To open from the Quick Menu

- Press **QUICK** to open the **Quick Menu**.
- Press **▲** or **▼** to select **Photo Frame**, and then press **OK** to open **Photo Frame**.

To close Photo Frame:

- Press **EXIT**.

Setting the features

In the preview screen, you can set various settings for Photo Frame.

Photo Select

- In the **Photo Frame Setup** menu, press **▲** or **▼** to select **Photo Select**, and then press **OK**.

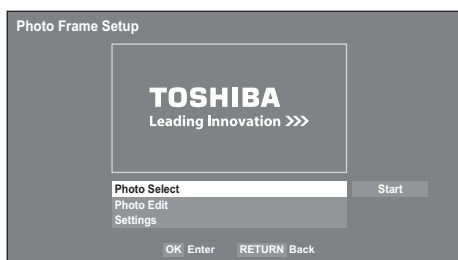

- If the device selection screen appears, press **▲** or **▼** to select the appropriate device, and then press **OK**.

- Press **▲ ▼ ◀ ▶** to select the photo you want to copy from the USB storage device or SD card to the TV's flash memory, and then press **OK**.

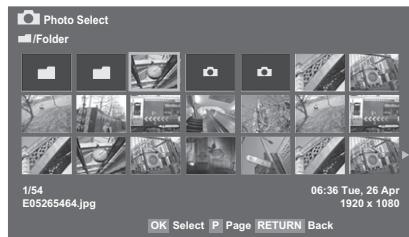
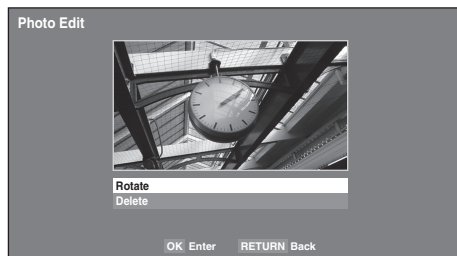

Photo Edit

- Press **▲** or **▼** to select **Photo Edit**, and then press **OK**.
- Press **▲** or **▼** to select **Rotate** or **Delete**.



- Set the following items as required.
 - Rotate** — Press **OK** to rotate the image 90° clockwise.
 - Delete** — Press **◀** or **▶** to select **YES**, and then press **OK**.

- Press **RETURN**.

Settings

- Press **▲** or **▼** to select **Settings**, and then press **OK**.

- 2 Press ▲ or ▼ to select **Clock**, **Position** or **Auto Power Off**.

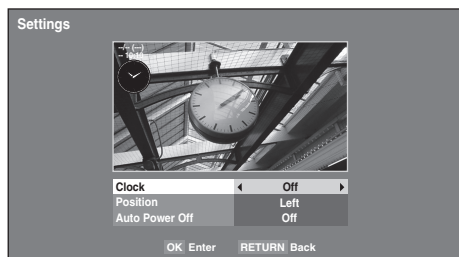

- 3 Set the following items as required.

- **Clock** — Press ◀ or ▶ to select **Off**, **Digital Clock**, **Analogue Clock** or **Analogue + Digital**.
- **Position** — Press ◀ or ▶ to select **Left** or **Right**.
- **Auto Power Off** — Press ◀ or ▶ to select **Off**, **00:30**, **01:00**, **02:00**, **04:00**, **06:00** or **12:00**.

If the Photo Frame window is left open, the TV will automatically turn off after the set length of time (maximum 12 hours).

- 4 Press **RETURN**.

- 5 Select **Start**, and then press (OK).



NOTE:

- The clock display will only appear when time from a digital broadcast is available.
- The photo and clock displays are moved by 4 dots every 5 minutes to prohibit screen burn-in.
- The pre-installed photo file is stored in the TV's flash memory before shipment.
- Picture Size selection (Normal/ Dot by Dot) is available by pressing the QUICK button.

Other features

Panel Lock

Panel Lock disables the buttons on the television. All buttons on the remote control can still be used.

- 1 In the **PREFERENCES** menu, select **Panel Lock** and choose **On** or **Off** using ◀ or ▶.

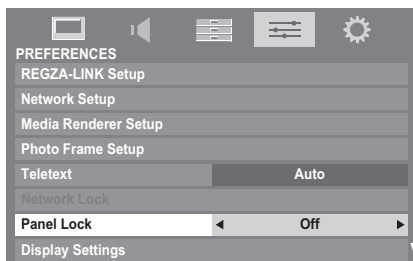

When **Panel Lock** is **On**, a reminder will appear when the buttons on the television are pressed. **If the standby button is pressed, the television will switch off and can only be brought out of standby by using the remote control.**

TOSHIBA Illumination

You can set the illumination mode of the TOSHIBA logo located on the front panel to **On** or **Off**.

- 1 In the **PREFERENCES** menu, press ▼ to select **TOSHIBA Illumination**.
- 2 Press ◀ or ▶ to select either **On** or **Off**.

The timers

Programme Timers – digital only

This feature will set the television to go to a specific channel at a certain time. It can be used to view a particular programme, or by setting the mode to daily or weekly, can be used to view a series of programmes.

- 1 Press **MENU** and ◀ or ▶ to select the **APPLICATIONS** menu.
- 2 Press ▼ to select **Programme Timers**, and then press **OK**.

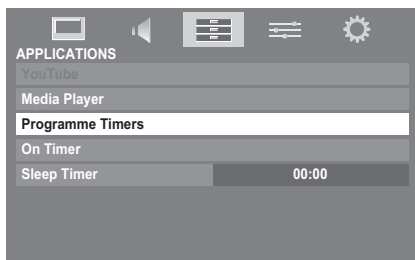

- 3 Press ▼ if necessary to select an open timer position, then press **OK**. The **Edit Timer** menu will now appear on screen.
- 4 Press ▲ and ▼ to go through the list adding the details of the programme by using the number buttons and ◀ and ▶ to make selections.

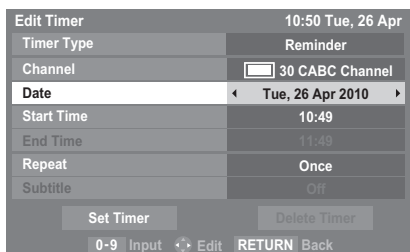

- 5 When all of the details have been entered, highlight **Set Timer** and press **OK** to save the timer.

The ORANGE/RED programme timer indicator on the front of the television will be lit (see page 72 for details).

PLEASE NOTE: When a timed programme is about to start, an information screen will appear offering the option of watching or cancelling the programme. The menus and other channels will not be available during the timed programme unless the programme timer is cancelled. The programme timer you set is not performed when the TV is turned off with the **POWER** switch.

On Timer

The feature allows you to set the television to turn on automatically to a preset channel at a certain time of day or after a certain length of time. When **On Timer** is set to **On**, the green **On Timer** indicator on the front of the television is lit.

- 1 In the **APPLICATIONS** menu, press ▼ to select **On Timer** and press **OK**.
- 2 Press ▲ or ▼ to select **Enable On Timer**, and then press ◀ or ▶ to select **On**.

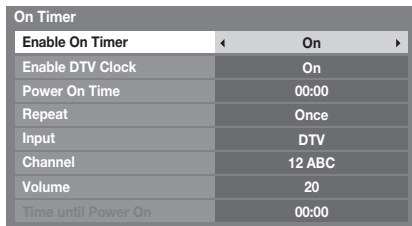

- 3 Press ▼ to select **Enable DTV Clock**, and then press ◀ or ▶ to select **On** or **Off**.
- 4 Press ▲ or ▼ to go through the list adding the details of the **On Timer** by using the number buttons and ◀ and ▶ to make selections.

Power On Time (only for DTV Clock On mode): Set the time you prefer with the number buttons.

Repeat (only for DTV Clock On mode): Select the desired **On Timer** operation (**Once**, **Every Day**, **Mon-Fri**, **Mon-Sat**, **Sat-Sun**).

Input: Select a video input source (ATV, DTV, EXT 1, EXT 2, EXT 3, EXT 4, HDMI 1, HDMI 2, HDMI 3, HDMI 4 or PC).

Channel: Set the channel that will be tuned when the television turns on.

NOTE: When an external input is selected in the **Input** field, a channel cannot be selected.

Volume: Set the volume that will be applied when the television turns on.

Time until Power On (only for DTV Clock Off mode): Set the amount of time from now until the TV turns on using the number buttons (maximum of 12 hours).

To cancel the On Timer

- 1 In the **On Timer** menu, select **Enable On Timer**
- 2 Press ◀ or ▶ to select **Off**.

Sleep Timer

The television can be set to turn itself **Off** after a certain length of time.

- 1 In the **APPLICATIONS** menu, press ▼ to select **Sleep Timer**. Use the number buttons to set the desired time. For example, to switch the television off in one and a half hours enter 01:30, or press ►/◄ to increase/decrease in steps of 10 minutes. (Maximum time setting is 12 hours)
- 2 Press **EXIT** to finish.
- 3 To cancel the **Sleep Timer**, enter all zeros for the above setting.

Energy Saving Settings

Automatic Power Down

The TV will automatically turn itself off (standby) after 4 hours, if you do not operate the TV either from the remote control or the TV control panel.

- 1 In the **PREFERENCES** menu, highlight **Energy Saving Settings** and press **OK**.
- 2 Press ▲ or ▼ to select **Automatic Power Down**.
- 3 Press ◀ or ▶ to select **On** or **Off**, and press **OK**.

NOTE:

- This feature is set to **On** when **Location** is set to **Home**.
- 1 minute before switching to standby, a Warning message will appear.
- When the following features are set, the feature that is set for the nearest time will function.
 - Automatic Power Down
 - Sleep Timer
 - Photo Frame/Auto Power Off
 - Auto shutdown after 1 hour of inactivity (after power on by On Timer)
 - No signal auto power off (after 15 minute of no signal)

No Signal Power Down

The TV will automatically turn itself off after 15 minutes when no signal is detected. You can change the setting to **Off** for the following purposes:

- Low signal strength of analog channel (no signal detection)
- Only Audio L/R is connected to external input to listen to music through the TV speakers.

- 1 In the **Energy Saving Settings** menu, highlight **No Signal Power Down**, and press **OK**.
- 2 Press ▲ or ▼ to highlight the item you want to change, and press ◀ or ▶ to select **On** or **Off**.

NOTE:

- Default setting is all **On**.
- A warning message will appear 1 minute before turning off.

Digital on-screen information and Programme Guide

When viewing in **digital** mode, the on-screen information and programme guide provide access to programme details for all available channels.

Information

- 1 Press **i+**, the information screen will appear giving details of the channel and programme currently being viewed.

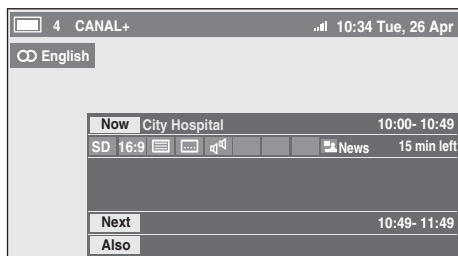

- 2 Press **▲** or **▼** to select the “**Now**”, “**Next**” or “**Also**” information guide.
- 3 To record the next scheduled programme, select “**Next**” and press **OK**. The **Edit Timer** screen will appear.

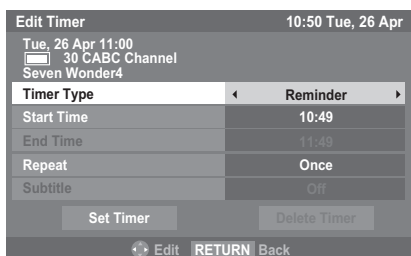

- 4 The details of the programme will already have been added to the timer. Highlight **Set Timer** and press **OK** to save.

To indicate that a Recording Timer has been set, a clock icon will be displayed in the **Next** and **Also** fields of the information screen. A check mark will appear if the timer is a Reminder Timer.

- 5 Press **▼** to select **Also**. Details of programmes that have started on other channels will be provided. Use **◀** or **▶** to change the display contents.

To display More Information

- 1 Press **QUICK** to open the **Quick Menu**.
- 2 Press **▼** to highlight **More Information** and press **OK**.

On-screen Information icons

	Icon	Description
Service info		Service type (TV, Radio, TEXT)
		Skip
Audio info		Mono
		Stereo
		Dual mono
		Multichannel
		Dolby Digital
		Dolby Digital+
		Audio Coding
		Audio Description
Audio/Subtitle info		For Hard of Hearing
Event info		Video format (HD, SD)
		Video Aspect
		Teletext
		Subtitle (Single, Multi)
		Multi-audio track
		Parental rating
		Encrypted
Timer info		Recording
		Reminder

Guide

- 1 Select the on-screen guide by pressing **GUIDE**, and the guide screen will appear highlighting details of the channel and programme currently being viewed. This may take a few moments to appear.

Thu6	10:50 Tue, 6 Apr				
TV	18:00	18:30	19:00	19:30	20:00
6 M6	LES SIMPSON	TOP MODEL			
9 W9	SUMMERLAND	SUMMERLAND	LES SIM...		
11 NT1	Nicky La...	Street fight...	Dragon B...	Dragon B...	K 2000
31 PARIS PREMIERE	MA SORCIE...	HAPPY DAYS	HAPPY DAYS		
34 AB1	Evamag	21 jump street	Jerry Springer Show	City guys	L...
800 FlowerGd 6Mbs					
801 FlowerGd 4Mbs					
802 FlowerGd 2Mbs					
804 Codec 4:3					
806 ITV1					
807 ITV3					
808 ITV2					
809 ITV4					

You can switch the time scale to 1.25 or 2.5 hours by pressing the **GREEN** button.

NOTE: Channels are displayed in groups by service type (TV, Radio, Text). Pressing the **TV** button will switch the service type.

- 2 Press **◀** or **▶** for information on other programmes scheduled for the channel selected. To highlight the first programme in the genre grid, press the **RED** button.
- 3 For details of other programmes currently available, press **▲** and **▼** to scroll up and down the channel list. As channels are selected, details of the programme currently being broadcast will appear. Press **◀** or **▶** to view information for future programmes.
- 4 For information on a highlighted programme, press **i+**.
- 5 To set the timer for that programme, press the **BLUE** button to bring up the **Programme Timers** menu.

NOTE: In order for the recording operation to work properly, the media recorder must be set to the same time as the TV. Regarding the process for recording, please refer to the owner's manual of the recording equipment.
- 6 Press **Pv** to advance to the next page, or press **P^** to go back to the previous page.

Genre selection/searching

From the guide screen, you can use the genre selection and search features.

- 1 Press the **QUICK** button from the guide screen.
 - 2 Press **▲** or **▼** to highlight **Genre Colour** in the **Quick Menu**, and then press **OK**.
-
- 3 With the focus on a particular genre, press the desired colour key to assign. Four colours will be available to set. Press **RETURN** to go back to the guide screen.
 - 4 Press the **YELLOW** button to access the **Genre Search** screen.

Genre Search		10:50 Tue, 6 Apr
Movies		
34 AB1	Hard Rain	Wed,27 Apr 0:15- 1:45
31 PARIS PREMIERE	Red Corner	Wed,27 Apr 22:15- 23:55
11 NT1	The Lawnmower Man	Thu,28 Apr 1:20- 3:00
9 W9	A Vow to Kill	Fri,29 Apr 1:30- 3:00
34 AB1	Parenthood	Sat,30 Apr 0:45- 2:40
11 NT1	Body and Soul	Sat,30 Apr 1:15- 3:00
31 PARIS PREMIERE	The Nun's Story	Sat,30 Apr 15:00- 17:30
9 W9	Red Corner	Sat,30 Apr 23:20- 1:15
11 NT1	The Real Blonde	Sun,1 May 0:40- 2:00
31 PARIS PREMIERE	Critters	Sun,1 May 0:40- 2:20
11 NT1	Indiana Jones and the Temple of Doom	Sun,1 May 21:10- 23:20
11 NT1	The jackal	Sun,1 May 23:20- 1:15
34 AB	Coup De Ville	Mon,1 May 1:10- 3:00

- 5 Press **◀** or **▶** to select the genre. Programmes listed will change for the new genre. Press **▲** or **▼** to highlight a particular programme.
- 6 When a current programme is selected, pressing **OK** will tune to that programme. When a future programme is selected, pressing **OK** will open the **Edit Timer** menu.
- 7 For information on a highlighted programme, press **i+**.
- 8 To exit the **Genre Search** and go back to the guide screen, press the **YELLOW** button.

Digital settings – parental control

In order to prevent viewing of unsuitable films and programmes, channels and menus can be locked in digital mode. These can then only be accessed with a security code PIN.

Setting the PIN

- 1 Press **MENU** and **▶** to select the **SETUP** menu.
- 2 Use **▼** to select **DTV Settings**, and then press **OK**.

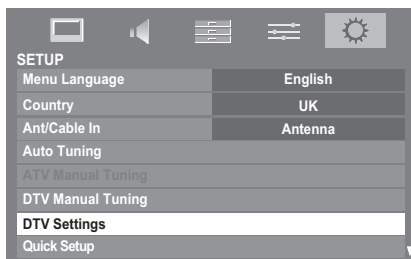

- 3 Press **▼** to highlight **PIN Setting**, and then press **OK**.

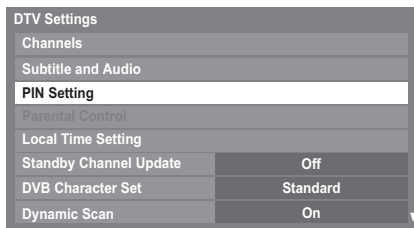

- 4 Using the number buttons enter a four digit number. Once entered you will be prompted to confirm by entering again.



The PIN number is now set.

If the PIN code has been set, when **Auto Tuning** and **Reset TV** are executed, entering the PIN will be necessary.

Parental Setup

The **Parental Control** feature allows you to block programmes according to their rating levels. If a PIN has been set, you will need to enter it before adjusting the level.

- 1 In the **DTV Settings** menu, press **▼** to select **Parental Control**, and then press **OK**.
- 2 Use **◀** or **▶** to choose an option (**None** or an age setting (4-17 or 4-18 depending on the **Country** setting)).



To view blocked programmes, enter the PIN. To reactivate the Parental Control, turn the TV off and then on again.

Network Lock

You can use the **Network Lock** feature to prevent the Web browser from launching. When this feature is set to **On**, PIN input will be necessary to use YouTube.

This feature will be grayed out until a PIN is set.

- 1 In the **PREFERENCES** menu, highlight **Network Lock** and press **OK**.

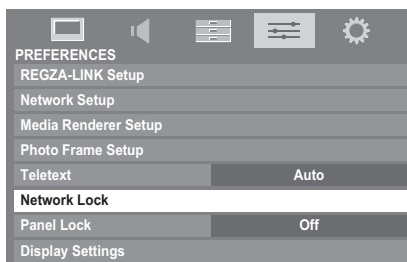

- 2 Enter your four-digit PIN code.
- 3 Press **◀** or **▶** to select **On**, and then press **OK**.

To unlock the Network:

- 1 Select **Off** in step 3 above.

Digital settings – Channel Options

Selecting favourite channels

Favourite Channels creates a list of the **digital** channels that are watched most. Four lists can be created, these can be a mixture of television, radio and text channels.

- 1 Select a channel you want to add to your favourite list.
- 2 Press **QUICK** to open the **Quick Menu**.
- 3 Press **▼** to select **Channel Options** and press **OK**.
- 4 Press **▶** repeatedly to select the favourite list (Fav. 1-4)



- 5 Press **OK** to select the ones required. A tick will appear in the box as they are selected.
- 6 Repeat steps 1 through 5 for other channels.
- 7 When all favourites have been selected, press **EXIT**.

Favourite Channel Lists

- 1 Press **LIST** to display **Channel List**.
- 2 Press **◀** or **▶** to select Favourites 1-4. The number of favourites available depends on how many lists have been created.



- 3 Press **▲** or **▼** to highlight a channel and press **OK** to watch.

Skip channels

This feature allows you to set channels that will be skipped when **Pv** or **P^** are used to tune.

- 1 Select the channel you want to skip in your channel list.
- 2 From the **Quick Menu**, press **▼** to select **Channel Options** and press **OK**.
- 3 Press **▶** repeatedly to highlight the skip (**↔**) box.
- 4 Press **OK** to select. A tick will appear in the box.
- 5 Repeat steps 1 through 4 for other channels.
- 6 Press **EXIT**.

NOTE: Skipped channels cannot be selected by **Pv** or **P^** but still be accessed by direct number entry (when tuned a **↔** icon will be displayed in the banner to indicate as a skipped channel).

Locking channels

Locking Channels stops the viewing of **digital** channels, and they can only be accessed by entering the **PIN**.

- 1 Select the channel you want to lock in your channel list.
- 2 From the **Quick Menu**, press **▼** to select **Channel Options** and press **OK**.
- 3 Press **▶** repeatedly to highlight the lock (**🔒**) box.
- 4 Press **OK** to select. A tick will appear in the box.

If a PIN has already been set, PIN entry will be required to set the locked channels.

- 5 Repeat steps 1 through 4 for other channels.
- 6 Press **EXIT**.
- 7 From this point on, when any of the channels in the **Locked Channel** list are selected, the **PIN** must be entered before they can be accessed.

Digital settings – other settings

Subtitles

In digital mode, this feature will show subtitles on the screen in the selected language provided they are being broadcast.

- 1 In the **DTV Settings** menu, press ▼ to select **Subtitle and Audio** and press **OK**.
- 2 Press ▼ to select **Subtitle Display** and use ◀ or ▶ to select **On** or **Off**.

Subtitle and Audio	
Subtitle Display	◀ Off ▶
Subtitle Type	Normal
Primary Subtitle Language	English
Secondary Subtitle Language	English
Audio Type	Normal
Primary Audio Language	English
Secondary Audio Language	English

- 3 Press ▼ to select **Primary Subtitle Language** or **Secondary Subtitle Language** and use ◀ or ▶ to select an option.

The **SUBTITLE** button can be used to select subtitle on or off for the current channel only and to select the subtitle language if more than one subtitle is available.

Audio languages

This feature allows a programme or film to be viewed with a choice of soundtrack language, provided multiple language tracks are being broadcast.

- 1 In the **Subtitle and Audio** menu, press ▼ to select **Audio Type** and use ◀ or ▶ to select **Normal** or **For Hard of Hearing**.
- 2 Press ▼ to select **Primary Audio Language** or **Secondary Audio Language** and use ◀ or ▶ to select an option.

If more than one soundtrack is available, use the **◻◻/◻◻** button to select between them.

Common Interface

The **Common Interface Slot**, situated on the side of the television, enables the insertion of a **CAM (Conditional Access Module)** and card. These are purchased from a service provider and allow additional subscription broadcasts to be viewed. For information, see a service provider.

- 1 Insert the **CAM** and card into the **Common Interface Slot**, following the instructions provided with the **CAM**. A box will appear on screen to confirm that the **CAM** has been inserted.
- 2 In the **DTV Settings** menu, press ▲ or ▼ to select **Common Interface** and press **OK**.
- 3 Details of the **CAM** should now be available.

NOTE:

- Software update of a **CI Plus CAM** may occur automatically if instigated by the broadcaster. This could cause the cancellation of any **Reminders/Recordings** during this process.
- Some **CI** or **CI+** **CAM** may not be supported.
- **CI+** operation is not guaranteed except for **Canal Ready DTT** services on suffix **FC** models.

Software Upgrade and Licences

Auto Upgrade

When **Auto Upgrade** is set to **On**, the television will automatically upgrade while in standby if new software is available.

- 1 From the **SETUP** menu, press ▲ or ▼ to select **Software Upgrade** and press (OK).
- 2 Press ▲ or ▼ to select **Over-the-air Upgrade** and press (OK).
- 3 Press ▲ or ▼ to select **Auto Upgrade**.
- 4 Use ◀ or ▶ to select **On** or **Off**.

Searching for New Software

If preferred, software upgrades can be searched for manually using **Search for New Software**.

- 1 In the **Software Upgrade** menu, select **Over-the-air Upgrade**, and then press ▲ or ▼ to select **Search for New Software**.
- 2 Press (OK). The television will automatically start searching for a software upgrade, the progress bar will move along the line.

SEARCHING FOR NEW SOFTWARE

Searching for a new software upgrade for this TV.

Searching 

If an upgrade is found, the television will automatically start downloading. If not, a screen will appear stating that an upgrade is unavailable.

Network Upgrade

TOSHIBA may offer upgrades for the TV's software in the future. The TV's software is upgraded via the Network.

Before downloading software;

Configure your TV to connect to the Internet.

NOTE: While the upgrade is being performed, you will not be able to watch the TV.

- 1 In the **Software Upgrade** menu, press ▲ or ▼ to select **Network Upgrade** and press (OK).

NOTE: If the network is not available, a warning message will appear.

- 2 The TV software upgrade will start when download succeeds.

Software Licences

The licences for the software used in this television are available for viewing.

- 1 In the **SETUP** menu, press ▲ or ▼ to select **Software Licences** and press (OK).

A screen will appear displaying all the licensing information required for the televisions software.

System Information and Reset TV

System Information

This feature can be used to check the version of software currently installed. When in DTV mode, it includes additional diagnostic information such as signal strength, signal quality, centre frequency, modulation, etc.

- 1 From the **SETUP** menu, press **▲** or **▼** to select **System Information**.
- 2 Press **OK** to display the **System Information**.

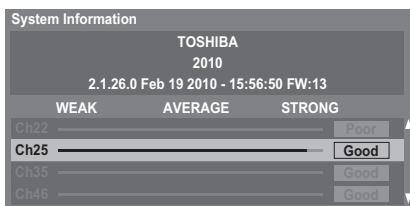

- 3 For information about the signal quality of a particular multiplex, press **▲** or **▼** to select that multiplex.
- 4 Press **OK** for a screen showing detailed technical information about the selected multiplex.

Reset TV

Selecting **Reset TV** will reset all TV settings, including saved channels, to their original factory values.

- 1 In the **SETUP** menu, press **▼** until **Reset TV** is highlighted.
- 2 Press **OK** to select. A screen will appear warning that all settings will be lost. Press **OK** to continue.

When the set powers back on, the **Quick Setup** screen will appear. Press **OK** to advance the setup and perform an auto tune. (See 'Quick Setup' section on page 15.)

PC Settings

Horizontal and Vertical Position

Connect the PC (as shown in the 'Connecting a computer' section) and ensure that a picture is showing on the television screen. The picture position may now be adjusted to suit personal preference.

- 1 In the **PREFERENCES** menu, highlight **Display Settings** and press **OK**.
- 2 In the **Display Settings** menu, press **▼** until **PC Settings** is highlighted.



- 3 Press **OK**. Press **▲** and **▼** to select an option, then **◀** or **▶** to adjust the settings.

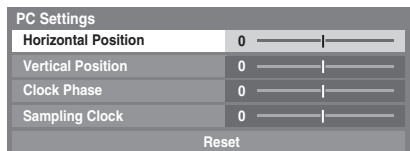

Clock Phase

The **Clock Phase** matches the PC signal with the LCD display. Adjusting this can clear horizontal stripes and picture blur.

- 1 In the **Display Settings** menu, press **▼** until **PC Settings** is highlighted.
- 2 Press **OK** to select, and then **▼** to highlight **Clock Phase**.
- 3 Use **◀** or **▶** to adjust until the picture clears.

Sampling Clock

Adjusting the **Sampling Clock** alters the number of pulses per scan, this will clear vertical lines on the screen.

- 1 In the **Display Settings** menu, press ▼ until **PC Settings** is highlighted.
- 2 Press (OK) to select, and then ▼ to highlight **Sampling Clock**.
- 3 Use ◀ or ▶ to adjust until the picture clears.

Reset

Use **Reset** to return all items to the original factory settings.

- 1 In the **Display Settings** menu, press ▼ until **PC Settings** is highlighted.
- 2 Press (OK) to select, and then ▼ to highlight **Reset**.
- 3 Press (OK).

NOTE: When a PC is connected using HDMI, none of these functions will be available.

The screen is disrupted momentarily when adjusting PC Settings. This is not a sign of malfunction.

The default settings and adjustment ranges may vary depending on the input signal format.

Input selection and AV connections

See page 9 for a detailed image showing recommended connections.

Most media recorders and decoders send a signal through the SCART lead to switch the television to the correct *Input* socket.

Alternatively, press the external source selection button (⊖) until the picture from connected equipment is shown.

An **S** in the display e.g. ⊖2S (**EXT 2S**), indicates the input is set for an S-Video signal.

Input selection

Use the **Input Selection** window if the television does not switch over automatically.

- 1 By pressing (⊖) on the remote control or TV, a list will appear on screen showing all inputs and external equipment.

Pressing (⊖) on the remote control

Inputs
TV
⊖ 1
⊖ 2
⊖ 3
⊖ 4
HDMI 1
HDMI 2
HDMI 3
HDMI 4
PC

Pressing (⊖) on the TV right side panel

Inputs
DTV TV
DTV RADIO *
DTV TEXT *
⊖ 1
⊖ 2
⊖ 3
⊖ 4
HDMI 1
HDMI 2
HDMI 3
HDMI 4
PC
ATV

* If radio or text channels are currently available for DTV.

HDMI® displays equipment connected to *Input HDMI* on the back or side of the television.

PC displays a computer connected to *Input RGB/PC* on the back of the television.

External input skip

This feature is designed to make input selection more convenient.

- 1 In the **PREFERENCES** menu, press ▼ to select **AV Connection** and press **OK**.

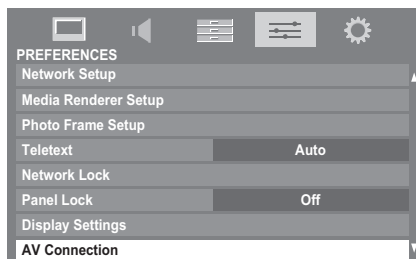

- 2 Press ▲ or ▼ to highlight **Input Labeling** and press **OK**.

- 3 Press ▲ or ▼ to select the input you want to skip, and then press the **RED** button to turn on the skip.

Input Labeling	Input	Label	
	EXT 1	--	👁️
	EXT 2	--	
	EXT 3	--	
	EXT 4	--	
	HDMI 1	--	
	HDMI 2	--	
	HDMI 3	--	
	HDMI 4	--	
	PC	--	

- 4 To turn off the skip, press the **RED** button again.

The input set to Skip is greyed out in the Input Selection window and is skipped over when you press **⏮** on the remote control.

Input signal selection

This specifies the type of signal going into SCART 2 (**EXT 2**) on the back of the television. Please refer to the manufacturer's instructions for the connected equipment.

- 1 In the **PREFERENCES** menu, press ▼ until **AV Connection** is highlighted and press **OK**.
- 2 Press ▲ or ▼ to highlight **EXT 2 Input**.
- 3 Press ◀ or ▶ to select either **AV** or **S-VIDEO** as the required input for **EXT 2**.

AV Connection	
Input Labeling	
PC/HDMI 3 Audio	PC
HDMI 3 Audio	Digital
HDMI Settings	
EXT 2 Input	AV
Woofers	Internal
Digital Audio Output	Auto

If video colour is absent, try the other setting.

Labeling video input sources

These input labels are shown in the input selector. You can label video inputs according to the devices you have connected to the TV.

- 1 In the **PREFERENCES** menu, highlight **AV Connection** and press **OK**.
- 2 Press **▲** or **▼** to highlight **Input Labeling** and press **OK**.

Input Labeling	Input	Label	
	EXT 1	← --	▶
	EXT 2	--	
	EXT 3	--	
	EXT 4	--	
	HDMI 1	--	
	HDMI 2	--	
	HDMI 3	--	
	HDMI 4	--	
	PC	--	

- 3 Press **▲** or **▼** to highlight the item you want to label, and then press **◀** or **▶** to select **--**, **Amplifier**, **Cable**, **DVD**, **Game**, **PC**, **Recorder**, **Satellite** or **VCR**, or press the **GREEN** button to select **User Input**.

NOTE: When **User Input** is selected by pressing the **GREEN** button, the **Software Keyboard** window will appear. Input the desired characters (10 characters or less) by using the **Software Keyboard** (see page 38) or using the number buttons for a number input. To save your settings, press the **BLUE** button.

- 4 Repeat step 3 for other video inputs.

Woofer setting

When an active Sub-Woofer is connected to the Woofer out connection on the back of the television, set the Woofer setting to **External**.

- 1 In the **AV Connection** menu, press **▼** to highlight **Woofer**.
- 2 Press **◀** or **▶** to select **External**.

PC Audio

In order to receive sound from a connected PC, plug the audio cable into the back of the television (as shown in the 'Connecting a computer' section), and then use the **PC/HDMI 3 Audio** setting.

- 1 In the **PREFERENCES** menu, press **▼** until **AV Connection** is highlighted, and then press **OK**.
- 2 Highlight **PC/HDMI 3 Audio**, and then use **▶** to select the **PC** option.

NOTE: Selecting the **PC** option will force HDMI 3 Audio to Digital mode.

HDMI 3 Audio

If the connected HDMI source does not support digital audio, plug the audio cable into **PC/HDMI 3 (AUDIO)** on the back of the television (as shown in the 'Connecting an HDMI® or DVI device to the HDMI input' section), then use the **HDMI 3 Audio** setting.

- 1 In the **AV Connection** menu, press **▼** to highlight **PC/HDMI 3 Audio** and using **▶** select **HDMI 3**.
- 2 Then highlight **HDMI 3 Audio**, and using **◀** or **▶** select **Auto** or **Analogue**.

AV Connection	
Input Labeling	
PC/HDMI 3 Audio	HDMI 3
HDMI 3 Audio	◀ Auto ▶
HDMI Settings	
EXT 2 Input	AV
Woofer	Internal
Digital Audio Output	Auto

If the sound is absent, try selecting a different setting.

NOTE: HDMI 3 supports digital and analogue sound, HDMI 1, HDMI 2 and HDMI 4 are digital sound only.

Certain DVD disk formats may not output from this TV (32/44.1/48kHz and 16/20/24 bits are acceptable).

HDMI Settings

Some early HDMI equipment may not work properly with your HDMI TV. Please try setting the **Enable Content Type** and **INSTAPORT™** options to **Off**. Adjusting these settings should allow your early HDMI source to operate properly with your television.

- 1 In the **PREFERENCES** menu, press ▼ until **AV Connection** is highlighted, and then press **OK**.
- 2 Press ▼ to highlight **HDMI Settings** and press **OK**.
NOTE: **HDMI Settings** is grayed out on non-HDMI inputs.
- 3 Press ▲ or ▼ to select an item, and then press ◀ or ▶ to select a setting.

HDMI Settings	
Enable Content Type	On
INSTAPORT™	On
RGB Range	Auto

• Enable Content Type: On

This feature is part of the HDMI 1.4 standard.

When set to On, the TV will automatically adjust settings according to the content type data sent from the connected HDMI device.

• INSTAPORT™: On

This feature reduces the lag time when switching HDMI sources.

• RGB Range: Auto

This feature adjusts RGB full range signal automatically. When **Limited** is selected, RGB signal is output in the range from 16 to 235. When **Full** is selected, RGB signal is output in the range from 0 to 255.

NOTE:

- If your HDMI connection is capable of 1080p and/or your television is capable of refresh rates greater than 50Hz or supports Deep Colour, you will need a Category 2 cable. Conventional HDMI/DVI cables may not work properly with this mode.
- All of the above HDMI settings need proper HDMI source devices.
If the HDMI source products do not support these features, the television may not work properly by activating these features.

Digital Audio Output

When connecting a surround sound amplifier to the digital audio output (Sony/Philips Digital Interface Format [S/PDIF]), the following options can be selected.

PCM: this mode outputs PCM format to the digital audio output socket.

Auto: this mode outputs Dolby Digital (if available) or PCM to the digital audio output socket.

Dolby Digital → Dolby Digital
Dolby Digital Plus → Dolby Digital
MPEG → PCM
HE-AAC → Dolby Digital

- 1 In the **AV Connection** menu, press ▼ to select **Digital Audio Output**.

AV Connection	
Input Labeling	
PC/HDMI 3 Audio	HDMI 3
HDMI 3 Audio	Auto
HDMI Settings	
EXT 2 Input	AV
Woofer	Internal
Digital Audio Output	Auto

- 2 Use ◀ or ▶ to select **PCM** or **Auto**.

Using REGZA-LINK

This is a new feature that uses CEC technology and allows you to control Toshiba REGZA-LINK compatible devices from the television remote control via HDMI connection (page 11).

When the **Enable REGZA-LINK** item in the **REGZA-LINK Setup** menu is set to **On**, individual functions also set to **On** will be activated.

Enable REGZA-LINK

- 1 Press **MENU** and ◀ or ▶ to select the **PREFERENCES** menu.
- 2 Press ▼ to select **REGZA-LINK Setup** and press **OK**.
- 3 Press ▼ to highlight **Enable REGZA-LINK**, and then press ◀ or ▶ to select **On**.

REGZA-LINK Setup		
Enable REGZA-LINK	◀	On ▶
TV Auto Power		On
Auto Standby		On
Amplifier Control		On
Speaker Preference		TV Speakers

NOTE: If you set **Enable REGZA-LINK** to **Off**, all other items will be grayed out.

TV Auto Power

The **TV Auto Power** setting allows the television to be automatically switched on if a REGZA-LINK device is turned on.

- 1 In the **REGZA-LINK Setup** menu, press ▼ to highlight **TV Auto Power**.
- 2 Press ◀ or ▶ to select **On** or **Off**.

Auto Standby

When **Auto Standby** is enabled, the television, when switched off, will automatically switch off (standby mode) all connected REGZA-LINK equipment.

- 1 In the **REGZA-LINK Setup** menu, press ▼ to highlight **Auto Standby**.
- 2 Press ◀ or ▶ to select **On** or **Off**.

Amplifier Control

When **Amplifier Control** is set to **On**, it allows the **“Speaker Preference”** feature to become available.

- 1 In the **REGZA-LINK Setup** menu, press ▼ to highlight **Amplifier Control**.
- 2 Press ◀ or ▶ to select **On** or **Off**.

Speaker Preference

This feature allows the audio output preference to be set to the TV speakers or AV amplifier speakers. The AV Amplifier option lets the television’s remote control adjust or mute the volume of the audio.

- 1 In the **REGZA-LINK Setup** menu, press ▼ to highlight **Speaker Preference**.
- 2 Press ◀ or ▶ to select **TV Speakers** or **Amplifier**.

REGZA-LINK input source selection

If a REGZA-LINK device with HDMI switching capability (e.g. AV amplifier) is connected to the HDMI input, you can select another REGZA-LINK device that is connected to the master HDMI device on the input source list.

- 1 Press **↻** and a list will appear on screen showing available input sources.
- 2 Press ▼ to select the desired input source with REGZA-LINK icon.
- 3 Press ▶ and a second selection screen will appear showing all connected REGZA-LINK equipment.

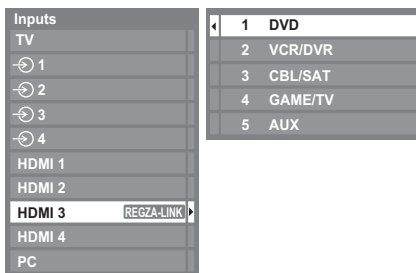

- 4 Press ▲ or ▼ to select the desired input source, and then press **OK**.

NOTE:

- These functions depend on the device connected.
- If you select the REGZA-LINK input source from the popup window, some REGZA-LINK devices may automatically turn on.
- When the television is switched on it will take a few minutes for the REGZA-LINK icon to appear in the list. When an HDMI cable is removed, it will take a few minutes for the icon to disappear.
- If the HDMI cable from connected equipment is changed, **Enable REGZA-LINK** in the REGZA-LINK Setup menu may need to be reset to **On**.
- If you change the HDMI lead to a connected device or change an HDMI device setting, reset the **Enable REGZA-LINK** item on the REGZA-LINK Setup menu from **Off** to **On**.

REGZA-LINK playback device control

With the REGZA-LINK mode on your television's remote control, you can control the connected REGZA-LINK playback device you are watching.

Remote Control CT-90344

To control the REGZA-LINK input source first select the equipment by REGZA-LINK input source selection, and then switch the mode on the remote control to **REGZA-LINK** and press a button.



See page 7 for details on available remote control key functions.

Remote Control CT-90345

To control the REGZA-LINK input source first select the equipment by REGZA-LINK input source selection.

Available remote control keys



See page 8 for details on available remote control key functions.

NOTE: The available functions depend on the equipment connected. All of the remote control keys may not be available. Please refer to the operation manual for each piece of equipment connected.

REGZA-LINK one touch play

When connected equipment is switched on, REGZA-LINK will automatically detect the television through the input selection. If the television is in standby, it will be switched on automatically.

These functions can be enabled or disabled from the REGZA-LINK Setup (see page 66).

NOTE:

- Even if the equipment is showing a menu, the television may automatically show the input source.
- This feature depends on the connected equipment and television state.

REGZA-LINK system standby

If the television is turned off (standby mode), the television will send a message to turn off (standby mode) all of the REGZA-LINK devices connected to the television.

These functions can be enabled or disabled from the REGZA-LINK Setup (see page 66).

NOTE: This feature depends on the connected equipment and television state.

REGZA-LINK system audio control

With your television's remote control, you can adjust or mute the sound volume of the speakers connected to the television via an AV amplifier. First, set the remote control mode switch to **REGZA-LINK**.

- 1 Set the **Speaker Preference to Amplifier** in the **REGZA-LINK Setup** menu.
- 2 Confirm that a connected REGZA-LINK device (such as a DVD player, etc) is selected for the AV amplifier input source.

NOTE:

- These functions depend on the device connected.
- When you turn on the AV amplifier, change its input source, or adjust the sound volume, the sound will be output from the AV amplifier's speakers even if **TV Speakers** has been selected. Turn the television off and on again to output the sound from the TV Speakers.
- This feature may not work if the AV amplifier is operated.

Toshiba PC compatible with REGZA-LINK

This feature automatically adjusts the suitable widescreen formats and picture preferences when connected to a Toshiba PC compatible with REGZA-LINK.

NOTE: This feature depends on the connected equipment state.

Text services

This television has a multi-page text memory, which takes a few moments to load. It offers two **Modes** of viewing text – **Auto** will display **Fasttext**, if available. **LIST** will save your four favourite pages.

Selecting modes

The text character set will be automatically chosen by the language setting in the **SETUP** menu.

- 1 In the **PREFERENCES** menu, select **Teletext**.
- 2 With ◀ or ▶ choose **Auto** or **LIST** then press **EXIT**.

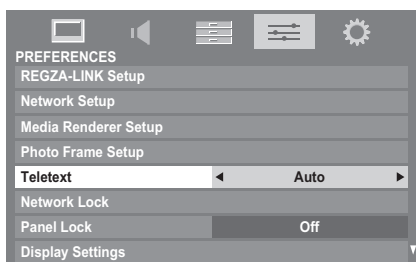

Text information

The **TEXT** button:

To view text services press **TEXT**. Press again to superimpose the text over a normal broadcast picture and again to return to normal viewing. Channels cannot be changed until text is cancelled.

The first text page shown will be the *initial* page.

Any text page can be accessed by entering the 3 digit page number using the numbered buttons, pressing the coloured buttons or pressing **P^** to advance to the next page and **Pv** to go back to the previous page.

Sub-pages

The pages on the screen will dynamically update as sub-pages are received.

If you open a page containing sub-pages, the sub-pages are automatically displayed in sequence. To quit automatic sub-page change, press ◀ or ▶.

Once selected, the sub-page you are viewing will be highlighted and, as the television loads any additional sub-pages, the colour of the numbers will change, indicating that these pages have been loaded.

These sub-pages will remain available to view until another page is chosen or, in normal TV mode, the channel is changed.

Navigating pages using Auto

If **Fasttext** is available, four coloured titles will appear at the base of the screen.

To access one of the four given subjects, press the relevant coloured button on the remote control.

For further information on your particular text system(s), see the broadcast text index page or, consult your local Toshiba dealer.

Navigating pages using LIST

The four coloured choices at the bottom of the screen are numbers – 100, 200, 300 and 400, which have been programmed into the television's memory. To view these pages, press the relevant coloured buttons.

To change these saved pages, press the relevant coloured button and enter the 3 digit number. This number will change in the top left of the screen and in the coloured highlight.

Press **OK** to save. **Whenever **OK** is pressed, all four page numbers showing at the bottom will be saved and the previous ones will be lost.**

If **OK** is not pressed, the selection will be forgotten when the channel is changed.

Other pages may be viewed by entering the 3 digit page number – but **DO NOT** press **OK** or these pages will be saved.

Control buttons

Below is a guide to the functions of the remote control text buttons.

To display the index/initial page:

Press  to access the index/initial page. The one displayed is dependant on the broadcaster.



TEXT To display a page of text:

Press **TEXT** to display text. Press again to superimpose text over a normal picture. Press again to return to normal television viewing. Channels cannot be changed until this has been done.

To reveal concealed text:

To discover the solutions on quiz and joke pages press the  button.



To hold a wanted page:

At times it is convenient to hold a page of text. Press  and  will appear in the top left of the screen. The page will be held on screen until the button is pressed again.

To enlarge the text display size:

Press  once to enlarge the top half of the page, press again to enlarge the bottom half of the page. Press again to revert to normal size.

/ **To select a page whilst viewing normal picture:**

Enter the page number then press / , normal picture will be displayed. The television will indicate when the page is ready by changing the colour of the page number at the top of the screen. Press **TEXT** to view the page.

To display news flashes:

Select the news flash page for the chosen text service (see the index page of text service). The news flashes will be displayed as and when they are broadcast.



Remember to cancel text before changing channels - press the TEXT button twice.

Questions and Answers

Below are the answers to some of the most common queries.

Q *Why is there no sound or picture?*

A Check the television is not in standby mode. Check the mains plug and all mains connections.

Q *There is a picture, but why is there little or no colour?*

A When using an **external** source, for instance, a poor quality video tape, if there is little or no colour, improvements may sometimes be achieved. The colour is factory set to **Auto** to automatically display the best colour system.

To check that you have the best colour:

1 With the external source playing, select **Colour System** from the **SETUP** menu.



2 With ◀ or ▶ choose between **Auto**, **PAL**, **SECAM**, **NTSC 4.43** or **NTSC 3.58**.

Q *Why doesn't the video/DVD being played show on screen?*

A Make sure the media recorder or DVD player is connected to the television as shown on page 9, and then select the correct input by pressing **◀**.

Q *Why is there a picture but no sound?*

A Check all lead connections. No sound or unacceptable format sound may be received. Check the volume has not been turned down or that sound mute has not been selected.

Q *Why is the VCR/DVD picture in black and white?*

A Check that the correct **EXT 2** input setting has been chosen, **S-VIDEO** or **AV**. See **AV Connection** on page 63.

Q *What else can cause a poor picture?*

A Interference or a weak signal. Try a different television station. **Manual Fine Tuning** may help.

1 Select the **ATV Manual Tuning** menu. Highlight the station and press **OK**. Then press ▶ to select **Manual Fine Tuning**.

2 Using ▲ or ▼ adjust to get the best picture and sound. Press **OK** and then **EXIT**.



Q *Why don't the controls of the television work?*

A Check that **Panel Lock** is not **On**.

Q *Why doesn't the remote control work?*

A Check that the mode switch on the remote control is in TV mode. Check that the batteries aren't dead or inserted incorrectly.

Q *Why is the digital channel locked?*

A The channel has been locked in **Channel Options** (see 'Digital Settings' section).

Q *Why are some of the digital subscription channels unavailable?*

A Your subscription needs upgrading. Contact your service provider.

Q *Why is the soundtrack in English when a different audio language has been selected?*

A The programme is currently being broadcast with an English soundtrack only.

Q *Why is there incorrect or no sound when in DTV mode?*

A Press **◻/I** to ensure the hard of hearing option has not been selected.

Q What is DVB-T?

A Digital Video Broadcast via an aerial/antenna.

Q What is DVB-C?

A Digital Video Broadcast via a cable connection.

Q How are radio channels selected?

A Press **TV** on the remote control and select **DTV RADIO**. Alternatively select from the **GUIDE**.

Q What can be done if the PIN number has been forgotten?

A Use the Master PIN code of 1276, then change to a number of your choice. Select **PIN Settings** from the **DTV Setting** menu to enter PIN. Ensure that no-one else can use the Master PIN by removing the Owner's Manual.

Q Why are there vertical stripes on the screen when in PC mode?

A The **Sampling Clock** may need adjustment. Select **PC Settings** from the **Display Settings** menu, highlight **Sampling Clock** and adjust until the lines clear.

Q Why are there horizontal stripes and/or blurred images on the screen when in PC mode?

A The **Clock Phase** may need adjustment. Select **PC Settings** from the **Display Settings** menu, highlight **Clock Phase** and adjust until the picture clears.

Q Why when digital subtitles have been selected are they not showing on screen?

A Subtitles are not currently being transmitted by the broadcaster.

Q Why are there problems with analogue text?

A Good performance of text depends on a good strong broadcast signal. This normally requires a roof or loft aerial. If the text is unreadable or garbled, check the aerial. Go to the *main index* page of the text service and look for the *User Guide*. This will explain the basic operation of text in some detail. If further information is needed on how to use text see the *text section*.

Q Why is a page number visible at the top of the screen but no text?

A Text has been selected but Teletext information is currently unavailable on the current source.

Q Why are the colours wrong when an NTSC source is played?

A Connect the source via a SCART lead and play. Select **Colour System** from the **SETUP** menu.

1 Set the Colour to **Auto** and exit.

2 Go to the **PICTURE** menu and adjust the tint.

Q Why don't the devices connected via HDMI operate properly?

A Make sure to use cables with the HDMI logo  (see page 10).

Some early HDMI equipment may not work properly with the latest HDMI TV products, due to new standard adoption. Try switching the HDMI settings (**Enable Content Type** and **INSTAPORT™**) to **Off**.

Q Why don't the REGZA-LINK devices work?

A When the connected REGZA-LINK device does not work correctly after you have changed the settings of the device, turn off your television and unplug the power cord, and then plug and turn on again. Unplug the HDMI cable of the REGZA-LINK device and lead again.

Q Why is the REGZA-LINK logo still showing when the equipment has been disconnected?

A If the REGZA-LINK device is disconnected, the logo will disappear after approximately one minute.

Q Why don't the networked devices work?

A The LAN cables are not connected properly or at all. Connect all cables (see page 13). Make sure your network address is set up correctly (see page 36).

Q Why doesn't the wireless network work?

A Make sure the TOSHIBA Dual Band WLAN Adaptor is used (see page 13). Check that the AP is powered on.

Q Why doesn't the Media Player feature operate?

A Make sure that devices are connected correctly. Incorrect behavior may occur with a USB Hub connection.

Q What do the LEDs on the front of the television indicate?

A Check the table below.

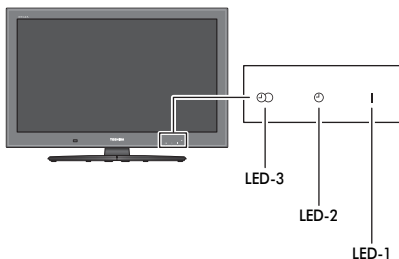

LED indication			Condition	Solution
LED-3	LED-2	LED-1		
Orange (Solid)	Green (Solid)	Green (Solid)	Power ON On Timer is set Programme Timer is set	-
Red (Solid)	Green (Solid)	Green (Solid)	Power ON On Timer is set Programme Timer is active	-
OFF	Green (Solid)	Green (Solid)	Power ON On Timer is set Programme Timer is NOT set	-
Orange (Solid)	OFF	Green (Solid)	Power ON On Timer is NOT set Programme Timer is set	-
Red (Solid)	OFF	Green (Solid)	Power ON On Timer is NOT set Programme Timer is active	-
OFF	OFF	Green (Solid)	Power ON On Timer is NOT set Programme Timer is NOT set	-
Orange (Solid)	Green (Solid)	Red (Solid)	Power OFF (Standby) On Timer is set Programme Timer is set	-

LED indication			Condition	Solution
LED-3	LED-2	LED-1		
Red (Solid)	Green (Solid)	Red (Solid)	Power ON (Standby) On Timer is set Programme Timer is active	-
OFF	Green (Solid)	Red (Solid)	Power OFF (Standby) On Timer is set Programme Timer is NOT set	-
Orange (Solid)	OFF	Red (Solid)	Power OFF (Standby) On Timer is NOT set Programme Timer is set	-
Red (Solid)	OFF	Red (Solid)	Power ON (Standby) On Timer is NOT set Programme Timer is active	-
OFF	OFF	Red (Solid)	Power OFF (Standby) On Timer is NOT set Programme Timer is NOT set	-
OFF	OFF	Green (Blinks)	Abnormal operation of BUS line.	Turn OFF the TV and unplug the power cord. Plug the power cord in again and turn ON the TV.
OFF	OFF	Red (Blinks)	Abnormal operation of WDT.	
OFF	Green (Blinks)	OFF	Fan stopped. (if applicable)	
OFF	OFF	Orange (Blinks)	Back Light error.	

> IN NEED OF HELP

IF YOU ARE EXPERIENCING ANY DIFFICULTIES PLEASE VISIT WWW.TOSHIBA.CO.UK/FAQ

OR CONTACT THE TOSHIBA CUSTOMER HELPLINE ON **0844 856 0730**

License Information



Manufactured under license from Dolby Laboratories.



Dolby and the double-D symbol are registered trademarks of Dolby Laboratories.



HDMI, the HDMI logo, and High-Definition Multimedia Interface are trademarks or registered trademarks of HDMI Licensing, LLC.

INSTAPORT™ and INSTAPORT logo are trademarks of Silicon Image, Inc. in the United States and other countries.



SD Logo is a trademark.

YouTube and the YouTube Logo are trademarks of Google Inc. This product contains NetFront Browser of ACCESS CO., LTD.



ACCESS, the ACCESS logo and NetFront are trademarks or registered trademarks of ACCESS CO., LTD. in the United States, Japan and other countries.



© 2010 ACCESS CO., LTD. All rights reserved. This software is based in part on the work of the Independent JPEG Group.

This product contains Adobe® Flash® Player software under license from Adobe Systems Incorporated. Copyright © 1995-2009 Adobe Systems Incorporated. All rights reserved. Adobe and Flash are trademarks of Adobe Systems Incorporated.

MPEG Layer-3 audio coding technology licensed from Fraunhofer IIS and Thomson.

DivX® is a registered trademark of DivX, Inc., and is used under license.

Covered by one or more of the following U.S. Patents: 7,295,673; 7,519,274; 7,515,710

DVB is a registered trademark of the DVB Project.

DLNA®, the DLNA Logo and DLNA CERTIFIED™ are trademarks, service marks, or certification marks of the Digital Living Network Alliance.

THIS PRODUCT IS LICENSED UNDER THE AVC PATENT PORTFOLIO LICENSE FOR THE PERSONAL AND NONCOMMERCIAL USE OF A CONSUMER TO (i) ENCODE VIDEO IN COMPLIANCE WITH THE AVC STANDARD (AVC VIDEO) AND/OR (ii) DECODE AVC VIDEO THAT WAS ENCODED BY A CONSUMER ENGAGED IN A PERSONAL AND NONCOMMERCIAL ACTIVITY AND/OR WAS OBTAINED FROM A VIDEO PROVIDER LICENSED TO PROVIDE AVC VIDEO. NO LICENSE IS GRANTED OR SHALL BE IMPLIED FOR ANY OTHER USE. ADDITIONAL INFORMATION MAY BE OBTAINED FROM MPEG LA, L.L.C.

SEE [HTTP://WWW.MPEGLA.COM](http://www.mpegla.com)



Audyssey EQ technology (VL/WL series EQ only)

Manufactured under license from Audyssey Laboratories. U.S. and foreign patents pending. Audyssey EQ is a registered trademark of Audyssey Laboratories.

Audyssey EQ is based on the award-winning Audyssey MultEQ technology. It is the first-ever room equalization solution that can achieve optimum sound for a large listening area and it is featured in many high end home theater products. Audyssey EQ is used in the TV tuning process to calculate an equalization solution that corrects time and frequency response problems in TV systems. This results in clear, rich sound with more intelligible dialog.

Cleaning the screen and cabinet...

Turn off the power, clean the screen and cabinet with a soft, dry cloth. We recommend that you **do not** use any proprietary polishes or solvents on the screen or cabinet as this may cause damage.

Disposal...

The following information is only for EU-member states:

Disposal of products

The crossed out wheeled dust bin symbol indicates that products must be collected and disposed of separately from household waste. Integrated batteries and accumulators can be disposed of with the product. They will be separated at the recycling centres.

The black bar indicates that the product was placed on the market after August 13, 2005.

By participating in separate collection of products and batteries, you will help to assure the proper disposal of products and batteries and thus help to prevent potential negative consequences for the environment and human health.

For more detailed information about the collection and recycling programmes available in your country, please contact your local city office or the shop where you purchased the product.



Disposal of batteries and/or accumulators

The crossed out wheeled dust bin symbol indicates that batteries and/or accumulators must be collected and disposed of separately from household waste.

If the battery or accumulator contains more than the specified values of lead (Pb), mercury (Hg), and/or cadmium (Cd) defined in the Battery Directive (2006/66/EC), then the chemical symbols for lead (Pb), mercury (Hg) and/or cadmium (Cd) will appear below the crossed out wheeled dust bin symbol.

By participating in separate collection of batteries, you will help to assure the proper disposal of products and batteries and thus help to prevent potential negative consequences for the environment and human health.

For more detailed information about the collection and recycling programmes available in your country, please contact your local city office or the shop where you purchased the product.



Hg Cd Pb

Information

Before connecting any external equipment, turn off all main power switches. If there is no switch, remove the mains plug from the wall socket.

Signal information for Mini D-sub 15 pin connector

Pin No.	Signal name	Pin No.	Signal name	Pin No.	Signal name
1	R	6	Ground	11	NC
2	G	7	Ground	12	NC
3	B	8	Ground	13	H-sync
4	NC*	9	NC	14	V-sync
5	NC	10	Ground	15	NC

* NC = not connected

Acceptable PC signals through the PC terminal

The PC input on this TV only accepts signal formats which are compliant with VESA-DMT as shown in the table below. Since some PCs input signals which are different from the resolution and frequency described in the table below, the following phenomenon may occur; incorrect display, false format detection, picture position failure, blur, or judder. In this case, set the monitor output format on your PC to conform to a signal in the table below.

Format	Resolution	V. Frequency	H. Frequency	Pixel Clock Frequency	VESA Standard (DMT)
VGA	640 × 480	59.940Hz	31.469kHz	25.175MHz	●
		72.809Hz	37.861kHz	31.500MHz	●
		75.000Hz	37.500kHz	31.500MHz	●
SVGA	800 × 600	56.250Hz	35.156kHz	36.000MHz	●
		60.317Hz	37.879kHz	40.000MHz	●
		72.188Hz	48.077kHz	50.000MHz	●
		75.000Hz	46.875kHz	49.500MHz	●
XGA	1024 × 768	60.004Hz	48.363kHz	65.000MHz	●
		70.069Hz	56.476kHz	75.000MHz	●
		75.029Hz	60.023kHz	78.750MHz	●
WXGA	1280 × 768	59.995Hz	47.396kHz	68.250MHz	●
		59.870Hz	47.776kHz	79.500MHz	●
		74.893Hz	60.289kHz	102.250MHz	●
	1360 × 768	60.015Hz	47.712kHz	85.500MHz	●
SXGA	1280 × 1024	60.020Hz	63.981kHz	108.000MHz	●
		75.025Hz	79.976kHz	135.000MHz	●

Acceptable video or PC signals through the HDMI terminals

The HDMI inputs on this TV only accept VGA, SVGA, XGA, WXGA, and SXGA signal formats which are compliant with VESA as shown in the table below. Since some PCs and HDMI or DVI devices input signals which are different from the resolution and frequency described in the table below, the following phenomenon may occur; incorrect display, false format detection, picture position failure, blur, or judder. In this case, set the monitor output format on your PC, HDMI or DVI device to conform to a signal in the table below.

Format	Resolution	V. Frequency	H. Frequency	Pixel Clock Frequency	VESA Standard
480i	720 × 480i	59.940/60.000Hz	15.734/15.750kHz	27.000/27.027MHz	
576i	720 × 576i	50.000Hz	15.625kHz	27.000MHz	
480p	720 × 480p	59.940/60.000Hz	31.469/31.500kHz	27.000/27.027MHz	
576p	720 × 576p	50.000Hz	31.250kHz	27.000MHz	
1080i	1920 × 1080i	59.940/60.000Hz	33.716/33.750kHz	74.176/74.250MHz	
1080i	1920 × 1080i	50.000Hz	28.125kHz	74.250MHz	
720p	1280 × 720p	59.940/60.000Hz	44.955/45.000kHz	74.176/74.250MHz	
720p	1280 × 720p	50.000Hz	37.500kHz	74.250MHz	
1080p	1920 × 1080p	59.940/60.000Hz	67.433/67.500kHz	148.352/148.500MHz	
1080p	1920 × 1080p	50.000Hz	56.250kHz	148.500MHz	
1080p	1920 × 1080p	24.000Hz	27.000kHz	74.250MHz	
VGA	640 × 480	59.940/60.000kHz	31.469/31.500kHz	25.175/25.200MHz	●
		72.809Hz	37.861kHz	31.500MHz	●
		75.000Hz	37.500kHz	31.500MHz	●
SVGA	800 × 600	56.250Hz	35.156kHz	36.000MHz	●
		60.317Hz	37.879kHz	40.000MHz	●
		72.188Hz	48.077kHz	50.000MHz	●
		75.000Hz	46.875kHz	49.500MHz	●
XGA	1024 × 768	60.004Hz	48.363kHz	65.000MHz	●
		70.069Hz	56.476kHz	75.000MHz	●
		75.029Hz	60.023kHz	78.750MHz	●
WXGA	1280 × 768	59.995Hz	47.396kHz	68.250MHz	●
		59.870Hz	47.776kHz	79.500MHz	●
		74.893Hz	60.289kHz	102.250MHz	●
SXGA	1360 × 768	60.015Hz	47.712kHz	85.500MHz	●
		60.020Hz	63.981kHz	108.000MHz	●
SXGA	1280 × 1024	75.025Hz	79.976kHz	135.000MHz	●

Specifications and accessories

DVB-T Broadcast systems/channels		Broadcast systems/channels	
UK	UHF 21-68	PAL-I	UHF UK21-UK69
France	VHF 05-10 (VHF 01-05)	PAL-B/G	UHF E21-E69
	UHF 21-69		VHF E2-E12, S1-S41
Germany	VHF 05-12	SECAM-L	UHF F21-F69
	UHF 21-69		VHF F1-F10, B-Q
Austria	VHF 05-12	SECAM-D/K	UHF R21-R69
	UHF 21-69		VHF R1-R12
Switzerland	VHF 05-12		
	UHF 21-69		
Italy	VHF 05-12 (D,E,F,G,H,H1,H2)		
	UHF 21-69		
Spain	UHF 21-69		
Netherlands	VHF 05-12		
	UHF 21-69		
Greece	VHF 05-12		
	UHF 21-69		

Video Input PAL, SECAM, NTSC 3.58/4.43

External connections

EXT 1	Input	21-pin SCART	RGB, A/V
EXT 2	Input	21-pin SCART	A/V, S-video
EXT 3	Input	Phono jacks	Y, P _B /C _B , P _R /C _R
		Phono jacks	Audio L + R
EXT 4	Input (Side)	Phono jack	Video
		Phono jacks	Audio L + R
HDMI 1/2/3	Input	HDMI [®] (Enable Content Type, INSTAPORT™, RGB Range, supported)	
HDMI 4	Input (Side)	HDMI [®] (Enable Content Type, INSTAPORT™, RGB Range, supported)	
PC	Input	Mini D-sub 15-pin Analog RGB signal	
PC/HDMI 3	Audio	3.5mm mini jack	Audio
Digital Audio Output (S/PDIF)		Optical	
Output to Active Sub-Woofer (SL/WL series only)		Phono jack	
Variable Audio Output (SL/WL series only)		Phono jacks	Audio L + R
LAN port		RJ-45	
USB 1 port		Media Player	
		Interface version: USB 2.0	
		USB class: Mass Storage	
		File system: FAT12, FAT16 and FAT32	
USB 2 port		Wireless LAN adaptor ready for a home network, IEEE802.11a/b/g/n compatible	
		Interface version: SD (up to 2GB)	
		SDHC (4-32GB)	
SD card slot (SL/WL series only)		File system: FAT12, FAT16 and FAT32	

Stereo

Nicam
2 carrier system

Visible Screen Size (approx.)	Model	32	80cm	37	94cm	40	102cm	46	117cm	55	139cm		
		32RV	117W	40WL	170W	37RV	146W	46WL	190W	40RV	148W	55WL	196W
		32SL	113W	40SL	137W	46SL	151W						

Display

16:9

Sound output

(at 10% distortion)

Main 10W + 10W

Power consumption

(approx.)

32RV	117W	40WL	170W
37RV	146W	46WL	190W
40RV	148W	55WL	196W
32SL	113W		
40SL	137W		
46SL	151W		

Annual power consumption* (approx.)	32RV	132.3kWh	40WL	198.3kWh
	37RV	158.7kWh	46WL	225.7kWh
	40RV	166.1kWh	55WL	247.5kWh
	32SL	132.4kWh		
	40SL	170.2kWh		

On mode power consumption**

(approx.)

32RV	89.6W	40WL	135W
37RV	108W	46WL	154W
40RV	113W	55WL	168W
32SL	89.7W		
40SL	116W		
46SL	123W		

Standby power consumption (approx.)

32RV/37RV/40RV/32SL/40SL	0.2W
46SL/40WL/46WL/55WL	0.3W

Off mode power consumption (approx.)

<0.01W

* Operating 4 hours a day and 365 days a year.

** Tested in accordance with IEC 62087-BD Ed. 2.0:2008.

Dimensions

(approx.)

Model	32RV	58cm (H)	79cm (W)	29cm (D)
37RV	65cm (H)	90cm (W)	29cm (D)	
40RV	68cm (H)	98cm (W)	33cm (D)	
32SL	58cm (H)	82cm (W)	26cm (D)	
40SL	68cm (H)	101cm (W)	31cm (D)	
46SL	76cm (H)	114cm (W)	31cm (D)	
40WL	68cm (H)	101cm (W)	31cm (D)	
46WL	76cm (H)	114cm (W)	31cm (D)	
55WL	89cm (H)	134cm (W)	33cm (D)	

(Height dimension includes foot stand)

Weight (approx.)

Model	32RV	13.5kg	40WL	19.0kg
37RV	16.0kg	46WL	22.5kg	
40RV	18.5kg	55WL	30.0kg	
32SL	14.5kg			
40SL	19.0kg			
46SL	22.5kg			

Headphone socket

3.5mm stereo

Operating condition

Temperature 5°C - 35°C (41°F - 94°F)
Humidity 20 - 80% (non-condensing)

Supplied accessories

Remote control
2 batteries (AAA, IEC R03 1.5V)
'P' Clip
Cleaning cloth
TOSHIBA Dual Band WLAN Adaptor WLM-10U2 with Gooseneck cable (for WL series)
Standard: IEEE 802.11a/b/g/n
Host Interface: USB2.0 compatible
Frequency Range: 5.15-5.35 GHz, 5.47-5.725 GHz, 5.725-5.850 GHz, 2.412-2.462 GHz
Security: WEP64/128, TKIP, AES, WPA/WPA2-PSK, WPS, None

Optional accessories

TOSHIBA Dual Band WLAN Adaptor WLM-10U2 with Gooseneck cable (for RV/SL series)



© **TOSHIBA Television Central Europe Sp. z o.o.**

All rights reserved.

Reproduction in whole or part without written permission is strictly prohibited.

TOSHIBA Television Central Europe Sp. z o.o.

ul. Pokoju 1, Biskupice Podgórne, 55-040 Kobierzyce, Poland

Specification is subject to change without notice.