

Notice to the installer

Please give this manual to the customer after installation



WI-TOUCH™ Wireless Faucet Controller TEC1DS



TOTO®

TOTO U.S.A., Inc 1155 Southern Road, Morrow, GA 30260
(888) 295-8134 Fax: 800-699-4889
www.totousa.com

- Thank you for choosing TOTO products.
- Before you begin the installation, please read through this manual thoroughly in order to better understand the product and its functioning.
- Warranty information is included in this manual, please keep it in a secure place

Important Safeguards.....3-5 Model Numbers and Components.....6	Getting Started
Before Use.....7-9 How to Use.....10 How to Adjust.....11	How to Use
Maintenance12-18	Maintenance
Troubleshooting.....19-21 Specifications.....22	Trouble Shooting
Warranty23	

- 1) This device complies with Part 15 of the FCC Rules. Operation is subject to the following two conditions: (1) This device may not cause harmful interference, and (2) this device must accept any interference received, including interference that may cause undesired operation.
- 2) This equipment has been tested and found to comply with the limits for a Class B digital device, pursuant to Part 15 of the FCC Rules. These limits are designed to provide reasonable protection against harmful interference in a residential installation. This equipment generates, uses, and can radiate radio frequency energy and, if not installed and used in accordance with the instructions, may cause harmful interference to radio communications. However, there is no guarantee that interference will not occur in a particular installation. If this equipment does cause harmful interference to radio or television reception, which can be determined by turning the equipment off and on, the user is encouraged to try and correct the interference by one or more of the following measures:
- Reorient or locate the receiving antenna.
 - Increase the separation between the equipment and receiver.
 - Connect the equipment into an outlet on a circuit different from that to which the receiver is connected.
 - Consult the dealer or an experienced radio/TV technician for help.

Changes or modifications not expressly approved by Toto could void the user's authority to operate the equipment.











DECLARATION OF CONFORMITY



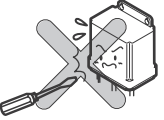

We Toto USA 5351 E. Jurupa St. Ontario, CA 91761 (909) 974-5678 declare under our sole responsibility that the product Wi-Touch Wireless Faucet Controller, Model TEC1DS complies with Part 15 of the FCC Rule.

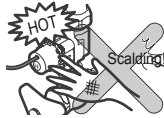



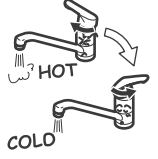
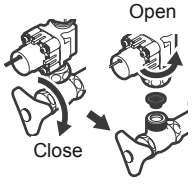
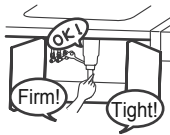
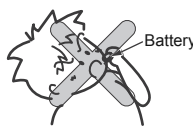
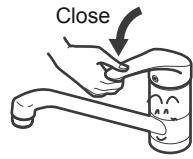

Operation is subject to the following conditions: 1) This devices may not cause harmful interference, and 2) this device must accept any interference received, including interference that may cause undesired operation.

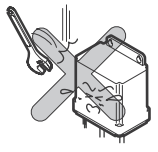
Important Safeguards

(For your safety, please follow the instructions below.)

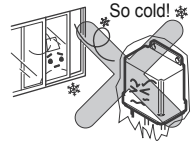
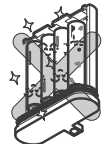
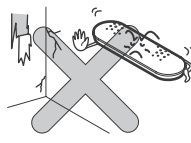
 Warning		
 Do Not	Do not allow the hot water temperature to exceed 140° F (60° C) or scalding may occur.	 Under 140° F (60° C)
	Do not modify or alter this product in any way. Failure to follow instructions may result in personal injury and/or property damage.	
	Do not use near medical equipment or devices which may be interfered with by the signal produced by this product. This product produces a signal utilizing 294MHz band, under 500µV/m.	
 Keep Dry	Do not install this product in rooms that are subject to high humidity, such as a bathroom containing a shower. Electric shock and/or failure of the product may occur.	
 Do Not Disassemble	Do not disassemble, modify, or attempt to repair this product yourself. Electric shock or fire may result.	
 Do Not Touch	A burn may result from contact with the hot water solenoid valve due to high temperature of water. Wear protective clothing.	
 Compulsory	Use a thermometer or similar method to check water temperature before using. Water temp should not exceed 140° F (60° C) or scalding may occur.	

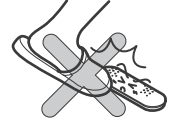
 Caution		
 Compulsory	It is suggested that, after using the hot water, the faucet should be returned to cold before turning off. This is to prevent the next person from scalding themselves on hot water left in the pipes.	
	Before cleaning the filter, make sure the hot water valve is closed and the solenoid valve has cooled. Otherwise scalding may occur.	
	It is important to check for leaks and loose pipe connections at least once every two years. Repair any leaks and tighten any loose fittings, or property damage may occur.	
	Keep the batteries in a safe place, beyond the reach of children. If ingested, contact a physician immediately.	
	If the product will not be used for an extended period of time (such as during a vacation), please turn off the faucet directly to ensure that water will not be wasted and that property damage will not occur.	
 Do Not	Do not allow any part of the product to be dropped or forcefully struck. The operation of the product may be affected resulting in fire, electrical shock, or property damage.	

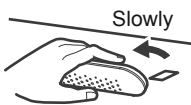
 Caution		
 Do Not	Do not allow the product to freeze or become wet. Do not install outdoors. Property damage may result. Warranty does not cover damage to the product due to freezing.	
	Always use fresh batteries in unit. Do not mix new and old batteries or use batteries of different brands together. Damage to the product may result from battery leakage.	
	Do not install product on a weak or easily damaged surface. Improperly secured items may damage surfaces if they come loose. Installation on wallpaper or similar wall treatments may result in tearing.	
 Compulsory	Once the adhesive film has been used it cannot be removed and reused. Use a new piece after cleaning surface.	
	Do not install the remote control where it can be tripped over. It is most commonly installed on the toe plate just under the cabinet.	
	If the remote control is installed on a plastic vinyl chloride surface, use the adhesive base strips to secure it in place.	
	In order not to damage the floor or cabinet surface while replacing the batteries in the remote control, use gentle pressure and move slowly to remove it.	

Model Number and Components

TEC1DS#GY: WI-TOUCH™
Wireless Faucet Controller

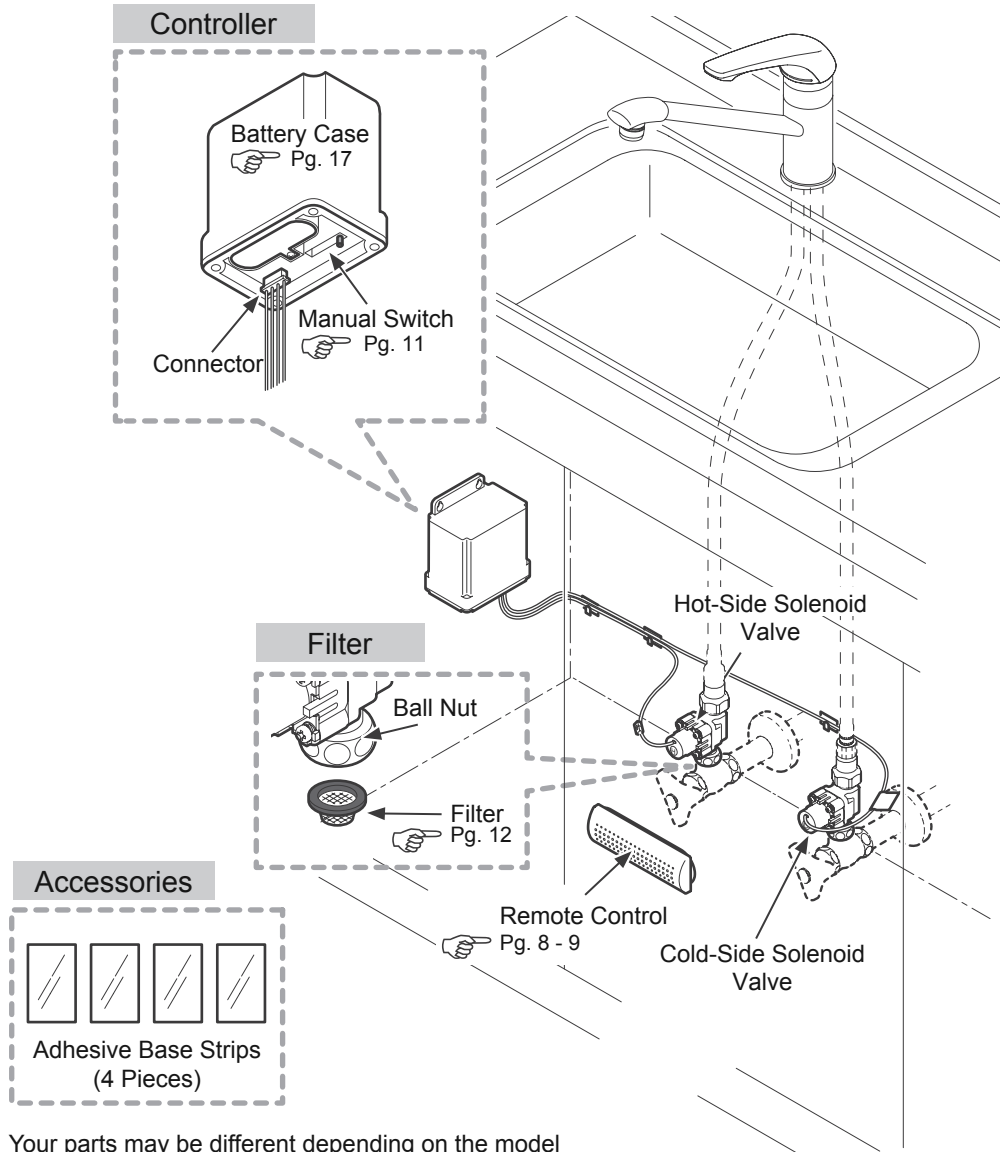

Your parts may be different depending on the model

Before Use

Check the Shut-off valve

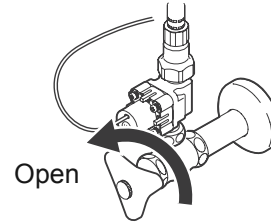

Open the shut-off valve
Check both the cold and hot shut off valves.

Check the Batteries

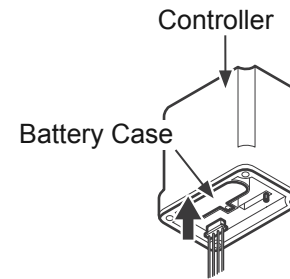

Check that the battery case is completely inserted in the controller.

Check the Connector

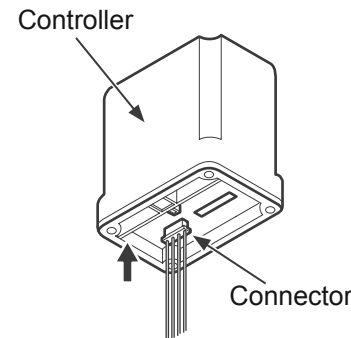

Check the connectors.
Check that the cords of the solenoid valves are firmly connected to the controller.

Be Careful

Make sure that none of the cords touch the hot side solenoid valve or any metal that is heated. Cords may melt and cause product to malfunction

Installation of the Remote Control

Be Careful

- Do not install the remote control or the controller on a metal surface, such as stainless steel. Product may malfunction if the signal is reflected or hindered. Likewise, it may not do well in a kitchen with numerous stainless steel appliances.
- Do not cover the remote control or the controller with metal such as aluminum foil. Metal will reflect the signal, causing the product to malfunction.
- Test the signal before you decide upon a permanent location for the product. Make sure it will work properly. The remote control should be within 3 feet (1 meter) of the controller.
- Make sure the remote control is secure and in a safe place before using. If it falls or is kicked, it may be damaged. It should not be installed where it might become a trip hazard.
- If the remote control is to be installed on a plastic vinyl chloride surface, use the adhesive strips as a base to secure it. This should prevent discoloration of the surrounding material. The bottom of the next page has a diagram showing the placement of the strips.
- Do not install the remote control in front of any air vents or heaters.
- Do not use near an electric converter or transformer. It may malfunction.
- Close proximity to a TV or radio may cause this product to malfunction.

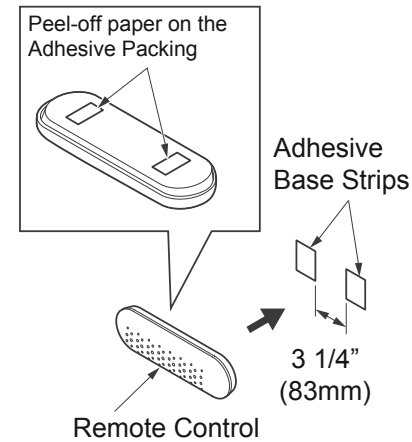

1. Install the battery in the remote control.
2. Adhere 2 adhesive base strips at the installation location. Set the distance between them to 3 1/4" (83mm). See bottom of page.
3. Expose the adhesive packing on the back of the remote by peeling off the protective paper.
4. Firmly press the adhesive packing of the remote control against the adhesive base strips.

Recommended locations of the remote control

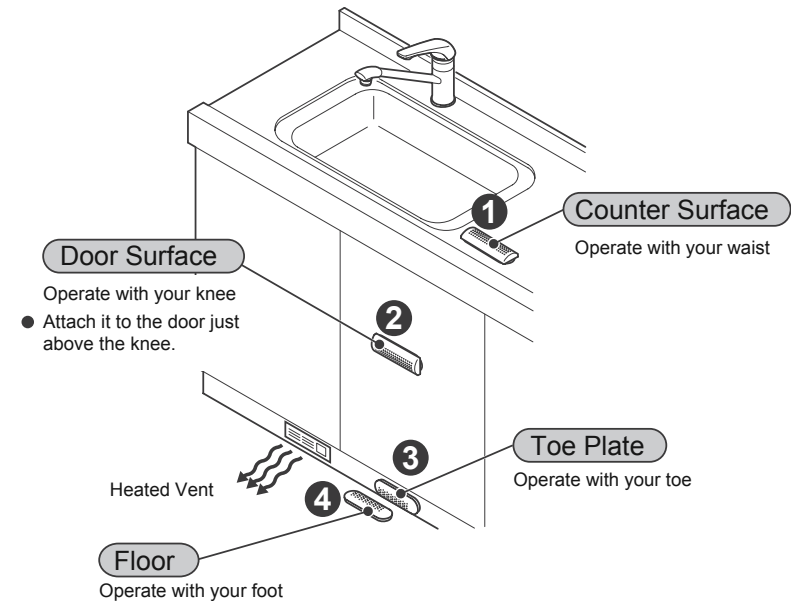

Location for the Adhesive Base Strips

Use this template to gauge the spacing for the adhesive base strips.

3 1/4"
(83 mm)

How to Use

Turning the Water On and Off

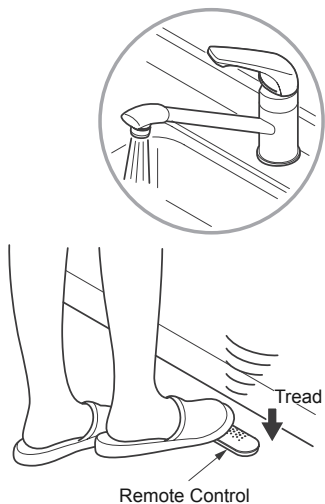

- 1. Open the faucet and leave it in the open position.**
- 2. Push the remote control. (tread)**
Water then flows out. Use the handle of the faucet to adjust the flow rate and temperature.
- 3. Push the remote control again. (tread)**
Water stops flowing.

- Please adjust the flow rate and temperature of the faucet in advance.
- If the product will not be used for an extended period (such as a vacation), turn off the faucet.
- The water will automatically stop in about 10 minutes if you leave it running. This setting can be changed to 8 hours if you have a dishwasher attached. (See page 11)
- Use the remote control gently. Kicking it or hitting it forcefully may damage it.
- Battery longevity is dependant on the frequency of usage of the product.

How to Adjust

Change Timer Setting

(If both faucet and dish washer share same supply line)

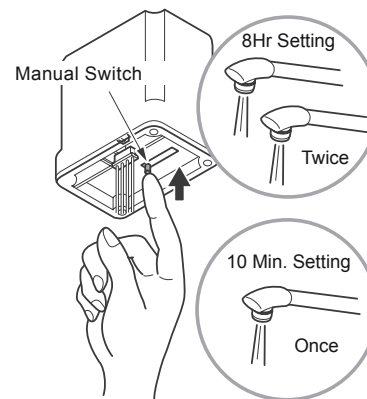

To change back to 10 minutes, repeat the steps above. When the timer setting is changed to 10 minutes, the water will flow out once from the spout.

- 1. Open the faucet to a position where water can flow out.**
- 2. Stop the water flow with the remote control.**
The solenoid valves are closed.
- 3. Hold down the manual switch of the controller for 20 seconds.**

When water starts flowing out, keep pushing the switch for another 20 seconds. When the timer setting is changed to 8 hours, water will flow out twice from the spout.

Installing a Secondary Remote Control

When a secondary remote control is installed elsewhere in the kitchen, you can turn the water on and off from there.

The ID code of this remote control must be synchronized with the controller so that the system can recognize the new remote control.

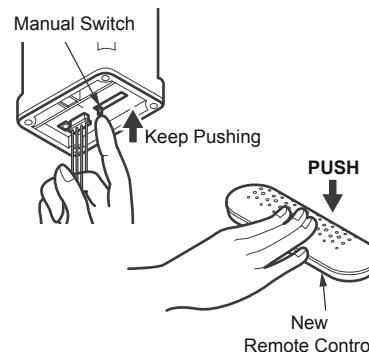

Keep pushing the manual switch of the controller, then push the new remote control.

By doing this, the ID code of the remote control is synchronized.

Maintenance

In order to take full advantage of the product and keep it functioning in good condition, a regular maintenance schedule should be followed.

Cleaning the Filter

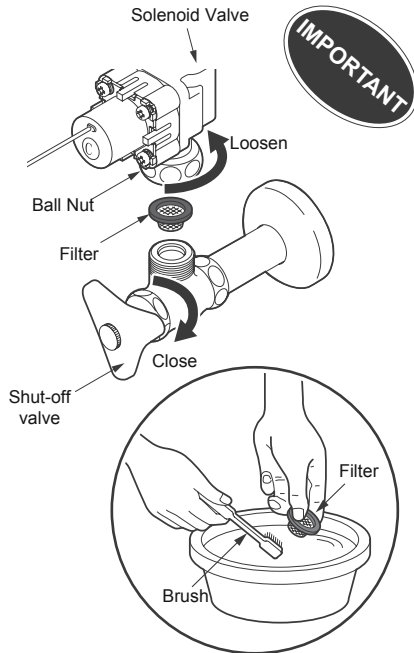

1. **Close the hot and cold shut-off valves.**
2. **Open the faucet and push the remote control in order to relieve pressure.**
3. **Loosen the ball nuts under each solenoid valve until they disengage from the shut-off valves.**
4. **Remove the filters and clean them with a soft brush.**
5. **Replace the filters and tighten the ball nuts.**
6. **Open the shut-off valves and check for leaks.**

Cleaning the Remote Control

- Use a soft, clean, damp cloth (not wet) to remove any dirt or stains on the remote. If necessary, use a diluted neutral household detergent in water. Wring out cloth. Cloth should be damp but not wet.
- Do not use any of the following agents as they will damage the remote:

Acidic detergent, chloride bleach, alkaline detergent solutions like thinner, benzene cleanser, abrasive powder, detergent with coarse particles, nylon scrubber, brush



Please inspect the following to ensure safe and continued use.

Check for leaks (twice a year)



Check for leaks

Look for stains on the floor under the pipes. A leaking pipe can cause serious damage to your property. If a leak is present, close the shut-off valve. If the leak continues, shut off your water main. Request plumbing service. Avoid using product until the leak is fixed.

Check the loose fittings (twice a year)

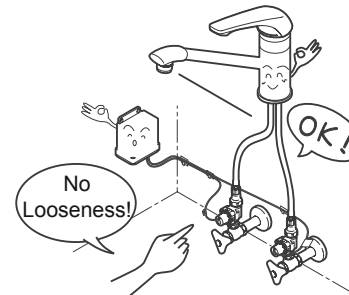

Check for loose fittings

With time, fittings can become loose. Make sure to check and tighten any loose fittings.

Replace the battery in the remote control

The remote control uses one CR2032 lithium battery. It is recommended that you replace the battery in the remote control unit at least once a year. If, however, the remote control is being used excessively, the battery may need to be changed more frequently.

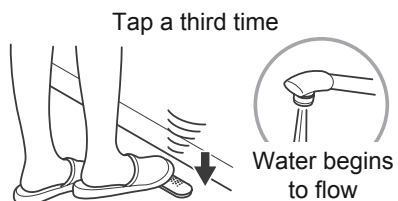
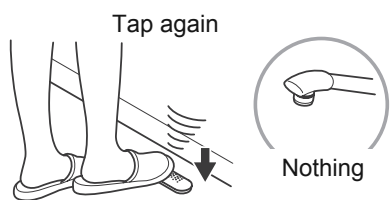
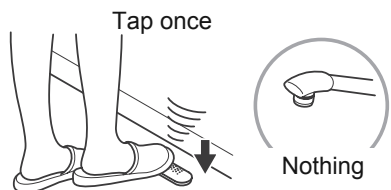

If the battery is dead, there is a chance that the valve will respond if the remote is tapped three times.

It is recommended that you replace the battery before it dies in order to continue using the product uninterrupted.

If the battery dies, the solenoid valve will remain as it is - closed or open, as the case may be. In either case, the water should be turned off manually with the faucet handle.

Information

The battery that normally ships with this product has been used to test the product. It may or may not last a full year. It is recommended that it be replaced with a fresh battery before it dies. Batteries are not covered under warranty.

How to replace the battery

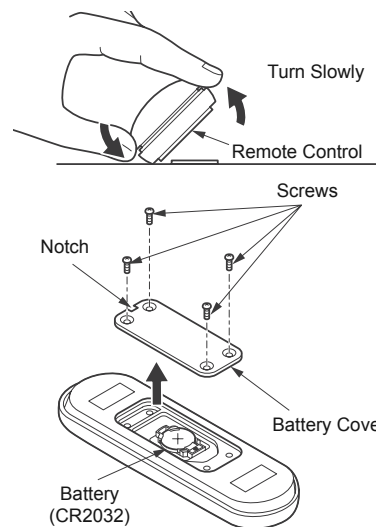

How to remove the battery

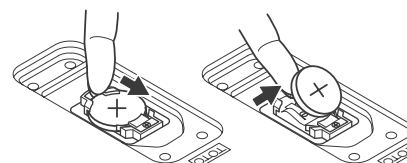

How to install the battery

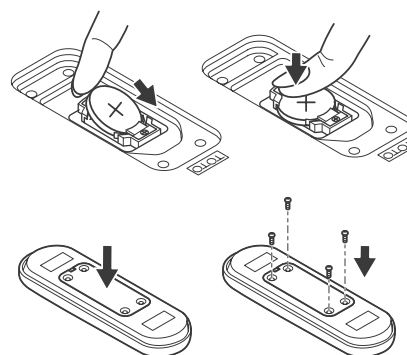

1. Hold the remote control firmly with two hands, then turn on one side to un-stick it.
2. Remove the four screws on the back of the remote control.
3. Remove the battery cover. Insert a flat screwdriver into the notch and lift the cover.
4. Take out the used battery and replace it with a new one (CR2032). It is easier to pick it out with your finger tip by holding it upwards.

- Be careful not to lose any parts when they are removed.
- Pay attention to the polarity of the battery and replace it correctly.
- You should use only model CR2032 battery.
- Follow local regulations for the disposal of the old battery.

5. Replace all four screws to ensure a water tight seal.
 6. Re-stick remote control back in place. (See pg. 16)
- Be careful that water does not enter the remote control.
 - All four screws should be installed. Otherwise, water may enter the remote control.

Clean the adhesive packing

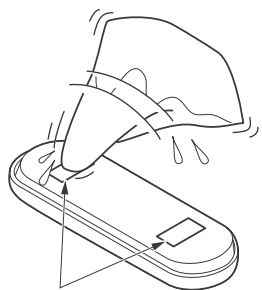

Adhesion Packing

If the adhesive packing on the back of the remote control is dirty, use a damp (**not wet**) cloth to clean it. Allow packing to dry out before resticking the remote control.

- Dust may reduce the adhesive force, so it should be cleared off.
- Do not clean the remote control directly with water.

Replace the batteries in the controller

The remote control uses 4 “AA” Alkaline Batteries. It is recommended that you replace the batteries in the controller at least once a year. If, however, the controller is being used excessively, the batteries may need to be changed more frequently.

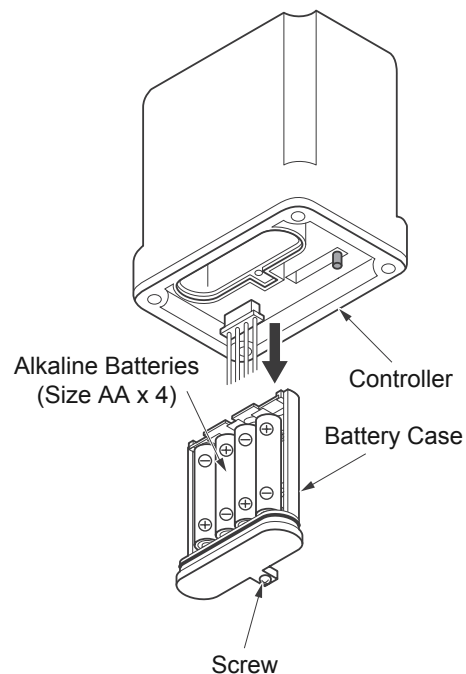

1. Remove the screw from the bottom of the controller.
2. Pull out the battery case.
3. Take out the used batteries and replace them with a new ones.

- Be careful not to lose any parts while replacing the batteries.
- Pay attention to the polarity of the batteries and insert them correctly.
- Do not mix old and new or different types of batteries.
- Follow local regulations for the disposal of the old batteries.

4. Replace the battery case and secure it with the screw.

Be careful that water does not enter the controller.

Information

It is recommended that batteries be replaced with fresh batteries before they die. Batteries are not covered under warranty.

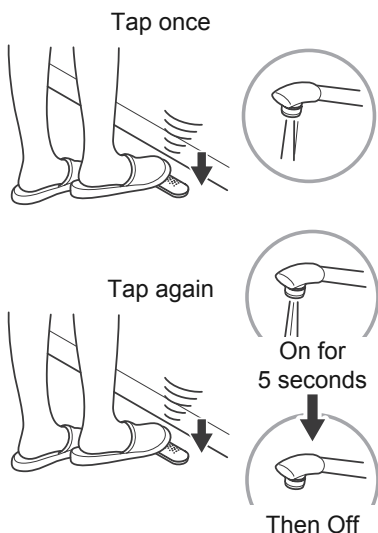

If the battery is dead there is a chance that the valve will respond if the remote is tapped two times. Water will flow for 5 seconds, then stop.

It is recommended that you replace the battery before it dies, in order to continue using the product uninterrupted.

If the battery dies, the solenoid valve will remain as it is - closed or open, as the case may be. In either case, the water should be turned off manually with the faucet handle.

Troubleshooting

How to stop the water in case of an emergency

If a leak occurs from the solenoid valve to the faucet, turn off the shut-off valves. If there is a leak elsewhere, shut-off the main valve.

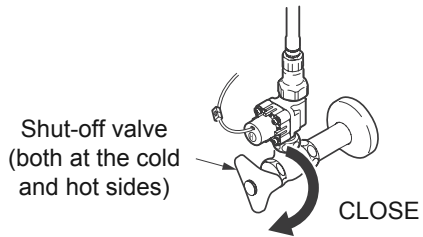

Close the shut-off valves at the cold and hot sides.

If this cannot stop the water flow, close the main valve.

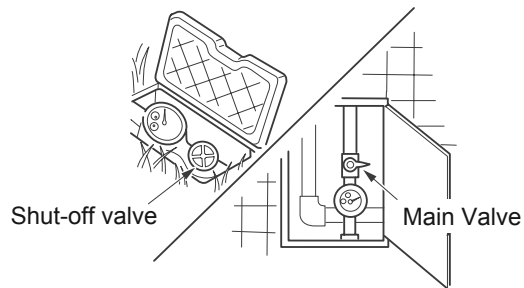

In case of no battery power

Push the manual switch under the controller.

This operation will open the cold-side solenoid valve, so that cold water will flow out. While there is no battery power you may continue to use the faucet by turning it off and on with its handle. After the batteries are replaced, the faucet will return to normal operation.

- The manual switch must be pushed within 90 minutes of the power failure. Otherwise you will have to wait until the batteries are replaced.
- When there is no battery power, the remote control cannot be used.
- In this period, only cold water can be used.

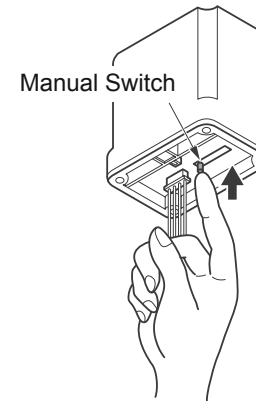

If the remote control battery is used up

Push the manual switch under the controller.

This operation will open the cold/hot-side solenoid valve and water will flow out. Push it again to stop the water flow. After the solenoid valves are open, you can use the faucet as a regular manually operated one.

If you use the manual switch, the automatic shut-off of water is also disabled.

For information on how to replace the remote control battery, please refer to pg. 15

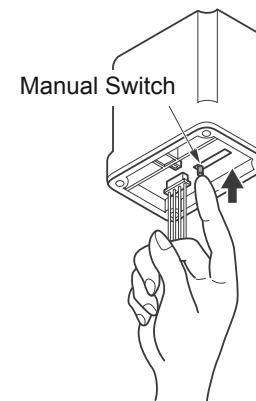

The following problems and their diagnosis can be performed by the owner of the faucet without voiding the warranty. If you are unsuccessful you can request service from the installer, distributor or TOTO Technical Support.

Before Requesting Service			
Problem	Inspection	Solution	Solution
No water flows	Is the faucet open?	Open the faucet.	Page 10
	Is the shut-off valve open enough?	Open the shut-off valve.	Page 7
	Is the filter blocked?	Clean the filter.	Page 12
	Have the batteries been inserted?	Insert the batteries.	Page 15, 17
	Has the battery been inserted in the remote control?	Insert the battery.	Page 14
	Has the connector been firmly connected?	Secure the connector.	Page 7
	Has the water main been shut off?	Wait until it is turned back on.	-
	Is the remote control or the controller installed on metal surface?	Install them on non-metal surface.	Page 8 - 9
	Is there an obstacle between the remote control and the controller?	Relocate the controller, the remote, or the obstacle.	Page 8 - 9
	Is there interference from a converter or other electrical equipment?	Keep appropriate distance from it.	Page 8 - 9
Water keeps flowing	Are the batteries of the remote control or the controller dead?	Replace the battery(s)	Page 14, 16
	Is the remote control or the controller installed on stainless steel surface?	Install them on non-metallic surface.	Page 8 - 9
	Is there an obstacle between the remote control and the controller, such as an iron or stainless dish washer?	Relocate the controller, the remote, or the obstacle.	Page 8 - 9
	Is there interference from a converter or other electrical equipment?	Keep appropriate distance from it.	Page 8 - 9
	If water still keeps flowing despite these inspections, turn off the shut-off valves.		

Before Requesting Service			
Problem	Inspection	Solution	Solution
Water flow is too small	Is the shut-off valve open enough?	Adjust flow rate.	Page 7
	Is the filter blocked?	Clean the filter.	Page 12
	If a hot water heater is used, is it set to an appropriate output?	Set it to an appropriate output.	-
Only hot water	Is the cold-side shut-off valve open enough?	Adjust flow rate.	Page 7
	Is the cold-side filter blocked?	Clean the filter.	Page 12
Only cold water	Is enough hot water supplied from the hot water heater?	Confirm the temperature setting and operation.	-
	Is the cold-side shut-off valve open enough?	Adjust flow rate.	Page 7
	Is the hot-side filter blocked?	Clean the filter.	Page 12
Temperature cannot be properly adjusted	Are the cold/hot-side shut-off valves open enough?	Adjust flow rate.	Page 7
	Is enough hot water supplied by the hot water heater?	Confirm the temperature setting and operation.	-
	Is the filter blocked?	Clean the filter.	Page 12

If you do not know the location of your shut-off valves or the main valve, contact your installer or a qualified plumber.



Note

Caution for using the product

The coating of the remote control may be peeled off due to abrasion depending on how you use it. This will not affect the performance of the product.

Specifications

Type	Battery Type	
Power Supply	DC 6V (Alkaline Size AA x 4) Battery Duration: 1 Year (Condition: 100 times/day)	
Power for Remote Control	DC 3V (Lithium Battery CR2032 x 1) Battery Duration: 1 Year (Condition: 100 times/day)	
Item Number	Controller: 551001 Remote Control: 9E3014	
Cord Length	Solenoid Valve: 1 3/4 ft. (570mm)	
Pressure of Water Supply	Min. (Flowing)	20 psi. (0.14MPa)
	Max. (Flowing)	108 psi. (0.75MPa)
Water Quality	Water that meets National/Primary drinking water regulation.	
Humidity Range	Less than 90% RH	
Distance	3 ft. (1m) between remote and controller	
Frequency (Remote)	294MHz under 500µV/m	
Max. Temperature of Hot Water	185°F (85°C) (But it should be under 140°F (60°C) for the sake of safety)	
Ambient Temperature	34° - 104°F (1 - 40°C) (It cannot be used in a freezing region)	
Adapting to the Main Water	1/2" NPSM (Solenoids) 3/8" CF x 1/2" WPSF adapters (2) 3/8" CM x 1/2" WPSF adapters (2)	
Usage	Residential Use	

TOTO U.S.A., INC. ONE YEAR LIMITED WARRANTY

- TOTO warrants its TEC1DS ("Product") to be free from defects in materials and workmanship during normal use when properly installed and serviced, for a period of ONE (1) year from date of purchase. This limited warranty is extended only to the ORIGINAL PURCHASER of the Product and is not transferable to any third party, including but not limited to any subsequent purchaser or owner of the Product. This warranty applies only to TOTO Product purchased and installed in United States, Canada and Mexico.
- TOTO's obligations under this warranty are limited to repair, replacement or other appropriate adjustment, at TOTO's option, of the Product or parts found to be defective in normal use, provided that such Product was properly installed, used and serviced in accordance with instructions. TOTO reserves the right to make such inspections as may be necessary in order to determine the cause of the defect. TOTO will not charge for labor or parts in connection with warranty repairs or replacements. TOTO is not responsible for the cost of removal, return and/or reinstallation of the Product.
- This warranty does not apply to the following items:
 - Damage or loss sustained in a natural calamity such as fire, earthquake, flood, thunder, electrical storm, etc.
 - Damage or loss resulting from any accident, unreasonable use, misuse, abuse, negligence, or improper care, cleaning, or maintenance of the Product.
 - Damage or loss resulting from sediments or foreign matter contained in a water system.
 - Damage or loss resulting from improper installation or from installation of the Product in a harsh and/or hazardous environment, or improper removal, repair or modification of the Product.
 - Damage or loss resulting from electrical surges or lightning strikes or other acts which are not the fault of TOTO or which the Product is not specified to tolerate.
 - Damage or loss resulting from normal and customary wear and tear, such as gloss reduction, scratching or fading over time due to use, cleaning practices or water or atmospheric conditions.
- In order for this limited warranty to be valid, TOTO must receive the completed attached warranty registration card and your proof of purchase within 30 days of the original purchase date.
- If the Product is used or installed outside of North America, TOTO warrants the Product to be free from defects in materials and workmanship during normal use for one (1) year from the date of installation of the Product, and all other terms of this warranty shall be applicable except the duration of the warranty
- THIS WARRANTY GIVES YOU SPECIFIC LEGAL RIGHTS. YOU MAY HAVE OTHER RIGHTS WHICH VARY FROM STATE TO STATE OR PROVINCE TO PROVINCE.
- To obtain warranty repair service under this warranty, you must take the Product or deliver it prepaid to a TOTO service facility together with proof of purchase (original sales receipt) and a letter stating the problem, or contact a TOTO distributor or products service contractor, or write directly to TOTO U.S.A., INC., 1155 Southern Road, Morrow, GA 30260 (888) 295-8134. If, because of the size of the Product or nature of the defect, the Product cannot be returned to TOTO, receipt by TOTO of written notice of the defect together with proof of purchase (original sales receipt) shall constitute delivery. In such case, TOTO may choose to repair the Product at the purchaser's location or pay to transport the Product to a service facility.

THIS WRITTEN WARRANTY IS THE ONLY WARRANTY MADE BY TOTO. REPAIR, REPLACEMENT OR OTHER APPROPRIATE ADJUSTMENT AS PROVIDED UNDER THIS WARRANTY SHALL BE THE EXCLUSIVE REMEDY AVAILABLE TO THE ORIGINAL PURCHASER. TOTO SHALL NOT BE RESPONSIBLE FOR LOSS OF THE PRODUCT OR FOR OTHER INCIDENTAL, SPECIAL OR CONSEQUENTIAL DAMAGES OR EXPENSES INCURRED BY THE ORIGINAL PURCHASER, OR FOR LABOR OR OTHER COSTS DUE TO INSTALLATION OR REMOVAL, OR COSTS OF REPAIRS BY OTHERS, OR FOR ANY OTHER EXPENSE NOT SPECIFICALLY STATED ABOVE. IN NO EVENT WILL TOTO'S RESPONSIBILITY EXCEED THE PURCHASE PRICE OF THE PRODUCT. EXCEPT TO THE EXTENT PROHIBITED BY APPLICABLE LAW, ANY IMPLIED WARRANTIES, INCLUDING THAT OF MERCHANTABILITY OR FITNESS FOR USE OR FOR A PARTICULAR PURPOSE, ARE EXPRESSLY DISCLAIMED. SOME STATES DO NOT ALLOW LIMITATIONS ON HOW LONG AN IMPLIED WARRANTY LASTS, OR THE EXCLUSION OR LIMITATION OF INCIDENTAL OR CONSEQUENTIAL DAMAGES, SO THE ABOVE LIMITATION AND EXCLUSION MAY NOT APPLY TO YOU.