

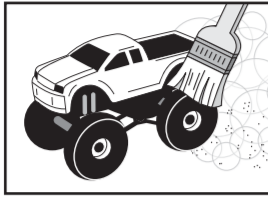

### CLEANING AND MAINTAINING

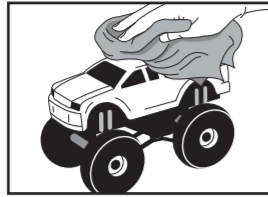

Brush areas where dirt and dust get trapped.



Wipe body off with a soft rag or tact cloth.



Do not clean vehicle with chemicals or water.

### FEDERAL COMMUNICATIONS COMMISSION COMPLIANCE

#### NOTE:

This device complies with Part 15 of the FCC Rules. Operation is subject to the following two conditions:  
1) This device may not cause harmful interference, and,  
2) This device must accept any interference received including interference that may cause undesired operation.

Warning: Changes or modifications to this unit not expressly approved by the party responsible for compliance could void the user's authority to operate the equipment. Note: This equipment has been tested and found to comply with the limits for a Class B digital device, pursuant to Part 15 of the FCC Rules. These limits are designed to provide reasonable protection against harmful interference in a residential installation. This equipment generates, uses and can radiate radio frequency energy and if not installed and used in accordance with the instructions, may cause harmful interference to radio communications. However, there is no guarantee that interference will not occur in a particular installation. If this equipment does cause harmful interference to radio or television reception, which can be determined by turning the equipment off and on, the user is encouraged to try and correct the interference by one or more of the following measures:

- Reorient or relocate the receiving antenna
- Increase the separation between the equipment and receiver
- Connect the equipment to an outlet on a circuit different from that to which the receiver is connected
- Consult the dealer or an experienced radio/TV technician for help.

### MANUFACTURER'S NOTE

"Modifications not authorized by the manufacturer may void users authority to operate the device."

### ATTENTION PARENTS

This toy and all accessories need to be periodically examined for potential hazards and any potentially hazardous parts be repaired or replaced.

www.roadrippers.com  
For questions, e-mail our Consumer Service Dept. at  
consumerservice@toystate.com  
Or Call 1-877-473-8015



WARNING: Not suitable for children under 36 months due to small parts. Choking hazard.



**MADE IN SHENZHEN, CHINA**  
**TOY STATE INTERNATIONAL LIMITED**  
1 PEKING ROAD, KOWLOON, HONG KONG

IN THE INTEREST OF BETTER QUALITY AND VALUE, WE ARE CONSTANTLY IMPROVING AND UPDATING OUR PRODUCTS. CONSEQUENTLY, PICTURES IN THIS INSTRUCTION SHEET MAY SOMETIMES DIFFER FROM THE MODEL ENCLOSED.



Ford Motor Company Trademarks and Trade Dress used under license to Toy State Industrial Ltd. www.fordmotorcompany.com

"Toyota, Tundra and all other associated marks, emblems and designs are intellectual property rights of Toyota Motor Corporation and used with permission."



www.toystate.com



# RADIO CONTROL TRAIL MAKER™ 4X4 R/C

## OWNER'S MANUAL

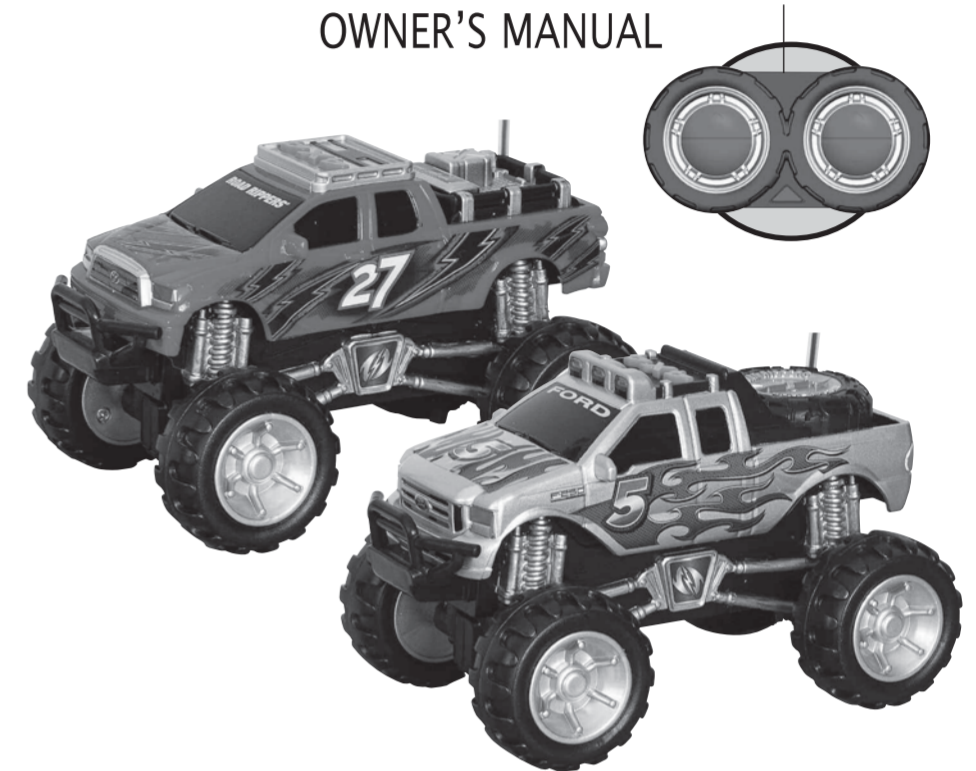

CONTROLLER  
AAA/R3 x3  
Batteries Not Included

VEHICLE  
AA/LR6 x3  
Included



### GETTING STARTED

Remove the R/C vehicle and controller from the package. Insert batteries into the R/C vehicle and controller to begin full function play (see "Battery Installation" section for further details).

### CAUTION

#### Important Battery Information

- Dispose of batteries properly.
- Do not dispose of batteries in fire.
- Use only batteries of the type recommended.
- Do not mix alkaline, standard (carbon-zinc) or rechargeable (nickel-cadmium) batteries.
- Do not mix old and new batteries.
- Remove batteries from R/C vehicle and controller if vehicle will not be used for a long period of time.

The antenna is not to be inserted into socket-outlets.

### BATTERY INSTALLATION

#### CONTROLLER

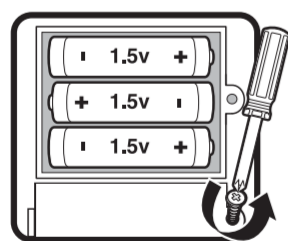

1. To remove battery cover, loosen screw to open.
2. Insert 3 "AAA" batteries into the controller. Be sure the + and - are properly matched.

#### R/C VEHICLE

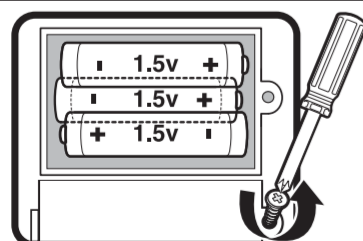

1. To remove battery cover, loosen screw to open.
2. Insert 3 "AA" batteries into the vehicle. Be sure the + and - are properly matched.

NOTE: For best performance, always use alkaline batteries only.

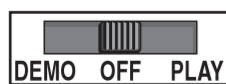

STRONG BATTERY MEANS OPTIMUM PERFORMANCE  
Save the battery by turning off vehicle when not in use.

### OPERATING R/C VEHICLE

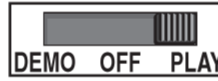

Toggle DEMO/OFF/PLAY switch located on bottom of R/C vehicle to the PLAY position

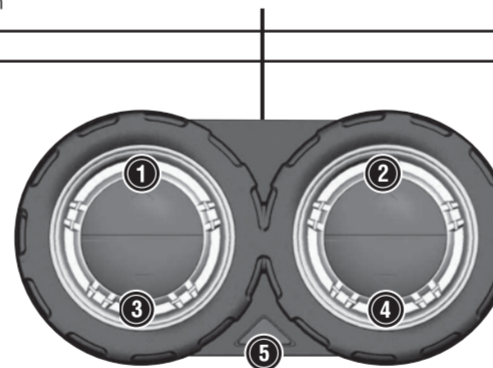

- Hold button 1 and 2 on the controller to drive forward
- Hold 3 and 4 to drive in reverse
- Hold 1 to turn right while going forward
- Hold 2 to turn left while going forward
- Hold 3 to turn right going in reverse
- Hold 4 to turn left going in reverse
- Press button 5 for lights and sounds



- Press button 6 on the vehicle to drive forward with lights and sounds
- Press button 7 on the vehicle for lights and sounds
- Press button 8 on the vehicle for lights and sounds

After play, always turn vehicle off. Remove batteries from controller and R/C vehicle when not in use or when storing. Leakage may occur and cause damage if left for a long period of time.

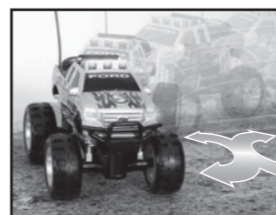

Full-Function Radio Control



Realistic 4-Wheel Drive

### TROUBLESHOOTING AND CARE FOR R/C VEHICLE

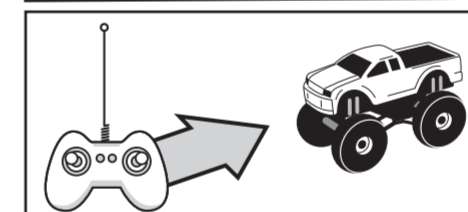

**LIMITED RADIO CONTROL RANGE**  
While R/C vehicle may be visible at a distance, full operational control may be lost. Hold controller high in the air and direct vehicle back.

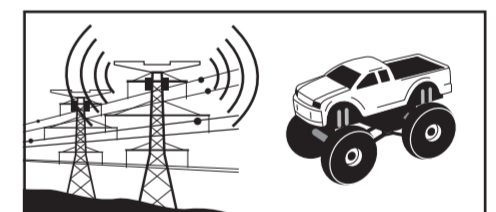

**INTERFERENCE**  
Other radio signals may cause loss of control. Remove vehicle from an area of interference.

R/C VEHICLE DOES NOT MOVE	<ul style="list-style-type: none"> <li>• Are the + and - contacts correctly matched in the controller?</li> <li>• Are the metal contact tabs touching, rusty or dirty in controller?</li> <li>• Are there batteries in the vehicle and controller?</li> <li>• Is the power switch turned on?</li> <li>• Are the batteries weak or out of power?</li> </ul>
R/C VEHICLE MOVES BY ITSELF	<ul style="list-style-type: none"> <li>• There is radio interference in the area.</li> <li>• Another R/C vehicle with the same frequency is close by.</li> </ul>
R/C VEHICLE RUNS SLOWLY	<ul style="list-style-type: none"> <li>• There is radio interference in the area.</li> <li>• Another R/C vehicle with the same frequency is close by.</li> <li>• Are the batteries weak or out of power?</li> </ul>
PERFORMANCE DROP, INCONSISTENT MOVEMENT OR FAILS TO RUN	Check batteries. If necessary, replace the batteries in the R/C vehicle and controller with new alkaline batteries.

### TREAT YOUR R/C VEHICLE WELL

Radio waves control the R/C vehicle. Care for your vehicle and it will provide hours of fun!  
Avoid water, heat, sand and high impact crashes!

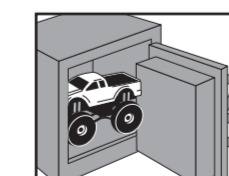

Store in safe place.

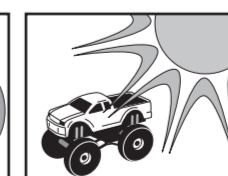

No direct sunlight.

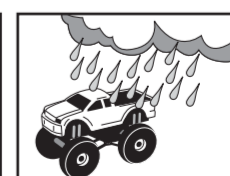

No rain or water.

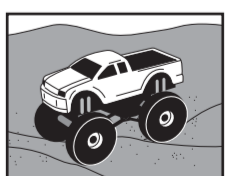

No sand or dust.

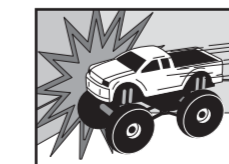

No Collisions.



R/C vehicle may get stuck on carpet or grass.

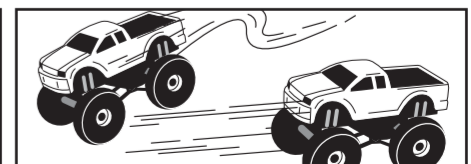

Avoid running 2 vehicles with the same radio control frequencies.