

# TABLE OF CONTENTS

1	<b>Before driving</b>	Adjusting and operating features such as door locks, mirrors, and steering column.
2	<b>When driving</b>	Driving, stopping and safe-driving information.
3	<b>Interior features</b>	Air conditioning and audio systems, as well as other interior features for a comfortable driving experience.
4	<b>Maintenance and care</b>	Cleaning and protecting your vehicle, performing do-it-yourself maintenance, and maintenance information.
5	<b>When trouble arises</b>	What to do if the vehicle needs to be towed, gets a flat tire, or is involved in an accident.
6	<b>Vehicle specifications</b>	Detailed vehicle information.
7	<b>For owners</b>	Reporting safety defects for U.S. owners, and seat belt and SRS airbag instructions for Canadian owners
	<b>Index</b>	Alphabetical listing of information contained in this manual.

**1 Before driving**

**1-1. Key information**  
 Keys ..... 28

**1-2. Opening, closing and locking the doors and trunk**  
 Smart key system..... 32  
 Wireless remote control ..... 46  
 Doors..... 52  
 Trunk ..... 58

**1-3. Adjustable components (seats, mirrors, steering wheel)**  
 Front seats ..... 62  
 Rear seats..... 65  
 Head restraints ..... 67  
 Seat belts ..... 69  
 Steering wheel ..... 76  
 Anti-glare inside rear view mirror..... 77  
 Outside rear view mirrors ..... 79

**1-4. Opening and closing the windows and moon roof**  
 Power windows ..... 81  
 Moon roof ..... 84

**1-5. Refueling**  
 Opening the fuel tank cap .... 88

**1-6. Theft deterrent system**

Engine immobilizer system... 92  
 Alarm ..... 95

**1-7. Safety information**

Correct driving posture ..... 98  
 SRS airbags ..... 100  
 Front passenger occupant classification system..... 113  
 Child restraint systems ..... 118  
 Installing child restraints ..... 122

**2 When driving**

**2-1. Driving procedures**

Driving the vehicle ..... 134  
 Engine (ignition) switch (vehicles without a smart key system) ..... 145  
 Engine (ignition) switch (vehicles with a smart key system) ..... 148  
 Automatic transmission (vehicles without paddle shift switches) ..... 155  
 Automatic transmission (vehicles with paddle shift switches) ..... 159  
 Turn signal lever ..... 166  
 Parking brake ..... 167  
 Horn..... 168

**2-2. Instrument cluster**

Gauges and meters ..... 169  
Indicators and warning lights ..... 179

**2-3. Operating the lights and wipers**

Headlight switch ..... 185  
Fog light switch ..... 192  
Windshield wipers and washer ..... 194

**2-4. Using other driving systems**

Cruise control ..... 199  
Driving assist systems ..... 203  
BSM (Blind Spot Monitor) ... 208

**2-5. Driving information**

Cargo and luggage ..... 213  
Vehicle load limits ..... 217  
Winter driving tips ..... 218  
Trailer towing ..... 222  
Dinghy towing ..... 223

**3 Interior features**

**3-1. Using the air conditioning system and defogger**

Manual air conditioning system ..... 226  
Automatic air conditioning system ..... 233  
Rear window and outside rear view mirror defoggers ..... 240

**3-2. Using the audio system**

Audio system types ..... 242  
Using the radio ..... 248  
Using the CD player ..... 251  
Playing back MP3 and WMA discs ..... 257  
Operating an iPod ..... 264  
Operating a USB memory ..... 272  
Optimal use of the audio system ..... 280  
Using the AUX port ..... 283

**3-3. Using the interior lights**

Interior lights list ..... 285  
• Interior lights ..... 286  
• Personal lights ..... 287

1

2

3

4

5

6

7

**3-4. Using the storage features**

List of storage features..... 289

- Glove box..... 290
- Console box..... 291
- Coin holder..... 292
- Bottle holders..... 293
- Cup holders..... 294
- Auxiliary boxes..... 296

**3-5. Other interior features**

Sun visors..... 298

Vanity mirrors..... 299

Clock..... 300

Outside temperature display..... 301

Ashtray..... 303

Power outlets..... 304

Seat heaters..... 307

Armrest..... 309

Coat hooks..... 310

Floor mat..... 311

Trunk features..... 313

Garage door opener..... 315

Compass..... 322

Safety Connect..... 326

**4 Maintenance and care**

**4-1. Maintenance and care**

Cleaning and protecting the vehicle exterior..... 334

Cleaning and protecting the vehicle interior..... 337

**4-2. Maintenance**

Maintenance requirements..... 340

General maintenance..... 342

Emission inspection and maintenance (I/M) programs..... 346

**4-3. Do-it-yourself maintenance**

Do-it-yourself service precautions..... 347

Hood..... 350

Positioning a floor jack..... 351

Engine compartment..... 353

Tires..... 367

Tire inflation pressure..... 375

Wheels..... 379

Air conditioning filter..... 382

Wireless remote control/ electronic key battery..... 384

Checking and replacing fuses..... 389

Light bulbs..... 401

## 5 When trouble arises

### 5-1. Essential information

Emergency flashers .....	414
If your vehicle needs to be towed .....	415
If you think something is wrong .....	418
Fuel pump shut off system .....	419

### 5-2. Steps to take in an emergency

If a warning light turns on or a warning buzzer sounds... ..	420
If you have a flat tire.....	435
If the engine will not start ....	447
If the shift lever cannot be shifted from P.....	449
If you lose your keys .....	450
If the electronic key does not operate properly.....	451
If the battery is discharged .....	454
If your vehicle overheats .....	459
If the vehicle becomes stuck .....	462
If your vehicle has to be stopped in an emergency .....	463

## 6 Vehicle specifications

### 6-1. Specifications

Maintenance data (fuel, oil level, etc.) .....	466
Fuel information.....	478
Tire information .....	481

### 6-2. Customization

Customizable features.....	493
----------------------------	-----

### 6-3. Initialization

Items to initialize .....	499
---------------------------	-----

## 7 For owners

Reporting safety defects for U.S. owners .....	502
Seat belt instructions for Canadian owners (in French).....	503
SRS airbag instructions for Canadian owners (in French).....	505

## Index

Abbreviation list.....	516
Alphabetical index .....	518
What to do if... ..	528

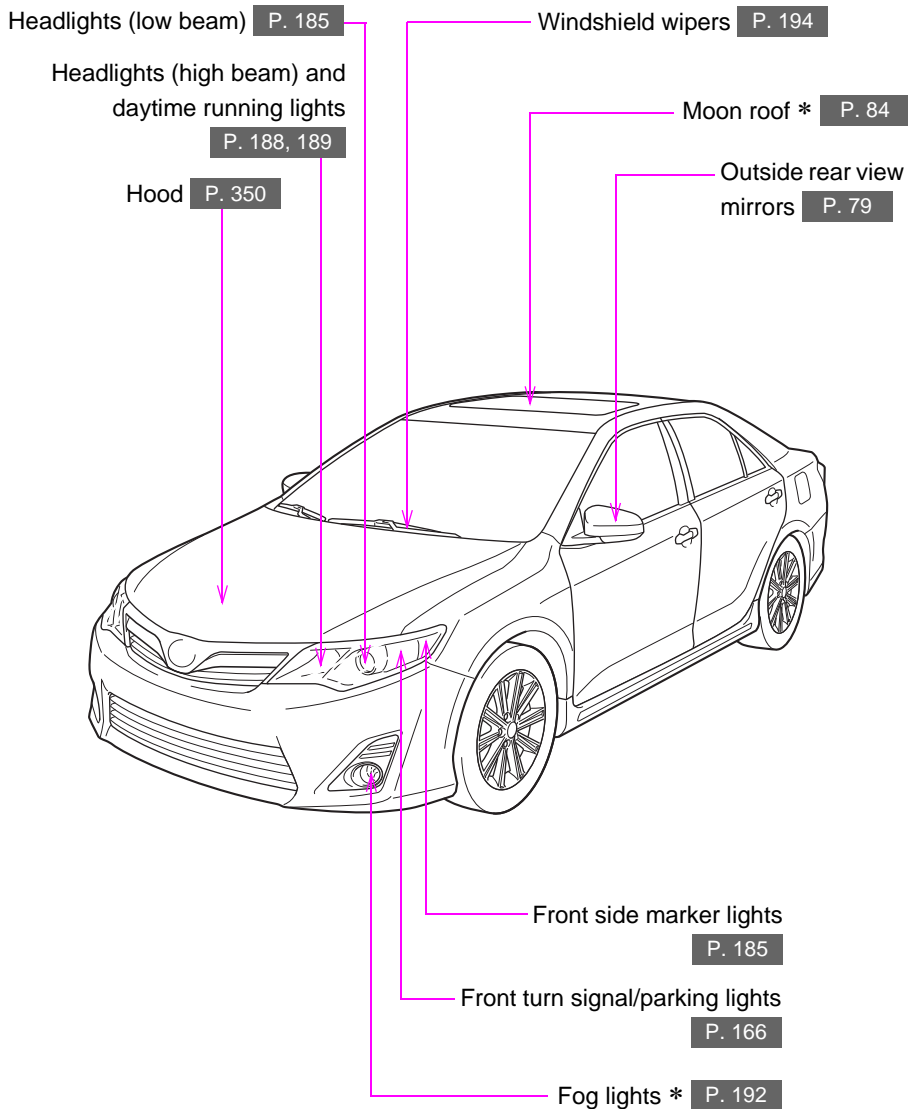

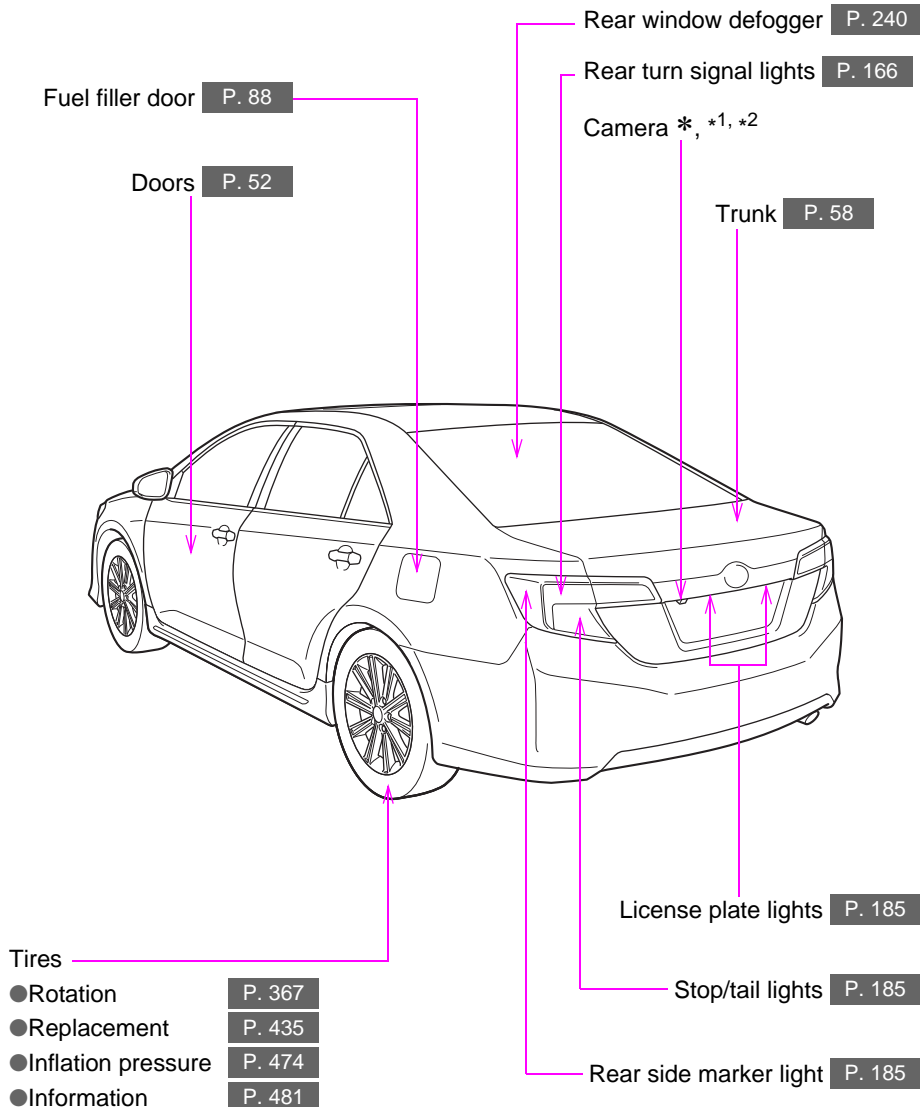

\*: If equipped  
 \*1: For vehicles with a navigation system, refer to "Navigation System Owner's Manual".  
 \*2: For vehicles with a Display Audio system, refer to "Display Audio System Owner's Manual".

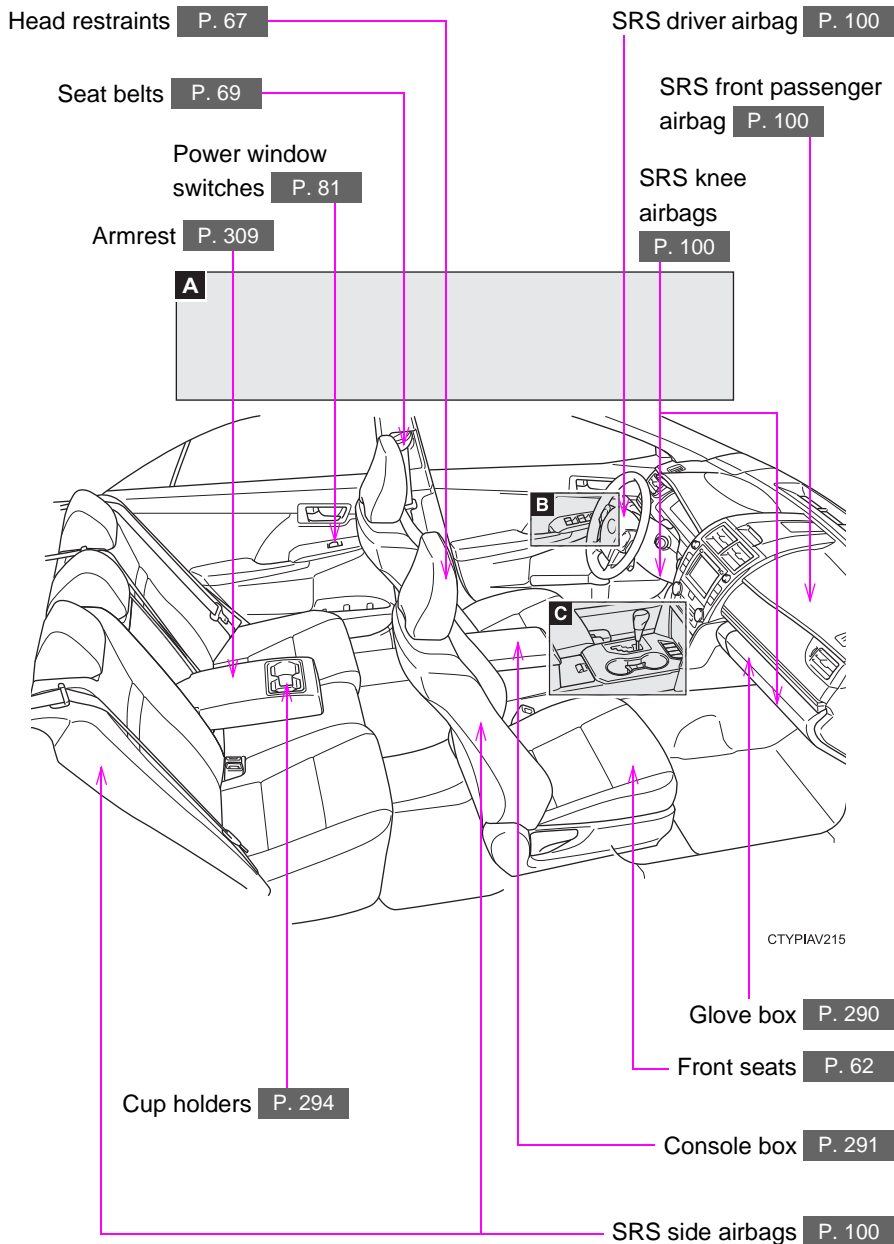

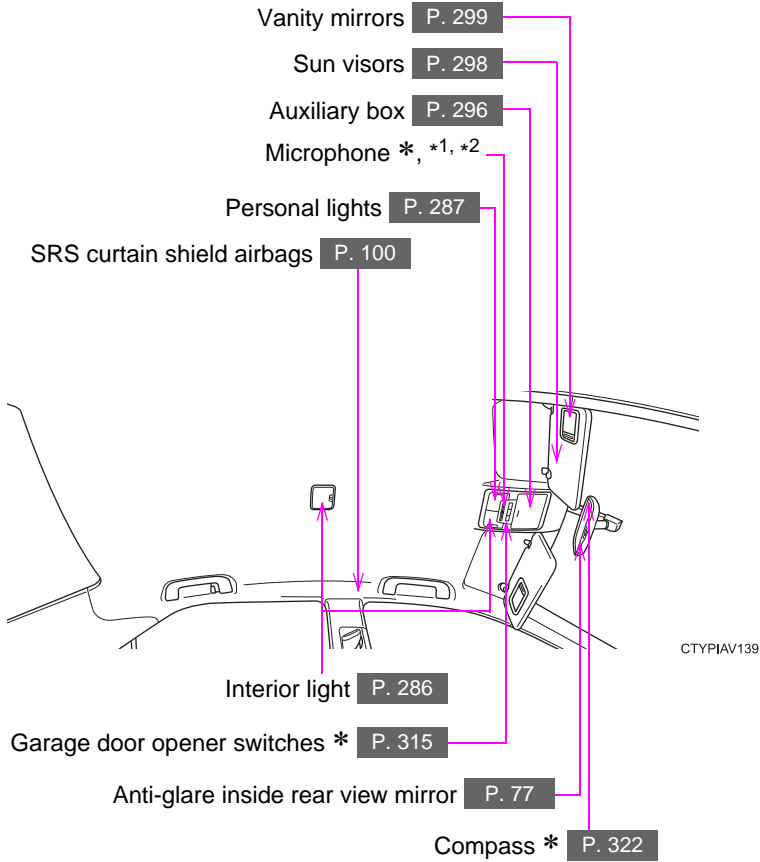

**A****Vehicles without moon roof**

\*: If equipped

\*1: For vehicles with a navigation system, refer to "Navigation System Owner's Manual".

\*2: For vehicles with a Display Audio system, refer to "Display Audio System Owner's Manual".

**A**

**Vehicles with moon roof**

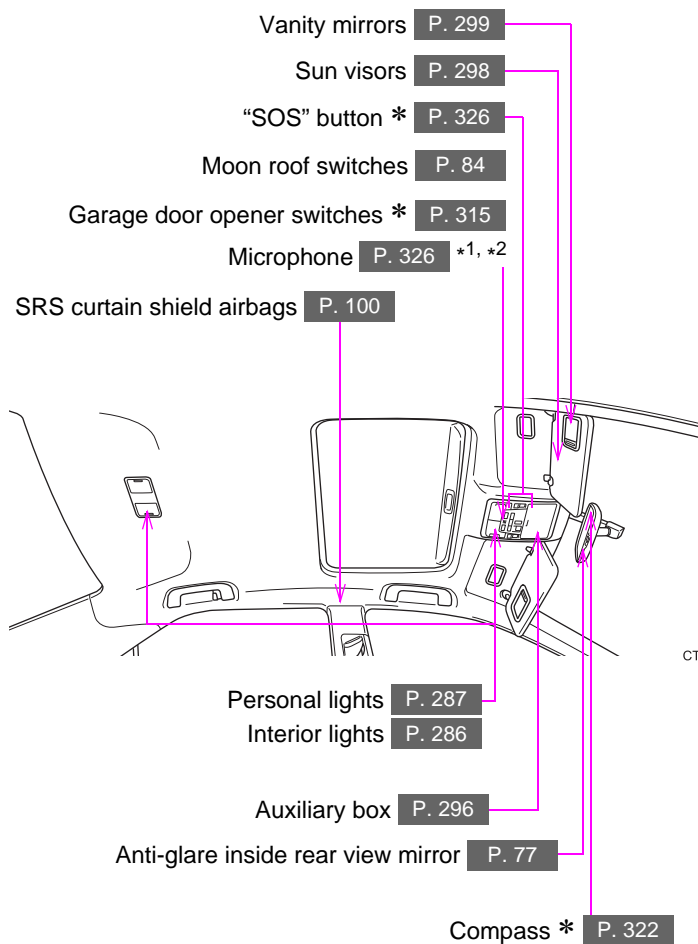

CTYPIAV120

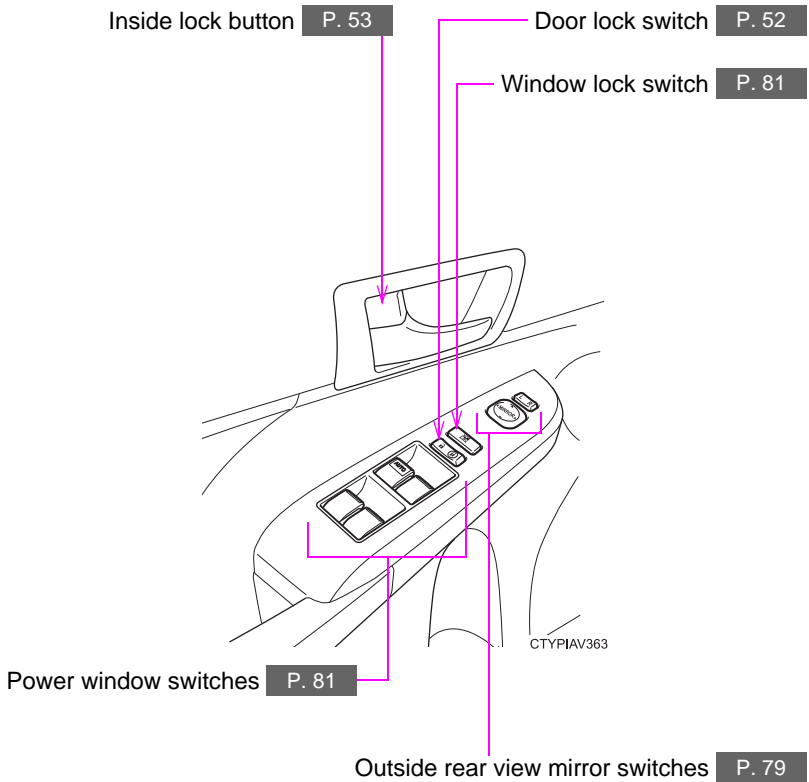
**B**

\*: If equipped

\*1: For vehicles with a navigation system, refer to "Navigation System Owner's Manual".

\*2: For vehicles with a Display Audio system, refer to "Display Audio System Owner's Manual".

**C**

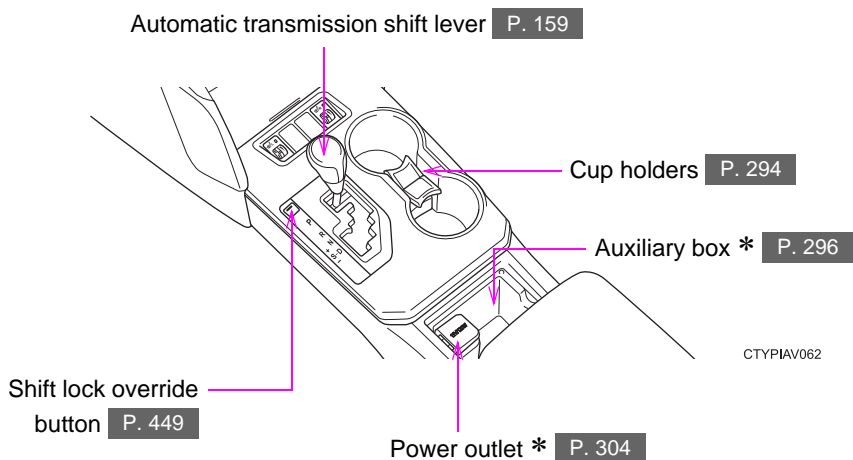

Gauges and meters P. 169

Windshield wiper and washer switch P. 194

Headlight switch P. 185  
Turn signal lever P. 166  
Fog light switch \* P. 192

Engine (ignition) switch (vehicles with a smart key system) P. 148

Clock P. 300

Audio system \* P. 242  
Navigation system \*, \*3  
Display Audio system \*, \*4

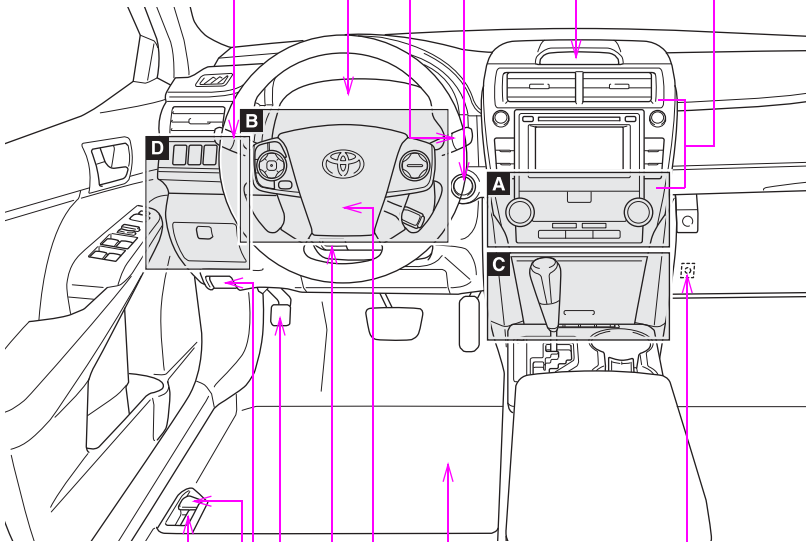

CTYPIAV174

Fuel filler door opener P. 88

Trunk opener P. 58

Hood lock release lever P. 350

Horn P. 168

Floor mat P. 311

Tilt and telescopic steering rock release lever P. 76

Parking brake pedal P. 167

Tire pressure warning reset switch \* P. 368

\*: If equipped

\*3: Refer to "Navigation System Owner's Manual".

\*4: Refer to "Display Audio System Owner's Manual".

**A**

**Manual air conditioning system**

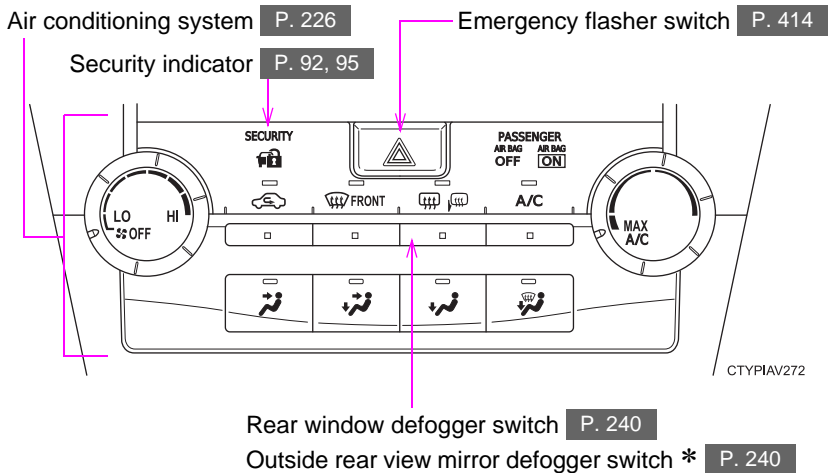

CTYPIAV272

**Automatic air conditioning system**

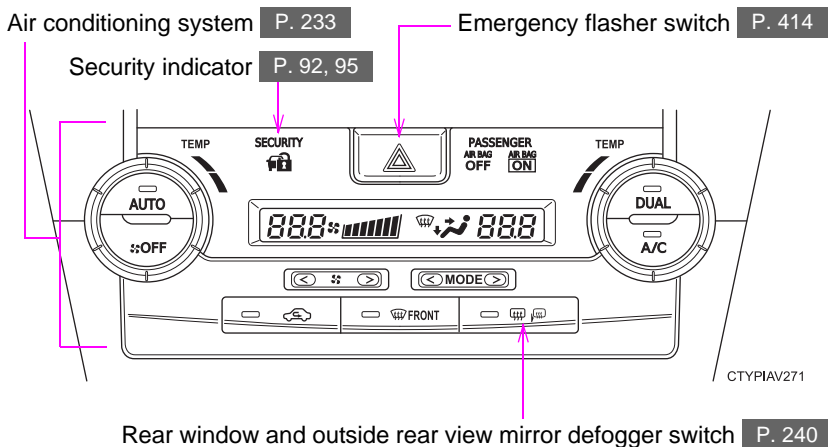

CTYPIAV271

**B****Type A**

Audio remote control switches \*, \*1, \*2

Telephone switches \*, \*1, \*2

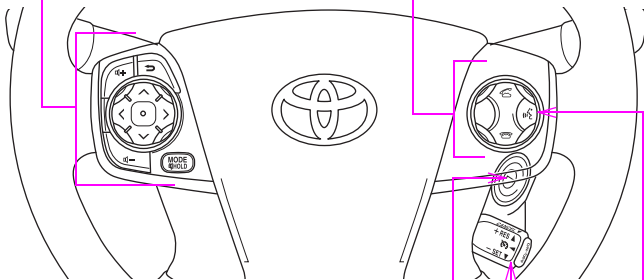

CTYPIAV236

Engine (ignition) switch  
(vehicles without a smart  
key system) P. 145

Cruise control switch P. 199

Talk switch \*, \*1, \*2

\*: If equipped

\*1: For vehicles with a navigation system, refer to "Navigation System Owner's Manual".

\*2: For vehicles with a Display Audio system, refer to "Display Audio System Owner's Manual".

**B**

**Type B**

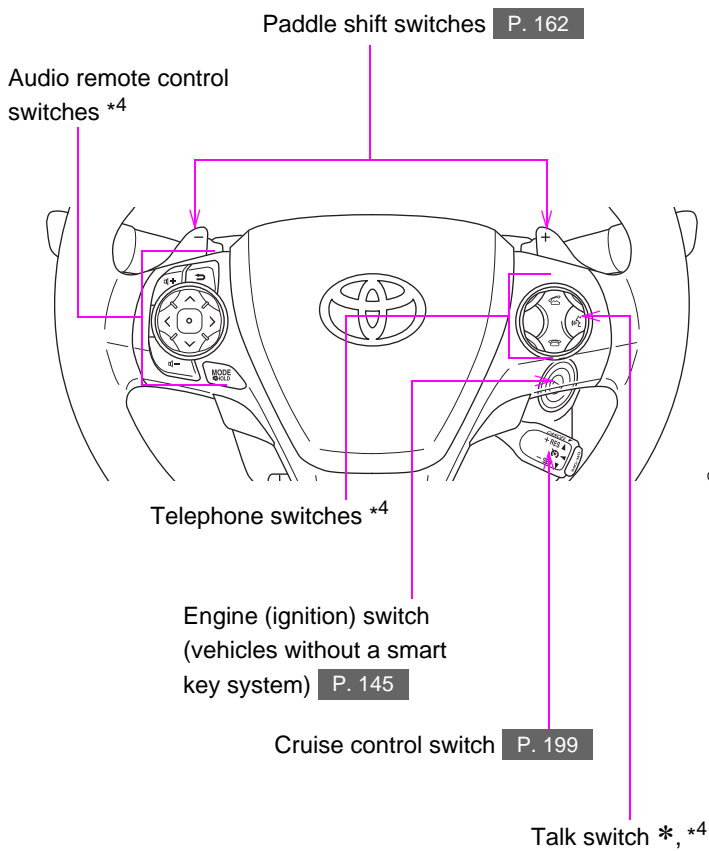



**C**

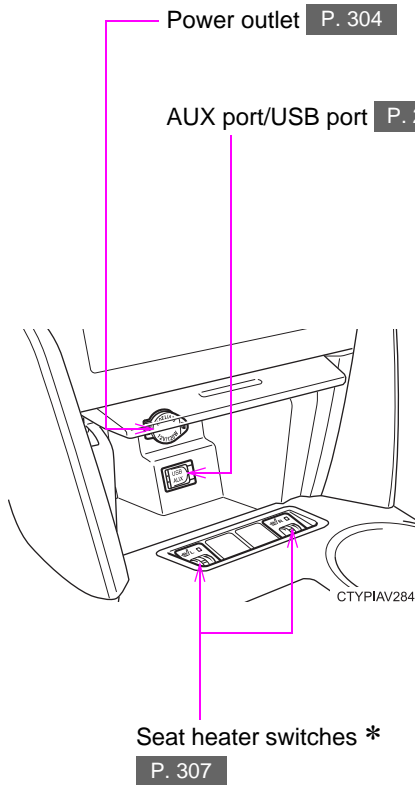

\*: If equipped

\*4: Refer to "Display Audio System Owner's Manual".

**D**

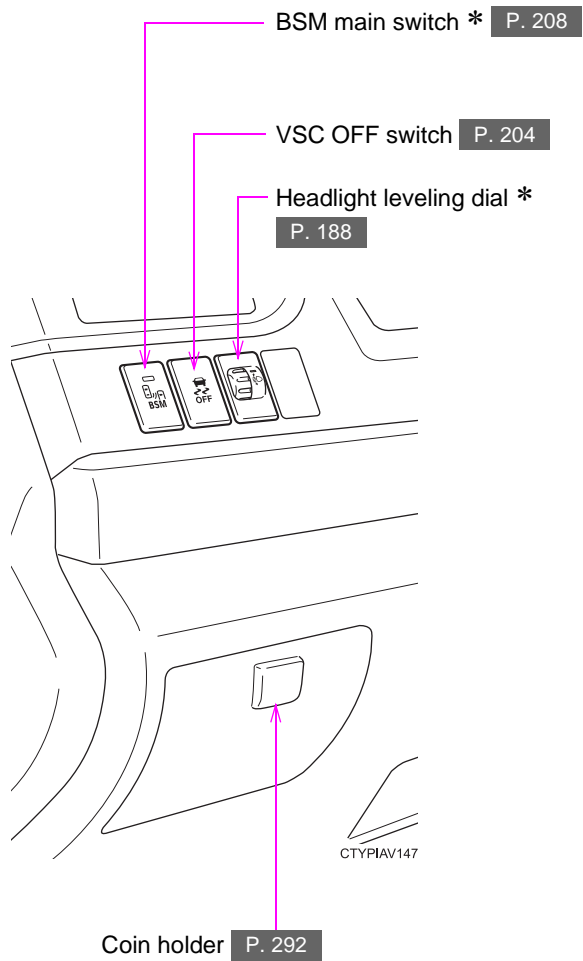

\*: If equipped

## For your information

### **Main Owner's Manual**

Please note that this manual covers all models and all equipment, including options. Therefore, you may find some explanations for equipment not installed on your vehicle.

All specifications provided in this manual are current at the time of printing. However, because of the Toyota policy of continual product improvement, we reserve the right to make changes at any time without notice.

Depending on specifications, the vehicle shown in the illustrations may differ from your vehicle in terms of equipment.

### **Noise from under vehicle after turning off the engine**

Approximately five hours after the engine is turned off, you may hear sound coming from under the vehicle for several minutes. This is the sound of a fuel evaporation leakage check and, it does not indicate a malfunction.

### **Accessories, spare parts and modification of your Toyota**

A wide variety of non-genuine spare parts and accessories for Toyota vehicles are currently available on the market. You should know that Toyota does not warrant these products and is not responsible for their performance, repair, or replacement, or for any damage they may cause to, or adverse effect they may have on, your Toyota vehicle.

This vehicle should not be modified with non-genuine Toyota products. Modification with non-genuine Toyota products could affect its performance, safety or durability, and may even violate governmental regulations. In addition, damage or performance problems resulting from the modification may not be covered under warranty.

## **Installation of a mobile two-way radio system**

The installation of a mobile two-way radio system in your vehicle could affect electronic systems such as:

- Multiport fuel injection system /sequential multiport fuel injection system
- Cruise control system
- Anti-lock brake system
- SRS airbag system
- Seat belt pretensioner system

Be sure to check with your Toyota dealer for precautionary measures or special instructions regarding installation of a mobile two-way radio system.

## Vehicle data recordings

Your Toyota is equipped with several sophisticated computers that will record certain data, such as:

- Engine speed
- Accelerator status
- Brake status
- Vehicle speed
- Shift position

The recorded data varies according to the vehicle grade level and options with which it is equipped. Furthermore, these computers do not record conversations, sounds or pictures.

### ● Data usage

Toyota may use the data recorded in these computers to diagnose malfunctions, conduct research and development, and improve quality.

Toyota will not disclose the recorded data to a third party except:

- With the consent of the vehicle owner or with the consent of the lessee if the vehicle is leased
  - In response to an official request by the police, a court of law or a government agency
  - For use by Toyota in a lawsuit
  - For research purposes where the data is not tied to a specific vehicle or vehicle owner
- Usage of data collected through Safety Connect (U.S. mainland only)

If your Toyota has Safety Connect and if you have subscribed to those services, please refer to the Safety Connect Telematics Subscription Service Agreement for information on data collected and its usage.

## Event data recorder

This vehicle is equipped with an event data recorder (EDR). The main purpose of an EDR is to record, in certain crash or near crash-like situations, such as an air bag deployment or hitting a road obstacle, data that will assist in understanding how a vehicle's systems performed. The EDR is designed to record data related to vehicle dynamics and safety systems for a short period of time, typically 30 seconds or less.

The EDR in this vehicle is designed to record such data as:

- How various systems in your vehicle were operating;
- Whether or not the driver and passenger safety belts were buckled/fastened;
- How far (if at all) the driver was depressing the accelerator and/or brake pedal; and,
- How fast the vehicle was traveling.

These data can help provide a better understanding of the circumstances in which crashes and injuries occur.

NOTE: EDR data are recorded by your vehicle only if a non-trivial crash situation occurs; no data are recorded by the EDR under normal driving conditions and no personal data (e.g., name, gender, age, and crash location) are recorded. However, other parties, such as law enforcement, could combine the EDR data with the type of personally identifying data routinely acquired during a crash investigation.

To read data recorded by an EDR, special equipment is required, and access to the vehicle or the EDR is needed. In addition to the vehicle manufacturer, other parties, such as law enforcement, that have the special equipment, can read the information if they have access to the vehicle or the EDR.

● Disclosure of the EDR data

Toyota will not disclose the data recorded in an EDR to a third party except when:

- An agreement from the vehicle's owner (or the lessee for a leased vehicle) is obtained
- In response to an official request by the police, a court of law or a government agency
- For use by Toyota in a lawsuit

However, if necessary, Toyota may:

- Use the data for research on vehicle safety performance
- Disclose the data to a third party for research purposes without disclosing information about the specific vehicle or vehicle owner

### **Scrapping of your Toyota**

The SRS airbag and seat belt pretensioner devices in your Toyota contain explosive chemicals. If the vehicle is scrapped with the airbags and seat belt pretensioners left as they are, this may cause an accident such as fire. Be sure to have the systems of the SRS airbag and seat belt pretensioner removed and disposed of by a qualified service shop or by your Toyota dealer before you scrap your vehicle.

### **Perchlorate Material**

Special handling may apply, See [www.dtsc.ca.gov/hazardouswaste/perchlorate](http://www.dtsc.ca.gov/hazardouswaste/perchlorate).

Your vehicle has components that may contain perchlorate. These components may include airbag, seat belt pretensioners, and wireless remote control batteries.



## CAUTION

### ■ **General precautions while driving**

**Driving under the influence:** Never drive your vehicle when under the influence of alcohol or drugs that have impaired your ability to operate your vehicle. Alcohol and certain drugs delay reaction time, impair judgment and reduce coordination, which could lead to an accident that could result in death or serious injury.

**Defensive driving:** Always drive defensively. Anticipate mistakes that other drivers or pedestrians might make and be ready to avoid accidents.

**Driver distraction:** Always give your full attention to driving. Anything that distracts the driver, such as adjusting controls, talking on a cellular phone or reading can result in a collision with resulting death or serious injury to you, your occupants or others.

### ■ **General precaution regarding children's safety**

Never leave children unattended in the vehicle, and never allow children to have or use the key.

Children may be able to start the vehicle or shift the vehicle into neutral. There is also a danger that children may injure themselves by playing with the windows, the moon roof, or other features of the vehicle. In addition, heat build-up or extremely cold temperatures inside the vehicle can be fatal to children.



## Symbols used throughout this manual

### Cautions & Notices

#### CAUTION

This is a warning against something which, if ignored, may cause death or serious injury to people. You are informed about what you must or must not do in order to reduce the risk of death or serious injury to yourself and others.

#### NOTICE

This is a warning against something which, if ignored, may cause damage to the vehicle or its equipment. You are informed about what you must or must not do in order to avoid or reduce the risk of damage to your Toyota and its equipment.

### Symbols used in illustrations



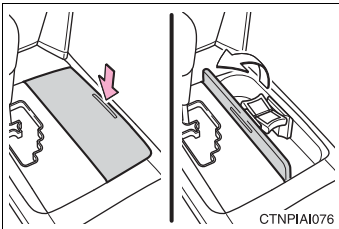

#### Safety symbol

The symbol of a circle with a slash through it means “Do not”, “Do not do this”, or “Do not let this happen”.



#### Arrows indicating operations

-  Indicates the action (pushing, turning, etc.) used to operate switches and other devices.
-  Indicates the outcome of an operation (e.g. a lid opens).



<b>1-1. Key information</b>		<b>1-6. Theft deterrent system</b>	
Keys .....	28	Engine immobilizer system .....	92
<b>1-2. Opening, closing and locking the doors and trunk</b>		Alarm.....	95
Smart key system .....	32	<b>1-7. Safety information</b>	
Wireless remote control .....	46	Correct driving posture.....	98
Doors .....	52	SRS airbags.....	100
Trunk.....	58	Front passenger occupant classification system .....	113
<b>1-3. Adjustable components (seats, mirrors, steering wheel)</b>		Child restraint systems.....	118
Front seats .....	62	Installing child restraints .....	122
Rear seats.....	65		
Head restraints.....	67		
Seat belts .....	69		
Steering wheel .....	76		
Anti-glare inside rear view mirror .....	77		
Outside rear view mirrors.....	79		
<b>1-4. Opening and closing the windows and moon roof</b>			
Power windows .....	81		
Moon roof.....	84		
<b>1-5. Refueling</b>			
Opening the fuel tank cap .....	88		

# Keys

The following keys are provided with the vehicle.

## Vehicles without a smart key system (type A)

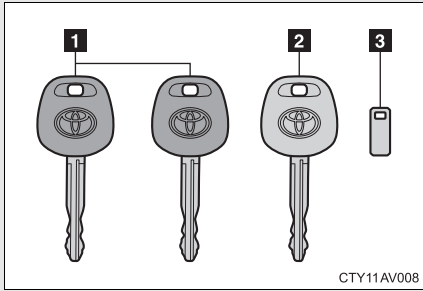

- 1** Master keys
- 2** Valet key
- 3** Key number plate

## Vehicles without a smart key system (type B)

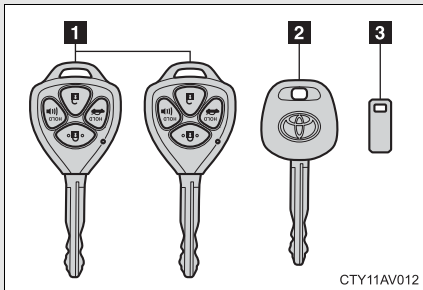

- 1** Master keys  
Operating the wireless remote control function (→P. 46)
- 2** Valet key
- 3** Key number plate

## Vehicles without a smart key system (type C)

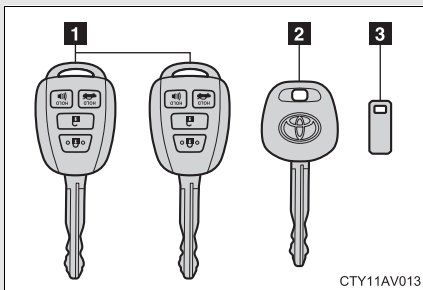

- 1** Master keys  
Operating the wireless remote control function (→P. 46)
- 2** Valet key
- 3** Key number plate

## Vehicles with a smart key system

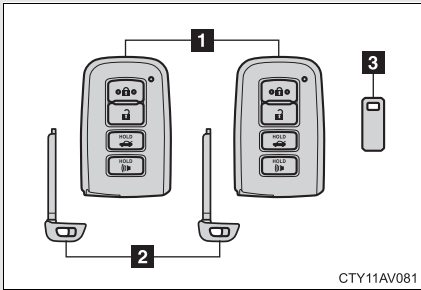

### 1 Electronic keys

- Operating the smart key system (→P. 32)
- Operating the wireless remote control function (→P. 46)

### 2 Mechanical keys

### 3 Key number plate

## Using the mechanical key (vehicles with a smart key system)

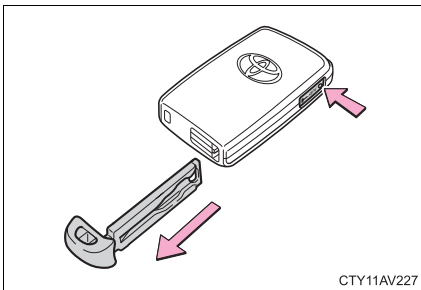

To take out the mechanical key, push the release button and take the key out.

The mechanical key can only be inserted in one direction, as the key only has grooves on one side. If the key cannot be inserted in a lock cylinder, turn it over and re-attempt to insert it.

After using the mechanical key, store it in the electronic key. Carry the mechanical key together with the electronic key. If the electronic key battery is depleted or the entry function does not operate properly, you will need the mechanical key. (→P. 451)

■ **When required to leave the vehicle's key with a parking attendant**

Lock the glove box as circumstances demand. (→P. 290)

Vehicles without a smart key system: Carry the master key for your own use and provide the attendant with the valet key.

Vehicles with a smart key system: Remove the mechanical key for your own use and provide the attendant with the electronic key only.

■ **Key number plate**

Keep the plate in a safe place such as your wallet, not in the vehicle. In the event that a key (without a smart key system) or mechanical key (with a smart key system) is lost, a new key can be made by your Toyota dealer using the key number plate. (→P. 450)

■ **When riding in an aircraft (vehicles with a wireless remote control)**

When bringing a key with wireless remote control function onto an aircraft, make sure you do not press any buttons on the key while inside the aircraft cabin. If you are carrying the key in your bag etc., ensure that the buttons are not likely to be pressed accidentally. Pressing a button may cause the key to emit radio waves that could interfere with the operation of the aircraft.

 NOTICE**■ To prevent key damage**

Observe the following:

- Do not drop the keys, subject them to strong shocks or bend them.
- Do not expose the keys to high temperatures for long periods of time.
- Do not get the keys wet or wash them in an ultrasonic washer etc.
- Do not attach metallic or magnetic materials to the keys or place the keys close to such materials.
- Do not disassemble the keys.
- Do not attach a sticker or anything else to the surface of the key.
- Do not place the keys near objects that produce magnetic fields, such as TVs, audio systems and glass top ranges, or medical electrical equipment, such as low-frequency therapy equipment.

**■ Carrying the electronic key on your person (vehicles with a smart key system)**

Carry the electronic key 3.9 in. (10 cm) or more away from electric appliances that are turned on. Radio waves emitted from electric appliances within 3.9 in. (10 cm) of the electronic key may interfere with the key, causing the key to not function properly.

**■ In case of a smart key system malfunction or other key-related problems (vehicles with a smart key system)**

Take your vehicle with all the electronic keys provided with your vehicle to your Toyota dealer.

**■ When a vehicle key is lost (vehicles with a smart key system)**

If the key remains lost, the risk of vehicle theft increases significantly. Visit your Toyota dealer immediately with all remaining electronic keys that was provided with your vehicle.

## 1-2. Opening, closing and locking the doors and trunk Smart key system\*

The following operations can be performed simply by carrying the electronic key on your person, for example in your pocket.  
(The driver should always carry the electronic key.)

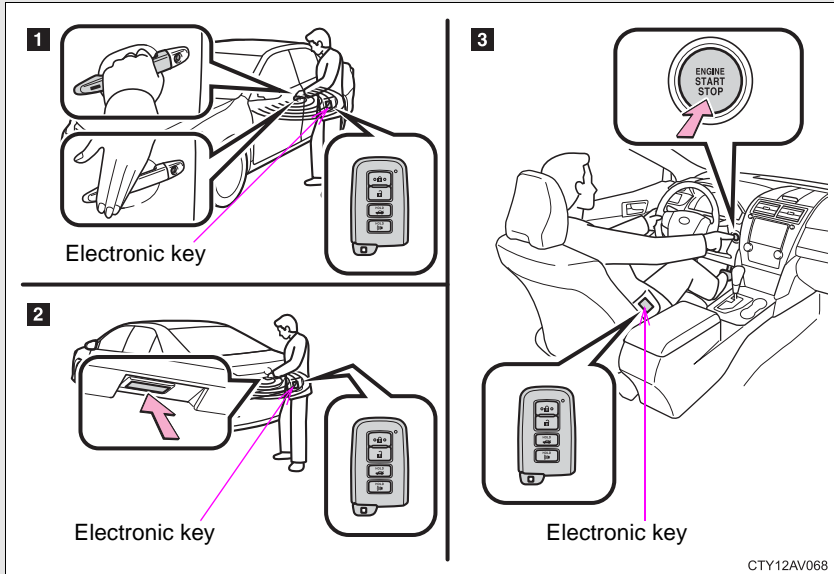

- 1** Unlocks and locks the doors (→P. 33)
- 2** Unlocks the trunk (→P. 33)
- 3** Starts the engine (→P. 148)

\*: If equipped



### Unlocking and locking the doors (front door handles only)

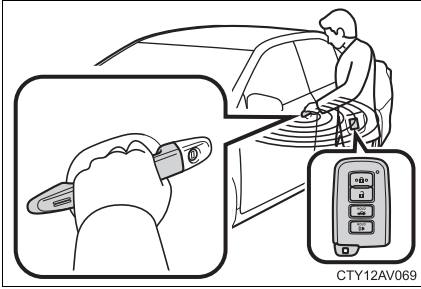

Grip the driver's door handle to unlock the door. Grip the passenger's door handle to unlock all the doors.\*

Make sure to touch the sensor on the back of the handle.

The doors cannot be unlocked for 3 seconds after the doors are locked.

\*: The door unlock settings can be changed. (→P. 38)

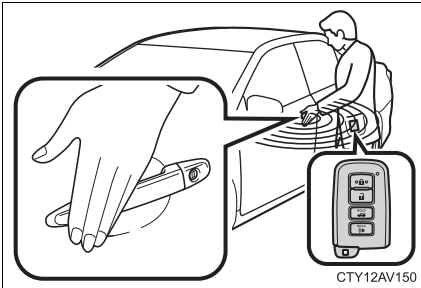

Touch the lock sensor (the indentation on the side of the door handle) to lock the doors.

### Unlocking the trunk

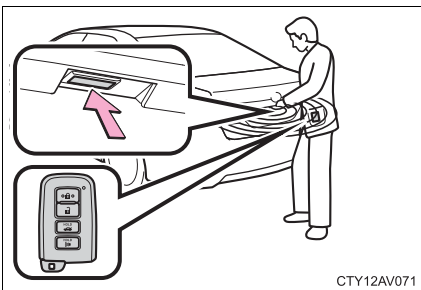

Press the button to unlock the trunk.

## Antenna location and effective range

### ■ Antenna location

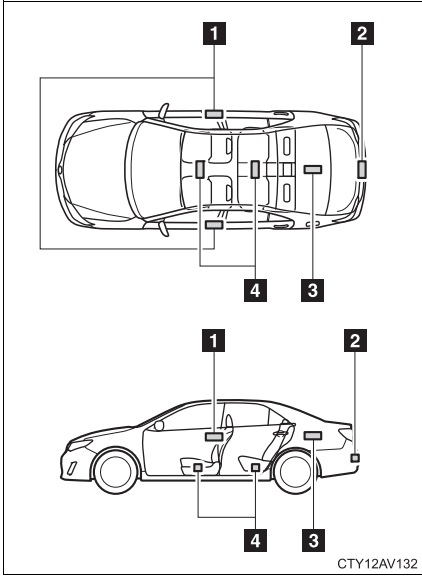

- 1** Antennas outside the cabin
- 2** Antenna outside the trunk
- 3** Antenna inside the trunk
- 4** Antennas inside the cabin

■ **Effective range (areas within which the electronic key is detected)**

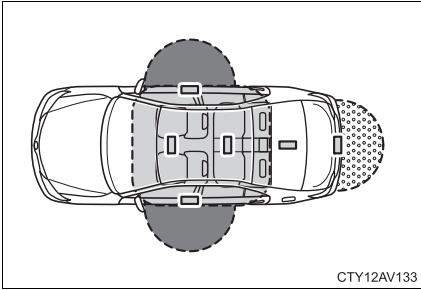

- When locking or unlocking the doors

The system can be operated when the electronic key is within about 2.3 ft. (0.7 m) of either of the front outside door handles. (Only the doors detecting the key can be operated.)

- When unlocking the trunk

The system can be operated when the electronic key is within about 2.3 ft. (0.7 m) of the trunk release button.

- When starting the engine or changing “ENGINE START STOP” switch modes

The system can be operated when the electronic key is inside the vehicle.

■ **Operation signals**

Doors: A buzzer sounds and the emergency flashers flash to indicate that the doors have been locked/unlocked. (Locked: Once; Unlocked: Twice)

Trunk: A buzzer sounds to indicate that the trunk has been unlocked.

■ **When the door cannot be locked by the lock sensor**

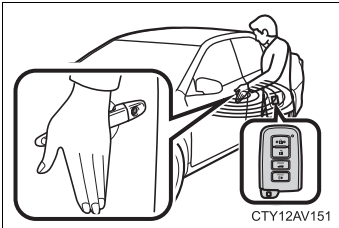

Use your palm to touch the lock sensor.

■ **Alarms and warning indicators**

A combination of exterior and interior alarms as well as warning lights are used to prevent theft of the vehicle and unforeseeable accidents resulting from erroneous operation. Take appropriate measures for the warning light that comes on. (→P. 427)

The following table describes circumstances and correction procedures when only alarms are sounded.

Alarm	Situation	Correction procedure
Exterior alarm sounds once for 5 seconds	An attempt was made to lock the doors using the smart key system while the electronic key was still inside the vehicle.	Retrieve the electronic key from the passenger compartment and lock the doors again.
	The trunk was closed while the electronic key was still inside the trunk and all the doors were locked.	Retrieve the electronic key from the trunk and close the trunk lid.
	An attempt was made to lock the vehicle while a door was open.	Close all of the doors and lock the doors again.

Alarm	Situation	Correction procedure
Interior alarm pings once and exterior alarm sounds once for 5 seconds	An attempt was made to lock either front door by opening a door and putting the inside lock button into the lock position, then closing the door with the electronic key still inside the vehicle.	Retrieve the electronic key from the vehicle and lock the doors again.
Interior alarm sounds continuously	The "ENGINE START STOP" switch was turned to ACCESSORY mode while the driver's door was open (The driver's door was opened when the "ENGINE START STOP" switch was in ACCESSORY mode.)	Turn the "ENGINE START STOP" switch off and close the driver's door.
	The driver's door was opened while any shift position other than P was selected without turning off the "ENGINE START STOP" switch.	Shift the shift lever to P.





### ■ Security feature

If a door is not opened within approximately 60 seconds after the vehicle is unlocked, the security feature automatically locks the vehicle again. (However, depending on the location of the electronic key, the key may be detected as being in the vehicle. In this case, vehicle may be unlocked.)

### ■ Switching the door unlock function

It is possible to set which doors the entry function unlocks using the wireless remote control.

**STEP 1** Turn the “ENGINE START STOP” switch off.

**STEP 2** When the indicator light on the key surface is not on, press and hold  ,  , or  for about 5 seconds while pressing and holding  .

The setting changes each time an operation is performed, as shown below. (When changing the setting continuously, release the buttons, wait for at least 5 seconds, and repeat step 2.)

Unlocking doors	Beep
Holding the driver's door handle unlocks only the driver's door.	Exterior: Beeps 3 times Interior: Beeps once
Holding the front passenger's door handle unlocks all the doors.	
Holding either front door handle unlocks all the doors.	Exterior: Beeps twice Interior: Beeps once

Vehicles with an alarm system: To prevent unintended triggering of the alarm, unlock the doors using the wireless remote control and open and close a door once after the settings have been changed. (If a door is not opened within 60 seconds after  is pressed, the doors will be locked again and the alarm will automatically be set.)

In case that the alarm is triggered, immediately stop the alarm. (→P. 95)

### ■ Battery-saving function



The battery-saving function will be activated in order to prevent the electronic key battery and the vehicle battery from being discharged while the vehicle is not in operation for a long time.

- In the following situations, the smart key system may take some time to unlock the doors.
  - The electronic key has been left in an area of approximately 6 ft. (2 m) of the outside of the vehicle for 10 minutes or longer.
  - The smart key system has not been used for 5 days or longer.
- If the smart key system has not been used for 14 days or longer, the doors cannot be unlocked at any doors except the driver's door. In this case, take hold of the driver's door handle, or use the wireless remote control or the mechanical key, to unlock the doors.

### ■ Electronic key battery-saving function

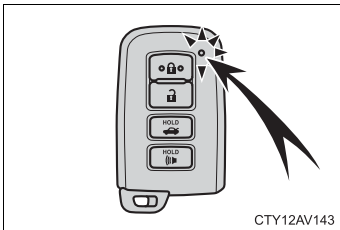
When battery-saving mode is set, battery depletion is minimized by stopping the electronic key from receiving radio waves.



Press  twice while pressing and holding . Confirm that the electronic key indicator flashes 4 times.

While the battery-saving mode is set, the smart key system cannot be used. To cancel the function, press any of the electronic key buttons.

### ■ Conditions affecting operation

The smart key system uses weak radio waves. In the following situations, the communication between the electronic key and the vehicle may be affected, preventing the smart key system, wireless remote control and engine immobilizer system from operating properly.

(Ways of coping: →P. 451)

- When the electronic key battery is depleted
- Near a TV tower, electric power plant, gas station, radio station, large display, airport or other facility that generates strong radio waves or electrical noise
- When the electronic key is in contact with, or is covered by the following metallic objects
  - Cards to which aluminum foil is attached
  - Cigarette boxes that have aluminum foil inside
  - Metallic wallets or bags
  - Coins
  - Hand warmers made of metal
  - Media such as CDs and DVDs
- When other wireless key (that emit radio waves) is being used nearby
- When carrying the electronic key together with the following devices that emit radio waves
  - A portable radio, cellular phone, cordless phone or other wireless communication device
  - Another vehicle's electronic key or a wireless key that emits radio waves
  - Personal computers or personal digital assistants (PDAs)
  - Digital audio players
  - Portable game systems
- If window tint with a metallic content or metallic objects are attached to the rear window
- When the electronic key is placed near a battery charger or electronic devices



### ■ Notes for the entry function

- Even when the electronic key is within the effective range (detection areas), the system may not operate properly in the following cases:
  - The electronic key is too close to the window or outside door handle, near the ground, or in a high place when the doors are locked or unlocked.
  - The electronic key is near the ground or in a high place, or too close to the rear bumper center when the trunk is unlocked.
  - The electronic key is on the instrument panel, rear package tray or floor, in the door pockets or glove box, or near a vent when the engine is started or “ENGINE START STOP” switch modes are changed.
- Do not leave the electronic key on top of the instrument panel or near the door pockets or a vent when exiting the vehicle. Depending on the radio wave reception conditions, it may be detected by the antenna outside the cabin and the door will become lockable from the outside, possibly trapping the electronic key inside the vehicle.
- As long as the electronic key is within the effective range, the doors may be locked or unlocked by anyone.
- Even if the electronic key is not inside the vehicle, it may be possible to start the engine if the electronic key is near the window.
- The doors may unlock if a large amount of water splashes on the door handle, such as in the rain or in a car wash when the electronic key is within the effective range. (The door will automatically be locked after approximately 60 seconds if the doors are not opened and closed.)
- Gripping the door handle when wearing a glove may not unlock the door.
- If the wireless remote control is used to lock the doors when the electronic key is near the vehicle, there is a possibility that the door may not be unlocked by the entry function. (Use the wireless remote control to unlock the doors.)
- A sudden approach to the effective range or door handle may prevent the doors from being unlocked. In this case, return the door handle to the original position and check that the doors unlock before pulling the door handle again.

### ■ Notes for locking the doors

- Touching the door lock sensor while wearing gloves may delay or prevent lock operation. Remove the gloves and touch the lock sensor again.
- When the lock operation is performed using the lock sensor, recognition signals will be shown up to two consecutive times. After this, no recognition signals will be given.
- If the door handle becomes wet while the electronic key is within the effective range, the door may lock and unlock repeatedly. In that case, follow the following correction procedures to wash the vehicle:
  - Place the electronic key in a location 6 ft. (2 m) or more away from the vehicle. (Take care to ensure that the key is not stolen.)
  - Set the electronic key to battery-saving mode to disable the smart key system. (→P. 39)
- If the electronic key is inside the vehicle and a door handle becomes wet during a car wash, a buzzer will sound outside the vehicle. To turn off the alarm, lock all the doors.
- The lock sensor may not work properly if it comes into contact with ice, snow, mud, etc. Clean the lock sensor and attempt to operate it again.

### ■ Notes for the unlocking function

- A sudden approach to the effective range or door handle may prevent the doors from being unlocked. In this case, return the door handle to the original position and check that the doors unlock before pulling the door handle again.
- Gripping the door handle when wearing a glove may not unlock the door. Remove the gloves and touch the sensor on the back of the handle again.
- If the door handle becomes wet while the electronic key is within the effective range, the door may lock and unlock repeatedly. In that case, follow the following correction procedures to wash the vehicle:
  - Place the electronic key in a location 6 ft. (2 m) or more away from the vehicle. (Take care to ensure that the key is not stolen.)
  - Set the electronic key to battery-saving mode to disable the smart key system. (→P. 39)
- If there is another electronic key in the detection area, it may take slightly longer to unlock the doors after the door handle is gripped.

■ **When the vehicle is not driven for extended periods**

- To prevent theft of the vehicle, do not leave the electronic key within 6 ft. (2 m) of the vehicle.
- The smart key system can be deactivated in advance. (→P. 493)

■ **Alarm (if equipped)**

Using the smart key system to lock the doors will set the alarm system. (→P. 95)

■ **To operate the system properly**

Make sure to carry the electronic key when operating the system. Do not get the electronic key too close to the vehicle when operating the system from the outside of the vehicle.

Depending on the position and holding condition of the electronic key, the key may not be detected correctly and the system may not operate properly. (The alarm may go off accidentally, or the door lock prevention function may not operate.)

■ **If the smart key system does not operate properly**

- Locking and unlocking the doors: Use the mechanical key. (→P. 451)
- Starting the engine: →P. 451

### ■ **Electronic key battery depletion**

- The standard battery life is 1 to 2 years.
- If the battery becomes low, an alarm will sound in the cabin when the engine stops. (→P. 427)
- As the electronic key always receives radio waves, the battery will become depleted even if the electronic key is not used. The following symptoms indicate that the electronic key battery may be depleted. Replace the battery when necessary. (→P. 386)
  - The smart key system or the wireless remote control does not operate.
  - The detection area becomes smaller.
  - The LED indicator on the key surface does not turn on.
- To avoid serious deterioration, do not leave the electronic key within 3 ft. (1 m) of the following electrical appliances that produce a magnetic field:
  - TVs
  - Personal computers
  - Cellular phones, cordless phones and battery chargers
  - Recharging cellular phones or cordless phones
  - Glass top ranges
  - Table lamps

### ■ **When the electronic key battery is fully depleted**

→P. 386

### ■ **If the smart key system has been deactivated in a customized setting**

- Locking and unlocking the doors: Use the wireless remote control or mechanical key. (→P. 46, 451)
- Starting the engine and changing “ENGINE START STOP” switch modes: →P. 452
- Stopping the engine: →P. 149

### ■ **Customization that can be configured at Toyota dealer**

Settings (e. g. smart key system) can be changed.  
(Customizable features: →P. 493)

## ■ Certification for the smart key system

### U.S.A.

FCC ID: NI4TMLF10-4

FCC ID: NI4TMLF10-5

FCC ID: HYQ23AAB

FCC ID: HYQ14FBA

### NOTE:

This device complies with Part 15 of the FCC Rules. Operation is subject to the following two conditions: (1) this device may not cause harmful interference, and (2) this device must accept any interference received, including interference that may cause undesired operation.

### FCC WARNING:

Changes or modifications not expressly approved by the party responsible for compliance could void the user's authority to operate the equipment.

### Canada

### NOTE:

Operation is subject to the following two conditions: (1) this device may not cause interference, and (2) this device must accept any interference, including interference that may cause undesired operation of the device.

## CAUTION

### ■ Caution regarding interference with electronic devices

- People with implanted pacemakers or cardiac defibrillators should keep away from the smart key system antennas. (→P. 34)

The radio waves may affect the operation of such devices. If necessary, the entry function can be disabled. Ask your Toyota dealer for details, such as the frequency of radio waves and timing of emitting the radio waves. Then, consult your doctor to see if you should disable the entry function.

- Users of any electrical medical device other than implanted pacemakers and implanted cardiac defibrillators should consult the manufacturer of the device for information about its operation under the influence of radio waves.

Radio waves could have unexpected effects on the operation of such medical devices.

Ask your Toyota dealer for details for disabling the entry function.

## 1-2. Opening, closing and locking the doors and trunk Wireless remote control\*

The wireless remote control can be used to lock and unlock the vehicle.

### Vehicles without a smart key system (type A)

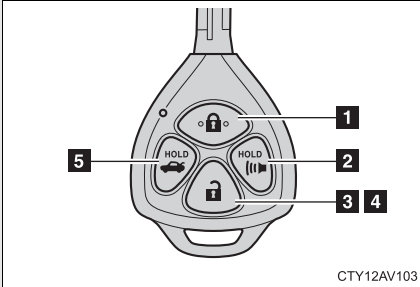

**1** Locks all the doors

**2** Sounds the alarm  
(press and hold)

**3** Unlocks all the doors

Pressing the button unlocks the driver's door. Pressing the button again within 5 seconds unlocks the other doors.

**4** Opens the driver's window and moon roof (press and hold)\*

**5** Unlocks the trunk  
(press and hold)

\*: This setting must be customized at your Toyota dealer.

\*: If equipped

### Vehicles without a smart key system (type B)

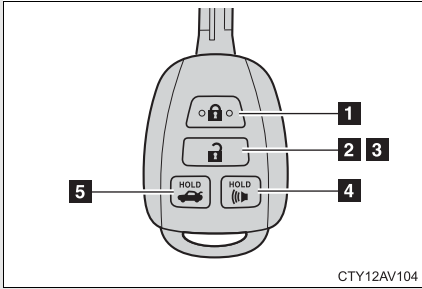

- 1** Locks all the doors
  - 2** Unlocks all the doors
- Pressing the button unlocks the driver's door. Pressing the button again within 5 seconds unlocks the other doors.
- 3** Opens the driver's window and moon roof (press and hold)\*
  - 4** Sounds the alarm (press and hold)
  - 5** Unlocks the trunk (press and hold)

\*: This setting must be customized at your Toyota dealer.

### Vehicles with a smart key system

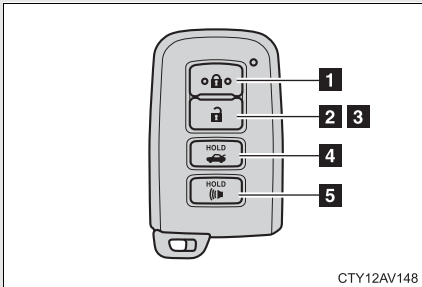

- 1** Locks all the doors
  - 2** Unlocks all the doors
- Pressing the button unlocks the driver's door. Pressing the button again within 5 seconds unlocks the other doors.
- 3** Opens the driver's window and moon roof (press and hold)\*
  - 4** Unlocks the trunk (press and hold)
  - 5** Sounds the alarm (press and hold)

\*: This setting must be customized at your Toyota dealer.

### ■ Operation signals

**Doors:** A buzzer sounds and the emergency flashers flash to indicate that the doors have been locked/unlocked.

(Locked: Once; Unlocked: Twice)

**Trunk:** A buzzer sounds to indicate that the trunk has been unlocked.

**Driver's window and moon roof:** A buzzer sounds to indicate that the driver's window and moon roof are opening.

### ■ Door lock buzzer

If an attempt to lock the doors is made when a door is not fully closed, a buzzer sounds continuously. Fully close the door to stop the buzzer, and lock the vehicle once more.

### ■ Panic mode

#### Vehicles without a smart key system

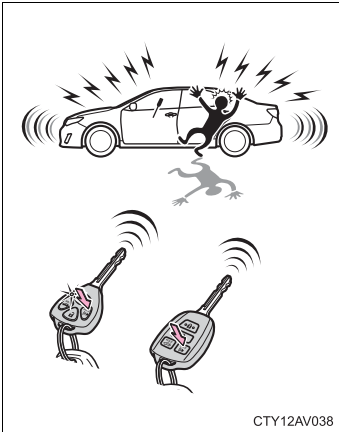

When  is pressed for longer than about one second, an alarm will sound intermittently and the vehicle lights will flash to deter any person from trying to break into or damage your vehicle.

To stop the alarm, press any button on the wireless remote control.



### Vehicles with a smart key system



When  is pressed for longer than about one second, an alarm will sound intermittently and the vehicle lights will flash to deter any person from trying to break into or damage your vehicle.

To stop the alarm, press any button on the electronic key.

#### ■ Security feature

If a door is not opened within approximately 60 seconds after the vehicle is unlocked, the security feature automatically locks the vehicle again.

#### ■ Alarm (if equipped)

Using the wireless remote control to lock the doors will set the alarm system. (→P. 95)

## ■ Conditions affecting operation

### Vehicles without a smart key system

The wireless remote control function may not operate normally in the following situations:

- When the wireless key battery is depleted
- Near a TV tower, electric power plant, gas station, radio station, large display, airport or other facility that generates strong radio waves or electrical noise
- When carrying a portable radio, cellular phone or other wireless communication devices
- When the wireless key is in contact with, or is covered by a metallic object
- When other wireless key (that emit radio waves) is being used nearby
- If window tint with a metallic content or metallic objects are attached to the rear window

### Vehicles with a smart key system

→P. 40

## ■ If the wireless remote control does not operate properly (vehicles with a smart key system)

Locking and unlocking the doors: Use the mechanical key. (→P. 451)

## ■ Key battery depletion

### Vehicles without a smart key system

If the wireless remote control function does not operate, the battery may be depleted. Replace the battery when necessary. (→P. 384)

### Vehicles with a smart key system

→P. 44

## ■ When the key battery is fully depleted

→P. 384

## ■ Confirmation of the registered key number (vehicles with a smart key system)

The number of keys already registered to the vehicle can be confirmed. Ask your Toyota dealer for details.

**■ Customization that can be configured at Toyota dealer**

Settings (e.g. wireless remote control system) can be changed.  
(Customizable features: →P. 493)

**■ Certification for wireless remote control****U.S.A. (vehicles without a smart key system)**

FCC ID: HYQ23AAC

FCC ID: HYQ12BDM

**NOTE:**

This device complies with Part 15 of the FCC Rules. Operation is subject to the following two conditions: (1) this device may not cause harmful interference, and (2) this device must accept any interference received, including interference that may cause undesired operation.

**FCC WARNING:**

Changes or modifications not expressly approved by the party responsible for compliance could void the user's authority to operate the equipment.

**U.S.A. (vehicles with a smart key system)**

FCC ID: NI4TMLF10-4

FCC ID: NI4TMLF10-5

FCC ID: HYQ23AAB

FCC ID: HYQ14FBA

**NOTE:**

This device complies with Part 15 of the FCC Rules. Operation is subject to the following two conditions: (1) this device may not cause harmful interference, and (2) this device must accept any interference received, including interference that may cause undesired operation.

**FCC WARNING:**

Changes or modifications not expressly approved by the party responsible for compliance could void the user's authority to operate the equipment.

**Canada****NOTE:**

Operation is subject to the following two conditions: (1) this device may not cause interference, and (2) this device must accept any interference, including interference that may cause undesired operation of the device.

## 1-2. Opening, closing and locking the doors and trunk

### Doors

The vehicle can be locked and unlocked using the entry function, wireless remote control, key or door lock switch.

#### ■ Entry function (vehicles with a smart key system)

→P. 32

#### ■ Wireless remote control (if equipped)

→P. 46

#### ■ Key

Turning the key operates the doors as follows:

#### Vehicles without a smart key system

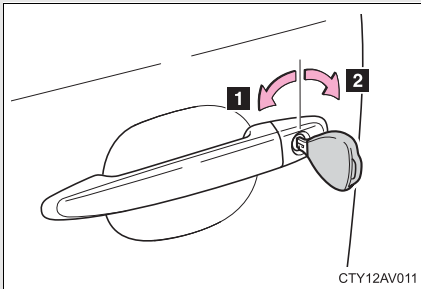

**1** Locks all the doors

**2** Unlocks all the doors

Driver's side only: Turning the key unlocks the driver's door. Turning the key again unlocks the other doors.

#### Vehicles with a smart key system

The doors can also be locked and unlocked with the mechanical key. (→P. 451)

#### ■ Door lock switch

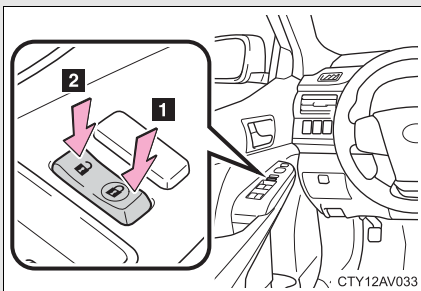

**1** Locks all the doors

**2** Unlocks all the doors

### ■ Inside lock button

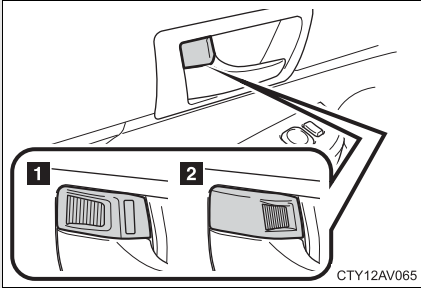

**1** Unlocks the door

**2** Locks the door

The front doors can be opened by pulling the inside handle even if the lock buttons are in the lock position.

1

Before driving

### Locking the doors from the outside without a key

**STEP 1** Move the inside lock button to the lock position.

**STEP 2** Close the door.

#### Vehicles without a smart key system

The door cannot be locked if either of the front doors is open and the key is in the engine switch.

#### Vehicles with a smart key system

The door cannot be locked if the “ENGINE START STOP” switch is in ACCESSORY or IGNITION ON mode, or the electronic key is left inside the vehicle.

The key may not be detected correctly and the door may be locked.

## Rear door child-protector lock



The door cannot be opened from inside the vehicle when the lock is set.

**1** Unlock

**2** Lock

These locks can be set to prevent children from opening the rear doors. Push down on each rear door switch to lock both rear doors.

## Automatic door locking and unlocking systems

The following functions can be set or cancelled:

Function	Operation
Shift position linked door locking function	Shifting the shift lever out of P locks all the doors.
Shift position linked door unlocking function	Shifting the shift lever to P unlocks all the doors.
Speed linked door locking function	All the doors are locked when the vehicle speed is approximately 12 mph (20 km/h) or higher.
Driver's door linked door unlocking function (vehicles without a smart key system)	All the doors are unlocked when the driver's door is opened within 10 seconds after turning the engine switch to "ACC" or "LOCK".
Driver's door linked door unlocking function (vehicles with a smart key system)	All the doors are unlocked when the driver's door is opened within 10 seconds after turning the "ENGINE START STOP" switch off.

### ■ Setting and canceling the functions (vehicles without navigation system and Display Audio system)

To switch between setting and canceling, follow the procedure below.

#### STEP 1 Vehicles without a smart key system



Close all the doors and turn the engine switch to the "ON" position. (Perform step 2 within 10 seconds.)

#### Vehicles with a smart key system

Close all the doors and turn the "ENGINE START STOP" switch to IGNITION ON mode. (Perform step 2 within 10 seconds.)

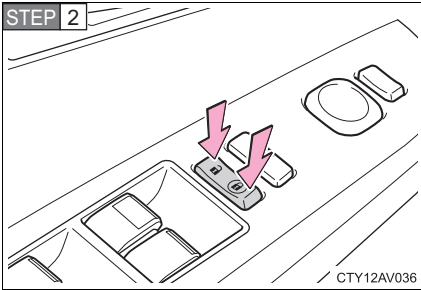



## 1-2. Opening, closing and locking the doors and trunk



Shift the shift lever to P or N, and press and hold the driver's door lock switch (  or  ) for approximately 5 seconds and then release.

The shift lever and switch positions corresponding to the desired function to be set are shown in the following table.

Use the same procedure to cancel the function.

Function	Shift lever position	Driver's door lock switch position
Shift position linked door locking function	P	
Shift position linked door unlocking function		
Speed linked door locking function	N	
Driver's door linked door unlocking function		

When the setting or canceling operation is complete, all doors are locked and then unlocked.



**■ If a wrong key is used (vehicles with a smart key system)**

The key cylinder rotates freely to isolate inside mechanism.

**■ If the smart key system has been deactivated in a customized setting (vehicles with a smart key system)**

Use the wireless remote control or mechanical key. (→P. 46, 451)

**■ Customization that can be configured at Toyota dealer**

Settings (e.g. unlocking function using a key) can be changed.  
(Customizable features →P. 493)

**⚠ CAUTION****■ To prevent an accident**

Observe the following precautions while driving the vehicle.

Failure to do so may result in a door opening and an occupant falling out, resulting in death or serious injury.

● Always use a seat belt.

● Always lock all the doors.

● Ensure that all doors are properly closed.

● Do not pull the inside handle of the doors while driving.

The doors may be opened and the passengers are thrown out of the vehicle and it may result in serious injury or death.

Be especially careful for the front doors, as the doors may be opened even if the inside lock buttons are in locked position.

● Set the rear door child-protector locks when children are seated in the rear seats.

## 1-2. Opening, closing and locking the doors and trunk

### Trunk

The trunk can be opened using the key, trunk opener, entry function or wireless remote control.

#### ■ Opening the trunk from inside the vehicle

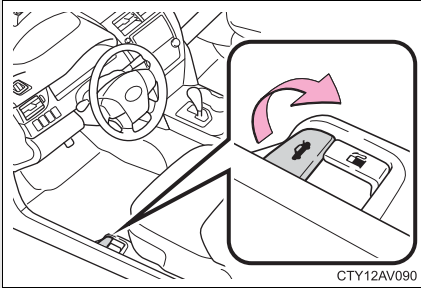

Pull up the lever to release the trunk lid.

#### ■ Opening the trunk from outside the vehicle

##### Key (vehicles without a wireless remote control)

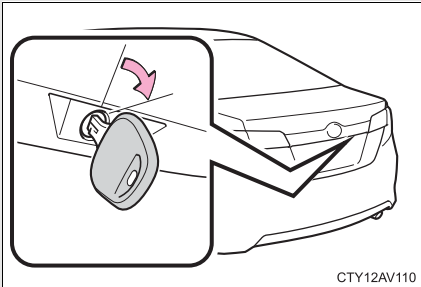

Turn the master key clockwise to release the trunk lid.

##### Entry function (vehicles with a smart key system)

→P. 32

##### Wireless remote control (if equipped)

→P. 46

### ■ Trunk light

The trunk light turns on when the trunk is opened.

### ■ Function to prevent the trunk being locked with the electronic key inside (vehicles with a smart key system)

● When all doors are being locked, closing the trunk lid with the electronic key left inside the trunk will sound an alarm.

In this case, the trunk lid can be opened using the entry function.

● Even when the spare electronic key is put in the trunk with all the doors locked, the key confinement prevention function can be activated so the trunk can be opened. In order to prevent theft, take all electronic keys with you when leaving the vehicle.

● Even when the electronic key is put in the trunk with all the doors are locked, the key may not be detected depending on the places and the surrounding radio wave conditions. In this case, the key confinement prevention function cannot be activated, causing the doors to lock when the trunk is closed. Make sure to check where the key is before closing the trunk.

● The key confinement prevention function cannot be activated if any one of the doors is unlocked. In this case, open the trunk using the trunk opener.

### ■ Internal trunk release lever

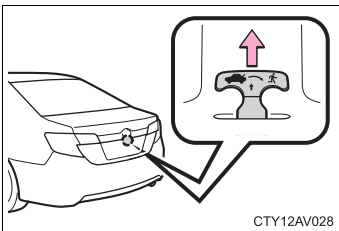

The trunk lid can be opened by pulling up the glow-in-the-dark lever located on the inside of the trunk lid.

The lever will continue to glow for some time after the trunk lid is closed.

 **CAUTION**

■ **Caution while driving**

- Keep the trunk lid closed while driving.

If the trunk lid is left open, it may hit near-by objects while driving or luggage in the trunk may be unexpectedly thrown out, causing an accident. In addition, exhaust gases may enter the vehicle, causing death or a serious health hazard. Make sure to close the trunk lid before driving.

- Before driving the vehicle, make sure that the trunk lid is fully closed. If the trunk lid is not fully closed, it may open unexpectedly while driving, causing an accident.
- Never let anyone sit in the trunk. In the event of sudden braking or a collision, they are susceptible to death or serious injury.

■ **When children are in the vehicle**

Observe the following precautions.

Failure to do so may result in death or serious injury.

- Do not allow children to enter the trunk.

If a child is accidentally locked in the trunk, they could overheat or suffocate.

- Do not allow a child to open or close the trunk lid.

Doing so may cause the trunk lid to operate unexpectedly, or cause the child's hands, head, or neck to be caught by the closing trunk lid.

**! CAUTION****■ Using the trunk**

Observe the following precautions.

Failure to do so may cause parts of the body to be caught, resulting in serious injury.

- Remove any heavy loads, such as snow and ice, from the trunk lid before opening it. Failure to do so may cause the trunk lid to fall closed again after it is opened.
- When opening or closing the trunk lid, thoroughly check to make sure the surrounding area is safe.
- If anyone is in the vicinity, make sure they are safe and let them know that the trunk is about to open or close.
- Use caution when opening or closing the trunk lid in windy weather as it may move abruptly in strong wind.

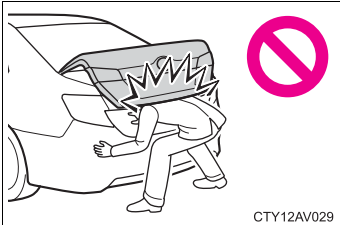

- The trunk lid may fall if it is not opened fully. It is more difficult to open or close the trunk lid on an incline than on a level surface, so beware of the trunk lid unexpectedly opening or closing by itself. Make sure that the trunk lid is fully open and secure before using the trunk.

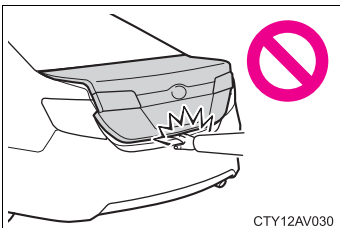

- When closing the trunk lid, take extra care to prevent your fingers etc. from being caught.
- When closing the trunk lid, make sure to press it lightly on its outer surface.

- Do not attach any accessories other than genuine Toyota parts to the trunk lid. Such additional weight on the trunk lid may cause the lid to fall closed again after it is opened.

## Front seats

### Manual seat

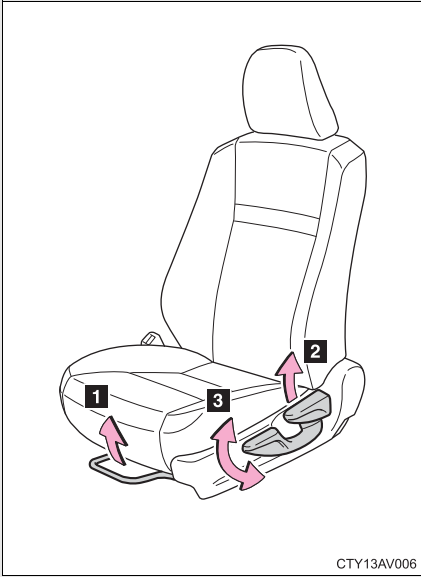

- 1** Seat position adjustment lever
- 2** Seatback angle adjustment lever
- 3** Vertical height adjustment lever (driver's side only)

## Power seat

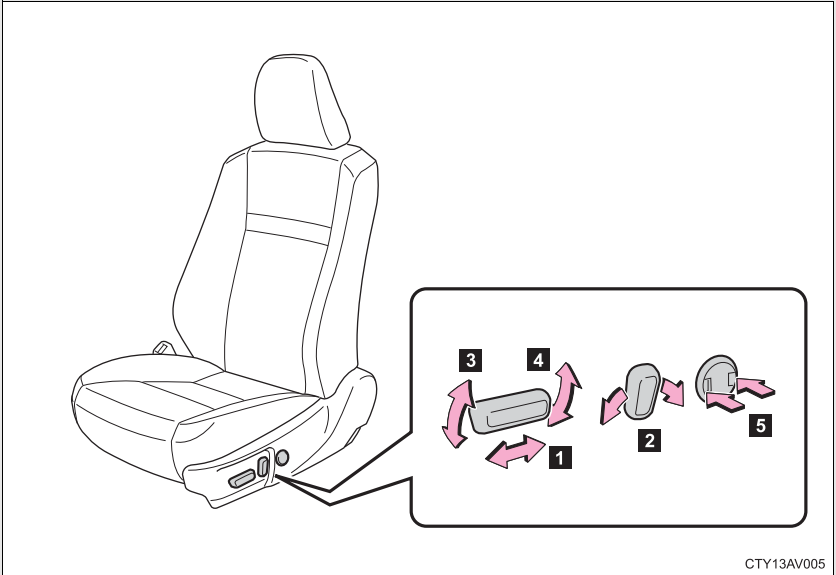

- 1** Seat position adjustment switch
- 2** Seatback angle adjustment switch
- 3** Seat cushion (front) angle adjustment switch (driver's side only)
- 4** Vertical height adjustment switch (driver's side only)
- 5** Lumbar support adjustment switch (driver's side only)

 CAUTION

■ **Seat adjustment**

- To reduce the risk of sliding under the lap belt during a collision, do not recline the seat more than necessary.

If the seat is too reclined, the lap belt may slide past the hips and apply restraint forces directly to the abdomen, or your neck may contact the shoulder belt, increasing the risk of death or serious injury in the event of an accident.

Adjustments should not be made while driving as the seat may unexpectedly move and cause the driver to lose control of the vehicle.

- Manual seat only: After adjusting the seat, make sure that the seat is locked in position.



# 1-3. Adjustable components (seats, mirrors, steering wheel)

## Rear seats

The seatbacks of the rear seats can be folded down.

### Folding down the rear seatbacks

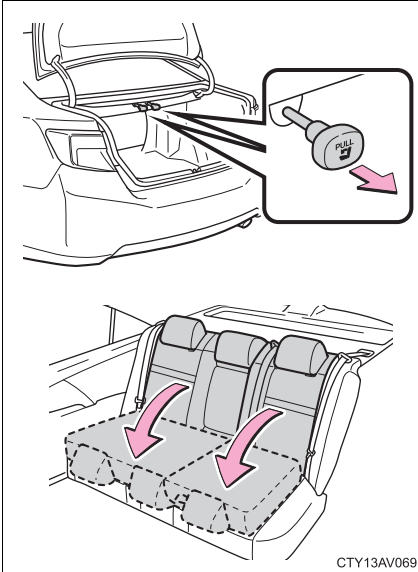

Pull the seatback lever in the trunk for the seatback you wish to fold down.

1  
Before driving

### ⚠ CAUTION

#### ■ When folding the rear seatbacks down

Observe the following precautions. Failure to do so may result in death or serious injury.

- Do not fold the seatbacks down while driving.
- Stop the vehicle on level ground, set the parking brake and shift the shift lever to P.
- Do not allow anyone to sit on a folded seatback or in the trunk while driving.
- Do not allow children to enter the trunk.

 CAUTION

■ **When returning the seat to its original position**

- Ensure that the seat belt does not get caught between or behind the seats.
- If the seat belt has been released from its guide, pass the seat belt through its guide. (→P. 72)

■ **Seat adjustment**

Be careful not to get hands or feet pinched between the rear console box and the rear seat when folding down the rear seatback.

■ **After returning the seatback to the upright position**

Observe the following precautions. Failure to do so may result in death or serious injury.

- Make sure the seatback is securely locked by pressing it forward and rearward on the top.
- Check that the seat belts are not twisted or caught in the seatback.
- Make sure that the seat belt is passing through its guide.

 NOTICE

■ **When left seatback is folded down**

Make sure the luggage loaded in the enlarged trunk will not damage the webbing of the rear center seat belt.

## 1-3. Adjustable components (seats, mirrors, steering wheel)

### Head restraints

Head restraints are provided for all seats.

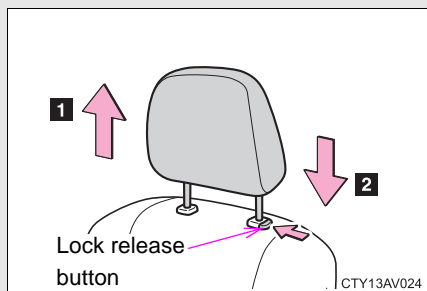

Vertical adjustment (front seats)

**1** Up

Pull the head restraints up.

**2** Down

Push the head restraint down while pushing the lock release button.

1

Before driving

#### ■ Removing the head restraints (front seats)

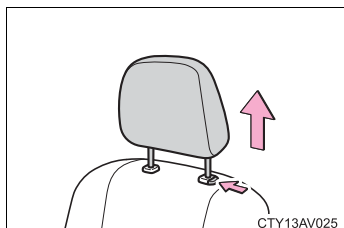

Pull the head restraint up while pressing the lock release button.

#### ■ Installing the head restraints (front seats)

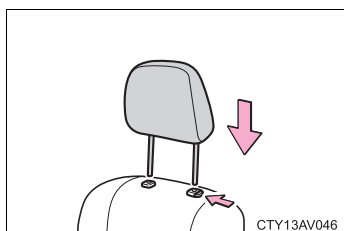

Align the head restraint with the installation holes and push it down to the lock position.

Press and hold the lock release button when lowering the head restraint.

### ■ Adjusting the height of the head restraints (front seats)

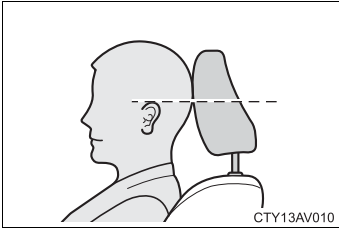

Make sure that the head restraints are adjusted so that the center of the head restraint is closest to the top of your ears.

### ⚠ CAUTION

#### ■ Head restraint precautions (front seats)

Observe the following precautions regarding the head restraints. Failure to do so may result in death or serious injury.

- Use the head restraints designed for each respective seat.
- Adjust the head restraints to the correct position at all times.
- After adjusting the head restraints, push down on them and make sure they are locked in position.
- Do not drive with the head restraints removed.

# 1-3. Adjustable components (seats, mirrors, steering wheel)

## Seat belts

**Make sure that all occupants are wearing their seat belts before driving the vehicle.**

### ■ Correct use of the seat belts

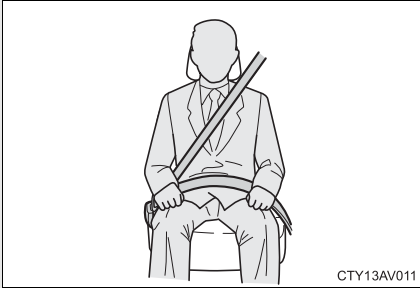

- Extend the shoulder belt so that it comes fully over the shoulder, but does not come into contact with the neck or slide off the shoulder.
- Position the lap belt as low as possible over the hips.
- Adjust the position of the seatback. Sit up straight and well back in the seat.
- Do not twist the seat belt.

### ■ Fastening and releasing the seat belt

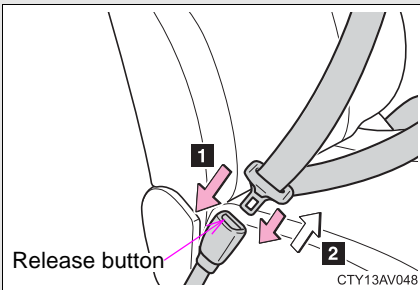

- 1** To fasten the seat belt, push the plate into the buckle until a click sound is heard.
- 2** To release the seat belt, press the release button.

### ■ Adjusting the seat belt shoulder anchor height (front seats)

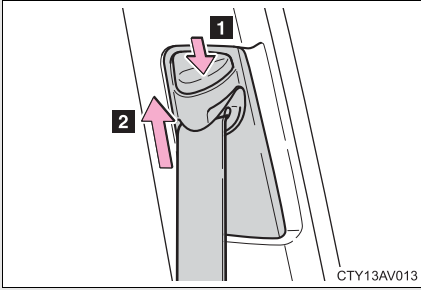

**1** Push the seat belt shoulder anchor down while pressing the release button.

**2** Push the seat belt shoulder anchor up.

Move the height adjuster up and down as needed until you hear a click.

### Seat belt pretensioners (front seats)

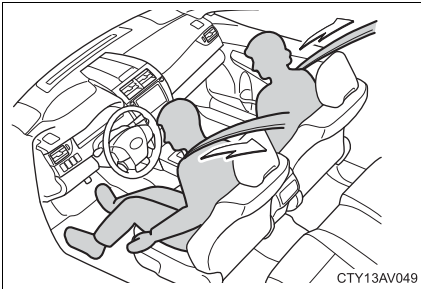

The pretensioner helps the seat belt to quickly restrain the occupant by retracting the seat belt when the vehicle is subjected to certain types of severe frontal or side collision.

The pretensioner may not activate in the event of a minor frontal impact, a minor side impact, a rear impact or a vehicle rollover.

### ■ Emergency locking retractor (ELR)

The retractor will lock the belt during a sudden stop or on impact. It may also lock if you lean forward too quickly. A slow, easy motion will allow the belt to extend so that you can move around fully.

### ■ Automatic locking retractor (ALR)

When a passenger's shoulder belt is completely extended and then retracted even slightly, the belt is locked in that position and cannot be extended. This feature is used to hold the child restraint system (CRS) firmly. To free the belt again, fully retract the belt and then pull the belt out once more. (→P. 122)

### ■ Pregnant women

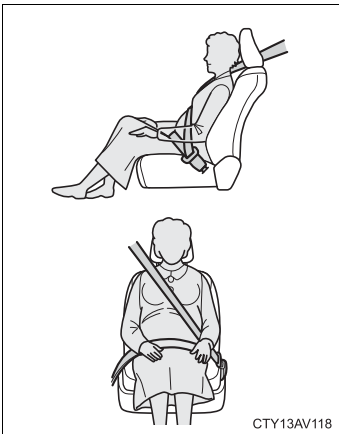

Obtain medical advice and wear the seat belt in the proper way. (→P. 69)

Women who are pregnant should position the lap belt as low as possible over the hips in the same manner as other occupants. Extend the shoulder belt completely over the shoulder and position the belt across the chest. Avoid belt contact over the rounding of the abdominal area.

If the seat belt is not worn properly, not only a pregnant woman, but also the fetus could suffer death or serious injury as a result of sudden braking or a collision.

### ■ People suffering illness

Obtain medical advice and wear the seat belt in the proper way. (→P. 69)

### ■ Child seat belt usage

The seat belts of your vehicle were principally designed for persons of adult size.

- Use a child restraint system appropriate for the child, until the child becomes large enough to properly wear the vehicle's seat belt. (→P. 118)
- When the child becomes large enough to properly wear the vehicle's seat belt, follow the instructions on P. 69 regarding seat belt usage.

### ■ Replacing the belt after the pretensioner has been activated

If the vehicle is involved in multiple collisions, the pretensioner will activate for the first collision, but will not activate for the second or subsequent collisions.

### ■ Seat belt extender

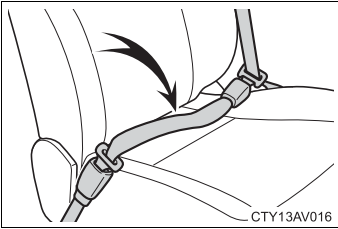

If your seat belts cannot be fastened securely because they are not long enough, a personalized seat belt extender is available from your Toyota dealer free of charge.

### ■ Rear seat belt

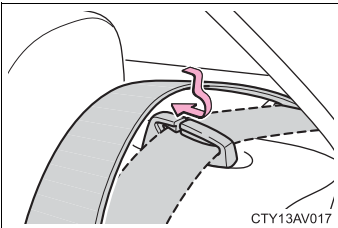

Use the seat belt after passing it through the guide if the seat belt comes free from the guide.



**! CAUTION**

Observe the following precautions to reduce the risk of injury in the event of sudden braking, sudden swerving or an accident. Failure to do so may cause death or severe injury.

**■ Wearing a seat belt**

- Ensure that all passengers wear a seat belt.
- Always wear a seat belt properly.
- Each seat belt should be used by one person only. Do not use a seat belt for more than one person at once, including children.
- Toyota recommends that children be seated in the rear seat and always use a seat belt and/or an appropriate child restraint system.
- To achieve a proper seating position, do not recline the seat more than necessary. The seat belt is most effective when the occupants are sitting up straight and well back in the seats.
- Do not wear the shoulder belt under your arm.
- Always wear your seat belt low and snug across your hips.

**■ When children are in the vehicle**

Do not allow children to play with the seat belt. If the seat belt becomes twisted around a child's neck, it may lead to choking or other serious injuries that could result in death.

If this occurs and the buckle cannot be unfastened, scissors should be used to cut the belt.

**■ Seat belt pretensioners**

- Do not place anything, such as a cushion, on the front passenger's seat. Doing so will disperse the passenger's weight, which prevents the sensor from detecting the passenger's weight properly. As a result, the seat belt pretensioner for the front passenger's seat may not activate in the event of a collision.
- If the pretensioner has activated, the SRS warning light will come on. In that case, the seat belt cannot be used again and must be replaced at your Toyota dealer.

 CAUTION

■ **Adjustable shoulder anchor**

Always make sure the shoulder belt is positioned across the center of your shoulder. The belt should be kept away from your neck, but not falling off your shoulder. Failure to do so could reduce the amount of protection in an accident and cause death or serious injuries in the event of a sudden stop, sudden swerve or accident. (→P. 70)

■ **Seat belt damage and wear**

- Do not damage the seat belts by allowing the belt, plate, or buckle to be jammed in the door.
- Inspect the seat belt system periodically. Check for cuts, fraying, and loose parts. Do not use a damaged seat belt until it is replaced. Damaged seat belts cannot protect an occupant from death or serious injury.
- Ensure that the belt and plate are locked and the belt is not twisted. If the seat belt does not function correctly, immediately contact your Toyota dealer.
- Replace the seat assembly, including the belts, if your vehicle has been involved in a serious accident, even if there is no obvious damage.
- Do not attempt to install, remove, modify, disassemble or dispose of the seat belts. Have any necessary repairs carried out by your Toyota dealer. Inappropriate handling of the pretensioner may prevent it from operating properly, resulting in death or serious injury.
- Always make sure the shoulder belt passes through the guide when using the seat belt. Failure to properly position the belt may reduce the amount of protection in an accident and could lead to death or serious injury in a collision or sudden stop.
- Always make sure that the seat belt is not twisted, does not get caught in the guide or the seatback and is arranged in the proper position.

 **CAUTION**

■ **Using a seat belt extender**

- Do not wear the seat belt extender if you can fasten the seat belt without the extender.
- Do not use the seat belt extender when installing a child restraint system because the belt will not securely hold the child restraint system, increasing the risk of death or serious injury in the event of an accident.
- The personalized extender may not be safe on another vehicle, when used by another person, or at a different seating position other than the one originally intended.

 **NOTICE**

■ **When using a seat belt extender**

When releasing the seat belt, press on the buckle release button on the extender, not on the seat belt.

This helps prevent damage to the vehicle interior and the extender itself.

## 1-3. Adjustable components (seats, mirrors, steering wheel)

### Steering wheel

The steering wheel can be adjusted to a comfortable position.

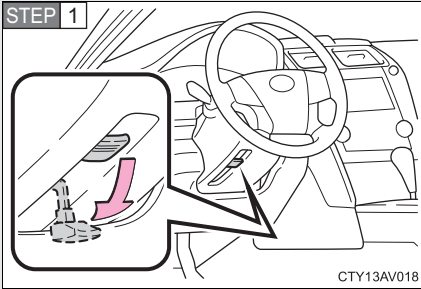

Hold the steering wheel and push the lever down.

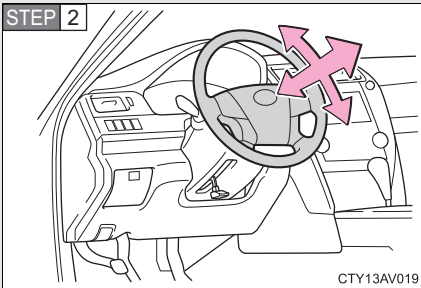

Adjust to the ideal position by moving the steering wheel horizontally and vertically.

After adjustment, pull the lever up to secure the steering wheel.

#### **!** CAUTION

##### ■ Caution while driving

Do not adjust the steering wheel while driving.

Doing so may cause the driver to mishandle the vehicle and cause an accident, resulting in death or serious injury.

##### ■ After adjusting the steering wheel

Make sure that the steering wheel is securely locked.

Otherwise, the steering wheel may move suddenly, possibly causing an accident, and resulting in death or serious injury.

Glare from the headlights of vehicles behind can be reduced by using the following functions:

### Manual anti-glare inside rear view mirror

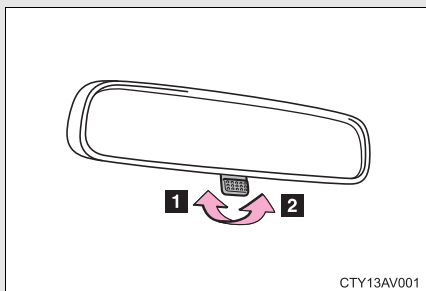

- 1 Normal position
- 2 Anti-glare position

### Auto anti-glare inside rear view mirror

In automatic mode, sensors are used to detect the headlights of vehicles behind and the reflected light is automatically reduced.

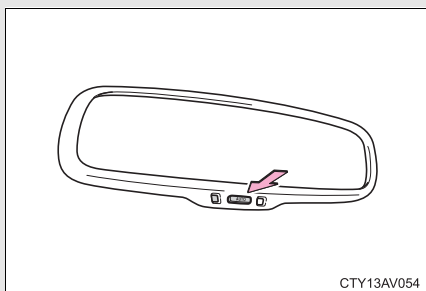

Turns automatic mode on/off

The indicator comes on when automatic mode is turned on.

#### Vehicles without a smart key system

The mirror will revert to the automatic mode each time the engine switch is turned to the "ON" position.

#### Vehicles with a smart key system

The mirror will revert to the automatic mode each time the "ENGINE START STOP" switch is turned to IGNITION ON mode.

## Adjusting the height of rear view mirror

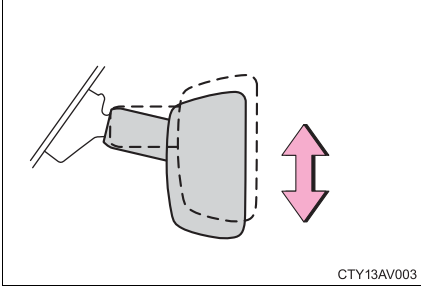

Adjust the height of the rear view mirror by moving it up and down.

### ■ To prevent sensor error (vehicles with auto anti-glare inside rear view mirror)

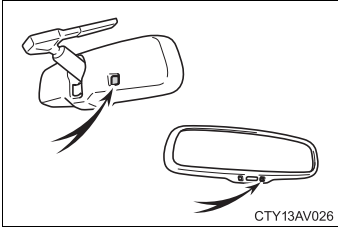

To ensure that the sensors operate properly, do not touch or cover them.

### ⚠ CAUTION

#### ■ Caution while driving

Do not adjust the position of the mirror while driving.

Doing so may lead to mishandling of the vehicle and an accident, resulting in death or serious injury.

# 1-3. Adjustable components (seats, mirrors, steering wheel)

## Outside rear view mirrors

Mirror angle can be adjusted using the switch.

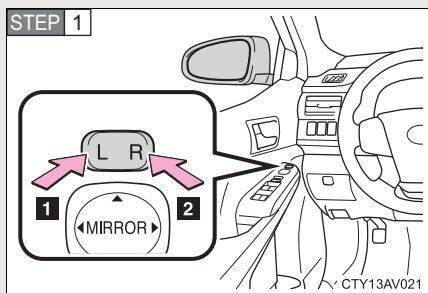

To select a mirror to adjust, press the switch.

- 1** Left
- 2** Right

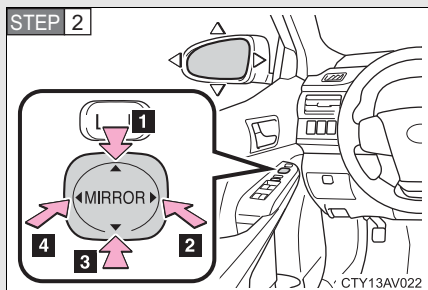

To adjust the mirror, press the switch.

- 1** Up
- 2** Right
- 3** Down
- 4** Left

### Folding the mirrors

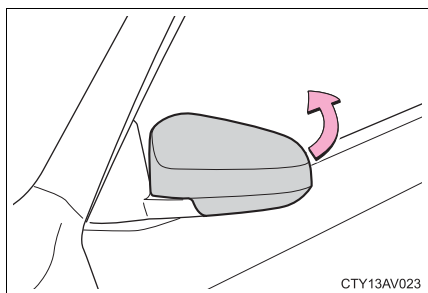

Push the mirror back in the direction of the vehicle's rear.

■ **Mirror angle can be adjusted when**

**Vehicles without a smart key system**

The engine switch is in the “ACC” or “ON” position.

**Vehicles with a smart key system**

The “ENGINE START STOP” switch is in ACCESSORY or IGNITION ON mode.

■ **When the mirrors are fogged up (vehicles with mirror defoggers)**

Turn on the mirror defoggers to defog the mirrors. (→P. 240)



**CAUTION**

■ **When driving the vehicle**

Observe the following precautions while driving.

Failure to do so may result in loss of control of the vehicle and cause an accident, resulting in death or serious injury.

- Do not adjust the mirrors while driving.
- Do not drive with the mirrors folded.
- Both the driver and passenger side mirrors must be extended and properly adjusted before driving.

■ **When a mirror is moving**

To avoid personal injury and mirror malfunction, be careful not to get your hand caught by the moving mirror.

■ **When the mirror defoggers are operating (vehicles with mirror defoggers)**

Do not touch the rear view mirror surfaces, as they can become very hot and burn you.



# 1-4. Opening and closing the windows and moon roof

## Power windows

The power windows can be opened and closed using the switches.

Operating the switch moves the windows as follows:

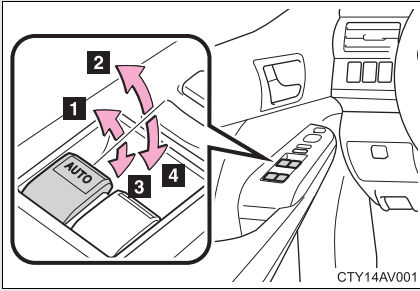

- 1** Closing
- 2** One-touch closing (driver's window only)\*
- 3** Opening
- 4** One-touch opening (driver's window only)\*

\*: Pressing the switch in the opposite direction will stop window travel partway.

### Window lock switch

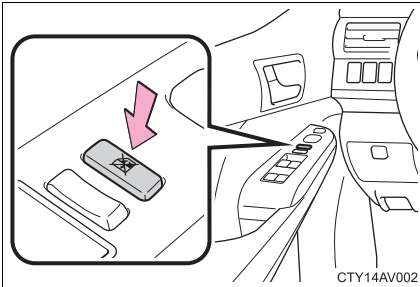

Press the switch down to lock the passenger window switches.

Use this switch to prevent children from accidentally opening or closing a passenger window.

■ **The power windows can be operated when**

**Vehicles without a smart key system**

The engine switch is in the “ON” position.

**Vehicles with a smart key system**

The “ENGINE START STOP” switch is in IGNITION ON mode.

■ **Operating the power windows after turning the engine off**

**Vehicles without a smart key system**

The power windows can be operated for approximately 45 seconds even after the engine switch is turned to the “ACC” or “LOCK” position. They cannot, however, be operated once either front door is opened.

**Vehicles with a smart key system**

The power windows can be operated for approximately 45 seconds even after the “ENGINE START STOP” switch is turned to ACCESSORY mode or turned off. They cannot, however, be operated once either front door is opened.

■ **Jam protection function (driver’s window only)**

If an object becomes caught between the window and the window frame, window travel is stopped and the window is opened slightly.

■ **When the power window does not close normally (driver’s window only)**

If the jam protection function is operating abnormally and a window cannot be closed, perform the following operations using the power window switch on the driver’s door.

- Vehicles without a smart key system: After stopping the vehicle, the window can be closed by holding the power window switch in the one-touch closing position while the engine switch is turned to the “ON” position.
- Vehicles with a smart key system: After stopping the vehicle, the window can be closed by holding the power window switch in the one-touch closing position while the “ENGINE START STOP” switch is turned to IGNITION ON mode.
- If the window still cannot be closed even by carrying out the operation explained above, initialize the function by performing the following procedure.

**STEP 1** Hold the power window switch in the one-touch closing position. Continue holding the switch for a further 6 seconds after the window has closed.

**STEP 2** Hold the power window switch in the one-touch opening position. Continue holding the switch for a further 2 seconds after the window has opened completely.

**STEP 3** Hold the power window switch in the one-touch closing position once again. Continue holding the switch for a further 2 seconds after the window has closed.

If you release the switch while the window is moving, start again from the beginning.

If the window continues to close but then re-open slightly even after performing the above procedure correctly, have the vehicle inspected by your Toyota dealer.

#### ■ Customization that can be configured at Toyota dealer

Settings (e.g. key linked operation) can be changed.  
(Customizable features: →P. 493)

### CAUTION

#### ■ Closing the windows

Observe the following precautions.  
Failure to do so may result in death or serious injury.

- Check to make sure that all passengers do not have any part of their body in a position where it could be caught when a window is being operated.
- Do not allow children to operate the power windows.  
Closing a power window on someone can cause serious injury, and in some instances, even death.

#### ■ Jam protection function (driver's window only)

- Never use any part of your body to intentionally activate the jam protection function.
- The jam protection function may not work if something gets caught just before the window fully closes.

## 1-4. Opening and closing the windows and moon roof Moon roof\*

Use the overhead switches to open and close the moon roof and tilt it up and down.

### ■ Opening and closing

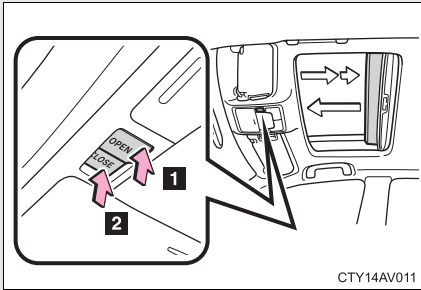

#### 1 Opens the moon roof\*

The moon roof stops slightly before the fully open position to reduce wind noise.

Press the switch again to fully open the moon roof.

#### 2 Closes the moon roof\*

\*: Lightly press the switch in either direction to stop the moon roof partway.

### ■ Tilt up and down

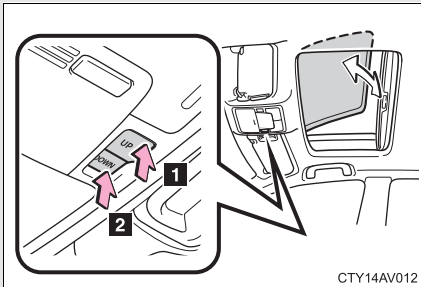

#### 1 Tilts the moon roof up\*

#### 2 Tilts the moon roof down\*

\*: Lightly press either of the moon roof switches to stop the moon roof partway.

\*: If equipped

---

■ **The moon roof can be operated when**

**Vehicles without a smart key system**

The engine switch is in the “ON” position.

**Vehicles with a smart key system**

The “ENGINE START STOP” switch is in IGNITION ON mode.

■ **Operating the moon roof after turning the engine off**

**Vehicles without a smart key system**

The moon roof can be operated for approximately 45 seconds after the engine switch is turned to the “ACC” or “LOCK” position. It cannot, however, be operated once either front door is opened.

**Vehicles with a smart key system**

The moon roof can be operated for approximately 45 seconds after the “ENGINE START STOP” switch is turned to ACCESSORY mode or turned off. It cannot, however, be operated once either front door is opened.

■ **Jam protection function**

If an object is detected between the moon roof and the frame while the moon roof is closing or tilting down, travel is stopped and the moon roof opens slightly.

■ **Sunshade**

The sunshade can be opened and closed manually. However, the sunshade will open automatically when the moon roof is opened.

### ■ When the moon roof does not close normally

Perform the following procedure:

- If the moon roof closes but then re-opens slightly

**STEP 1** Stop the vehicle.

**STEP 2** Press and hold the “CLOSE” switch.\*<sup>1</sup>

The moon roof will close, reopen and pause for approximately 10 seconds.\*<sup>2</sup> Then it will close again, tilt up and pause for approximately 1 second. Finally, it will tilt down, open and close.

**STEP 3** Check to make sure that the moon roof is completely closed and then release the switch.

- If the moon roof tilts down but then tilts back up

**STEP 1** Stop the vehicle.

**STEP 2** Press and hold the “UP” switch\*<sup>1</sup> until the moon roof moves into the tilt up position and stops.

**STEP 3** Release the “UP” switch once and then press and hold the “UP” switch again.\*<sup>1</sup>

The moon roof will pause for approximately 10 seconds in the tilt up position.\*<sup>2</sup> Then it will adjust slightly and pause for approximately 1 second. Finally, it will tilt down, open and close.

**STEP 4** Check to make sure that the moon roof is completely closed and then release the switch.

\*<sup>1</sup>: If the switch is released at the incorrect time, the procedure will have to be performed again from the beginning.

\*<sup>2</sup>: If the switch is released after the above mentioned 10 second pause, automatic operation will be disabled. In that case, press and hold the open/close switch in the close position or press and hold the “UP” switch. The moon roof will tilt up and pause for approximately 1 second. Then it will tilt down, open and close. Check to make sure that the moon roof is completely closed and then release the switch.

If the moon roof does not fully close even after performing the above procedure correctly, have the vehicle inspected by your Toyota dealer.

## ■ Moon roof open reminder function

### Vehicles without a smart key system

An alarm will sound when the driver's door is opened with the moon roof not fully closed and the engine switch off.

### Vehicles with a smart key system

An alarm will sound when the driver's door is opened with the moon roof not fully closed and the "ENGINE START STOP" switch off.

## ■ Customization that can be configured at Toyota dealer

Settings (e.g. key linked operation) can be changed.  
(Customizable features: →P. 493)

## CAUTION

### ■ Opening the moon roof

Observe the following precautions.

Failure to do so may cause death or serious injury.

- Do not allow any passengers to put their hands or heads outside the vehicle while it is moving.
- Do not sit on top of the moon roof.

### ■ Closing the moon roof

Observe the following precautions.

Failure to do so may result in death or serious injury.

- Check to make sure that all passengers do not have any part of their bodies in a position where they could be caught when the moon roof is being operated.
- Do not allow children to operate the moon roof.  
Closing the moon roof on someone can cause death or serious injury.

### ■ Jam protection function

- Never use any part of your body to intentionally activate the jam protection function.
- The jam protection function may not work if something gets caught just before the moon roof fully closes.

## Opening the fuel tank cap

Perform the following steps to open the fuel tank cap:

### ■ Before refueling the vehicle

#### Vehicles without a smart key system

Turn the engine switch off and ensure that all the doors and windows are closed.

#### Vehicles with a smart key system

Turn the “ENGINE START STOP” switch off and ensure that all the doors and windows are closed.

### ■ Opening the fuel tank cap

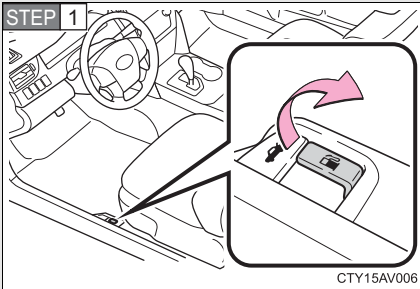

Pull up the opener to open the fuel filler door.

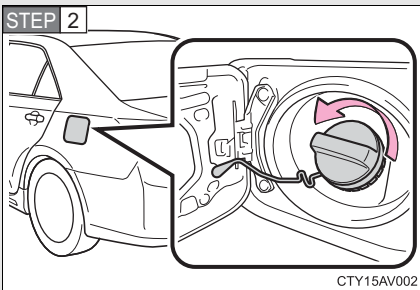

Turn the fuel tank cap slowly to open.



STEP 3

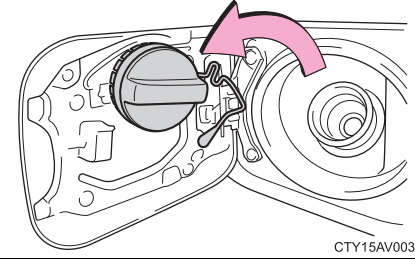

Hang the fuel tank cap on the back of the fuel filler door.

### Closing the fuel tank cap

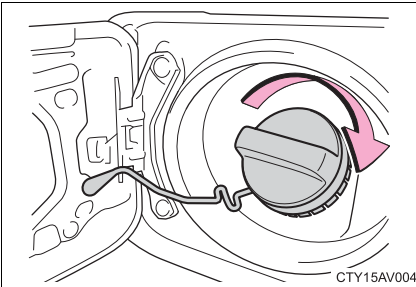

After refueling, turn the fuel tank cap until you hear a click. Once the cap is released, it will turn slightly in the opposite direction.

 **CAUTION**

■ **When refueling the vehicle**

Observe the following precautions while refueling the vehicle. Failure to do so may result in death or serious injury.

- After exiting the vehicle and before opening the fuel door, touch an unpainted metal surface to discharge any static electricity. It is important to discharge static electricity before refueling because sparks resulting from static electricity can cause fuel vapors to ignite while refueling.
- Always hold the grips on the fuel tank cap and turn it slowly to remove it. A whooshing sound may be heard when the fuel tank cap is loosened. Wait until the sound cannot be heard before fully removing the cap. In hot weather, pressurized fuel may spray out the filler neck and cause injury.
- Do not allow anyone that has not discharged static electricity from their body to come close to an open fuel tank.
- Do not inhale vaporized fuel.  
Fuel contains substances that are harmful if inhaled.
- Do not smoke while refueling the vehicle.  
Doing so may cause the fuel to ignite and cause a fire.
- Do not return to the vehicle or touch any person or object that is statically charged.  
This may cause static electricity to build up, resulting in a possible ignition hazard.

■ **When refueling**

Securely insert the fuel nozzle into the fuel filler neck. If fuel is added with the nozzle slightly lifted away from the fuel filler neck, the automatic shut off function may not operate, resulting in fuel overflowing from the tank.

■ **When replacing the fuel cap**

Do not use anything but a genuine Toyota fuel tank cap designed for your vehicle. Doing so may cause a fire or other incident which may result in death or serious injury.

 NOTICE**■ Refueling**

Do not spill fuel during refueling.

Doing so may damage the vehicle, such as causing the exhaust systems to operate abnormally or damaging fuel system components or the vehicle's painted surface.

## 1-6. Theft deterrent system Engine immobilizer system

The vehicle's keys have built-in transponder chips that prevent the engine from starting if a key has not been previously registered in the vehicle's on-board computer.

**Never leave the keys inside the vehicle when you leave the vehicle.**

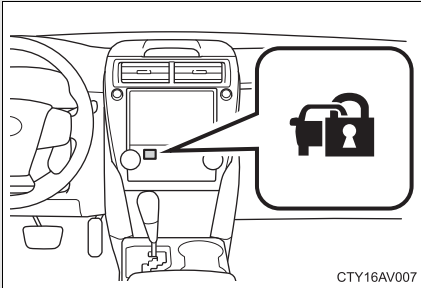

### **Vehicles without a smart key system**

The indicator light flashes after the key has been removed from the engine switch to indicate that the system is operating.

The indicator light stops flashing after the registered key has been inserted into the engine switch to indicate that the system has been canceled.

### **Vehicles with a smart key system**

The indicator light flashes after the "ENGINE START STOP" switch has been turned off to indicate that the system is operating.

The indicator light stops flashing after the "ENGINE START STOP" switch has been turned to ACCESSORY or IGNITION ON mode to indicate that the system has been canceled.

**■ System maintenance**

The vehicle has a maintenance-free type engine immobilizer system.

**■ Conditions that may cause the system to malfunction**

- If the grip portion of the key is in contact with a metallic object
- If the key is in close proximity to or touching a key to the security system (key with a built-in transponder chip) of another vehicle

**■ Certifications for the engine immobilizer system****U.S.A.**

Vehicles without a smart key system

FCC ID: WRKRI-34BTY

This device complies with Part 15 of the FCC Rules. Operation is subject to the following two conditions: (1) this device may not cause harmful interference, and (2) this device must accept any interference received, including interference that may cause undesired operation.

Vehicles with a smart key system

FCC ID: NI4TMIMB-3

This device complies with Part 15 of the FCC Rules. Operation is subject to the following two conditions: (1) this device may not cause harmful interference, and (2) this device must accept any interference received, including interference that may cause undesired operation.

**Canada**

Operation is subject to the following two conditions: (1) this device may not cause interference, and (2) this device must accept any interference, including interference that may cause undesired operation of the device.

**⚠ CAUTION****■ Certifications for the immobilizer system**

Changes or modifications not expressly approved by the party responsible for compliance could void the user's authority to operate the equipment.



**NOTICE**

■ **To ensure the system operates correctly**

Do not modify or remove the system. If modified or removed, the proper operation of the system cannot be guaranteed.

## Alarm\*

**The system sounds the alarm and flashes the lights when forced entry is detected.**

### ■ Triggering of the alarm

The alarm is triggered in the following situations when the alarm is set:

- A locked door or trunk is unlocked or opened in any way other than using the entry function, wireless remote control or mechanical key.
- The hood is opened.
- Some models: The window is tapped or broken.

### ■ Setting the alarm system

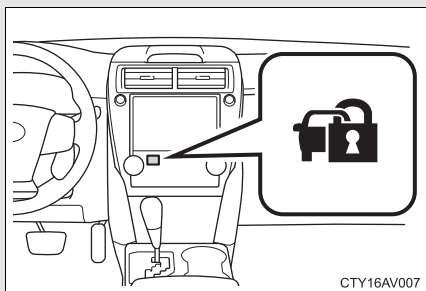

Close the doors, trunk and hood, and lock all the doors. The system will be set automatically after 30 seconds.

The indicator light changes from being on to flashing when the system is set.

### ■ Deactivating or stopping the alarm

Do one of the following to deactivate or stop the alarm.

- Unlock the doors or trunk.
- Vehicles without a smart key system: Turn the engine switch to the “ACC” or “ON” position, or start the engine. (The alarm will be deactivated or stopped after a few seconds.)
- Vehicles with a smart key system: Turn the “ENGINE START STOP” switch to ACCESSORY or IGNITION ON mode, or start the engine. (The alarm will be deactivated or stopped after a few seconds.)

---

### ■ System maintenance

The vehicle has a maintenance-free type alarm system.

### ■ Items to check before locking the vehicle

To prevent unexpected triggering of the alarm and vehicle theft, make sure of the following:

- Nobody is in the vehicle.
- The windows and moon roof are closed before the alarm is set.
- No valuables or other personal items are left in the vehicle.



### ■ Triggering of the alarm

The alarm may be triggered in the following situations.  
(Stopping the alarm deactivates the system.)

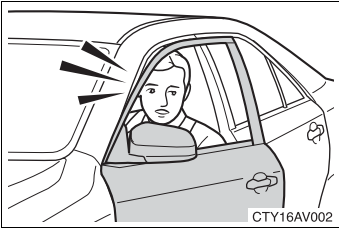

- A person inside the vehicle opens a door, the trunk or hood.

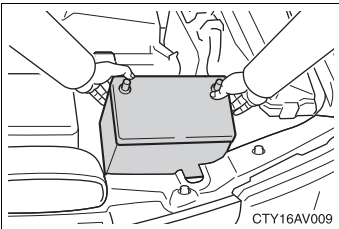

- The battery is recharged or replaced when the vehicle is locked.

### ■ Alarm-operated door lock

- When the alarm is operating, the doors are locked automatically to prevent intruders.
- Do not leave the key inside the vehicle when the alarm is operating, and make sure the key is not inside the vehicle when recharging or replacing the battery.

#### NOTICE

#### ■ To ensure the system operates correctly

Do not modify or remove the system. If modified or removed, the proper operation of the system cannot be guaranteed.

## Correct driving posture

Drive in a good posture as follows:

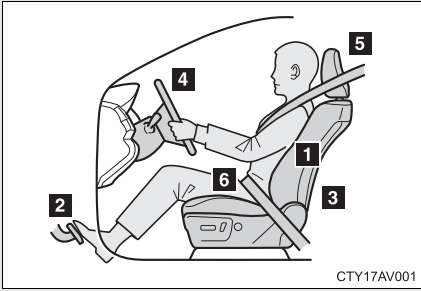

- 1** Sit upright and well back in the seat. (→P. 62)
- 2** Adjust the position of the seat forward or backward to ensure the pedals can be reached and easily depressed to the extent required. (→P. 62)
- 3** Adjust the seatback so that the controls are easily operable.
- 4** Adjust the tilt and telescopic positions of the steering wheel downward so the airbag is facing your chest. (→P. 76)
- 5** Lock the head restraint in place with the center of the head restraint closest to the top of your ears. (→P. 67)
- 6** Wear the seat belt correctly. (→P. 69)

 **CAUTION****■ While driving**

- Do not adjust the position of the driver's seat.  
Doing so could cause the driver to lose control of the vehicle.
- Do not place a cushion between the driver or passenger and the seatback.  
A cushion may prevent correct posture from being achieved, and reduce the effectiveness of the seat belt and head restraint, increasing the risk of death or serious injury to the driver or passenger.
- Do not place anything under the front seats.  
Objects placed under the front seats may become jammed in the seat tracks and stop the seat from locking in place. This may lead to an accident, resulting in death or serious injury. The adjustment mechanism may also be damaged.

**■ Adjusting the seat position**

- Take care when adjusting the seat position to ensure that other passengers are not injured by the moving seat.
- Do not put your hands under the seat or near the moving parts to avoid injury.  
Fingers or hands may become jammed in the seat mechanism.

## SRS airbags

The SRS airbags inflate when the vehicle is subjected to certain types of severe impacts that may cause significant injury to the occupants. They work together with the seat belts to help reduce the risk of death or serious injury.

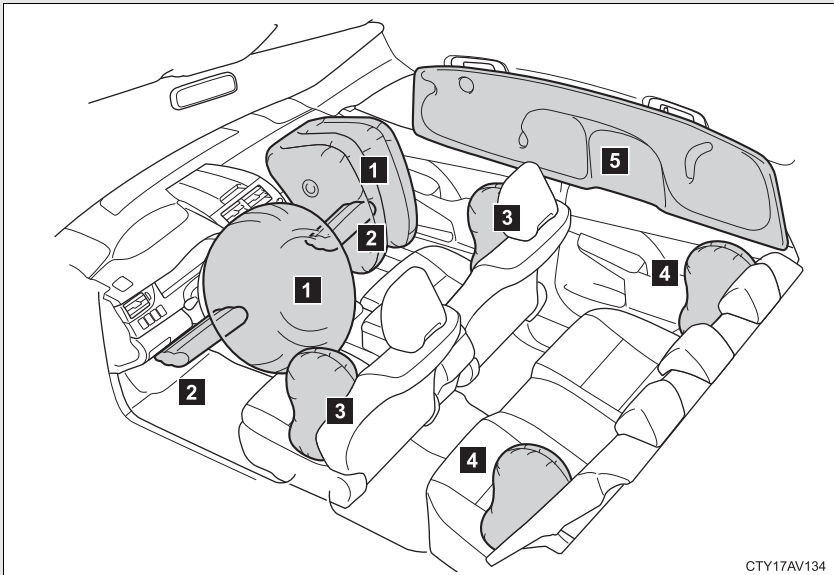

CTY17AV134

### SRS front airbags

- 1** SRS driver airbag/front passenger airbag  
Can help protect the head and chest of the driver and front passenger from impact with interior components
- 2** SRS knee airbags  
Can help provide driver and front passenger protection

### SRS side and curtain shield airbags

- 3** SRS front side airbags  
Can help protect the torso of the front seat occupants
- 4** SRS rear side airbags  
Can help protect the torso of occupants in the rear outer seats

**5 SRS curtain shield airbags**

Can help protect primarily the head of occupants in the outer seats

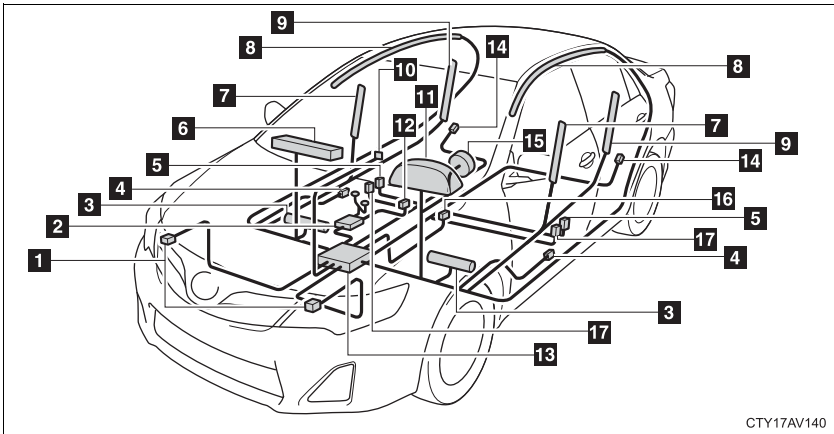
**SRS airbag system components****1** Front impact sensors**2** Front passenger occupant classification system (ECU and sensors)**3** Knee airbags**4** Side impact sensors (front door)**5** Side impact sensors (front)**6** Front passenger airbag**7** Front side airbags**8** Curtain shield airbags**9** Rear side airbags**10** "AIR BAG ON" and "AIR BAG OFF" indicator lights**11** SRS warning light**12** Front passenger's seat belt buckle switch**13** Airbag sensor assembly**14** Side impact sensors (rear)**15** Driver airbag**16** Driver's seat belt buckle switch**17** Seat belt pretensioners and force limiters

CTY17AV140

Your vehicle is equipped with ADVANCED AIRBAGS designed based on the US motor vehicle safety standards (FMVSS208). The airbag sensor assembly (ECU) controls airbag deployment based on information obtained from the sensors etc. shown in the system components diagram above. This information includes crash severity and occupant information. As the airbags deploy, a chemical reaction in the inflators quickly fills the airbags with nontoxic gas to help restrain the motion of the occupants.

### ■ If the SRS airbags deploy (inflate)

- Bruising and slight abrasions may result from contact with a deploying (inflating) SRS airbag.
- A loud noise and white powder will be emitted.
- Parts of the airbag module (steering wheel hub, airbag cover and inflator) as well as the seats, parts of the front and rear pillars, and roof side rails, may be hot for several minutes. The airbag itself may also be hot.
- The windshield may crack.
- For Safety Connect subscribers, if the SRS airbags deploy or in the event of a severe rear-end collision, the system is designed to send an emergency call to the response center, notifying them of the vehicle's location (without needing to push the "SOS" button) and an agent will attempt to speak with the occupants to ascertain the level of emergency and assistance required. If the occupants are unable to communicate, the agent automatically treats the call as an emergency and helps to dispatch the necessary emergency services. (→P. 326)

### ■ SRS airbag deployment conditions (SRS front airbags)

- The SRS front airbags will deploy in the event of an impact that exceeds the set threshold level (the level of force corresponding to an approximately 12 - 18 mph [20 - 30 km/h] frontal collision with a fixed wall that does not move or deform).

However, this threshold velocity will be considerably higher if the vehicle strikes an object, such as a parked vehicle and sign pole, which can move or deform on impact, or if the vehicle is involved in an underride collision (e.g. a collision in which the front of the vehicle "underrides", or goes under, the bed of a truck etc.).

- Depending on the type of collision, it is possible that only the seat belt pretensioners will activate.
- The SRS front airbags for the front passenger will not activate if there is no passenger sitting in the front passenger seat. However, the SRS front airbags for the front passenger may deploy if luggage is put in the seat, even if the seat is unoccupied. (→P. 113)

■ **SRS airbag deployment conditions (SRS side and curtain shield airbags)**

- The SRS side and curtain shield airbags will deploy in the event of an impact that exceeds the set threshold level (the level of force corresponding to the impact force produced by an approximately 3300 lb. [1500 kg] vehicle colliding with the vehicle cabin from a direction perpendicular to the vehicle orientation at an approximate speed of 12 - 18 mph [20 - 30 km/h]).
- The SRS curtain shield airbags may also deploy in the event of a severe frontal collision.

■ **Conditions under which the SRS airbags may deploy (inflate), other than a collision**

The SRS front airbags and SRS curtain shield airbags may also deploy if a serious impact occurs to the underside of your vehicle. Some examples are shown in the illustration.

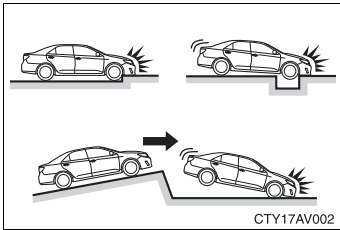

- Hitting a curb, edge of pavement or hard surface
- Falling into or jumping over a deep hole
- Landing hard or falling



### ■ Types of collisions that may not deploy the SRS airbags (SRS front airbags)

The SRS front airbags do not generally inflate if the vehicle is involved in a side or rear collision, if it rolls over, or if it is involved in a low-speed frontal collision. But, whenever a collision of any type causes sufficient forward deceleration of the vehicle, deployment of the SRS front airbags may occur.

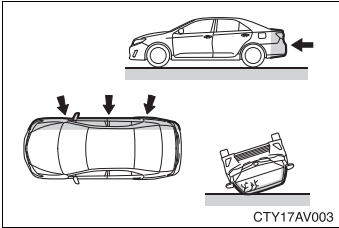

- Collision from the side
- Collision from the rear
- Vehicle rollover

### ■ Types of collisions that may not deploy the SRS airbags (SRS side and curtain shield airbags)

The SRS side and curtain shield airbags may not activate if the vehicle is subjected to a collision from the side at certain angles, or a collision to the side of the vehicle body other than the passenger compartment.

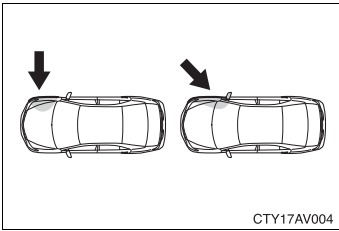

- Collision from the side to the vehicle body other than the passenger compartment
- Collision from the side at an angle

**SRS side airbags:** Do not generally inflate if the vehicle is involved in a frontal or rear collision, if it rolls over, or if it is involved in a low-speed side collision.

**SRS curtain shield airbags:** Do not generally inflate if the vehicle is involved in a rear collision, if it rolls over, or if it is involved in a low-speed side collision.

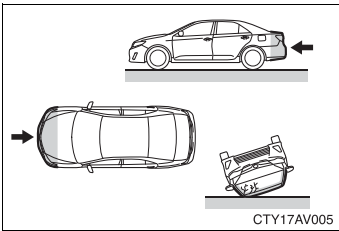

- Collision from the front\*
- Collision from the rear
- Vehicle rollover

\*: Depending on the conditions and type of accident, the curtain shield airbags may deploy (inflate) upon frontal impact.

## ■ When to contact your Toyota dealer

In the following cases, contact your Toyota dealer as soon as possible.

- Any of the SRS airbags have been inflated.

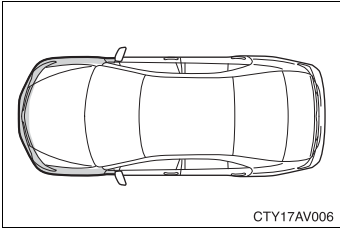

- The front of the vehicle is damaged or deformed, or was involved in an accident that was not severe enough to cause the SRS front airbags and SRS curtain shield airbags to inflate.

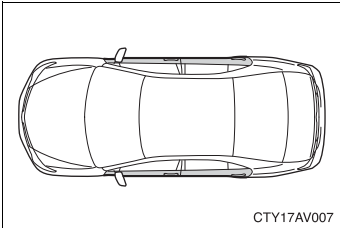

- A portion of a door is damaged or deformed, or the vehicle was involved in an accident that was not severe enough to cause the SRS side and curtain shield airbags to inflate.

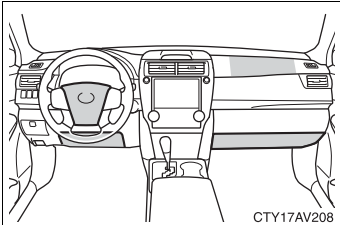

- The pad section of the steering wheel, dashboard near the front passenger airbag or lower portion of the instrument panel is scratched, cracked, or otherwise damaged.

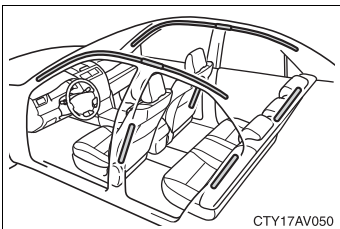

- The surface of the seats with the side airbag is scratched, cracked, or otherwise damaged.
- The portion of the front pillars, rear pillars or roof side rail garnishes (padding) containing the curtain shield airbags inside is scratched, cracked, or otherwise damaged.

 CAUTION

■ **SRS airbag precautions**

Observe the following precautions regarding the SRS airbags. Failure to do so may cause death or serious injury.

- The driver and all passengers in the vehicle must wear their seat belts properly.

The SRS airbags are supplemental devices to be used with the seat belts.

- The SRS driver airbag deploys with considerable force, and can cause death or serious injury especially if the driver is very close to the airbag. The National Highway Traffic Safety Administration (NHTSA) advises:

Since the risk zone for the driver's airbag is the first 2 - 3 in. (50 - 75 mm) of inflation, placing yourself 10 in. (250 mm) from your driver airbag provides you with a clear margin of safety. This distance is measured from the center of the steering wheel to your breastbone. If you sit less than 10 in. (250 mm) away now, you can change your driving position in several ways:

- Move your seat to the rear as far as you can while still reaching the pedals comfortably.
- Slightly recline the back of the seat.  
Although vehicle designs vary, many drivers can achieve the 10 in. (250 mm) distance, even with the driver seat all the way forward, simply by reclining the back of the seat somewhat. If reclining the back of your seat makes it hard to see the road, raise yourself by using a firm, non-slippery cushion, or raise the seat if your vehicle has that feature.
- If your steering wheel is adjustable, tilt it downward. This points the airbag toward your chest instead of your head and neck.

The seat should be adjusted as recommended by NHTSA above, while still maintaining control of the foot pedals, steering wheel, and your view of the instrument panel controls.

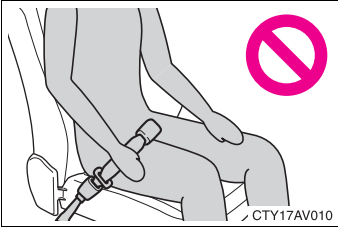
**! CAUTION****■ SRS airbag precautions**

- If the seat belt extender has been connected to the front seat belt buckles but the seat belt extender has not also been fastened to the latch plate of the seat belt, the SRS front airbags will judge that the driver and front passenger are wearing the seat belt even though the seat belt has not been connected. In this case, the SRS front airbags may not activate correctly in a collision, resulting in death or serious injury in the event of a collision. Be sure to wear the seat belt with the seat belt extender.

- The SRS front passenger airbag also deploys with considerable force, and can cause death or serious injury especially if the front passenger is very close to the airbag. The front passenger seat should be as far from the airbag as possible with the seatback adjusted, so the front passenger sits upright.
- Improperly seated and/or restrained infants and children can be killed or seriously injured by a deploying airbag. An infant or child who is too small to use a seat belt should be properly secured using a child restraint system. Toyota strongly recommends that all infants and children be placed in the rear seats of the vehicle and properly restrained. The rear seats are safer for infants and children than the front passenger seat. (→P. 118)

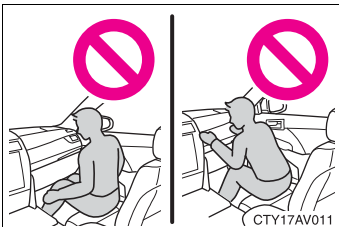

- Do not sit on the edge of the seat or lean against the dashboard.

**! CAUTION**

**■ SRS airbag precautions**

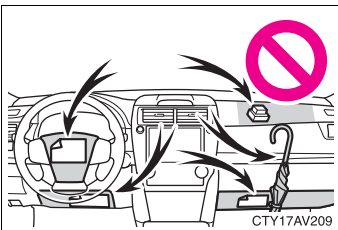
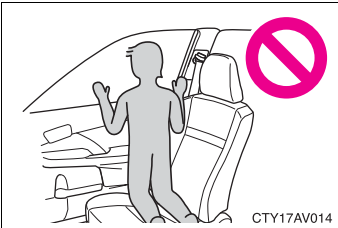
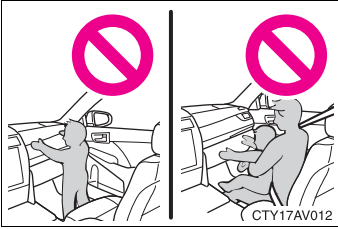

- Do not allow a child to stand in front of the SRS front passenger airbag unit or sit on the knees of a front passenger.
- Do not allow the front seat occupants to hold items on their knees.
- Do not lean against the door, the roof side rail or the front, side and rear pillars.
- Do not allow anyone to kneel on the passenger seats toward the door or put their head or hands outside the vehicle.
- Do not attach anything to or lean anything against areas such as the dashboard, steering wheel pad and lower portion of the instrument panel. These items can become projectiles when the SRS driver, front passenger and knee airbags deploy.

## ⚠ CAUTION

### ■ SRS airbag precautions

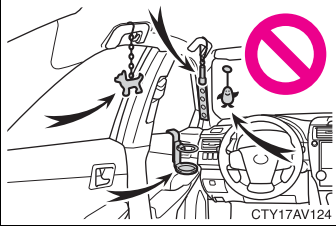

- Do not attach anything to areas such as a door, windshield glass, side door glass, front or rear pillar, roof side rail and assist grip.

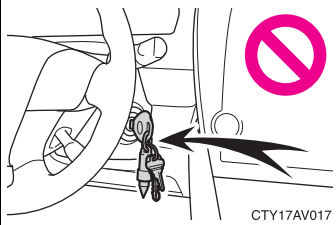

- Vehicles without a smart key system: Do not attach any heavy, sharp or hard objects such as keys and accessories to the key. The objects may restrict the SRS knee airbag inflation or be thrust into the driver's seat area by the force of the deploying airbag, thus causing a danger.

- Do not hang coat hangers or other hard objects on the coat hooks. All of these items could become projectiles and may cause death or serious injury, should the SRS curtain shield airbags deploy.
- If a vinyl cover is put on the area where the SRS knee airbag will deploy, be sure to remove it.
- Do not use seat accessories which cover the parts where the SRS side airbags inflate as they may interfere with inflation of the airbags. Such accessories may prevent the side airbags from activating correctly, disable the system or cause the side airbags to inflate accidentally, resulting in death or serious injury.
- Do not strike or apply significant levels of force to the area of the SRS airbag components.  
Doing so can cause the SRS airbags to malfunction.
- Do not touch any of the component parts immediately after the SRS airbags have deployed (inflated) as they may be hot.

 CAUTION

■ **SRS airbag precautions**

- If breathing becomes difficult after the SRS airbags have deployed, open a door or window to allow fresh air in, or leave the vehicle if it is safe to do so. Wash off any residue as soon as possible to prevent skin irritation.
- If the areas where the SRS airbags are stored, such as the steering wheel pad and front and rear pillar garnishes, are damaged or cracked, have them replaced by your Toyota dealer.

■ **Modification and disposal of SRS airbag system components**

Do not dispose of your vehicle or perform any of the following modifications without consulting your Toyota dealer. The SRS airbags may malfunction or deploy (inflate) accidentally, causing death or serious injury.

- Installation, removal, disassembly and repair of the SRS airbags
- Repairs, modifications, removal or replacement of the steering wheel, instrument panel, dashboard, seats or seat upholstery, front, side and rear pillars or roof side rails
- Repairs or modifications of the front fender, front bumper, or side of the occupant compartment
- Installation of snow plows, winches, etc. to the front grille (bull bars or kangaroo bar etc.)
- Modifications to the vehicle's suspension system
- Installation of electronic devices such as mobile two-way radios and CD players
- Modifications to your vehicle for a person with a physical disability



# Front passenger occupant classification system

Your vehicle is equipped with a front passenger occupant classification system. This system detects the conditions of the front passenger seat and activates or deactivates the devices for the front passenger.

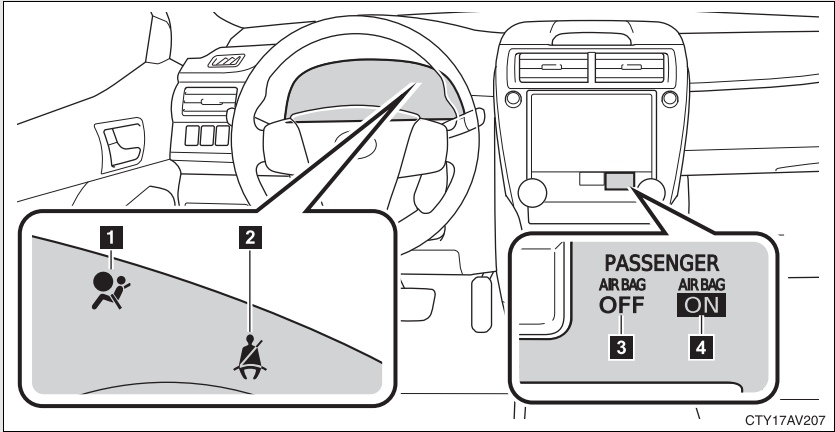

- 1** SRS warning light
- 2** Seat belt reminder light
- 3** "AIR BAG OFF" indicator light
- 4** "AIR BAG ON" indicator light

**Condition and operation in the front passenger occupant classification system**

■ **Adult\*1**

Indicator/ warning light	“AIR BAG ON” and “AIR BAG OFF” indicator lights	“AIR BAG ON”
	SRS warning light	Off
	Seat belt reminder light	Flashing*2
Devices	Front passenger airbag	Activated
	Side airbag on the front passenger seat	
	Curtain shield airbag in the front passenger side	
	Front passenger knee airbag	
	Front passenger’s seat belt pretensioner	

■ **Child\*3 or child restraint system\*4**

Indicator/ warning light	“AIR BAG ON” and “AIR BAG OFF” indicator lights	“AIR BAG OFF”*5
	SRS warning light	Off
	Seat belt reminder light	Flashing*2
Devices	Front passenger airbag	Deactivated
	Side airbag on the front passenger seat	Activated
	Curtain shield airbag in the front passenger side	
	Front passenger knee airbag	Deactivated
	Front passenger’s seat belt pretensioner	Activated

## ■ Unoccupied

Indicator/ warning light	“AIR BAG ON” and “AIR BAG OFF” indicator lights	“AIR BAG OFF”
	SRS warning light	Off
	Seat belt reminder light	
Devices	Front passenger airbag	Deactivated
	Side airbag on the front passenger seat	Activated
	Curtain shield airbag in the front passenger side	
	Front passenger knee airbag	Deactivated
	Front passenger’s seat belt pretensioner	Activated

## ■ There is a malfunction in the system

Indicator/ warning light	“AIR BAG ON” and “AIR BAG OFF” indicator lights	“AIR BAG OFF”
	SRS warning light	On
	Seat belt reminder light	
Devices	Front passenger airbag	Deactivated
	Side airbag on the front passenger seats	Activated
	Curtain shield airbag in the front passenger side	
	Front passenger knee airbag	Deactivated
	Front passenger’s seat belt pretensioner	Activated

\*1: The system judges a person of adult size as an adult. When a smaller adult sits in the front passenger seat, the system may recognize him/her as a child depending on his/her physique and posture.

\*2: In the event the front passenger does not wear a seat belt.

\*3: When a larger child who has outgrown a child restraint system sits in the front passenger seat, the system may recognize him/her as an adult depending on his/her physique or posture.

- \*4: Never install a rear-facing child restraint system on the front passenger seat. A forward-facing child restraint system should only be installed on the front passenger seat when it is unavoidable. (→P. 118)
- \*5: In case the indicator light is not illuminated, consult this manual on how to install the child restraint system properly. (→P. 122)



## CAUTION

### ■ Front passenger occupant classification system precautions

Observe the following precautions regarding the front passenger occupant classification system.

Failure to do so may cause death or serious injury.

- Wear the seat belt properly.
- Make sure the front passenger's seat belt plate has not been left inserted into the buckle before someone sits in the front passenger seat.
- Make sure the "AIR BAG OFF" indicator light is not illuminated when using the seat belt extender for the front passenger seat. If the "AIR BAG OFF" indicator light is illuminated, disconnect the extender tongue from the seat belt buckle, and reconnect the seat belt. Reconnect the seat belt extender after making sure the "AIR BAG ON" indicator light is illuminated. If you use the seat belt extender while the "AIR BAG OFF" indicator light is illuminated, the SRS airbags for the passenger may not activate correctly, which could cause death or serious injury in the event of a collision.
- Do not apply a heavy load to the front passenger seat or equipment.
- Do not put weight on the front passenger seat by putting your hands or feet on the front passenger seat seatback from the rear passenger seat.
- Do not let a rear passenger lift the front passenger seat with their feet or press on the seatback with their legs.
- Do not put objects under the front passenger seat.

 CAUTION**Front passenger occupant classification system precautions**

- Do not recline the front passenger seatback so far that it touches a rear seat. This may cause the “AIR BAG OFF” indicator light to be illuminated, which indicates that the passenger’s airbags will not deploy in the event of a severe accident. If the seatback touches the rear seat, return the seatback to a position where it does not touch the rear seat. Keep the front passenger seatback as upright as possible when the vehicle is moving. Reclining the seatback excessively may lessen the effectiveness of the seat belt system.
- If an adult sits in the front passenger seat, the “AIR BAG ON” indicator light is illuminated. If the “AIR BAG OFF” indicator is illuminated, ask the passenger to sit up straight, well back in the seat, feet on the floor, and with the seat belt worn correctly. If the “AIR BAG OFF” indicator still remains illuminated, either ask the passenger to move to the rear seat, or if that is not possible, move the front passenger seat fully rearward.
- When it is unavoidable to install a forward-facing child restraint system on the front passenger seat, install the child restraint system on the front passenger seat in the proper order. (→P. 122)
- Do not modify or remove the front seats.
- Do not kick the front passenger seat or subject it to severe impact. Otherwise, the SRS warning light may come on to indicate a malfunction of the detection system. In this case, contact your Toyota dealer immediately.
- Child restraint systems installed on the rear seat should not contact the front seatbacks.
- Do not use a seat accessory, such as a cushion and seat cover, that covers the seat cushion surface.
- Do not modify or replace the upholstery of the front seat.

## Child restraint systems

**A child restraint system for a small child or baby must itself be properly restrained on the seat with the lap portion of the lap/shoulder belt.**

**The laws of all 50 states of the U.S.A. and Canada now require the use of child restraint systems.**

### Points to remember

Studies have shown that installing a child restraint system on a rear seat is much safer than installing one on the front passenger seat.

- Choose a child restraint system that suits your vehicle and is appropriate to the age and size of the child.
- For installation details, follow the instructions provided with the child restraint system.

General installation instructions are provided in this manual.

(→P. 122)

## Types of child restraints

Child restraint systems are classified into the following 3 types according to the age and size of the child:

### Rear facing — Infant seat/convertible seat

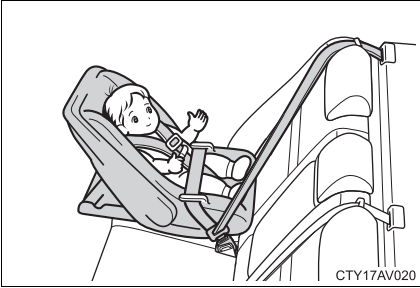

### Forward facing — Convertible seat

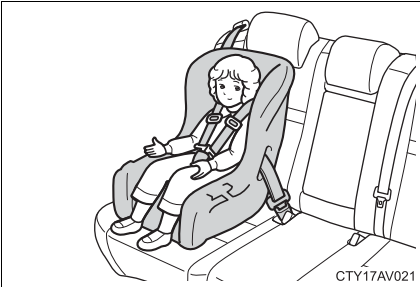

### Booster seat

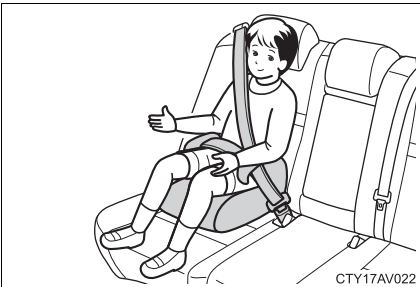

### ■ Selecting an appropriate child restraint system

- Use a child restraint system appropriate for the child until the child becomes large enough to properly wear the vehicle's seat belt.
- If the child is too large for a child restraint system, sit the child on a rear seat and use the vehicle's seat belt. (→P. 69)

### CAUTION

#### ■ Child restraint precautions

- For effective protection in automobile accidents and sudden stops, a child must be properly restrained, using a seat belt or child restraint system depending on the age and size of the child. Holding a child in your arms is not a substitute for a child restraint system. In an accident, the child can be crushed against the windshield, or between you and the vehicle's interior.
- Toyota strongly urges the use of a proper child restraint system that conforms to the size of the child, installed on the rear seat. According to accident statistics, the child is safer when properly restrained in the rear seat than in the front seat.
- Never install a rear-facing child restraint system on the front passenger seat even if the "AIR BAG OFF" indicator light is illuminated. In the event of an accident, the force of the rapid inflation of the front passenger airbag can cause death or serious injury to the child if the rear-facing child restraint system is installed on the front passenger seat.
- A forward-facing child restraint system may be installed on the front passenger seat only when it is unavoidable. A child restraint system that requires a top tether strap should not be used in the front passenger seat since there is no top tether strap anchor for the front passenger seat. Adjust the seatback as upright as possible and always move the seat as far back as possible even if the "AIR BAG OFF" indicator light is illuminated, because the front passenger airbag could inflate with considerable speed and force. Otherwise, the child may be killed or seriously injured.



 **CAUTION****■ Child restraint precautions**

- Do not use the seat belt extender when installing a child restraint system on the front or rear passenger seat. If installing a child restraint system with the seat belt extender connected to the seat belt, the seat belt will not securely hold the child restraint system, which could cause death or serious injury to the child or other passengers in the event of a sudden stop, sudden swerve or accident.
- Do not allow the child to lean his/her head or any part of his/her body against the door or the area of the seat, front and rear pillars or roof side rails from which the SRS side airbags or SRS curtain shield airbags deploy even if the child is seated in the child restraint system. It is dangerous if the SRS side airbags and curtain shield airbags inflate, and the impact could cause death or serious injury to the child.
- Make sure you have complied with all installation instructions provided by the child restraint manufacturer and that the system is properly secured. If it is not secured properly, it may cause death or serious injury to the child in the event of a sudden stop, sudden swerve or an accident.

**■ When children are in the vehicle**

Do not allow children to play with the seat belt. If the seat belt becomes twisted around a child's neck, it may lead to choking or other serious injuries that could result in death.

If this occurs and the buckle cannot be unfastened, scissors should be used to cut the belt.

**■ When the child restraint system is not in use**

- Keep the child restraint system properly secured on the seat even if it is not in use.  
Do not store the child restraint system unsecured in the passenger compartment.
- If it is necessary to detach the child restraint system, remove it from the vehicle or store it securely in the trunk. This will prevent it from injuring passengers in the event of a sudden stop, sudden swerve or accident.

## Installing child restraints

**Follow the child restraint system manufacturer's instructions. Firmly secure child restraints to the seats using the LATCH anchors or a seat belt. Attach the top tether strap when installing a child restraint.**

**The lap/shoulder belt can be used if your child restraint system is not compatible with the LATCH (Lower Anchors and Tethers for Children) system.**

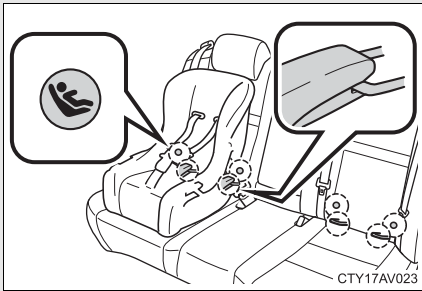

Child restraint LATCH anchors

LATCH anchors are provided for the outer rear seats. (Buttons displaying the location of the anchors are attached to the seats.)



Seat belts equipped with a child restraint locking mechanism (ALR/ELR belts except driver's seat belt) (→P. 69)

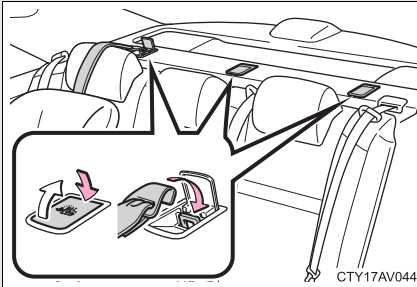

Anchor brackets (for top tether strap)

An anchor bracket is provided for each rear seat.

## Installation with LATCH system

### Type A

**STEP 1** Widen the gap between the seat cushion and seatback slightly.

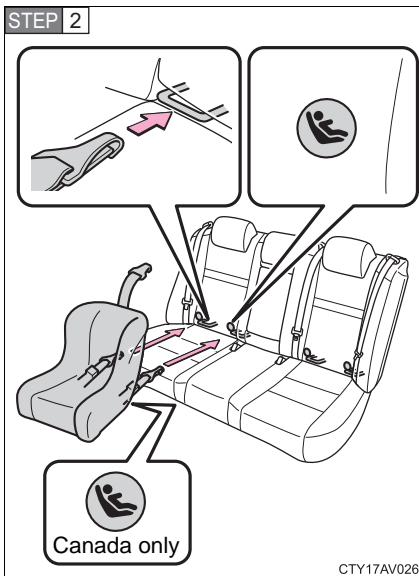

Latch the hooks of the lower straps onto the LATCH anchors. If the child restraint has a top tether strap, the top tether strap should be latched onto the top tether strap anchor.

For owners in Canada:  
The symbol on a child restraint system indicates the presence of a lower connector system.

## Type B

**STEP 1** Widen the gap between the seat cushion and seatback slightly.

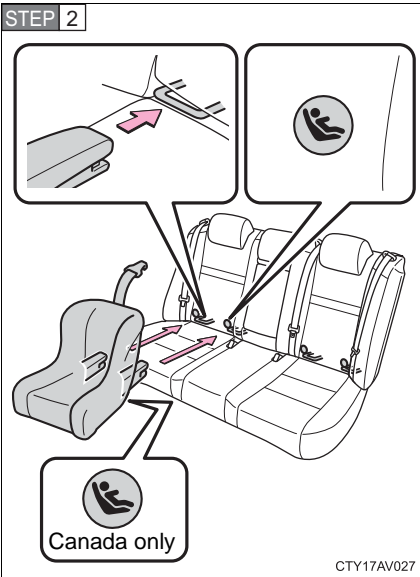

Latch the buckles onto the LATCH anchors. If the child restraint has a top tether strap, the top tether strap should be latched onto the top tether strap anchor.

For owners in Canada:  
The symbol on a child restraint system indicates the presence of a lower connector system.

## Installing child restraints using a seat belt (child restraint lock function belt)

### ■ Rear facing — Infant seat/convertible seat

STEP 1

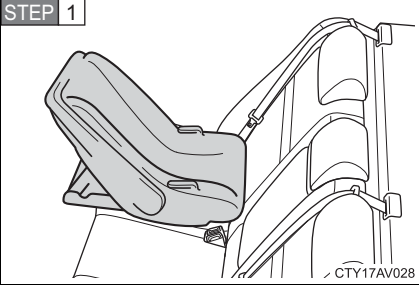

Place the child restraint system on the rear seat facing the rear of the vehicle.

STEP 2

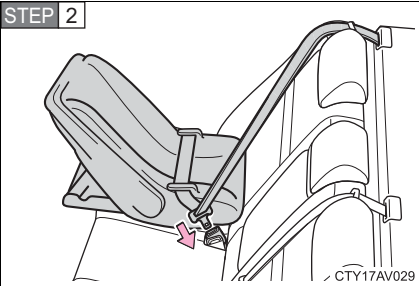

Run the seat belt through the child restraint system and insert the plate into the buckle. Make sure that the belt is not twisted.

STEP 3

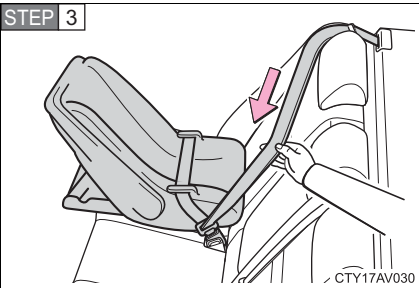

Fully extend the shoulder belt and allow it to retract to put it in lock mode. In lock mode, the belt cannot be extended.

1

Before driving

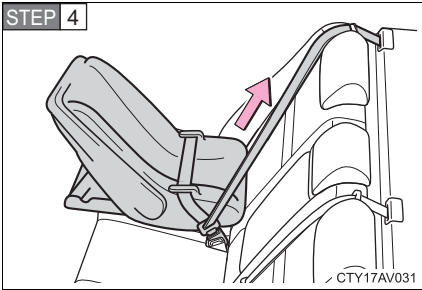

While pushing the child restraint system down into the rear seat, allow the shoulder belt to retract until the child restraint system is securely in place.

After the shoulder belt has retracted to a point where there is no slack in the belt, pull the belt to check that it cannot be extended.

### ■ Forward facing — Convertible seat

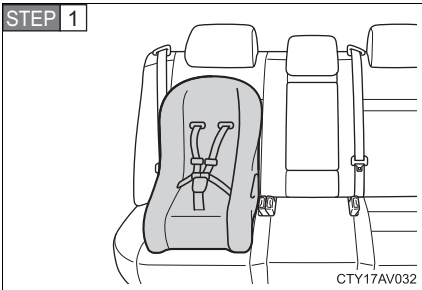

Place the child restraint system on the seat facing the front of the vehicle.

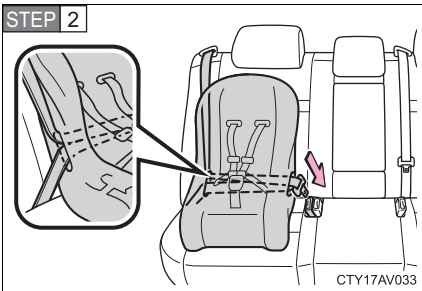

Run the seat belt through the child restraint system and insert the plate into the buckle. Make sure that the belt is not twisted.

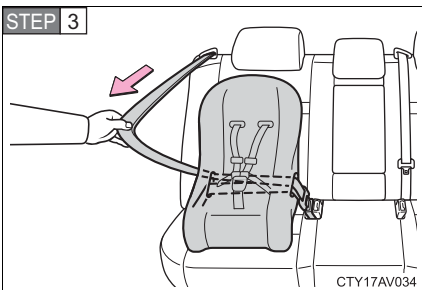

Fully extend the shoulder belt and allow it to retract to put it in lock mode. In lock mode, the belt cannot be extended.

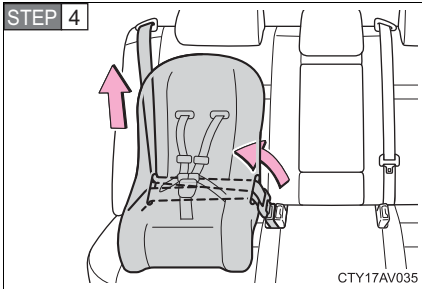

While pushing the child restraint system into the rear seat, allow the shoulder belt to retract until the child restraint system is securely in place.

After the shoulder belt has retracted to a point where there is no slack in the belt, pull the belt to check that it cannot be extended.

**STEP 5** If the child restraint has a top tether strap, the top tether strap should be latched onto the top tether strap anchor. (→P. 128)

### ■ Booster seat

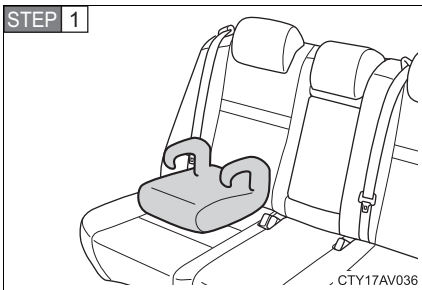

Place the child restraint system on the seat facing the front of the vehicle.

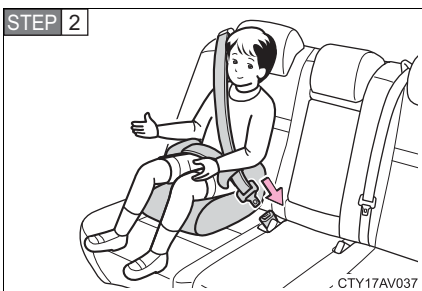

Sit the child in the child restraint system. Fit the seat belt to the child restraint system according to the manufacturer's instructions and insert the plate into the buckle. Make sure that the belt is not twisted.

Check that the shoulder belt is correctly positioned over the child's shoulder and that the lap belt is as low as possible. (→P. 69)

### Removing a child restraint installed with a seat belt

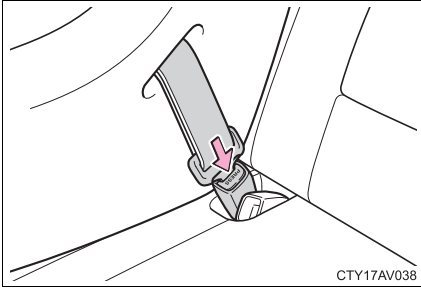

Push the buckle release button and fully retract the seat belt.

### Child restraint systems with a top tether strap

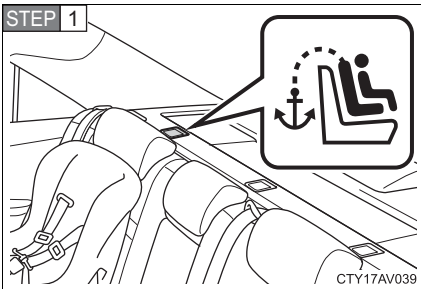

Secure the child restraint using the seat belt or LATCH anchors.

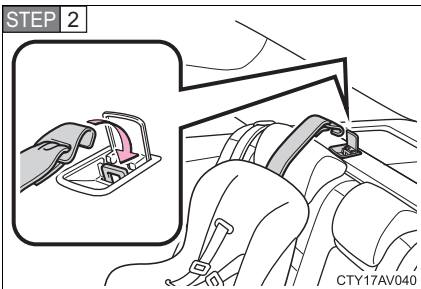

Open the anchor bracket cover, latch the hook onto the anchor bracket and tighten the top tether strap.

Make sure the top tether strap is securely latched.



---

**■ Laws and regulations pertaining to anchorages**

The LATCH system conforms to FMVSS225 or CMVSS210.2.

Child restraint systems conforming to FMVSS213 or CMVSS213 specifications can be used.

This vehicle is designed to conform to SAE J1819.

** CAUTION****■ When installing a booster seat**

To prevent the belt from going into ALR lock mode, do not fully extend the shoulder belt. ALR mode causes the belt to tighten only. This could cause injury or discomfort to the child. (→P. 71)

**! CAUTION**

**■ When installing a child restraint system**

Follow the directions given in the child restraint system installation manual and fix the child restraint system securely in place.

If the child restraint system is not correctly fixed in place, the child or other passengers may be seriously injured or even killed in the event of sudden braking, sudden swerving or an accident.

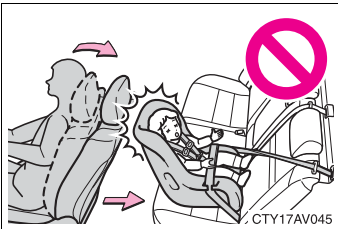

- If the driver's seat interferes with the child restraint system and prevents it from being attached correctly, attach the child restraint system to the right-hand rear seat.

- Adjust the front passenger seat so that it does not interfere with the child restraint system.

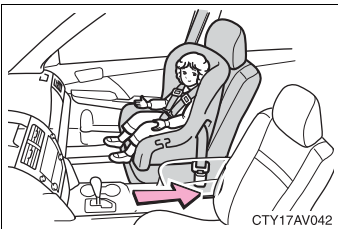

- Only put a forward-facing child restraint system on the front seat when unavoidable. When installing a forward-facing child restraint system on the front passenger seat, move the seat as far back as possible even if the "AIR BAG OFF" indicator light is illuminated. Failure to do so may result in death or serious injury if the airbags deploy (inflate).

 **CAUTION****■ When installing a child restraint system**

- When a booster seat is installed, always ensure that the shoulder belt is positioned across the center of the child's shoulder. The belt should be kept away from the child's neck, but not so that it could fall off the child's shoulder. Failure to do so may result in death or serious injury in the event of sudden braking, sudden swerving or an accident.
- Ensure that the belt and plate are securely locked and the seat belt is not twisted.
- Push and pull the child restraint system from side to side and forward to be sure it is secure.
- After securing a child restraint system, never adjust the seat.
- Follow all installation instructions provided by the child restraint system manufacturer.

**■ Do not use a seat belt extender**

If a seat belt extender is used when installing a child restraint system, the seat belt will not securely hold the child restraint system, which could cause death or serious injury to the child or other passengers in the event of sudden braking, sudden swerving or an accident.

**■ To correctly attach a child restraint system to the anchors**

When using the LATCH anchors, be sure that there are no foreign objects around the anchors and that the seat belt is not caught behind the child restraint. Make sure the child restraint system is securely attached, or it may cause death or serious injury to the child or other passengers in the event of sudden braking, sudden swerve or an accident.



## 2-1. Driving procedures

Driving the vehicle.....	134
Engine (ignition) switch (vehicles without a smart key system).....	145
Engine (ignition) switch (vehicles with a smart key system).....	148
Automatic transmission (vehicles without paddle shift switches) ....	155
Automatic transmission (vehicles with paddle shift switches) .....	159
Turn signal lever .....	166
Parking brake.....	167
Horn .....	168

## 2-2. Instrument cluster

Gauges and meters .....	169
Indicators and warning lights .....	179

## 2-3. Operating the lights and wipers

Headlight switch.....	185
Fog light switch .....	192
Windshield wipers and washer .....	194

## 2-4. Using other driving systems

Cruise control .....	199
Driving assist systems ....	203
BSM (Blind Spot Monitor) .....	208

## 2-5. Driving information

Cargo and luggage .....	213
Vehicle load limits .....	217
Winter driving tips .....	218
Trailer towing .....	222
Dinghy towing .....	223

## 2-1. Driving procedures

# Driving the vehicle

The following procedures should be observed to ensure safe driving:

### ■ Starting the engine

→P. 145, 148

### ■ Driving

**STEP 1** With the brake pedal depressed, shift the shift lever to D.  
(→P. 155, 159)

**STEP 2** Release the parking brake. (→P. 167)

**STEP 3** Gradually release the brake pedal and gently depress the accelerator pedal to accelerate the vehicle.

### ■ Stopping

**STEP 1** With the shift lever in D, depress the brake pedal.

**STEP 2** If necessary, set the parking brake.

If the vehicle is to be stopped for an extended period of time, shift the shift lever to P or N. (→P. 155, 159)

### ■ Parking the vehicle

**STEP 1** With the shift lever in D, depress the brake pedal.

**STEP 2** Set the parking brake. (→P. 167)

**STEP 3** Shift the shift lever to P. (→P. 155, 159)

If parking on a hill, block the wheels as needed.

**STEP 4** Vehicles without a smart key system:

Turn the engine switch to the “LOCK” position to stop the engine.

Vehicles with a smart key system:

Press the “ENGINE START STOP” switch to stop the engine.

**STEP 5** Lock the door, making sure that you have the key on your person.

## Starting off on a steep uphill

- STEP 1** Make sure that the parking brake is set and shift the shift lever to D.
- STEP 2** Gently depress the accelerator pedal.
- STEP 3** Release the parking brake.

### ■ Driving in the rain

- Drive carefully when it is raining, because visibility will be reduced, the windows may become fogged-up, and the road will be slippery.
- Drive carefully when it starts to rain, because the road surface will be especially slippery.
- Refrain from high speeds when driving on an expressway in the rain, because there may be a layer of water between the tires and the road surface, preventing the steering and brakes from operating properly.

### ■ Engine speed while driving

In the following conditions, the engine speed may become high while driving. This is due to automatic up-shifting control or down-shifting implementation to meet driving conditions. It does not indicate sudden acceleration.

- The vehicle is judged to be driving uphill or downhill
- When the accelerator pedal is released

### ■ Breaking in your new Toyota

To extend the life of the vehicle, observing the following precautions is recommended:

- For the first 200 miles (300 km):  
Avoid sudden stops.
- For the first 1000 miles (1600 km):
  - Do not drive at extremely high speeds.
  - Avoid sudden acceleration.
  - Do not drive continuously in low gears.
  - Do not drive at a constant speed for extended periods.

### ■ Drum-in-disc type parking brake system

Your vehicle has a drum-in-disc type parking brake system. This type of brake system needs bedding-down of the brake shoes periodically or whenever the parking brake shoes and/or drum are replaced. Have your Toyota dealer perform the bedding down operation.

### ■ Operating your vehicle in a foreign country

Comply with the relevant vehicle registration laws and confirm the availability of the correct fuel. (→P. 468)

### ■ Eco-friendly driving

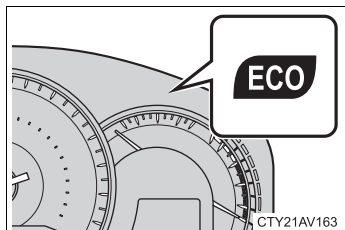

During Eco-friendly acceleration (Eco driving), Eco Driving Indicator Light will turn on. If the acceleration exceeds the Zone of Eco driving, and when the vehicle is stopped, the light turns off.

Eco Driving Indicator Light will not operate in the following conditions:

- The shift lever is anything other than D.
- The paddle shift switch is used. (If equipped)
- The vehicle speed is approximately 80 mph (130 km/h) or higher.

Eco Driving Indicator Light can be activated or deactivated. (→P. 176)



 CAUTION**■ When starting the vehicle**

Always keep your foot on the brake pedal while stopped with the engine running. This prevents the vehicle from creeping.

**■ When driving the vehicle**

- Do not drive if you are unfamiliar with the location of the brake and accelerator pedals to avoid depressing the wrong pedal.
  - Accidentally depressing the accelerator pedal instead of the brake pedal will result in sudden acceleration that may lead to an accident that could result in death or serious injury.
  - When backing up, you may twist your body around, leading to a difficulty in operating the pedals. Make sure to operate the pedals properly.
  - Make sure to keep a correct driving posture even when moving the vehicle only slightly. This allows you to depress the brake and accelerator pedals properly.
  - Depress the brake pedal using your right foot. Depressing the brake pedal using your left foot may delay response in an emergency, resulting in an accident.
- Do not drive the vehicle over or stop the vehicle near flammable materials. The exhaust system and exhaust gases can be extremely hot. These hot parts may cause a fire if there is any flammable material nearby.
- Do not let the vehicle roll backward while the shift lever is in a driving position, or roll forward while the shift lever is in R. Doing so may cause the engine to stall or lead to poor brake and steering performance, resulting in an accident or damage to the vehicle.
- If the smell of exhaust is noticed inside the vehicle, open the windows and check that the trunk is closed. Large amounts of exhaust in the vehicle can cause driver drowsiness and an accident, resulting in death or a serious health hazard. Have the vehicle inspected by your Toyota dealer immediately.
- Do not shift the shift lever to P while the vehicle is moving. Doing so can damage the transmission and may result in a loss of vehicle control.

 CAUTION

- Do not shift the shift lever to R while the vehicle is moving forward. Doing so can damage the transmission and may result in a loss of vehicle control.
- Do not shift the shift lever to D while the vehicle is moving backward. Doing so can damage the transmission and may result in a loss of vehicle control.
- Moving the shift lever to N while the vehicle is moving will disengage the engine from the transmission. Engine braking is not available when N is selected.
- During normal driving, do not turn off the engine. Turning the engine off while driving will not cause loss of steering or braking control, but the power assist to these systems will be lost. This will make it more difficult to steer and brake, so you should pull over and stop the vehicle as soon as it is safe to do so.  
However, in the event of an emergency, such as if it becomes impossible to stop the vehicle in the normal way: →P. 463
- Use engine braking (downshift) to maintain a safe speed when driving down a steep hill.  
Using the brakes continuously may cause the brakes to overheat and lose effectiveness. (→P. 156, 160)
- Do not adjust the position of the steering wheel, the seat, or the inside or outside rear view mirrors while driving.  
Doing so may result in a loss of vehicle control that can cause accidents, resulting in death or serious injury.
- Always check that all passengers' arms, heads or other parts of their body are not outside the vehicle, as this may result in death or serious injury.
- Do not drive in excess of the speed limit. Even if the legal speed limit permits it, do not drive over 85 mph (140 km/h) unless your vehicle has high-speed capability tires. Driving over 85 mph (140 km/h) may result in tire failure, loss of control and possible injury. Be sure to consult a tire dealer to determine whether the tires on your vehicle are high-speed capability tires or not before driving at such speeds.

 **CAUTION****■ When driving on slippery road surfaces**

- Sudden braking, acceleration and steering may cause tire slippage and reduce your ability to control the vehicle, resulting in an accident.
- Sudden acceleration, engine braking due to shift changing, or changes in engine speed could cause the vehicle to skid, resulting in an accident.
- After driving through a puddle, lightly depress the brake pedal to make sure that the brakes are functioning properly. Wet brake pads may prevent the brakes from functioning properly. If the brakes on only one side are wet and not functioning properly, steering control may be affected, resulting in an accident.

**■ When shifting the shift lever**

Be careful not to shift the shift lever with the accelerator pedal depressed. Shifting the shift lever to a gear other than P or N may lead to unexpected rapid acceleration of the vehicle that may cause an accident and result in death or serious injury.

**■ If you hear a squealing or scraping noise (brake pad wear limit indicators)**

Have the brake pads checked and replaced by your Toyota dealer as soon as possible.

Rotor damage may result if the pads are not replaced when needed.

It is dangerous to drive the vehicle when the wear limits of the brake pads and/or those of the brake discs are exceeded.

 CAUTION

■ **When the vehicle is stopped**

- Do not race the engine.

If the vehicle is in any gear other than P or N, the vehicle may accelerate suddenly and unexpectedly, causing an accident.

- Do not leave the vehicle with the engine running for a long time.

If such a situation cannot be avoided, park the vehicle in an open space and check that exhaust fumes do not enter the vehicle interior.

- In order to prevent accidents due to the vehicle rolling away, always keep depressing the brake pedal while the engine is running, and apply the parking brake as necessary.

- If the vehicle is stopped on an incline, in order to prevent accidents caused by the vehicle rolling forward or backward, always depress the brake pedal and securely apply the parking brake as needed.

- Avoid revving or racing the engine.

Running the engine at high speed while the vehicle is stopped may cause the exhaust system to overheat, which could result in a fire if combustible material is nearby.

 CAUTION**■ When the vehicle is parked**

- Do not leave glasses, cigarette lighters, spray cans, or soft drink cans in the vehicle when it is in the sun.

Doing so may result in the following:

- Gas may leak from a cigarette lighter or spray can, and may lead to a fire.
- The temperature inside the vehicle may cause the plastic lenses and plastic material of glasses to deform or crack.
- Soft drink cans may fracture, causing the contents to spray over the interior of the vehicle, and may also cause a short circuit in the vehicle's electrical components.
- Do not leave cigarette lighters in the vehicle. If a cigarette lighter is in a place such as the glove box or on the floor, it may be lit accidentally when luggage is loaded or the seat is adjusted, causing a fire.
- Do not attach adhesive discs to the windshield or windows. Do not place containers such as air fresheners on the instrument panel or dashboard. Adhesive discs or containers may act as lenses, causing a fire in the vehicle.
- Do not leave a door or window open if the curved glass is coated with a metallized film such as a silver-colored one. Reflected sunlight may cause the glass to act as a lens, causing a fire.
- Always apply the parking brake, shift the shift lever to P, stop the engine and lock the vehicle.  
Do not leave the vehicle unattended while the engine is running.
- Do not touch the exhaust pipe while the engine is running or immediately after turning the engine off.  
Doing so may cause burns.
- Do not leave the engine running in an area with snow build-up, or where it is snowing. If snowbanks build up around the vehicle while the engine is running, exhaust gases may collect and enter the vehicle. This may lead to death or a serious health hazard.

 **CAUTION**

■ **Exhaust gases**

Exhaust gases include harmful carbon monoxide (CO), which is colorless and odorless. Inhaling exhaust gases may lead to death or a serious health hazard.

- If the vehicle is in a poorly ventilated area, stop the engine. In a closed area, such as a garage, exhaust gases may collect and enter the vehicle. This may lead to death or a serious health hazard.
- The exhaust system should be checked occasionally. If there is a hole or crack caused by corrosion, damage to a joint or abnormal exhaust noise, be sure to have the vehicle inspected and repaired by your Toyota dealer. Failure to do so may allow exhaust gases to enter the vehicle, resulting in death or a serious health hazard.

■ **When taking a nap in the vehicle**

Always turn the engine off. Otherwise, if you accidentally move the shift lever or depress the accelerator pedal, this could cause an accident or fire due to engine overheating. Additionally, if the vehicle is parked in a poorly ventilated area, exhaust gases may collect and enter the vehicle, leading to death or a serious health hazard.

 **CAUTION****■ When braking**

- When the brakes are wet, drive more cautiously.  
Braking distance increases when the brakes are wet, and this may cause one side of the vehicle to brake differently than the other side. Also the parking brake may not securely hold the vehicle.
- If the power brake assist function does not operate, do not follow other vehicles closely and avoid hills or sharp turns that require braking.  
In this case, braking is still possible, but the brake pedal should be depressed more firmly than usual. Also, the braking distance will increase.
- Do not pump the brake pedal if the engine stalls.  
Each push on the brake pedal uses up the reserve for the power-assisted brakes.
- The brake system consists of 2 individual hydraulic systems; if one of the systems fails, the other will still operate. In this case, the brake pedal should be depressed more firmly than usual and the braking distance will increase.  
If this happens, do not continue to drive the vehicle. Have your brakes fixed immediately.

 **NOTICE****■ When driving the vehicle**

- Do not depress the accelerator and brake pedals at the same time during driving, as this may restrain driving torque.
- Do not use the accelerator pedal or depress the accelerator and brake pedals at the same time to hold the vehicle on a hill.

**■ When parking the vehicle**

Always shift the shift lever to P. Failure to do so may cause the vehicle to move or the vehicle may accelerate suddenly if the accelerator pedal is accidentally depressed.

 NOTICE

■ **Avoiding damage to vehicle parts**

- Do not turn the steering wheel fully in either direction and hold it there for an extended period of time.  
Doing so may damage the power steering motor.
- When driving over bumps in the road, drive as slowly as possible to avoid damaging the wheels, underside of the vehicle, etc.

■ **If you get a flat tire while driving**

A flat or damaged tire may cause the following situations. Hold the steering wheel firmly and gradually depress the brake pedal to slow down and stop the vehicle in a safe place.

- It may be difficult to control your vehicle.
- The vehicle will make abnormal sounds or vibrations.
- The vehicle will behave abnormally.

Information on what to do in case of a flat tire (→P. 435)

■ **When encountering flooded roads**

Do not drive on a road that has flooded after heavy rain etc. Doing so may cause the following serious damage to the vehicle:

- Engine stalling
- Short in electrical components
- Engine damage caused by water immersion

In the event that you drive on a flooded road and the vehicle is flooded, be sure to have your Toyota dealer check the following:

- Brake function
- Changes in quantity and quality of engine oil, and transaxle fluid etc.
- Lubricant condition for the bearings and suspension joints (where possible), and the function of all joints, bearings, etc.



### ■ Starting the engine

- STEP 1** Check that the parking brake is set.
- STEP 2** Check that the shift lever is set in P.
- STEP 3** Firmly depress the brake pedal.
- STEP 4** Turn the engine switch to the “START” position and start the engine.

### ■ Changing the engine switch positions

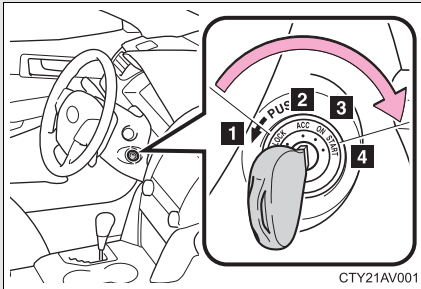

#### **1** “LOCK”

The steering wheel is locked and the key can be removed. (The key can be removed only when the shift lever is in “P”.)

#### **2** “ACC”

Some electrical components such as the audio system can be used.

#### **3** “ON”

All electrical components can be used.

#### **4** “START”

For starting the engine.

■ **Turning the key from “ACC” to “LOCK”**

**STEP 1** Shift the shift lever to P.

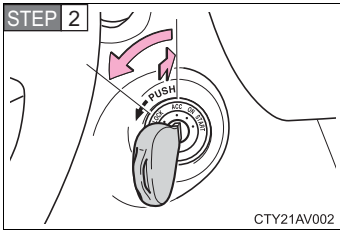

Push in the key and turn it to the “LOCK” position.

■ **If the engine does not start**

The engine immobilizer system may not have been deactivated. (→P. 92)

■ **When the steering lock cannot be released**

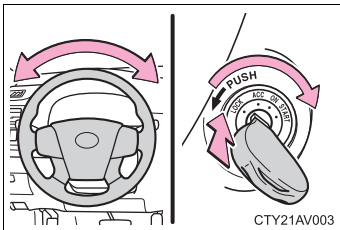

When starting the engine, the engine switch may seem stuck in the “LOCK” position. To free it, turn the key while turning the steering wheel slightly left and right.

■ **Key reminder function**

A buzzer sounds if the driver’s door is opened while the engine switch is in the “LOCK” or “ACC” position to remind you to remove the key.

 **CAUTION****■ When starting the engine**

Always start the engine while sitting in the driver's seat. Do not depress the accelerator pedal while starting the engine under any circumstances. Doing so may cause an accident resulting in death or serious injury.

**■ Caution when driving**

Do not turn the engine switch to the "LOCK" position while driving. If, in an emergency, you must turn the engine off while the vehicle is moving, turn the engine switch only to the "ACC" position to stop the engine. An accident may result if the engine is stopped while driving.

 **NOTICE****■ To prevent battery discharge**

Do not leave the engine switch in the "ACC" or "ON" position for long periods of time without the engine running.

**■ When starting the engine**

- Do not crank the engine for more than 30 seconds at a time. This may overheat the starter and wiring system.
- Do not race a cold engine.
- If the engine becomes difficult to start or stalls frequently, have the engine checked immediately.

**Performing the following operations when carrying the electronic key on your person starts the engine or changes “ENGINE START STOP” switch modes.**

■ **Starting the engine**

**STEP 1** Check that the parking brake is set.

**STEP 2** Check that the shift lever is set in P.

If the shift lever is not set in P, the engine may not be started.  
(→P. 155, 159)

**STEP 3** Firmly depress the brake pedal.

The smart key system indicator light (green) will turn on. If the indicator light does not turn on, the engine cannot be started.

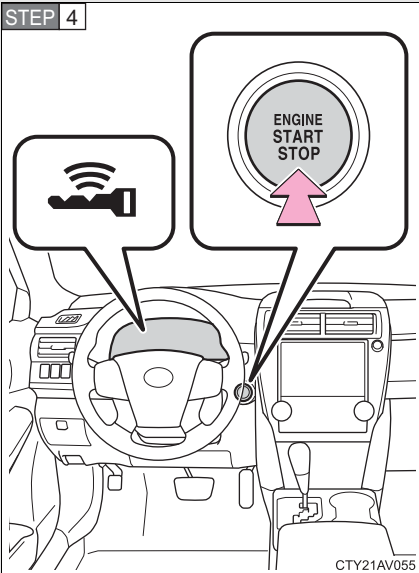

Press the “ENGINE START STOP” switch.

The engine will crank until it starts or for up to 30 seconds, whichever is less.

Continue depressing the brake pedal until the engine is completely started.

The engine can be started from any “ENGINE START STOP” switch mode.

### ■ Stopping the engine

**STEP 1** Stop the vehicle.

**STEP 2** Shift the shift lever to P.

**STEP 3** Set the parking brake. (→P. 167)

**STEP 4** Release the brake pedal.

**STEP 5** Press the “ENGINE START STOP” switch.

**STEP 6** Check that the smart key system indicator light (green) is off.

## ■ Changing “ENGINE START STOP” switch modes

Modes can be changed by pressing the “ENGINE START STOP” switch with brake pedal released. (The mode changes each time the switch is pressed.)

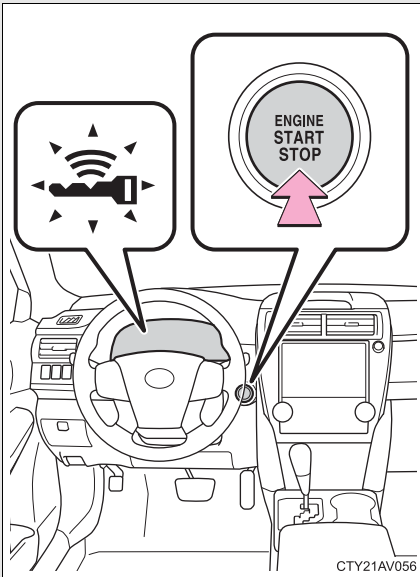

### Off\*

The emergency flashers can be used.

The smart key system indicator light (green) off.

### ACCESSORY mode

Some electrical components such as the audio system can be used.

The smart key system indicator light (green) flashes slowly.

### IGNITION ON mode

All electrical components can be used.

The smart key system indicator light (green) flashes slowly.

\*: If the shift lever is in a position other than P when turning off the engine, the “ENGINE START STOP” switch will be turned to ACCESSORY mode, not to off.

### When stopping the engine with the shift lever in a position other than P

If the engine is stopped with the shift lever in a position other than P, the “ENGINE START STOP” switch will not be turned off but instead be turned to ACCESSORY mode. Perform the following procedure to turn the switch off:

**STEP 1** Check that the parking brake is set.

**STEP 2** Shift the shift lever to P.

**STEP 3** Check that the smart key system indicator light (green) flashes slowly and then press the “ENGINE START STOP” switch once.

**STEP 4** Check that the smart key system indicator light (green) is off.

#### ■ Auto power off function

If the vehicle is left in ACCESSORY mode for more than 20 minutes or IGNITION ON mode (the engine is not running) for more than an hour with the shift lever in P, the “ENGINE START STOP” switch will automatically turn off. However, this function cannot entirely prevent battery discharge. Do not leave the vehicle with the “ENGINE START STOP” switch in ACCESSORY or IGNITION ON mode for long periods of time when the engine is not running.

#### ■ Electronic key battery depletion

→P. 44

#### ■ Conditions affecting operation

→P. 40

#### ■ Note for the entry function

→P. 41

### ■ If the engine does not start

- The engine immobilizer system may not have been deactivated. (→P. 92)

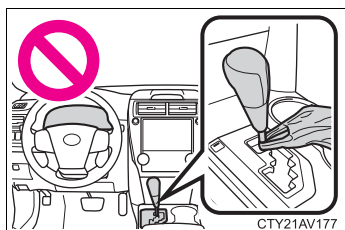

- Check that the shift lever is securely set in P. The engine may not start if the shift lever is displaced out of P.

### ■ Steering lock

After turning the “ENGINE START STOP” switch off and opening and closing the doors, the steering wheel will be locked due to the steering lock function. Operating the “ENGINE START STOP” switch again automatically cancels the steering lock.

### ■ When the steering lock cannot be released

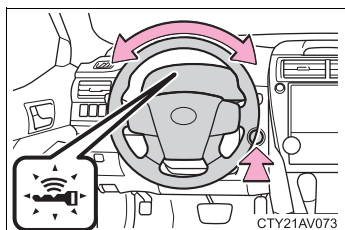

The smart key system indicator light (green) will flash quickly.

Check that the shift lever is set in P. Press the “ENGINE START STOP” switch while turning the steering wheel left and right.

### ■ Steering lock motor overheating prevention

To prevent the steering lock motor from overheating, the motor may be suspended if the engine is turned on and off repeatedly in a short period of time. In this case, refrain from operating the engine. After about 10 seconds, the steering lock motor will resume functioning.

### ■ When the smart key system indicator light flashes in yellow

The system may be malfunctioning. Have the vehicle inspected by your Toyota dealer immediately.

### ■ If the electronic key battery is depleted

→P. 384



### ■ Operation of the “ENGINE START STOP” switch

When operating the “ENGINE START STOP” switch, one short, firm press is enough. If the switch is pressed improperly, the engine may not start or the “ENGINE START STOP” switch mode may not change. It is not necessary to press and hold the switch.

### ■ If the smart key system has been deactivated in a customized setting

→P. 452

## CAUTION

### ■ When starting the engine

Always start the engine while sitting in the driver's seat. Do not depress the accelerator pedal while starting the engine under any circumstances. Doing so may cause an accident resulting in death or serious injury.

### ■ Caution while driving

If engine failure occurs while the vehicle is moving, do not lock or open the doors until the vehicle reaches a safe and complete stop. Activation of the steering lock in this circumstance may lead to an accident, resulting in death or serious injury.

### ■ Stopping the engine in an emergency

If you want to stop the engine in an emergency while driving the vehicle, press and hold the “ENGINE START STOP” switch for more than 2 seconds, or press it briefly 3 times or more in succession.

However, do not touch the “ENGINE START STOP” switch while driving except in an emergency. Turning the engine off while driving will not cause loss of steering or braking control, but the power assist to these systems will be lost. This will make it more difficult to steer and brake, so you should pull over and stop the vehicle as soon as it is safe to do so.

 NOTICE

■ **To prevent battery discharge**

- Do not leave the “ENGINE START STOP” switch in ACCESSORY or IGNITION ON mode for long periods of time without the engine running.
- If the smart key system indicator light (green) is illuminated, the “ENGINE START STOP” switch is not off. When exiting the vehicle, always check that the “ENGINE START STOP” switch is off.
- Do not stop the engine when the shift lever is in a position other than P. If the engine is stopped in another shift lever position, the “ENGINE START STOP” switch will not be turned off but instead be turned to ACCESSORY mode. If the vehicle is left in ACCESSORY mode, battery discharge may occur.

■ **When starting the engine**

- Do not race a cold engine.
- If the engine becomes difficult to start or stalls frequently, have the engine checked immediately.

■ **Symptoms indicating a malfunction with the “ENGINE START STOP” switch**

If the “ENGINE START STOP” seems to be operating somewhat differently than usual, such as the switch sticking slightly, there may be a malfunction. Contact your Toyota dealer immediately.

**Select a shift position appropriate for the driving conditions.**

■ **Shifting the shift lever**

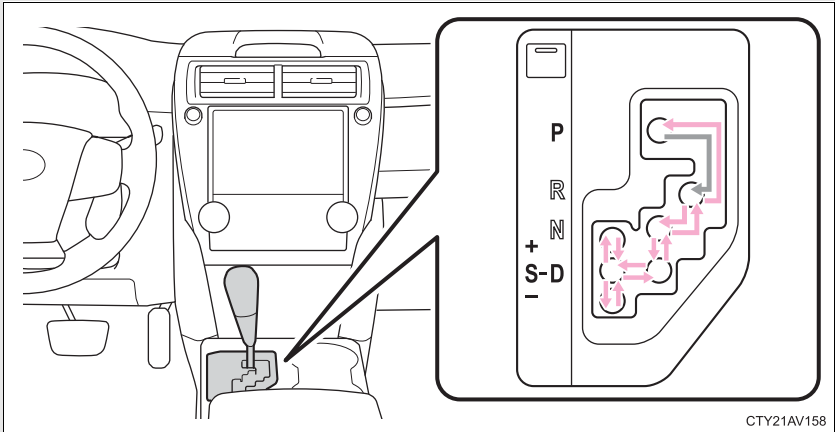

CTY21AV158



Vehicles without a smart key system:

While the engine switch is in the “ON” position, move the shift lever with the brake pedal depressed.

Vehicles with a smart key system:

While the “ENGINE START STOP” switch is in IGNITION ON mode, move the shift lever with the brake pedal depressed.

When shifting the shift lever between P and D, make sure that the vehicle is completely stopped.

## ■ Shift position purpose

Shift position	Function
P	Parking the vehicle/starting the engine
R	Reversing
N	Neutral
D	Normal driving <sup>*1</sup>
S	S mode driving <sup>*2</sup> (→P. 156)

\*1: To improve fuel efficiency and reduce noises, set the shift lever in the D position for normal driving.

\*2: Selecting shift ranges using S mode restricts the upper limit of the possible gear ranges, controls engine braking force, and prevents unnecessary upshifting.

## Changing shift ranges in S mode

When the shift lever is in the S position, the shift lever can be operated as follows:

### Type A

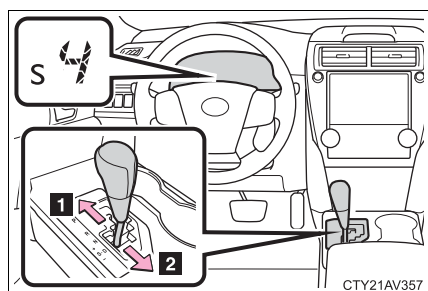

- 1** Upshifting
- 2** Downshifting

## Type B

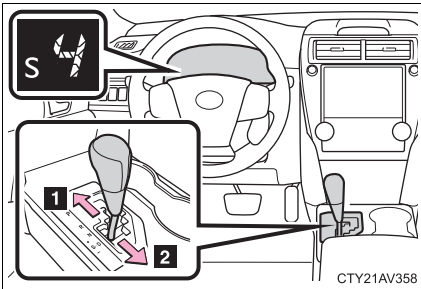

- 1 Upshifting
- 2 Downshifting

The initial shift range in S mode is set automatically to “5” or “4” according to vehicle speed. However, the initial shift range may be set to “3” if AI-SHIFT has operated while the shift lever was in the D position. (→P. 157)

### ■ Shift ranges and their functions

- You can choose from 6 levels of engine braking force.
- A lower shift range will provide greater engine braking force than a higher shift range, and the engine speed will also increase.

### ■ S mode

- When the shift range is “4” or lower, holding the shift lever toward “+” sets the shift range to “6”.
- To prevent the engine from over-revving, upshifting may automatically occur.
- To protect the automatic transmission, a function is adopted that automatically shifts to the top range when the temperature is too hot.

### ■ AI-SHIFT

AI-SHIFT automatically selects the suitable gear according to driver performance and driving conditions.

AI-SHIFT automatically operates when the shift lever is in the D position. (Shifting the shift lever to the S position cancels the function.)

■ **When driving with cruise control activated**

Even when performing the following actions with the intent of enabling engine braking, engine braking will not activate while driving in S mode and downshifting to 5 or 4 because cruise control will not be canceled. (→P. 199)

■ **If the shift lever cannot be shifted from P**

→P. 449

■ **If the “S” indicator does not come on or the “D” indicator is displayed even after shifting the shift lever to S**

This may indicate a malfunction in the automatic transmission system. Have the vehicle inspected by your Toyota dealer immediately.

(In this situation, the transmission will operate in the same manner as when the shift lever is in D.)

■ **Downshift restriction warning buzzer (S mode)**

To help ensure safety and driving performance, downshifting operation may sometimes be restricted. In some circumstances, downshifting may not be possible even when the shift lever is operated. (A buzzer will sound twice.)

 **CAUTION**

■ **When driving on slippery road surfaces**

Do not accelerate or shift gears suddenly.

Sudden changes in engine braking may cause the vehicle to spin or skid, resulting in an accident.

**Select a shift position appropriate for the driving conditions.**

■ **Shifting the shift lever**

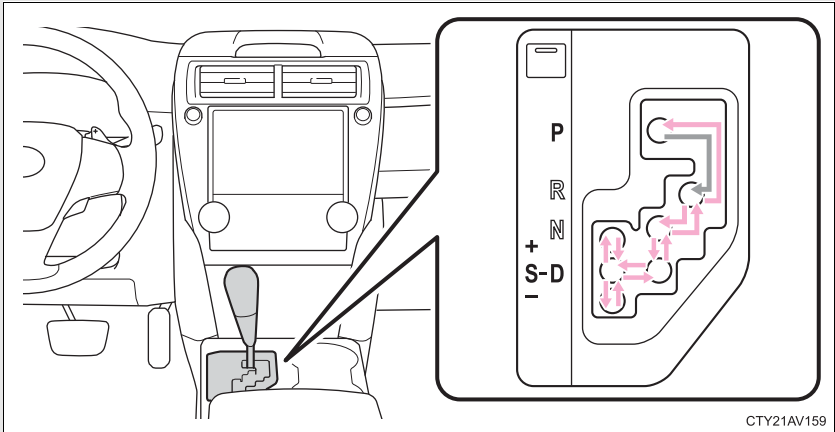

Vehicles without a smart key system:

While the engine switch is in the “ON” position, move the shift lever with the brake pedal depressed.

Vehicles with a smart key system:

While the “ENGINE START STOP” switch is in IGNITION ON mode, move the shift lever with the brake pedal depressed.

When shifting the shift lever between P and D, make sure that the vehicle is completely stopped.







### ■ Shift position purpose

Shift position	Function
P	Parking the vehicle/starting the engine
R	Reversing
N	Neutral
D	Normal driving <sup>*1</sup>
S	S mode driving <sup>*2</sup> (→P. 162)

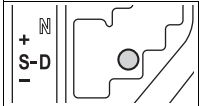
\*1: To improve fuel efficiency and reduce noises, set the shift lever in the D position for normal driving.

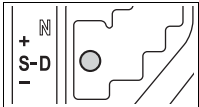
\*2: Selecting shift ranges using S mode restricts the upper limit of the possible gear ranges, controls engine braking force, and prevents unnecessary upshifting.

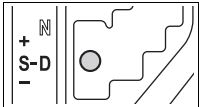

Shift position	Meter display	Function	Purpose
		<p>Normal “D” position driving</p>	<p>Gears between “1” and “6” are automatically selected according to driving conditions</p>
	 <p>(paddle shift switches activated)</p>	<p>Shift range selection (→P. 163)</p>	<p>Allows optimum use of engine braking</p>
		<p>Shift range selection (→P. 162)</p>	<p>Allows the driver to select gears for sporty driving</p>

## Changing shift ranges in S mode

When the shift lever is in the S position, the shift lever or paddle shift switches can be operated as follows:

### Shift lever

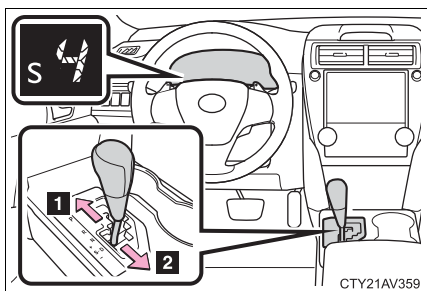

- 1 Upshifting
- 2 Downshifting

### Paddle shift switches

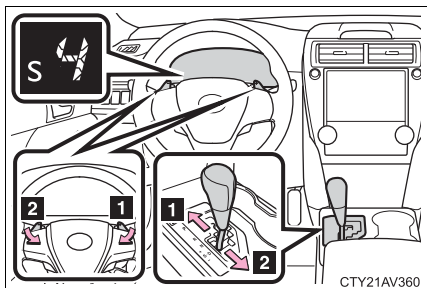

- 1 Upshifting
- 2 Downshifting

The initial shift range in S mode is set automatically to “5” or “4” according to vehicle speed. However, the initial shift range may be set to “3” if AI-SHIFT has operated while the shift lever was in the D position. (→P. 157)

## Selecting shift ranges in the “D” position

To drive using temporary shift range selection, operate the “-”paddle shift switch. The shift range can then be selected by operating the “-” and “+” paddle shift switches. Changing the shift range allows restriction of the highest gear, preventing unnecessary upshifting and enabling the level of engine braking force to be selected.

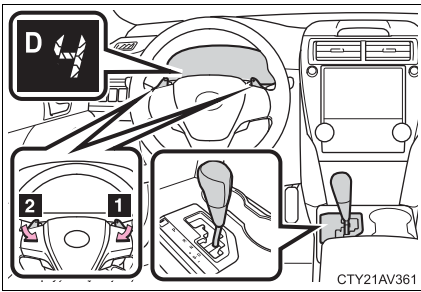

### 1 Upshifting

### 2 Downshifting

The selected shift range, from “1” to “5”, or “D” will be displayed in the meter.

To return to normal “D” position driving, the “+” paddle shift switch must be held down for a period of time.

When a shift range higher than “5” is selected, the shift range will return to the normal D position.

## ■ Shift ranges and their functions

- You can choose from 6 levels of engine braking force.
- A lower shift range will provide greater engine braking force than a higher shift range, and the engine speed will also increase.

■ **S mode**

- When the shift range is “4” or lower, holding the shift lever toward “+” sets the shift range to “6”.
- To prevent the engine from over-revving, upshifting may automatically occur.
- To protect the automatic transmission, a function is adopted that automatically shifts to the top range when the temperature is too hot.

■ **AI-SHIFT**

AI-SHIFT automatically selects the suitable gear according to driver performance and driving conditions.

AI-SHIFT automatically operates when the shift lever is in the D position. (Shifting the shift lever to the S position cancels the function.)

■ **When driving with cruise control activated**

Even when performing the following actions with the intent of enabling engine braking, engine braking will not activate while driving in D or S mode and downshifting to 5 or 4 because cruise control will not be canceled. (→P. 199)

■ **If the shift lever cannot be shifted from P**

→P. 449

■ **If the “S” indicator does not come on or the “D” indicator is displayed even after shifting the shift lever to S**

This may indicate a malfunction in the automatic transmission system. Have the vehicle inspected by your Toyota dealer immediately.

(In this situation, the transmission will operate in the same manner as when the shift lever is in D.)

■ **Downshift restriction warning buzzer**

To help ensure safety and driving performance, downshifting operation may sometimes be restricted. In some circumstances, downshifting may not be possible even when the shift lever or paddle shift switches are operated. (A buzzer will sound twice.)

 **CAUTION****■ When driving on slippery road surfaces**

Do not accelerate or shift gears suddenly.

Sudden changes in engine braking may cause the vehicle to spin or skid, resulting in an accident.

## 2-1. Driving procedures

### Turn signal lever

The turn signal lever can be used to show the following intentions of the driver:

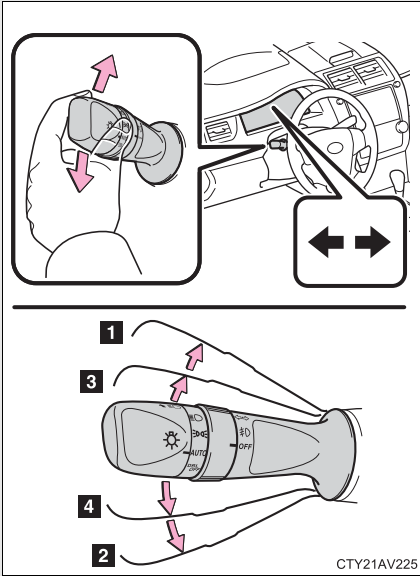

**1** Right turn

**2** Left turn

**3** Lane change to the right  
(push and hold the lever partway)

The right hand signals will flash until you release the lever.

**4** Lane change to the left  
(push and hold the lever partway)

The left hand signals will flash until you release the lever.

#### ■ Turn signals can be operated when

Vehicles without a smart key system: The engine switch is in the "ON" position.

Vehicles with a smart key system: The "ENGINE START STOP" switch is in IGNITION ON mode.

#### ■ If the indicators flashes faster than usual

Check that a light bulb in the front or rear turn signal lights has not burned out.

## Parking brake

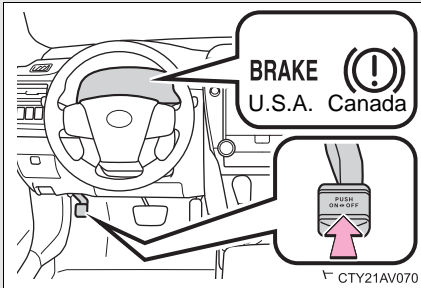

To set the parking brake, fully depress the parking brake pedal with your left foot while depressing the brake pedal with your right foot.

(Depressing the pedal again releases the parking brake.)

### ■ Usage in winter time

See "Winter driving tips" for parking brake usage in winter time. (→P. 218)

### ⚠ NOTICE

#### ■ Before driving

Fully release the parking brake.

Driving the vehicle with the parking brake set will lead to brake components overheating, which may affect braking performance and increase brake wear.

## Horn

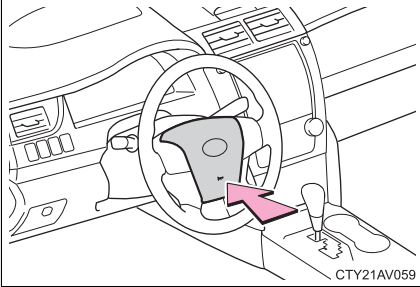

To sound the horn, press on or close to the  mark.

### ■ After adjusting the steering wheel

Make sure that the steering wheel is securely locked.

The horn may not sound if the steering wheel is not securely locked.

(→P. 76)



## 2-2. Instrument cluster Gauges and meters

### Type A

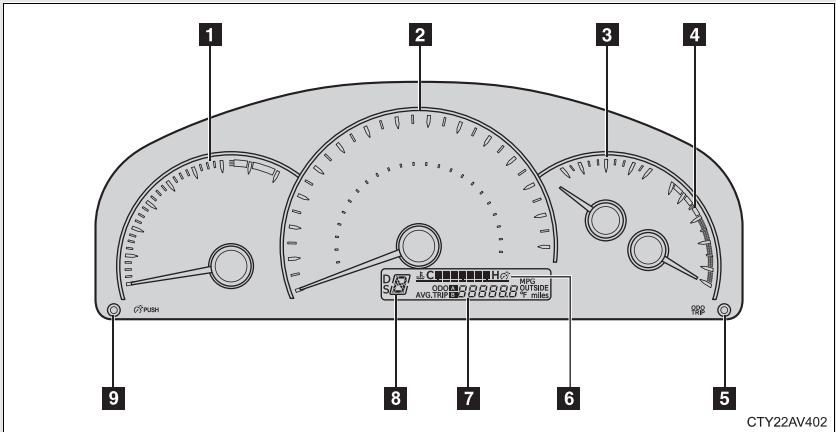

#### **1** Tachometer

Displays the engine speed in revolutions per minute.

#### **2** Speedometer

Displays the vehicle speed.

#### **3** Fuel gauge

Displays the quantity of fuel remaining in the tank.

#### **4** Average fuel consumption meter

Displays the average fuel consumption since the function was reset.

#### **5** Display change button

→P. 172

#### **6** Engine coolant temperature display/instrument panel light control display

Displays the engine coolant temperature and instrument panel light control.

**7** Odometer/trip meter/outside temperature/average fuel consumption/current fuel consumption display.

→P. 172

**8** Shift position/shift range display

Displays the currently selected shift position and the shift range.

→P. 155

**9** Instrument panel light control button

→P. 175

## Type B

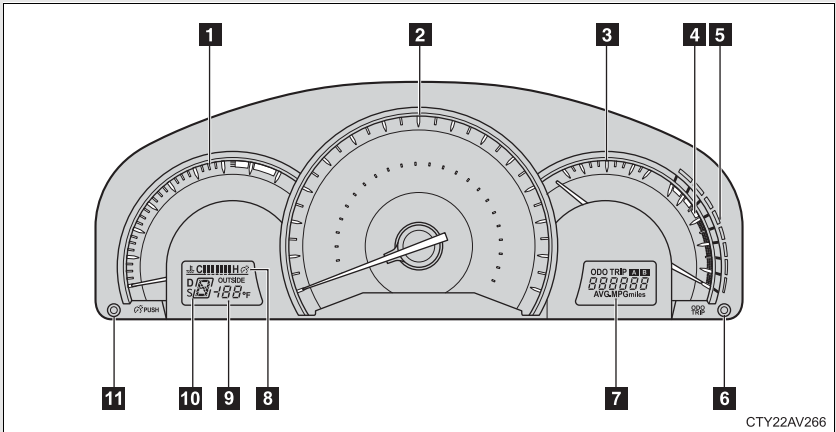
**1** Tachometer

Displays the engine speed in revolutions per minute.

**2** Speedometer

Displays the vehicle speed.

**3** Fuel gauge

Displays the quantity of fuel remaining in the tank.

**4** Average fuel consumption meter

Displays the average fuel consumption since the function was reset.

**5** Current fuel consumption gauge (if equipped)

Displays the current rate of fuel consumption.

**6** Display change button

→P. 172

**7** Odometer/trip meter/average fuel consumption display

→P. 172

**8** Engine coolant temperature display/instrument panel light control display

Displays the engine coolant temperature and instrument panel light control.

**9** Outside temperature display

→P. 301

**10** Shift position/shift range display

Displays the currently selected shift position and the shift range.

→P. 155, 159

**11** Instrument panel light control button

→P. 175

## Changing the odometer/trip meter display

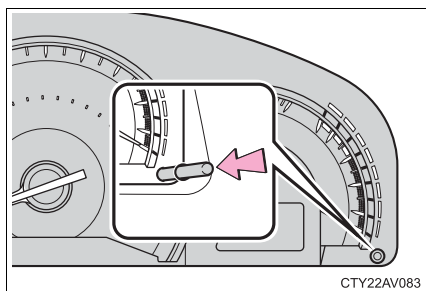

Pressing the button changes the display as follows.

## Type A

### ● Odometer



Displays the total distance the vehicle has been driven.

### ● Trip meters A and B



Displays the distance the vehicle has been driven since the meter was last reset. Trip meters A and B can be used to record and display different distances independently.



Press and hold the button to reset.

### ● Outside temperature



Displays the outside air temperature.

The temperature range that can be displayed is from  $-40^{\circ}\text{F}$  ( $-40^{\circ}\text{C}$ ) to  $122^{\circ}\text{F}$  ( $50^{\circ}\text{C}$ ).

### ● Average fuel consumption

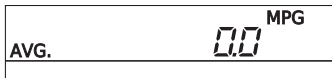

Displays the average fuel consumption since the function was last reset.

- To reset the function, press and hold the button while average fuel consumption is being displayed. The average fuel consumption meter will also be reset, returning the needle to the 0 position.
- Use the displayed average fuel consumption as a reference.

● Current fuel consumption

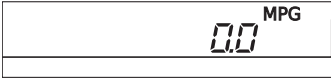

Displays the current rate of fuel consumption

**Type B**

● Odometer



Displays the total distance the vehicle has been driven.

● Trip meters A and B



Displays the distance the vehicle has been driven since the meter was last reset. Trip meters A and B can be used to record and display different distances independently.

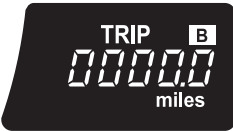

Press and hold the button to reset.

● Average fuel consumption



Displays the average fuel consumption since the function was last reset.

- To reset the function, press and hold the button while average fuel consumption is being displayed. The average fuel consumption meter will also be reset, returning the needle to the 0 position.
- Use the displayed average fuel consumption as a reference.

## Instrument panel light control button

The brightness of the instrument panel lights can be adjusted.

### Type A

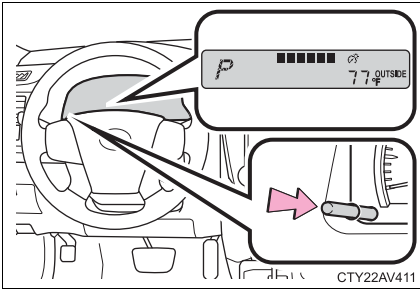

Pressing the button will adjust brightness of the instrument panel lights.

### Type B

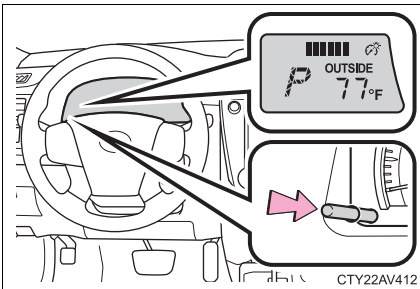

Pressing the button will adjust brightness of the instrument panel lights.

## Eco Driving Indicator Light and current fuel consumption gauge customization

### Type A

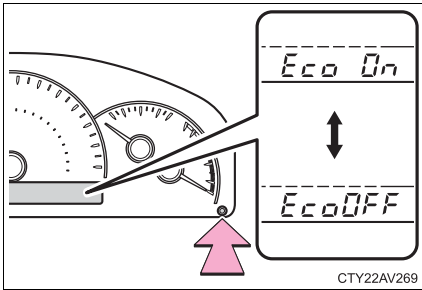

Eco Driving Indicator Light can be activated or deactivated

**STEP 1** While the odometer is being displayed, press and hold the display change button to display the Eco Driving Indicator Light customization screen

**STEP 2** Press the display change button to set Eco Driving Indicator Light to on or off.

**STEP 3** Press and hold the display change button to complete the setting



## Type B

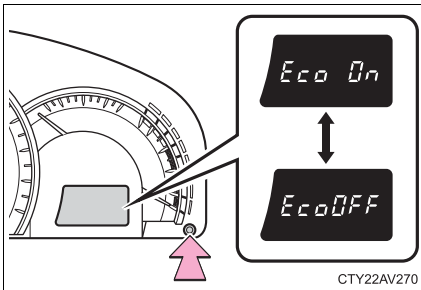

Eco Driving Indicator Light and current fuel consumption gauge can be activated or deactivated

**STEP 1** While the odometer is being displayed, press and hold the display change button to display the Eco Driving Indicator Light customization screen

**STEP 2** Press the display change button to set Eco Driving Indicator Light to on or off.

**STEP 3** Press and hold the display change button to complete the setting

If off is selected, Eco Driving Indicator Light and the current fuel consumption gauge (if equipped) will not be displayed.

2

When driving

### ■ The meters and display illuminate when

Vehicles without a smart key system:  
The engine switch is in the "ON" position.

Vehicles with a smart key system:  
The "ENGINE START STOP" switch is in IGNITION ON mode.

### ■ The brightness of the instrument panel lights

When the tail lights are turned on, the meter's brightness will be reduced slightly unless the meter brightness level adjustment is set to the brightest setting.

On some models: If the tail lights are turned on when the surroundings are dark, the meter's brightness will reduce slightly. However, when the surroundings are bright, such as during the daytime, the meter's brightness will not be reduced even if the tail lights are turned on.

### ■ Fuel gauge and odometer/trip meter display remain on mode

Vehicles without a smart key system:

After the engine switch has been turned off, the fuel gauge and odometer/trip meter display remain on for 10 minutes, enabling the fuel gauge and odometer/trip meter values to be checked again without having to turn the engine switch to the "ON" position.

When confirming the gauges and meters, turn the headlight switch to the  position. Press the display change button to change between the odometer and trip meter displays.

Vehicles with a smart key system:

After the "ENGINE START STOP" switch has been turned off, the fuel gauge and odometer/trip meter display remain on for 10 minutes, enabling the fuel gauge and odometer/trip meter values to be checked again without having to turn the "ENGINE START STOP" switch to IGNITION ON mode.

When confirming the gauges and meters, turn the headlight switch to the  position. Press the display change button to change between the odometer and trip meter displays.

#### NOTICE

#### ■ To prevent damage to the engine and its components

- Do not let the indicator needle of the tachometer enter the red zone, which indicates the maximum engine speed.
- The engine may be overheating if the rightmost segment of the engine coolant temperature display is flashing. In this case, immediately stop the vehicle in a safe place, and check the engine after it has cooled completely. (→P. 459)

## 2-2. Instrument cluster Indicators and warning lights

The indicator and warning lights on the instrument cluster, center panel and outside rear view mirrors inform the driver of the status of the vehicle's various systems.

### ■ Instrument cluster

#### Type A

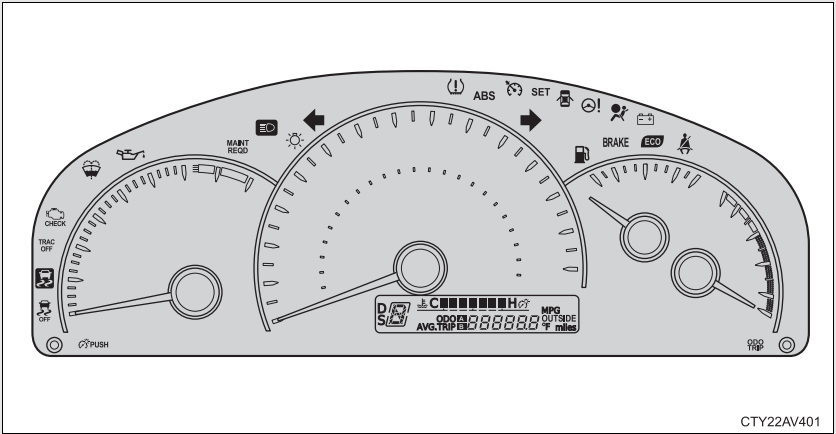

#### Type B

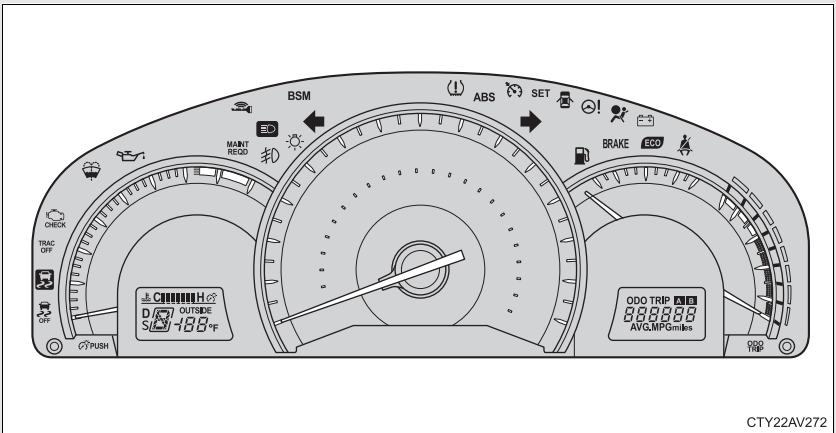

■ Center panel

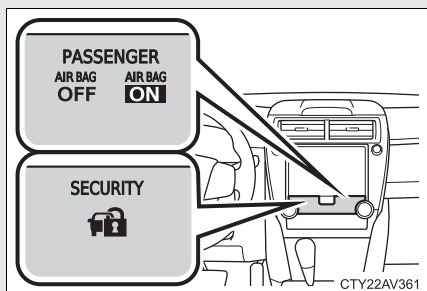

■ Outside rear view mirrors (if equipped)

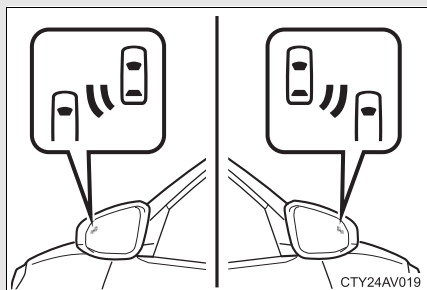

## ■ Indicators

The indicators inform the driver of the operating state of the vehicle's various systems.



Turn signal indicator  
(→P. 166)



Headlight high beam indicator (→P. 188)



Slip indicator  
(→P. 203)



VSC OFF indicator  
(→P. 204)



"TRAC OFF" indicator  
(→P. 204)



Security indicator  
(→P. 92, 95)

### Type A



Shift position and shift range indicators (→P. 155)

### Type B



Shift position and shift range indicators (→P. 155, 159)



(If equipped)

Smart key system indicator (→P. 148)



(if equipped)

BSM outside rear view mirror indicators  
(→P. 208)



(U.S.A.)

Headlight indicator  
(→P. 185)



(Canada)

Tail light indicator  
(→P. 185)



(if equipped)

Front fog light indicator  
(→P. 192)



\*1

SRS airbag on-off indicator (→P. 113)



Cruise control indicator  
(→P. 199)



Cruise control set indicator (→P. 199)



\*1

Eco Driving Indicator Light (→P. 136)

\*1: These lights turn on when the engine switch is turned to the “ON” position (vehicles without a smart key system) or the “ENGINE START STOP” switch is turned to IGNITION ON mode (vehicles with a smart key system) to indicate that a system check is being performed. They will turn off after the engine is started, or after a few seconds. There may be a malfunction in a system if a light does not come on, or if the lights do not turn off. Have the vehicle inspected by your Toyota dealer.

\*2: In order to confirm operation, the BSM outside rear view mirror indicators illuminate in the following situations:

- When the “ENGINE START STOP” switch is turned to IGNITION ON mode while the BSM main switch is set to ON.
- When the BSM main switch is set to ON while the “ENGINE START STOP” switch is in IGNITION ON mode.

If the system is functioning correctly, the BSM outside rear view mirror indicators will turn off after a few seconds.

If the BSM outside rear view mirror indicators do not illuminate or do not turn off, there may be a malfunction with the system.

If this occurs, have the vehicle inspected by your Toyota dealer.

\*3: The light flashes to indicate that the system is operating.

## ■ Warning lights

Warning lights inform the driver of malfunctions in any of the vehicle's systems. (→P. 420)

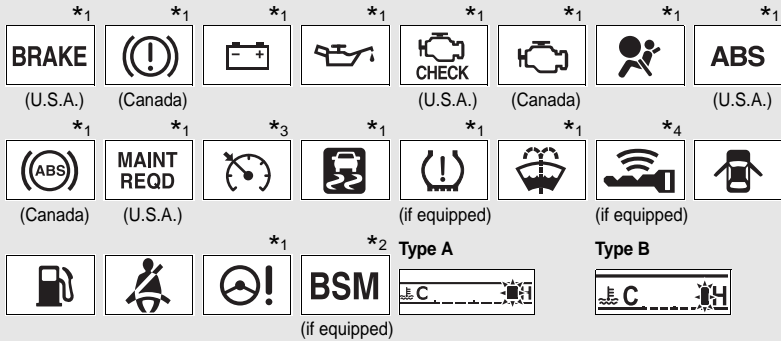

\*1: These lights turn on when the engine switch is turned to the “ON” position (vehicles without a smart key system) or the “ENGINE START STOP” switch is turned to IGNITION ON mode (vehicles with a smart key system) to indicate that a system check is being performed. They will turn off after the engine is started, or after a few seconds. There may be a malfunction in a system if a light does not come on, or if the lights do not turn off. Have the vehicle inspected by your Toyota dealer.

\*2: In order to confirm operation, the BSM outside rear view mirror indicators illuminate in the following situations:

- When the “ENGINE START STOP” switch is turned to IGNITION ON mode while the BSM main switch is set to ON.
- When the BSM main switch is set to ON while the “ENGINE START STOP” switch is in IGNITION ON mode.

If the system is functioning correctly, the BSM outside rear view mirror indicators will turn off after a few seconds.

If the BSM outside rear view mirror indicators do not illuminate or do not turn off, there may be a malfunction with the system.

If this occurs, have the vehicle inspected by your Toyota dealer.

\*3: The light comes on in yellow to indicate a malfunction.

\*4: The light flashes in yellow to indicate a malfunction. The light flashes quickly in green to indicate that the steering lock has not been released.



## CAUTION

### ■ If a safety system warning light does not come on

Should a safety system light such as the ABS or SRS warning light not come on when you start the engine, this could mean that these systems are not available to help protect you in an accident, which could result in death or serious injury. Have the vehicle inspected by your Toyota dealer immediately if this occurs.



## 2-3. Operating the lights and wipers

### Headlight switch

The headlights can be operated manually or automatically.

Turning the end of the lever turns on the lights as follows:

#### U.S.A. (type A)

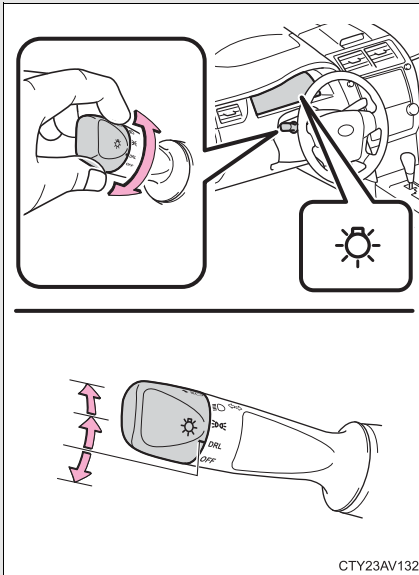

**DRL** The daytime running lights turn on.

 The side marker, parking, tail, license plate, daytime running lights and instrument panel lights turn on.

 The headlights and all the lights listed above (except daytime running lights) turn on.

**OFF** The daytime running light turns off.

### U.S.A. (type B)

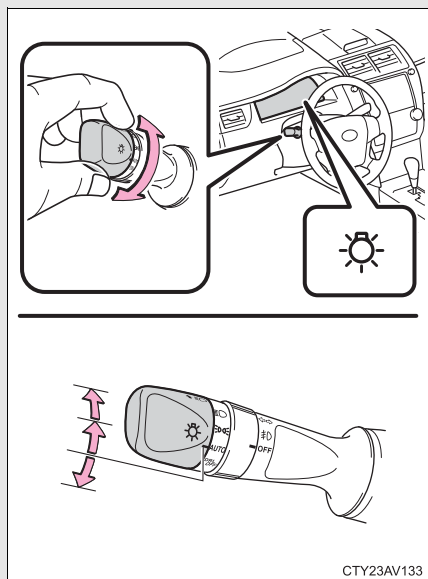

**AUTO** Vehicles without a smart key system: The headlights and parking lights, daytime running lights turn on and off automatically (when the engine switch is in the “ON” position).

Vehicles with a smart key system: The headlights, parking lights, daytime running lights and so on turn on and off automatically (when the “ENGINE START STOP” switch is in IGNITION ON mode).

 The side marker, parking, tail, license plate, daytime running lights and instrument panel lights turn on.

 The headlights and all the lights listed above (except daytime running lights) turn on.

 The daytime running lights turn off.

## Canada

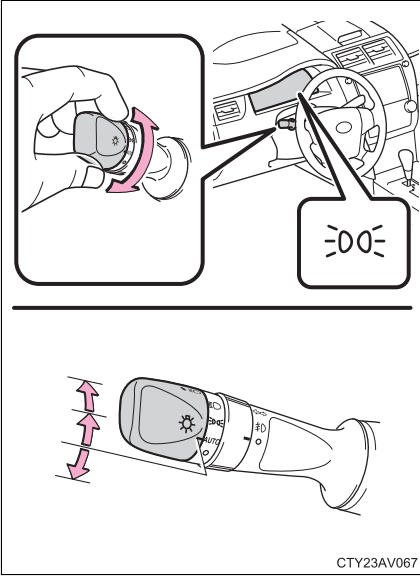

**AUTO** Vehicles without a smart key system: The headlights, parking lights, daytime running lights and so on turn on and off automatically (when the engine switch is in the “ON” position).

Vehicles with a smart key system: The headlights, parking lights, daytime running lights and so on turn on and off automatically (when the “ENGINE START STOP” switch is in IGNITION ON mode).

 The side marker, parking, tail, license plate, daytime running lights and instrument panel lights turn on.

 The headlights and all the lights listed above (except daytime running lights) turn on.

 The daytime running lights turn on.

### Turning on the high beam headlights

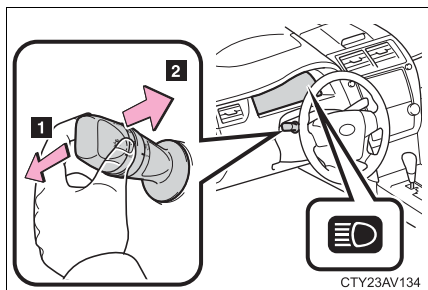

**1** With the headlights on, push the lever away from you to turn on the high beams.

Pull the lever toward you to the center position to turn the high beams off.

**2** Pull the lever toward you and release it to flash the high beams once.

You can flash the high beams with the headlights on or off.

### Manual headlight leveling dial (if equipped)

The level of the headlights can be adjusted according to the number of passengers and the loading condition of the vehicle.

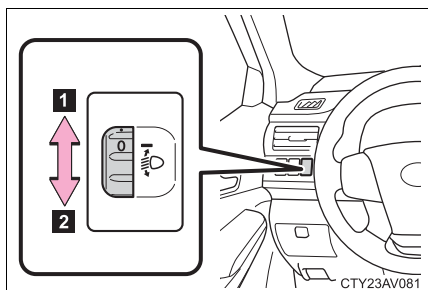

**1** Raises the level of the headlights

**2** Lowers the level of the headlights

## ■ Guide to dial settings

Occupancy and luggage load conditions		Dial position
Occupants	Luggage load	
Driver	None	0
Driver and front passenger	None	0
All seats occupied	None	1
All seats occupied	Full luggage loading	3
Driver	Full luggage loading	4.5

## ■ Daytime running light system

- To make your vehicle more visible to other drivers, the headlights turn on automatically (at a reduced intensity) whenever the engine is started and the parking brake is released. Daytime running lights are not designed for use at night.

U.S.A.: Daytime running lights can be turned off by operating the switch.

- Compared to turning on the headlights, the daytime running light system offers greater durability and consumes less electricity, so it can help improve fuel economy.

## ■ Headlight control sensor (if equipped)

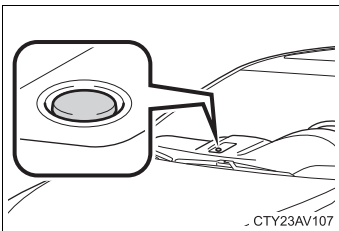



The sensor may not function properly if an object is placed on the sensor, or anything that blocks the sensor is affixed to the windshield.

Doing so interferes with the sensor detecting the level of ambient light and may cause the automatic headlight system to malfunction.

## ■ Automatic light off system (if equipped)

### Vehicles without a smart key system



- When the light switch is in **AUTO** : The headlights and tail lights turn off 30 seconds after the engine switch is turned to the “ACC” or “LOCK” position and a door is opened and closed. (Vehicles with a wireless remote control: The lights turn off immediately if  on the key is pressed twice after all the doors are closed.)

To turn the lights on again, turn the engine switch to “ON” position, or turn the light switch off once and then back to  or  .

If any of the doors or trunk lid is kept open, the lights automatically turn off after 20 minutes.

### Vehicles with a smart key system

- When the light switch is in **AUTO** : The headlights and tail lights turn off 30 seconds after the “ENGINE START STOP” switch is turned to ACCESSORY mode or turned off and a door is opened and closed. (The lights turn off immediately if  on the key is pressed twice after all the doors are closed.)

To turn the lights on again, turn the “ENGINE START STOP” switch to IGNITION ON mode, or turn the light switch off once and then back to  or  .

If any of the doors or trunk lid is kept open, the lights automatically turn off after 20 minutes.

## ■ Light reminder buzzer

### Vehicles without a smart key system

A buzzer sounds when the engine switch is turned “OFF” or to “ACC” position and the driver's door is opened with the key removed from the engine switch while the lights are turned on.

### Vehicles with a smart key system

A buzzer sounds when the “ENGINE START STOP” switch is turned off or turned to ACCESSORY mode and the driver's door is opened while the lights are turned on.

### ■ Battery-saving function

In order to prevent the vehicle battery from discharging, if the headlights and/or tail lights are on when the engine switch is turned to the “LOCK” position (vehicles without a smart key system) or when the “ENGINE START STOP” switch is turned off (vehicles with a smart key system) the battery saving function will operate and automatically turn off all the lights after approximately 20 minutes.

When the engine switch is turned to the “ON” position (vehicles without a smart key system) or when the “ENGINE START STOP” switch is turned to IGNITION ON mode (vehicles with a smart key system), the battery-saving function will be disabled.

When any of the following are performed, the battery-saving function is canceled once and then reactivated. All the lights will turn off automatically 20 minutes after the battery-saving function has been reactivated:

- When the headlight switch is operated
- When a door is opened or closed

### ■ Customization that can be configured at Toyota dealer

Settings (e.g. light sensor sensitivity) can be changed.  
(Customizable features →P. 493)



#### NOTICE

#### ■ To prevent battery discharge

Do not leave the lights on longer than necessary when the engine is not running.

## 2-3. Operating the lights and wipers Fog light switch\*

The fog lights secure excellent visibility in difficult driving conditions, such as in rain and fog.

U.S.A.

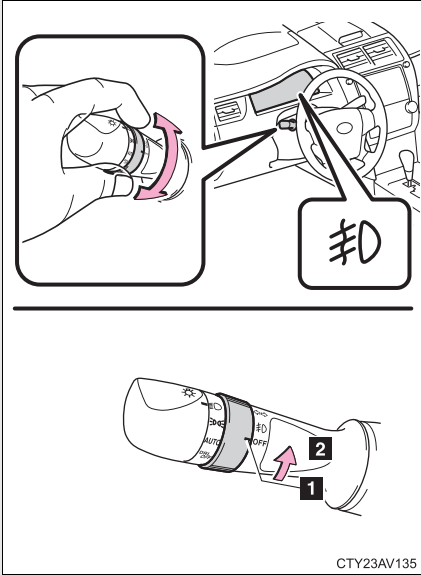

- 1 Turns the front fog lights off
- 2 Turns the front fog lights on

CTY23AV135

\*: If equipped



## Canada

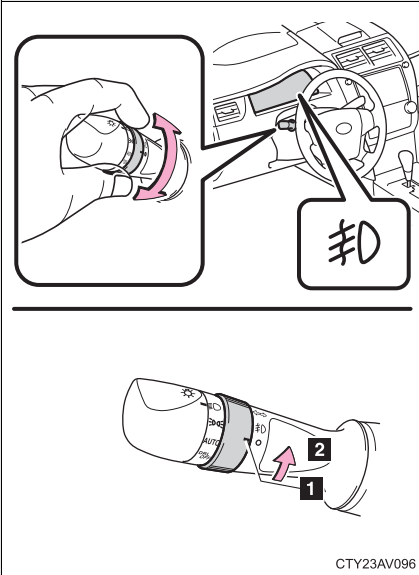

- 1** Turns the front fog lights off
- 2** Turns the front fog lights on

- **Fog lights can be used when**  
The headlights are on in low beam.

## 2-3. Operating the lights and wipers Windshield wipers and washer

The wiper operation is selected by moving the lever as follows.

### U.S.A. (type A)

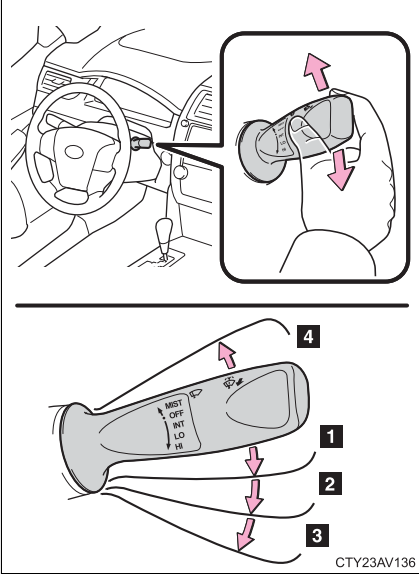

- 1 Intermittent windshield wiper operation
- 2 Low speed windshield wiper operation
- 3 High speed windshield wiper operation
- 4 Temporary operation

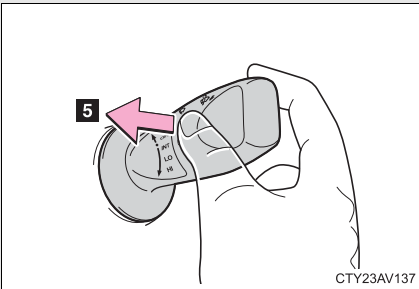

- 5 Washer/wiper dual operation

The wipers will automatically operate a couple of times after the washer squirts.

When **INT** is selected, the wiper interval can be adjusted for intermittent operation.

The wiper operation is selected by moving the lever as follows.

**U.S.A. (type B)**

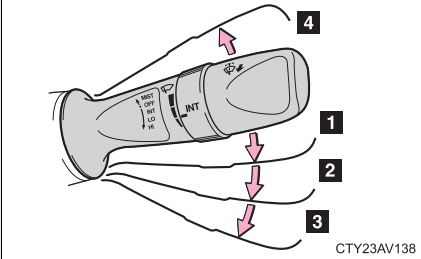
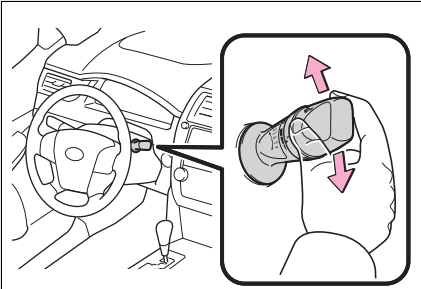

CTY23AV138

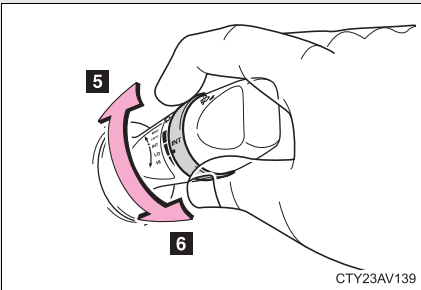

CTY23AV139

- 1** Intermittent windshield wiper operation
- 2** Low speed windshield wiper operation
- 3** High speed windshield wiper operation
- 4** Temporary operation
- 5** Increases the intermittent windshield wiper frequency
- 6** Decreases the intermittent windshield wiper frequency

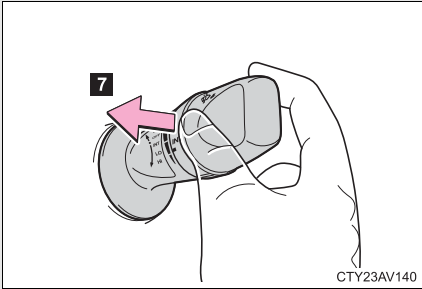

**7** Washer/wiper dual operation

The wipers will automatically operate a couple of times after the washer squirts.

When  is selected, the wiper interval can be adjusted for intermittent operation.

The wiper operation is selected by moving the lever as follows.

**Canada**

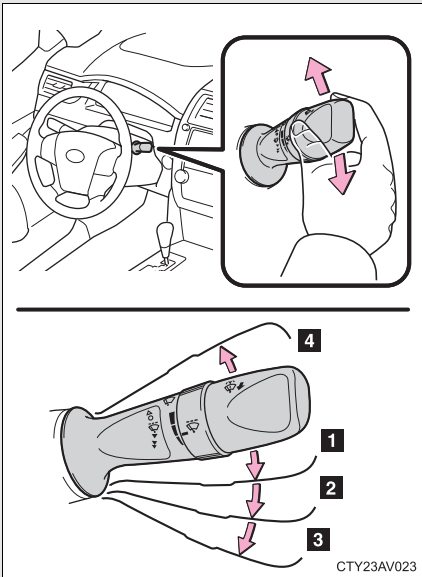

- 1** Intermittent windshield wiper operation
- 2** Low speed windshield wiper operation
- 3** High speed windshield wiper operation
- 4** Temporary operation

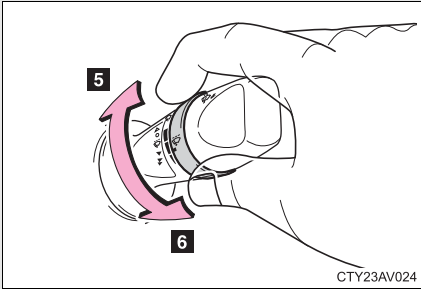

- 5** Increases the intermittent windshield wiper frequency
- 6** Decreases the intermittent windshield wiper frequency

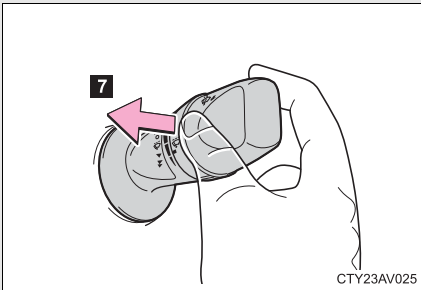

- 7** Washer/wiper dual operation

The wipers will automatically operate a couple of times after the washer squirts.

### ■ The windshield wiper and washers can be operated when

Vehicles without a smart key system: The engine switch is in the "ON" position.

Vehicles with a smart key system: The "ENGINE START STOP" switch is in IGNITION ON mode.

### ■ If no windshield washer fluid sprays

Check that the washer nozzles are not blocked if there is washer fluid in the windshield washer fluid reservoir.

 NOTICE

■ **When the windshield is dry**

Do not use the wipers, as they may damage the windshield.

■ **When the washer fluid tank is empty**

Do not operate the switch continually as the washer fluid pump may over-heat.

■ **When a nozzle becomes blocked**

In this case, contact your Toyota dealer.

Do not try to clear it with a pin or other object. The nozzle will be damaged.

## 2-4. Using other driving systems

### Cruise control

Use the cruise control to maintain a set speed without depressing the accelerator pedal.

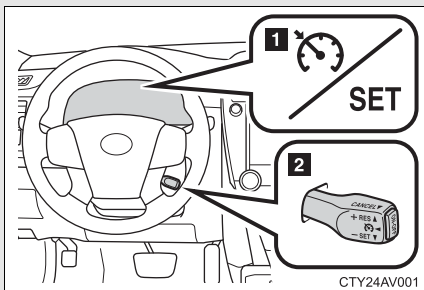

- 1 Indicators
- 2 Cruise control switch

#### ■ Setting the vehicle speed

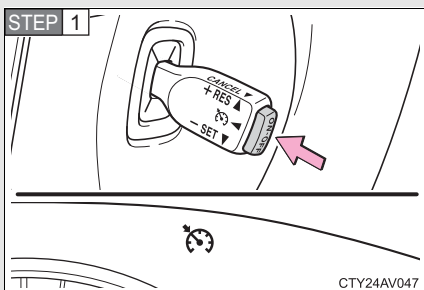

Press the “ON-OFF” button to activate the cruise control.

Cruise control indicator will come on.

Press the button again to deactivate the cruise control.

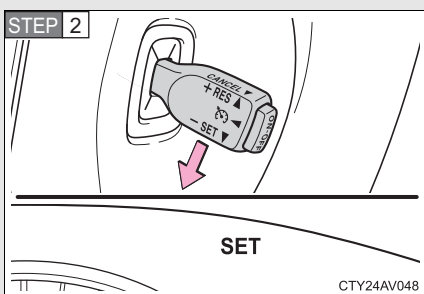

Accelerate or decelerate the vehicle to the desired speed, and push the lever down to set the speed.

“SET” indicator will come on.

The vehicle speed at the moment the lever is released becomes the set speed.

### ■ Adjusting the set speed

To change the set speed, operate the lever until the desired set speed is obtained.

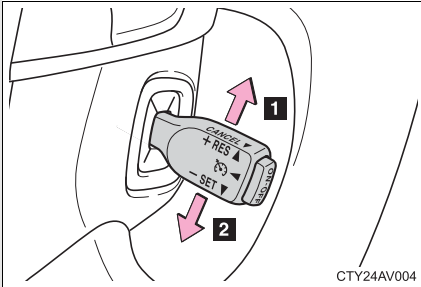

**1** Increases the speed

**2** Decreases the speed

Fine adjustment: Momentarily move the lever in the desired direction.

Large adjustment: Hold the lever in the desired direction.

The set speed will be increased or decreased as follows:

Fine adjustment: By approximately 1 mph (1.6 km/h) each time the lever is operated.

Large adjustment: The set speed can be increased or decreased continually until the lever is released.

### ■ Canceling and resuming the constant speed control

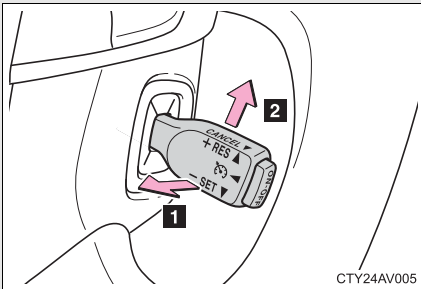

**1** Pulling the lever toward you cancels the constant speed control.

The speed setting is also canceled when the brakes are applied.

**2** Pushing the lever up resumes the constant speed control.

Resuming is available when the vehicle speed is more than approximately 25 mph (40 km/h).



---

**■ Cruise control can be set when**

- The shift lever is in the D or range 4 or higher of S has been selected.
- Range 4 or higher has been selected by using the paddle shift. (vehicles with paddle shift switch)
- Vehicle speed is above approximately 25 mph (40 km/h).

**■ Accelerating after setting the vehicle speed**

- The vehicle can be accelerated normally. After acceleration, the set speed resumes.
- Even without canceling the cruise control, the set speed can be increased by first accelerating the vehicle to the desired speed and then pushing the lever down to set the new speed.

**■ Automatic cruise control cancelation**

Cruise control will stop maintaining the vehicle speed in any of the following situations.

- Actual vehicle speed falls more than approximately 10 mph (16 km/h) below the preset vehicle speed.  
At this time, the memorized set speed is not retained.
- Actual vehicle speed is below approximately 25 mph (40 km/h).
- VSC is activated.

**■ If the cruise control indicator light comes on in yellow**

Press the "ON-OFF" button once to deactivate the system, and then press the button again to reactivate the system.

If the cruise control speed cannot be set or if the cruise control cancels immediately after being activated, there may be a malfunction in the cruise control system. Have the vehicle inspected by your Toyota dealer.

 **CAUTION**

■ **To avoid operating the cruise control by mistake**

Switch the cruise control off using the “ON-OFF” button when not in use.

■ **Situations unsuitable for cruise control**

Do not use cruise control in any of the following situations.

Doing so may result in loss of control and could cause an accident resulting in death or serious injury.

- In heavy traffic
- On roads with sharp bends
- On winding roads
- On slippery roads, such as those covered with rain, ice or snow
- On steep hills

Vehicle speed may exceed the set speed when driving down a steep hill.

## 2-4. Using other driving systems

### Driving assist systems

To help enhance driving safety and performance, the following systems operate automatically in response to various driving situations. Be aware, however, that these systems are supplementary and should not be relied upon too heavily when operating the vehicle.

#### ■ ABS (Anti-lock Brake System)

Helps to prevent wheel lock when the brakes are applied suddenly, or if the brakes are applied while driving on a slippery road surface.

#### ■ Brake assist

Generates an increased level of braking force after the brake pedal is depressed when the system detects a panic stop situation.

#### ■ VSC (Vehicle Stability Control)

Helps the driver to control skidding when swerving suddenly or turning on slippery road surfaces.

#### ■ TRAC (Traction Control)

Helps to maintain drive power and prevent the drive wheels from spinning when starting the vehicle or accelerating on slippery roads.

#### ■ EPS (Electric Power Steering)

Employs an electric motor to reduce the amount of effort needed to turn the steering wheel.

#### ■ BSM (Blind Spot Monitor) (if equipped)

→P. 208

### When the TRAC/VSC systems are operating

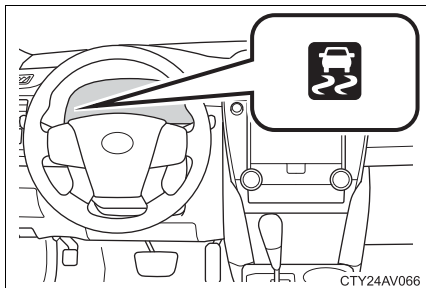

If the vehicle is in danger of slipping or if any of the drive wheels spins, the slip indicator light flashes to indicate that the VSC/TRAC systems are operating.

## Disabling the TRAC/VSC systems

If the vehicle gets stuck in fresh snow or mud, the TRAC/VSC systems may reduce power from the engine to the wheels. You may need to turn the system off to enable you to rock the vehicle in order to free it.

### ■ Turning off the TRAC system only

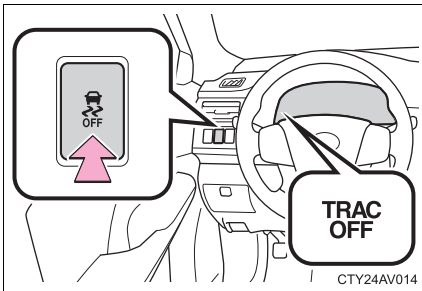

Quickly push and release the switch to turn off TRAC.

The "TRAC OFF" indicator light should come on.

Press the switch again to turn the system back on.

### ■ Turning off both TRAC and VSC systems

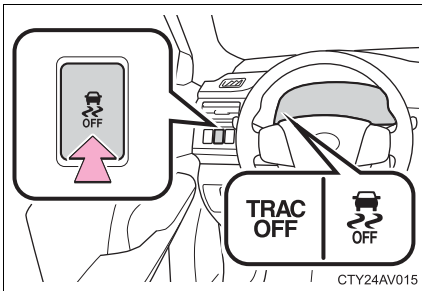

Push and hold the switch for more than 3 seconds while the vehicle is stopped to turn off TRAC and VSC.

The "TRAC OFF" and VSC OFF indicator lights should come on.

Press the switch again to turn the systems back on.

■ **When the “TRAC OFF” indicator light comes on even if the VSC OFF switch has not been pressed**

TRAC cannot be operated. Contact your Toyota dealer.

■ **Sounds and vibrations caused by the ABS, brake assist, VSC and TRAC**

- A sound may be heard from the engine compartment when the engine is started or just after the vehicle begins to move. This sound does not indicate that a malfunction has occurred in any of these systems.
- Any of the following conditions may occur when the above systems are operating. None of these indicates that a malfunction has occurred.
  - Vibrations may be felt through the vehicle body and steering.
  - A motor sound may be heard after the vehicle comes to a stop.
  - The brake pedal may pulsate slightly after the ABS is activated.
  - The brake pedal may move down slightly after the ABS is activated.

■ **EPS operation sound**

When the steering wheel is operated, a motor sound (whirring sound) may be heard. This does not indicate a malfunction.

■ **Reactivation of the TRAC /VSC systems after turning off the engine**

Turning off the engine after turning off the TRAC/VSC systems will automatically reactivate them.

■ **Reactivation of the TRAC system linked to vehicle speed**

When only the TRAC system is turned off, the TRAC system will turn on when vehicle speed increases. However, when both TRAC and VSC systems are turned off, the systems will not turn on even when vehicle speed increases.

■ **Reduced effectiveness of the EPS system**

The effectiveness of the EPS system is reduced to prevent the system from overheating when there is frequent steering input over an extended period of time. The steering wheel may feel heavy as a result. Should this occur, refrain from excessive steering input or stop the vehicle and turn the engine off. The EPS system should return to normal within 10 minutes.

■ **If the slip indicator comes on...**

It may indicate a malfunction in the TRAC and VSC. Contact your Toyota dealer.

 CAUTION

■ **ABS does not operate effectively when**

- Tires with inadequate gripping ability are used (such as excessively worn tires on a snow covered road).
- The vehicle hydroplanes while driving at high speed on the wet or slick road.

■ **Stopping distance when the ABS is operating may exceed that of normal conditions**

The ABS is not designed to shorten the vehicle's stopping distance. Always maintain a safe distance from the vehicle in front of you in the following situations:

- When driving on dirt, gravel or snow-covered roads
- When driving with tire chains
- When driving over bumps in the road
- When driving over roads with potholes or roads with uneven surfaces

■ **TRAC may not operate effectively when**

Directional control and power may not be achievable while driving on slippery road surfaces, even if the TRAC system is operating.

Do not drive the vehicle in conditions where stability and power may be lost.

 **CAUTION****■ When the VSC is activated**

The slip indicator light flashes. Always drive carefully. Reckless driving may cause an accident. Exercise particular care when the indicator light flashes.

**■ When the TRAC/VSC systems are turned off**

Be especially careful and drive at a speed appropriate to the road conditions. As these are the systems to ensure vehicle stability and driving force, do not turn the TRAC/VSC systems off unless necessary.

**■ Replacing tires**

Make sure that all tires are of the specified size, brand, tread pattern and total load capacity. In addition, make sure that the tires are inflated to the recommended tire inflation pressure level.

The ABS, TRAC and VSC systems will not function correctly if different tires are installed on the vehicle.

Contact your Toyota dealer for further information when replacing tires or wheels.

**■ Handling of tires and suspension**

Using tires with any kind of problem or modifying the suspension will affect the driving assist systems, and may cause a system to malfunction.

## 2-4. Using other driving systems BSM (Blind Spot Monitor)\*

The **Blind Spot Monitor** is a system that assists the driver in making the decision to change lanes.

The system uses radar sensors to detect vehicles that are traveling in an adjacent lane in the area that is not reflected in the outside rear view mirror (the blind spot), and advises the driver of the vehicles existence via the outside rear view mirror indicator.

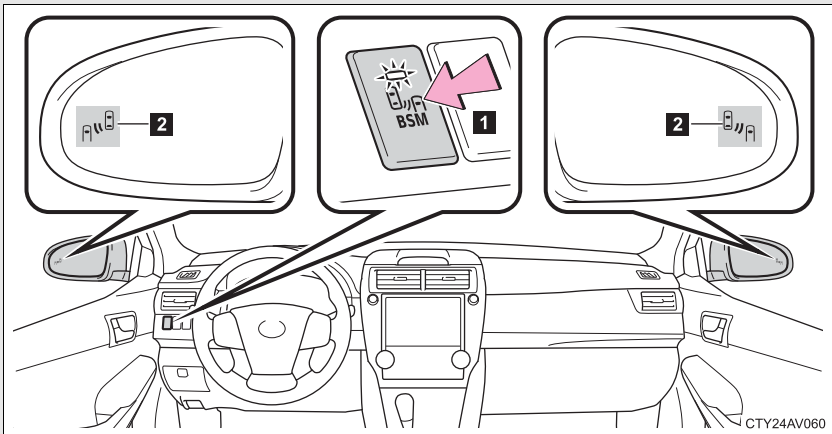

### 1 BSM main switch

Pressing the switch turns the system on or off. When the switch is set to on, the switch's indicator illuminates.

### 2 Outside rear view mirror indicator

When a vehicle is detected in the blind spot, the outside rear view mirror indicator on that side illuminates. If the turn signal lever is operated when a vehicle is in the blind spot, the outside rear view mirror indicator flashes.

\*: If equipped



## The Blind Spot Monitor detection areas

The blind spot that vehicles can be detected in are outlined below.

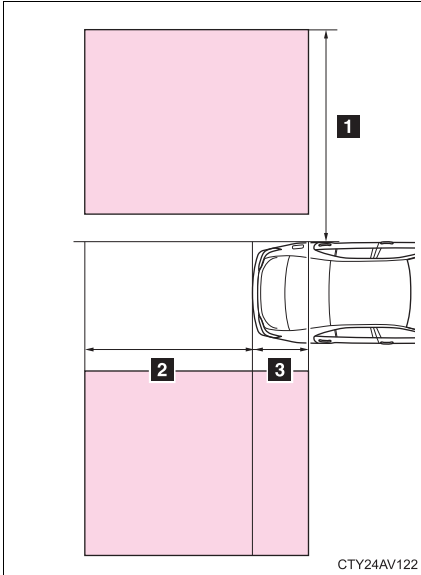

The range of the detection area extends to:

- 1** Approximately 11.5 ft. (3.5 m) from the side of the vehicle

The first 1.6 ft. (0.5 m) from the side of the vehicle is not in the detection area

- 2** Approximately 9.8 ft. (3 m) from the rear bumper
- 3** Approximately 3.3 ft. (1 m) forward of the rear bumper

2

When driving

### ■ The Blind Spot Monitor is operational when

The BSM main switch is set to on and vehicle speed is greater than about 25 mph (40 km/h)

### ■ The Blind Spot Monitor will detect a vehicle when

- A vehicle in an adjacent lane overtakes your vehicle
- Another vehicle enters the vehicles detection area when it changes lanes.

■ **Conditions under which the Blind Spot Monitor will not detect a vehicle**

The Blind Spot Monitor is not designed to detect the following types of vehicles and/or objects:

- Vehicles traveling from the opposite direction
- Small motorcycles, bicycles, pedestrians etc.\*
- Guardrails, walls, signs, parked vehicles and similar stationary objects\*
- Following vehicles that are in the same lane\*
- Vehicles driving 2 lanes across from your vehicle\*

\*: Depending on conditions, detection of a vehicle and/or object may occur

■ **Conditions under which the Blind Spot Monitor may not function correctly**

- The Blind Spot Monitor may not detect vehicles correctly in the following conditions:
  - During bad weather such as heavy rain, fog, snow etc.
  - When ice, mud etc. is attached to the rear bumper
  - When driving on a road surface that is wet due to rain, standing water etc.
  - When there is a significant difference in speed between your vehicle and the vehicle that enters the detection area
  - When a vehicle is in the detection area from a stop and remains in the detection area as your vehicle accelerates
  - When driving up or down consecutive steep inclines, such as hills, a dip in the road etc.
  - When multiple vehicles approach with only a small gap between each vehicle
  - When vehicle lanes are wide, and the vehicle in the next lane is too far away from your vehicle
  - When the vehicle that enters the detection area is traveling at about the same speed as your vehicle
  - When there is a significant difference in height between your vehicle and the vehicle that enters the detection area.
  - Directly after the BSM switch is set to on.

- Instances of the Blind Spot Monitor unnecessarily detecting a vehicle and/or object may increase under the following conditions:
  - When there is only a short distance between your vehicle and a guard-rail, wall etc.
  - When there is only a short distance between your vehicle and a following vehicle.
  - When vehicle lanes are narrow and a vehicle driving 2 lanes across from your vehicle enters the detection area

#### ■ The outside rear view mirror indicators visibility

When under strong sunlight, the outside rear view mirror indicator may be difficult to see.

#### ■ When there is a malfunction in the system

If a system malfunction is detected due to any of the following reasons, warning lights will turn on: (→P. 421)

- There is a malfunction with the sensors
- The sensors have become dirty
- The outside temperature is extremely high or low
- The sensor voltage has become abnormal

#### ■ Certification for the Blind Spot Monitor

FCC ID: OAYBSDTX

This device complies with part 15 of the FCC Rules. Operation is subject to the following three conditions:

- (1) This device may not cause harmful interference.
- (2) This device must accept any interference received, including interference that may cause undesired operation.
- (3) This device may only work when the vehicle is in operation pursuant to § 15.252 (a) (4).

#### FCC WARNING

Changes or modifications not expressly approved by the party responsible for compliance could void the user's authority to operate the equipment.

**! CAUTION**

**■ Cautions regarding the use of the system**

The driver is solely responsible for safe driving. Always drive safely, taking care to observe your surroundings.

The Blind Spot Monitor is a supplementary system which alerts the driver that a vehicle is present in the blind spot. Do not overly rely on the Blind Spot Monitor. The system cannot judge if it is safe to change lanes, therefore over reliance could cause an accident resulting in death or serious injury. According to conditions, the system may not function correctly. Therefore the driver's own visual confirmation of safety is necessary.

**■ Handling the radar sensor**

One Blind Spot Monitor is installed inside the left and right side of the vehicle rear bumper respectively. Observe the following to ensure the Blind Spot Monitor can function correctly.

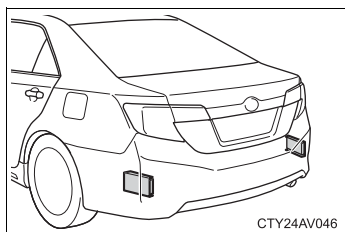

- Keep the sensor and its surrounding area on the bumper clean at all times.

- Do not subject the sensor or surrounding area on the bumper to a strong impact. If the sensor moves even slightly off position, the system may malfunction and vehicles that enter the detection area may not be detected. If the sensor or surrounding area is subject to a strong impact, always have the area inspected by your Toyota dealer.
- Do not disassemble the sensor.
- Do not attach accessories or stickers to the sensor or surrounding area on the bumper.
- Do not modify the sensor or surrounding area on the bumper.
- Do not paint the sensor or surrounding area on the bumper.

## 2-5. Driving information

# Cargo and luggage

**Take notice of the following information about storage precautions, cargo capacity and load:**

- Stow cargo and luggage in the trunk whenever possible.
- Be sure all items are secured in place.
- To maintain vehicle balance while driving, position luggage evenly within the luggage compartment.
- For better fuel economy, do not carry unnecessary weight.

### Capacity and distribution

Cargo capacity depends on the total weight of the occupants.

(Cargo capacity) = (Total load capacity) - (Total weight of occupants)

#### **Steps for Determining Correct Load Limit—**

- (1) Locate the statement “The combined weight of occupants and cargo should never exceed XXX kg or XXX lbs.” on your vehicle's placard.
- (2) Determine the combined weight of the driver and passengers that will be riding in your vehicle.
- (3) Subtract the combined weight of the driver and passengers from XXX kg or XXX lbs.
- (4) The resulting figure equals the available amount of cargo and luggage load capacity.

For example, if the “XXX” amount equals 1400 lbs. and there will be five 150 lb passengers in your vehicle, the amount of available cargo and luggage load capacity is 650 lbs. (1400 - 750 (5 × 150) = 650 lbs.)

- (5) Determine the combined weight of luggage and cargo being loaded on the vehicle. That weight may not safely exceed the available cargo and luggage load capacity calculated in Step 4.

(6) If your vehicle will be towing a trailer, load from your trailer will be transferred to your vehicle. Consult this manual to determine how this reduces the available cargo and luggage load capacity of your vehicle.

(→P. 466)

Toyota does not recommend towing a trailer with your vehicle. Your vehicle is not designed for trailer towing.

### Example based on your vehicle

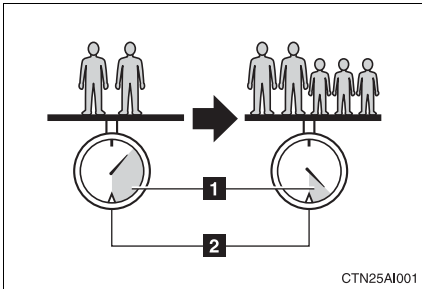

- 1 Cargo capacity
- 2 Total load capacity

When 2 people with the combined weight of 366 lb. (166 kg) are riding in your vehicle, which has a total load capacity of 905 lb. (410 kg), the available amount of cargo and luggage load capacity will be as follows:

$$905 \text{ lb.} - 366 \text{ lb.} = 539 \text{ lb.} \quad (410 \text{ kg} - 166 \text{ kg} = 244 \text{ kg})$$

In this condition, if 3 more passengers with the combined weight of 388 lb. (176 kg) get on, the available cargo and luggage load will be reduced as follows:

$$539 \text{ lb.} - 388 \text{ lb.} = 151 \text{ lb.} \quad (244 \text{ kg} - 176 \text{ kg} = 68 \text{ kg})$$

As shown in the above example, if the number of occupants increases, the cargo and luggage load will be reduced by an amount that equals the increased weight due to the additional occupants. In other words, if an increase in the number of occupants causes an excess of the total load capacity (combined weight of occupants plus cargo and luggage load), you must reduce the cargo and luggage on your vehicle.

 CAUTION**■ Things that must not be carried in the trunk**

The following things may cause a fire if loaded in the trunk:

- Receptacles containing gasoline
- Aerosol cans

**■ Storage precautions**

Observe the following precautions.

Failure to do so may result in death or serious injury.

- Stow cargo and luggage in the trunk whenever possible.
- To prevent cargo and luggage from sliding forward during braking, do not stack anything in the enlarged trunk. Keep cargo and luggage low, as close to the floor as possible.
- When you fold down the rear seats, long items should not be placed directly behind the front seats.
- Never allow anyone to ride in the enlarged trunk. It is not designed for passengers. They should ride in their seats with their seat belts properly fastened. Otherwise, they are much more likely to suffer death or serious bodily injury, in the event of sudden braking, sudden swerving or an accident.
- Do not place cargo or luggage in or on the following locations as the item may get under the brake or accelerator pedal and prevent the pedals from being depressed properly, block the driver's vision, or hit the driver or passengers, causing an accident:
  - At the feet of the driver
  - On the front passenger or rear seats (when stacking items)
  - On the package tray
  - On the instrument panel
  - On the dashboard
- Secure all items in the occupant compartment, as they may shift and injure someone during sudden braking, sudden swerving or an accident.

 CAUTION

■ **Capacity and distribution**

- Do not exceed the maximum axle weight rating or the total vehicle weight rating.
- Even if the total load of occupant's weight and the cargo load is less than the total load capacity, do not apply the load unevenly. Improper loading may cause deterioration of steering or braking control which may cause death or serious injury.



**Vehicle load limits include total load capacity, seating capacity, towing capacity and cargo capacity.**

■ **Total load capacity: 905 lb. (410 kg)**

Total load capacity means the combined weight of occupants, cargo and luggage.

■ **Seating capacity: 5 occupants (Front 2, Rear 3)**

Seating capacity means the maximum number of occupants whose estimated average weight is 150 lb. (68 kg) per person.

■ **Towing capacity**

Toyota does not recommend towing a trailer with your vehicle.

■ **Cargo capacity**

Cargo capacity may increase or decrease depending on the weight and the number of occupants.

---

■ **Total load capacity and seating capacity**

These details are also described on the tire and loading information label. (→P. 375)

 **CAUTION**

■ **Overloading the vehicle**

Do not overload the vehicle.

It may not only cause damage to the tires, but also degrade steering and braking ability, resulting in an accident.

**Carry out the necessary preparations and inspections before driving the vehicle in winter. Always drive the vehicle in a manner appropriate to the prevailing weather conditions.**

■ **Pre-winter preparations**

- Use fluids that are appropriate to the prevailing outside temperatures.
  - Engine oil
  - Engine coolant
  - Washer fluid
- Have a service technician inspect the level and specific gravity of battery electrolyte.
- Have the vehicle fitted with four snow tires or purchase a set of tire chains for the front tires.

Ensure that all tires are the same size and brand, and that chains match the size of the tires.

■ **Before driving the vehicle**

Perform the following according to the driving conditions:

- Do not try to forcibly open a window or move a wiper that is frozen. Pour warm water over the frozen area to melt the ice. Wipe away the water immediately to prevent it from freezing.
- To ensure proper operation of the climate control system fan, remove any snow that has accumulated on the air inlet vents in front of the windshield.
- Remove any ice that has accumulated on the vehicle chassis.
- Periodically check for and remove any excess ice or snow that may have accumulated in the wheel well or on the brakes.

### ■ When driving the vehicle

Accelerate the vehicle slowly and drive at a reduced speed suitable to road conditions.

### ■ When parking the vehicle

Park the vehicle and move the shift lever to P without setting the parking brake. The parking brake may freeze up, preventing it from being released. If necessary, block the wheels to prevent inadvertent sliding or creeping.

2

When driving

## Selecting tire chains

Use the correct tire chain size when mounting the snow chains. Chain size is regulated for each tire size.

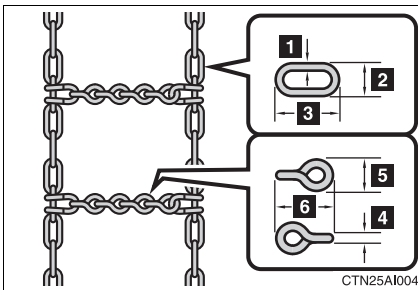

### Side chain:

- 1 0.12 in. (3 mm) in diameter
- 2 0.39 in. (10 mm) in width
- 3 1.18 in. (30 mm) in length

### Cross chain:

- 4 0.16 in. (4 mm) in diameter
- 5 0.55 in. (14 mm) in width
- 6 0.98 in. (25 mm) in length

## Regulations on the use of tire chains

Regulations regarding the use of tire chains vary according to location and type of road. Always check local regulations before installing chains.

### ■ Tire chain installation

Observe the following precautions when installing and removing chains:

- Install and remove tire chains in a safe location.
- Install tire chains on the front tires only. Do not install tire chains on the rear tires.
- Install tire chains on front tires as tightly as possible. Retighten chains after driving 1/4 — 1/2 mile (0.5 — 1.0 km).
- Install tire chains following the instructions provided with the tire chains.

### CAUTION

#### ■ Driving with snow tires

Observe the following precautions to reduce the risk of accidents.

Failure to do so may result in a loss of vehicle control and cause death or serious injury.

- Use tires of the size specified.
- Maintain the recommended level of air pressure.
- Do not drive in excess of 75 mph (120 km/h), regardless of the type of snow tires being used.
- Use snow tires on all, not just some wheels.

#### ■ Driving with tire chains

Observe the following precautions to reduce the risk of accidents.

Failure to do so may result in the vehicle being unable to be driven safely, and may cause death or serious injury.

- Do not drive in excess of the speed limit specified for the tire chains being used, or 30 mph (50 km/h), whichever is lower.
- Avoid driving on bumpy road surfaces or over potholes.
- Avoid sudden turns and braking, as use of chains may adversely affect vehicle handling.
- Slow down sufficiently before entering a curve to ensure that vehicle control is maintained.

 NOTICE**■ Repairing or replacing snow tires**

Request repairs or replacement of snow tires from Toyota dealers or legitimate tire retailers.

This is because the removal and attachment of snow tires affects the operation of the tire pressure warning valves and transmitters.

**■ Fitting tire chains**

The tire pressure warning valves and transmitters may not function correctly when tire chains are fitted.

## Trailer towing

**Toyota does not recommend towing a trailer with your vehicle. Toyota also does not recommend the installation of a tow hitch or the use of a tow hitch carrier for a wheelchair, scooter, bicycle, etc. Your vehicle is not designed for trailer towing or for the use of tow hitch mounted carriers.**



## 2-5. Driving information

### Dinghy towing

Your vehicle is not designed to be dinghy towed (with 4 wheels on the ground) behind a motor home.

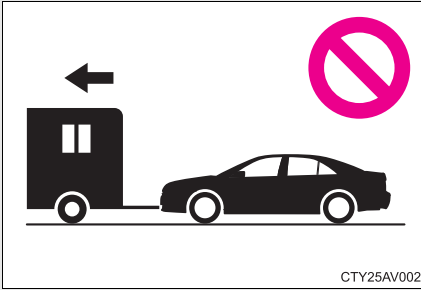

#### NOTICE

**■ To avoid serious damage to your vehicle**

Do not tow your vehicle with the four wheels on the ground.





### 3-1. Using the air conditioning system and defogger

Manual air conditioning system .....	226
Automatic air conditioning system .....	233
Rear window and outside rear view mirror defoggers .....	240

### 3-2. Using the audio system

Audio system types .....	242
Using the radio .....	248
Using the CD player .....	251
Playing back MP3 and WMA discs .....	257
Operating an iPod .....	264
Operating a USB memory .....	272
Optimal use of the audio system .....	280
Using the AUX port .....	283

### 3-3. Using the interior lights

Interior lights list .....	285
• Interior lights .....	286
• Personal lights .....	287

### 3-4. Using the storage features

List of storage features ....	289
• Glove box .....	290
• Console box .....	291
• Coin holder .....	292
• Bottle holders .....	293
• Cup holders .....	294
• Auxiliary boxes .....	296

### 3-5. Other interior features

Sun visors .....	298
Vanity mirrors .....	299
Clock .....	300
Outside temperature display .....	301
Ashtray .....	303
Power outlets .....	304
Seat heaters .....	307
Armrest .....	309
Coat hooks .....	310
Floor mat .....	311
Trunk features .....	313
Garage door opener .....	315
Compass .....	322
Safety Connect .....	326

### 3-1. Using the air conditioning system and defogger Manual air conditioning system\*

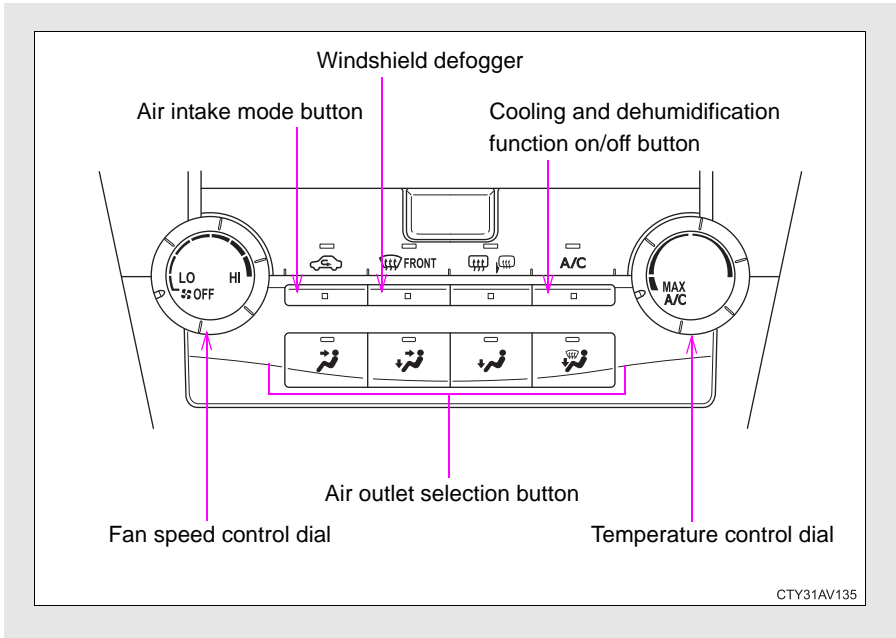



**Adjusting the settings**





**STEP 1** To adjust the fan speed, turn the fan speed control dial clockwise (increase) or counterclockwise (decrease).

Turning the dial to “OFF” turns off the fan.

**STEP 2** To adjust the temperature setting, turn the temperature control dial clockwise (warm) or counterclockwise (cool).

If  is not pressed, the system will blow ambient temperature air or heated air.

For quick cooling, turn the temperature control dial to “MAX A/C”. The air conditioning will automatically turn on. The air intake mode button will be set for recirculated air mode when  or  is selected. It is not possible to turn to the outside air mode.

**STEP 3** To change the air outlets, press  ,  ,  or  .

**Defogging the windshield**

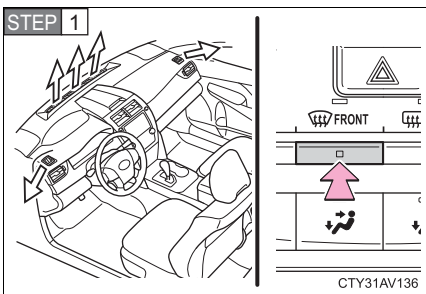

Press  .

If the recirculated air mode is used, it will automatically switch to the outside air mode.

**STEP 2** Perform the following operations accordingly:

- To adjust the fan speed, turn the fan speed control dial.
- To adjust the temperature setting, turn the temperature control dial.
- If the dehumidification function is not operating, press



to operate the dehumidification function.

To defog the windshield and the side windows early, turn the air flow and temperature up.

### Air outlets and air flow

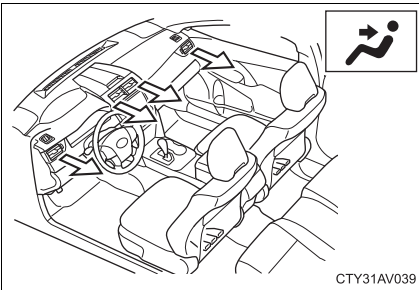

Air flows to the upper body.

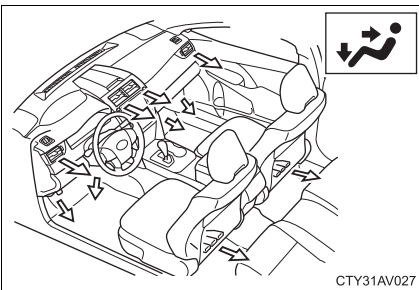

Air flows to the upper body and feet.

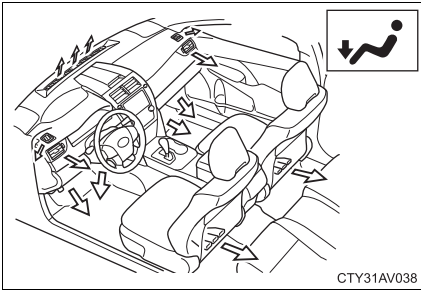

Air flows to the feet.

The air intake is automatically switched to outside air mode.

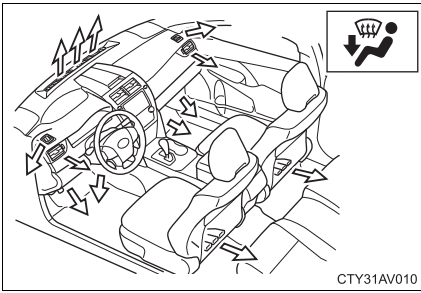

Air flows to the feet and the windshield defogger operates.

**Switching between outside air and recirculated air modes**

Press  .

The mode switches between outside air mode (introduces air from outside the vehicle) (indicator off) and recirculated air mode (recycles air inside the vehicle) (indicator on) each time the button is pressed.

**Adjusting the position of and opening and closing the air outlets**

**Front center outlets**

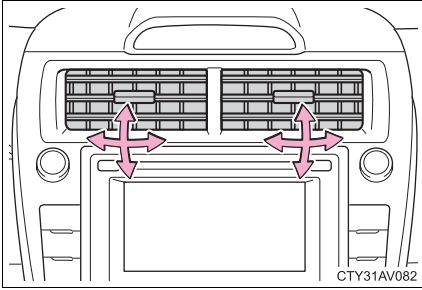

Direct air flow to the left or right, up or down.

**Front side outlets**

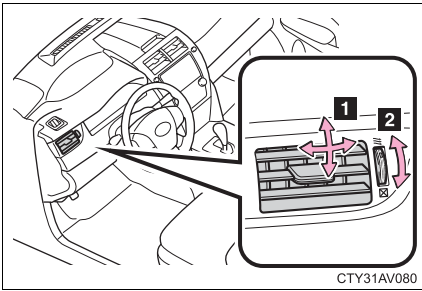

- 1** Direct air flow to the left or right, up or down.
- 2** Turn the knob to open or close the vent.

### ■ Switching between outside air and recirculated air modes

Recirculated air mode or outside air mode may be automatically switched to in accordance with the temperature setting and the inside temperature.

### ■ Fogging up of the windows

- The windows will easily fog up when the humidity in the vehicle is high.

Turning  on will dehumidify the air from the outlets and defog the windshield effectively.

- If you turn  off, the windows may fog up more easily.
- The windows may fog up if the recirculated air mode is used.

### ■ Outside/recirculated air mode

When driving on dusty roads such as tunnels or in heavy traffic, set the outside/recirculated air mode button to the recirculated air mode. This is effective in preventing outside air from entering the vehicle interior. During cooling operation, setting the recirculated air mode will also cool the vehicle interior effectively.

### ■ When the outside temperature falls to nearly 32°F (0°C)

The dehumidification function may not operate even when  is pressed.

### ■ Air conditioning odors

- During use, various odors from inside and outside the vehicle may enter into and accumulate in the air conditioning system. This may then cause odor to be emitted from the vents.
- To reduce potential odors from occurring:  
It is recommended that the air conditioning system be set to outside air mode prior to turning the vehicle off.

### ■ Air conditioning filter

→P. 382

 CAUTION

■ **To prevent the windshield from fogging up**

Do not use  during cool air operation in extremely humid weather.

The difference between the temperature of the outside air and that of the windshield can cause the outer surface of the windshield to fog up, blocking your vision.

 NOTICE

■ **To prevent battery discharge**

Do not leave the air conditioning system on longer than necessary when the engine is stopped.



### 3-1. Using the air conditioning system and defogger Automatic air conditioning system\*

**Air outlets and fan speed are automatically adjusted according to the temperature setting.**

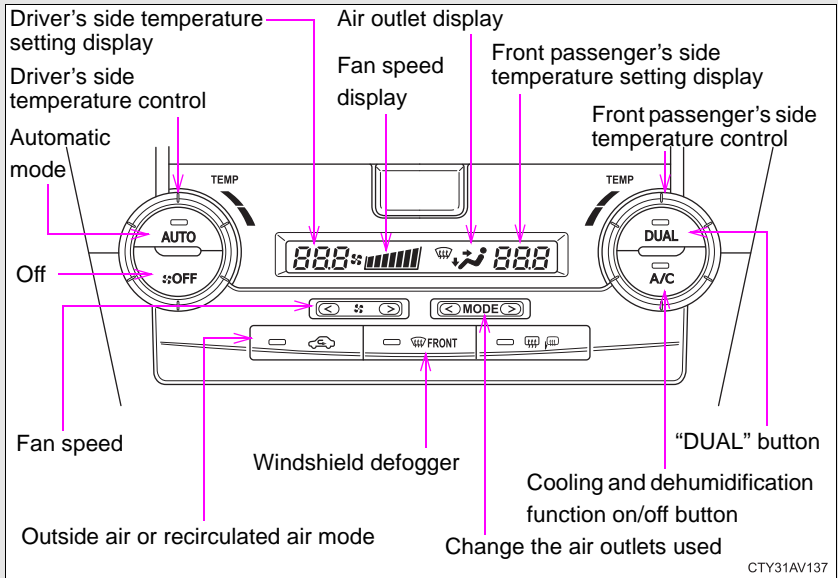



\*: If equipped



## Using the automatic air conditioning system

**STEP 1** Press .

The air conditioning system begins to operate. Air outlets and fan speed are automatically adjusted according to the temperature setting.

**STEP 2** Turn  clockwise to increase the temperature and turn

 counterclockwise to decrease the temperature.

When  is pressed (the  indicator is on) or the passenger's side temperature control dial is turned, the temperature for the driver and passenger seats can be adjusted separately.



## Adjusting the settings manually

**STEP 1** To adjust the fan speed, press ">" on  to increase the fan speed and "<" to decrease the fan speed.

Press  to turn the fan off.

**STEP 2** To adjust the temperature setting, turn  clockwise to

increase the temperature and turn  counterclockwise to decrease the temperature.

When  is pressed (the  indicator is on) or the passenger's side temperature control dial is turned, the temperature for the driver and passenger seats can be adjusted separately.

**STEP 3** To change the air outlets, press "<" or ">" on .

The air outlets used are switched each time either side of the button is pressed.

## Defogging the windshield

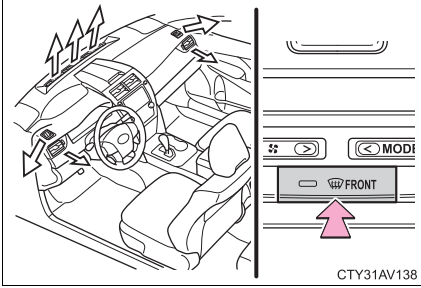

Press  .

The dehumidification function operates and fan speed increases.

Set the outside/recirculated air mode button to the outside air mode if the recirculated air mode is used. (It may switch automatically.)

To defog the windshield and the side windows early, turn the air flow and temperature up.

To return to the previous mode, press  again when the windshield is defogged.

## Air outlets and air flow

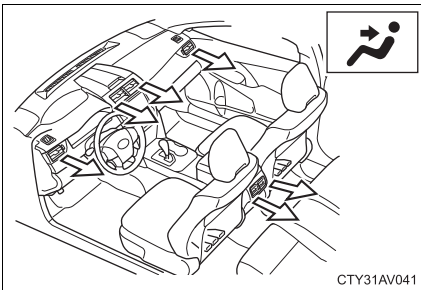

Air flows to the upper body.

### 3-1. Using the air conditioning system and defogger

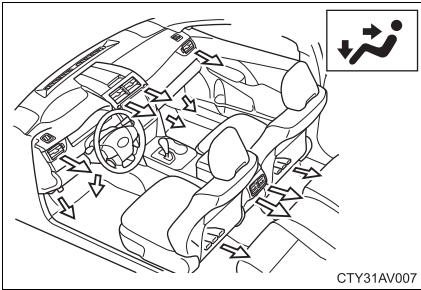

Air flows to the upper body and feet.

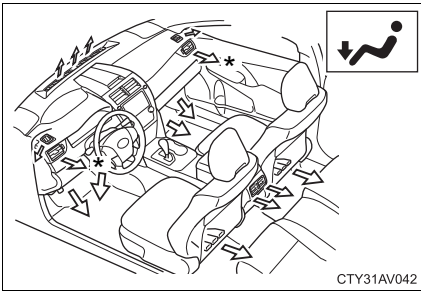

Air flows to the feet.

\*: When the warming function is operating, air flows to the upper body as well to warm the upper body effectively.

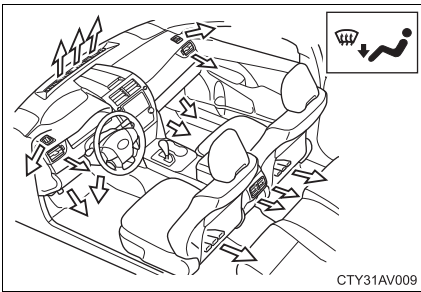

Air flows to the feet and the windshield defogger operates.

### Switching between outside air and recirculated air modes

Press .

The mode switches between outside air mode (the indicator is off) and recirculated air mode (the indicator is on) each time the button is pressed.

## Adjusting the position of and opening and closing the air outlets

### Front center outlets

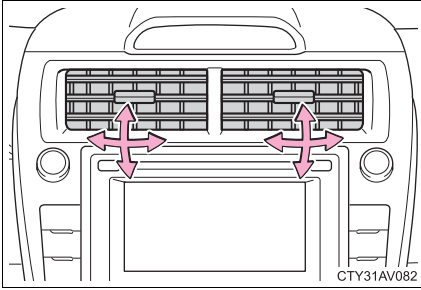

Direct air flow to the left or right, up or down.

### Front side outlets

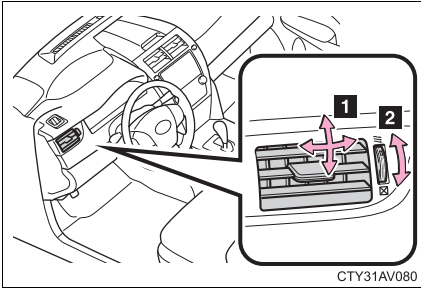

- 1 Direct air flow to the left or right, up or down.
- 2 Turn the knob to open or close the vent.

### Rear outlets

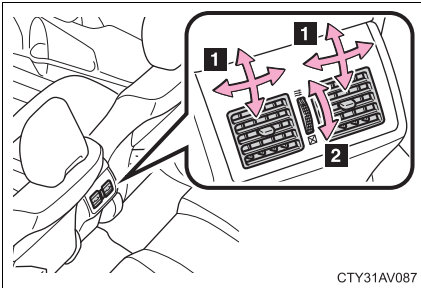

- 1 Direct air flow to the left or right, up or down.
- 2 Turn the knob to open or close the vent.

### ■ Using automatic mode

Fan speed is adjusted automatically according to the temperature setting and the ambient conditions.

Therefore, the fan may stop for a while until warm or cool air is ready to flow immediately after  is pressed.

### ■ Fogging up of the windows

- The windows will easily fog up when the humidity in the vehicle is high.

Turning  on will dehumidify the air from the outlets and defog the windshield effectively.

- If you turn  off, the windows may fog up more easily.
- The windows may fog up if the recirculated air mode is used.

### ■ Outside/recirculated air mode

- When driving on dusty roads such as tunnels or in heavy traffic, set the outside/recirculated air mode button to the recirculated air mode. This is effective in preventing outside air from entering the vehicle interior. During cooling operation, setting the recirculated air mode will also cool the vehicle interior effectively.
- Outside/recirculated air mode may automatically switch depending on the temperature setting or the inside temperature.

### ■ When the outside temperature falls to nearly 32°F (0°C)

The dehumidification function may not operate even when  is pressed.

### ■ Air conditioning odors

- During use, various odors from inside and outside the vehicle may enter into and accumulate in the air conditioning system. This may then cause odor to be emitted from the vents.
- To reduce potential odors from occurring:
  - It is recommended that the air conditioning system be set to outside air mode prior to turning the vehicle off.
  - The start timing of the blower may be delayed for a short period of time immediately after the air conditioning system is started in automatic mode.

### ■ Air conditioning filter

→P. 382

### ■ Customization that can be configured at Toyota dealer

Settings (e.g. air conditioning setting) can be changed.  
(Customizable features →P. 493)

#### CAUTION

##### ■ To prevent the windshield from fogging up

Do not use  during cool air operation in extremely humid weather. The difference between the temperature of the outside air and that of the windshield can cause the outer surface of the windshield to fog up, blocking your vision.

#### NOTICE

##### ■ To prevent battery discharge

Do not leave the air conditioning system on longer than necessary when the engine is stopped.

### 3-1. Using the air conditioning system and defogger Rear window and outside rear view mirror defoggers

Defoggers are used to defog the rear window, and to remove rain-drops, dew and frost from the outside rear view mirrors.

#### Vehicles with a manual air conditioning system

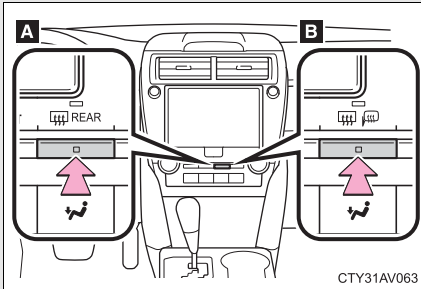

Turns the defoggers on/off

The defoggers will automatically turn off after their operation time. The operation time is between 15 minutes and 1 hour depending on the ambient temperature and vehicle speed.

**A** Vehicles without outside rear view mirror defoggers

**B** Vehicles with outside rear view mirror defoggers

#### Vehicles with an automatic air conditioning system

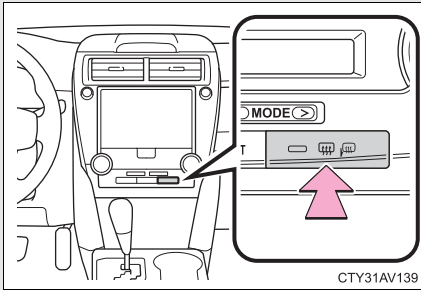

Turns the defoggers on/off

The defoggers will automatically turn off after their operation time. The operation time is between 15 minutes and 1 hour depending on the ambient temperature and vehicle speed.

#### ■ The defoggers can be operated when

##### Vehicles without a smart key system

The engine switch is in the "ON" position.

##### Vehicles with a smart key system

The "ENGINE START STOP" switch is in IGNITION ON mode.

#### ■ The outside rear view mirror defoggers (if equipped)

Turning the rear window defogger on will turn the outside rear view mirror defoggers on.



 CAUTION

■ **When the outside rear view mirror defoggers are on (if equipped)**

Do not touch the outside surface of the rear view mirrors, as they can become very hot and burn you.

## 3-2. Using the audio system

### Audio system types

#### Without navigation system and Display Audio system CD player and AM/FM radio

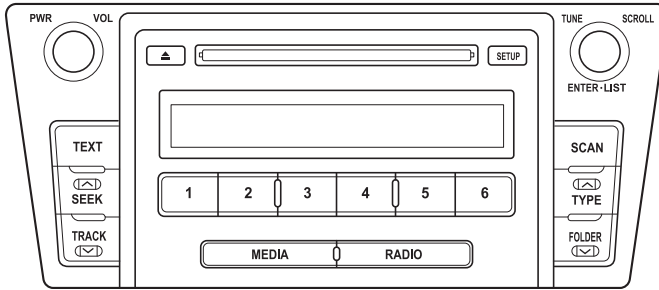

CTY32AV061

Title	Page
Using the radio	P. 248
Using the CD player	P. 251
Playing back MP3 and WMA discs	P. 257
Operating an iPod	P. 264
Operating a USB memory	P. 272
Optimal use of the audio system	P. 280
Using the AUX port	P. 283

### With Display Audio system

Owners of models equipped with a Display Audio system should refer to the “Display Audio System Owner’s Manual”.

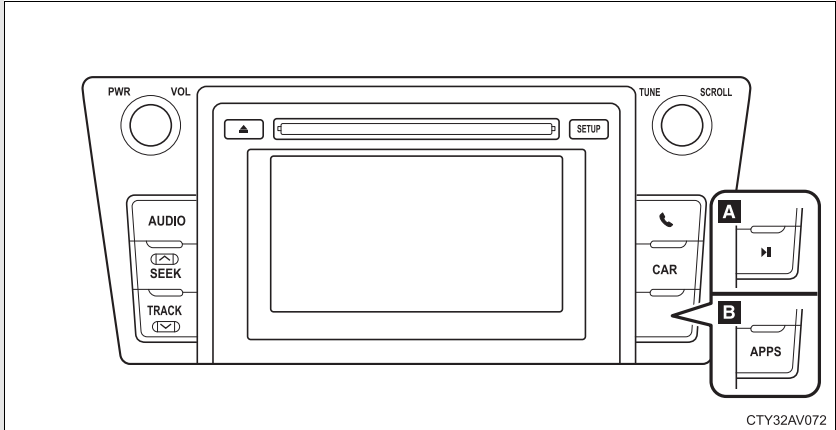

**A** Display Audio system

**B** Premium Display Audio system

### With navigation system

Owners of models equipped with a navigation system should refer to the “Navigation System Owner’s Manual”.

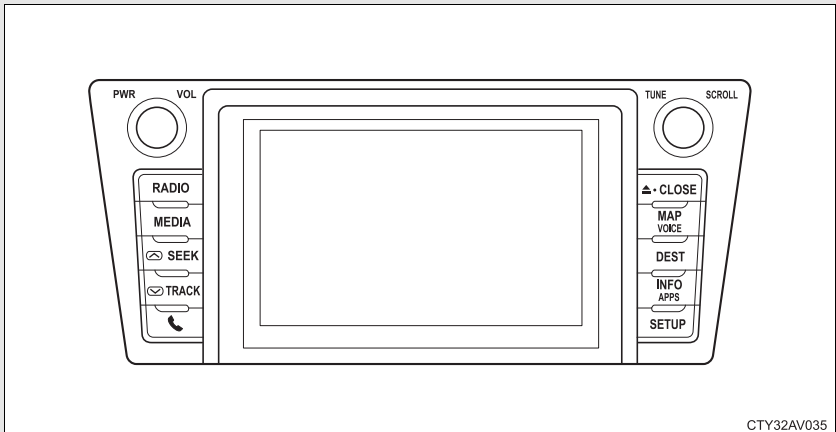

### ■ About Bluetooth® (with Display Audio system)

The Bluetooth wordmark and logo are owned by Bluetooth SIG. and permission has been granted to use the trademark of the licensee Panasonic Corporation/Pioneer Corporation. Other trademarks and trade names are owned by various different owners.

#### CAUTION

### ■ Certifications for the Bluetooth® (with Display Audio system)

FCC ID: ACJ932CQ-US70G0

IC ID: 216J-CQUS70G0

FCC ID: AJDK032

IC ID: 775E-K032

#### ● FCC WARNING:

Changes or modifications not expressly approved by the party responsible for compliance could void the user's authority to operate the equipment.

#### ● Part 15 of the FCC Rules & Industry Canada licence-exempt RSS standard(s)

- Properly shielded a grounded cables and connectors must be used for connection to host computer and/or peripherals in order to meet FCC emission limits.
- This transmitter must not be co-located or operated in conjunction with any other antenna or transmitter.
- This device complies with Part 15 of FCC Rules and Industry Canada licence-exempt RSS standard(s). Operation is subject to the following two conditions: (1) this device may not cause interference, and (2) this device must accept any interference, including interference that may cause undesired operation of this device.
- Le présent appareil est conforme aux la partie 15 des règles de la FCC et CNR d'Industrie Canada applicables aux appareils radio exempts de licence. L'exploitation est autorisée aux deux conditions suivantes : (1) l'appareil ne doit pas produire de brouillage, et (2) l'utilisateur de l'appareil doit accepter tout brouillage radioélectrique subi, même si le brouillage est susceptible d'en compromettre le fonctionnement.

 CAUTION

- This equipment complies with FCC/IC radiation exposure limits set forth for an uncontrolled environment and meets the FCC radio frequency (RF) Exposure Guidelines in Supplement C to OET65 and RSS-102 of the IC radio frequency (RF) Exposure rules. This equipment has very low levels of RF energy that it deemed to comply without maximum permissive exposure evaluation (MPE). But it is desirable that it should be installed and operated keeping the radiator at least 20 cm or more away from person's body (excluding extremities: hands, wrists, feet and ankles).
- Cet équipement est conforme aux limites d'exposition aux rayonnements énoncées pour un environnement non contrôlé et respecte les règles les radioélectriques (RF) de la FCC lignes directrices d'exposition dans le Supplément C à OET65 et d'exposition aux fréquences radioélectriques (RF) CNR-102 de l'IC. Cet équipement émet une énergie RF très faible qui est considérée conforme sans évaluation de l'exposition maximale autorisée. Cependant, cet équipement doit être installé et utilisé en gardant une distance de 20 cm ou plus entre le dispositif rayonnant et le corps (à l'exception des extrémités : mains, poignets, pieds et chevilles).
- Under Industry Canada regulations, this radio transmitter may only operate using an antenna of a type and maximum (or lesser) gain approved for the transmitter by Industry Canada. To reduce potential radio interference to other users, the antenna type and its gain should be so chosen that the equivalent isotropically radiated power (e.i.r.p.) is not more than that necessary for successful communication.
- Conformément à la réglementation d'Industrie Canada, le présent émetteur radio peut fonctionner avec une antenne d'un type et d'un gain maximal (ou inférieur) approuvé pour l'émetteur par Industrie Canada. Dans le but de réduire les risques de brouillage radioélectrique à l'intention des autres utilisateurs, il faut choisir le type d'antenne et son gain de sorte que la puissance isotrope rayonnée équivalente (p.i.r.e.) ne dépasse pas l'intensité nécessaire à l'établissement d'une communication satisfaisante.

 CAUTION

● Laser products

- Do not take this unit apart or attempt to make any changes yourself.  
This is an intricate unit that uses a laser pickup to retrieve information from the surface of compact discs. The laser is carefully shielded so that its rays remain inside the cabinet. Therefore, never try to disassemble the player or alter any of its parts since you may be exposed to laser rays and dangerous voltages.

- This product utilizes a laser.

Use of controls or adjustments or performance of procedures other than those specified herein may result in hazardous radiation exposure.

**THE USE OF OPTICAL INSTRUMENTS WITH THIS PRODUCT WILL INCREASE EYE HAZARD.**

 NOTICE

■ **To prevent battery discharge**

Do not leave the audio system on longer than necessary when the engine is stopped.

■ **To avoid damaging the audio system**

Take care not to spill drinks or other fluids over the audio system.

## 3-2. Using the audio system

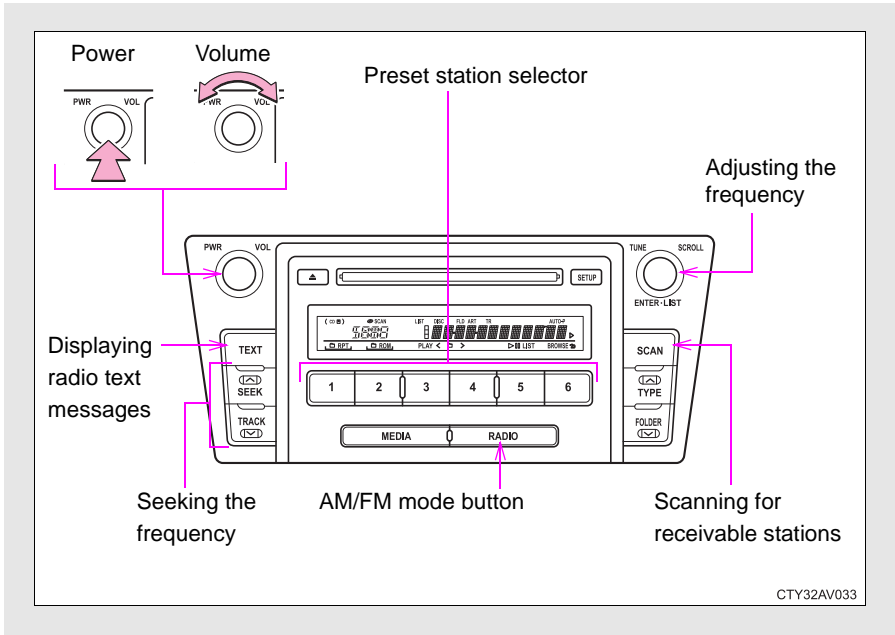

### Using the radio

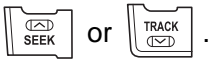

### Setting station presets

**STEP 1** Search for a desired station by turning  or pressing



**STEP 2** Press and hold a button (from  to  ) until you hear a beep.



## Scanning radio stations

### ■ Scanning the preset radio stations

**STEP 1** Press and hold  until you hear a beep.

Preset stations will be played for 5 seconds each.

**STEP 2** When the desired station is reached, press  once again.

### ■ Scanning all radio stations within range

**STEP 1** Press .

All stations with reception will be played for 5 seconds each.

**STEP 2** When the desired station is reached, press  once again.

## Switching the display

Press .

Each time  is pressed, the display changes in the following order:

Frequency → Channel name → Radio text.

### ■ Reception sensitivity

- Maintaining perfect radio reception at all times is difficult due to the continually changing position of the antenna, differences in signal strength and surrounding objects, such as trains, transmitters, etc.
- The radio antenna is mounted inside the rear window. To maintain clear radio reception, do not attach metallic window tinting or other metallic objects to the antenna wire mounted inside the rear window.

### ■ Certifications for the radio tuner

This equipment has been tested and found to comply with the limits for a class B digital device, pursuant to Part 15 of the FCC Rules. These limits are designed to provide reasonable protection against harmful interference in a residential installation. This equipment generates, uses and can radiate radio frequency energy and, if not installed and used in accordance with the instructions, may cause harmful interference to radio communications. However, there is no guarantee that interference will not occur in a particular installation.

If this equipment does cause harmful interference to radio or television reception, which can be determined by turning the equipment off and on, the user is encouraged to try to correct the interference by trying one or more of the following:

- Reorienting or relocating the receiving antenna.
- Increasing the separation between the equipment and receiver.
- Connecting the equipment into an outlet on a circuit different from that to which the receiver is connected.
- Consulting the dealer or an experienced radio/TV technician for help.

## 3-2. Using the audio system Using the CD player

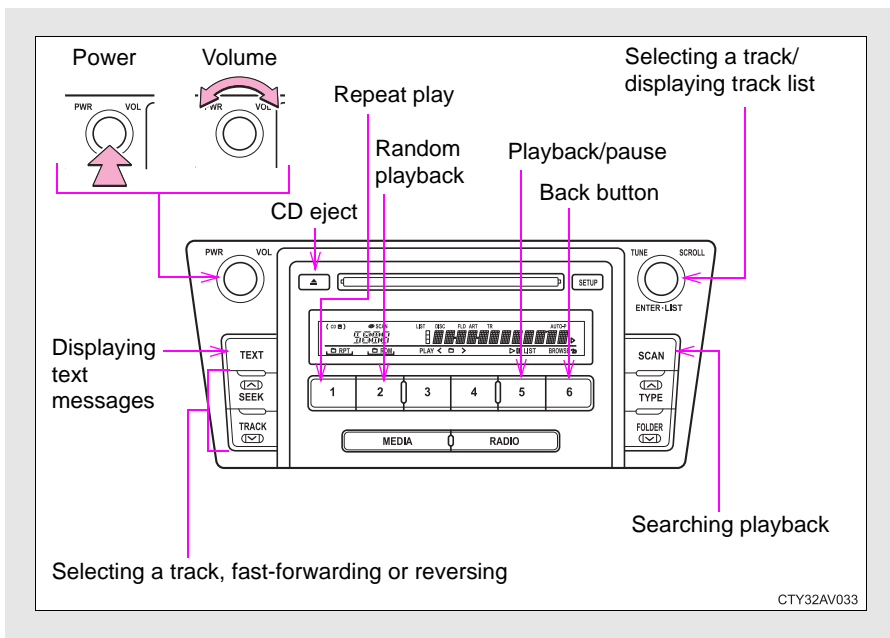



### Loading CDs

Insert a CD.

### Ejecting CDs

Press  and remove the CD.

### Selecting a track

Turn  or press  to move up or  to move down until the desired track number is displayed.

## Selecting a track from a track list

**STEP 1** Press  .

The track list will be displayed.

**STEP 2** Turn and press  to select a track.

To return to the previous display, press  (  ).

## Scanning tracks

**STEP 1** Press  .

The first 10 seconds of each track will be played.

To cancel, press  again.

**STEP 2** Press  again when the desired track is reached.

## Fast-forwarding and reversing tracks

Press and hold  or  .

## Repeat play

Press  (RPT).

The current track is played repeatedly until  (RPT) is pressed again.

## Random playback

Press  (RDM).

Tracks are played in a random order until  (RDM) is pressed again.

## Playing and pausing tracks

Press  (▶||).

## Switching the display

Press .

Each time  is pressed, the display changes in the following order:

Track no./Elapsed time → CD title → Track title → Artist name.

### ■ Display

Up to 12 characters can be displayed at a time.

If there are 13 characters or more, pressing and holding  for 1 second or more will display the remaining characters. A maximum of 24 characters can be displayed.

If  is pressed for 1 second or more again or has not been pressed for 6 seconds or more, the display will return to the first 12 characters.

Depending on the contents recorded, the characters may not be displayed properly or may not be displayed at all.

### ■ Error messages

“ERROR”: This indicates a problem either in the CD or inside the player.

“CD CHECK”: The CD may be dirty, damaged or inserted up-side down.

“WAIT”: Operation has stopped due to a high temperature inside the player. Contact your Toyota dealer if the CD still cannot be played.

### ■ Discs that can be used

Discs with the marks shown below can be used.

Playback may not be possible depending on recording format or disc features, or due to scratches, dirt or deterioration.



CDs with copy-protect features may not be used.

### ■ CD player protection feature

To protect the internal components, playback is automatically stopped when a problem is detected while the CD player is being used.

### ■ If a CD is left inside the CD player or in the ejected position for extended periods

The CD may be damaged and may not play properly.

### ■ Lens cleaners

Do not use lens cleaners. Doing so may damage the CD player.

 NOTICE

**■ CDs and adapters that cannot be used**

Do not use the following types of CDs or 3 in. (8 cm) CD adapters or Dual Disc.

Doing so may damage the CD player and/or the CD insert/eject function.

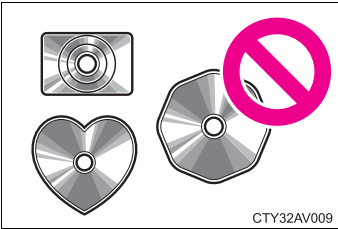

- CDs that have a diameter that is not 4.7 in. (12 cm)

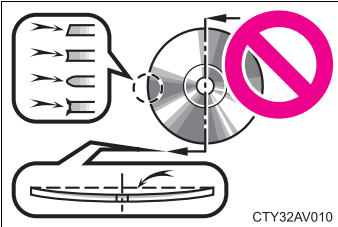

- Low-quality and deformed CDs

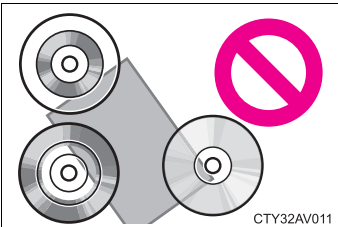

- CDs with a transparent or translucent recording area

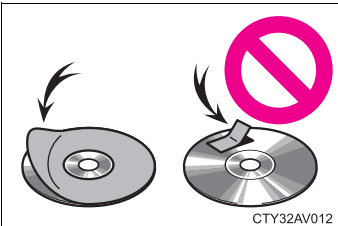

- CDs that have had tape, stickers or CD-R labels attached to them, or that have had the label peeled off

 NOTICE

■ **CD player precautions**

Failure to follow the precautions below may result in serious damage to the CDs or the player itself.

- Do not insert anything other than CDs into the CD slot.
- Do not apply oil to the CD player.
- Store CDs away from direct sunlight.
- Never try to disassemble any part of the CD player.



## Playing back MP3 and WMA discs

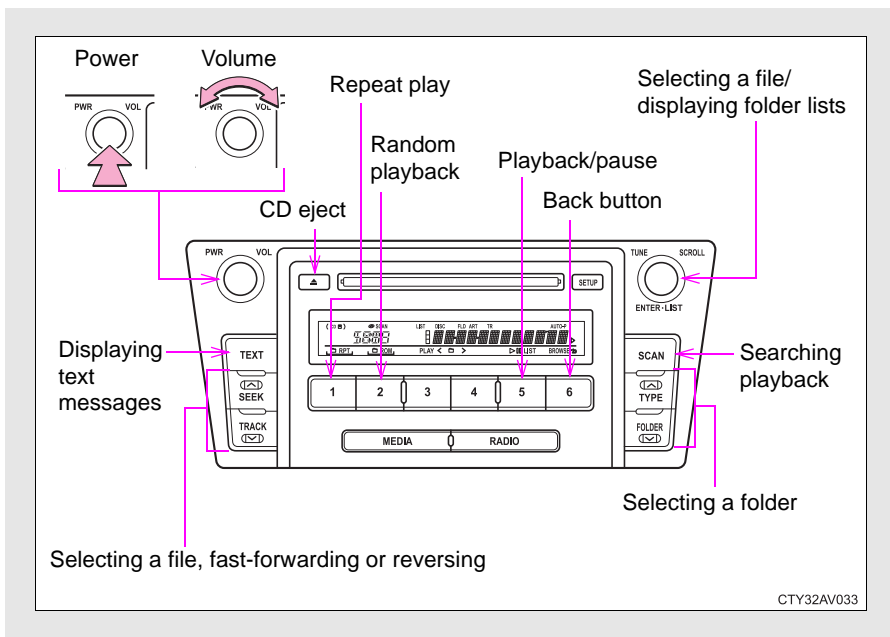



### Loading and ejecting MP3 and WMA discs

→P. 251

### Selecting and scanning a folder

#### ■ Selecting a folder

Press  or  to select the desired folder.

#### ■ Returning to the first file of the first folder

Press and hold  until you hear a beep.

### ■ Scanning the first file of all the folders

**STEP 1** Press and hold  until you hear a beep.

The first 10 seconds of the first file in each folder will be played.

**STEP 2** When the desired folder is reached, press  again.

### ■ Selecting a folder and file from folder lists

**STEP 1** Press  .

The folder list will be displayed.

**STEP 2** Turn and press  to select a folder and a file.

To return to the previous display, press  (  ).

## Selecting and scanning files

### ■ Selecting a file

Turn  or press  or  to select the desired file.

### ■ Scanning the files in a folder

**STEP 1** Press  .

The first 10 seconds of each file will be played.

**STEP 2** When the desired file is reached, press  again.

## Fast-forwarding and reversing files

Press and hold  or .

## Repeat play

Pressing  (RPT) changes modes in the following order:  
File repeat → Folder repeat\* → Off.

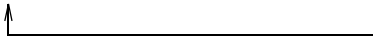

\*: Available except when RDM (random playback) is selected

## Random playback

Pressing  (RDM) changes modes in the following order:  
Folder random → Disc random → Off.

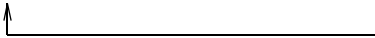

## Playing and pausing files

Press  (▶||).

## Switching the display

Press .

Each time  is pressed, the display changes in the following order:



Track no./Elapsed time → Folder name → File name → Album title (MP3 only) → Track title → Artist name.

---

■ **Display**

→P. 253

■ **Canceling random and repeat playback**

Press  (RPT) or  (RDM), or press and hold .

■ **Error messages**

“ERROR”: This indicates a problem either in the CD or inside the player.

“CD CHECK”: The CD may be dirty, damaged or inserted up-side down.

“WAIT”: Operation has stopped due to a high temperature inside the player. Contact your Toyota dealer if the CD still cannot be played.

“NO SUPPORT”: This indicates that MP3/WMA files are not included in the CD.

■ **Discs that can be used**

Discs with the marks shown below can be used.

Playback may not be possible depending on recording format or disc features, or due to scratches, dirt or deterioration.



■ **CD player protection feature**

To protect the internal components, playback is automatically stopped when a problem is detected while the CD player is being used.

■ **If a CD is left inside the CD player or in the ejected position for extended periods**

The CD may be damaged and may not play properly.

### ■ Lens cleaners

Do not use lens cleaners. Doing so may damage the CD player.

### ■ MP3 and WMA files

MP3 (MPEG Audio LAYER3) is a standard audio compression format.

Files can be compressed to approximately 1/10 of their original size by using MP3 compression.

WMA (Windows Media Audio) is a Microsoft audio compression format.

This format compresses audio data to a size smaller than that of the MP3 format.

There is a limit to the MP3 and WMA file standards and to the media/formats recorded by them that can be used.

#### ● MP3 file compatibility

- Compatible standards  
MP3 (MPEG1 LAYER3, MPEG2 LSF LAYER3)
- Compatible sampling frequencies  
MPEG1 LAYER3: 32, 44.1, 48 (kHz)  
MPEG2 LSF LAYER3: 16, 22.05, 24 (kHz)
- Compatible bit rates  
MPEG1 LAYER3: 32, 40, 48, 56, 64, 80, 96, 112, 128, 160, 192, 224, 256, 320 (kbps)  
MPEG2 LSF LAYER3: 8, 16, 24, 32, 40, 48, 56, 64, 80, 96, 112, 128, 144, 160 (kbps)  
\* Compatible with VBR
- Compatible channel modes: stereo, joint stereo, dual channel and monaural

#### ● WMA file compatibility

- Compatible standards  
WMA Ver. 7, 8, 9
- Compatible sampling frequencies  
32, 44.1, 48 (kHz)
- Compatible bit rates  
Ver. 7, 8: CBR 48, 64, 80, 96, 128, 160, 192 (kbps)  
Ver. 9: CBR 48, 64, 80, 96, 128, 160, 192, 256, 320 (kbps)  
\* Only compatible with 2-channel playback

### ● Compatible media

Media that can be used for MP3 and WMA playback are CD-Rs and CD-RWs.

Playback in some instances may not be possible, depending on the status of the CD-R or CD-RW. Playback may not be possible or the audio may jump if the disc is scratched or marked with fingerprints.

### ● Compatible disc formats

The following disc formats can be used.

- Disc formats: CD-ROM Mode 1 and Mode 2  
CD-ROM XA Mode 2, Form 1 and Form 2
- File formats: ISO9660 Level 1, Level 2, (Romeo, Joliet)  
MP3 and WMA files written in any format other than those listed above may not play correctly, and their file names and folder names may not be displayed correctly.

Items related to standards and limitations are as follows.

- Maximum directory hierarchy: 8 levels
- Maximum length of folder names/file names: 32 characters
- Maximum number of folders: 192 (including the root)
- Maximum number of files per disc: 255

### ● File names

The only files that can be recognized as MP3/WMA and played are those with the extension .mp3 or .wma.

### ● Multi-sessions

As the audio system is compatible with multi-sessions, it is possible to play discs that contain MP3 and WMA files. However, only the first session can be played.

### ● ID3 and WMA tags

ID3 tags can be added to MP3 files, making it possible to record the track title, artist name, etc.

The system is compatible with ID3 Ver. 1.0, 1.1, and Ver. 2.2, 2.3 ID3 tags. (The number of characters is based on ID3 Ver. 1.0 and 1.1.)

WMA tags can be added to WMA files, making it possible to record the track title and artist name in the same way as with ID3 tags.

### ● MP3 and WMA playback

When a disc containing MP3 or WMA files is inserted, all files on the disc are first checked. Once the file check is finished, the first MP3 or WMA file is played. To make the file check finish more quickly, we recommend you do not write in any files other than MP3 or WMA files or create any unnecessary folders.

If the discs contain a mixture of music data and MP3 or WMA format data, only music data can be played.

### ● Extensions

If the file extensions .mp3 and .wma are used for files other than MP3 and WMA files, they will be mistakenly recognized and played as MP3 and WMA files. This may result in large amounts of interference and damage to the speakers.

### ● Playback

- To play MP3 files with steady sound quality, we recommend a fixed bit rate of 128 kbps and a sampling frequency of 44.1 kHz.
- CD-R or CD-RW playback may not be possible in some instances, depending on the characteristics of the disc.
- There is a wide variety of freeware and other encoding software for MP3 and WMA files on the market, and depending on the status of the encoding and the file format, poor sound quality or noise at the start of playback may result. In some cases, playback may not be possible at all.
- When files other than MP3 or WMA files are recorded on a disc, it may take more time to recognize the disc and in some cases, playback may not be possible at all.
- Microsoft, Windows, and Windows Media are the registered trademarks of Microsoft Corporation in the U.S. and other countries.



#### NOTICE

■ **CDs and adapters that cannot be used (→P. 255)**

■ **CD player precautions (→P. 256)**

## 3-2. Using the audio system Operating an iPod

Connecting an iPod enables you to enjoy music from the vehicle speakers.

### ■ Connecting an iPod

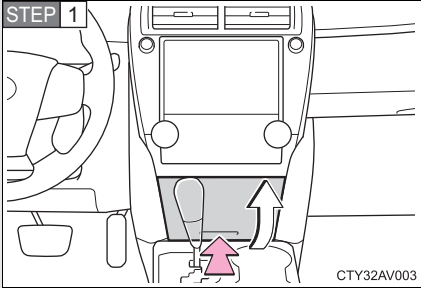

Push the lid.

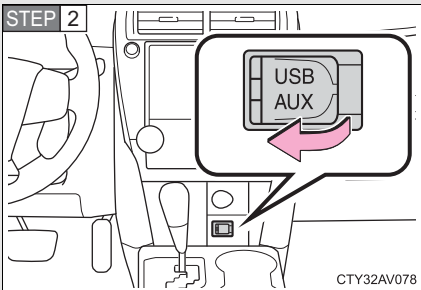

Open the cover and connect an iPod using an iPod cable.

Turn on the power of the iPod if it is not turned on.

STEP 3 Press  repeatedly until "iPod" is displayed.



■ Control panel

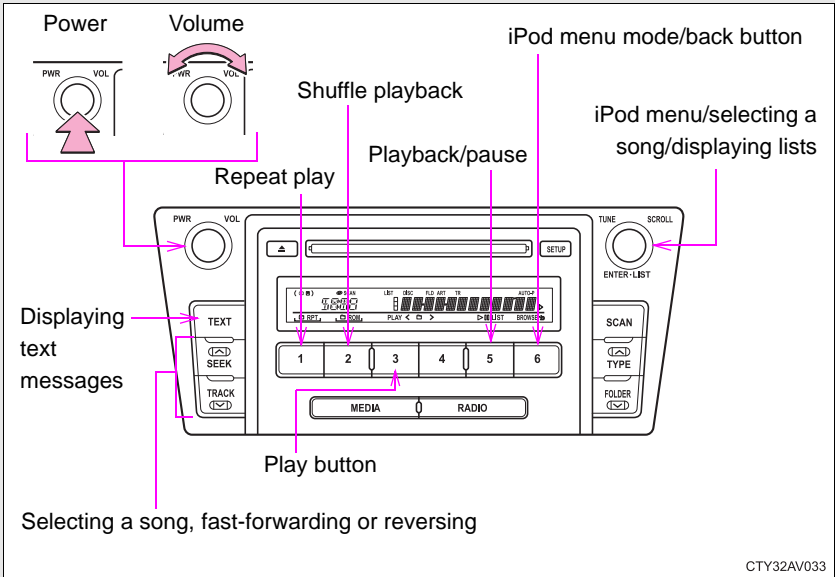

CTY32AV033

3 Interior features

**Selecting a play mode**

**STEP 1** Press  (BROWSE) to select iPod menu mode.

**STEP 2** Turning  clockwise changes the play mode in the following order:

“Playlists” → “Artists” → “Albums” → “Songs” → “Podcasts” → “Genres” → “Composers” → “Audiobooks”

**STEP 3** Press  to select the desired play mode.

Press  (PLAY) to enter the displayed selection.

## ■ Play mode list

Play mode	First selection	Second selection	Third selection	Fourth selection
“Playlists”	Playlists select	Songs select	-	-
“Artists”	Artists select	Albums select	Songs select	-
“Albums”	Albums select	Songs select	-	-
“Songs”	Songs select	-	-	-
“Podcasts”	Podcasts select	Episodes select	-	-
“Genres”	Genre select	Artists select	Albums select	Songs select
“Composers”	Composers select	Albums select	Songs select	-
“Audiobooks”	Audiobooks select	Chapter select	-	-

## ■ Selecting a list

**STEP 1** Turn  to display the first selection list.

**STEP 2** Press  to select the desired item.

Pressing the knob changes to the second selection list.

**STEP 3** Repeat the same procedure to select the desired item.

To return to the previous selection list, press  (  ).

## Selecting songs

Turn  or press  or  to select the desired song.

## Selecting a song from the song list

**STEP 1** Press  .

The song list will be displayed.

**STEP 2** Turn  to select a song.

**STEP 3** Press  to play the song.

To return to the previous display, press  (  ).

## Fast-forwarding and reversing songs

Press and hold  or  .

## Repeat play

Press  (RPT).

To cancel, press  (RPT) again.

## Shuffle playback

Pressing  (RDM) changes modes in the following order:

Track shuffle → Album shuffle → Off.



## Playing and pausing songs

Press  (>||).

## Switching the display

Press  .

Each time  is pressed, the display changes in the following order:

Track no./Elapsed time → Album name → Track title → Artist name.

### ■ About iPod

Made for



iPod



iPhone

- “Made for iPod” and “Made for iPhone” mean that an electronic accessory has been designed to connect specifically to iPod, or iPhone, respectively, and has been certified by the developer to meet Apple performance standards.

- Apple is not responsible for the operation of this device or its compliance with safety and regulatory standards. Please note that the use of this accessory with iPod or iPhone may affect wireless performance.
- iPhone, iPod, iPod classic, iPod nano and iPod touch are trademarks of Apple Inc., registered in the U.S. and other countries.

### ■ iPod functions

- When an iPod is connected and the audio source is changed to iPod mode, the iPod will resume play from the same point in which it was last used.
- Depending on the iPod that is connected to the system, certain functions may not be available. If a function is unavailable due to a malfunction (as opposed to a system specification), disconnecting the device and reconnecting it once again may resolve the problem.
- While connected to the system, the iPod cannot be operated with its own controls. It is necessary to use the controls of the vehicle's audio system instead.
- When the battery level of an iPod is very low, the iPod may not operate. If so, charge the iPod before use.
- Supported models (→P. 270)

### ■ iPod problems

To resolve most problems encountered when using your iPod, disconnect your iPod from the vehicle iPod connection and reset it. For instructions on how to reset your iPod, refer to your iPod Owner's Manual.

### ■ Display

→P. 253

### ■ Error messages

- “ERROR 1”: This indicates that the data in the iPod cannot be read.
- “ERROR 3”: This indicates that the iPod may be malfunctioning.
- “ERROR 4”: This indicates that an over current error has occurred.
- “ERROR 5”: This indicates that an iPod communication error has occurred.
- “ERROR 6”: This indicates that an authentication error has occurred.
- “NO SONGS”: This indicates that there is no music data in the iPod.
- “NO PLAYLISTS”: This indicates that some available songs are not found in a selected playlist.
- “UPDATE”: This indicates that the version of the iPod is not compatible. Upgrade your iPod software to the latest version.

### ■ Compatible models

The following iPod®, iPod nano®, iPod classic®, iPod touch® and iPhone® devices can be used with this system.

#### ● Made for

- iPod touch (4th generation)
- iPod touch (3rd generation)
- iPod touch (2nd generation)
- iPod touch (1st generation)
- iPod classic
- iPod with video
- iPod nano (6th generation)
- iPod nano (5th generation)
- iPod nano (4th generation)
- iPod nano (3rd generation)
- iPod nano (2nd generation)
- iPod nano (1st generation)
- iPhone 4
- iPhone 3GS
- iPhone 3G
- iPhone

Depending on differences between models or software versions etc., some models might be incompatible with this system.

Items related to standards and limitations are as follows:

- Maximum number of lists in device: 9999
- Maximum number of songs in device: 65535
- Maximum number of songs per list: 65535

### CAUTION

#### ■ Caution while driving

Do not connect iPod or operate the controls.

### NOTICE

#### ■ If the auxiliary box lid cannot be fully closed

Depending on the size and shape of the iPod that is connected to the system, the auxiliary box lid may not close fully. In this case, do not forcibly close the lid as this may damage the iPod or the terminal, etc.

#### ■ To prevent damage to iPod

- Do not leave iPod in the vehicle. The temperature inside the vehicle may become high, resulting in damage to the iPod.
- Do not push down on or apply unnecessary pressure to the iPod while it is connected as this may damage the iPod or its terminal.
- Do not insert foreign objects into the port as this may damage the iPod or its terminal.

## 3-2. Using the audio system

### Operating a USB memory

Connecting a USB memory enables you to enjoy music from the vehicle speakers.

#### ■ Connecting a USB memory

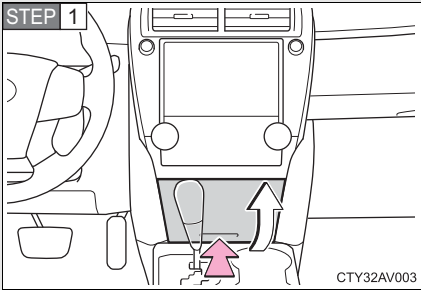

Push the lid.

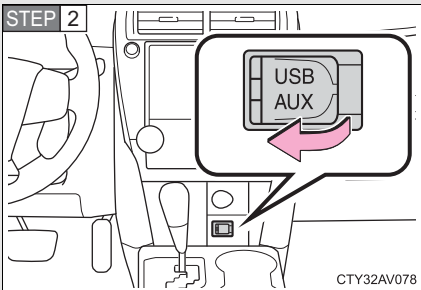

Open the cover and connect a USB memory.

Turn on the power of the USB memory if it is not turned on.

**STEP 3** Press  repeatedly until "USB" is displayed.



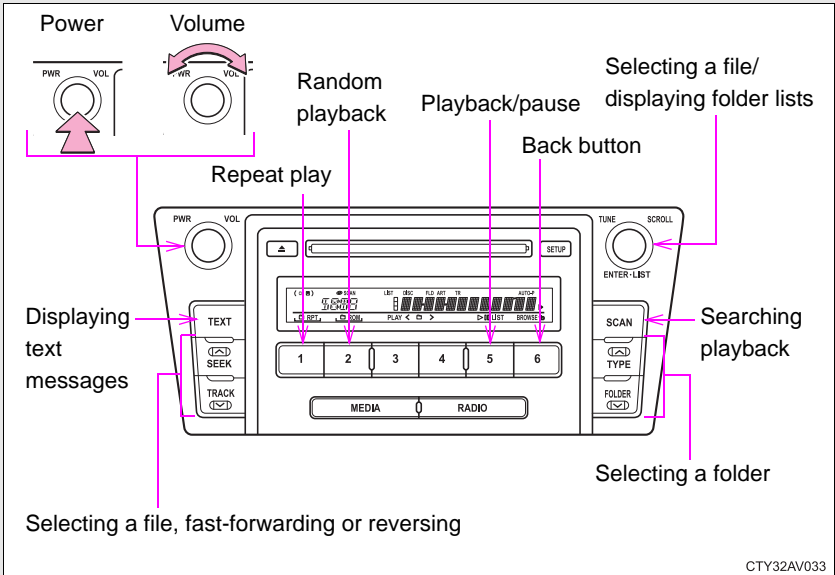

### ■ Control panel



3 Interior features

## Selecting and scanning a folder

### ■ Selecting a folder

Press  or  to select the desired folder.

### ■ Returning to the first file of the first folder

Press and hold  until you hear a beep.

### ■ Scanning the first file of all the folders

**STEP 1** Press and hold  until you hear a beep.

The first 10 seconds of the first file in each folder will be played.

**STEP 2** When the desired folder is reached, press  again.

### ■ Selecting from folder lists and file lists

**STEP 1** Press  .

The folder list will be displayed.

**STEP 2** Turn and press  to select a folder and a file.

To return to the previous display, press  (  ).

## Selecting and scanning files

### ■ Selecting a file

Turn  or press  or  to select the desired file.

### ■ Scanning the files in a folder

**STEP 1** Press  .

The first 10 seconds of each file will be played.

**STEP 2** When the desired file is reached, press  again.

## Fast-forwarding and reversing files

Press and hold  or .

## Repeat play

Pressing  (RPT) changes modes in the following order:  
File repeat → Folder repeat\* → Off.



\*: Available except when RDM (random playback) is selected

## Random playback

Pressing  (RDM) changes modes in the following order:  
1 folder random → All folders random → Off.



## Playing and pausing files

Press  (▶||).

## Switching the display

Press .

Each time  is pressed, the display changes in the following order:

Track no./Elapsed time → Folder name → File name → Album title (MP3 only) → Track title → Artist name.

### ■ USB memory functions

- Depending on the USB memory that is connected to the system, the device itself may not be operable and certain functions may not be available. If the device is inoperable or a function is unavailable due to a malfunction (as opposed to a system specification), disconnecting the device and reconnecting it once again may resolve the problem.
- If the USB memory still does not begin operation after being disconnected and reconnected, format the memory.

### ■ Display

→P. 253

### ■ Error messages

“ERROR”: This indicates a problem in the USB memory or its connection.

“NO MUSIC”: This indicates that no MP3/WMA files are included in the USB memory.

### ■ USB memory

- Compatible devices

USB memory that can be used for MP3 and WMA playback

- Compatible device formats

The following device formats can be used:

- USB communication formats: USB2.0 FS (12 Mbps)
- File formats: FAT12/16/32 (Windows)
- Correspondence class: Mass storage class

MP3 and WMA files written in any format other than those listed above may not play correctly, and their file names and folder names may not be displayed correctly.

Items related to standards and limitations are as follows:

- Maximum directory hierarchy: 8 levels
- Maximum number of folders in a device: 999 (including the root)
- Maximum number of files in a device: 9999
- Maximum number of files per folder: 255

- MP3 and WMA files

MP3 (MPEG Audio LAYER 3) is a standard audio compression format.

Files can be compressed to approximately 1/10 of their original size using MP3 compression.

WMA (Windows Media Audio) is a Microsoft audio compression format.

This format compresses audio data to a size smaller than that of the MP3 format.

There is a limit to the MP3 and WMA file standards that can be used and to the media/formats on which the files are recorded.

- MP3 file compatibility

- Compatible standards
  - MP3 (MPEG1 AUDIO LAYERIII, MPEG2 AUDIO LAYERIII, MPEG2.5)
- Compatible sampling frequencies
  - MPEG1 AUDIO LAYERIII: 32, 44.1, 48 (kHz)
  - MPEG2 AUDIO LAYERIII: 16, 22.05, 24 (kHz)
  - MPEG2.5: 8, 11.025, 12 (kHz)
- Compatible bit rates (compatible with VBR)
  - MPEG1 AUDIO LAYERII, III: 32-320 (kbps)
  - MPEG2 AUDIO LAYERII, III: 8-160 (kbps)
  - MPEG2.5: 8-160 (kbps)
- Compatible channel modes: stereo, joint stereo, dual channel and monaural

- WMA file compatibility

- Compatible standards
  - WMA Ver. 7, 8, 9
- Compatible sampling frequencies
  - HIGH PROFILE 32, 44.1, 48 (kHz)
- Compatible bit rates
  - HIGH PROFILE 48-320 (kbps, CBR)

- File names

The only files that can be recognized as MP3/WMA and played are those with the extension .mp3 or .wma.

### ● ID3 and WMA tags

ID3 tags can be added to MP3 files, making it possible to record the track title, artist name, etc.

The system is compatible with ID3 Ver. 1.0, 1.1, and Ver. 2.2, 2.3, 2.4 ID3 tags. (The number of characters is based on ID3 Ver. 1.0 and 1.1.)

WMA tags can be added to WMA files, making it possible to record the track title and artist name in the same way as with ID3 tags.

### ● MP3 and WMA playback

- When a device containing MP3 or WMA files is connected, all files in the USB memory are checked. Once the file check is finished, the first MP3 or WMA file is played. To make the file check finish more quickly, we recommend that you do not include any files other than MP3 or WMA files or create any unnecessary folders.
- When the USB memory is connected and the audio source is changed to USB memory mode, the USB memory will start playing the first file in the first folder. If the same device is removed and reinserted (and the contents have not been changed), the USB memory will resume play from the same point in which it was last used.

### ● Extensions

If the file extensions .mp3 and .wma are used for files other than MP3 and WMA files, they will be skipped (not played).

### ● Playback

- To play MP3 files with steady sound quality, we recommend a fixed bit rate of at least 128 kbps and a sampling frequency of 44.1 kHz.
- There is a wide variety of freeware and other encoding software for MP3 and WMA files on the market, and depending on the status of the encoding and the file format, poor sound quality or noise at the start of playback may result. In some cases, playback may not be possible at all.
- Microsoft, Windows, and Windows Media are registered trademarks of Microsoft Corporation in the U.S.A. and other countries.

### CAUTION

#### ■ Caution while driving

Do not connect USB memory or operate the controls.

 NOTICE**■ If the auxiliary box lid cannot be fully closed**

Depending on the size and shape of the USB memory that is connected to the system, the auxiliary box lid may not close fully. In this case, do not forcibly close the lid as this may damage the USB memory or the terminal, etc.

**■ To prevent damage to USB memory**

- Do not leave USB memory in the vehicle. The temperature inside the vehicle may become high, resulting in damage to the player.
- Do not push down on or apply unnecessary pressure to the USB memory while it is connected as this may damage the USB memory or its terminal.
- Do not insert foreign objects into the port as this may damage the USB memory or its terminal.

## 3-2. Using the audio system

# Optimal use of the audio system

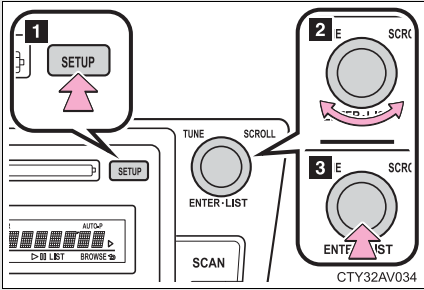

- 1 Displays the current mode
- 2 Changes the following setting
  - Sound quality and volume balance (→P. 281)The sound quality and balance setting can be changed to produce the best sound.
- 3 Selecting the mode

- Automatic Sound Levelizer (→P. 281)

### Using the audio control function

#### ■ Changing sound quality modes

**STEP 1** Press  .

**STEP 2** Turn  to select “SOUND”.

**STEP 3** Press  .

**STEP 4** Turn  to select the desired mode.

“BAS”, “TRE”, “FAD”, “BAL”, or “ASL”

**STEP 5** Press  .



## ■ Adjusting sound quality

Turning  adjusts the level.

Sound quality mode	Mode displayed	Level	Turn to the left	Turn to the right
Bass*	"BAS"	-5 to 5	Low	High
Treble*	"TRE"	-5 to 5		
Front/rear volume balance	"FAD"	F7 to R7	Shifts to rear	Shifts to front
Left/right volume balance	"BAL"	L7 to R7	Shifts to left	Shifts to right

\*: The sound quality level is adjusted individually in each audio mode.

## ■ Adjusting the Automatic Sound Levelizer (ASL)

When ASL is selected, turn  to select the desired mode.

Once the desired mode has been selected, press .

"ASL LOW", "ASL MID", "ASL HIGH", or "ASL OFF"

ASL automatically adjusts the volume and tone quality according to vehicle speed.

■ **Trademark owned by SRS Labs, Inc.**



The audio systems utilize SRS FOCUS<sup>®</sup> and SRS TruBass<sup>®</sup> audio enhancement technologies, under license from SRS Labs, Inc., in all modes except AM radio mode.

FOCUS, TruBass, SRS and  symbol are trademarks of SRS Labs, Inc.

FOCUS and TruBass technologies are incorporated under license from SRS Labs, Inc.

TruBass<sup>®</sup> enhances the perception of bass frequencies to provide deep, rich bass response from any size speaker.

SRS FOCUS<sup>®</sup> raises the audio image from non-optimally placed speakers up to the natural listening height at ear level.

## 3-2. Using the audio system

### Using the AUX port

This port can be used to connect a portable audio device and listen to it through the vehicle's speakers.

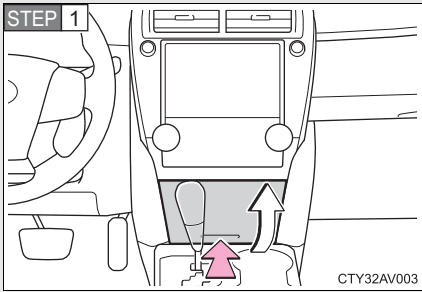

Push the lid.

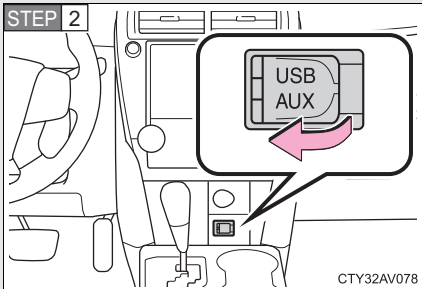

Open the cover and connect the portable audio device.

STEP 3 Press  repeatedly until "AUX" is displayed.

#### ■ Operating portable audio devices connected to the audio system

The volume can be adjusted using the vehicle's audio controls. All other adjustments must be made on the portable audio device itself.

#### ■ When using a portable audio device connected to the power outlet

Noise may occur during playback. Use the power source of the portable audio device.

 NOTICE

■ **If the auxiliary box lid cannot be fully closed**

Depending on the size and shape of the portable audio device that is connected to the system, the auxiliary box lid may not close fully. In this case, do not forcibly close the lid as this may damage the portable audio device or the terminal, etc.

### 3-3. Using the interior lights

## Interior lights list

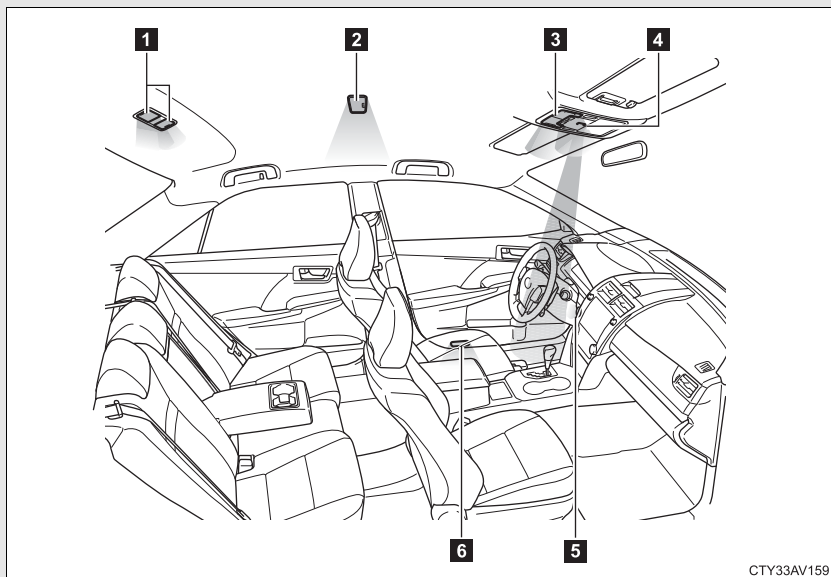

- 1** Interior/rear personal lights (vehicles with moon roof)  
(→P. 286, 287)
- 2** Interior light (vehicles without moon roof) (→P. 286)
- 3** Interior/front personal lights (vehicles with moon roof) or personal lights (vehicles without moon roof) (→P. 286, 287)
- 4** Shift lever light (when the tail lights are on) (vehicles with moon roof)
- 5** Engine switch light (vehicles without a smart key system)/  
“ENGINE START STOP” switch light (vehicles with a smart key system)
- 6** Door courtesy lights

## Interior lights

### Vehicles without moon roof

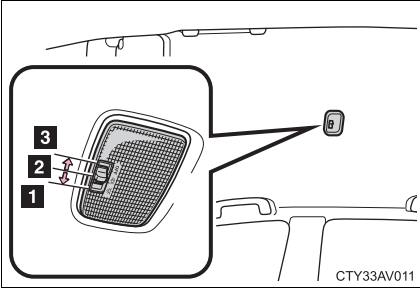

- 1 Turns the lights on
- 2 Turns the door position on
- 3 Turns the lights off

### Vehicles with moon roof

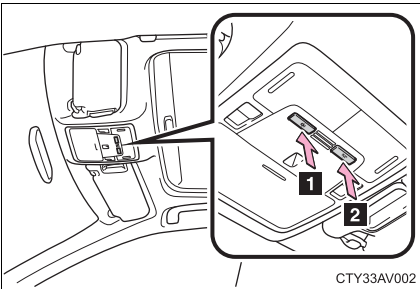

- 1 Turns the lights on/off linked to door positions.
- 2 Turns the lights on/off

**Personal lights**

**Front**

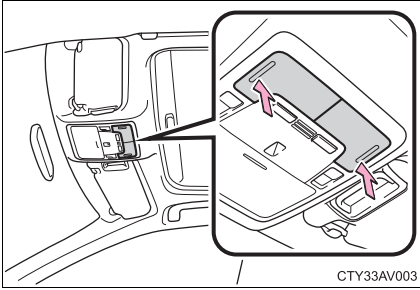

Turns the lights on/off

**Rear (vehicles with moon roof)**

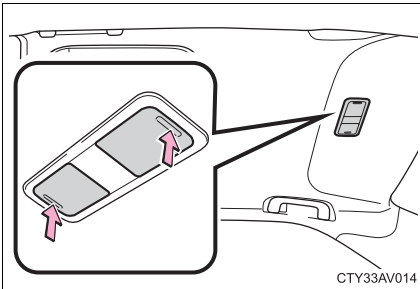

Turns the lights on/off

---

**■ Illuminated entry system****Vehicles without a smart key system**

The lights automatically turn on/off according to the engine switch position, whether the doors are locked/unlocked, and whether the doors are open/closed.

**Vehicles with a smart key system**

The lights automatically turn on/off according to “ENGINE START STOP” switch mode, the presence of the electronic key, whether the doors are locked/unlocked, and whether the doors are open/closed.

**■ To prevent battery discharge****Vehicles without a smart key system**

If the interior lights, personal lights and/or door courtesy lights are left on when the engine switch is turned to the “LOCK” position, the lights will go off automatically after 20 minutes.

**Vehicles with a smart key system**

If the interior lights, personal lights and/or door courtesy lights are left on when the “ENGINE START STOP” switch is turned off, the lights will go off automatically after 20 minutes.

**■ Customization that can be configured at Toyota dealer**

Settings (e.g. the time elapsed before lights turn off) can be changed.  
(Customizable features →P. 493)



## 3-4. Using the storage features

### List of storage features

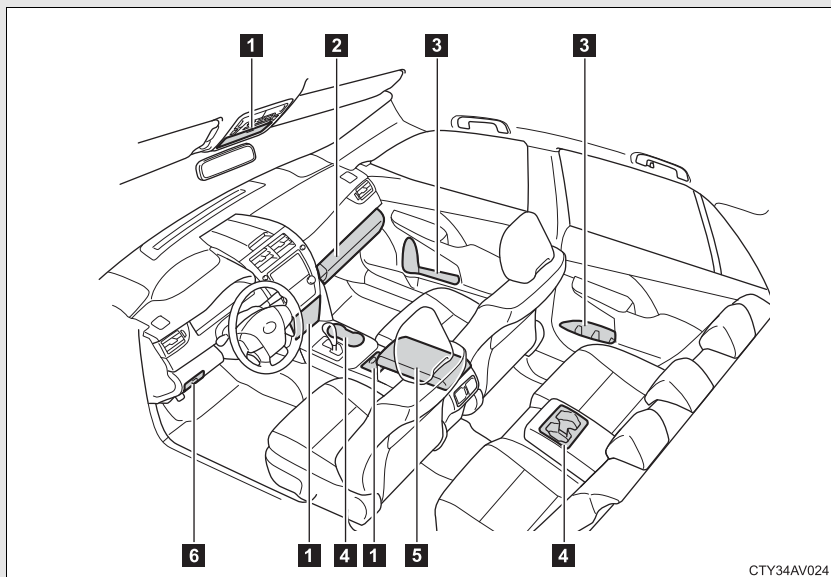

- 1** Auxiliary boxes
- 2** Glove box
- 3** Bottle holders/door pockets
- 4** Cup holders
- 5** Console box
- 6** Coin holder

#### CAUTION

##### ■ Items that should not be left in the storage spaces

Do not leave glasses, lighters or spray cans in the storage spaces, as this may cause the following when cabin temperature becomes high:

- Glasses may be deformed by heat or cracked if they come into contact with other stored items.
- Lighters or spray cans may explode. If they come into contact with other stored items, the lighter may catch fire or the spray can may release gas, causing a fire hazard.

**Glove box**

The glove box can be opened by pressing the lock release button, locked and unlocked using the master key (vehicles without a smart key system) or the mechanical key (vehicles with a smart key system).

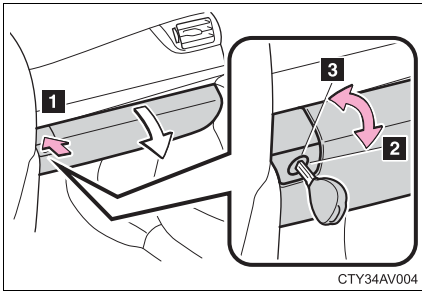

- 1** Open
- 2** Lock
- 3** Unlock

**! CAUTION****■ Caution while driving**

Keep the glove box closed. In the event of sudden braking or sudden swerving, an accident may occur due to an occupant being struck by the open glove box or the items stored inside.

## Console box

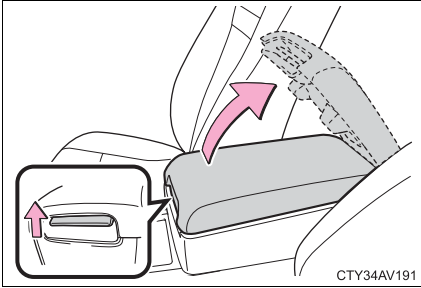

Lift the lid while pulling up the lever to release the lock.

### ■ When using the console box lid as an armrest

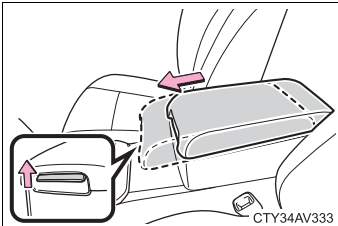

Slide the console box lid forward as needed. Slide the lid forward while pulling up the lever.

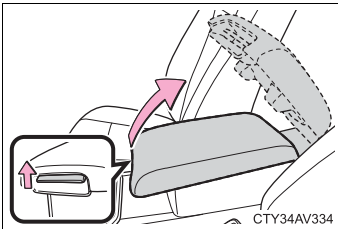

The lid can also be opened from the forwardmost position.

## ⚠ CAUTION

### ■ Caution while driving

Keep the console box closed. In the event of sudden braking, an accident may occur due to an occupant being struck by the open console box or the items stored inside.

## Coin holder

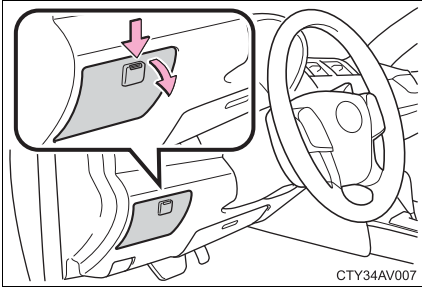

Pull the lid down while pressing down the button.

### CAUTION

#### Caution while driving

Keep the coin holder closed. In the event of sudden braking, an accident may occur due to an occupant being struck by the open coin holder or the items stored inside.

## Bottle holders

### Front

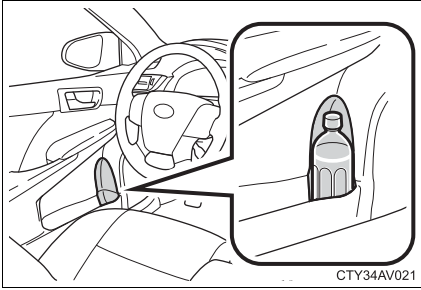

### Rear

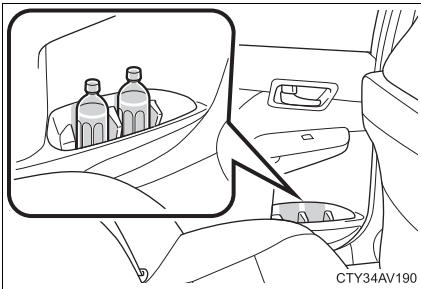

#### ■ When using the holder as a bottle holder

- When storing a bottle, close the cap.
- The bottle may not be stored depending on its size or shape.

#### ▲ CAUTION

#### ■ Items unsuitable for the bottle holder

Do not place anything other than a bottle in the bottle holders. Other items may be thrown out of the holders in the event of an accident or sudden braking and cause injury.

**⚠ NOTICE****■ Items that should not be stowed in the bottle holders**

Put the cap on before stowing a bottle. Do not place open bottles in the bottle holders, or glasses and paper cups containing liquid. The contents may spill and glasses may break.

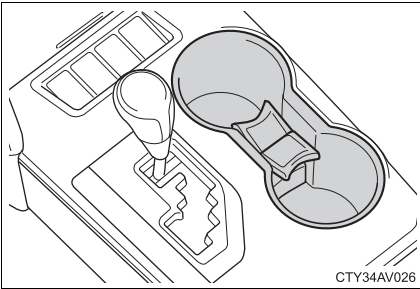
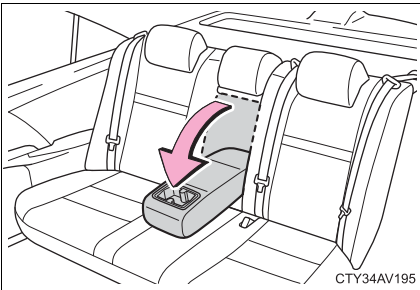
**Cup holders****Front****Rear**

Pull the armrest down.

### ■ Cup holder insert

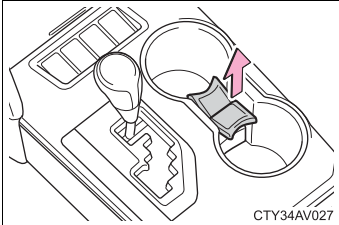

Cup holder insert can be removed.

### ⚠ CAUTION

#### ■ Items unsuitable for the cup holder

Do not place anything other than cups or aluminum cans in the cup holders. Other items may be thrown out of the holders in the event of an accident or sudden braking, causing injury. If possible, cover hot drinks to prevent burns.

**Auxiliary boxes**

**Type A**

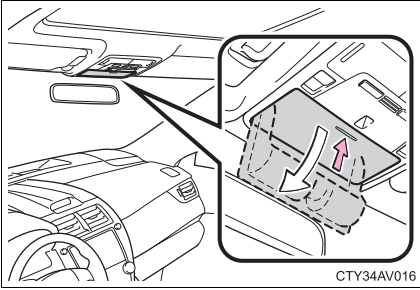

Push the lid.

**Type B**

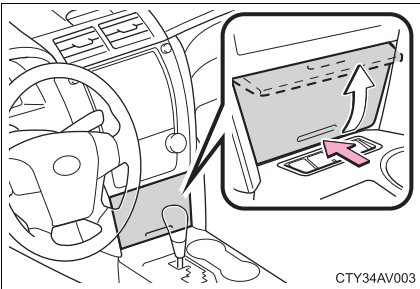

Push the lid.

**Type C (if equipped)**

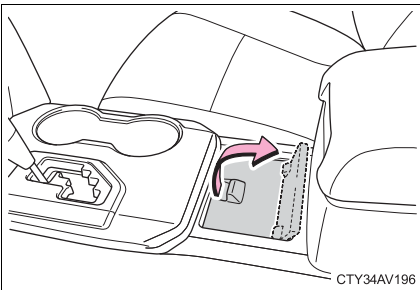

Lift the lid.



 **CAUTION****■ Caution while driving**

Keep the auxiliary boxes closed. In the event of sudden braking, an accident may occur due to an occupant being struck by an open auxiliary box or the items stored inside.

**■ Items unsuitable for storing (type A only)**

Do not store items heavier than 0.4 lb. (0.2 kg).

Doing so may cause the auxiliary box to open and the items inside may fall out, resulting in an accident.

## Sun visors

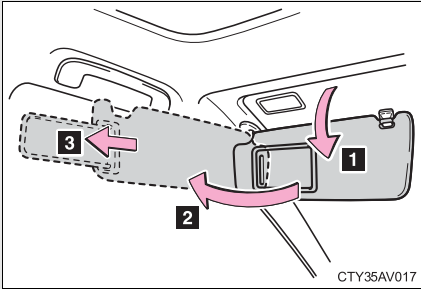

- 1** To set the visor in the forward position, flip it down.
- 2** To set the visor in the side position, flip down, unhook, and swing it to the side.
- 3** To use the side extender, place the visor in the side position, then slide it backward.

## Vanity mirrors

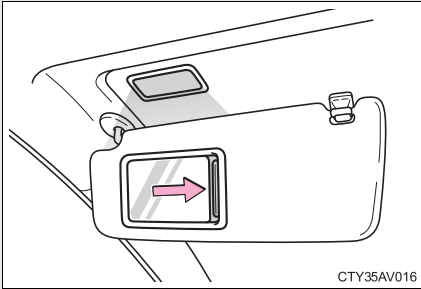

Slide the cover to open.

Vehicles with vanity lights: The light turns on when the cover is opened.

### ■ To prevent battery discharge (vehicles with vanity lights)

If the vanity lights remain on for 20 minutes while the engine is off, the lights will turn off automatically.

## Clock

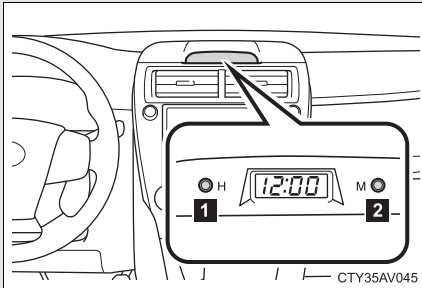

- 1** Adjusts the hours
- 2** Adjusts the minutes

### ■ The clock is displayed when

#### **Vehicles without a smart key system**

The engine switch is in the “ACC” or “ON” position.

#### **Vehicles with a smart key system**

The “ENGINE START STOP” switch is in ACCESSORY or IGNITION ON mode.

### ■ When disconnecting and reconnecting battery terminals

The time display will automatically be set to 1:00.

## Outside temperature display

The temperature display shows temperatures within the range of  $-40^{\circ}\text{F}$  ( $-40^{\circ}\text{C}$ ) and  $122^{\circ}\text{F}$  ( $50^{\circ}\text{C}$ ).

### Type A

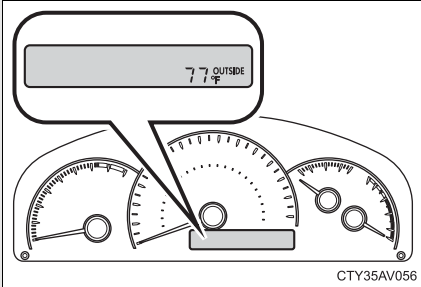

### Type B

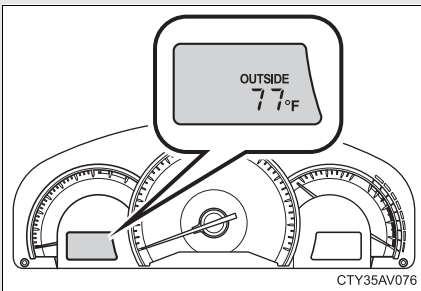

#### ■ The outside temperature is displayed when

##### **Vehicles without a smart key system**

The engine switch is in the "ON" position.

##### **Vehicles with a smart key system**

The "ENGINE START STOP" switch is in IGNITION ON mode.

■ **Display**

In the following situations, the correct outside temperature may not be displayed, or the display may take longer than normal to change:

- When the vehicle is stopped, or moving at low speeds (less than 16 mph [25 km/h])
- When the outside temperature has changed suddenly (at the entrance/exit of a garage, tunnel, etc.)

■ **When “E” is displayed**

The system may be malfunctioning. Take your vehicle to your Toyota dealer.

## Ashtray\*

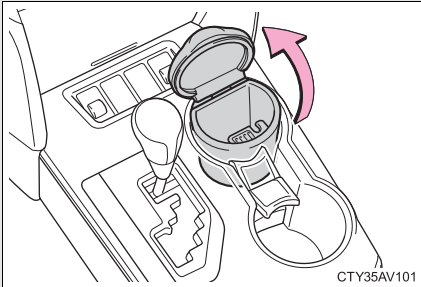

An ashtray can be installed in the cup holder. (→P. 294)

### CAUTION

#### ■ When not in use

Keep the ashtray closed. In the event of sudden braking, an accident may occur due to an occupant being struck by the open ashtray or ash flying out.

#### ■ To prevent fire

- Fully extinguish matches and cigarettes before putting them in the ashtray, then make sure the ashtray is fully closed.
- Do not place paper or any other type of flammable object in the ashtray.

## 3-5. Other interior features

### Power outlets

The power outlet can be used for 12 V accessories that run on less than 10 A.

#### Instrument cluster

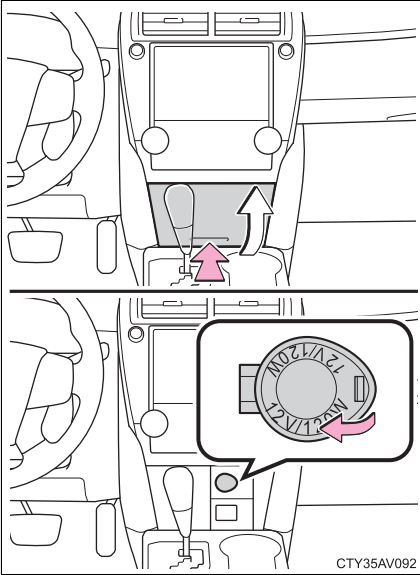



### Center console (if equipped)

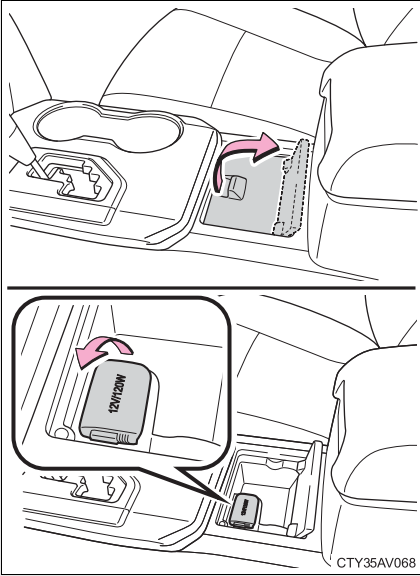

#### ■ The power outlet can be used when

##### **Vehicles without a smart key system**

The engine switch is in the “ACC” or “ON” position.

##### **Vehicles with a smart key system**

The “ENGINE START STOP” switch is in ACCESSORY or IGNITION ON mode.



## NOTICE

■ **To avoid damaging the power outlet**

Close the power outlet lid when the power outlet is not in use.

Foreign objects or liquids that enter the power outlet may cause a short circuit.

■ **To prevent blown fuse**

Do not use an accessory that uses more than 12 V 10 A.

■ **To prevent battery discharge**

Do not use the power outlet longer than necessary when the engine is not running.

## Seat heaters\*

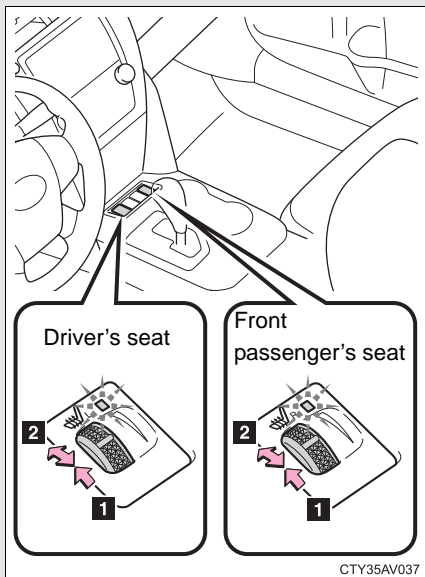

**1** On

The indicator light comes on.

**2** Adjusts the seat temperature

The further you move the dial forward, the warmer the seat becomes.

■ **The seat heaters can be used when**

**Vehicles without a smart key system**

The engine switch is in the "ON" position.

**Vehicles with a smart key system**

The "ENGINE START STOP" switch is in IGNITION ON mode.

■ **When not in use**

Move the dial fully backward. The indicator light turns off.

\*: If equipped

 **CAUTION**

■ **Burns**

- Use caution when seating the following persons in a seat with the seat heater on to avoid the possibility of burns:
  - Babies, small children, the elderly, the sick and the physically challenged
  - Persons with sensitive skin
  - Persons who are fatigued
  - Persons who have taken alcohol or drugs that induce sleep (sleeping drugs, cold remedies, etc.)
- Do not cover the seat with anything when using the seat heater. Using the seat heater with a blanket or cushion increases the temperature of the seat and may lead to overheating.
- Do not use the seat heater more than necessary. Doing so may cause minor burns or overheating.

 **NOTICE**

■ **To prevent seat heater damage**

Do not put heavy objects that have an uneven surface on the seat and do not stick sharp objects (needles, nails, etc.) into the seat.

■ **To prevent battery discharge**

Turn the seat heaters off when the engine is not running.

## Armrest

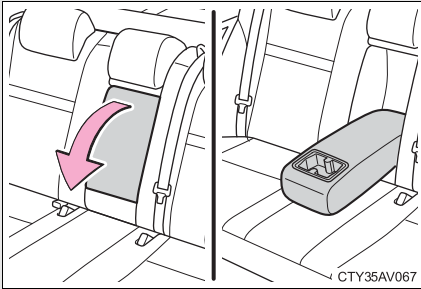

Fold down the armrest for use.

 **NOTICE**

 **To prevent damage to the armrest**

Do not apply too much load on the armrest.

## Coat hooks

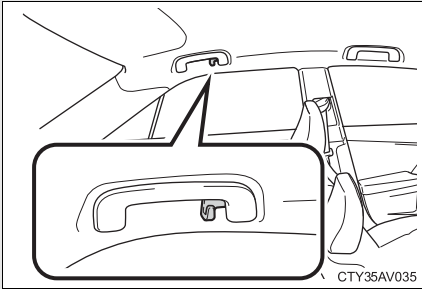

### **⚠ CAUTION**

#### **■ Items that cannot be hung on the coat hook**

Do not hang coat hangers or other hard or sharp objects on the hook. If the SRS curtain shield airbags deploy, these items may become projectiles, causing death or serious injury.

## Floor mat

Use only floor mats designed specifically for vehicles of the same model and model year as your vehicle. Fix them securely in place onto the carpet.

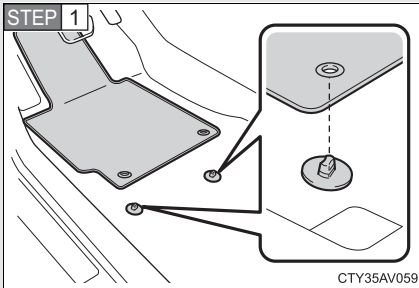

Insert the retaining hooks (clips) into the floor mat eyelets.

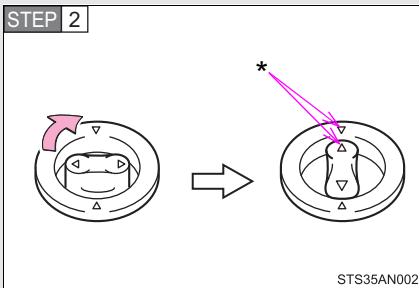

Turn the upper knob of each retaining hook (clip) to secure the floor mats in place.

\*: Always align the  $\Delta$  marks.

The shape of the retaining hooks (clips) may differ from that shown in the illustration.

**! CAUTION**

Observe the following precautions.

Failure to do so may cause the driver's floor mat to slip, possibly interfering with the pedals while driving. An unexpectedly high speed may result or it may become difficult to stop the vehicle, leading to a serious accident.

**■ When installing the driver's floor mat**

- Do not use floor mats designed for other models or different model year vehicles, even if they are Toyota Genuine floor mats.
- Only use floor mats designed for the driver's seat.
- Always install the floor mat securely using the retaining hooks (clips) provided.
- Do not use two or more floor mats on top of each other.
- Do not place the floor mat bottom-side up or upside-down.

**■ Before driving**

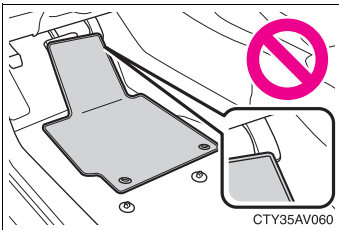

- Check that the floor mat is securely fixed in the correct place with all the provided retaining hooks (clips). Be especially careful to perform this check after cleaning the floor.
- With the engine stopped and the shift lever in P, fully depress each pedal to the floor to make sure it does not interfere with the floor mat.



## Trunk features

### ■ Grocery bag hooks

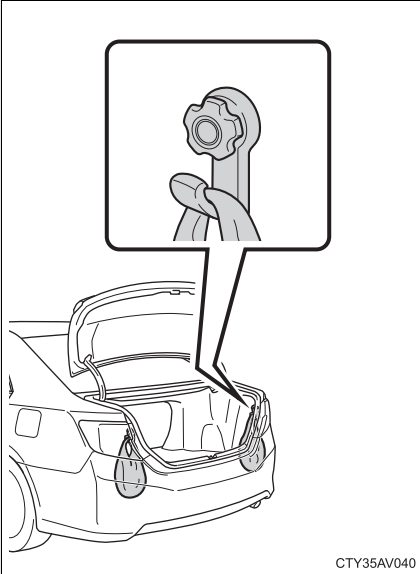

■ **Cargo net (if equipped)**

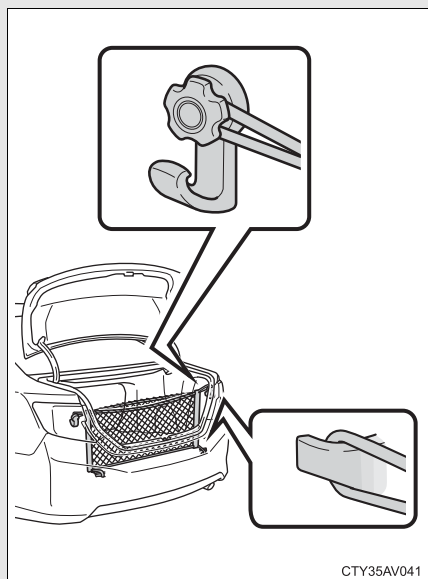

 **NOTICE**

■ **To prevent damage to the hooks**

Do not apply too much load to the hooks.

## 3-5. Other interior features

### Garage door opener\*

The garage door opener can be programmed to operate garage doors, gates, entry doors, door locks, home lighting systems, security systems, and other devices.

The garage door opener (HomeLink® Universal Transceiver) is manufactured under license from HomeLink®.

#### Programming HomeLink® (for U.S. owners)

The HomeLink® compatible transceiver in your vehicle has 3 buttons which can be programmed to operate 3 different devices. Refer to the programming method below appropriate for the device.

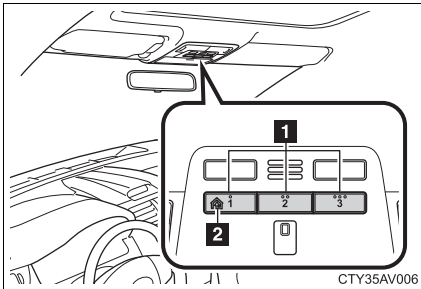

- 1 Buttons
- 2 Indicator

## ■ Programming the HomeLink®

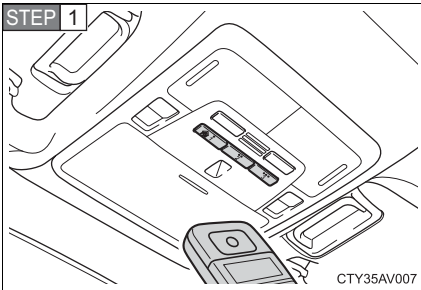

Point the remote control transmitter for the device 1 to 3 in. (25 to 75 mm) from the HomeLink® control buttons.

Keep the HomeLink® indicator light in view while programming.

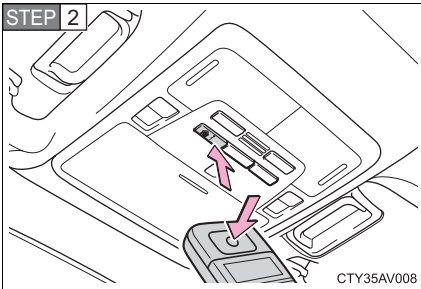

Press and hold one of the HomeLink® buttons and the transmitter button. When the HomeLink® indicator light changes from a slow to a rapid flash, you can release both buttons.

If the HomeLink® indicator light comes on but does not flash, or flashes rapidly for 2 seconds and remains lit, the HomeLink® button is already programmed. Use the other buttons or follow the "Reprogramming a HomeLink® button" instructions. (→P. 319)

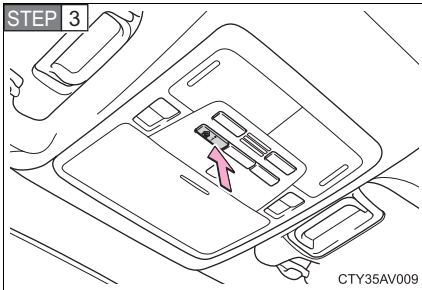

Test the HomeLink<sup>®</sup> operation by pressing the newly programmed button.

If a HomeLink<sup>®</sup> button has been programmed for a garage door, check to see if the garage door opens and closes. If the garage door does not operate, see if your remote control transmitter is of the rolling code type. Press and hold the programmed HomeLink<sup>®</sup> button. The remote control transmitter is of the rolling code type if the HomeLink<sup>®</sup> indicator light flashes rapidly for 2 seconds and then remains lit. If your transmitter is of the rolling code type, proceed to the heading “Programming a rolling code system”.

**STEP 4** Repeat the steps above to program another device for any of the remaining HomeLink<sup>®</sup> buttons.

### ■ Programming a Rolling Code system (for U.S. owners)

If your device is Rolling Code equipped, follow the steps under the heading “Programming HomeLink<sup>®</sup>” before proceeding with the steps listed below.

**STEP 1** Locate the learn button on the ceiling mounted garage door opener motor. The exact location and color of the button may vary by brand of garage door opener motor.

Refer to the operation manual supplied with the garage door opener motor for the location of the learn button.

**STEP 2** Press the learn button.

Following this step, you have 30 seconds in which to initiate step 3 below.

**STEP 3** Press and hold the vehicle's programmed HomeLink<sup>®</sup> button for 2 seconds and then release it. Repeat this step once again. The garage door may open.

If the garage door opens, the programming process is complete. If the door does not open, press and release the button a third time. This third press and release will complete the programming process by opening the garage door.

The ceiling mounted garage door opener motor should now recognize the HomeLink<sup>®</sup> signal and operate the garage door.

**STEP 4** Repeat the steps above to program another rolling code system for any of the remaining HomeLink<sup>®</sup> buttons.

### ■ **Programming an entry gate (for U.S. owners)/Programming a device in the Canadian market**

**STEP 1** Place the remote control transmitter 1 to 3 in. (25 to 75 mm) away from the HomeLink<sup>®</sup> buttons.

Keep the HomeLink<sup>®</sup> indicator light in view while programming.

**STEP 2** Press and hold the selected HomeLink<sup>®</sup> button.

**STEP 3** Repeatedly press and release (cycle) the remote control transmitter for 2 seconds each until step 4 is completed.

**STEP 4** When the HomeLink<sup>®</sup> indicator light starts to flash rapidly, release the buttons.

**STEP 5** Test the HomeLink<sup>®</sup> operation by pressing the newly programmed button. Check to see if the gate/device operates correctly.

**STEP 6** Repeat the steps above to program another device for any of the remaining HomeLink<sup>®</sup> buttons.

### ■ **Programming other devices**

To program other devices such as home security systems, home door locks or lighting, contact your Toyota dealer for assistance.

### ■ **Reprogramming a button**

The individual HomeLink<sup>®</sup> buttons cannot be erased but can be reprogrammed. To reprogram a button, follow the "Reprogramming a HomeLink<sup>®</sup> button" instructions.

## Operating HomeLink®

Press the appropriate HomeLink® button. The HomeLink® indicator light should come on.

The HomeLink® compatible transceiver in your vehicle continues to send a signal for up to 20 seconds as long as the button is pressed.

## Reprogramming a HomeLink® button

Press and hold the desired HomeLink® button. After 20 seconds, the HomeLink® indicator light will start flashing slowly. Keep pressing the HomeLink® button and press and hold the transmitter button until the HomeLink® indicator light changes from a slow to a rapid flash. Release the buttons.

## Erasing the entire HomeLink® memory (all three programs)

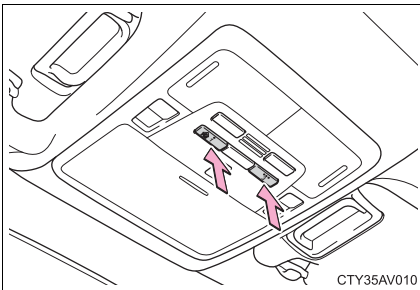

Press and hold the 2 outside buttons for 10 seconds until the indicator light flashes.

If you sell your vehicle, be sure to erase the programs stored in the HomeLink® memory.

■ **Before programming**

- Install a new battery in the remote control transmitter.
- The battery side of the remote control transmitter must be pointed away from the HomeLink® button.

■ **To prevent battery discharge**

Vehicles without a smart key system:

HomeLink® will turn off if a door has not been opened and closed for 20 minutes or the engine switch is left turned off. (After which programming cannot be completed.) Open and close a door or turn the engine switch to the “ACC” position to turn HomeLink® on. We recommend programming while the engine switch is in the “ACC” position.

Vehicles with a smart key system:

HomeLink® will turn off if a door has not been opened and closed for 20 minutes or the “ENGINE START STOP” switch is left turned off. (After which programming cannot be completed.) Open and close a door or turn the “ENGINE START STOP” switch to ACCESSORY mode to turn HomeLink® on. We recommend programming while the “ENGINE START STOP” switch is in ACCESSORY mode.

■ **Certification for the garage door opener**

**U.S.A.**

FCC ID: CB2051AHL4/CB251AHL4NR

**NOTE:**

This device complies with Part 15 of the FCC Rules. Operation is subject to the following two conditions: (1) this device may not cause harmful interference, and (2) this device must accept any interference received, including interference that may cause undesired operation.

**FCC WARNING:**

Changes or modifications not expressly approved by the party responsible for compliance could void the user's authority to operate the equipment.

**Canada**

**NOTE:**

Operation is subject to the following two conditions: (1) this device may not cause interference, and (2) this device must accept any interference, including interference that may cause undesired operation of the device.



**■ When support is necessary**

Visit on the web at [www.homelink.com](http://www.homelink.com) or call 1-800-355-3515.

**⚠ CAUTION****■ When programming a garage door or other remote control devices**

The garage door or other devices may operate, so ensure people and objects are out of danger to prevent potential harm.

**■ Conforming to federal safety standards**

Do not use the HomeLink<sup>®</sup> compatible transceiver with any garage door opener or device that lacks safety stop and reverse features as required by federal safety standards.

This includes any garage door that cannot detect an interfering object. A door or device without these features increases the risk of death or serious injury.

## Compass\*

The compass on the inside rear view mirror indicates the direction in which the vehicle is heading.

### ■ Operation

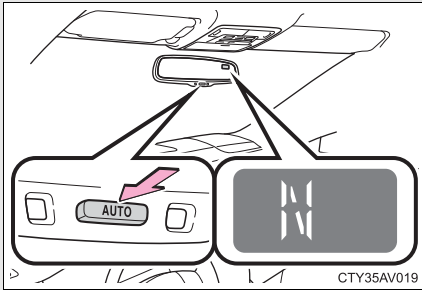

To turn the compass on or off, press “AUTO” for more than 3 seconds.

### ■ Displays and directions

Display	Direction
N	North
NE	Northeast
E	East
SE	Southeast
S	South
SW	Southwest
W	West
NW	Northwest

\*: If equipped

## Calibrating the compass

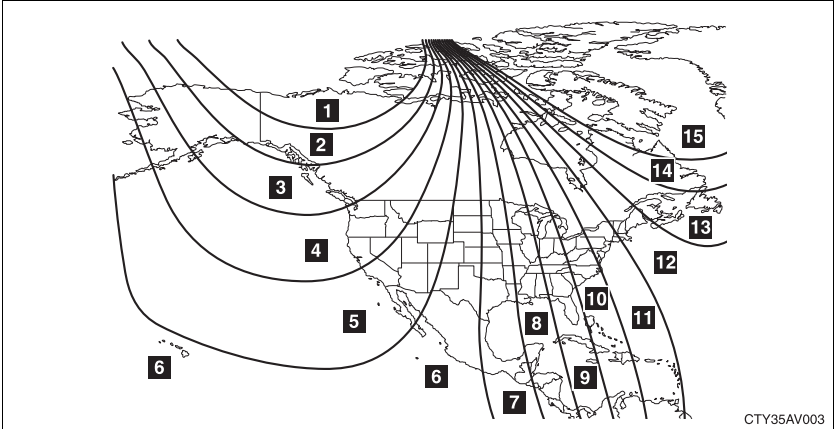

The direction display deviates from the true direction determined by the earth's magnetic field. The amount of deviation varies depending on the geographic position of the vehicle.

If you cross over one of the map boundaries shown in illustration, the compass will deviate.

To obtain higher precision or perfect calibration, refer to "Deviation calibration".

### ■ Deviation calibration

**STEP 1** Stop the vehicle.

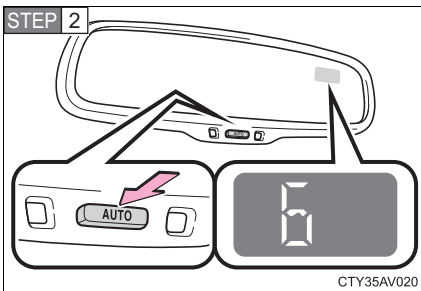

Press and hold "AUTO".

A number (1 to 15) appears on the compass display.

**STEP 3** Referring to the map above, press “AUTO” to select the number of the zone you are in.

If the direction is displayed several seconds after adjustment, the calibration is complete.

### ■ Circling calibration

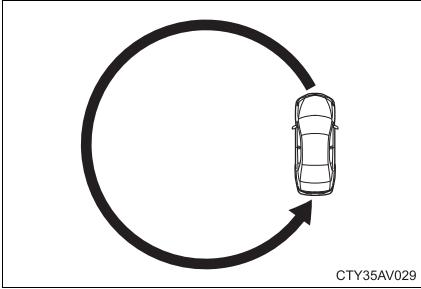

When “C” appears on the display, drive the vehicle at 5 mph (8 km/h) or less in a circle until a direction is displayed.

If there is not enough space to drive in a circle, drive around the block until a direction is displayed.

---

### ■ Conditions unfavorable to correct operation

The compass may not show the correct direction in the following conditions:

- The vehicle is stopped immediately after turning.
- The vehicle is on an inclined surface.
- The vehicle is in a place where the earth's magnetic field is subject to interference by artificial magnetic fields (underground car park/parking lot, under a steel tower, between buildings, roof car park/parking lot, near an intersection, near a large vehicle, etc.).
- The vehicle has become magnetized.  
(There is a magnet or metal object near the inside rear view mirror.)
- The battery has been disconnected.
- A door is open.

 **CAUTION****■ While driving the vehicle**

Do not adjust the display. Adjust the display only when the vehicle is stopped.

**■ When doing the circling calibration**

Secure a wide space, and watch out for people and vehicles in the vicinity. Do not violate any local traffic rules while performing circling calibration.

 **NOTICE****■ To avoid compass malfunctions**

Do not place magnets or any metal objects near the inside rear view mirror. Doing this may cause the compass sensor to malfunction.

**■ To ensure normal operation of the compass**

- Do not perform a circling calibration of the compass in a place where the earth's magnetic field is subject to interference by artificial magnetic fields.
- During calibration, do not operate electric systems (moon roof, power windows, etc.) as they may interfere with the calibration.

## Safety Connect\*

**Safety Connect is a subscription-based telematics service that uses Global Positioning System (GPS) data and embedded cellular technology to provide safety and security features to subscribers. Safety Connect is supported by Toyota's designated response center, which operates 24 hours per day, 7 days per week.**

**Safety Connect service is available by subscription on select, telematics hardware-equipped vehicles.**

**By using the Safety Connect service, you are agreeing to be bound by the Telematics Subscription Service Agreement and its Terms and Conditions, as in effect and amended from time to time, a current copy of which is available at Toyota.com. All use of the Safety Connect service is subject to such then-applicable Terms and Conditions.**

### ■ System components

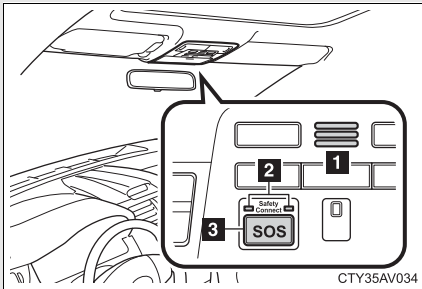

- 1** Microphone
- 2** LED light indicators
- 3** "SOS" button

\*: if equipped

## ■ Services

Subscribers have the following Safety Connect services available:

- Automatic Collision Notification\*

Helps drivers receive necessary response from emergency service providers. (→P. 329)

\*: U.S. Patent No. 7,508,298 B2

- Stolen Vehicle Location

Helps drivers in the event of vehicle theft. (→P. 330)

- Emergency Assistance Button (SOS)

Connects drivers to response-center support. (→P. 330)

- Enhanced Roadside Assistance

Provides drivers various on-road assistance. (→P. 330)

## ■ Subscription

After you have signed the Telematics Subscription Service Agreement and are enrolled, you can begin receiving services.

A variety of subscription terms is available for purchase. Contact your Toyota dealer, call 1-800-331-4331, or push the “SOS” button in your vehicle for further subscription details.

### ■ **Safety Connect Services Information**

- Phone calls using the vehicles Bluetooth® technology will not be possible during Safety Connect.
- Safety Connect is available beginning Fall 2009 on select Toyota models. Contact with the Safety Connect response center is dependent upon the telematics device being in operative condition, cellular connection availability, and GPS satellite signal reception, which can limit the ability to reach the response center or receive emergency service support. Enrollment and Telematics Subscription Service Agreement required. A variety of subscription terms is available; charges vary by subscription term selected.
- Automatic Collision Notification, Emergency Assistance, Stolen Vehicle Location, and Enhanced Roadside Assistance will function in the United States, including Hawaii and Alaska, and in Canada. No Safety Connect services will function outside of the United States in countries other than Canada.
- Safety Connect services are not subject to section 255 of the Telecommunications Act and the device is not TTY compatible.

### ■ **Languages**

The Safety Connect response center will offer support in multiple languages. The Safety Connect system will offer voice prompts in English and Spanish. Please indicate your language of choice when enrolling.

### ■ **When contacting the response center**

You may be unable to contact the response center if the network is busy.



## Safety Connect LED light Indicators

When the “ENGINE START STOP” switch is turned to IGNITION ON mode (vehicles with a smart key system) or the engine switch is turned to the “ON” position (vehicles without a smart key system), the red indicator light comes on for 2 seconds then turns off. Afterward, the green indicator light comes on, indicating that the service is active.

The following indicator light patterns indicate specific system usage conditions:

- Green indicator light on = Active service
- Green indicator light flashing = Safety Connect call in process
- Red indicator light (except at vehicle start-up) = System malfunction (contact your Toyota dealer)
- No indicator light (off) = Safety Connect service not active

## Safety Connect services

### ■ Automatic Collision Notification

In case of either airbag deployment or severe rear-end collision, the system is designed to automatically call the response center. The responding agent receives the vehicle’s location and attempts to speak with the vehicle occupants to assess the level of emergency. If the occupants are unable to communicate, the agent automatically treats the call as an emergency, contacts the nearest emergency services provider to describe the situation, and requests that assistance be sent to the location.

### ■ **Stolen Vehicle Location**

If your vehicle is stolen, Safety Connect can work with local authorities to assist them in locating and recovering the vehicle. After filing a police report, call the Safety Connect response center at 1-800-331-4331 and follow the prompts for Safety Connect to initiate this service.

In addition to assisting law enforcement with recovery of a stolen vehicle, Safety-Connect-equipped vehicle location data may, under certain circumstances, be shared with third parties to locate your vehicle. Further information is available at [Toyota.com](http://Toyota.com).

### ■ **Emergency Assistance Button (“SOS”)**

In the event of an emergency on the road, push the “SOS” button to reach the Safety Connect response center. The answering agent will determine your vehicle’s location, assess the emergency, and dispatch the necessary assistance required.

If you accidentally press the “SOS” button, tell the response-center agent that you are not experiencing an emergency.

### ■ **Enhanced Roadside Assistance**

Enhanced Roadside Assistance adds GPS data to the already included warranty-based Toyota roadside service.

Subscribers can press the “SOS” button to reach a Safety Connect response-center agent, who can help with a wide range of needs, such as: towing, flat tire, fuel delivery, etc. For a description of the Enhanced Roadside Assistance services and their limitations, please see the Safety Connect Terms and Conditions, which are available at [Toyota.com](http://Toyota.com).

## Safety information for Safety Connect

Important! Read this information before using Safety Connect.

### ■ Exposure to radio frequency signals

The Safety Connect system installed in your vehicle is a low-power radio transmitter and receiver. It receives and also sends out radio frequency (RF) signals.

In August 1996, the Federal Communications Commission (FCC) adopted RF exposure guidelines with safety levels for mobile wireless phones. Those guidelines are consistent with the safety standards previously set by the following U.S. and international standards bodies.

- ANSI (American National Standards Institute) C95.1 [1992]
- NCRP (National Council on Radiation Protection and Measurement) Report 86 [1986]
- ICNIRP (International Commission on Non-Ionizing Radiation Protection) [1996]

Those standards were based on comprehensive and periodic evaluations of the relevant scientific literature. Over 120 scientists, engineers, and physicians from universities, and government health agencies and industries reviewed the available body of research to develop the ANSI Standard (C95.1).

The design of Safety Connect complies with the FCC guidelines in addition to those standards.

■ **Certification for Safety Connect**

FCC ID: O9EGTM1

FCC ID: O6Y-CDMRF101

**NOTE:**

This device complies with Part 15 of the FCC Rules. Operation is subject to the following two conditions: (1) This device may not cause harmful interference, and (2) this device must accept any interference received, including interference that may cause undesired operation.

**FCC WARNING:**

Changes or modifications not expressly approved by the party responsible for compliance could void the user's authority to operate the equipment.

**4-1. Maintenance and care**

Cleaning and protecting  
the vehicle exterior..... 334  
Cleaning and protecting  
the vehicle interior..... 337

**4-2. Maintenance**

Maintenance  
requirements ..... 340  
General maintenance..... 342  
Emission inspection and  
maintenance (I/M)  
programs..... 346

**4-3. Do-it-yourself  
maintenance**

Do-it-yourself service  
precautions ..... 347  
Hood ..... 350  
Positioning a floor jack..... 351  
Engine compartment..... 353  
Tires ..... 367  
Tire inflation pressure ..... 375  
Wheels ..... 379  
Air conditioning filter..... 382  
Wireless remote control/  
electronic key battery ..... 384  
Checking and replacing  
fuses ..... 389  
Light bulbs..... 401

## Cleaning and protecting the vehicle exterior

**Perform the following to protect the vehicle and maintain it in prime condition:**

- Working from top to bottom, liberally apply water to the vehicle body, wheel wells and underside of the vehicle to remove any dirt and dust.
- Wash the vehicle body using a sponge or soft cloth, such as a chamois.
- For hard-to-remove marks, use car wash soap and rinse thoroughly with water.
- Wipe away any water.
- Wax the vehicle when the waterproof coating deteriorates.

If water does not bead on a clean surface, apply wax when the vehicle body is cool.

---

### ■ Automatic car washes

- Fold the mirrors before washing the vehicle. Start washing from the front of the vehicle. Make sure to extend the mirrors before driving.
- Brushes used in automatic car washes may scratch the vehicle surface and harm your vehicle's paint.
- Vehicles with rear spoiler: In certain automatic car washes, the rear spoiler may interfere with machine operation. This may prevent the vehicle from being cleaned properly or result in damage to the rear spoiler.

### ■ High pressure car washes

- Do not allow the nozzles of the car wash to come within close proximity of the windows.
- Before using the car wash, check that the fuel filler door on your vehicle is closed properly.

### ■ When using a car wash (vehicles with a smart key system)

If the door handle becomes wet while the electronic key is within the effective range, the door may lock and unlock repeatedly. In that case, follow the following correction procedures to wash the vehicle:

- Place the electronic key in a location 6 ft. (2 m) or more away from the vehicle. (Take care to ensure that the key is not stolen.)
- Set the electronic key to battery-saving mode to disable the smart key system. (→P. 39)

### ■ Aluminum wheels (if equipped)

- Remove any dirt immediately by using a neutral detergent. Do not use hard brushes or abrasive cleaners. Do not use strong or harsh chemical cleaners. Use the same mild detergent and wax as used on the paint.
- Do not use detergent on the wheels when they are hot, for example after driving for long distance in the hot weather.
- Wash detergent from the wheels immediately after use.

### ■ Bumpers

Do not scrub with abrasive cleaners.

## CAUTION

### ■ When washing the vehicle

Do not apply water to the inside of the engine compartment. Doing so may cause the electrical components etc. to catch fire.

### ■ Precautions regarding the exhaust pipe

Exhaust gasses cause the exhaust pipe to become quite hot.

When washing the vehicle, be careful not to touch the pipe until it has cooled sufficiently, as touching a hot exhaust pipe can cause burns.

### ■ Precaution regarding the Blind Spot Monitor

If the paint of the rear bumper is chipped or scratched, the system may malfunction. If this occurs, consult your Toyota dealer.

 NOTICE

■ **To prevent paint deterioration and corrosion on the body and components (aluminum wheels etc.)**

● Wash the vehicle immediately in the following cases:

- After driving near the sea coast
- After driving on salted roads
- If coal tar or tree sap is present on the paint surface
- If dead insects, insect droppings or bird droppings are present on the paint surface
- After driving in an area contaminated with soot, oily smoke, mine dust, iron powder or chemical substances
- If the vehicle becomes heavily soiled with dust or mud
- If liquids such as benzene and gasoline are spilled on the paint surface

● If the paint is chipped or scratched, have it repaired immediately.

● To prevent the wheels from corroding, remove any dirt and store in a place with low humidity when storing the wheels.

■ **Cleaning the exterior lights**

● Wash carefully. Do not use organic substances or scrub with a hard brush. This may damage the surfaces of the lights.

● Do not apply wax to the surfaces of the lights. Wax may cause damage to the lenses.



## Cleaning and protecting the vehicle interior

**The following procedures will help protect your vehicle's interior and keep it in top condition:**

### ■ **Protecting the vehicle interior**

Remove dirt and dust using a vacuum cleaner. Wipe dirty surfaces with a cloth dampened with lukewarm water.

### ■ **Cleaning the leather areas**

- Remove dirt and dust using a vacuum cleaner.
- Wipe off any excess dirt and dust with a soft cloth dampened with diluted detergent.

Use a diluted water solution of approximately 5% neutral wool detergent.

- Wring out any excess water from the cloth and thoroughly wipe off all remaining traces of detergent.
- Wipe the surface with a dry, soft cloth to remove any remaining moisture. Allow the leather to dry in a shaded and ventilated area.

### ■ **Cleaning the synthetic leather areas**

- Remove loose dirt using a vacuum cleaner.
- Apply a mild soap solution to the synthetic leather using a sponge or soft cloth.
- Allow the solution to soak in for a few minutes. Remove the dirt and wipe off the solution with a clean, damp cloth.

### ■ Caring for leather areas

Toyota recommends cleaning the interior of the vehicle at least twice a year to maintain the quality of the vehicle's interior.

### ■ Shampooing the carpets

There are several commercial foaming-type cleaners available. Use a sponge or brush to apply the foam. Rub in overlapping circles. Do not use water. Wipe dirty surfaces and let them dry. Excellent results are obtained by keeping the carpet as dry as possible.

### ■ Seat belts

Clean with mild soap and lukewarm water using a cloth or sponge. Also check the belts periodically for excessive wear, fraying or cuts.

## CAUTION

### ■ Water in the vehicle

- Do not splash or spill liquid in the vehicle.

Doing so may cause electrical components etc. to malfunction or catch fire.

- Do not get any of the SRS components or wiring in the vehicle interior wet. (→P. 101)

An electrical malfunction may cause the airbags to deploy or not function properly, resulting in death or serious injury.

### ■ Cleaning the interior (especially instrument panel)

Do not use polish wax or polish cleaner. The instrument panel may reflect off the windshield, obstructing the driver's view and leading to an accident, resulting in death or serious injury.

 NOTICE**■ Cleaning detergents**

- Do not use the following types of detergent, as they may discolor the vehicle interior or cause streaks or damage to painted surfaces:
  - Non-seat portions: Organic substances such as benzene or gasoline, alkaline or acidic solutions, dye, and bleach
  - Seats: Alkaline or acidic solutions, such as thinner, benzene, and alcohol
- Do not use polish wax or polish cleaner. The instrument panel's or other interior part's painted surface may be damaged.

**■ Preventing damage to leather surfaces**

Observe the following precautions to avoid damage to and deterioration of leather surfaces:

- Remove any dust or dirt from leather surfaces immediately.
- Do not expose the vehicle to direct sunlight for extended periods of time. Park the vehicle in the shade, especially during summer.
- Do not place items made of vinyl, plastic, or containing wax on the upholstery, as they may stick to the leather surface if the vehicle interior heats up significantly.

**■ Water on the floor**

Do not wash the vehicle floor with water.

Vehicle systems such as the audio system may be damaged if water comes into contact with electrical components such as the audio system above or under the floor of the vehicle. Water may also cause the body to rust.

**■ Cleaning the inside of the rear window**

- Do not use glass cleaner to clean the rear window, as this may cause damage to the rear window defogger heater wires or antenna. Use a cloth dampened with lukewarm water to gently wipe the window clean. Wipe the window in strokes running parallel to the heater wires or antenna.
- Be careful not to scratch or damage the heater wires or antenna.

## Maintenance requirements

**To ensure safe and economical driving, day-to-day care and regular maintenance are essential. It is the owner's responsibility to perform regular checks. Toyota recommends performing the following maintenance:**

### ■ General maintenance

General maintenance should be performed on a daily basis. This can be done by yourself or by a Toyota dealer.

### ■ Scheduled maintenance

Scheduled maintenance should be performed at specified intervals according to the maintenance schedule.

For details about maintenance items and schedules, refer to the "Scheduled Maintenance Guide" or "Owner's Manual Supplement".

### ■ Do-it-yourself maintenance

You can perform some maintenance procedures by yourself. Please be aware that do-it-yourself maintenance may affect warranty coverage.

The use of Toyota Repair Manuals is recommended.

For details about warranty coverage, see the separate "Owner's Warranty Information Booklet" or "Owner's Manual Supplement".

---

### ■ Repair and replacement

It is recommended that genuine Toyota parts be used for repair to ensure performance of each system. If non-Toyota parts are used in replacement or if a repair shop other than a Toyota dealer performs repairs, confirm the warranty coverage.

### ■ Reset the maintenance data (U.S.A. only)

After the required maintenance is performed according to the maintenance schedule, please reset the maintenance data.

To reset the data, follow the procedures described below:

- STEP 1** Turn the engine switch (vehicles without a smart key system) or the “ENGINE START STOP” switch (vehicles with a smart key system) off with the trip meter A reading shown. (→P. 172)
- STEP 2** While pressing the display change button (→P. 169), turn the engine switch to the “ON” position (vehicles without a smart key system) or “ENGINE START STOP” switch to IGNITION ON mode (vehicles with a smart key system)
- STEP 3** Continue to press and hold the knob until the trip meter displays “000000”.

**■ Allow inspection and repairs to be performed by a Toyota dealer**

- Toyota technicians are well-trained specialists and are kept up to date with the latest service information. They are well informed about the operations of all systems on your vehicle.
- Keep a copy of the repair order. It proves that the maintenance that has been performed is under warranty coverage. If any problem should arise while your vehicle is under warranty, your Toyota dealer will promptly take care of it.

**⚠ CAUTION**

**■ If your vehicle is not properly maintained**

Improper maintenance could result in serious damage to the vehicle and possible serious injury or death.

**■ Handling of the battery**

- Engine exhaust, some of its constituents, and a wide variety of automobile components contain or emit chemicals known to the State of California to cause cancer and birth defects and other reproductive harm. Work in a well ventilated area.
- Oils, fuels and fluids contained in vehicles as well as waste produced by component wear contain or emit chemicals known to the State of California to cause cancer and birth defects or other reproductive harm. Avoid exposure and wash any affected area immediately.
- Battery posts, terminals and related accessories contain lead and lead compounds which are known to cause brain damage. Wash your hands after handling. (→P. 363)

## General maintenance

Listed below are the general maintenance items that should be performed at the intervals specified in the “Owner's Warranty Information Booklet” or “Owner's Manual Supplement/Scheduled Maintenance Guide”. It is recommended that any problem you notice should be brought to the attention of your Toyota dealer or qualified service shop for advice.

### Engine compartment

Items	Check points
Battery	Check the connections. (→P. 363)
Brake fluid	Is the brake fluid at the correct level? (→P. 361)
Engine coolant	Is the engine coolant at the correct level? (→P. 360)
Engine oil	Is the engine oil at the correct level? (→P. 355)
Exhaust system	There should not be any fumes or strange sounds.
Radiator/condenser	The radiator and condenser should be free from foreign objects. (→P. 361)
Washer fluid	Is there sufficient washer fluid? (→P. 366)

<b>Vehicle interior</b>
-------------------------

Items	Check points
Accelerator pedal	<ul style="list-style-type: none"> <li>The accelerator pedal should move smoothly (without uneven pedal effort or catching).</li> </ul>
Automatic transmission "Park" mechanism	<ul style="list-style-type: none"> <li>When parked on a slope and the shift lever is in P, is the vehicle securely stopped?</li> </ul>
Brake pedal	<ul style="list-style-type: none"> <li>Does the brake pedal move smoothly?</li> <li>Does the brake pedal have appropriate clearance from the floor? (→P. 473)</li> <li>Does the brake pedal have the correct amount of free play? (→P. 473)</li> </ul>
Brakes	<ul style="list-style-type: none"> <li>The vehicle should not pull to one side when the brakes are applied.</li> <li>The brakes should work effectively.</li> <li>The brake pedal should not feel spongy.</li> <li>The brake pedal should not get too close to the floor when the brakes are applied.</li> </ul>
Head restraints (front seat)	<ul style="list-style-type: none"> <li>Do the head restraints move smoothly and lock securely?</li> </ul>
Indicators/buzzers	<ul style="list-style-type: none"> <li>Do the indicators and buzzers function properly?</li> </ul>
Lights	<ul style="list-style-type: none"> <li>Do all the lights come on?</li> </ul>
Parking brake	<ul style="list-style-type: none"> <li>Does the parking brake pedal move smoothly?</li> <li>When parked on a slope and the parking brake is on, is the vehicle securely stopped?</li> </ul>

Items	Check points
Seat belts	<ul style="list-style-type: none"> <li>• Do the seat belts operate smoothly?</li> <li>• The seat belts should not be damaged.</li> </ul>
Seats	<ul style="list-style-type: none"> <li>• Do the seat controls operate properly?</li> </ul>
Steering wheel	<ul style="list-style-type: none"> <li>• Does the steering wheel rotate smoothly?</li> <li>• Does the steering wheel have the correct amount of free play?</li> <li>• There should not be any strange sounds coming from the steering wheel.</li> </ul>



## Vehicle exterior

Items	Check points
Doors/trunk	<ul style="list-style-type: none"> <li>• Do the doors and trunk operate smoothly?</li> </ul>
Engine hood	<ul style="list-style-type: none"> <li>• Does the engine hood lock system work properly?</li> </ul>
Fluid leaks	<ul style="list-style-type: none"> <li>• There should not be any signs of fluid leakage after the vehicle has been parked.</li> </ul>
Tires	<ul style="list-style-type: none"> <li>• Is the tire inflation pressure correct?</li> <li>• The tires should not be damaged or excessively worn.</li> <li>• Have the tires been rotated according to the maintenance schedule?</li> <li>• The wheel nuts should not be loose.</li> </ul>

### CAUTION

#### ■ If the engine is running

Turn the engine off and ensure that there is adequate ventilation before performing maintenance checks.

**Some states have vehicle emission inspection programs which include OBD (On Board Diagnostics) checks. The OBD system monitors the operation of the emission control system.**

■ **If the malfunction indicator lamp comes on**

The OBD system determines that a problem exists somewhere in the emission control system. Your vehicle may not pass the I/M test and may need to be repaired. Contact your Toyota dealer to service the vehicle.

■ **Your vehicle may not pass the I/M test in the following situations:**

- When the battery is disconnected or discharged

Readiness codes that are set during ordinary driving are erased.

Also, depending on your driving habits, the readiness codes may not be completely set.

- When the fuel tank cap is loose

The malfunction indicator lamp comes on indicating a temporary malfunction and your vehicle may not pass the I/M test.

■ **When the malfunction indicator lamp still remains on after several driving trips**

The error code in the OBD system will not be cleared unless the vehicle is driven 40 or more times.

■ **If your vehicle does not pass the I/M test**

Contact your Toyota dealer to prepare the vehicle for re-testing.

## Do-it-yourself service precautions

**If you perform maintenance by yourself, be sure to follow the correct procedures as given in these sections.**

Items	Parts and tools
Battery condition (→P. 363)	<ul style="list-style-type: none"> <li>• Warm water</li> <li>• Baking soda</li> <li>• Grease</li> <li>• Conventional wrench (for terminal clamp bolts)</li> </ul>
Brake fluid level (→P. 361)	<ul style="list-style-type: none"> <li>• FMVSS No.116 DOT 3 or SAE J1703 brake fluid</li> <li>• Rag or paper towel</li> <li>• Funnel (used only for adding brake fluid)</li> </ul>
Engine coolant level (→P. 360)	<ul style="list-style-type: none"> <li>• “Toyota Super Long Life Coolant” or a similar high quality ethylene glycol-based non-silicate, non-amine, non-nitrite and non-borate coolant with long-life hybrid organic acid technology U.S.A.: “Toyota Super Long Life Coolant” is pre-mixed with 50% coolant and 50% deionized water. Canada: “Toyota Super Long Life Coolant” is pre-mixed with 55% coolant and 45% deionized water.</li> <li>• Funnel (used only for adding engine coolant)</li> </ul>

Items	Parts and tools
Engine oil level (→P. 355)	<ul style="list-style-type: none"> <li>• “Toyota Genuine Motor Oil” or equivalent</li> <li>• Rag or paper towel</li> <li>• Funnel (used only for adding engine oil)</li> </ul>
Fuses (→P. 389)	<ul style="list-style-type: none"> <li>• Fuse with same amperage rating as original</li> </ul>
Light bulbs (→P. 401)	<ul style="list-style-type: none"> <li>• Bulb with same number and wattage rating as original</li> <li>• Phillips-head screwdriver</li> <li>• Flathead screwdriver</li> <li>• Wrench</li> </ul>
Radiator and condenser (→P. 361)	—
Tire inflation pressure (→P. 375)	<ul style="list-style-type: none"> <li>• Tire pressure gauge</li> <li>• Compressed air source</li> </ul>
Washer fluid (→P. 366)	<ul style="list-style-type: none"> <li>• Water or washer fluid containing antifreeze (for winter use)</li> <li>• Funnel (used only for adding water or washer fluid)</li> </ul>

 **CAUTION**

The engine compartment contains many mechanisms and fluids that may move suddenly, become hot, or become electrically energized. To avoid death or serious injury, observe the following precautions:

■ **When working on the engine compartment:**

- Keep hands, clothing and tools away from the moving fan and engine drive belt.
- Be careful not to touch the engine, radiator, exhaust manifold, etc. right after driving as they may be hot. Oil and other fluids may also be hot.
- Do not leave anything that may burn easily, such as paper or rags, in the engine compartment.
- Do not smoke, cause sparks or expose an open flame to fuel or the battery. Fuel and battery fumes are flammable.
- Be extremely cautious when working on the battery. It contains poisonous and corrosive sulfuric acid.

■ **When working near the electric cooling fans or radiator grille**

Vehicles without a smart key system: Be sure the engine switch is off. With the engine switch in the "ON" position, the electric cooling fans may automatically start to run if the air conditioning is on and/or the coolant temperature is high. (→P. 361)

Vehicles with a smart key system: Be sure the "ENGINE START STOP" switch is off. With the "ENGINE START STOP" switch in IGNITION ON mode, the electric cooling fans may automatically start to run if the air conditioning is on and/or the coolant temperature is high. (→P. 361)

■ **Safety glasses**

Wear safety glasses to prevent flying or falling material, fluid spray, etc. from getting in your eyes.

 **NOTICE**

■ **If you remove the air cleaner filter**

Driving with the air cleaner filter removed may cause excessive engine wear due to dirt in the air. Also, a backfire could cause a fire in the engine compartment.

## 4-3. Do-it-yourself maintenance

### Hood

**Release the lock from the inside of the vehicle to open the hood.**

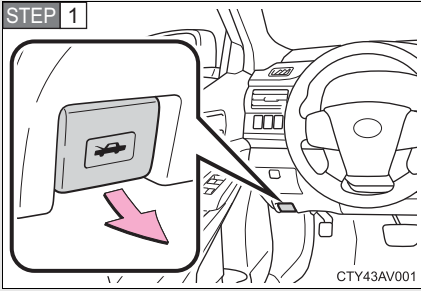

Pull the hood release lever.

The hood will pop up slightly.

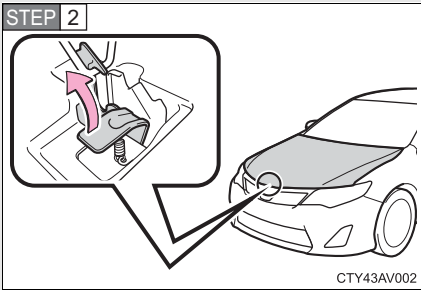

Pull up the auxiliary catch lever and lift the hood.

#### CAUTION

##### ■ Pre-driving check

Check that the hood is fully closed and locked.

If the hood is not locked properly, it may open while the vehicle is in motion and cause an accident, which may result in death or serious injury.

## 4-3. Do-it-yourself maintenance

### Positioning a floor jack

When raising your vehicle with a floor jack, position the jack correctly. Improper placement may damage your vehicle or cause injury.

#### ■ Front

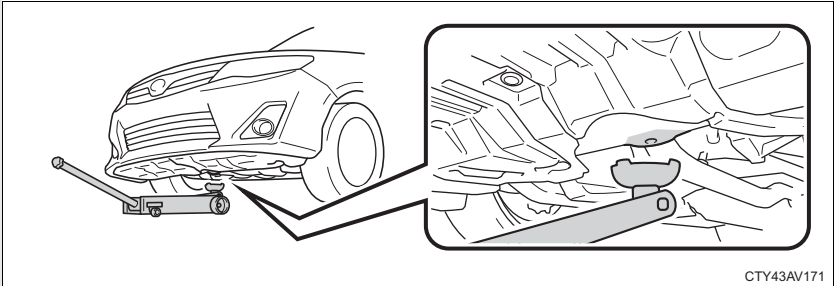

#### ■ Rear

##### 2.5 L 4-cylinder (2AR-FE) engine

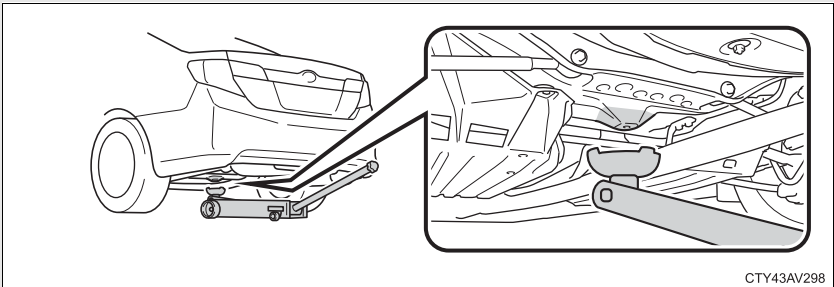

##### 3.5 L V6 (2GR-FE) engine

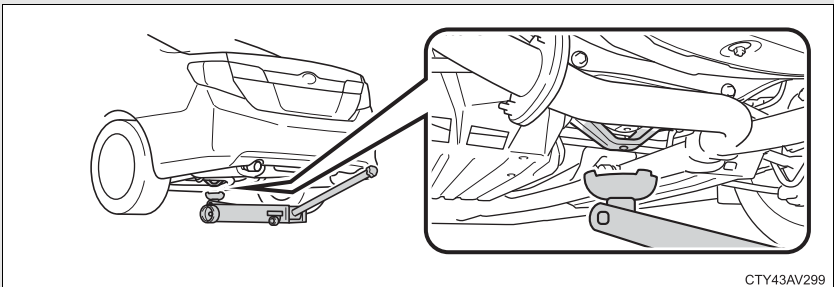

**! CAUTION**

**■ When raising your vehicle**

Make sure to observe the following precautions to reduce the possibility of death or serious injury:

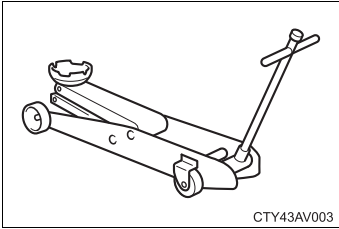

● Lift up the vehicle using a floor jack such as the one shown in the illustration.

- When using a floor jack, follow the instructions of the manual provided with the jack.
- Do not use the jack that was supplied with your vehicle.
- Do not put any part of your body underneath the vehicle when it is supported only by the floor jack.
- Always use floor jack and/or automotive jack stands on a solid, flat, level surface.
- Do not start the engine while the vehicle is supported by the floor jack.
- Stop the vehicle on level, firm ground, firmly set the parking brake and shift the shift lever to P.
- Make sure to set the floor jack properly at the jack point.  
Raising the vehicle with an improperly positioned floor jack will damage the vehicle and may cause the vehicle to fall off the floor jack.
- Do not raise the vehicle while someone is in the vehicle.
- When raising the vehicle, do not place any objects on top of or underneath the floor jack.



## 4-3. Do-it-yourself maintenance

### Engine compartment

#### 2.5 L 4-cylinder (2AR-FE) engine

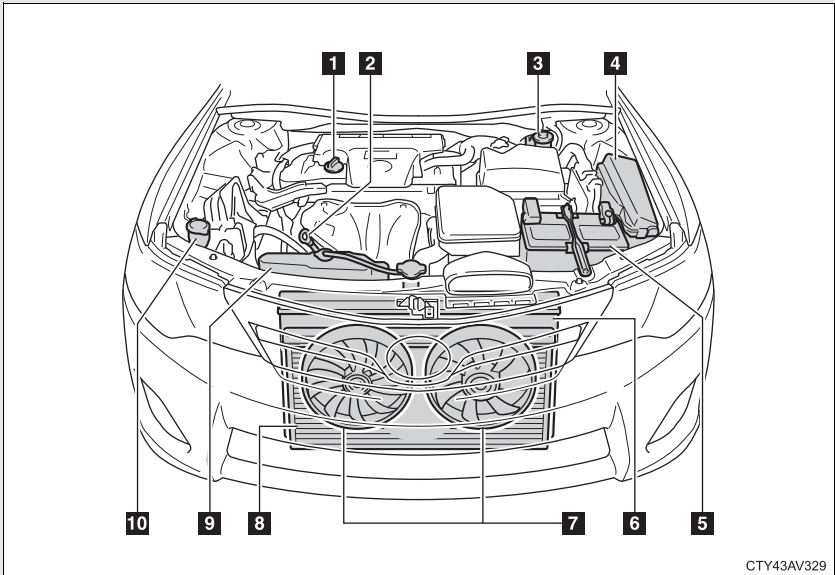

CTY43AV/329

- |   |  |
|---|--|
| <b>1</b> Engine oil filler cap<br>(→P. 357)     | <b>5</b> Battery<br>(→P. 363)                  |
| <b>2</b> Engine oil level dipstick<br>(→P. 355) | <b>6</b> Radiator<br>(→P. 361)                 |
| <b>3</b> Brake fluid reservoir<br>(→P. 361)     | <b>7</b> Electric cooling fans                 |
| <b>4</b> Fuse box<br>(→P. 389)                  | <b>8</b> Condenser<br>(→P. 361)                |
|   | <b>9</b> Engine coolant reservoir<br>(→P. 360) |
|   | <b>10</b> Washer fluid tank (→P. 366)          |

### 3.5 L V6 (2GR-FE) engine

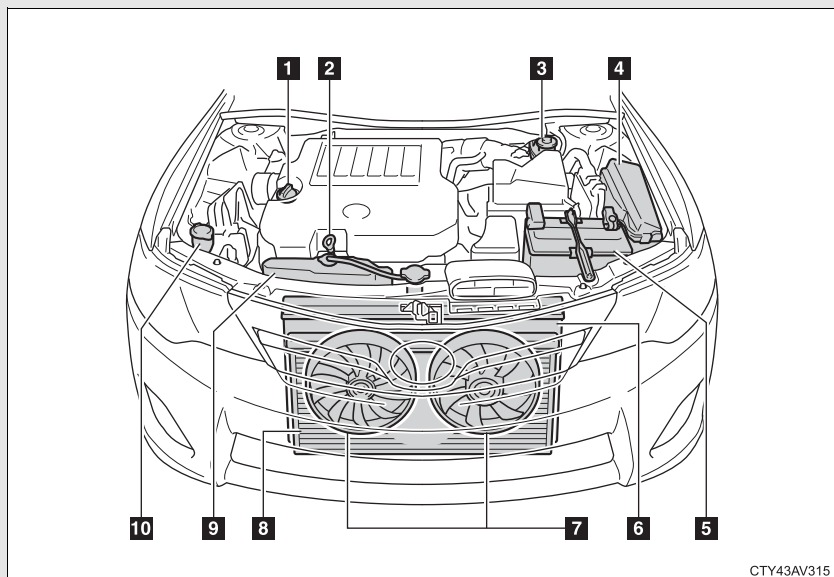

CTY43AV315

- |   |  |
|---|--|
| <b>1</b> Engine oil filler cap<br>(→P. 357)     | <b>5</b> Battery<br>(→P. 363)                  |
| <b>2</b> Engine oil level dipstick<br>(→P. 355) | <b>6</b> Radiator<br>(→P. 361)                 |
| <b>3</b> Brake fluid reservoir<br>(→P. 361)     | <b>7</b> Electric cooling fans                 |
| <b>4</b> Fuse box<br>(→P. 389)                  | <b>8</b> Condenser<br>(→P. 361)                |
|   | <b>9</b> Engine coolant reservoir<br>(→P. 360) |
|   | <b>10</b> Washer fluid tank (→P. 366)          |

## Engine oil

With the engine at operating temperature and turned off, check the oil level on the dipstick.

### ■ Checking the engine oil

**STEP 1** Park the vehicle on level ground. After warming up the engine and turning it off, wait more than 5 minutes for the oil to drain back into the bottom of the engine.

**STEP 2** Hold a rag under the end, pull the dipstick out.

#### 2.5 L 4-cylinder (2AR-FE) engine

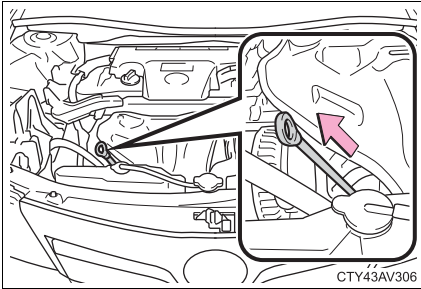

#### 3.5 L V6 (2GR-FE) engine

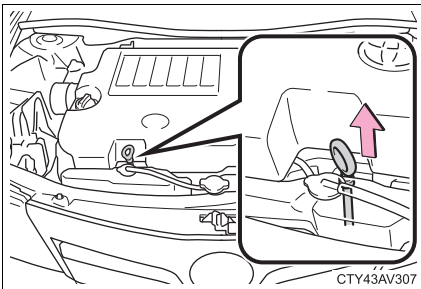

**STEP 3** Wipe the dipstick clean.

**STEP 4** Reinsert the dipstick fully.

**STEP 5** Holding a rag under the end, pull the dipstick out and check the oil level.

**STEP 6** Wipe the dipstick and reinsert it fully.

### 2.5 L 4-cylinder (2AR-FE) engine

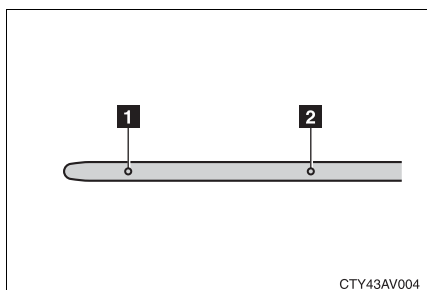

**1** Low

**2** Full

### 3.5 L V6 (2GR-FE) engine

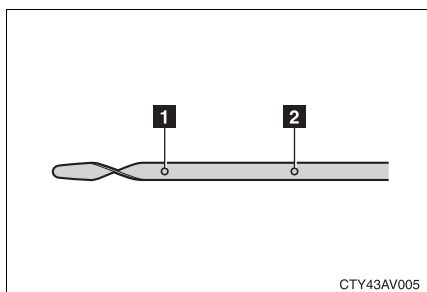

**1** Low

**2** Full

## ■ Adding engine oil

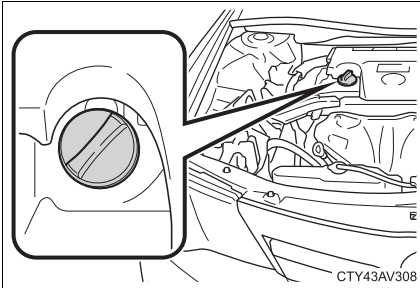

If the oil level is below or near the low level mark, add engine oil of the same type as that already in the engine.

Make sure to check the oil type and prepare the items needed before adding oil.

Engine oil selection	→P. 469
Oil quantity (Low → Full)	1.6 qt. (1.5 L, 1.3 Imp. qt.)
Items	Clean funnel

**STEP 1** Remove the oil filler cap by turning it counterclockwise.

**STEP 2** Add engine oil slowly, checking the dipstick.

**STEP 3** Install the oil filler cap by turning it clockwise.

### ■ Engine oil consumption

- The amount of engine oil consumed depends on the oil viscosity, the quality of the oil and the way the vehicle is driven.
- More oil is consumed under driving conditions such as high speeds and frequent acceleration and deceleration.
- A new engine consumes more oil.
- When judging the amount of oil consumption, keep in mind that the oil may have become diluted, making it difficult to judge the true level accurately.
- Oil consumption: Max. 1.1 qt./600 miles (0.9 Imp. qt./600 miles, 1.0 L/1000 km)
- If your vehicle consumes more than 1.1 qt. (1.0 L, 0.9 Imp. qt.) every 600 miles (1000 km), contact your Toyota dealer.

### CAUTION

#### ■ Used engine oil

- Used engine oil contains potentially harmful contaminants which may cause skin disorders such as inflammation or skin cancer, so care should be taken to avoid prolonged and repeated contact. To remove used engine oil from your skin, wash thoroughly with soap and water.
- Dispose of used oil and filters only in a safe and acceptable manner. Do not dispose of used oil and filters in household trash, in sewers or onto the ground. Call your Toyota dealer, service station or auto parts store for information concerning recycling or disposal.
- Do not leave used engine oil within the reach of children.

 NOTICE**■ To prevent serious engine damage**

Check the oil level on a regular basis.

**■ When replacing the engine oil**

- Be careful not to spill engine oil on the vehicle components.
- Avoid overfilling, as the engine could be damaged.
- Check the oil level on the dipstick every time you refill the vehicle.
- Be sure the engine oil filler cap is properly tightened.

## Engine coolant

The coolant level is satisfactory if it is between the “F” and “L” lines on the reservoir when the engine is cold.

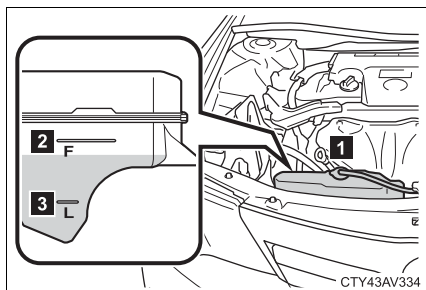

**1** Reservoir cap

**2** “F” line

**3** “L” line

If the level is on or below the “L” line, add coolant up to the “F” line. (→P. 459)

### ■ Coolant selection

Only use “Toyota Super Long Life Coolant” or a similar high quality ethylene glycol based non-silicate, non-amine, non-nitrite, and non-borate coolant with long-life hybrid organic acid technology.

U.S.A.: “Toyota Super Long Life Coolant” is a mixture of 50% coolant and 50% deionized water. (Minimum temperature: -31°F [-35°C])

Canada: “Toyota Super Long Life Coolant” is a mixture of 55% coolant and 45% deionized water. (Minimum temperature: -44°F [-42°C])

For more details about engine coolant, contact your Toyota dealer.

### ■ If the coolant level drops within a short time of replenishing

Visually check the radiator, hoses, engine coolant reservoir caps, drain cock and water pump.

If you cannot find a leak, have your Toyota dealer test the cap and check for leaks in the cooling system.

## ⚠ CAUTION

### ■ When the engine is hot

Do not remove the engine coolant reservoir cap.

The cooling system may be under pressure and may spray hot coolant if the cap is removed, causing serious injuries, such as burns.



 NOTICE

■ **When adding coolant**

Coolant is neither plain water nor straight antifreeze. The correct mixture of water and antifreeze must be used to provide proper lubrication, corrosion protection and cooling. Be sure to read the antifreeze or coolant label.

■ **If you spill coolant**

Be sure to wash it off with water to prevent it from damaging parts or paint.

## Radiator and condenser

Check the radiator and condenser and clear away any foreign objects.

If either of the above parts is extremely dirty or you are not sure of their condition, have your vehicle inspected by your Toyota dealer.

 CAUTION

■ **When the engine is hot**

Do not touch the radiator or condenser as they may be hot and cause serious injuries, such as burns.

## Brake fluid

■ **Checking fluid level**

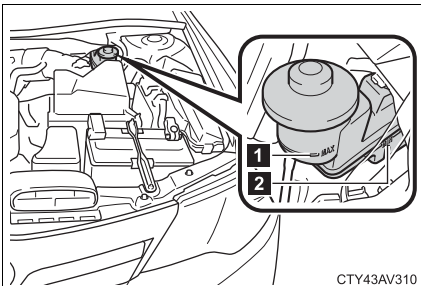

The brake fluid level should be between the “MAX” and “MIN” lines on the tank.

**1** “MAX”

**2** “MIN”

### ■ Adding fluid

Make sure to check the fluid type and prepare the necessary item.

Fluid type	FMVSS No.116 DOT 3 or SAE J1703 brake fluid
Item	Clean funnel

### ■ Brake fluid can absorb moisture from the air

Excess moisture in the brake fluid can cause a dangerous loss of braking efficiency. Use only newly opened brake fluid.

#### CAUTION

#### ■ When filling the reservoir

Take care as brake fluid can harm your hands and eyes and damage painted surfaces.

If fluid gets on your hands or in your eyes, flush the affected area with clean water immediately.

If you still experience discomfort, see a doctor.

#### NOTICE

#### ■ If the fluid level is low or high

It is normal for the brake fluid level to go down slightly as the brake pads wear out or when the fluid level in the accumulator is high.

If the reservoir needs frequent refilling, there may be a serious problem.

## Battery

Check the battery as follows:

Make sure that the battery terminals are not corroded and that there are no loose connections, cracks, or loose clamps.

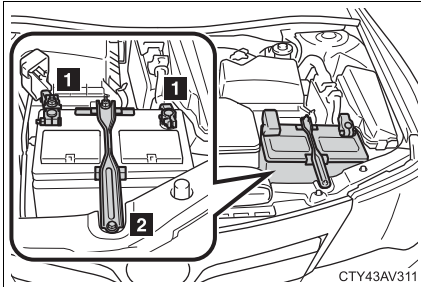

**1** Terminals

**2** Hold-down clamp

### ■ Before recharging

When recharging, the battery produces hydrogen gas which is flammable and explosive. Therefore, observe the following before recharging:

- If recharging with the battery installed on the vehicle, be sure to disconnect the ground cable.
- Make sure the power switch on the charger is off when connecting and disconnecting the charger cables to the battery.

■ **After recharging/reconnecting the battery (vehicles with a smart key system)**

- Unlocking the doors using the smart key system may not be possible immediately after reconnecting the battery. If this happens, use the wireless remote control or the mechanical key to lock/unlock the doors.
- Start the engine with the “ENGINE START STOP” switch in ACCESSORY mode. The engine may not start with the “ENGINE START STOP” switch turned off. However, the engine will operate normally from the second attempt.
- The “ENGINE START STOP” switch mode is recorded by the vehicle. If the battery is reconnected, the vehicle will return the “ENGINE START STOP” switch mode to the status it was in before the battery was disconnected. Make sure to turn off the engine before disconnect the battery. Take extra care when connecting the battery if the “ENGINE START STOP” switch mode prior to discharge is unknown.

If the engine will not start even after multiple attempts, contact your Toyota dealer.

 **CAUTION**

■ **Chemicals in the battery**

Batteries contains poisonous and corrosive sulfuric acid and may produce hydrogen gas which is flammable and explosive. To reduce the risk of death or serious injury, take the following precautions while working on or near the battery:

- Do not cause sparks by touching the battery terminals with tools.
- Do not smoke or light a match near the battery.
- Avoid contact with eyes, skin and clothes.
- Never inhale or swallow electrolyte.
- Wear protective safety glasses when working near the battery.
- Keep children away from the battery.

 **CAUTION**
**■ Where to safely charge the battery**

Always charge the battery in an open area. Do not charge the battery in a garage or closed room where there is insufficient ventilation.

**■ How to recharge the battery**

Only perform a slow charge (5 A or less). The battery may explode if charged at a quicker rate.

**■ Emergency measures regarding electrolyte**
**● If electrolyte gets in your eyes**

Flush your eyes with clean water for at least 15 minutes and get immediate medical attention. If possible, continue to apply water with a sponge or cloth while traveling to the nearest medical facility.

**● If electrolyte gets on your skin**

Wash the affected area thoroughly. If you feel pain or burning, get medical attention immediately.

**● If electrolyte gets on your clothes**

It can soak through clothing on to your skin. Immediately take off the clothing and follow the procedure above if necessary.

**● If you accidentally swallow electrolyte**

Drink a large quantity of water or milk. Get emergency medical attention immediately.

 **NOTICE**
**■ When recharging the battery**

Never recharge the battery while the engine is running. Also, be sure all accessories are turned off.

## Washer fluid

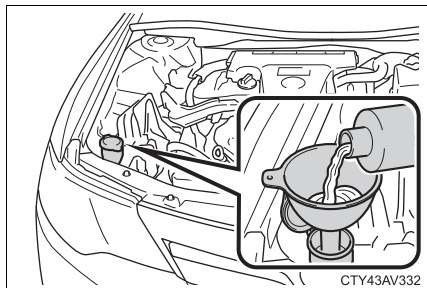

Add washer fluid in the following situations.

- Any washer does not work.
- The low washer fluid warning light comes on.

### CAUTION

#### ■ When adding washer fluid

Do not add washer fluid when the engine is hot or running as washer fluid contains alcohol and may catch fire if spilled on the engine etc.

### NOTICE

#### ■ Do not use any fluid other than washer fluid

Do not use soapy water or engine antifreeze instead of washer fluid. Doing so may cause streaking on the vehicle's painted surfaces.

#### ■ Diluting washer fluid

Dilute washer fluid with water as necessary.

Refer to the freezing temperatures listed on the label of the washer fluid bottle.

# Tires

Replace or rotate tires in accordance with maintenance schedules and treadwear.

## ■ Checking tires

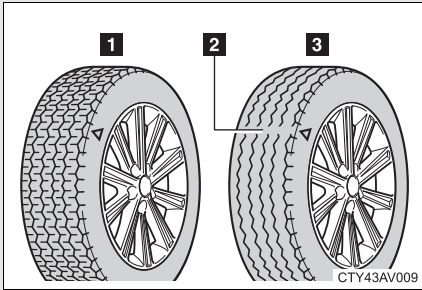

- 1 New tread
- 2 Treadwear indicator
- 3 Worn tread

The location of treadwear indicators is shown by the “TWI” or “△” marks, etc., molded on the sidewall of each tire.

Check spare tire condition and pressure if not rotated.

## ■ Tire rotation

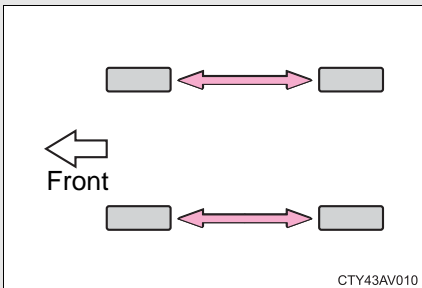

Rotate the tires in the order shown.

To equalize tire wear and extend tire life, Toyota recommends that tire rotation is carried out at the same interval as tire inspection.

## ■ Tire pressure warning system (if equipped)

Your vehicle is equipped with a tire pressure warning system that uses tire pressure warning valves and transmitters to detect low tire inflation pressure before serious problems arise.

(→P. 423)

## Installing tire pressure warning valves and transmitters

When replacing tires or wheels, tire pressure warning valves and transmitters must also be installed.

When new tire pressure warning valves and transmitters are installed, new ID codes must be registered in the tire pressure warning computer and the tire pressure warning system must be initialized. Have tire pressure warning valve and transmitter ID codes registered by your Toyota dealer. (→P. 369)

### ■ The tire pressure warning system must be initialized in the following circumstances:

- When the tire inflation pressure is changed such as when changing travelling speed or load weight
- When changing the tire size

When the tire pressure warning system is initialized, the current tire inflation pressure is set as the benchmark pressure.

### ■ How to initialize the tire pressure warning system

**STEP 1** Park the vehicle in a safe place and turn the engine switch (vehicles without a smart key system) or the “ENGINE START STOP” switch (vehicles with a smart key system) off.

Initialization cannot be performed while the vehicle is moving.

**STEP 2** Adjust the tire inflation pressure to the specified cold tire inflation pressure level. (→P. 474)

Make sure to adjust the tire pressure to the specified cold tire inflation pressure level. The tire pressure warning system will operate based on this pressure level.

**STEP 3** Turn the engine switch to the “ON” position (vehicles without a smart key system) or “ENGINE START STOP” switch to IGNITION ON mode (vehicles with a smart key system).



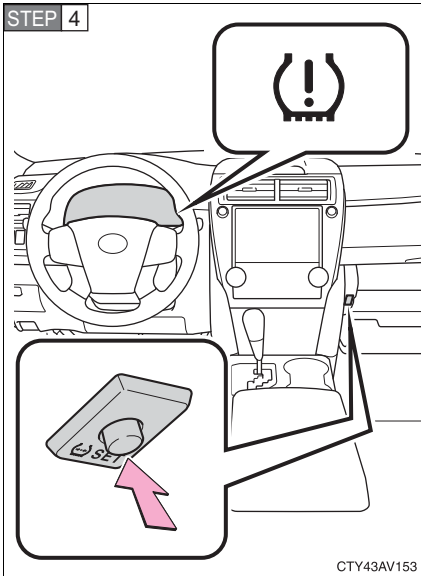

Press and hold the tire pressure warning reset switch until the tire pressure warning light blinks slowly 3 times.

**STEP 5** Vehicles without a smart key system: Wait for a few minutes with the engine switch in the “ON” position and then turn the engine switch to the “ACC” or “LOCK” position.  
 Vehicles with a smart key system: Wait for a few minutes with the “ENGINE START STOP” switch in IGNITION ON mode and then turn the “ENGINE START STOP” switch off.

### Registering ID codes

The tire pressure warning valve and transmitter is equipped with a unique ID code. When replacing a tire pressure warning valve and transmitter, it is necessary to register the ID code. Have the ID code registered by your Toyota dealer.

### ■ **When to replace your vehicle's tires**

Tires should be replaced if:

- You have tire damage such as cuts, splits, cracks deep enough to expose the fabric, and bulges indicating internal damage
- A tire goes flat repeatedly or cannot be properly repaired due to the size or location of a cut or other damage

If you are not sure, consult with your Toyota dealer.

### ■ **Replacing tires and wheels**

If the ID code of the tire pressure warning valve and transmitter is not registered, the tire pressure warning system will not work properly. After driving for about 20 minutes, the tire pressure warning light blinks for 1 minute and stays on to indicate a system malfunction.

### ■ **Tire life**

Any tire over 6 years old must be checked by a qualified technician even if it has seldom or never been used or damage is not obvious.

### ■ **Routine tire inflation pressure checks**

The tire pressure warning system does not replace routine tire inflation pressure checks. Make sure to check tire inflation pressure as part of your routine of daily vehicle checks.

### ■ **Low profile tires (vehicles with 18-inch tires)**

Generally, low profile tires will wear more rapidly and tire grip performance will be reduced on snowy and/or icy roads when compared to standard tires. Be sure to use snow tires or tire chains on snowy and/or icy roads and drive carefully at a speed appropriate for road and weather conditions.

### ■ Maximum load of tire

Check that the maximum load of the replacement tire is greater than 1/2 of the Gross Axle Weight Ratings (GAWR) of either the front axle or the rear axle, whichever is greater.

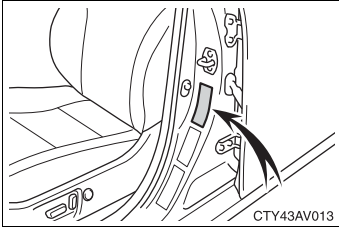

For the GAWR, see the Certification Label. For the maximum load of the tire, see the load limit at maximum cold tire inflation pressure mentioned on the sidewall of the tire. (→P. 481)

### ■ Tire types

#### ● Summer tires

Summer tires are high-speed performance tires best suited to highway driving under dry conditions. Since summer tires do not have the same traction performance as snow tires, summer tires are inadequate for driving on snow-covered or icy roads. For driving on snow-covered roads or icy roads, the use of snow tires is recommended. When installing snow tires, be sure to replace all four tires.

#### ● All season tires

All season tires are designed to provide better traction in snow and to be adequate for driving in most winter conditions as well as for use year-round. All season tires, however, do not have adequate traction performance compared with snow tires in heavy or loose snow. Also, all season tires fall short in acceleration and handling performance compared with summer tires in highway driving.

#### ● Snow tires

For driving on snow-covered roads or icy roads, we recommend using snow tires. If you need snow tires, select tires of the same size, construction and load capacity as the originally installed tires. Since your vehicle has radial tires as original equipment, make sure your snow tires also have radial construction. Do not install studded tires without first checking local regulations for possible restrictions. Snow tires should be installed on all wheels. (→P. 218)

### ■ Initializing the tire pressure warning system

Initialize the system with the tire inflation pressure adjusted to the specified level.

### ■ If the tread on snow tires wears down below 0.16 in. (4 mm)

The effectiveness of the tires as snow tires is lost.

### ■ If you press the tire pressure warning reset switch accidentally

If initialization is performed, adjust the tire inflation pressure to the specified level and initialize the tire pressure warning system again.

### ■ When the initialization of the tire pressure warning system has failed

Initialization can be completed in a few minutes. However, in the following cases, the settings have not been recorded and the system will not operate properly. If repeated attempts to record tire inflation pressure settings are unsuccessful, have the vehicle inspected by your Toyota dealer.

- When operating the tire pressure warning reset switch, the tire pressure warning light does not blink 3 times.
- After driving for a certain period of time since the initialization has been completed, the warning light comes on after blinking for 1 minute.

### ■ Certification for the tire pressure warning system

FCC ID: PAXPMVC010

FCC ID: HYQ23AAD

#### NOTE:

This device complies with Part 15 of the FCC Rules. Operation is subject to the following two conditions: (1) This device may not cause harmful interference, and (2) this device must accept any interference received, including interference that may cause undesired operation.

#### FCC WARNING:

Changes or modifications not expressly approved by the party responsible for compliance could void the user's authority to operate the equipment.

 **CAUTION****■ When inspecting or replacing tires**

Observe the following precautions to prevent accidents.

Failure to do so may cause damage to parts of the drive train as well as dangerous handling characteristics, which may lead to an accident resulting in death or serious injury.

- Do not mix tires of different makes, models or tread patterns.  
Also, do not mix tires of remarkably different treadwear.
- Do not use tire sizes other than those recommended by Toyota.
- Do not mix differently constructed tires (radial, bias-belted or bias-ply tires).
- Do not mix summer, all season and snow tires.
- Do not use tires that have been used on another vehicle.  
Do not use tires if you do not know how they were used previously.

**■ When initializing the tire pressure warning system**

Do not operate the tire pressure warning reset switch without first adjusting the tire inflation pressure to the specified level. Otherwise, the tire pressure warning light may not come on even if the tire inflation pressure is low, or it may come on when the tire inflation pressure is actually normal.

 NOTICE

■ **Repairing or replacing tires, wheels, tire pressure warning valves, transmitters and tire valve caps**

- When removing or fitting the wheels, tires or the tire pressure warning valves and transmitters, contact your Toyota dealer as the tire pressure warning valves and transmitters may be damaged if not handled correctly.
- When replacing tire valve caps, do not use tire valve caps other than those specified. The cap may become stuck.

■ **To avoid damage to the tire pressure warning valves and transmitters**

When a tire is repaired with liquid sealants, the tire pressure warning valve and transmitter may not operate properly. If a liquid sealant is used, contact your Toyota dealer or other qualified service shop as soon as possible. Make sure to replace the tire pressure warning valve and transmitter when replacing the tire. (→P. 368)

■ **Driving on rough roads**

Take particular care when driving on roads with loose surfaces or potholes.

These conditions may cause losses in tire inflation pressure, reducing the cushioning ability of the tires. In addition, driving on rough roads may cause damage to the tires themselves, as well as the vehicle's wheels and body.

■ **Low profile tires (vehicles with 18-inch tires)**

Low profile tires may cause greater damage than usual to the tire wheel when sustaining impact from the road surface. Therefore, pay attention to the following:

- Be sure to use proper tire inflation pressure. If tires are under-inflated, they may be damaged more severely.
- Avoid potholes, uneven pavement, curbs and other road hazards. Failure to do so may lead to severe tire and wheel damage.

■ **If tire inflation pressure of each tire becomes low while driving**

Do not continue driving, or your tires and/or wheels may be ruined.

## 4-3. Do-it-yourself maintenance

### Tire inflation pressure

#### ■ Tire inflation pressure

The recommended cold tire inflation pressure and tire size are displayed on the tire and loading information label. (→P. 474)

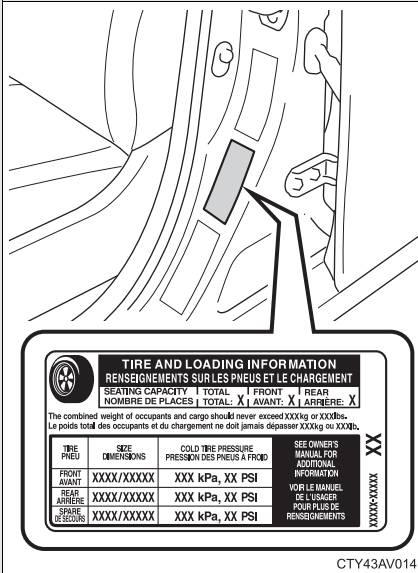

### ■ Inspection and adjustment procedure

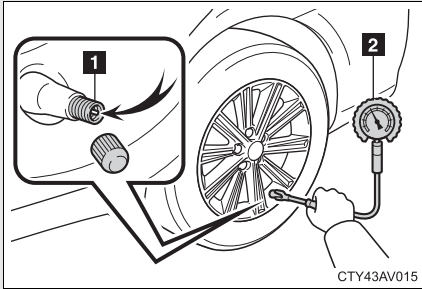

- 1 Tire valve
- 2 Tire pressure gauge

**STEP 1** Remove the tire valve cap.

**STEP 2** Press the tip of the tire pressure gauge onto the tire valve.

**STEP 3** Read the pressure using the gauge gradations.

**STEP 4** If the tire inflation pressure is not at the recommended level, adjust the pressure.

If you add too much air, press the center of the valve to deflate.

**STEP 5** After completing the tire inflation pressure measurement and adjustment, apply soapy water to the valve and check for leakage.

**STEP 6** Put the tire valve cap back on.

### ■ Tire inflation pressure check interval

You should check tire inflation pressure every two weeks, or at least once a month.

Do not forget to check the spare.



### ■ Effects of incorrect tire inflation pressure

Driving with incorrect tire inflation pressure may result in the following:

- Reduced fuel efficiency
- Reduced driving comfort and tire life
- Reduced safety
- Damage to the drive train

If a tire needs frequent inflating, have it checked by your Toyota dealer.

### ■ Instructions for checking tire inflation pressure

When checking tire inflation pressure, observe the following:

- Check only when the tires are cold.  
If your vehicle has been parked for at least 3 hours or has not been driven for more than 1 mile or 1.5 km, you will get an accurate cold tire inflation pressure reading.
- Always use a tire pressure gauge.  
The appearance of the tire can be misleading. In addition, tire inflation pressure that is even just a few pounds off can affect ride quality and handling.
- Do not reduce tire inflation pressure after driving. It is normal for tire inflation pressure to be higher after driving.
- Never exceed the vehicle capacity weight.  
Passengers and luggage weight should be placed so that the vehicle is balanced.

 CAUTION

■ **Proper inflation is critical to save tire performance**

Keep your tires properly inflated. Otherwise, the following conditions may occur and result in an accident causing death or serious injury:

- Excessive wear
- Uneven wear
- Poor handling
- Possibility of blowouts resulting from overheated tires
- Poor sealing of the tire bead
- Wheel deformation and/or tire separation
- A greater possibility of tire damage from road hazards

 NOTICE

■ **When inspecting and adjusting tire inflation pressure**

Be sure to put the tire valve caps back on.

Without the valve caps, dirt or moisture could get into the valve and cause air leakage, which could result in an accident. If the caps are lost, replace them as soon as possible.

## Wheels

**If a wheel is bent, cracked or heavily corroded, it should be replaced. Otherwise, the tire may separate from the wheel or cause a loss of handling control.**

### ■ Wheel selection

When replacing wheels, care should be taken to ensure that they are equivalent to those removed in load capacity, diameter, rim width, and inset\*.

Replacement wheels are available at your Toyota dealer.

\*: Conventionally referred to as “offset”.

Toyota does not recommend using the following:

- Wheels of different sizes or types
- Used wheels
- Bent wheels that have been straightened

### ■ Aluminum wheel precautions (if equipped)

- Use only Toyota wheel nuts and wrenches designed for use with your aluminum wheels.
- When rotating, repairing or changing your tires, check that the wheel nuts are still tight after driving 1000 miles (1600 km).
- Be careful not to damage the aluminum wheels when using tire chains.
- Use only Toyota genuine balance weights or equivalent and use a plastic or rubber hammer when balancing your wheels.

■ **When replacing wheels (vehicles with a tire pressure warning system)**

The wheels of your vehicle are equipped with tire pressure warning valves and transmitters that allow the tire pressure warning system to provide advance warning in the event of a loss in tire inflation pressure. Whenever wheels are replaced, tire pressure warning valves and transmitters must be installed. (→P. 368)

**⚠ CAUTION**

■ **When replacing wheels**

- Do not use wheels that are a different size from those recommended in the Owner's Manual, as this may result in loss of handling control.
- Never use an inner tube in a leaking wheel which is designed for a tubeless tire. Doing so may result in an accident, causing death or serious injury.

■ **When installing the wheel nuts**

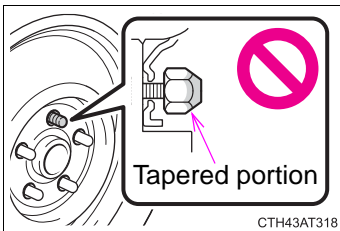

- Be sure to install the wheel nuts with the tapered ends facing inward. Installing the nuts with the tapered ends facing outward can cause the wheel to break and eventually cause the wheel to come off while driving, which could lead to an accident resulting in death or serious injury.

- Never use oil or grease on the wheel bolts or wheel nuts. Oil and grease may cause the wheel nuts to be excessively tightened, leading to bolt or disc wheel damage. In addition, the oil or grease can cause the wheel nuts to loosen and the wheel may fall off, causing an accident and resulting in death or serious injury. Remove any oil or grease from the wheel bolts or wheel nuts.

 NOTICE**■ Replacing tire pressure warning valves and transmitters (vehicles with a tire pressure warning system)**

- Because tire repair or replacement may affect the tire pressure warning valves and transmitters, make sure to have tires serviced by your Toyota dealer or other qualified service shop. In addition, make sure to purchase your tire pressure warning valves and transmitters at your Toyota dealer.
- Ensure that only genuine Toyota wheels are used on your vehicle. Tire pressure warning valves and transmitters may not work properly with non-genuine wheels.

## 4-3. Do-it-yourself maintenance

### Air conditioning filter

The air conditioning filter must be changed regularly to maintain air conditioning efficiency.

#### ■ Removal method

**STEP 1** Vehicles without a smart key system: Turn the engine switch off.

Vehicles with a smart key system: Turn the “ENGINE START STOP” switch off.

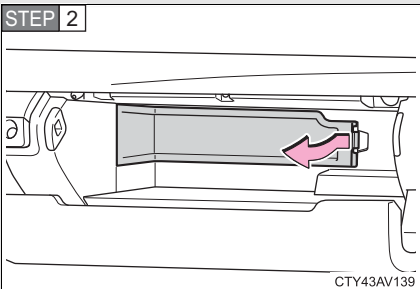

Open the glove box and remove the glove box cover inside the glove box.

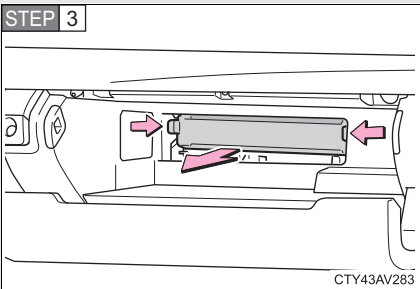

Remove the filter cover.

#### ■ Replacement method

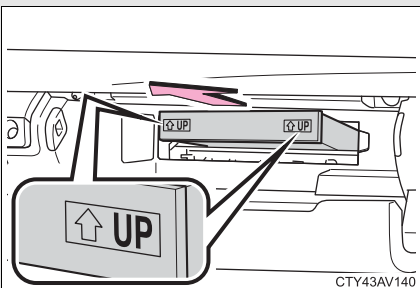

Remove the air conditioning filter and replace it with a new one.

The “↑UP” marks shown on the filter should be pointing up.

---

**■ Checking interval**

Inspect and replace the air conditioning filter according to the maintenance schedule. In dusty areas or areas with heavy traffic flow, early replacement may be required. (For scheduled maintenance information, please refer to the “Scheduled Maintenance Guide” or “Owner’s Manual Supplement”.)

**■ If air flow from the vents decreases dramatically**

The filter may be clogged. Check the filter and replace if necessary.

**NOTICE****■ When using the air conditioning system**

Make sure that a filter is always installed.

Using the air conditioning system without a filter may cause damage to the system.

Replace the battery with a new one if it is depleted.

■ You will need the following items:

- Flathead screwdriver
- Small flathead screwdriver
- Lithium battery CR2016 (vehicles without a smart key system), or CR2032 (vehicles with a smart key system)

■ Replacing the battery (vehicles without a smart key system)

Type A

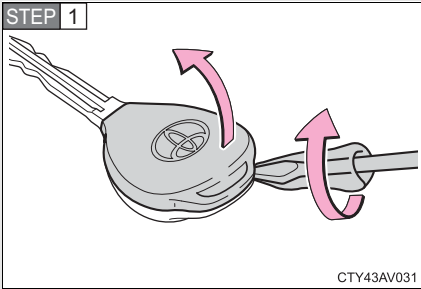

Remove the cover.

To prevent damage to the key, cover the tip of the screwdriver with a rag.

To prevent the buttons from being disassembled, face the button surface downward.

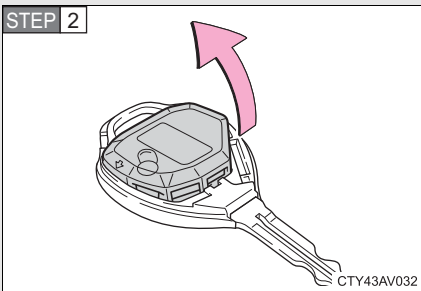

Remove the module.

\*: If equipped

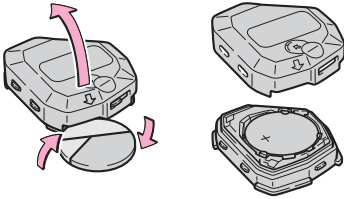

**STEP 3**

CTY43AV033

Open the case cover using a coin protected with tape etc. and remove the depleted battery.

Insert a new battery with the “+” terminal facing up.

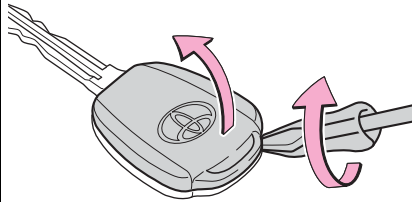
**Type B****STEP 1**

CTY43AV042

Remove the cover.

To prevent damage to the key, cover the tip of the screwdriver with a rag.

To prevent the buttons from being disassembled, face the button surface downward.

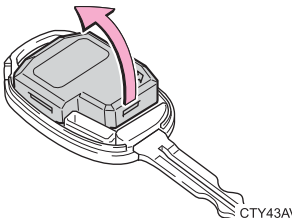
**STEP 2**

CTY43AV193

Remove the module.

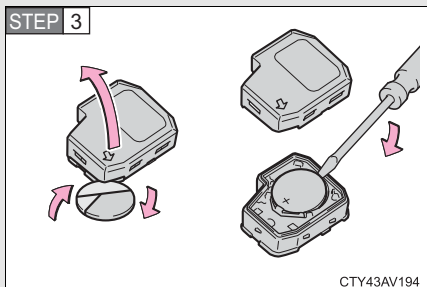

Open the case cover using a coin protected with tape etc. and remove the depleted battery using a small flathead screwdriver.

Insert a new battery with the “+” terminal facing up.

### ■ Replacing the battery (vehicles with a smart key system)

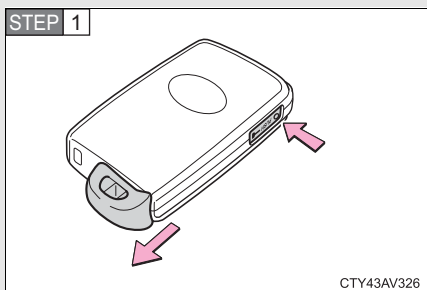

Take out the mechanical key.

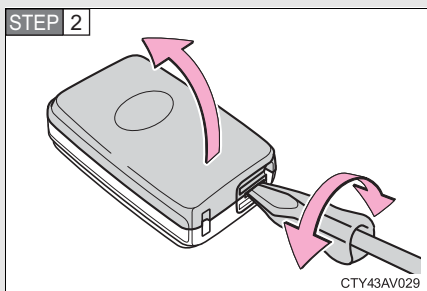

Remove the cover.

To prevent damage to the key, cover the tip of the screwdriver with a rag.

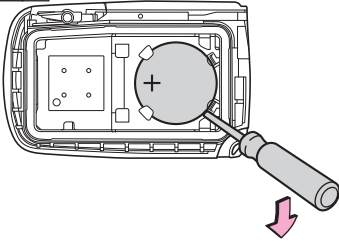
**STEP 3**

Remove the depleted battery using a small flathead screwdriver.

Insert a new battery with the “+” terminal facing up.

■ **Use a CR2016 (vehicles without a smart key system) or CR2032 (vehicles with a smart key system) lithium battery**

- Batteries can be purchased at your Toyota dealer, local electrical appliance shops or camera stores.
- Replace only with the same or equivalent type recommended by the manufacturer.
- Dispose of used batteries according to local laws.

■ **If the key battery is depleted**

The following symptoms may occur:

- The smart key system and wireless remote control will not function properly.
- The operational range will be reduced.

**⚠ CAUTION**

■ **Removed battery and other parts**

Keep away from children. These parts are small and if swallowed by a child, they can cause choking. Failure to do so could result in death or serious injury.

 NOTICE

■ **For normal operation after replacing the battery**

Observe the following precautions to prevent accidents:

- Always work with dry hands.  
Moisture may cause the battery to rust.
- Do not touch or move any other components inside the remote control.
- Do not bend either of the battery terminals.

## 4-3. Do-it-yourself maintenance

### Checking and replacing fuses

**If any of the electrical components do not operate, a fuse may have blown. If this happens, check and replace the fuses as necessary.**

**STEP 1** Vehicles without a smart key system: Turn the engine switch off.

Vehicles with a smart key system: Turn the “ENGINE START STOP” switch off.

**STEP 2** Open the fuse box cover.

#### Engine compartment

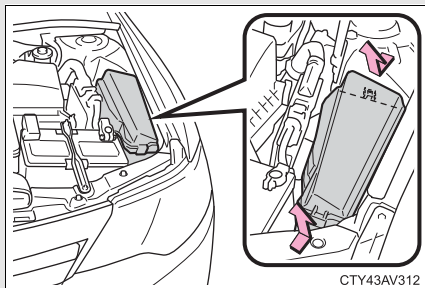

Push the tabs in and lift the lid off.

#### Under the instrument panel

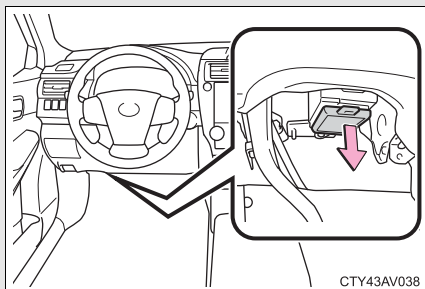

Remove the lid.

**STEP 3** After a system failure, see “Fuse layout and amperage ratings” (→P. 392) for details about which fuse to check.

**STEP 4** Remove the fuse.

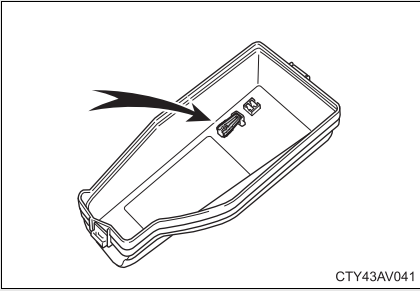

Only type A fuse can be removed using the pullout tool.

**STEP 5** Check if the fuse has blown.

**Type A**

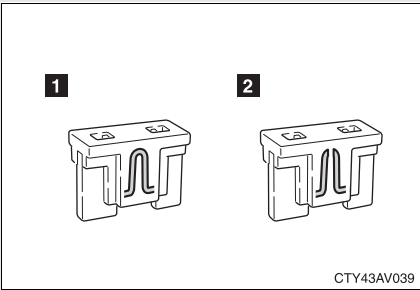

**1** Normal fuse

**2** Blown fuse

Replace the blown fuse with a new fuse of an appropriate amperage rating. The amperage rating can be found on the fuse box lid.

**Type B**

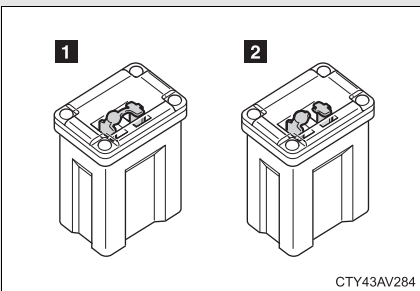

**1** Normal fuse

**2** Blown fuse

Replace the blown fuse with a new fuse of an appropriate amperage rating. The amperage rating can be found on the fuse box lid.

## Type C

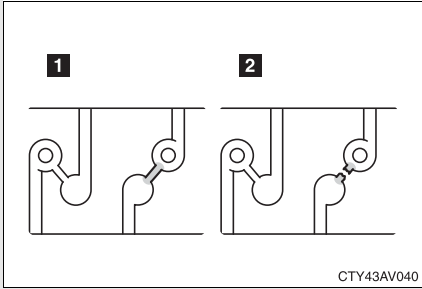

**1** Normal fuse

**2** Blown fuse

Contact your Toyota dealer.

## Fuse layout and amperage ratings

### ■ Engine compartment

#### Fuse block

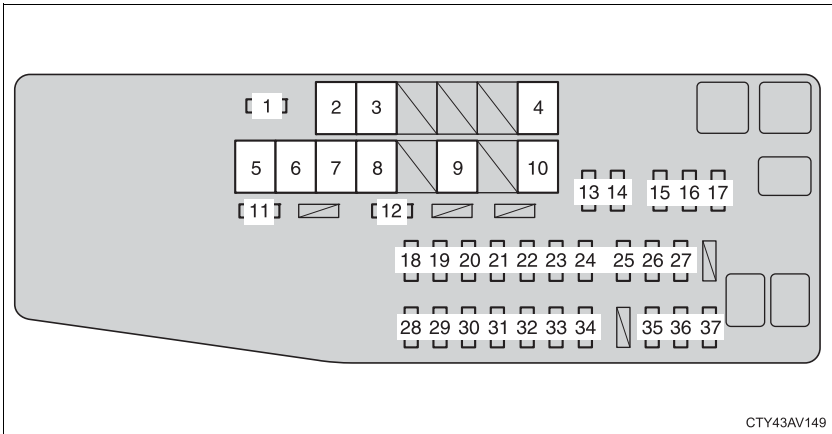

#### Fuse block on the back of the cover

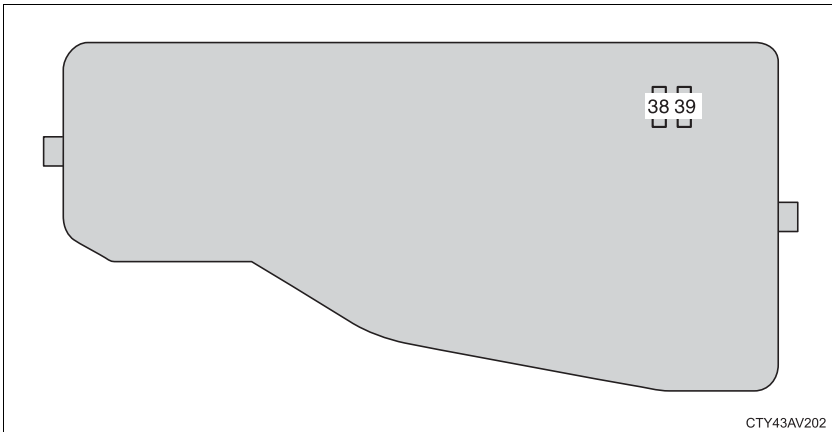



Fuse		Ampere	Circuit
1	METER-IG2	5 A	Gauge and meters
2	FAN* <sup>1</sup>	50 A	Electric cooling fans
3	H-LP CLN	30 A	No circuit
4	HTR	50 A	Air conditioning system
5	ALT	120 A	Charging system
6	ABS NO.2	30 A	Vehicle stability control system
7	ST/AM2	30 A	Starter system, ECU-IG2 NO.1, A/B, ECU-IG2 NO.2
8	H-LP-MAIN	30 A	H-LP LH-LO, H-LP RH-LO, MNL H-LP LVL, headlights (low beam)
9	ABS NO.1	50 A	Vehicle stability control system
10	EPS	80 A	Electric power steering
11	S-HORN	7.5 A	S-HORN
12	HORN	10 A	Horns
13	EFI NO.2	15 A	Multiport fuel injection system/ sequential multiport fuel injection system, electronic controlled trans- mission
14	EFI NO.3	7.5 A* <sup>2</sup>	Multiport fuel injection system/ sequential multiport fuel injection system
		10 A* <sup>1</sup>	
15	INJ	7.5 A	Multiport fuel injection system/ sequential multiport fuel injection system
16	ECU-IG2 NO.3	7.5 A	Multiport fuel injection system/ sequential multiport fuel injection system, steering lock system, elec- tronic controlled transmission
17	IGN	15 A	Starter system
18	D/L-AM2	20 A	No circuit

#### 4-3. Do-it-yourself maintenance

Fuse		Ampere	Circuit
19	IG2-MAIN	25 A	IGN, INJ, METER-IG2, ECU-IG2 NO.3, A/B, ECU-IG2 NO.2, ECU-IG2 NO.1
20	ALT-S	7.5 A	Charging system
21	MAYDAY	5 A	MAYDAY
22	TURN&HAZ	15 A	Turn signal lights, emergency flashers, gauge and meters
23	STRG LOCK	10 A	Steering lock system
24	AMP	15 A	Audio system
25	H-LP LH-LO	15 A <sup>*3</sup>	Left-hand headlight (low beam), manual headlight leveling system
		20 A <sup>*4</sup>	
26	H-LP RH-LO	15 A <sup>*3</sup>	Right-hand headlight (low beam)
		20 A <sup>*4</sup>	
27	MNL H-LP LVL <sup>*4</sup>	7.5 A	Manual headlight leveling system
28	EFI-MAIN NO.1	30 A	Multiport fuel injection system/ sequential multiport fuel injection system, EFI NO.2, EFI NO.3, A/F sensor
29	SMART	5 A	No circuit
30	ETCS	10 A	Electronic throttle control system
31	TOWING	20 A	No circuit
32	EFI NO.1	7.5 A	Multiport fuel injection system/ sequential multiport fuel injection system, electronic controlled transmission
33	EFI-MAIN NO.2 <sup>*2</sup>	20 A	A/F sensor
	A/F <sup>*1</sup>		
34	AM2	7.5 A	Smart key system

Fuse		Ampere	Circuit
35	RADIO-B	20 A	Audio system, navigation system
36	DOME	7.5 A	Clock, vanity lights, interior lights, personal lights, trunk light, door courtesy lights
37	ECU-B NO.1	10 A	Multiplex communication system, smart key system, gauge and meters, tire pressure warning system, wireless remote control, steering sensor, front passenger occupant classification system, Blind Spot Monitor
38	SPARE	25 A	Spare fuse
39	SPARE	30 A	Spare fuse

\*1: 3.5 L V6 (2GR-FE) engine

\*2: 2.5 L 4-cylinder (2AR-FE) engine

\*3: Vehicles with halogen headlight

\*4: Vehicles with discharge headlight

■ Under the instrument panel

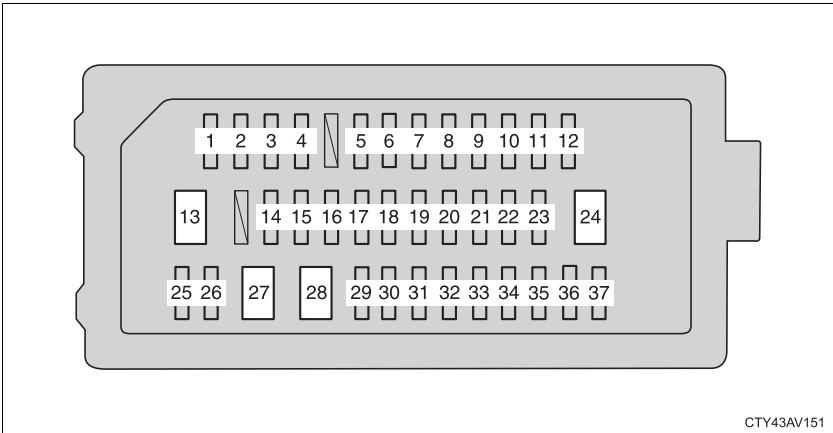

Fuse		Ampere	Circuit
1	ECU-IG1 NO.2	10 A	Shift lock control system, seat heaters, smart key system, tire pressure warning system, wireless remote control, multiplex communication system, audio system, navigation system, moon roof, auto anti-glare inside rear view mirror
2	ECU-IG1 NO.1	10 A	Vehicle stability control system, electric cooling fans, steering sensor, multiport fuel injection system/ sequential multiport fuel injection system, charging system, rear window defogger, outside rear view mirror defoggers, Blind Spot Monitor
3	PANEL	10 A	Switch illumination, air conditioning system, shift lever light, glove box light, interior lights, personal lights, audio system, navigation system

Fuse		Ampere	Circuit
4	TAIL	15 A	Parking lights, side marker lights, tail lights, license plate lights, fog lights
5	EPS-IG1	7.5 A	Electric power steering
6	ECU-IG1 NO.3	7.5 A	Blind Spot Monitor
7	S/HTR&FAN F/L	10 A	Seat heaters
8	H-LP LVL	7.5 A	No circuit
9	WASHER	10 A	Windshield wipers and washer
10	A/C-IG1	7.5 A	Air conditioning system
11	WIPER	25 A	Windshield wipers and washer
12	BKUP LP	7.5 A	Back-up lights, multiport fuel injection system/sequential multiport fuel injection system, electronic controlled transmission, audio system, navigation system
13	DOOR NO.1	30 A	Power windows
14	WIPER-S	5 A	No circuit
15	P/OUTLET RR	20 A	Power outlet
16	SFT LOCK- ACC	5 A	Shift lock control system
17	DOOR R/R	20 A	Rear right-hand power windows
18	DOOR R/L	20 A	Rear left-hand power windows
19	OBD	10 A	On-Board diagnosis system
20	ECU-B NO.2	10 A	Smart key system, tire pressure warning system
21	DOOR NO.2	20 A	Power windows
22	AM1	7.5 A	Multiport fuel injection system/ sequential multiport fuel injection system, starter system

Fuse		Ampere	Circuit
23	STOP	7.5 A	Tail lights, multiport fuel injection system/sequential multiport fuel injection system, vehicle stability control system, anti-lock brake system, electronic controlled transmission, high mounted stoplight, smart key system, shift lock control system
24	P/SEAT RR	30 A	No circuit
25	A/C-B	7.5 A	Air conditioning system
26	S/ROOF	10 A	Moon roof
27	P/SEAT FR	30 A	Power seats
28	PSB	30 A	No circuit
29	D/L-AM1	20 A	Multiplex communication system, power door lock, trunk opener switch
30	TI&TE	20 A	No circuit
31	A/B	10 A	Front passenger occupant classification system, SRS airbag system
32	ECU-IG2 NO.1	7.5 A	Multiport fuel injection system/sequential multiport fuel injection system
33	ECU-IG2 NO.2	7.5 A	Smart key system, Blind Spot Monitor
34	CIG&P/ OUTLET	15 A	Power outlet
35	ECU-ACC	7.5 A	Clock, outside rear view mirrors, multiplex communication system, audio system, navigation system
36	S/HTR&FAN F/ R	10 A	Seat heaters
37	S/HTR RR	20 A	No circuit

---

**■ After a fuse is replaced**

- If the lights do not turn on even after the fuse has been replaced, a bulb may need replacement. (→P. 401)
- If the replaced fuse blows again, have the vehicle inspected by your Toyota dealer.

**■ If there is an overload in a circuit**

The fuses are designed to blow, protecting the wiring harness from damage.

**■ When replacing light bulbs**

Toyota recommends that you use genuine Toyota products designed for this vehicle. Because certain bulbs are connected to circuits designed to prevent overload, non-genuine parts or parts not designed for this vehicle may be unusable.

 **CAUTION**

■ **To prevent system breakdowns and vehicle fire**

Observe the following precautions.

Failure to do so may cause damage, and possibly a fire or injury.

- Never use a fuse of a higher amperage rating than that indicated, or use any other object in place of a fuse.
- Always use a genuine Toyota fuse or equivalent.  
Never replace a fuse with a wire, even as a temporary fix.  
This can cause extensive damage or even fire.
- Do not modify the fuses or fuse boxes.

 **NOTICE**

■ **Before replacing fuses**

Have the cause of electrical overload determined and repaired by your Toyota dealer as soon as possible.



## Light bulbs

You may replace the following bulbs by yourself. The difficulty level of replacement varies depending on the bulb. If necessary bulb replacement seems difficult to perform, contact your Toyota dealer.

For more information about replacing other light bulbs, contact your Toyota dealer.

### ■ Preparing for light bulb replacement

Check the wattage of the light bulb to be replaced. (→P. 477)

### ■ Front bulb locations

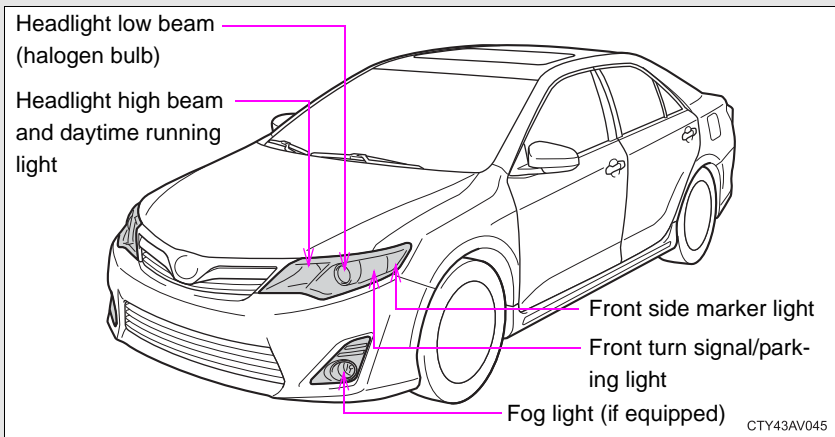

### ■ Rear bulb locations

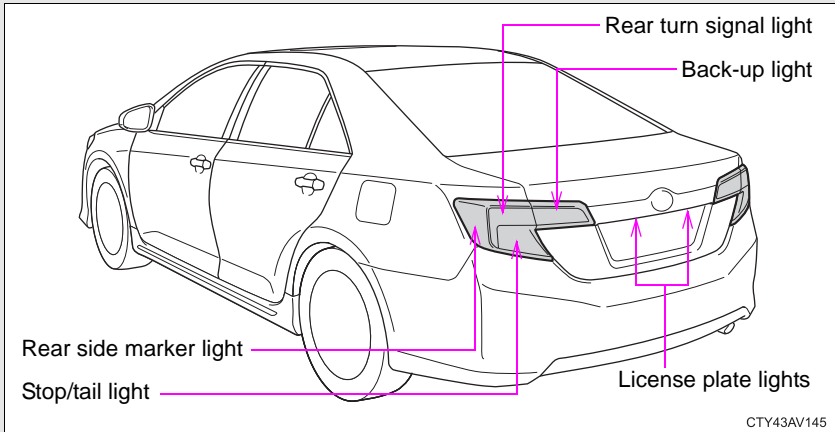

### Replacing light bulbs

#### ■ Headlight high beam and daytime running light

STEP 1

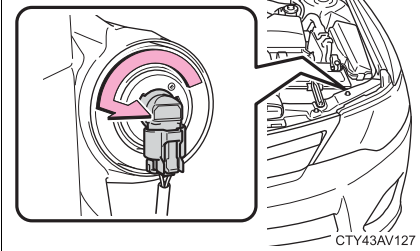

Turn the bulb base counterclockwise.

STEP 2

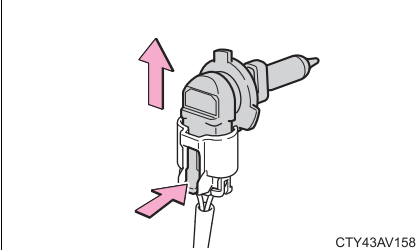

Unplug the connector while depressing the lock release.

## ■ Headlight low beam (halogen bulb)

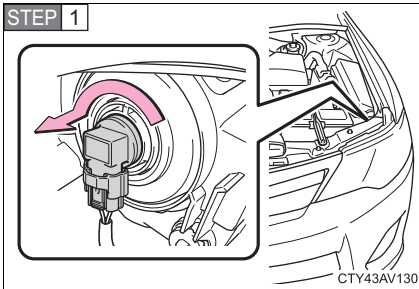

Turn the bulb base counterclockwise.

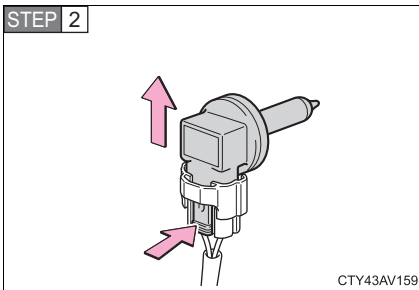

Unplug the connector while depressing the lock release.

## ■ Fog light (if equipped)

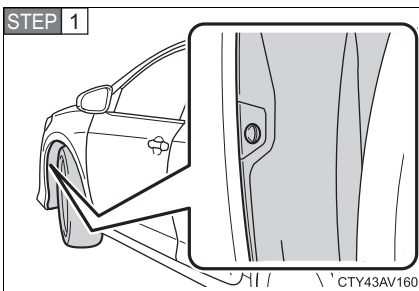

Turn the steering wheel in the opposite direction of the fog light that you wish to replace.

For example, if you wish to replace the fog light on the left side, turn the steering wheel to the right.

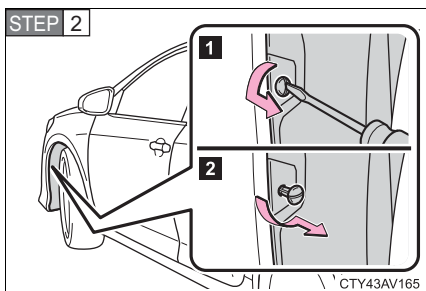

Remove the fender liner clip.

- 1** After turning the clip, pull the clip until it stops.
- 2** Turn the clip again, and then pull out the clip.

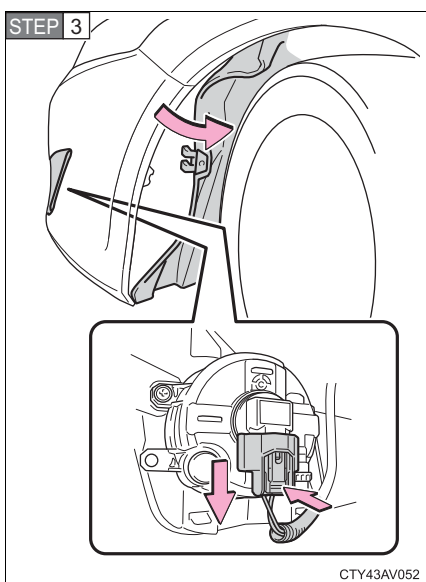

Partly remove the fender liner and unplug the connector while depressing the lock release.

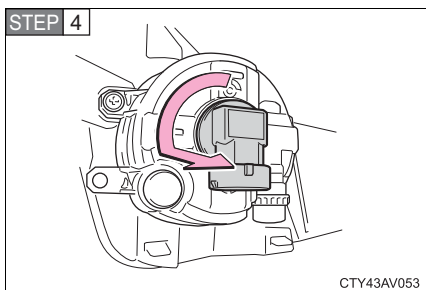

Turn the bulb base counterclockwise.

### ■ Front turn signal/parking light

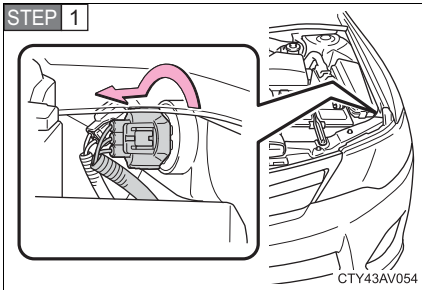

Turn the bulb base counterclockwise.

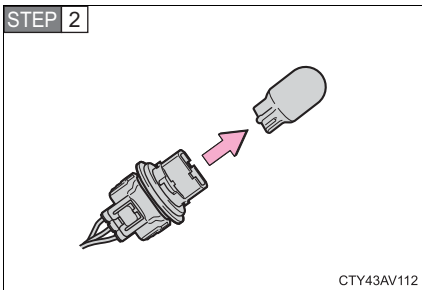

Remove the light bulb.

### ■ Front side marker light

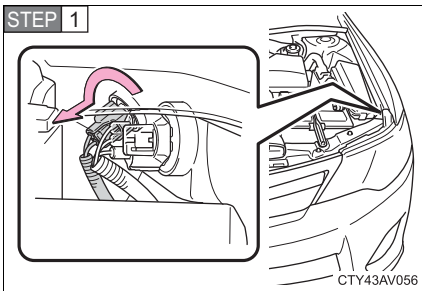

Turn the bulb base counterclockwise.

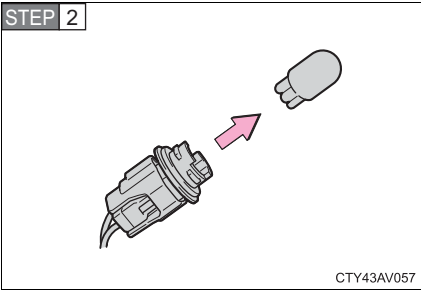

Remove the light bulb.

■ **Rear side marker light, rear turn signal light and stop/tail light**

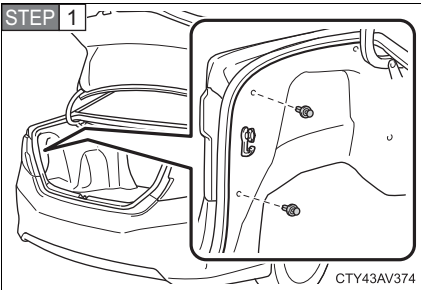

Open the trunk lid and remove the luggage trim cover clips.

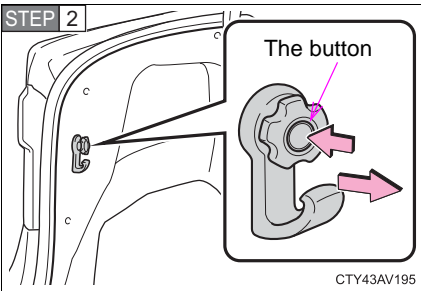

Pull the hook while depressing the button.

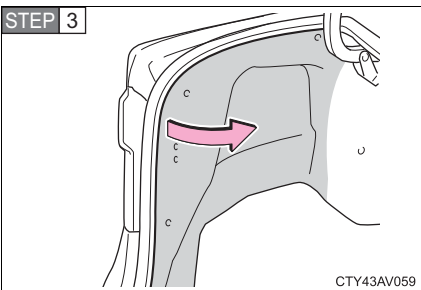

Partly remove the luggage trim cover.

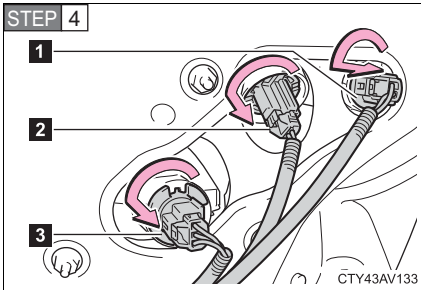

Turn the bulb base counterclockwise.

- 1 Rear side marker light
- 2 Rear turn signal light
- 3 Stop/tail light

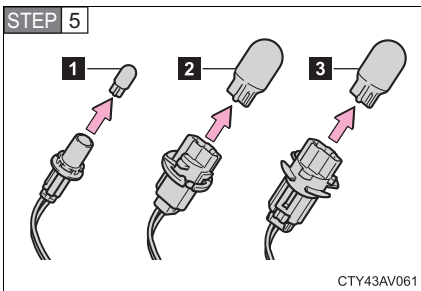

Remove the light bulb.

- 1 Rear side marker light
- 2 Rear turn signal light
- 3 Stop/tail light

## ■ Back-up light

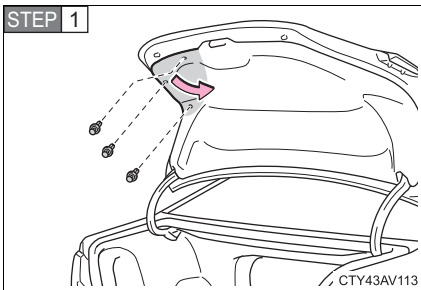

Open the trunk lid and remove the clips. Then partly remove the trunk panel cover.

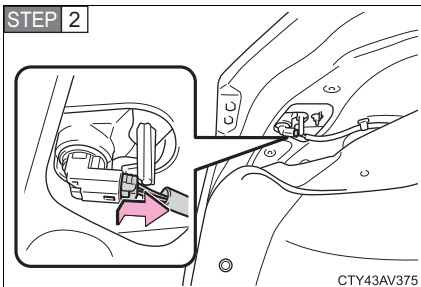

Unplug the connector while depressing the lock release.

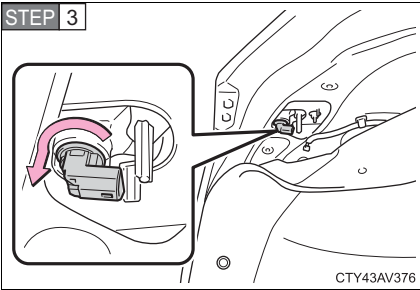

Turn the bulb base counterclockwise.

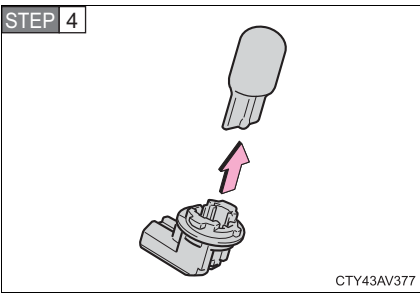

Remove the light bulb.

### ■ License plate light

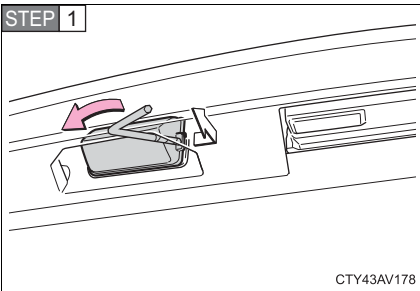

Remove the lens.

Insert a properly sized Allen key into the hole of the lens, and pry off the lens as shown in the illustration.

To prevent damaging the vehicle, wrap the tip of the Allen key with a tape.

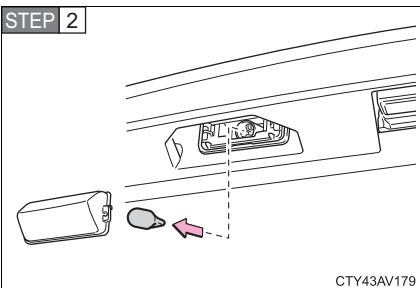

Remove the light bulb.



**■ Lights other than the above**

If any of the lights listed below has burnt out, have it replaced by your Toyota dealer.

- Headlight low beams (discharge bulb)
  - High mounted stoplight
- 

**■ Discharge headlights (if equipped)**

If voltage to the discharge bulbs is insufficient, the bulbs may not come on, or may go out temporarily. The discharge bulbs will come on when normal power is restored.

**■ LED light bulbs**

The high mounted stoplight consists of a number of LEDs. If any of the LEDs burn out, take your vehicle to your Toyota dealer to have the light replaced.

**■ Condensation build-up on the inside of the lens**

Contact your Toyota dealer for more information in the following situations. Temporary condensation build-up on the inside of the headlight lens does not indicate a malfunction.

- Large drops of water have built up on the inside of the lens.
- Water has built up inside the headlight.

## ■ Removing and installing the clips

### The luggage trim cover and trunk panel cover clip

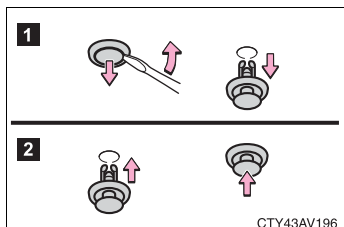

1 Removing

2 Installing

### The fender liner clip

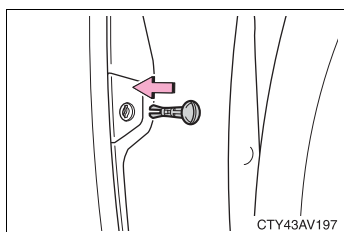

Installing

## ■ When replacing light bulbs

→P. 399

### ⚠ CAUTION

#### ■ Replacing light bulbs

- Turn off the lights. Do not attempt to replace the bulb immediately after turning off the lights. The bulbs become very hot and may cause burns.
- Do not touch the glass portion of the light bulb with bare hands. Hold the bulb by the plastic or metal portion. If the bulb is scratched or dropped, it may blow out or crack.
- Fully install light bulbs and any parts used to secure them. Failure to do so may result in heat damage, fire, or water entering the headlight unit. This may damage the headlights or cause condensation to build up on the lens.

**! CAUTION**

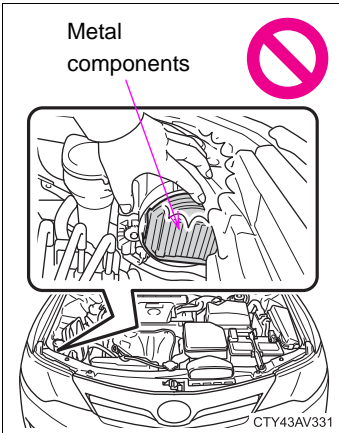

● Vehicles with discharge headlights:

While the low beam headlights are turned on, and for a short time after they have been turned off, metal components at the rear of the headlight assembly will be extremely hot. To prevent burns, do not touch these metal components until you are certain they have cooled down.

■ **Discharge headlights (if equipped)**

- Contact your Toyota dealer before replacing the discharge headlights (including light bulbs).
- Do not touch the discharge headlight's high voltage socket when the headlights are turned on.  
An extremely high voltage of 30000 V will be discharged and could result in serious injury or death by electric shock.
- Do not attempt to take apart or repair the low beam discharge headlight bulbs, connectors, power supply circuits, or related components.  
Doing so could result in electric shock and serious injury or death.

■ **To prevent damage or fire**

Make sure bulbs are fully seated and locked.



**5-1. Essential information**

Emergency flashers ..... 414  
If your vehicle needs to  
be towed ..... 415  
If you think something  
is wrong ..... 418  
Fuel pump shut off  
system ..... 419

**5-2. Steps to take in an  
emergency**

If a warning light turns  
on or a warning buzzer  
sounds... ..... 420  
If you have a flat tire..... 435  
If the engine will not  
start..... 447  
If the shift lever cannot  
be shifted from P..... 449  
If you lose your keys ..... 450  
If the electronic key  
does not operate  
properly..... 451  
If the battery is  
discharged ..... 454  
If your vehicle  
overheats ..... 459  
If the vehicle becomes  
stuck ..... 462  
If your vehicle has to  
be stopped in an  
emergency ..... 463

## 5-1. Essential information

### Emergency flashers

**Use the emergency flashers if the vehicle malfunctions or is involved in an accident.**

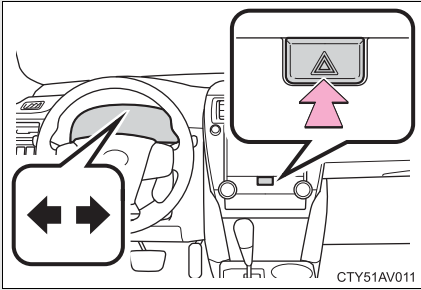

Press the switch to flash all the turn signal lights. To turn them off, press the switch once again.

#### NOTICE

##### **To prevent battery discharge**

Do not leave the emergency flashers on longer than necessary when the engine is not running.

## If your vehicle needs to be towed

**If towing is necessary, we recommend having your vehicle towed by your Toyota dealer or a commercial towing service, using a lift-type truck or flatbed truck.**

**Use a safety chain system for all towing, and abide by all state/provincial and local laws.**

### Before towing

The following may indicate a problem with your transmission. Contact your Toyota dealer before towing.

- The engine is running but the vehicle will not move.
- The vehicle makes an abnormal sound.

### Towing with a sling-type truck

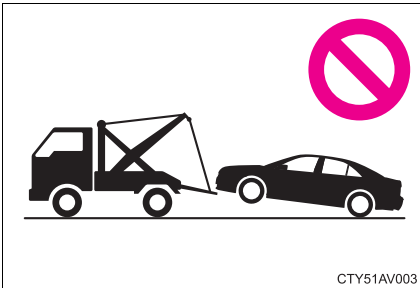

Do not tow with a sling-type truck to prevent body damage.

## Towing with a wheel-lift type truck

### From the front

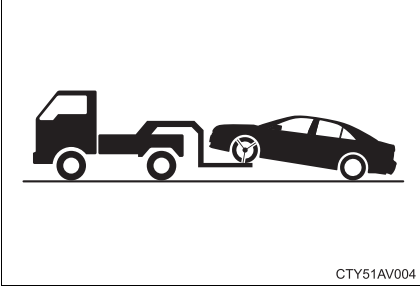

Release the parking brake.

### From the rear

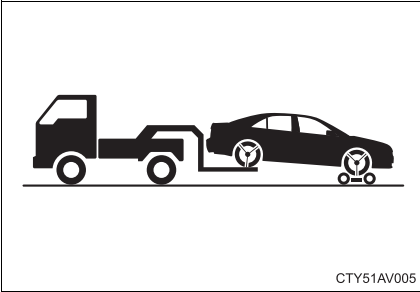

Use a towing dolly under the front wheels.

## Using a flatbed truck

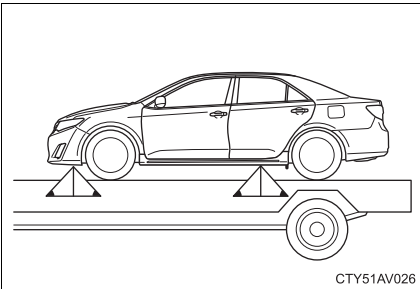

If you use chains or cables to tie down your vehicle, the angles shaded in black must be 45°.

Do not overly tighten the tie downs or the vehicle may be damaged.



 NOTICE

■ **To prevent causing serious damage to the transmission when towing using a wheel-lift type truck**

Never tow this vehicle from the rear with the front wheels on the ground.

■ **To prevent damage to the vehicle when towing using a wheel-lift type truck**

When raising the vehicle, ensure adequate ground clearance for towing at the opposite end of the raised vehicle. Without adequate clearance, the vehicle could be damaged while being towed.

■ **To prevent body damage when towing with a sling-type truck**

Do not tow with a sling-type truck, either from the front or rear.

## If you think something is wrong

**If you notice any of the following symptoms, your vehicle probably needs adjustment or repair. Contact your Toyota dealer as soon as possible.**

### ■ Visible symptoms

- Fluid leaks under the vehicle  
(Water dripping from the air conditioning after use is normal.)
- Flat-looking tires or uneven tire wear
- The rightmost segment of the engine coolant temperature display flashes

### ■ Audible symptoms

- Changes in exhaust sound
- Excessive tire squeal when cornering
- Strange noises related to the suspension system
- Pinging or other noises related to the engine

### ■ Operational symptoms

- Engine missing, stumbling or running roughly
- Appreciable loss of power
- Vehicle pulls heavily to one side when braking
- Vehicle pulls heavily to one side when driving on a level road
- Loss of brake effectiveness, spongy feeling, pedal almost touches the floor

## 5-1. Essential information

### Fuel pump shut off system

**To minimize the risk of fuel leakage when the engine stalls or when an airbag inflates upon collision, the fuel pump shut off system stops the supply of fuel to the engine.**

Follow the procedure below to restart the engine after the system is activated.

#### **Vehicles without a smart key system**

**STEP 1** Turn the engine switch to the “ACC” or “LOCK” position.

**STEP 2** Restart the engine.

#### **Vehicles with a smart key system**

**STEP 1** Turn the “ENGINE START STOP” switch off.

**STEP 2** Restart the engine.



#### **NOTICE**

##### **■ Before starting the engine**

Inspect the ground under the vehicle.

If you find that fuel has leaked on to the ground, the fuel system has been damaged and is in need of repair. Do not restart the engine.



## 5-2. Steps to take in an emergency

### If a warning light turns on or a warning buzzer sounds...

**Calmly perform the following actions if any of the warning lights comes on or flashes. If a light comes on or flashes, but then goes off, this does not necessarily indicate a malfunction in the system. However, if this continues to occur, have the vehicle inspected by your Toyota dealer.**

**Stop the vehicle immediately. Continuing to drive the vehicle may be dangerous.**





The following warning indicates a possible problem in the brake system. Immediately stop the vehicle in a safe place and contact your Toyota dealer.

Warning light	Warning light/Details
 (U.S.A.)  (Canada)	<b>Brake system warning light (warning buzzer)*</b> <ul style="list-style-type: none"><li>• Low brake fluid</li><li>• Malfunction in the brake system</li></ul> This light also comes on when the parking brake is not released. If the light turns off after the parking brake is fully released the system is operating normally.

\*: Parking brake engaged warning buzzer: The buzzer sounds to indicate that the parking brake is still engaged (with the vehicle having reached a speed of 3 mph [5 km/h]).

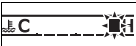

### Stop the vehicle immediately.







The following warning indicates the possibility of damage to the vehicle that may lead to an accident. Immediately stop the vehicle in a safe place and contact your Toyota dealer.

Warning light	Warning light/Details
	<b>Charging system warning light</b> Indicates a malfunction in the vehicle's charging system.
	<b>Low engine oil pressure warning light</b> Indicates that the engine oil pressure is too low.
<b>Type A</b>  <b>Type B</b> 	<b>High engine coolant temperature warning light (the rightmost segment of the engine coolant temperature display flashes)</b> Indicates that the engine is almost overheating. (→P. 459)

### Have the vehicle inspected by your Toyota dealer immediately.





Failure to investigate the cause of the following warnings may lead to the system operating abnormally and possibly cause an accident. Have the vehicle inspected by your Toyota dealer immediately.

Warning light	Warning light/Details
 (U.S.A.)  (Canada)	<b>Malfunction indicator lamp</b> Indicates a malfunction in: <ul style="list-style-type: none"> <li>• The electronic engine control system; or</li> <li>• The electronic throttle control system; or</li> <li>• The electronic automatic transmission control system.</li> </ul>

Warning light	Warning light/Details
	<p><b>SRS warning light</b>                      Indicates a malfunction in:</p> <ul style="list-style-type: none"> <li>• The SRS airbag system; or</li> <li>• The front passenger occupant classification system; or</li> <li>• The seat belt pretensioner system.</li> </ul>
<p><b>ABS</b> (U.S.A.)</p>  <p>(Canada)</p>	<p><b>ABS warning light</b>                      Indicates a malfunction in:</p> <ul style="list-style-type: none"> <li>• The ABS; or</li> <li>• The brake assist system.</li> </ul>
 <p>(Comes on in yellow)</p>	<p><b>Cruise control indicator light</b>                      Indicates a malfunction in the cruise control system.                      →P. 199</p>
 <p>(Comes on)</p>	<p><b>Slip indicator light</b>                      Indicates a malfunction in:</p> <ul style="list-style-type: none"> <li>• VSC system; or</li> <li>• TRAC system.</li> </ul>
	<p><b>Electric power steering system warning light (warning buzzer)</b>                      Indicates a malfunction in the EPS system.</p>
<p><b>BSM</b> (Comes on)</p>	<p><b>BSM warning light (if equipped)</b>                      Indicates a malfunction in the Blind Spot Monitor.</p>
 <p>(Flashes in yellow for 15 seconds.)</p>	<p><b>Smart key system indicator light (if equipped)</b>                      Indicates a malfunction in the smart key system.</p>

**Follow the correction procedures.**

After taking the specified steps to correct the suspected problem, check that the warning light goes off.

Warning light	Warning light/Details	Correction procedure
	<p><b>Open door warning light (warning buzzer)*<sup>1</sup></b> Indicates that a door or the trunk is not fully closed.</p>	<p>Check that all doors and the trunk are closed.</p>
	<p><b>Low fuel level warning light</b> Indicates remaining fuel is approximately 2.6 gal. (9.7 L, 2.1 Imp. gal.) or less.</p>	<p>Refuel the vehicle.</p>
	<p><b>Driver's/front passenger's seat belt reminder light (warning buzzer)*<sup>2</sup></b> Warns the driver/front passenger to fasten his/her seat belt.</p>	<p>Fasten the seat belt.</p>
	<p><b>Low windshield washer fluid warning light</b> Low level of washer fluid.</p>	<p>Fill the tank.</p>

Warning light	Warning light/Details	Correction procedure
<div style="border: 1px solid black; padding: 2px; display: inline-block; text-align: center;"> <b>MAINT REQD</b> </div> (U.S.A. only)	<p><b>Maintenance required reminder light</b>                      Indicates that maintenance is required according to the driven distance on the maintenance schedule*<sup>3</sup>.</p>	
	<p>Illuminates for about 3 seconds and then flashes for about 15 seconds approximately 4500 miles (7200 km) after the maintenance data has been reset.</p>	<p>If necessary, perform maintenance.</p>
	<p>Comes on and remains on if the distance driven exceeds 5000 miles (8000 km) after the maintenance data has been reset.                      (The indicator will not work properly unless the maintenance data has been reset.)</p>	<p>Perform the necessary maintenance.                      Please reset the maintenance data after the maintenance is performed.                      (→P. 340)</p>



Warning light	Warning light/Details	Correction procedure
 (U.S.A. only)	<b>Tire pressure warning light</b>	
	When the light comes on: Low tire inflation pressure such as <ul style="list-style-type: none"> <li>• Natural causes (→P. 430)</li> <li>• Flat tire (→P. 435)</li> </ul>	Adjust the tire inflation pressure to the specified level. The light will turn off after a few minutes. In case the light does not turn off even if the tire inflation pressure is adjusted, have the system checked by your Toyota dealer.
	When the light comes on after blinking for 1 minute: Malfunction in the tire pressure warning system. (→P. 432)	Have the system checked by your Toyota dealer.

**\*1: Open door warning buzzer:**

The open door warning buzzer sounds to alert the driver that one or more of the doors is not fully closed (with the vehicle having reached a speed of 3 mph [5 km/h]).

**\*2: Driver's seat belt buzzer:**

**Vehicles without a smart key system**

The driver's seat belt buzzer sounds to alert the driver that his or her seat belt is not fastened. Once the engine switch is turned to the "ON" position, the buzzer sounds for 6 seconds. If the vehicle reaches a speed of 12 mph (20 km/h), the buzzer sounds once. If the seat belt is still unfastened after 30 seconds, the buzzer will sound intermittently for 10 seconds. Then, if the seat belt is still unfastened, the buzzer will sound in a different tone for 20 more seconds.

### **Vehicles with a smart key system**

The driver's seat belt buzzer sounds to alert the driver that his or her seat belt is not fastened. Once the "ENGINE START STOP" switch is turned to ON mode, the buzzer sounds for 6 seconds. If the vehicle reaches a speed of 12 mph (20 km/h), the buzzer sounds once. If the seat belt is still unfastened after 30 seconds, the buzzer will sound intermittently for 10 seconds. Then, if the seat belt is still unfastened, the buzzer will sound in a different tone for 20 more seconds.



#### **Front passenger's seat belt buzzer:**

The front passenger's seat belt buzzer sounds to alert the front passenger that his or her seat belt is not fastened. The buzzer sounds once if the vehicle reaches a speed of 12 mph (20 km/h). If the seat belt is still unfastened after 30 seconds, the buzzer will sound intermittently for 10 seconds. Then, if the seat belt is still unfastened, the buzzer will sound in a different tone for 20 more seconds.





\*3: Refer to the separate "Scheduled Maintenance Guide" or "Owner's Manual Supplement" for the maintenance interval applicable to your vehicle.

**Follow the correction procedures. (vehicles with a smart key system)**

After taking the specified steps to correct the suspected problem, check that the warning light goes off.

Interior buzzer	Exterior buzzer	Warning light	Warning light/Details	Correction procedure
Continuous	Continuous	 <p>(Flashes in yellow)</p>	<p><b>Smart key system indicator light</b></p> <p>The electronic key was carried outside the vehicle and the driver's door was opened and closed while any shift position other than P was selected without turning off the "ENGINE START STOP" switch.</p>	<ul style="list-style-type: none"> <li>• Change the shift position to P.</li> <li>• Bring the electronic key back into the vehicle.</li> </ul>
Once	3 times	 <p>(Flashes in yellow)</p>	<p><b>Smart key system indicator light</b></p> <p>The electronic key was carried outside the vehicle and the driver's door was opened and closed while the shift position P was selected without turning off the "ENGINE START STOP" switch.</p>	<p>Turn the "ENGINE START STOP" switch off or bring the electronic key back into the vehicle.</p>
Once	3 times	 <p>(Flashes in yellow)</p>	<p><b>Smart key system indicator light</b></p> <p>Indicates that a door other than the driver's door has been opened and closed with the "ENGINE START STOP" switch in any mode other than off and the electronic key outside of the detection area.</p>	<p>Confirm the location of the electronic key.</p>

## 5-2. Steps to take in an emergency

Interior buzzer	Exterior buzzer	Warning light	Warning light/Details	Correction procedure
Once	Continuous (5 seconds)	 (Flashes in yellow)	<b>Smart key system indicator light</b> An attempt was made to exit the vehicle with the electronic key and lock the doors without first turning the “ENGINE START STOP” switch off.	Turn the “ENGINE START STOP” switch off and lock the doors again.
Once	—	 (Flashes in yellow for 15 seconds.)	<b>Smart key system indicator light</b> Indicates that the electronic key is not present when attempting to start the engine.	Confirm the location of the electronic key.
9 times	—	 (Flashes in yellow)	<b>Smart key system indicator light</b> An attempt was made to drive when the regular key was not inside the vehicle.	Confirm that the electronic key is inside the vehicle.
Once	—	 (Flashes in yellow for 15 seconds.)	<b>Smart key system indicator light</b> Indicates that the electronic key battery is low.	Replace the battery. (→P. 384)
Once	—	 (Flashes quickly in green for 15 seconds.)	<b>Smart key system indicator light</b> Indicates that the steering lock has not been released.	Release the steering lock. (→P. 152)

Interior buzzer	Exterior buzzer	Warning light	Warning light/Details	Correction procedure
Once	—	 (Flashes in yellow for 30 seconds.)	<b>Smart key system indicator light</b> <ul style="list-style-type: none"> <li>• When the doors were unlocked with the mechanical key and then the “ENGINE START STOP” switch was pressed, the electronic key could not be detected in the vehicle.</li> <li>• The electronic key could not be detected in the vehicle even after the “ENGINE START STOP” switch was pressed two consecutive times.</li> </ul>	Touch the electronic key to the “ENGINE START STOP” switch while depressing the brake pedal.

### ■ SRS warning light

This warning light system monitors the airbag sensor assembly, front airbag sensors, side and curtain shield airbag sensors, curtain shield airbag sensors, driver's seat belt buckle switch, front passenger occupant classification system (ECU and sensors), “AIR BAG ON” indicator light, “AIR BAG OFF” indicator light, front passenger's seat belt buckle switch, seat belt pretensioner assemblies, airbags, interconnecting wiring and power sources. (→P. 100)

### ■ Front passenger detection sensor, passenger seat belt reminder and warning buzzer

- If luggage is placed on the front passenger seat, the front passenger detection sensor may cause the warning light to flash and the warning buzzer to sound even if a passenger is not sitting in the seat.
- If a cushion is placed on the seat, the sensor may not detect a passenger, and the warning light may not operate properly.

■ **If the malfunction indicator lamp comes on while driving**

First check the following:

- Is the fuel tank empty?  
If it is, fill the fuel tank immediately.
- Is the fuel tank cap loose?  
If it is, tighten it securely.

The malfunction indicator lamp will go off after several driving trips. If the malfunction indicator lamp does not go off even after several trips, contact your Toyota dealer as soon as possible.

■ **When the tire pressure warning light comes on (if equipped)**

Check the tire inflation pressure and adjust to the appropriate level. Pushing the tire pressure warning reset switch will not turn off the tire pressure warning light.

■ **The tire pressure warning light may come on due to natural causes (vehicles with a tire pressure warning system)**

The tire pressure warning light may come on due to natural causes such as natural air leaks and tire inflation pressure changes caused by temperature. In this case, adjusting the tire inflation pressure will turn off the warning light (after a few minutes).

■ **When a tire is replaced with a spare tire (vehicles with a tire pressure warning system)**

The compact spare tire is not equipped with a tire pressure warning valve and transmitter. If a tire goes flat, the tire pressure warning light will not turn off even though the flat tire has been replaced with the spare tire. Replace the spare tire with the repaired tire and adjust the tire inflation pressure. The tire pressure warning light will go off after a few minutes.

■ **If the tire pressure warning system is not functioning (vehicles with a tire pressure warning system)**

The tire pressure warning system will be disabled in the following conditions:

(When the condition becomes normal, the system will work properly.)

- If tires not equipped with tire pressure warning valves and transmitters are used
- If the ID code on the tire pressure warning valves and transmitters is not registered in the tire pressure warning computer.
- If the tire inflation pressure is 73 psi (500 kPa, 5.1 kgf/cm<sup>2</sup> or bar) or higher

The tire pressure warning system may be disabled in the following conditions:

(When the condition becomes normal, the system will work properly.)

- If electronic devices or facilities using similar radio wave frequencies are nearby.
- If a radio set at a similar frequencies is in use in the vehicle
- If a window tint that affects the radio wave signals is installed
- If there is a lot of snow or ice on the vehicle, particularly around the wheels or wheel housings
- If non-genuine Toyota wheels are used. (Even if you use Toyota wheels, the tire pressure warning system may not work properly with some types of tires.)
- If tire chains are used

■ **If the tire pressure warning light frequently comes on after blinking for 1 minute (vehicles with a tire pressure warning system)**

If the tire pressure warning light frequently comes on after blinking for 1 minute when the engine switch (vehicles without a smart key system) or the “ENGINE START STOP” switch (vehicles with a smart key system) is turned on, have it checked by your Toyota dealer.

■ **Electric power steering system warning light (warning buzzer)**

The electric power steering system warning light may come on and the warning buzzer may sound when the voltage is low or the voltage drops.

■ **Customization that can be configured at Toyota dealer**

The vehicle speed linked seat belt reminder buzzer can be disabled. (Customizable features →P. 493) However, Toyota recommends that the seat belt reminder buzzer be operational to alert the driver and front passenger that the seat belts are not fastened.

 **CAUTION**

■ **When the electric power steering system warning light comes on**

The steering wheel may become extremely heavy.

If the steering wheel becomes heavier than usual when operating, hold firmly and operate using more force than usual.

■ **If the tire pressure warning light comes on (vehicles with a tire pressure warning system)**

Be sure to observe the following precautions. Failure to do so could cause loss of vehicle control and result in death or serious injury.

- Stop your vehicle in a safe place as soon as possible. Adjust the tire inflation pressure immediately.
- If the tire pressure warning light comes on even after tire inflation pressure adjustment, it is probable that you have a flat tire. Check the tires. If a tire is flat, change it with the spare tire and have the flat tire repaired by the nearest Toyota dealer.
- Avoid abrupt maneuvering and braking. If the vehicle tires deteriorate, you could lose control of the steering wheel or the brakes.



 CAUTION

■ **If a blowout or sudden air leakage should occur (vehicles with a tire pressure warning system)**

The tire pressure warning system may not activate immediately.

■ **Maintenance of the tires (vehicles with a tire pressure warning system)**

Each tire, including the spare (if provided), should be checked monthly when cold and inflated to the inflation pressure recommended by the vehicle manufacturer on the vehicle placard or tire inflation pressure label (tire and load information label). (If your vehicle has tires of a different size than the size indicated on the vehicle placard or tire inflation pressure label [tire and load information label], you should determine the proper tire inflation pressure for those tires.)

As an added safety feature, your vehicle has been equipped with a tire pressure monitoring system (TPMS-tire pressure warning system) that illuminates a low tire pressure telltale (tire pressure warning light) when one or more of your tires is significantly under-inflated. Accordingly, when the low tire pressure telltale (tire pressure warning light) illuminates, you should stop and check your tires as soon as possible, and inflate them to the proper pressure. Driving on a significantly under-inflated tire causes the tire to overheat and can lead to tire failure. Under-inflation also reduces fuel efficiency and tire tread life, and may affect the vehicle's handling and stopping ability.

Please note that the TPMS (tire pressure warning system) is not a substitute for proper tire maintenance, and it is the driver's responsibility to maintain correct tire pressure, even if under-inflation has not reached the level to trigger illumination of the TPMS low tire pressure telltale (tire pressure warning light).

 CAUTION

Your vehicle has also been equipped with a TPMS (tire pressure warning system) malfunction indicator to indicate when the system is not operating properly. The TPMS (tire pressure warning system) malfunction indicator is combined with the low tire pressure telltale (tire pressure warning light). When the system detects a malfunction, the telltale will flash for approximately one minute and then remain continuously illuminated. This sequence will continue upon subsequent vehicle start-ups as long as the malfunction exists. When the malfunction indicator is illuminated, the system may not be able to detect or signal low tire pressure as intended.

TPMS (tire pressure warning system) malfunctions may occur for a variety of reasons, including the installation of replacement or alternate tires or wheels on the vehicle that prevent the TPMS (tire pressure warning system) from functioning properly. Always check the TPMS (tire pressure warning system) malfunction telltale after replacing one or more tires or wheels on your vehicle to ensure that the replacement or alternate tires and wheels allow the TPMS (tire pressure warning system) to continue to function properly.

 NOTICE

■ **Precaution when installing a different tire (vehicles with a tire pressure warning system)**

When a tire of a different specification or maker is installed, the tire pressure warning system may not operate properly.

## 5-2. Steps to take in an emergency If you have a flat tire

**Remove the flat tire and replace it with the spare provided.**

■ **Before jacking up the vehicle**

- Stop the vehicle on a hard, flat surface.
- Set the parking brake.
- Shift the shift lever to P.
- Stop the engine.
- Turn on the emergency flashers.

■ **Location of the spare tire, jack and tools**

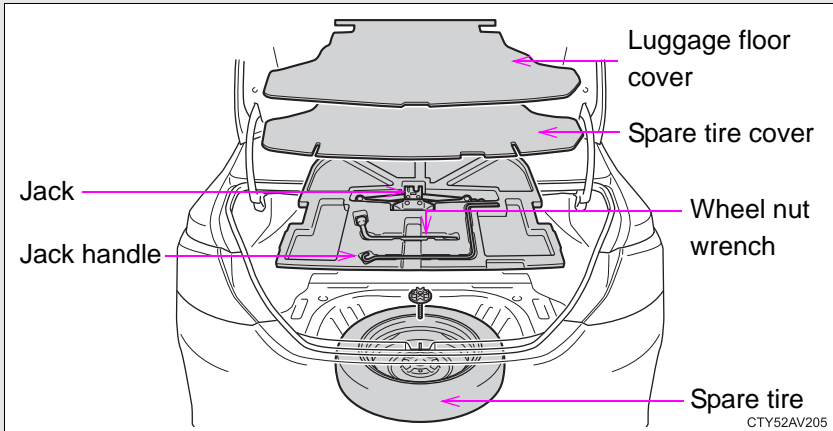

## Taking out the jack

STEP 1

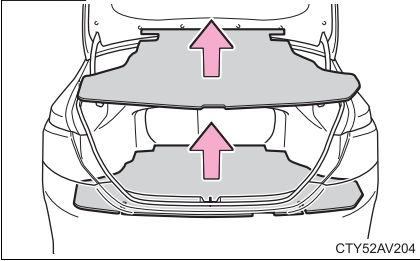

Remove the luggage floor cover and spare tire cover.

STEP 2

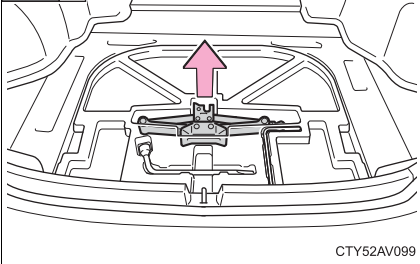

Remove the jack.

## Taking out the spare tire

STEP 1

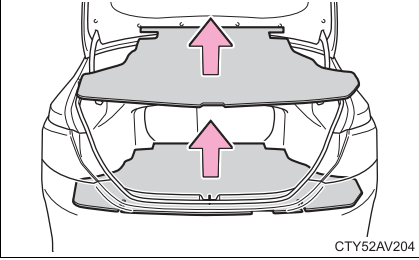

Remove the luggage floor cover and spare tire cover.

STEP 2

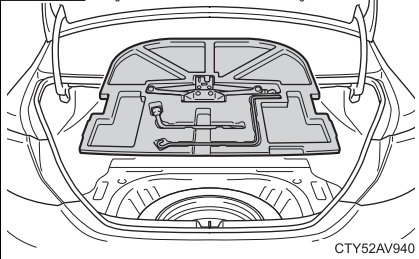

Remove the tool tray.

STEP 3

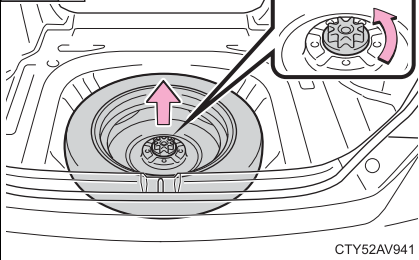

Loosen the center fastener that secures the spare tire.

When taking out or stowing the spare tire, make sure to firmly hold opposite ends of the tire.

## Replacing a flat tire

STEP 1

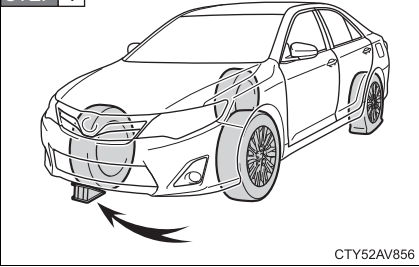

Chock the tires.

Flat tire		Wheel chock positions
Front	Left-hand side	Behind the rear right-hand side tire
	Right-hand side	Behind the rear left-hand side tire
Rear	Left-hand side	In front of the front right-hand side tire
	Right-hand side	In front of the front left-hand side tire

STEP 2

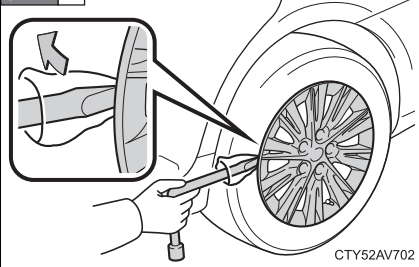

For vehicles with steel wheels, remove the wheel ornament using the wrench.

To protect the wheel ornament, place a rag between the wrench and the wheel ornament, as shown in the illustration.

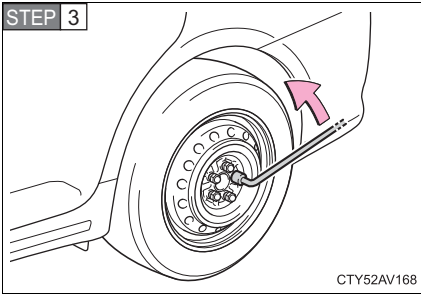

Slightly loosen the wheel nuts (one turn).

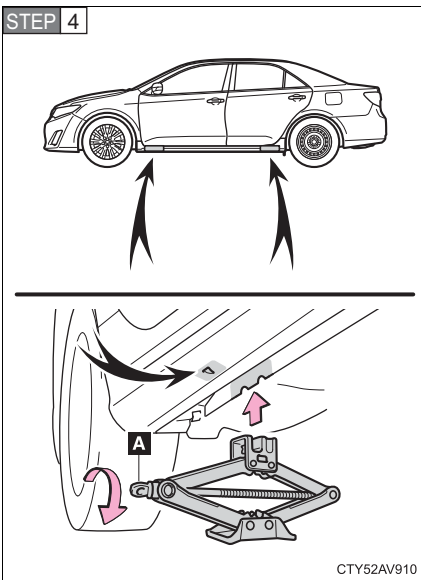

Turn the tire jack portion "A" by hand until the notch of the jack is in contact with the jack point.

The jack point guides are located under the rocker panel. They indicate the jack point positions.

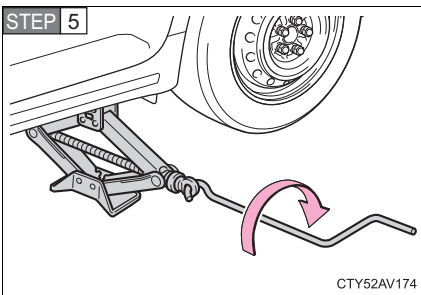

Raise the vehicle until the tire is slightly raised off the ground.

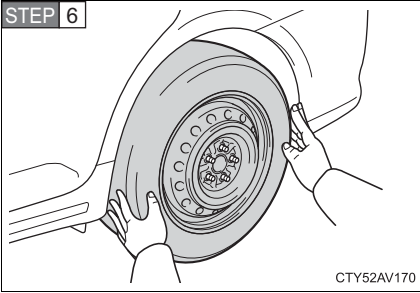

Remove all the wheel nuts and the tire.

When resting the tire on the ground, place the tire so that the wheel design faces up to avoid scratching the wheel surface.

### Installing the spare tire

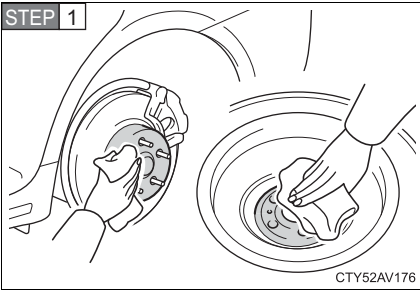

Remove any dirt or foreign matter from the wheel contact surface.

If foreign matter is on the wheel contact surface, the wheel nuts may loosen while the vehicle is in motion, causing the tire to come off.

**STEP 2** Install the tire and loosely tighten each wheel nut by hand by approximately the same amount.

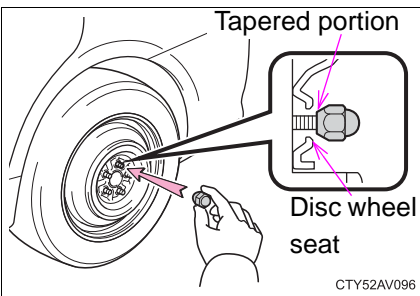

When replacing a steel wheel with a steel wheel, tighten the wheel nuts until the tapered portion comes into loose contact with the disc wheel seat.



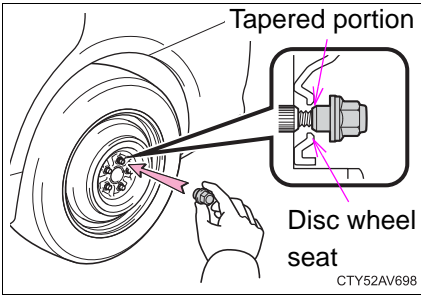

When replacing an aluminum wheel with a steel wheel, tighten the wheel nuts until the tapered portion comes into loose contact with the disc wheel seat.

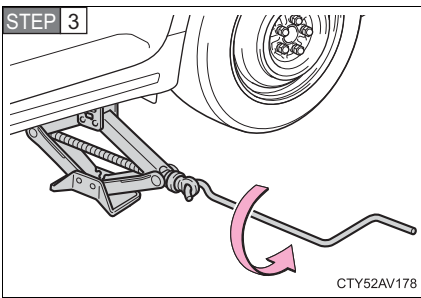

Lower the vehicle.

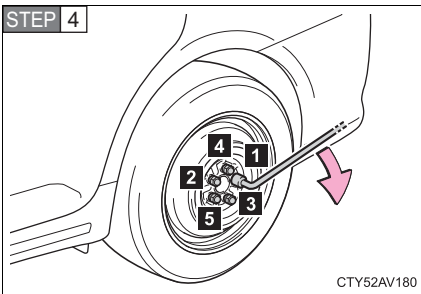

Firmly tighten each wheel nut two or three times in the order shown in the illustration.

**Tightening torque:**  
76 ft•lbf (103 N•m, 10.5 kgf•m)

**STEP 5** Stow the flat tire, tire jack and all tools.

■ **The compact spare tire**

- The compact spare tire is identified by the label “TEMPORARY USE ONLY” on the tire sidewall.

Use the compact spare tire temporarily, and only in an emergency.

- Make sure to check the tire inflation pressure of the compact spare tire. (→P. 474)

■ **After completing the tire change (vehicles with a tire pressure warning system)**

The tire pressure warning system must be reset. (→P. 368)

■ **When using the compact spare tire**

As the compact spare tire is not equipped with a tire pressure warning valve and transmitter, low inflation pressure of the spare tire will not be indicated by the tire pressure warning system. Also, if you replace the compact spare tire after the tire pressure warning light comes on, the light remains on.

■ **If you have a flat front tire on a road covered with snow or ice**

Install the compact spare tire on one of the rear wheels of the vehicle. Perform the following steps and fit tire chains to the front tires:

**STEP 1** Replace a rear tire with the compact spare tire.

**STEP 2** Replace the flat front tire with the tire removed from the rear of the vehicle.

**STEP 3** Fit tire chains to the front tires.

 **CAUTION****■ When using the compact spare tire**

- Remember that the compact spare tire provided is specifically designed for use with your vehicle. Do not use your compact spare tire on another vehicle.
- Do not use more than one compact spare tire simultaneously.
- Replace the compact spare tire with a standard tire as soon as possible.
- Avoid sudden acceleration, deceleration and braking, as well as sharp cornering.

**■ When storing the compact spare tire**

Be careful not to catch fingers or other body parts between the compact spare tire and the body of the vehicle.

**■ When the compact spare tire is attached**

The vehicle speed may not be correctly detected, and the following systems may not operate correctly:

- ABS & Brake assist
- Cruise control
- VSC
- TRAC
- EPS
- Navigation system (if equipped)

**■ Speed limit when using the compact spare tire**

Do not drive at speeds in excess of 50 mph (80 km/h) when a compact spare tire is installed on the vehicle.

The compact spare tire is not designed for driving at high speeds. Failure to observe this precaution may lead to an accident causing death or serious injury.

 CAUTION

■ **Using the tire jack**

Improper use of the tire jack may cause the vehicle to suddenly fall off the jack, leading to death or serious injury.

- Do not use the tire jack for any purpose other than replacing tires or installing and removing tire chains.
- Only use the tire jack that comes with this vehicle for replacing a flat tire.  
Do not use it on other vehicles, and do not use other tire jacks for replacing tires on this vehicle.
- Always check that the tire jack is securely set to the jack point.
- Do not put any part of your body under the vehicle while it is supported by the jack.
- Do not start or run the engine while your vehicle is supported by the jack.
- Do not raise the vehicle while someone is inside.
- When raising the vehicle, do not put an object on or under the jack.
- Do not raise the vehicle to a height greater than that required to replace the tire.
- Use a jack stand if it is necessary to get under the vehicle.

Take particular care when lowering the vehicle to ensure that no one working on or near the vehicle may be injured.

 CAUTION**■ Replacing a flat tire**

- Do not touch the disc wheels or the area around the brakes immediately after the vehicle has been driven.  
After the vehicle has been driven the disc wheels and the area around the brakes will be extremely hot. Touching these areas with hands, feet or other body parts while changing a tire, etc. may result in burns.
- Failure to follow these precautions could cause the wheel nuts to loosen and the tire to fall off, resulting in death or serious injury.
  - Have the wheel nuts tightened with a torque wrench to 76 ft•lbf (103 N•m, 10.5 kgf•m) as soon as possible after changing wheels.
  - Do not attach a heavily damaged wheel ornament, as it may fly off the wheel while the vehicle is moving.
  - When installing a tire, only use wheel nuts that have been specifically designed for that wheel.
  - If there are any cracks or deformations in the bolt screws, nut threads or bolt holes of the wheel, have the vehicle inspected by your Toyota dealer.
  - When installing the wheel nuts, be sure to install them with the tapered ends facing inward. (→P. 380)

 NOTICE

■ **Do not drive the vehicle with a flat tire.**

Do not continue driving with a flat tire.

Driving even a short distance with a flat tire can damage the tire and the wheel beyond repair.

■ **Be careful when driving over bumps with the compact spare tire installed on the vehicle.**

The vehicle becomes lower when driving with the compact spare tire compared to when driving with standard tires. Be careful when driving over uneven road surfaces.

■ **Driving with tire chains and the compact spare tire**

Do not fit tire chains to the compact spare tire.

Tire chains may damage the vehicle body and adversely affect driving performance.

■ **When replacing the tires (vehicles with a tire pressure warning system)**

When removing or fitting the wheels, tires or the tire pressure warning valve and transmitter, contact your Toyota dealer as the tire pressure warning valve and transmitter may be damaged if not handled correctly.

■ **To avoid damage to the tire pressure warning valves and transmitters (if equipped)**

When a tire is repaired with liquid sealants, the tire pressure warning valve and transmitter may not operate properly. If a liquid sealant is used, contact your Toyota dealer or other qualified service shop as soon as possible. Make sure to replace the tire pressure warning valve and transmitter when replacing the tire. (→P. 368)

## 5-2. Steps to take in an emergency If the engine will not start

**If the engine will not start even though correct starting procedures are being followed (→P. 145, 148), consider each of the following points:**

■ **The engine will not start even though the starter motor operates normally.**

One of the following may be the cause of the problem:

- There may not be sufficient fuel in the vehicle's tank.  
Refuel the vehicle.
- The engine may be flooded.  
Try to restart the engine again following correct starting procedures. (→P. 145, 148)
- There may be a malfunction in the engine immobilizer system.  
(→P. 92)

■ **The starter motor turns over slowly, the interior lights and headlights are dim, or the horn does not sound or sounds at a low volume.**

One of the following may be the cause of the problem:

- The battery may be discharged. (→P. 454)
- The battery terminal connections may be loose or corroded.

■ **The starter motor does not turn over (vehicles with a smart key system).**

The engine starting system may be malfunctioning due to an electrical problem such as an open circuit or a blown fuse. However, an interim measure is available to start the engine.  
(→P. 448)

■ **The starter motor does not turn over, the interior lights and headlights do not turn on, or the horn does not sound.**

One of the following may be the cause of the problem:

- One or both of the battery terminals may be disconnected.
- The battery may be discharged. (→P. 454)
- There may be a malfunction in the steering lock system (vehicles with a smart key system).

Contact your Toyota dealer if the problem cannot be repaired, or if repair procedures are unknown.

**Emergency start function (vehicles with a smart key system)**

When the engine does not start, the following steps can be used as an interim measure to start the engine if the “ENGINE START STOP” switch is functioning normally:

**STEP 1** Set the parking brake.

**STEP 2** Shift the shift lever to P.

**STEP 3** Set the “ENGINE START STOP” switch to ACCESSORY mode.

**STEP 4** Press and hold the “ENGINE START STOP” switch for about 15 seconds while depressing the brake pedal firmly.

Even if the engine can be started using the above steps, the system may be malfunctioning. Have the vehicle inspected by your Toyota dealer.



## If the shift lever cannot be shifted from P

If the shift lever cannot be shifted with your foot on the brake pedal, there may be a problem with the shift lock system (a system to prevent accidental operation of the shift lever). Have the vehicle inspected by your Toyota dealer immediately.

The following steps may be used as an emergency measure to ensure that the shift lever can be shifted:

**STEP 1** Set the parking brake.

**STEP 2** Vehicles without a smart key system: Turn the engine switch to the “ACC” position.

Vehicles with a smart key system: Turn the “ENGINE START STOP” switch to ACCESSORY mode.

**STEP 3** Depress the brake pedal.

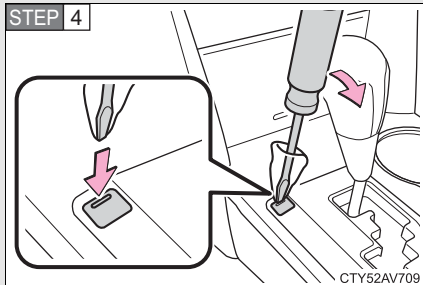

Pry the cover up with a flat-head screwdriver or equivalent.

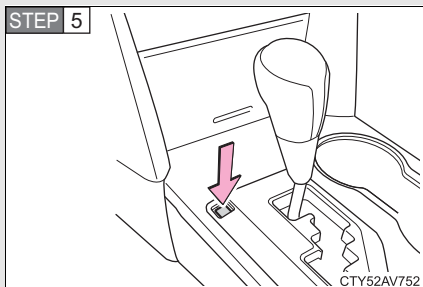

Press the shift lock override button.

The shift lever can be shifted while the button is pressed.

## If you lose your keys

**New genuine keys can be made by your Toyota dealer. For vehicles without the smart key system, bring a master key and the key number stamped on the key number plate. For vehicles with the smart key system, bring the other key and the key number stamped on the key number plate.**

## 5-2. Steps to take in an emergency

If the electronic key does not operate properly (vehicles with a smart key system)

If communication between the electronic key and the vehicle is interrupted (→P. 40) or the electronic key cannot be used because the battery is depleted, the smart key system and wireless remote control cannot be used. In such cases, the doors and trunk can be opened or the engine can be started by following the procedure below.

### Locking and unlocking the doors and key linked functions

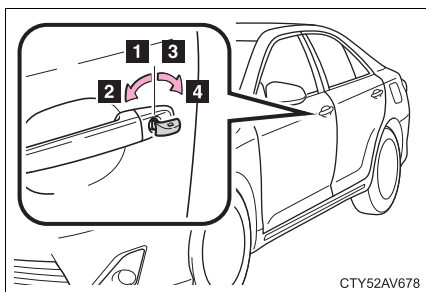

Using the mechanical key (→P. 29) in order to perform the following operations (driver's door only):

- 1** Locks all doors
- 2** Closes the windows and moon roof (turn and hold)\*
- 3** Unlocks the door

Turning the key rearward unlocks the driver's door. Turning the key once again unlocks the other doors.

- 4** Opens the windows and moon roof (turn and hold)\*

\*: This setting must be customized at your Toyota dealer.

## Starting the engine

**STEP 1** Ensure that the shift lever is in P and firmly depress the brake pedal.

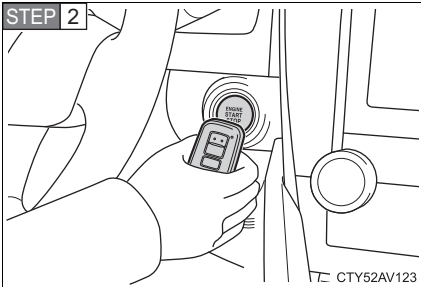

Touch the Toyota emblem side of the electronic key to the “ENGINE START STOP” switch.

The “ENGINE START STOP” switch will turn to IGNITION ON mode.

When the smart key system is deactivated in customization setting, the “ENGINE START STOP” switch will turn to ACCESSORY mode. Modes can be changed by pressing the “ENGINE START STOP” switch with brake pedal released. (The mode changes each time the switch is pressed.)

**STEP 3** Firmly depress the brake pedal and check that the smart key system indicator light (green) turns on.

**STEP 4** Press the “ENGINE START STOP” switch.

In the event that the “ENGINE START STOP” switch still cannot be operated, contact your Toyota dealer.

---

**■ Stopping the engine**

Shift the shift lever to P and press the “ENGINE START STOP” switch as you normally do when stopping the engine.

**■ Replacing the key battery**

As the above procedure is a temporary measure, it is recommended that the electronic key battery be replaced immediately when the battery is depleted. (→P. 384)

**■ If the doors cannot be locked or unlocked by the smart key system**

Lock and unlock the doors by the mechanical key or wireless remote control.

**■ When the electronic key does not work properly**

- Make sure that the smart key system has not been deactivated in the customization setting. If it is off, turn the function on. (Customizable features →P. 493)
- Check if battery-saving mode is set. If it is set, cancel the function. (→P. 39)

## 5-2. Steps to take in an emergency If the battery is discharged

The following procedures may be used to start the engine if the vehicle's battery is discharged.

You can also call your Toyota dealer or a qualified repair shop.

If you have a set of jumper (or booster) cables and a second vehicle with a 12-volt battery, you can jump start your vehicle by following the steps below.

**STEP 1** Open the hood. (→P. 350)

**STEP 2**

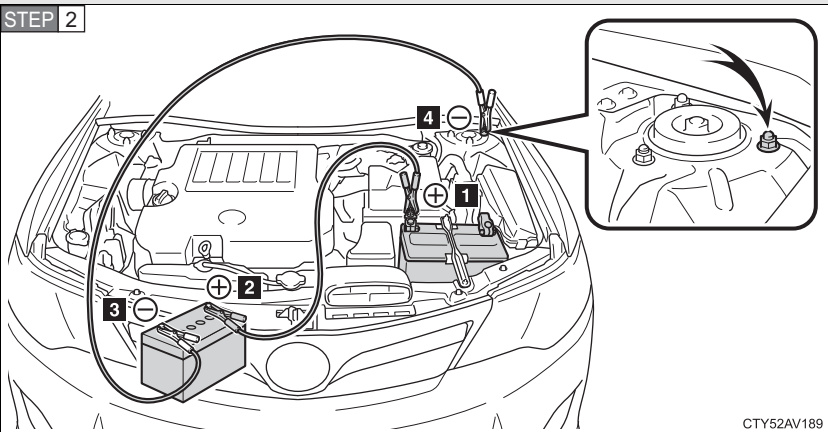

CTY52AV189

Connect the jumper cables according to the following procedure:

- 1** Positive (+) battery terminal on your vehicle
- 2** Positive (+) battery terminal on the second vehicle
- 3** Negative (-) battery terminal on the second vehicle
- 4** Connect the jumper cable to ground on your vehicle as shown in the illustration.

**STEP 3** Start the engine of the second vehicle. Increase the engine speed slightly and maintain at that level for approximately 5 minutes to recharge the battery of your vehicle.

**STEP 4** Vehicles with a smart key system: Open and close any of the doors with the “ENGINE START STOP” switch off.

**STEP 5** Vehicles without a smart key system: Maintain the engine speed of the second vehicle and turn the engine switch to the “ON” position, then start the vehicle's engine.

Vehicles with a smart key system: Maintain the engine speed of the second vehicle and turn the “ENGINE START STOP” switch to IGNITION ON mode, then start the vehicle's engine.

**STEP 6** Once the vehicle's engine has started, remove the jumper cables in the exact reverse order from which they were connected.

Once the engine starts, have the vehicle checked at your Toyota dealer as soon as possible.

■ **Starting the engine when the battery is discharged**

The engine cannot be started by push-starting.

■ **To prevent battery discharge**

- Turn off the headlights and the audio system while the engine is off.
- Turn off any unnecessary electrical components when the vehicle is running at a low speed for an extended period, such as in heavy traffic.

■ **Precautions when the battery is discharged (vehicles with a smart key system)**

- In some cases, it may not be possible to unlock the doors using the smart key system when the battery is discharged. Use the wireless remote control or the mechanical key to lock or unlock the doors.
- The engine may not start on the first attempt after the battery has recharged but will start normally after the second attempt. This is not a malfunction.
- The “ENGINE START STOP” switch mode is memorized by the vehicle. When the battery is reconnected, the system will return to the mode it was in before the battery was discharged. Before disconnecting the battery, turn the “ENGINE START STOP” switch off.  
If you are unsure what mode the “ENGINE START STOP” switch was in before the battery discharged, be especially careful when reconnecting the battery.



 **CAUTION****■ Avoiding battery fires or explosions**

Observe the following precautions to prevent accidentally igniting the flammable gas that may be emitted from the battery:

- Make sure each jumper cable is connected to the correct terminal and that it is not unintentionally in contact with any other than the intended terminal.
- Do not allow the + and - clamps of the jumper cables to come into contact with each other.
- Do not smoke, use matches, cigarette lighters or allow open flame near the battery.

**■ Battery precautions**

The battery contains poisonous and corrosive acidic electrolyte, while related parts contain lead and lead compounds. Observe the following precautions when handling the battery:

- When working with the battery, always wear safety glasses and take care not to allow any battery fluids (acid) to come into contact with skin, clothing or the vehicle body.
- Do not lean over the battery.
- In the event that battery fluid comes into contact with the skin or eyes, immediately wash the affected area with water and seek medical attention. Place a wet sponge or cloth over the affected area until medical attention can be received.
- Always wash your hands after handling the battery support, terminals, and other battery-related parts.
- Do not allow children near the battery.

**■ To prevent damage to the vehicle**

Do not pull- or push-start the vehicle as the three-way catalytic converter may overheat and become a fire hazard.

 NOTICE

■ **When handling jumper cables**

When connecting the jumper cables, ensure that they do not become entangled in the cooling fans or belt.

## 5-2. Steps to take in an emergency If your vehicle overheats

### If your engine overheats:

**STEP 1** Stop the vehicle in a safe place and turn off the air conditioning system.

**STEP 2** Check to see if steam is coming out from under the hood.

If you see steam:

Stop the engine. Carefully lift the hood after the steam subsides and then restart the engine.

If you do not see steam:

Leave the engine running and carefully lift the hood.

**STEP 3** Check to see if the cooling fans are operating.

If the fans are operating:

Wait until the high engine coolant temperature warning light goes off and then stop the engine.

If the fans are not operating:

Stop the engine immediately and call your Toyota dealer.

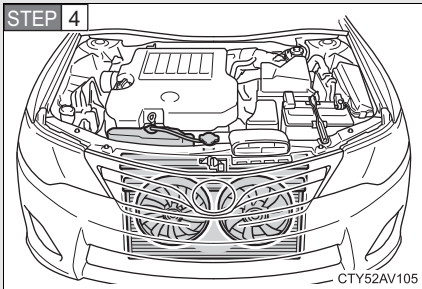

After the engine has cooled down sufficiently, check the engine coolant level and inspect the radiator core (radiator) for any leaks.

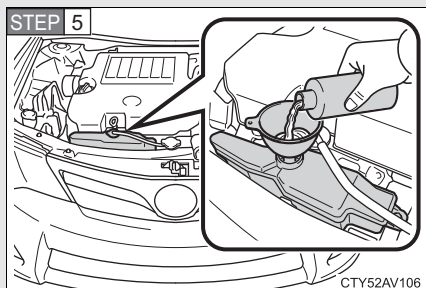

Add engine coolant if necessary.

Water can be used in an emergency if engine coolant is unavailable. (→P. 471)

Have the vehicle checked at the nearest Toyota dealer as soon as possible.

### ■ Overheating

If you observe the following, your vehicle may be overheating:

- The rightmost segment of the engine coolant temperature display is flashing or a loss of power is experienced.
- Steam comes out from under the hood.

### ⚠ CAUTION

#### ■ To prevent an accident or injury when inspecting under the hood of your vehicle

- If steam is seen coming from under the hood, do not open the hood until the steam has subsided. The engine compartment may be very hot, causing serious injuries such as burns.
- Keep hands and clothing away from the fans and drive belt while the engine is running.
- Do not loosen the coolant reservoir cap while the engine and radiator are hot.  
Serious injury, such as burns, may result from hot coolant and steam released under pressure.

**NOTICE****■ When adding engine coolant**

Wait until the engine has cooled down before adding engine coolant.

When adding coolant, do so slowly. Adding cool coolant to a hot engine too quickly can cause damage to the engine.

## 5-2. Steps to take in an emergency If the vehicle becomes stuck

**Carry out the following procedures if the tires spin or the vehicle becomes stuck in mud, dirt or snow:**

**STEP 1** Stop the engine. Set the parking brake and shift the shift lever to P.

**STEP 2** Remove the mud, snow or sand from around the stuck tire.

**STEP 3** Place wood, stones or some other material under the tires to help provide traction.

**STEP 4** Restart the engine.

**STEP 5** Shift the shift lever to the D or R position and carefully apply the accelerator to free the vehicle.

Turn off TRAC and VSC if these functions are hampering your attempts to free the vehicle. (→P. 204)

### CAUTION

#### ■ When attempting to free a stuck vehicle

If you choose to push the vehicle back and forth to free it, make sure the surrounding area is clear to avoid striking other vehicles, objects or people. The vehicle may also lunge forward or lunge back suddenly as it becomes free. Use extreme caution.

#### ■ When shifting the shift lever

Be careful not to shift the shift lever with the accelerator pedal depressed. This may lead to unexpected rapid acceleration of the vehicle that may cause an accident resulting in death or serious injury.

### NOTICE

#### ■ To avoid damage to the transmission and other components

- Avoid spinning the wheels and depressing the accelerator pedal more than necessary.
- If the vehicle remains stuck even after these procedures are performed, the vehicle may require towing to be freed.

## 5-2. Steps to take in an emergency

### If your vehicle has to be stopped in an emergency

**Only in an emergency, such as if it becomes impossible to stop the vehicle in the normal way, stop the vehicle using the following procedure:**

**STEP 1** Steadily step on the brake pedal with both feet and firmly depress it.

Do not pump the brake pedal repeatedly as this will increase the effort required to slow the vehicle.

**STEP 2** Shift the shift lever to N.

**If the shift lever is shifted to N**

**STEP 3** After slowing down, stop the vehicle in a safe place by the road.

**STEP 4** Stop the engine.

**If the shift lever cannot be shifted to N**

**STEP 3** Keep depressing the brake pedal with both feet to reduce vehicle speed as much as possible.

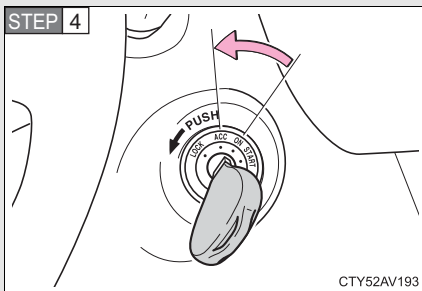

Vehicles without a smart key system: Stop the engine by turning the engine switch to the "ACC" position.

**STEP 4**

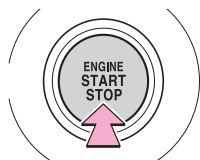

Press and hold for 2 seconds or more, or press briefly 3 times or more

CTY52AD212

Vehicles with a smart key system: To stop the engine, press and hold the “ENGINE START STOP” switch for 2 consecutive seconds or more, or press it briefly 3 times or more in succession.

**STEP 5**

Stop the vehicle in a safe place by the road.



**CAUTION**

**■ If the engine has to be turned off while driving**

- Power assist for the brakes and steering wheel will be lost, making the brake pedal harder to depress and the steering wheel heavier to turn. Decelerate as much as possible before turning off the engine.
- Vehicles without a smart key system: Never attempt to remove the key, as doing so will lock the steering wheel.



### 6-1. Specifications

Maintenance data (fuel, oil level, etc.) .....	466
Fuel information .....	478
Tire information .....	481

### 6-2. Customization

Customizable features .....	493
-----------------------------	-----

### 6-3. Initialization

Items to initialize .....	499
---------------------------	-----

## 6-1. Specifications

### Maintenance data (fuel, oil level, etc.)

#### Dimensions and weights

Overall length	189.2 in. (4805 mm)	
Overall width	71.7 in. (1820 mm)	
Overall height* <sup>1</sup>	57.9 in. (1470 mm)	
Wheelbase	109.3 in. (2775 mm)	
Tread	Front	62.0 in. (1575 mm) <sup>*2</sup> 62.4 in. (1585 mm) <sup>*3</sup>
	Rear	61.6 in. (1565 mm) <sup>*2</sup> 62.0 in. (1575 mm) <sup>*3</sup>
Vehicle capacity weight (Occupants + luggage)	905 lb. (410 kg)	

\*1: Unladen vehicles

\*2: P215/55R17 and P225/45R18 tires

\*3: P205/65R16 tires

#### Vehicle identification

##### ■ Vehicle identification number

The vehicle identification number (VIN) is the legal identifier for your vehicle. This is the primary identification number for your Toyota. It is used in registering the ownership of your vehicle.

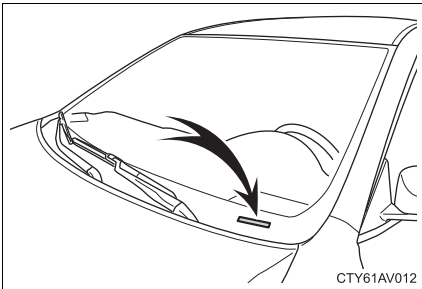

This number is located on the top left of the instrument panel.

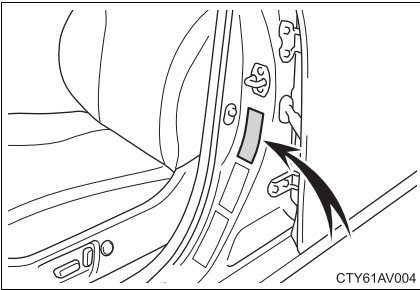

This number is also on the Certification Label.

### ■ Engine number

The engine number is stamped on the engine block as shown.

#### 2.5 L 4-cylinder (2AR-FE) engine

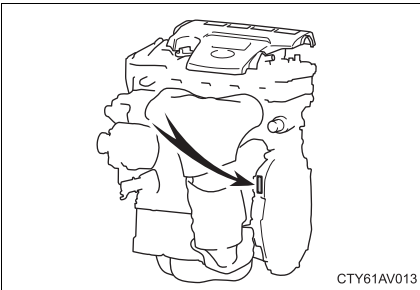

#### 3.5 L V6 (2GR-FE) engine

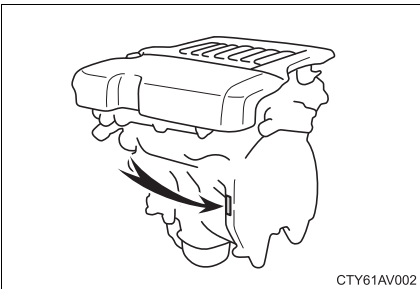

## Engine

Model	2AR-FE	2GR-FE
Type	4-cylinder in line, 4-cycle, gasoline	6-cylinder V type, 4-cycle, gasoline
Bore and stroke	3.54 × 3.86 in. (90.0 × 98.0 mm)	3.70 × 3.27 in. (94.0 × 83.0 mm)
Displacement	152.2 cu.in. (2494 cm <sup>3</sup> )	210.9 cu.in. (3456 cm <sup>3</sup> )
Drive belt tension	Automatic adjustment	
Valve clearance (engine cold)	Automatic adjustment	

### NOTICE

#### **■ Drive belt type (2.5 L 4-cylinder [2AR-FE] engine only)**

The high strength drive belt is used for the generator side drive belt.

When replacing the drive belt, use Toyota genuine drive belt or equivalent high strength drive belt. If the high strength drive belt is not used, durability of the belt may become less than expected. The high strength drive belt is a belt with Aramid core which has higher strength compared to usually available belts with PET or PEN core.

## Fuel

Fuel type	Unleaded gasoline only
Octane rating	87 (Research Octane Number 91) or higher
Fuel tank capacity (Reference)	17.0 gal. (64.35 L, 14.2 Imp. gal.)

## Lubrication system

Oil capacity (Drain and refill — reference*)	With filter	<b>2.5 L 4-cylinder (2AR-FE) engine</b> 4.6 qt. (4.4 L, 3.9 Imp. qt.) <b>3.5 L V6 (2GR-FE) engine</b> 6.4 qt. (6.1 L, 5.4 Imp. qt.)
	Without filter	<b>2.5 L 4-cylinder (2AR-FE) engine</b> 4.2 qt. (4.0 L, 3.5 Imp. qt.) <b>3.5 L V6 (2GR-FE) engine</b> 6.0 qt. (5.7 L, 5.0 Imp. qt.)

\*: The engine oil capacity is a reference quantity to be used when changing the engine oil. Warm up and turn off the engine, wait more than 5 minutes, and check the oil level on the dipstick.

### ■ Engine oil selection

“Toyota Genuine Motor Oil” is used in your Toyota vehicle. Use Toyota approved “Toyota Genuine Motor Oil” or equivalent to satisfy the following grade and viscosity.

Oil grade: ILSAC multigrade engine oil

Recommended viscosity: SAE 0W-20

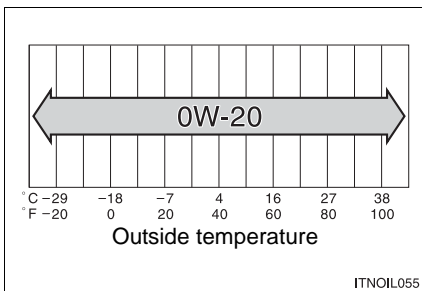

SAE 0W-20 is the best choice for good fuel economy and good starting in cold weather.

If SAE 0W-20 is not available, SAE 5W-20 oil may be used. However, it must be replaced with SAE 0W-20 at the next oil change.

Oil viscosity (0W-20 is explained here as an example):

- The 0W in 0W-20 indicates the characteristic of the oil which allows cold startability. Oils with a lower value before the W allow for easier starting of the engine in cold weather.
- The 20 in 0W-20 indicates the viscosity characteristic of the oil when the oil is at high temperature. An oil with a higher viscosity (one with a higher value) may be better suited if the vehicle is operated at high speeds, or under extreme load conditions.

How to read oil container label:

The ILSAC (International Lubricant Standardization and Approval Committee) Certification Mark is added to some oil containers to help you select the oil you should use.

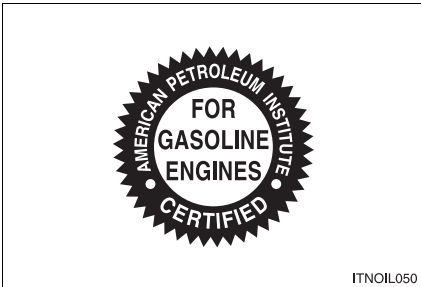

### Cooling system

Capacity (Reference)	<b>2.5 L 4-cylinder (2AR-FE) engine</b> 7.7 qt. (7.3 L, 6.4 Imp. qt.) <b>3.5 L V6 (2GR-FE) engine</b> 9.7 qt. (9.2 L, 8.1 Imp. qt.)
Coolant type	Use either of the following: <ul style="list-style-type: none"> <li>• “Toyota Super Long Life Coolant”</li> <li>• A similar high-quality ethylene glycol-based non-silicate, non-amine, non-nitrite, and non-borate coolant with long-life hybrid organic acid technology</li> </ul> Do not use plain water alone.

### Ignition system

Spark plug	
Make	<b>2.5 L 4-cylinder (2AR-FE) engine</b> DENSO SK16HR11 <b>3.5 L V6 (2GR-FE) engine</b> DENSO FK20HR11
Gap	0.043 in. (1.1 mm)



#### NOTICE

#### ■ Iridium-tipped spark plugs

Use only iridium-tipped spark plugs. Do not adjust the spark plug gap.

## Electrical system

Battery	12.6 — 12.8 V Fully charged 12.2 — 12.4 V Half charged 11.8 — 12.0 V Discharged (*: Voltage checked 20 minutes after the engine and all the lights are turned off)
Open voltage* at 68°F (20°C):	
Charging rates	5 A max.

## Automatic transaxle

Fluid capacity*	6.9 qt. (6.5 L, 5.7 Imp. qt.)
Fluid type	Toyota Genuine ATF WS

\*: The fluid capacity is a reference quantity. If replacement is necessary, contact your Toyota dealer.

### NOTICE

#### ■ Transmission fluid type

Using transmission fluid other than “Toyota Genuine ATF WS” may cause deterioration in shift quality, locking up of the transmission accompanied by vibration and, ultimately, damage to the vehicle’s transmission.



<b>Brakes</b>
---------------

Pedal clearance <sup>*1</sup>	3.8 in. (96 mm)
Pedal free play	0.04 — 0.24 in. (1 — 6 mm)
Brake pad wear limit	0.04 in. (1.0 mm)
Parking brake lining wear limit	0.04 in. (1.0 mm)
Parking brake pedal travel <sup>*2</sup>	7 — 10 clicks
Fluid type	SAE J1703 or FMVSS No.116 DOT 3

\*1: Minimum pedal clearance when depressed with a force of 112 lbf (500 N, 51 kgf) while the engine is running

\*2: Parking brake pedal travel when depressed with a force of 67 lbf (300 N, 31 kgf).

## Steering

Free play

Less than 1.2 in. (30 mm)

## Tires and wheels

### 16-inch tires

Tire size	P205/65R16 94S, T155/70D17 110M
Tire inflation pressure (Recommended cold tire inflation pressure)	<p>Driving under normal conditions</p> <p>Front: 35 psi (240 kPa, 2.4 kgf/cm<sup>2</sup> or bar)</p> <p>Rear: 35 psi (240 kPa, 2.4 kgf/cm<sup>2</sup> or bar)</p> <p>Spare:</p> <p>60 psi (420 kPa, 4.2 kgf/cm<sup>2</sup> or bar)</p> <p>Driving at high speeds (above 100 mph [160 km/h]) (in countries where such speeds are permitted by law)</p> <p>Add 3 psi (20 kPa, 0.2 kgf/cm<sup>2</sup> or bar) to the front tires and rear tires. Never exceed the maximum cold tire inflation pressure indicated on the tire sidewall.</p>
Wheel size	16 × 6 1/2 JJ, 17 × 4 T (compact spare)
Wheel nut torque	76 ft•lbf (103 N•m, 10.5 kgf•m)

**17-inch tires**

Tire size	P215/55R17 93V, T155/70D17 110M
Tire inflation pressure (Recommended cold tire inflation pressure)	<p>Driving under normal conditions</p> <p>Front: 35 psi (240 kPa, 2.4 kgf/cm<sup>2</sup> or bar)</p> <p>Rear: 35 psi (240 kPa, 2.4 kgf/cm<sup>2</sup> or bar)</p> <p>Spare:</p> <p>60 psi (420 kPa, 4.2 kgf/cm<sup>2</sup> or bar)</p> <p>Driving at high speeds (above 100 mph [160 km/h]) (in countries where such speeds are permitted by law)</p> <p>Add 6 psi (40 kPa, 0.4 kgf/cm<sup>2</sup> or bar) to the front tires and rear tires. Never exceed the maximum cold tire inflation pressure indicated on the tire sidewall.</p>
Wheel size	17 × 7 J, 17 × 4 T (compact spare)
Wheel nut torque	76 ft•lbf (103 N•m, 10.5 kgf•m)

**18-inch tires**

Tire size	P225/45R18 91V, T155/70D17 110M
Tire inflation pressure (Recommended cold tire inflation pressure)	<p>Driving under normal conditions            Front: 33 psi (230 kPa, 2.3 kgf/cm<sup>2</sup> or bar)            Rear: 33 psi (230 kPa, 2.3 kgf/cm<sup>2</sup> or bar)            Spare:            60 psi (420 kPa, 4.2 kgf/cm<sup>2</sup> or bar)</p> <p>Driving at high speeds (above 100 mph [160 km/h]) (in countries where such speeds are permitted by law)            Add 6 psi (40 kPa, 0.4 kgf/cm<sup>2</sup> or bar) to the front tires and rear tires. Never exceed the maximum cold tire inflation pressure indicated on the tire sidewall.</p>
Wheel size	18 × 7 1/2 J, 17 × 4 T (compact spare)
Wheel nut torque	76 ft•lbf (103 N•m, 10.5 kgf•m)

<b>Light bulbs</b>
--------------------

	Light Bulbs	Bulb No.	W	Type
Exterior	Headlights Low beam (halogen bulbs)*	—	55	A
	Low beam (discharge bulbs)*	—	35	C
	High beam	9005	60	B
	Front side marker lights	—	5	D
	Rear side marker lights	—	5	D
	Front turn signal/ parking lights	—	28/8	E
	Rear turn signal lights	—	21	E
	Stop/tail lights	—	21/5	D
	License plate lights	—	5	D
	Back-up lights	921	16	D
Fog lights*	—	55	A	
Interior	Interior/front personal lights	—	5	D
	Interior/rear personal lights*	—	8	D
	Rear interior light*	—	8	F
	Door courtesy lights	168	5	D
	Vanity lights*	—	8	D
	Trunk light	194	3.8	D

\*: If equipped

A: H11 halogen bulbs

B: HB3 halogen bulbs

C: D4S discharge bulbs

D: Wedge base bulbs (clear)

E: Wedge base bulbs (amber)

F: Double end bulbs

## 6-1. Specifications

# Fuel information

**You must only use unleaded gasoline in your vehicle.**

**Select octane rating 87 (Research Octane Number 91) or higher. Use of unleaded gasoline with an octane rating lower than 87 may result in engine knocking. Persistent knocking can lead to engine damage.**

At minimum, the gasoline you use should meet the specifications of ASTM D4814 in the U.S.A. and CGSB3.5-M93 in Canada.

---

### ■ Fuel tank opening for unleaded gasoline

To help prevent incorrect fueling, your vehicle has a fuel tank opening that only accommodates the special nozzle on unleaded fuel pumps.

### ■ Gasoline quality

In very few cases, driveability problems may be caused by the brand of gasoline you are using. If driveability problems persist, try changing the brand of gasoline. If this does not correct the problem, consult your Toyota dealer.

### ■ Gasoline quality standards

- Automotive manufacturers in the U.S.A., Europe and Japan have developed a specification for fuel quality called the World-Wide Fuel Charter (WWFC), which is expected to be applied worldwide.
- The WWFC consists of four categories that are based on required emission levels. In the U.S., category 4 has been adopted.
- The WWFC improves air quality by lowering emissions in vehicle fleets, and improves customer satisfaction through better performance.

### ■ Recommendation of the use of gasoline containing detergent additives

- Toyota recommends the use of gasoline that contains detergent additives to avoid the build-up of engine deposits.
- All gasoline sold in the U.S.A. contains detergent additives to clean and/or keep clean intake systems.

### ■ Recommendation of the use of cleaner burning gasoline

Cleaner burning gasoline, including reformulated gasoline that contains oxygenates such as ethanol or MTBE (Methyl Tertiary Butyl Ether) is available in many areas.

Toyota recommends the use of cleaner burning gasoline and appropriately blended reformulated gasoline. These types of gasoline provide excellent vehicle performance, reduce vehicle emissions and improve air quality.

### ■ Non-recommendation of the use of blended gasoline

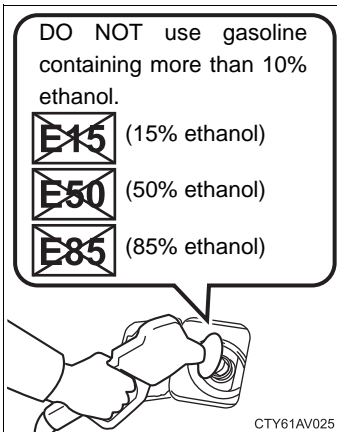

- Use only gasoline containing a maximum of 10% ethanol.  
DO NOT use any flex-fuel or gasoline that could contain more than 10% ethanol, including from any pump labeled E15, E30, E50, E85 (which are only some examples of fuel containing more than 10% ethanol).

- If you use gasohol in your vehicle, be sure that it has an octane rating no lower than 87.
- Toyota does not recommend the use of gasoline containing methanol.

### ■ Non-recommendation of the use of gasoline containing MMT

Some gasoline contains an octane enhancing additive called MMT (Methylcyclopentadienyl Manganese Tricarbonyl).

Toyota does not recommend the use of gasoline that contains MMT. If fuel containing MMT is used, your emission control system may be adversely affected.

The malfunction indicator lamp on the instrument cluster may come on. If this happens, contact your Toyota dealer for service.

### ■ If your engine knocks

- Consult your Toyota dealer.
- You may occasionally notice light knocking for a short time while accelerating or driving uphill. This is normal and there is no need for concern.

#### NOTICE

##### ■ Notice on fuel quality

- Do not use improper fuels. If improper fuels are used, the engine will be damaged.
- Do not use leaded gasoline.  
Leaded gasoline can cause damage to your vehicle's three-way catalytic converters causing the emission control system to malfunction.
- Do not use gasohol other than the type previously stated.  
Other gasohol may cause fuel system damage or vehicle performance problems.
- Using unleaded gasoline with an octane number or rating lower than the level previously stated will cause persistent heavy knocking.  
At worst, this will lead to engine damage.

##### ■ Fuel-related poor driveability

If poor driveability is encountered after using a different type of fuel (poor hot starting, vaporization, engine knocking, etc.), discontinue the use of that type of fuel.

##### ■ When refueling with gasohol

Take care not to spill gasohol. It can damage your vehicle's paint.



# 6-1. Specifications

## Tire information

### Typical tire symbols

#### Full-size tire

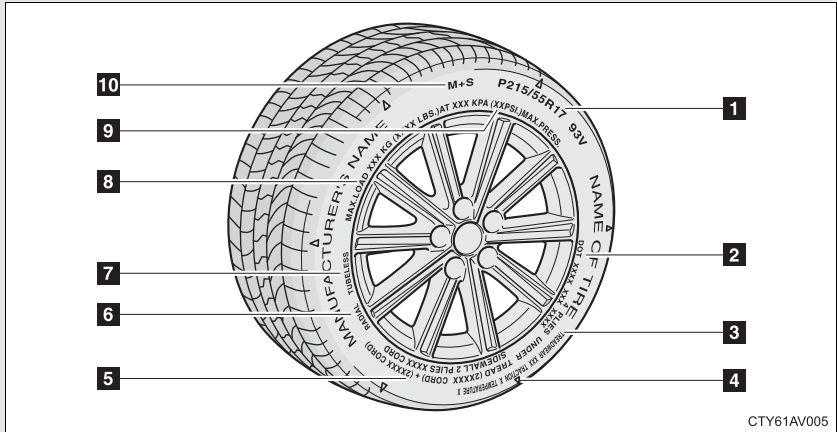

#### Compact spare tire

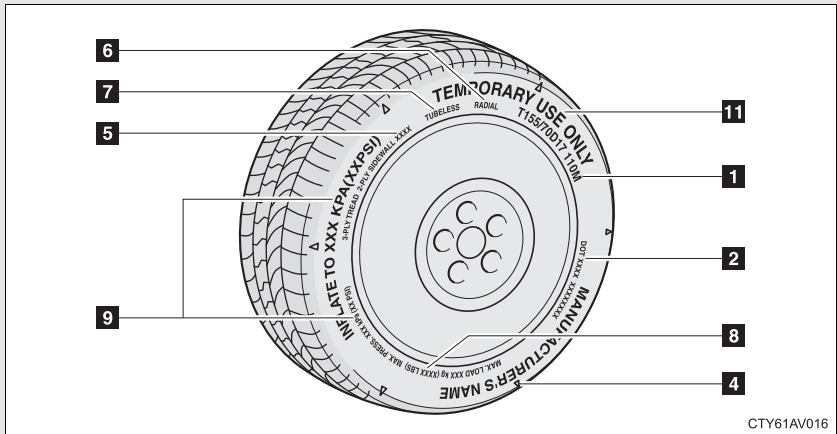

- 1** Tire size (→P. 484)
- 2** DOT and Tire Identification Number (TIN) (→P. 483)
- 3** Uniform tire quality grading  
For details, see “Uniform Tire Quality Grading” that follows.
- 4** Location of treadwear indicators (→P. 367)

**5** Tire ply composition and materials

Plies are layers of rubber-coated parallel cords. Cords are the strands which form the plies in a tire.

**6** Radial tires or bias-ply tires

A radial tire has "RADIAL" on the sidewall. A tire not marked "RADIAL" is a bias-ply tire.

**7** TUBELESS or TUBE TYPE

A tubeless tire does not have a tube and air is directly put into the tire. A tube type tire has a tube inside the tire and the tube maintains the air pressure.

**8** Load limit at maximum cold tire inflation pressure (→P. 371)

**9** Maximum cold tire inflation pressure (→P. 474)

This means the pressure to which a tire may be inflated.

**10** Summer tires or all season tires (→P. 371)

An all season tire has "M+S" on the sidewall. A tire not marked "M+S" is a summer tire.

**11** "TEMPORARY USE ONLY" (→P. 442)

A compact spare tire is identified by the phrase "TEMPORARY USE ONLY" molded on its sidewall. This tire is designed for temporary emergency use only.

## Typical DOT and Tire Identification Number (TIN)

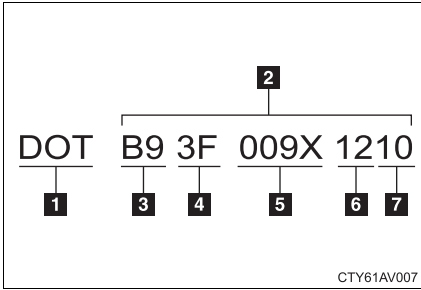

- 1** DOT symbol\*
- 2** Tire Identification Number (TIN)
- 3** Tire manufacturer's identification mark
- 4** Tire size code
- 5** Manufacturer's optional tire type code (3 or 4 letters)
- 6** Manufacturing week
- 7** Manufacturing year

\*: The DOT symbol certifies that the tire conforms to applicable Federal Motor Vehicle Safety Standards.

## Tire size

### ■ Typical tire size information

The illustration indicates typical tire size.

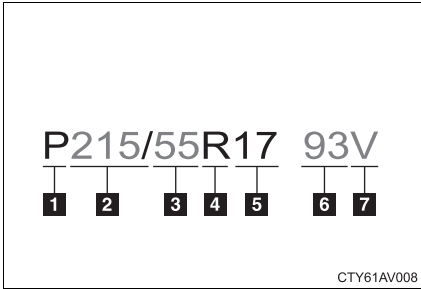

#### 1 Tire use

(P = Passenger car,  
T = Temporary use)

#### 2 Section width (millimeters)

#### 3 Aspect ratio

(tire height to section width)

#### 4 Tire construction code

(R = Radial, D = Diagonal)

#### 5 Wheel diameter (inches)

#### 6 Load index (2 digits or 3 digits)

#### 7 Speed symbol

(alphabet with one letter)

### ■ Tire dimensions

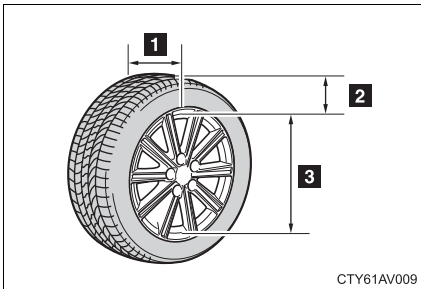

#### 1 Section width

#### 2 Tire height

#### 3 Wheel diameter

## Tire section names

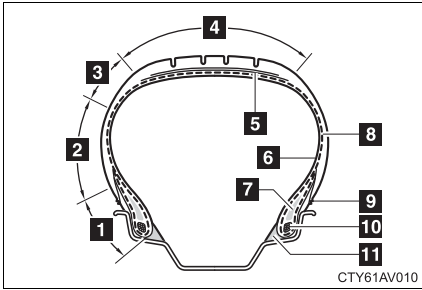

- 1** Bead
- 2** Sidewall
- 3** Shoulder
- 4** Tread
- 5** Belt
- 6** Inner liner
- 7** Reinforcing rubber
- 8** Carcass
- 9** Rim lines
- 10** Bead wires
- 11** Chafer

## Uniform Tire Quality Grading

This information has been prepared in accordance with regulations issued by the National Highway Traffic Safety Administration of the U.S. Department of Transportation.

It provides the purchasers and/or prospective purchasers of Toyota vehicles with information on uniform tire quality grading.

Your Toyota dealer will help answer any questions you may have as you read this information.

### ■ DOT quality grades

All passenger vehicle tires must conform to Federal Safety Requirements in addition to these grades. Quality grades can be found where applicable on the tire sidewall between tread shoulder and maximum section width.

For example: Treadwear 200 Traction AA Temperature A

### ■ Treadwear

The treadwear grade is a comparative rating based on the wear rate of the tire when tested under controlled conditions on a specified government test course.

For example, a tire graded 150 would wear one and a half (1 - 1/2) times as well on the government course as a tire graded 100.

The relative performance of tires depends upon the actual conditions of their use. Performance may differ significantly from the norm due to variations in driving habits, service practices and differences in road characteristics and climate.

### ■ Traction AA, A, B, C

The traction grades, from highest to lowest, are AA, A, B and C, and they represent the tire's ability to stop on wet pavement as measured under controlled conditions on specified government test surfaces of asphalt and concrete.

A tire marked C may have poor traction performance.

Warning: The traction grade assigned to this tire is based on braking (straight ahead) traction tests and does not include cornering (turning) traction.

### ■ Temperature A, B, C

The temperature grades are A (the highest), B, and C, representing the tire's resistance to the generation of heat and its ability to dissipate heat when tested under controlled conditions on a specified indoor laboratory test wheel.

Sustained high temperature can cause the material of the tire to degenerate and reduce tire life, and excessive temperature can lead to sudden tire failure.

Grade C corresponds to a level of performance which all passenger car tires must meet under the Federal Motor Vehicle Safety Standard No. 109.

Grades B and A represent higher levels of performance on the laboratory test wheel than the minimum required by law.

Warning: The temperature grades of a tire assume that it is properly inflated and not overloaded.

Excessive speed, underinflation, or excessive loading, either separately or in combination, can cause heat buildup and possible tire failure.

### Glossary of tire terminology

Tire related term	Meaning
Cold tire inflation pressure	Tire pressure when the vehicle has been parked for three hours or more, or has not been driven more than 1 mile or 1.5 km under that condition
Maximum inflation pressure	The maximum cold inflated pressure to which a tire may be inflated, shown on the sidewall of the tire
Recommended inflation pressure	Cold tire inflation pressure recommended by a manufacturer
Accessory weight	The combined weight (in excess of those standard items which may be replaced) of automatic transmission, power steering, power brakes, power windows, power seats, radio and heater, to the extent that these items are available as factory-installed equipment (whether installed or not)
Curb weight	The weight of a motor vehicle with standard equipment, including the maximum capacity of fuel, oil and coolant, and if so equipped, air conditioning and additional weight optional engine
Maximum loaded vehicle weight	The sum of: (a) Curb weight (b) Accessory weight (c) Vehicle capacity weight (d) Production options weight

Tire related term	Meaning
Normal occupant weight	150 lb. (68 kg) times the number of occupants specified in the second column of Table 1* that follows
Occupant distribution	Distribution of occupants in a vehicle as specified in the third column of Table 1* below
Production options weight	The combined weight of installed regular production options weighing over 5 lb. (2.3 kg) in excess of the standard items which they replace, not previously considered in curb weight or accessory weight, including heavy duty brakes, ride levelers, roof rack, heavy duty battery, and special trim
Rim	A metal support for a tire or a tire and tube assembly upon which the tire beads are seated
Rim diameter (Wheel diameter)	Nominal diameter of the bead seat
Rim size designation	Rim diameter and width
Rim type designation	The industry manufacturer's designation for a rim by style or code
Rim width	Nominal distance between rim flanges
Vehicle capacity weight (Total load capacity)	The rated cargo and luggage load plus 150 lb. (68 kg) times the vehicle's designated seating capacity
Vehicle maximum load on the tire	The load on an individual tire that is determined by distributing to each axle its share of the maximum loaded vehicle weight, and dividing by two
Vehicle normal load on the tire	The load on an individual tire that is determined by distributing to each axle its share of curb weight, accessory weight, and normal occupant weight (distributed in accordance with Table 1* below), and dividing by two



Tire related term	Meaning
Weather side	The surface area of the rim not covered by the inflated tire
Bead	The part of the tire that is made of steel wires, wrapped or reinforced by ply cords and that is shaped to fit the rim
Bead separation	A breakdown of the bond between components in the bead
Bias ply tire	A pneumatic tire in which the ply cords that extend to the beads are laid at alternate angles substantially less than 90 degrees to the centerline of the tread
Carcass	The tire structure, except tread and sidewall rubber which, when inflated, bears the load
Chunking	The breaking away of pieces of the tread or sidewall
Cord	The strands forming the plies in the tire
Cord separation	The parting of cords from adjacent rubber compounds
Cracking	Any parting within the tread, sidewall, or innerliner of the tire extending to cord material
CT	A pneumatic tire with an inverted flange tire and rim system in which the rim is designed with rim flanges pointed radially inward and the tire is designed to fit on the underside of the rim in a manner that encloses the rim flanges inside the air cavity of the tire
Extra load tire	A tire designed to operate at higher loads and at higher inflation pressures than the corresponding standard tire
Groove	The space between two adjacent tread ribs
Innerliner	The layer(s) forming the inside surface of a tubeless tire that contains the inflating medium within the tire

Tire related term	Meaning
Innerliner separation	The parting of the innerliner from cord material in the carcass
Intended outboard sidewall	<p>(a) The sidewall that contains a whitewall, bears white lettering, or bears manufacturer, brand, and/or model name molding that is higher or deeper than the same molding on the other sidewall of the tire, or</p> <p>(b) The outward facing sidewall of an asymmetrical tire that has a particular side that must always face outward when mounted on a vehicle</p>
Light truck (LT) tire	A tire designated by its manufacturer as primarily intended for use on lightweight trucks or multipurpose passenger vehicles
Load rating	The maximum load that a tire is rated to carry for a given inflation pressure
Maximum load rating	The load rating for a tire at the maximum permissible inflation pressure for that tire
Maximum permissible inflation pressure	The maximum cold inflation pressure to which a tire may be inflated
Measuring rim	The rim on which a tire is fitted for physical dimension requirements
Open splice	Any parting at any junction of tread, sidewall, or innerliner that extends to cord material
Outer diameter	The overall diameter of an inflated new tire
Overall width	The linear distance between the exteriors of the sidewalls of an inflated tire, including elevations due to labeling, decorations, or protective bands or ribs
Passenger car tire	A tire intended for use on passenger cars, multipurpose passenger vehicles, and trucks, that have a gross vehicle weight rating (GVWR) of 10,000 lb. or less.

Tire related term	Meaning
Ply	A layer of rubber-coated parallel cords
Ply separation	A parting of rubber compound between adjacent plies
Pneumatic tire	A mechanical device made of rubber, chemicals, fabric and steel or other materials, that, when mounted on an automotive wheel, provides the traction and contains the gas or fluid that sustains the load
Radial ply tire	A pneumatic tire in which the ply cords that extend to the beads are laid at substantially 90 degrees to the centerline of the tread
Reinforced tire	A tire designed to operate at higher loads and at higher inflation pressures than the corresponding standard tire
Section width	The linear distance between the exteriors of the sidewalls of an inflated tire, excluding elevations due to labeling, decoration, or protective bands
Sidewall	That portion of a tire between the tread and bead
Sidewall separation	The parting of the rubber compound from the cord material in the sidewall
Snow tire	A tire that attains a traction index equal to or greater than 110, compared to the ASTM E-1136 Standard Reference Test Tire, when using the snow traction test as described in ASTM F-1805-00, Standard Test Method for Single Wheel Driving Traction in a Straight Line on Snow-and Ice-Covered Surfaces, and which is marked with an Alpine Symbol (  ) on at least one sidewall
Test rim	The rim on which a tire is fitted for testing, and may be any rim listed as appropriate for use with that tire

Tire related term	Meaning
Tread	That portion of a tire that comes into contact with the road
Tread rib	A tread section running circumferentially around a tire
Tread separation	Pulling away of the tread from the tire carcass
Treadwear indicators (TWI)	The projections within the principal grooves designed to give a visual indication of the degrees of wear of the tread
Wheel-holding fixture	The fixture used to hold the wheel and tire assembly securely during testing

\*: Table 1 — Occupant loading and distribution for vehicle normal load for various designated seating capacities

Designated seating capacity, Number of occupants	Vehicle normal load, Number of occupants	Occupant distribution in a normally loaded vehicle
2 through 4	2	2 in front
5 through 10	3	2 in front, 1 in second seat
11 through 15	5	2 in front, 1 in second seat, 1 in third seat, 1 in fourth seat
16 through 20	7	2 in front, 2 in second seat, 2 in third seat, 1 in fourth seat

## Customizable features

**Your vehicle includes a variety of electronic features that can be personalized to suit your preferences. Programming these preferences requires specialized equipment and may be performed by your Toyota dealer.**

Some function settings are changed simultaneously with other functions being customized. Contact your Toyota dealer for further details.

### Customizable Features

- 1** Vehicles with a Display Audio system: Settings that can be changed using the Display Audio system  
(For further information on customizing settings using the Display Audio system, refer to the “Display Audio System Owner’s Manual”.)
  - 2** Vehicles with a navigation system: Settings that can be changed using the navigation system  
(For further information on customizing settings using the navigation system, refer to the “Navigation System Owner’s Manual”.)
  - 3** Settings that can be changed by your Toyota dealer
- Definition of symbols: O = Available, — = Not available

Item	Function	Default setting	Customized setting	1	2	3
Smart key system* <sup>1</sup> and wireless remote control (→P. 32, 46)	Operation signal (Emergency flashers)	On	Off	—	○	○
	Operation signal (Buzzer)	On	Off	—	—	○
	Operation buzzer volume	Level 5	Off to level 7	○	○	○
	Time elapsed before automatic door lock function is activated if door is not opened after being unlocked	60 seconds	Off	—	○	○
			30 seconds			
	120 seconds					
	Open door warning buzzer	On	Off	—	—	○
Smart key system* <sup>1</sup> (→P. 32)	Smart key system	On	Off	—	—	○
	Number of permissible times of continuous smart lock	Twice	Unlimited	—	—	○

Item	Function	Default setting	Customized setting	1	2	3
Wireless remote control (→P. 46)	Wireless remote control	On	Off	—	—	○
	Unlocking operation	Driver's door unlocked in one step, all doors unlocked in two steps	All doors unlocked in one step.	○	○	○
	Panic function	On	Off	—	—	○
	Trunk unlocking operation	Press and hold (short)	Off	—	—	○
			Press twice			
One short press						
		Press and hold (long)				

Item	Function	Default setting	Customized setting	1	2	3
Door lock (→P. 52)	Unlocking using a key	Driver's door unlocked in one step, all doors unlocked in two steps	All doors unlocked in one step.	—	○	○
	Speed-detecting automatic door lock function	Off	On	○	○	○
	Opening driver's door unlocks all doors	Off	On	—	○	○
	Shifting gears to P unlocks all doors.	On	Off	○	○	○
	Shifting gears to position other than P locks all doors.	On	Off	○	○	○
Automatic light control system*1 (→P. 185)	Light sensor sensitivity	Level 3	Level 1 to 5	○	○	○
	Time elapsed before headlights automatically turn off after doors are closed	30 seconds	0 seconds	○	○	○
			60 seconds			
90 seconds						
Lights (→P. 185)	Daytime running light system (except Canada)	On	Off	○	○	○



Item	Function	Default setting	Customized setting	1	2	3
Illumination (→P. 285)	Time elapsed before lights turn off	15 seconds	Off	—	O	O
			7.5 seconds			
			30 seconds			
	Operation when the doors are unlocked	On	Off	—	—	O
	Vehicles without smart key system: Operation after the engine switch turned to the "LOCK" position Vehicles with smart key system: Operation after the "ENGINE START STOP" switch turned off	On	Off	—	—	O
Operation when you approach the vehicle with the electronic key on your person*2	On	Off	—	—	O	
Seat belt reminder (→P. 423)	Vehicle speed linked seat belt reminder buzzer	On	Off	—	—	O

Item	Function	Default setting	Customized setting	1	2	3
Automatic air conditioning system*1 (→P. 233)	Switching between outside air and recirculated air mode linked to "AUTO" switch operation	Auto	Manual	—	O	O
	A/C auto switch operation	Auto	Manual	—	O	O
Power window (driver's door) & moon roof*1 (→P. 81, 84)	Key linked opening	Off	On	—	—	O
	Wireless remote control linked opening	Off	On	—	—	O
	Key linked closing	Off	On	—	—	O
	Wireless remote control linked opening buzzer	On	Off	—	—	O
Moon roof*1 (→P. 84)	Linked operation of components when door key is used	Slide only	Tilt only	—	—	O
	Linked operation of components when wireless remote control is used	Slide only	Tilt only	—	—	O

\*1: If equipped

\*2: Vehicles with a smart key system

## 6-3. Initialization

### Items to initialize

**The following items must be initialized for normal system operation after such cases as the battery being reconnected, or maintenance being performed on the vehicle:**

Item	When to initialize	Reference
Maintenance data	After the maintenance is performed	P. 340
Tire pressure warning system (U.S.A. only)	<ul style="list-style-type: none"><li>• When changing tire pressure (such as when changing traveling speed, load weight, etc.)</li><li>• When changing the tire size</li></ul>	P. 368



Reporting safety defects for U.S. owners .....	502
Seat belt instructions for Canadian owners (in French) .....	503
SRS airbag instructions for Canadian owners (in French) .....	505

## Reporting safety defects for U.S. owners

If you believe that your vehicle has a defect which could cause a crash or could cause injury or death, you should immediately inform the National Highway Traffic Safety Administration (NHTSA) in addition to notifying Toyota Motor Sales, U.S.A., Inc. (Toll-free: 1-800-331-4331).

If NHTSA receives similar complaints, it may open an investigation, and if it finds that a safety defect exists in a group of vehicles, it may order a recall and remedy campaign. However, NHTSA cannot become involved in individual problems between you, your dealer, or Toyota Motor Sales, U.S.A., Inc.

To contact NHTSA, you may call the Vehicle Safety Hotline toll-free at 1-888-327-4236 (TTY: 1-800-424-9153); go to <http://www.safercar.gov>; or write to: Administrator, NHTSA, 1200 New Jersey Ave, S.E., Washington, DC 20590. You can also obtain other information about motor vehicle safety from <http://www.safercar.gov>.

## Seat belt instructions for Canadian owners (in French)

The following is a French explanation of seat belt instructions extracted from the seat belt section in this manual.

See the seat belt section for more detailed seat belt instructions in English.

### Utilisation correcte des ceintures de sécurité

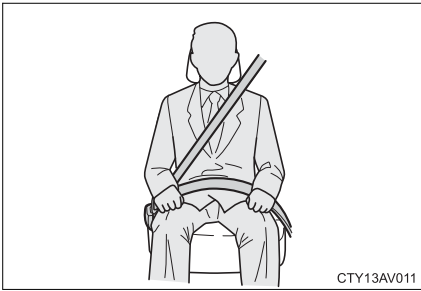

- Tendez la sangle diagonale de sorte qu'elle couvre complètement l'épaule, sans entrer en contact avec le cou ou glisser de l'épaule.
- Placez la sangle abdominale le plus bas possible sur les hanches.
- Réglez la position du dossier de siège. Asseyez-vous le dos le plus droit possible et calez-vous bien dans le siège.
- Ne vrillez pas la ceinture de sécurité.

## ■ Ceinture de sécurité arrière

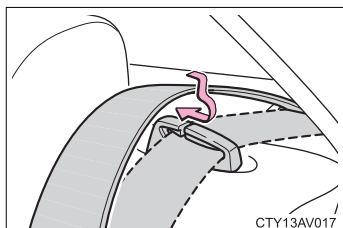

Si la ceinture de sécurité est sortie de son guide, repassez-la dedans avant de l'utiliser.

## Entretien et soin

### ■ Ceintures de sécurité

Nettoyez avec un chiffon ou une éponge humectée d'eau savonneuse tiède. Profitez de l'occasion pour vérifier régulièrement que les ceintures ne sont pas effilochées, entaillées, ou ne paraissent pas exagérément usées.

### ⚠ ATTENTION

#### ■ Détérioration et usure des ceintures de sécurité

Inspectez les ceintures de sécurité périodiquement. Contrôlez qu'elles ne sont pas entaillées, effilochées, et que leurs ancrages ne sont pas desserrés. N'utilisez pas une ceinture de sécurité défectueuse avant qu'elle ne soit remplacée. Une ceinture de sécurité défectueuse n'apporte aucune garantie de protection de l'occupant en cas d'accident.



The following is a French explanation of SRS airbag instructions extracted from the SRS airbag section in this manual.

See the SRS airbag section for more detailed SRS airbag instructions in English.

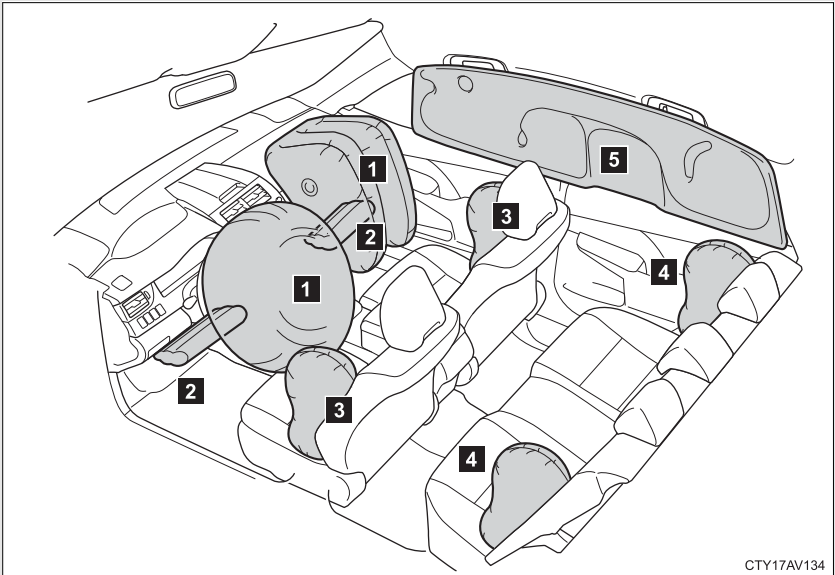

CTY17AV134

## Sacs de sécurité gonflables SRS frontaux

- 1** Sac de sécurité gonflable conducteur/sac de sécurité gonflable passager avant SRS

Participent à la protection de la tête et du thorax du conducteur et du passager avant contre les chocs avec les éléments de l'habitacle

- 2** Sacs de sécurité gonflables SRS de genoux

Participent à la protection du conducteur et du passager avant

### **Sacs de sécurité gonflables SRS latéraux et rideau**

- 3** Sacs de sécurité gonflables SRS latéraux avant  
Participent à la protection du haut du corps des occupants assis aux places avant
- 4** Sacs de sécurité gonflables SRS latéraux arrière  
Participent à la protection du haut du corps des occupants assis aux places arrière extérieures
- 5** Sacs de sécurité gonflables SRS rideau  
Participent principalement à la protection de la tête des occupants assis aux places extérieures

## Composition du système de sacs de sécurité gonflables SRS

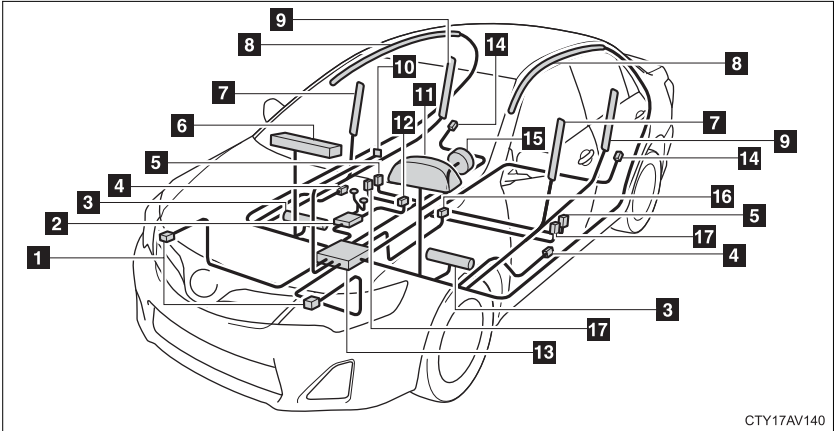

CTY17AV140

- |  |  |
|--|--|
| <b>1</b> Capteurs d'impact avant   | <b>10</b> Témoins indicateurs "AIR BAG ON" et "AIR BAG OFF"              |
| <b>2</b> Système de classification des occupants du siège passager avant (ECU et capteurs) | <b>11</b> Témoin d'alerte SRS  |
| <b>3</b> Sac de sécurité gonflable de genoux   | <b>12</b> Contacteur de boucle de ceinture de sécurité passager avant    |
| <b>4</b> Capteurs d'impact latéral (porte avant)   | <b>13</b> Boîtier électronique de sacs de sécurité gonflables            |
| <b>5</b> Capteurs d'impact latéral (avant)   | <b>14</b> Capteurs d'impact latéral (arrière)                            |
| <b>6</b> Sac de sécurité gonflable passager avant  | <b>15</b> Sac de sécurité gonflable conducteur                           |
| <b>7</b> Sacs de sécurité gonflables latéraux avant  | <b>16</b> Contacteur de boucle de ceinture de sécurité conducteur        |
| <b>8</b> Sacs de sécurité gonflables rideau  | <b>17</b> Prétensionneurs de ceintures de sécurité et limiteurs de force |
| <b>9</b> Sacs de sécurité gonflables latéraux arrière                                      |  |

Votre véhicule est équipé de SACS DE SECURITE GONFLABLES INTELLIGENTS (ADVANCED AIRBAGS) conçus selon les normes de sécurité américaines applicables aux véhicules à moteur (FMVSS208). Le boîtier électronique (ECU) des sacs de sécurité gonflables régule le déploiement de ces derniers sur la base des informations qu'il reçoit des capteurs, etc., indiqués ci-dessus dans le schéma illustrant la composition du système. Parmi ces informations figurent la gravité du choc et l'occupation du véhicule par les passagers. Le déploiement rapide des sacs de sécurité gonflables est obtenu au moyen d'une réaction chimique dans les dispositifs pyrotechniques, qui produit un gaz inoffensif permettant d'amortir le mouvement des occupants.

## ATTENTION

### ■ Précautions avec les sacs de sécurité gonflables SRS

Respectez les précautions suivantes concernant les sacs de sécurité gonflables SRS.

À défaut, des blessures graves, voire mortelles, pourraient s'ensuivre.

- Le conducteur et tous les passagers à bord du véhicule doivent porter leur ceinture de sécurité correctement.

Les sacs de sécurité gonflables SRS sont des dispositifs de protection complémentaires aux ceintures de sécurité.

- Le sac de sécurité gonflable SRS conducteur se déploie avec une violence considérable, qui peut être très dangereuse voire mortelle si le conducteur se trouve très près du sac de sécurité gonflable.

L'autorité fédérale chargée de la sécurité routière aux États-Unis, la NHTSA (National Highway Traffic Safety Administration) conseille:

Sachant que la zone à risque du sac de sécurité gonflable conducteur se trouve dans les premiers 2 à 3 in. (50 - 75 mm) de déploiement, vous disposez d'une marge de sécurité confortable en vous plaçant à 10 in. (250 mm) de votre sac de sécurité gonflable conducteur. Cette distance est à mesurer entre le moyeu du volant de direction et le sternum. Si vous êtes assis à moins de 10 in. (250 mm), vous pouvez changer votre position de conduite de plusieurs façons:

- Reculez votre siège le plus possible, tout en continuant à pouvoir atteindre confortablement les pédales.
- Inclinez légèrement le dossier du siège.

Bien que les véhicules puissent être différents les uns des autres, la plupart des conducteurs peuvent s'asseoir à une distance de 10 in. (250 mm), même avec le siège conducteur complètement avancé, simplement en inclinant un peu le dossier de siège. Si vous avez des difficultés à voir la route après avoir incliné votre siège, utilisez un coussin ferme et antidérapant pour vous rehausser ou, si votre véhicule est équipé du réglage en hauteur du siège, remontez-le.

- Si votre volant de direction est réglable, inclinez-le vers le bas. Cela a pour effet d'orienter le sac de sécurité gonflable en direction de votre poitrine plutôt que de votre tête et de votre cou.

Régalez votre siège selon ces recommandations de la NHTSA, tout en conservant le contrôle des pédales et du volant de direction, et la vue des commandes du tableau de bord.

## ATTENTION

### ■ Précautions avec les sacs de sécurité gonflables SRS



- Si vous attachez une rallonge de ceinture de sécurité aux boucles de ceinture de sécurité avant, mais pas au pêne de la ceinture de sécurité, les sacs de sécurité gonflables SRS frontaux détectent que le conducteur et le passager avant ont attaché leur ceinture de sécurité, alors même que ce n'est pas le cas. Dans ce cas, il se peut que les sacs de sécurité gonflables SRS frontaux ne se déploient pas correctement en cas d'accident, et vous risquez d'être tué ou grièvement blessé. Veillez donc à porter la ceinture de sécurité avec la rallonge de ceinture de sécurité.
- Le sac de sécurité gonflable SRS passager avant se déploie également avec une violence considérable, qui peut être très dangereuse voire mortelle si le passager avant se trouve très près du sac de sécurité gonflable. Éloignez le siège passager avant au maximum du sac de sécurité gonflable, et réglez le dossier de siège de sorte à être assis bien droit dans le siège.
- Les nourrissons et les enfants qui ne sont pas correctement assis et/ou protégés peuvent être grièvement blessés ou tués par le déploiement d'un sac de sécurité gonflable. Installez dans un siège de sécurité enfant les enfants trop jeunes pour pouvoir utiliser la ceinture de sécurité. Toyota recommande vivement que les nourrissons et les jeunes enfants soient installés sur le siège arrière du véhicule et convenablement attachés. Les sièges arrière sont plus sûrs pour les nourrissons et les enfants que le siège passager avant.

## ! ATTENTION

### ■ Précautions avec les sacs de sécurité gonflables SRS

● N'installez jamais un siège de sécurité enfant type dos à la route sur le siège passager avant, même si le témoin indicateur "AIR BAG OFF" est allumé. En cas d'accident, par la violence et la vitesse de son déploiement, le sac de sécurité gonflable passager avant peut blesser grièvement, voire tuer l'enfant si vous l'avez installé à la place du passager avant dans un siège de sécurité enfant type dos à la route.

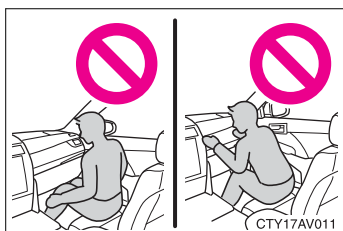

● Ne pas s'asseoir sur le bord du siège et ne pas s'appuyer contre la planche de bord.

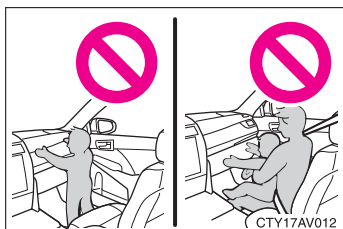

● Ne laissez pas un enfant rester debout devant le sac de sécurité gonflable SRS passager avant ou bien s'asseoir sur les genoux du passager avant.

● Ne laissez pas les occupants des sièges avant voyager avec un objet sur les genoux.



● Ne vous appuyez pas contre la porte, contre le rail latéral de toit ou contre les montants avant, latéraux et arrière.

## ⚠ ATTENTION

### ■ Précautions avec les sacs de sécurité gonflables SRS

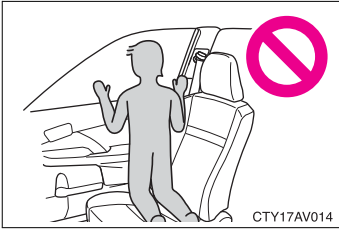

- Interdisez à quiconque de s'agenouiller sur les sièges passagers en appui contre la porte ou de sortir la tête ou les mains à l'extérieur du véhicule.

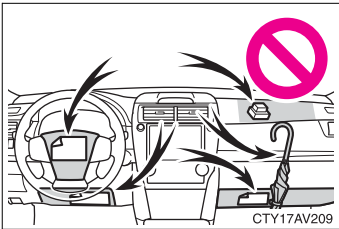

- Ne fixez ni ne posez aucun objet sur la planche de bord, la garniture centrale du moyeu de volant de direction et la partie inférieure du tableau de bord. Au déploiement des sacs de sécurité gonflables SRS conducteur, passager avant et genoux, tout objet risque de se transformer en projectile.

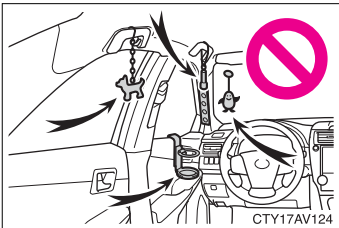

- Ne rien fixer aux portes, à la vitre de pare-brise, aux vitres latérales, aux montants avant et arrière, au rail latéral de toit et à la poignée de maintien.

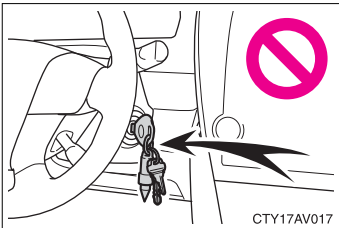

- Véhicules dépourvus de système d'accès et de démarrage "mains libres": Évitez d'attacher au porte-clés de la clé de contact des objets lourds, pointus ou très durs, comme d'autres clés par exemple. Ces objets risquent d'entraver le déploiement du sac de sécurité gonflable SRS de genoux ou d'être projetés vers le siège conducteur par la force de déploiement, constituant ainsi un danger potentiel.



## ATTENTION

### ■ Précautions avec les sacs de sécurité gonflables SRS

- Ne suspendez aux crochets à vêtements aucun cintre nu ni aucun objet dur. En cas de déploiement des sacs de sécurité gonflables rideau SRS, tous ces objets pourraient se transformer en projectiles et causer des blessures graves, voire mortelles.
- Si une housse en vinyle recouvre la partie où le sac de sécurité gonflable SRS de genoux se déploie, veillez à l'enlever.
- N'utilisez aucun accessoire de siège venant recouvrir les zones de déploiement des sacs de sécurité gonflables SRS latéraux, car il risquerait d'en gêner le déploiement. De tels accessoires peuvent empêcher les sacs de sécurité gonflables latéraux de fonctionner correctement, désactiver le dispositif ou entraîner le déploiement accidentel des sacs de sécurité latéraux, entraînant la mort ou des blessures graves.
- Évitez de faire subir des chocs ou des pressions excessives aux zones renfermant les composants des sacs de sécurité gonflables SRS. En effet, cela pourrait entraîner un fonctionnement anormal des sacs de sécurité gonflables SRS.
- Ne touchez aucun composant du système immédiatement après le déclenchement (déploiement) des sacs de sécurité gonflables SRS, car ils sont alors encore très chauds.
- Si vous avez des difficultés à respirer après le déploiement des sacs de sécurité gonflables SRS, ouvrez une porte ou une vitre pour faire entrer de l'air frais, ou bien descendez du véhicule si cela ne présente pas de danger. Essayez tout résidu dès que possible afin d'éviter d'éventuelles irritations de la peau.
- Si les parties renfermant les sacs de sécurité gonflables SRS, telles que la garniture du moyeu de volant et les garnitures de montants avant et arrière, apparaissent abîmées ou craquelées, faites-les remplacer par votre concessionnaire Toyota.

## ATTENTION

### ■ **Modification et mise au rebut des éléments du système de sacs de sécurité gonflables SRS**

Consultez impérativement votre concessionnaire Toyota si vous avez besoin d'intervenir sur votre véhicule ou de procéder à l'une des modifications suivantes. Les sacs de sécurité gonflables SRS risquent de ne pas fonctionner correctement ou de se déployer (gonfler) accidentellement, provoquant ainsi des blessures graves, voire mortelles.

- Installation, dépose, démontage et réparations des sacs de sécurité gonflables SRS
- Réparations, modifications, démontage ou remplacement du volant, du tableau de bord, de la planche de bord, des sièges ou de leur garnissage, des montants avant, latéraux et arrière ou des rails latéraux de toit
- Réparations ou modifications des ailes avant, du bouclier avant, ou des flancs de l'habitacle
- Installation de chasse-neige, de treuils, etc., sur la calandre (pare-buffle ou pare-kangourou, etc.)
- Modification des suspensions du véhicule
- Installation d'appareils électroniques, tels qu'un radioémetteur/récepteur ou d'un lecteur CD
- Aménagements du véhicule visant à permettre sa conduite par une personne atteinte d'un handicap physique

## Index

Abbreviation list .....	516
Alphabetical index.....	518
What to do if... .....	528

Vehicles with a Display Audio system:

For details of equipment related to the Display Audio system, such as the audio system, refer to the “Display Audio System Owner’s Manual”.

Vehicles with a navigation system:

For details of equipment related to the navigation system, such as the audio system, refer to the “Navigation System Owner’s Manual”.

## Abbreviation/Acronym list

ABBREVIATIONS	MEANING
A/C	Air Conditioning
ABS	Anti-lock Brake System
ACC	Accessory
AI-SHIFT	Artificial Intelligence Shift control
ALR	Automatic Locking Retractor
BSM	Blind Spot Monitor
CRS	Child Restraint System
ECO	Economy/Ecology
ECU	Electronic Control Unit
EDR	Event data recorder
ELR	Emergency Locking Retractor
EPS	Electric Power Steering
GAWR	Gross Axle Weight Ratings
GVWR	Gross Vehicle Weight Rating

ABBREVIATIONS	MEANING
I/M	Emission inspection and maintenance
LATCH	Lower Anchors and Tethers for Children
LED	Light Emitting Diode
M + S	Mud and Snow
MMT	Methylcyclopentadienyl Manganese Tricarbonyl
MTBE	Methyl Tertiary Butyl Ether
OBD	On Board Diagnostics
SRS	Supplemental Restraint System
TIN	Tire Identification Number
TPMS	Tire Pressure Warning System
TRAC	Traction Control
VIN	Vehicle Identification Number
VSC	Vehicle Stability Control

- A**
- A/C**.....226, 233
  - ABS** .....203
  - Air conditioning filter**.....382
  - Air conditioning system**
    - Air conditioning filter.....382
    - Automatic air conditioning system .....233
    - Manual air conditioning system .....226
  - Airbags**
    - Airbag operating conditions.....103
    - Airbag precautions for your child .....108
    - Airbag warning light.....421
    - Curtain shield airbag operating conditions.....104
    - Curtain shield airbag precautions .....108
    - Front passenger occupant classification system .....113
    - General airbag precautions .....108
    - Locations of airbags .....100
    - Modification and disposal of airbags .....112
    - Proper driving posture.....98, 108
    - Side airbag operating conditions.....104
    - Side airbag precautions .....108
    - SRS airbags .....100
  - Alarm**.....95
  - Antenna** .....250
  - Anti-lock brake system** .....203
  - Armrest**.....309
  - Ashtray** .....303
  - Audio input**.....264, 272, 283
  - Audio system**
    - Antenna.....250
    - Audio input .....264, 272, 283
    - AUX adapter .....283
    - CD player.....251
    - iPod.....264
    - MP3/WMA disc .....257
    - Optimal use.....280
    - Portable music player.....264, 272, 283
    - Radio.....248
    - Type .....242
    - USB memory.....272
  - Automatic air conditioning system** .....233
  - Automatic light control system** .....185
  - Automatic transmission**
    - Automatic transmission .....155, 159
    - If the shift lever cannot be shifted from P .....449
    - S mode.....156, 162
  - AUX port** .....283
  - Auxiliary boxes** .....296

<b>B</b>	<b>Back-up lights</b>	
	Replacing light bulbs .....	401
	Wattage .....	477
	<b>Battery</b>	
	Checking .....	363
	If the vehicle has	
	discharged battery .....	454
	Preparing and checking	
	before winter .....	218
	<b>Blind Spot Monitor</b> .....	<b>208</b>
	<b>Bottle holders</b> .....	<b>293</b>
	<b>Brake</b>	
	Fluid.....	361
	Parking brake .....	167
	<b>Brake assist</b> .....	<b>203</b>
	<b>Break-in tips</b> .....	<b>135</b>
	<b>BSM</b> .....	<b>208</b>

<b>C</b>	<b>Care</b>	
	Exterior.....	334
	Interior .....	337
	Seat belts .....	338
	<b>Cargo capacity</b> .....	<b>213</b>
	<b>Cargo net</b> .....	<b>314</b>
	<b>CD player</b> .....	<b>251</b>
	<b>Chains</b> .....	<b>218</b>
	<b>Child-protectors</b> .....	<b>54</b>
	<b>Child restraint system</b>	
	Booster seats, definition.....	118
	Booster seats, installation .....	122
	Convertible seats,	
	definition .....	118
	Convertible seats,	
	installation.....	122
	Front passenger occupant	
	classification system .....	113
	Infant seats, definition .....	118
	Infant seats, installation.....	122
	Installing CRS with LATCH	
	anchors .....	123
	Installing CRS with	
	seat belts .....	125
	Installing CRS with top	
	tether straps.....	128

**Child safety**

Airbag precautions .....	108
Battery precautions .....	364, 457
Child restraint system.....	118
Child-protectors.....	54
How your child should wear the seat belt .....	71
Installing child restraints.....	122
Moon roof precautions .....	87
Power window lock switch.....	81
Power window precautions .....	83
Removed key battery precautions .....	387
Seat belt extender precautions .....	75
Seat belt precautions .....	73
Seat heater precautions.....	308
Trunk precautions .....	60
<b>Cleaning</b>	
Exterior.....	334
Interior.....	337
Seat belts .....	338
<b>Clock .....</b>	<b>300</b>
<b>Coin holder .....</b>	<b>292</b>
<b>Compass.....</b>	<b>322</b>
<b>Condenser .....</b>	<b>361</b>
<b>Console box .....</b>	<b>291</b>
<b>Cooling system</b>	
Engine overheating .....	459
<b>Cruise control.....</b>	<b>199</b>
<b>Cup holder .....</b>	<b>294</b>
<b>Curtain shield airbags .....</b>	<b>100</b>
<b>Customizable features.....</b>	<b>493</b>

**D**

<b>Daytime running light system .....</b>	<b>189</b>
<b>Defogger</b>	
Outside rear view mirror.....	240
Rear window .....	240
<b>Dimensions .....</b>	<b>466</b>
<b>Dinghy towing.....</b>	<b>223</b>
<b>Do-it-yourself maintenance .....</b>	<b>347</b>
<b>Door courtesy light</b>	
Door courtesy light.....	285
Wattage.....	477
<b>Doors</b>	
Door lock.....	32, 46, 52
Door windows .....	81
Outside rear view mirrors.....	79
<b>Driver's seat belt reminder light.....</b>	<b>423</b>
<b>Driving</b>	
Break-in tips .....	135
Correct posture .....	98
Procedures.....	134
Winter driving tips .....	218



<b>E</b>	<b>Electric power steering</b> .....	<b>203</b>
	<b>Electronic key</b>	
	If the electronic key does not operate properly.....	451
	<b>Emergency flashers</b>	
	Switch.....	414
	<b>Emergency, in case of</b>	
	If a warning light turns on .....	420
	If the electronic key does not operate properly.....	451
	If the engine will not start.....	447
	If the shift lever cannot be shifted from P.....	449
	If the vehicle has discharged battery .....	454
	If the warning buzzer sounds .....	420
	If you have a flat tire .....	435
	If you lose your keys.....	450
	If you think something is wrong .....	418
	If your vehicle becomes stuck.....	462
	If your vehicle has to be stopped in an emergency...	463
	If your vehicle needs to be towed .....	415
	If your vehicle overheats .....	459

<b>Engine</b>	
Compartment .....	353
Engine switch .....	145, 148
Hood.....	350
How to start the engine .....	145, 148
Identification number.....	466
If the engine will not start .....	447
Ignition switch.....	145, 148
Overheating.....	459
<b>Engine coolant</b>	
Capacity .....	471
Checking .....	360
Preparing and checking before winter .....	218
<b>Engine coolant temperature display .....</b>	<b>169</b>
<b>Engine immobilizer system.....</b>	<b>92</b>
<b>Engine oil</b>	
Capacity .....	469
Checking .....	355
Preparing and checking before winter .....	218
<b>Engine switch light .....</b>	<b>285</b>
<b>EPS.....</b>	<b>203</b>
<b>Event data recorder .....</b>	<b>22</b>

<b>F</b>	<b>Floor mat.....</b>	<b>311</b>
	<b>Fluid</b>	
	Brake.....	361
	Washer.....	366
	<b>Fog lights</b>	
	Replacing light bulbs.....	401
	Switch.....	192
	Wattage.....	477
	<b>Front fog lights</b>	
	Replacing light bulbs.....	401
	Switch.....	192
	Wattage.....	477
	<b>Front passenger occupant classification system .....</b>	<b>113</b>
	<b>Front passenger's seat belt reminder light.....</b>	<b>423</b>
	<b>Front seats</b>	
	Adjustment .....	62
	<b>Front side marker lights</b>	
	Replacing light bulbs.....	401
	Wattage.....	477
	<b>Front turn signal lights</b>	
	Replacing light bulbs.....	401
	Wattage.....	477
	<b>Fuel</b>	
	Capacity .....	468
	Fuel gauge .....	169
	Fuel pump shut off system....	419
	Gas station information .....	532
	Information .....	478
	Refueling.....	88
	Type .....	468
	<b>Fuel door.....</b>	<b>88</b>
	<b>Fuel filler door .....</b>	<b>88</b>
	<b>Fuel pump shut off system .....</b>	<b>419</b>
	<b>Fuses.....</b>	<b>389</b>

<b>G</b>	<b>Garage door opener .....</b>	<b>315</b>
	<b>Gas station information .....</b>	<b>532</b>
	<b>Gauges.....</b>	<b>169</b>
	<b>Glove box .....</b>	<b>290</b>
	<b>Grocery bag hooks .....</b>	<b>313</b>
<b>H</b>	<b>Hazard lights</b>	
	Switch .....	414
	<b>Head restraints</b>	
	Adjusting .....	67
	<b>Headlights</b>	
	Replacing light bulbs.....	401
	Switch .....	185
	Wattage.....	477
	<b>Heaters</b>	
	Outside rear view mirror.....	240
	Seat heater .....	307
	<b>Hood.....</b>	<b>350</b>
	<b>Hooks</b>	
	Cargo net hooks.....	314
	Grocery bag hooks.....	313
	<b>Horn .....</b>	<b>168</b>

<b>I</b>	<b>I/M test</b> .....	<b>346</b>
	<b>Identification number</b>	
	Engine .....	466
	Vehicle.....	466
	<b>Ignition switch</b> .....	<b>145, 148</b>
	<b>Illuminated entry system</b> .....	<b>288</b>
	<b>Indicator lights</b> .....	<b>179</b>
	<b>Initialization</b>	
	Items to initialize.....	499
	<b>Inside rear view mirror</b> .....	<b>77</b>
	<b>Interior lights</b>	
	Interior lights.....	285
	Switch.....	286
	Wattage.....	477
<b>J</b>	<b>Jack</b>	
	Positioning a floor jack .....	351
	Vehicle-equipped jack .....	435
	<b>Jack handle</b> .....	<b>435</b>
<b>K</b>	<b>Keyless entry</b> .....	<b>46</b>
	<b>Keys</b>	
	Electronic key .....	28
	Engine switch .....	145, 148
	If the electronic key does not operate properly.....	451
	If you lose your keys.....	450
	Ignition switch.....	145, 148
	Key number .....	28
	Keyless entry.....	46
	Keys .....	28
	Mechanical key.....	28
	Wireless remote control key ...	46

<b>L</b>	<b>License plate lights</b>	
	Replacing light bulbs .....	401
	Wattage.....	477
	<b>Light bulbs</b>	
	Replacing .....	401
	Wattage.....	477
	<b>Lights</b>	
	Door courtesy lights .....	285
	Emergency flasher switch .....	414
	Fog light switch .....	192
	Hazard light switch.....	414
	Headlights switch .....	185
	Interior light switch .....	286
	Personal light switch .....	287
	Replacing light bulbs .....	401
	Turn signal lever.....	166
	Vanity lights.....	299
	Wattage.....	477
	<b>Load capacity</b> .....	<b>217</b>
	<b>Lock steering column</b> .....	<b>146, 152</b>
<b>M</b>	<b>Maintenance</b>	
	Do-it-yourself maintenance .....	347
	General maintenance.....	342
	Maintenance data.....	466
	Maintenance requirements....	340
	Reset the maintenance data.....	340
	<b>Manual air conditioning system</b> .....	<b>226</b>
	<b>Meter</b>	
	Instrument panel light control .....	175
	Meters .....	169
	<b>Mirrors</b>	
	Inside rear view mirror.....	77
	Outside rear view mirror defogger.....	240
	Outside rear view mirrors .....	79
	Vanity mirrors .....	299
	<b>Moon roof</b> .....	<b>84</b>
	<b>MP3 disc</b> .....	<b>257</b>

<b>N</b>	<b>Noise from under vehicle</b> .....	<b>19</b>
<b>O</b>	<b>Odometer</b> .....	<b>169</b>
	<b>Oil</b>	
	Engine oil.....	355
	<b>Opener</b>	
	Fuel filler door.....	88
	Hood.....	350
	Trunk.....	58
	<b>Outside rear view mirrors</b>	
	Adjusting and folding.....	79
	Defogger.....	240
	<b>Outside temperature display</b> .....	<b>301</b>
	<b>Overheating, Engine</b> .....	<b>459</b>
<b>P</b>	<b>Parking brake</b> .....	<b>167</b>
	<b>Parking lights</b>	
	Replacing light bulbs.....	401
	Switch.....	185
	Wattage.....	477
	<b>Personal lights</b>	
	Switch.....	287
	Wattage.....	477
	<b>Power outlet</b> .....	<b>304</b>
	<b>Power windows</b> .....	<b>81</b>
<b>R</b>	<b>Radiator</b> .....	<b>361</b>
	<b>Radio</b> .....	<b>248</b>
	<b>Rear seats</b>	
	Folding down.....	65
	<b>Rear side marker lights</b>	
	Replacing light bulb.....	401
	Switch.....	185
	Wattage.....	477
	<b>Rear turn signal lights</b>	
	Replacing light bulbs.....	401
	Wattage.....	477

	<b>Rear view mirror</b>	
	Compass.....	322
	<b>Rear window defogger</b> .....	<b>240</b>
	<b>Replacing</b>	
	Fuses.....	389
	Key battery.....	384
	Light bulbs.....	401
	Tires.....	435
	<b>Reporting safety defects for U.S.A. owners</b> .....	<b>502</b>
<b>S</b>	<b>Safety Connect</b> .....	<b>326</b>
	<b>Seat belts</b>	
	Adjusting the seat belt.....	69
	Automatic Locking Retractor.....	71
	Child restraint system installation.....	122
	Cleaning and maintaining the seat belts.....	338
	Emergency Locking Retractor.....	71
	How to wear your seat belt.....	69
	How your child should wear the seat belt.....	71
	Pregnant women, proper seat belt use.....	71
	Reminder light.....	423
	Seat belt extenders.....	72
	Seat belt pretensioners.....	70
	<b>Seat heaters</b> .....	<b>307</b>
	<b>Seating capacity</b> .....	<b>217</b>

**Seats**

- Adjustment ..... 62
- Adjustment precautions..... 64
- Child seats/child restraint system installation..... 122
- Cleaning ..... 337
- Head restraint..... 67
- Properly sitting in the seat..... 98
- Rear seat folding down..... 65
- Seat heaters ..... 307

**Service reminder**

- indicators ..... 179**

**Shift lever**

- Automatic transmission..... 155, 159
- If the shift lever cannot be shifted from P..... 449

**Shift lock system..... 449**

**Side airbags..... 100**

**Side marker lights**

- Replacing light bulbs ..... 401
- Switch..... 185
- Wattage..... 477

**Side mirror**

- Adjusting and folding ..... 79
- Defogger..... 240

**Smart key system**

- Entry function ..... 32
- Starting the engine ..... 148

**Spare tire**

- Inflation pressure..... 375
- Storage location ..... 435

**Spark plug..... 471**

**Specifications..... 466**

**Speedometer ..... 169**

**Steering**

- Column lock release..... 146, 152

**Steering wheel**

- Adjustment ..... 76

**Stop lights**

- Replacing light bulbs ..... 401
- Wattage..... 477

**Storage feature..... 289**

**Storage precautions ..... 213**

**Stuck**

- If your vehicle becomes stuck ..... 462

**Sun visors..... 298**

**Sunshade**

- Roof..... 85

**Switch**

- Emergency flasher switch ..... 414
- Engine switch ..... 145, 148
- Fog light switch ..... 192
- Hazard light switch ..... 414
- Ignition switch..... 145, 148
- Light switches..... 185
- Power door lock switch ..... 52
- Power window switch ..... 81
- Window lock switch ..... 81
- Wiper and washer switch ..... 194

<b>T</b>	<b>Tachometer</b> .....	<b>169</b>	<b>Tools</b> .....	<b>435</b>
	<b>Tail lights</b>		<b>Total load capacity</b> .....	<b>217</b>
	Replacing light bulbs .....	401	<b>Towing</b>	
	Switch.....	185	Dinghy towing .....	223
	Wattage.....	477	Trailer towing .....	222
	<b>Theft deterrent system</b>		<b>TRAC</b> .....	<b>203</b>
	Alarm.....	95	<b>Traction control</b> .....	<b>203</b>
	Engine immobilizer system .....	92	<b>Trip information</b> .....	<b>169</b>
	<b>Tire inflation pressure</b> .....	<b>375</b>	<b>Trip meter</b> .....	<b>169</b>
	<b>Tire information</b>		<b>Trunk</b>	
	Glossary .....	487	Opener .....	58
	Size .....	484	<b>Trunk light</b>	
	Tire identification number.....	483	Trunk light .....	59
	Uniform tire quality		Wattage.....	477
	grading.....	485	<b>Turn signal lights</b>	
	<b>Tires</b>		Replacing light bulbs.....	401
	Chains .....	218	Switch .....	166
	Checking .....	367	Wattage.....	477
	If you have a flat tire.....	435		
	Inflation pressure.....	375	<b>V</b>	
	Inflation pressure sensor.....	368	<b>Valet key</b> .....	<b>28</b>
	Replacing .....	435	<b>Vanity lights</b>	
	Rotating tires .....	367	Vanity lights.....	299
	Size .....	474	Wattage.....	477
	Snow tires .....	218	<b>Vanity mirrors</b> .....	<b>299</b>
	Spare tire.....	435	<b>Vehicle data recordings</b> .....	<b>21</b>
			<b>Vehicle identification</b>	
			number .....	466
			<b>Vehicle stability control</b> .....	<b>203</b>
			<b>VSC</b> .....	<b>203</b>

**W**

**Warning buzzers**

- Brake system..... 420
- Downshifting..... 158, 164
- Electric power steering system..... 421
- Open door ..... 423
- Seat belt reminder ..... 423

**Warning lights**

- Anti-lock brake system ..... 421
- Blind Spot Monitor ..... 421
- Brake assist system ..... 421
- Brake system..... 420
- Charging system ..... 421
- Cruise control indicator light ..... 421
- Electric power steering system..... 421
- Engine coolant temperature..... 421
- Engine oil pressure..... 421
- Low fuel level..... 423
- Maintenance reminder light ..... 423
- Malfunction indicator lamp.... 421
- Open door ..... 423
- Pretensioners ..... 421
- Seat belt reminder light ..... 423
- Slip indicator ..... 421
- Smart key system..... 427
- SRS airbags ..... 421
- Tire pressure warning light ..... 423
- Washer fluid ..... 423

**Washer**

- Checking .....366
- Preparing and checking before winter .....218
- Switch.....194

**Washing and waxing .....334**

**Weight**

- Cargo capacity .....213
- Load limits .....217
- Weight .....466

**Wheels .....379**

**Window glasses .....81**

**Window lock switch.....81**

**Windows**

- Power windows .....81
- Rear window defogger .....240
- Washer.....194

**Windshield wipers .....194**

**Wireless remote control key**

- Replacing the battery .....384
- Wireless remote control .....46

**WMA disc.....257**

What to do if...

What to do if...

A tire punctures	P. 435	If you have a flat tire
The engine does not start	P. 447	If the engine will not start
	P. 92	Engine immobilizer system
	P. 454	If the battery is discharged
	P. 451	If the electronic key does not operate properly
The shift lever cannot be moved out	P. 449	If the shift lever cannot be shifted from P
The rightmost segment of the engine coolant temperature display flashes	P. 459	If your vehicle overheats
Steam can be seen coming from under the hood		
The key is lost	P. 450	If you lose your keys
The battery runs out	P. 454	If the battery is discharged
The doors cannot be locked	P. 52	Doors
The horn begins to sound	P. 95	Alarm
The vehicle is stuck in mud or sand	P. 462	If the vehicle becomes stuck



A warning light or indicator light comes on

P. 420

If a warning light turns on or a warning buzzer sounds...

### Type A

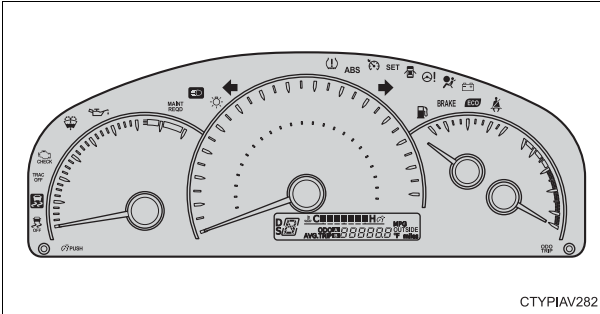

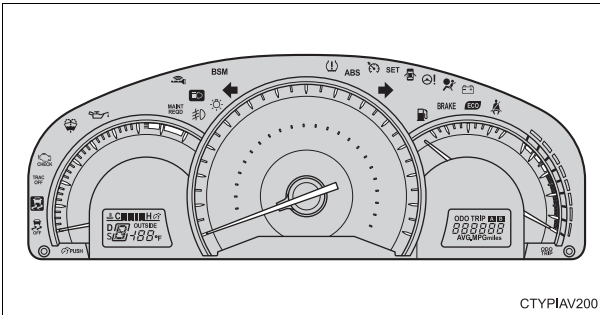

### Type B





## ■ Warning lights

<b>BRAKE</b>	Brake system warning light	
or		
		P. 420

	Charging system warning light	P. 421
---	-------------------------------	--------

	Low engine oil pressure warning light	P. 421
---	---------------------------------------	--------

	Malfunction indicator lamp	
or		
		P. 421

	SRS warning light	P. 421
---	-------------------	--------

<b>ABS</b>	ABS warning light	
or		
		P. 421

	Cruise control indicator light* <sup>1</sup>	P. 421
---	--	--------

	Slip indicator light	P. 421
---	----------------------	--------

	Tire pressure warning light	P. 423
---	-----------------------------	--------

	Low windshield washer fluid warning light	P. 423
---	---	--------

	Open door warning light	P. 423
---	-------------------------	--------

	Low fuel level warning light	P. 423
---	------------------------------	--------



	Driver's/front passenger's seat belt reminder light	P. 423
---	---	--------

	Electric power steering system warning light	P. 421
---	--	--------

<b>BSM</b>	BSM warning light	P. 421
------------	-------------------	--------

<b>MAINT REQD</b>	Maintenance required reminder light P. 423
-----------------------	--

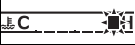
	Smart key system indicator light* <sup>2</sup> P. 421
---	---

	High engine coolant temperature warning light (the rightmost segment of the engine coolant temperature display flashes) P. 421
or	
	

\*1: The light comes on in yellow to indicate a malfunction.

\*2: The light flashes in yellow to indicate a malfunction. The light flashes quickly in green to indicate that the steering lock has not been released.

## GAS STATION INFORMATION

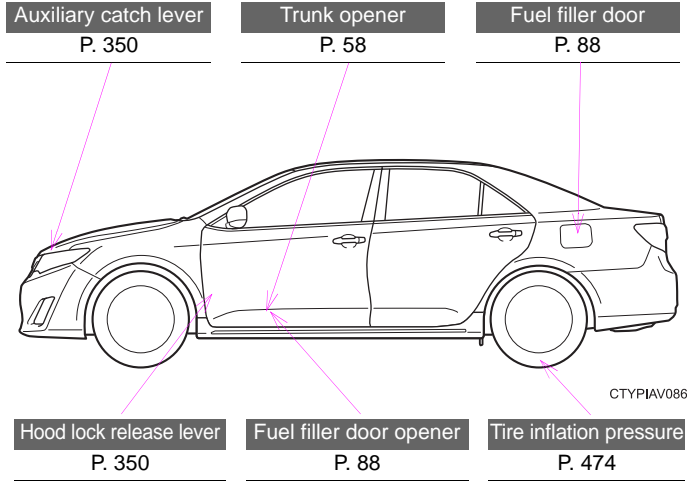

Fuel tank capacity (Reference)		17.0 gal. (64.35 L, 14.2 Imp. gal.)	
Fuel type		Unleaded gasoline only	P. 468
Cold tire inflation pressure		P. 474	
Engine oil capacity (Drain and refill reference)	2.5 L 4-cylinder (2AR-FE) engine	With filter	qt. (L, Imp. qt.) 4.6 (4.4, 3.9)
		Without filter	4.2 (4.0, 3.5)
	3.5 L V6 (2GR-FE) engine	With filter	6.4 (6.1, 5.4)
		Without filter	6.0 (5.7, 5.0)
Engine oil type		P. 469	