

SECTION 1 - 1

OPERATION OF INSTRUMENTS AND CONTROLS



Overview of instruments and controls

[Instrument panel overview](#) 2
[Instrument cluster overview](#) 4
[Indicator symbols on the instrument panel](#) 6

'03 Corolla U (L/O 0201)

Instrument panel overview

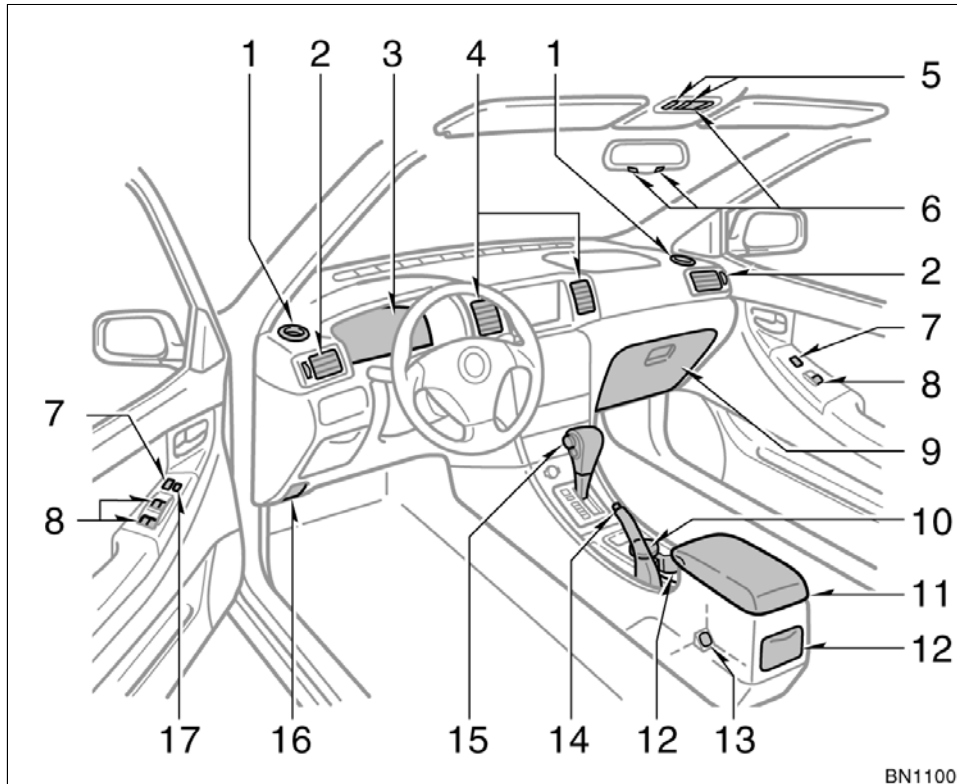

1. Side defroster outlets
2. Side vents
3. Instrument cluster
4. Center vents
5. Electric moon roof switches
6. Personal lights
7. Power door lock switches
8. Power window switches
9. Glove box
10. Portable ashtray
11. Rear console box
12. Cup holders
13. Power outlet
14. Parking brake lever
15. Automatic transmission selector lever
or manual transmission gear shift lever
16. Hood lock release lever
17. Window lock switch

'03 Corolla U (L/O 0201)

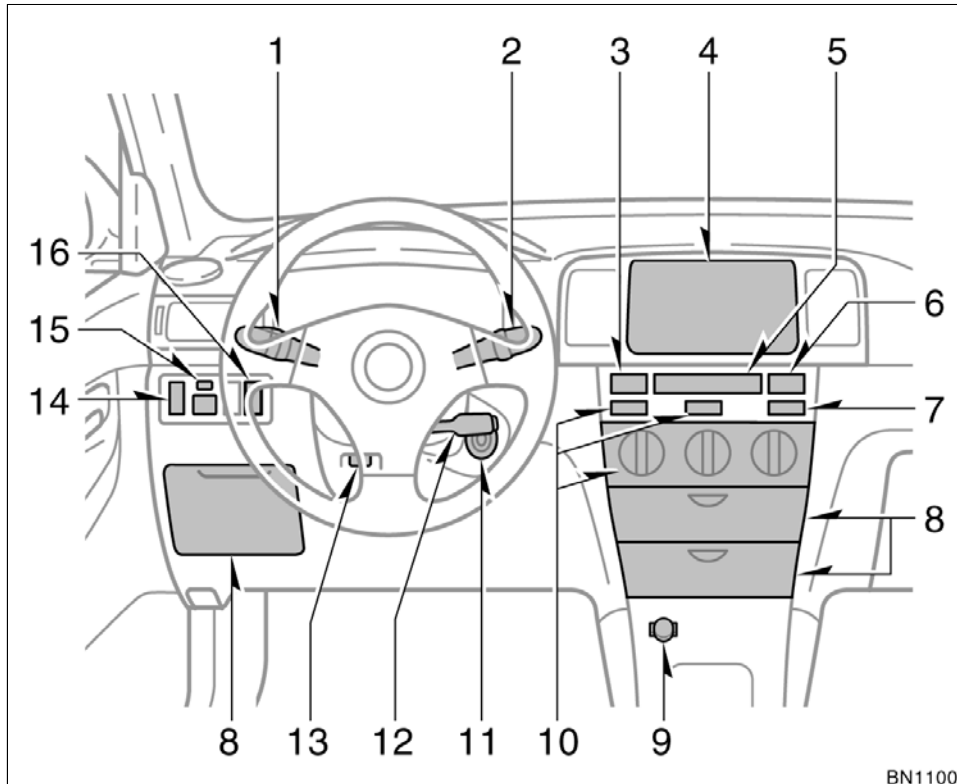

1. Headlight and turn signal switch and front fog light switch
2. Wiper and washer switches
3. Emergency flasher switch
4. Car audio
5. Clock
6. Front passenger's seat belt reminder light
7. Rear window defogger switch
8. Auxiliary boxes
9. Power outlet or cigarette lighter
10. Air conditioning controls
11. Ignition switch
12. Cruise control switch
13. Tilt steering lock release lever
14. Interior/instrument panel light control dial
15. Power rear view mirror control switches
16. Toyota vehicle intrusion protection system indicator light

'03 Corolla U (L/O 0201)

Instrument cluster overview

►Type A

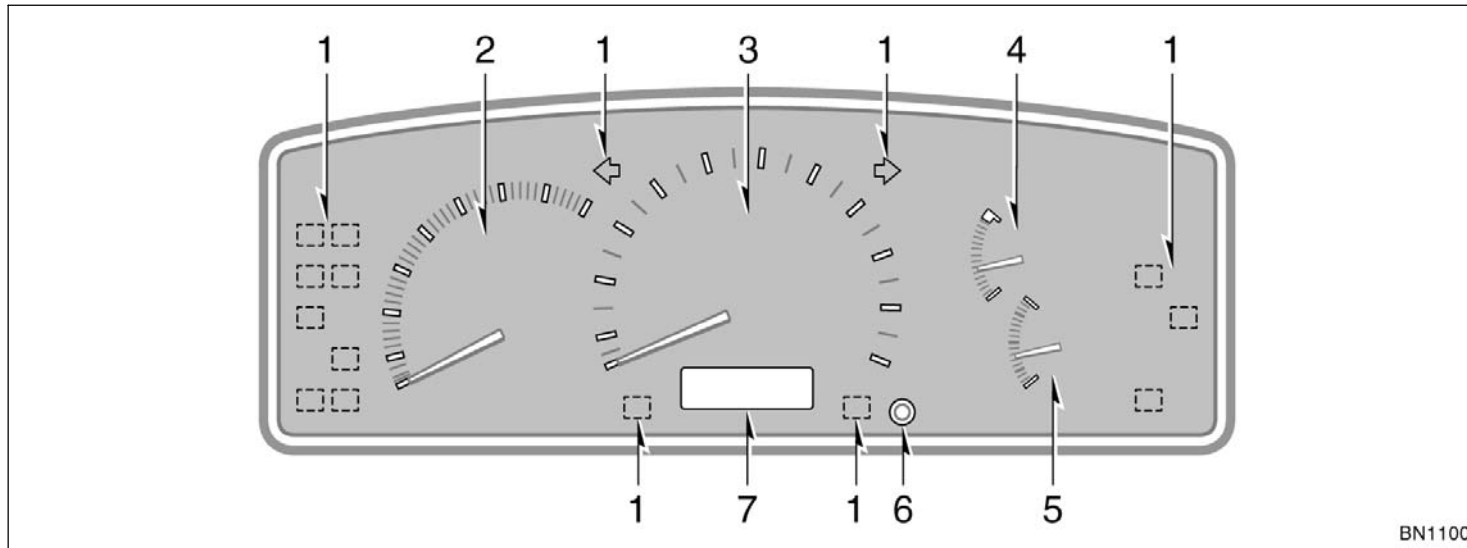

- 1. Service reminder indicators and indicator lights
- 2. Tachometer
- 3. Speedometer

- 4. Engine coolant temperature gauge
- 5. Fuel gauge
- 6. Trip meter reset knob
- 7. Odometer, two trip meters and outside temperature display

'03 Corolla U (L/O 0201)

►Type B

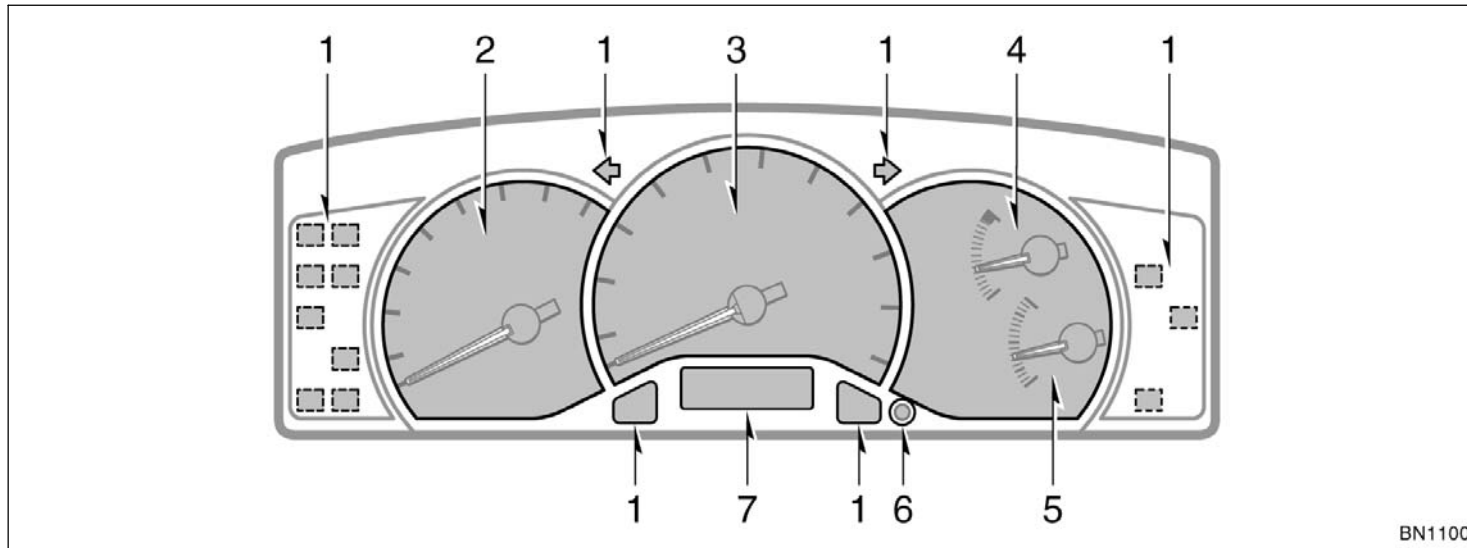

BN11007















- 1. Service reminder indicators and indicator lights
- 2. Tachometer
- 3. Speedometer

- 4. Engine coolant temperature gauge
- 5. Fuel gauge
- 6. Trip meter reset knob

- 7. Odometer, two trip meters and outside temperature display

'03 Corolla U (L/O 0201)

Indicator symbols on the instrument panel

BRAKE or 	Brake system warning light* ¹		Low engine oil pressure warning light* ¹
	Driver's seat belt reminder light* ¹	ABS or 	Anti-lock brake system warning light* ¹
PASSENGER 	Front passenger's seat belt reminder light* ¹		Open door warning light* ¹
	Discharge warning light* ¹		SRS warning light* ¹
 CHECK or 	Malfunction indicator lamp* ¹		Low windshield washer fluid level warning light * ¹ , * ³
	Low fuel level warning light* ¹		Headlight high beam indicator light
			Turn signal indicator lights

'03 Corolla U (L/O 0201)

O/D OFF	Overdrive-off indicator light
CRUISE	Cruise control indicator light* ²

*1: For details, see "Service reminder indicators and warning buzzers" on page 85 in Section 1-5.

*2: If this light flashes, see "Cruise control" on page 99 in Section 1-6.

*3: This symbol equipped only on vehicles sold in Canada.

'03 Corolla U (L/O 0201)