



Customer Experience Center  
1-800-331-4331

# HIGHLANDER

## 2009 Quick Reference Guide

# 2009 Highlander

This *Quick Reference Guide* is a summary of basic vehicle operations. It contains brief descriptions of fundamental operations so you can locate and use the vehicle's main equipment quickly and easily.

The *Quick Reference Guide* is not intended as a substitute for the *Owner's Manual* located in your vehicle's glove box. We strongly encourage you to review the *Owner's Manual* and supplementary manuals so you will have a better understanding of your vehicle's capabilities and limitations.

Your dealership and the entire staff of Toyota Motor Sales, U.S.A., Inc. wish you many years of satisfied driving in your new Highlander.

## ! A word about safe vehicle operations

This *Quick Reference Guide* is not a full description of Highlander operations. Every Highlander owner should review the *Owner's Manual* that accompanies this vehicle.

Pay special attention to the boxed information highlighted in color throughout the *Owner's Manual*. Each box contains safe operating instructions to help you avoid injury or equipment malfunction.

All information in this *Quick Reference Guide* is current at the time of printing. Toyota reserves the right to make changes at any time without notice.

## Seatbelts-Shoulder belt anchor

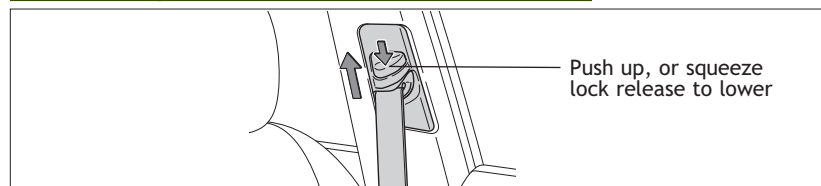

## Doors-Child safety locks

Rear door

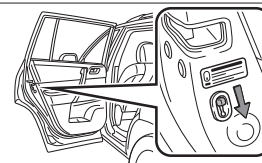

Moving the lever to "LOCK" will allow the door to be opened only from the outside.

## Spare tire & tools

Tool location

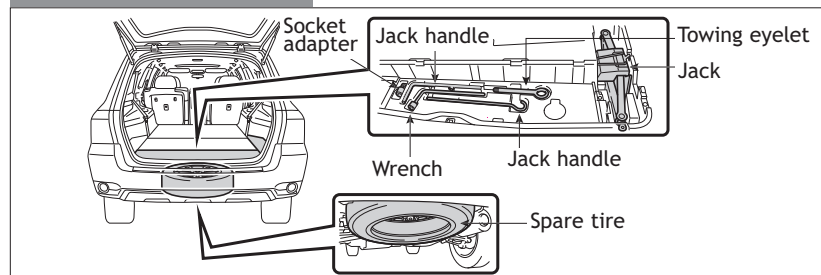

Removing the spare tire

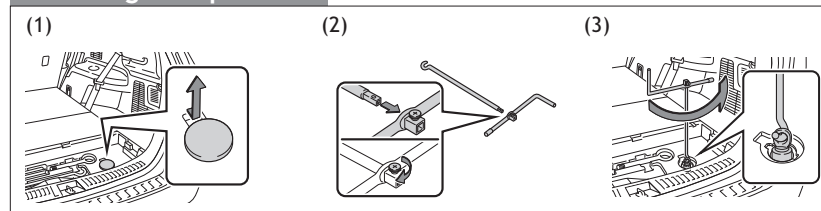

- (1) Remove the cover under the center deck board to find the spare tire clamp bolt.
- (2) Assemble the jack handle.
- (3) Put the socket adapter on the spare tire clamp bolt. Loosen the bolt by turning it counterclockwise with the jack handle.

Refer to the *Owner's Manual* for tire changing and jack positioning procedures.

# INDEX

## OVERVIEW

Engine maintenance	9
Fuel tank door release and cap	8
Hood release	8
Indicator symbols	4-5
Instrument cluster	4
Instrument panel	2-3
<b>Keyless entry<sup>1</sup></b>	<b>6</b>
Light control-Instrument panel	9
<b>Smart Key system<sup>1,2</sup></b>	<b>7</b>

## FEATURES/OPERATIONS

Air Conditioning/Heating	20-22
Audio	24-25
<b>Auto lock functions<sup>1</sup></b>	<b>11</b>
Automatic Transmission	10
Clock	22
Cruise control	23
Cup holders	27
Door locks	11
Door-Power back	12
Downhill Assist Control system (DAC)	26
Garage door opener (HomeLink <sup>®</sup> ) <sup>3</sup>	23
Hill-start Assist Control (HAC)	27
<b>Lights<sup>1</sup> &amp; turn signals</b>	<b>16</b>
Moonroof	12
<b>Multi-information display<sup>2</sup></b>	<b>18</b>
Parking brake	11
Power outlets-12V DC	17
Power outlets-115V AC	17
Rear seat entertainment system	26
Seat adjustments-Front	13
Seat adjustments-Rear	13
Seat heaters	22
Seats-Folding down second row seats	15
Seats-Head restraints	14
Seats-Removing Center-Stow <sup>™</sup> second row seat	14
Seats-Stowing third row seats	14
Steering lock release	11
Steering wheel controls	25
Telephone controls (Bluetooth <sup>®</sup> )	19
Tilt and telescopic steering wheel	12
Windows-Power	18
Windshield wipers & washers	15

## SAFETY AND

## EMERGENCY FEATURES

Doors-Child safety locks	29
Seatbelts	28
Seatbelts-Shoulder belt anchor	29
Spare tire & tools	29
Tire Pressure Monitoring (warning) System	28

<sup>1</sup> Visit your Toyota dealer for information on customizing this feature.

<sup>2</sup> Programmable by customer. Refer to the Owner's Manual for instructions and more information.

<sup>3</sup> HomeLink<sup>®</sup> is a registered trademark of Johnson Controls, Inc.

# OVERVIEW

## Instrument panel

### Steering wheel controls (if equipped)

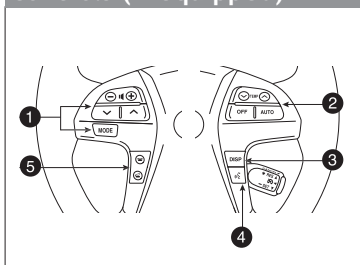

### Automatic Air Conditioning

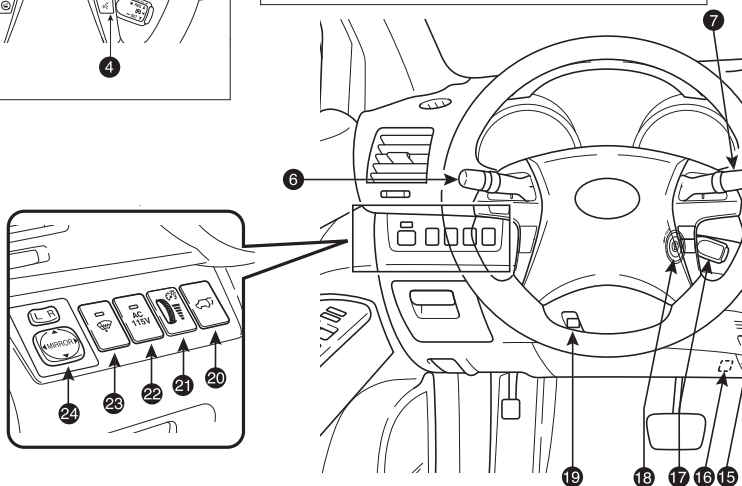
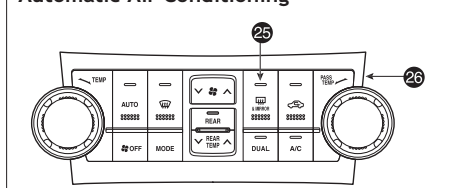

- 1 Steering wheel audio controls<sup>1</sup>
- 2 Steering wheel climate controls<sup>1</sup>
- 3 Multi-information display button<sup>1</sup>
- 4 Voice command button<sup>1</sup>
- 5 Telephone controls<sup>1,2</sup>
- 6 Headlight and turn signal controls/Headlight, turn signal and front fog light controls<sup>1</sup>
- 7 Wiper and washer controls
- 8 Multi-information display<sup>1</sup>
- 9 Audio system or navigation system-integrated audio system<sup>1,2</sup>
- 10 Theft deterrent system/Engine immobilizer indicator<sup>1</sup>
- 11 Emergency flasher button
- 12 "AIR BAG ON" and "AIR BAG OFF" indicator and front passenger seatbelt reminder lights
- 13 Power back door main switch<sup>1</sup>
- 14 "ENGINE START STOP" button (Smart Key)<sup>1</sup>
- 15 VSC/TRAC OFF switch

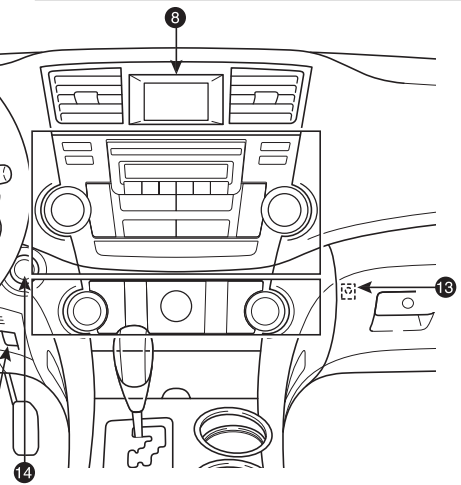
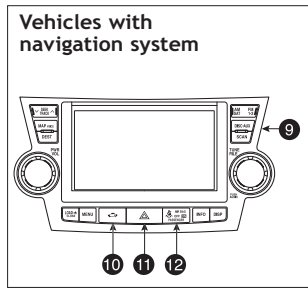
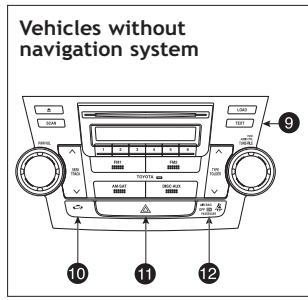
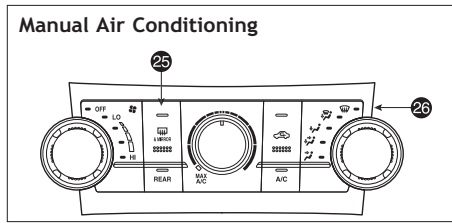

- 16 Tire Pressure Monitoring (warning) System
- 17 Cruise control
- 18 Ignition (standard key)
- 19 Tilt and telescopic steering lock release
- 20 Power back door button<sup>1</sup>
- 21 Instrument panel light control
- 22 115V AC Power outlet ON/OFF switch<sup>1</sup>
- 23 Windshield wiper de-icer switch<sup>1</sup>
- 24 Power rearview mirror control
- 25 Outside rearview mirror<sup>1</sup>/Rear window defogger button
- 26 Air Conditioning controls

<sup>1</sup> If equipped

<sup>2</sup> For vehicles with a navigation system, refer to the “Navigation System Owner’s Manual.”

## Instrument cluster

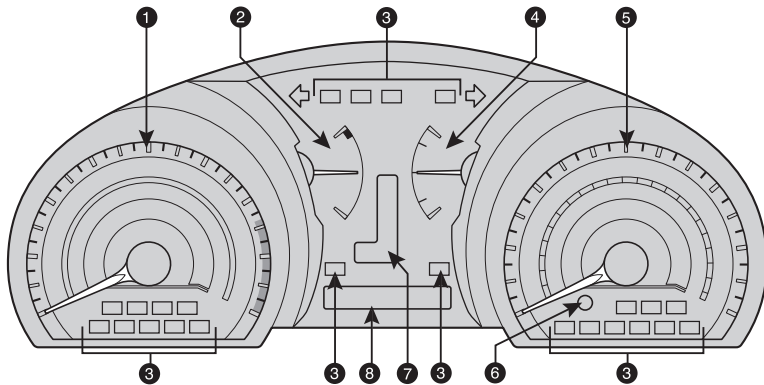

















- ❶ Tachometer
- ❷ Engine coolant temperature
- ❸ Service indicator and reminder
- ❹ Fuel gauge
- ❺ Speedometer
- ❻ Trip meter reset knob
- ❼ Automatic Transmission shift position indicator
- ❽ Odometer and two trip meters/Automatic Transmission shift range display

## Indicator symbols

For details, refer to “Indicators and warning lights,” Section 2-2, 2009 *Owner’s Manual*.

	Brake system warning <sup>1</sup>
	Driver seatbelt reminder (alarm will sound if speed is over 12 mph)
	Front passenger seatbelt reminder (alarm will sound if speed is over 12 mph)
	Charging system warning <sup>1</sup>
	Front passenger occupant classification or front passenger airbag ON/OFF indicator <sup>1</sup>
	Low engine oil pressure warning <sup>1</sup>
	Malfunction/Check Engine indicator <sup>1</sup>

<sup>1</sup> If indicator does not turn off within a few seconds of starting engine, there may be a malfunction. Have vehicle inspected by your Toyota dealer.

<b>MAINT REQD</b>	Engine oil replacement reminder <sup>1</sup>
	Low fuel level warning
	Open door warning
	Airbag SRS warning <sup>1</sup>
	Master warning
<b>A/T OIL TEMP</b>	Automatic Transmission fluid temperature warning <sup>1</sup>
	Low Tire Pressure Warning <sup>1</sup>
	Electric power steering system warning <sup>1</sup>
	Low windshield washer fluid level warning <sup>1</sup>
	Theft deterrent/Engine immobilizer system indicator
 	Headlight low/high beam indicator
	Turn signal indicator
	Tail light indicator
	Front fog light indicator
	Slip indicator/Hill-start Assist Control indicator/Downhill Assist Control indicator <sup>1</sup>
	Vehicle Stability Control OFF indicator <sup>1</sup>
<b>SNOW</b>	SNOW indicator
<b>CRUISE</b>	Cruise control indicator <sup>2</sup>
	Downhill Assist Control indicator <sup>1</sup>
<b>ABS</b>	Anti-lock Brake System warning <sup>1</sup>
<b>TRAC OFF</b>	Traction control OFF indicator <sup>1</sup>

<sup>2</sup> If this light flashes, refer to "Cruise control," Section 2-4, 2009 Owner's Manual.

## Keyless entry

### Locking operation

Without Smart Key system



With power back door

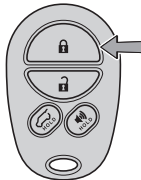

Without power back door

With Smart Key system



Push 

### Unlocking operation

Without Smart Key system

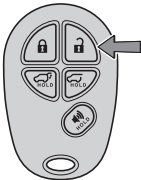

With power back door

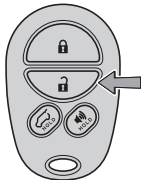

Without power back door

With Smart Key system



Push ONCE: Driver door   
TWICE: All doors

**NOTE:** If a door is not opened within 30 seconds of unlocking, all doors will relock for safety.

### Glass hatch operation (if equipped)

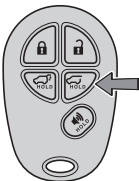

With power back door



Without power back door

Push and hold 

### Power back door operation (if equipped)

Without Smart Key system



With Smart Key system



Push and hold 

### Panic button



Push and hold





## Smart Key system (if equipped)

### Start function

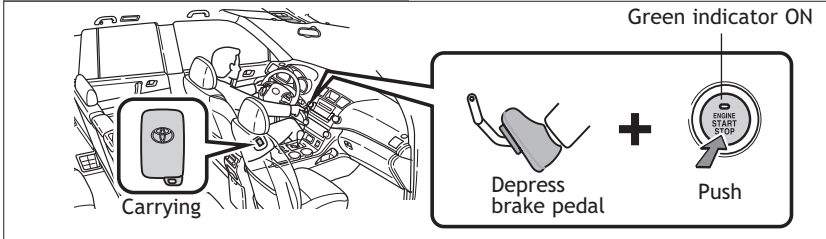

**NOTE:** Gear shift lever must be in Park and brake pedal depressed.

### Power (without starting engine)

Without depressing the brake pedal, pressing the “ENGINE START STOP” switch will change the operation mode in succession from:

**ACC**

Accessories such as the radio will operate.

**ON**

Power ON; the engine not running.

**OFF**

All systems OFF.

### Locking operation

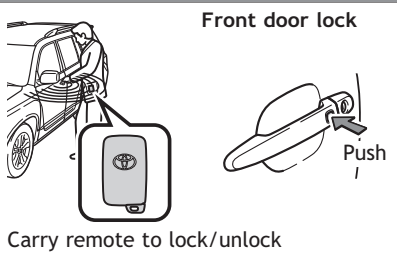

### Unlocking operation

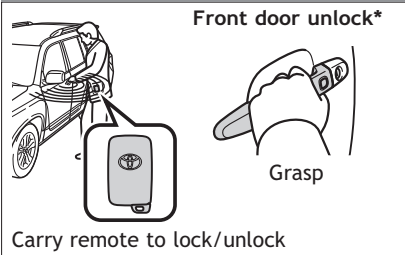

### Glass hatch unlock

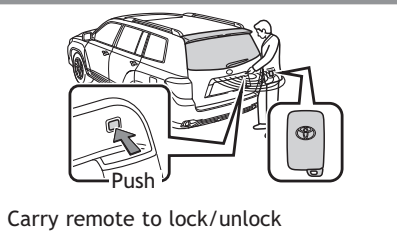

### Back door lock/unlock

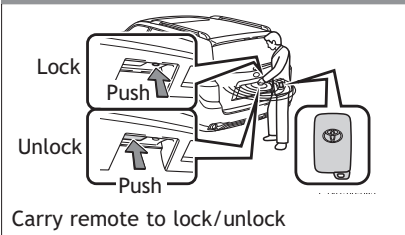

\* Driver door unlocking function can be programmed to unlock driver door only, or all doors. Grasping passenger door handle will unlock all doors.

**NOTE:** Doors may also be locked/unlocked using remote.

## Fuel tank door release and cap

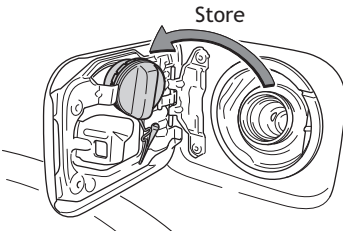
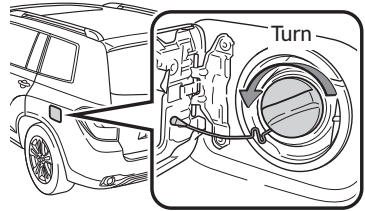
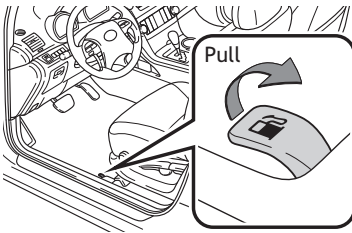

**NOTE:** Tighten until one click is heard. If the cap is not tightened enough, Check Engine “” indicator may illuminate.

## Hood release

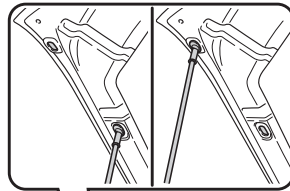
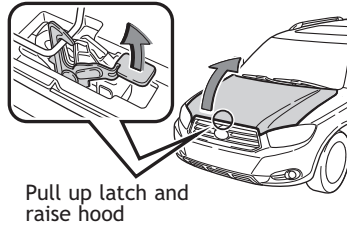
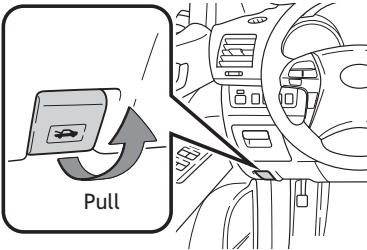

Engage support rod



## Light control-Instrument panel

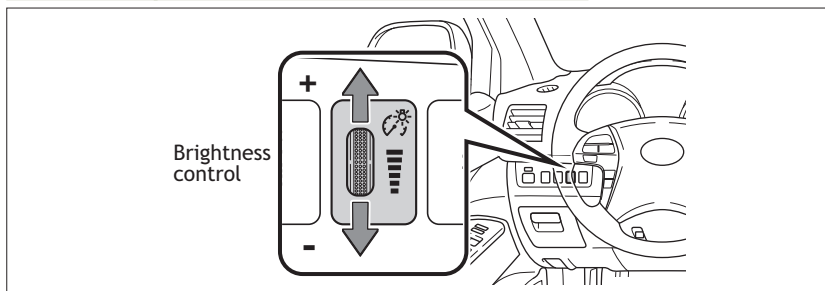

## Engine maintenance

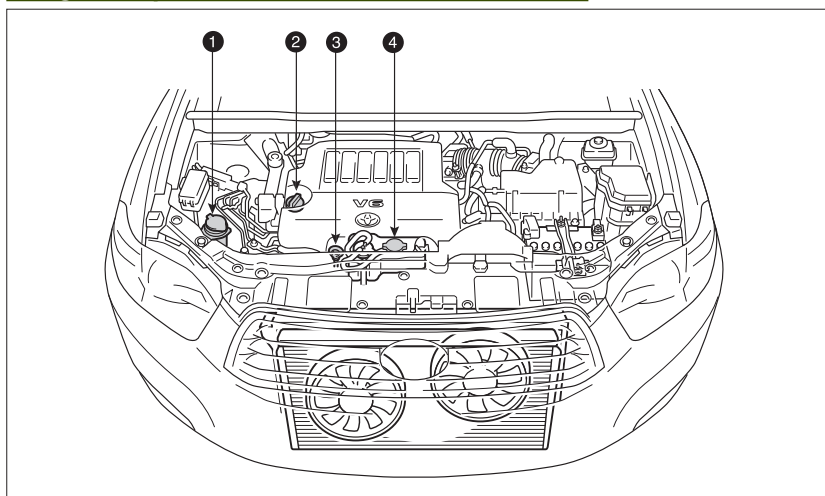

- 1 Windshield washer fluid tank
- 2 Engine oil filler cap
- 3 Engine oil level dipstick
- 4 Engine coolant reservoir

**Note:** Regularly scheduled maintenance, including oil changes, will help extend the life of your vehicle and maintain performance. Please refer to the “Owner’s Warranty Information Booklet,” “Scheduled Maintenance Guide” or “Owner’s Manual Supplement.”

# FEATURES/OPERATIONS

## Automatic Transmission

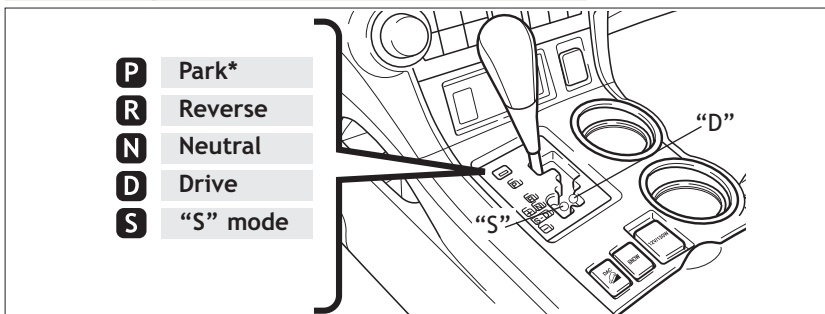

\* The ignition switch must be "ON" and the brake pedal depressed to shift from Park.

### "S" (Sequential) mode

Shift the shift lever to "S" position from "D" position.

#### Floor shift type:

- + : Upshift (push and release)
- : Downshift (pull and release)

Downshifting increases power going uphill, or provides engine braking downhill. For best fuel economy during normal driving conditions, always drive with the shift lever in the "D" position.

## Snow mode

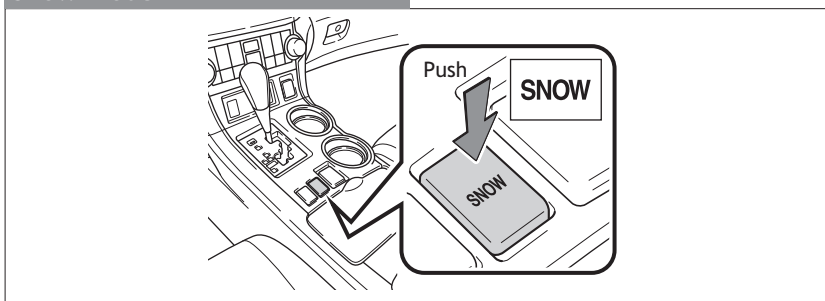

The snow mode prevents sudden acceleration on slippery surfaces. Use in snowy or icy road conditions.

## Auto lock functions

Automatic door locks can be programmed to operate in two different modes, or turned OFF.

- Doors lock when shifting from Park.
- Doors unlock when shifting into Park.

Refer to the *Owner's Manual* for more details.

## Steering lock release

Smart Key system

Without Smart Key system

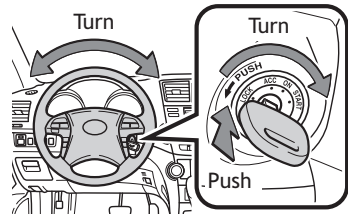
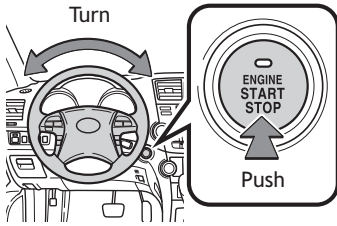

## Door locks

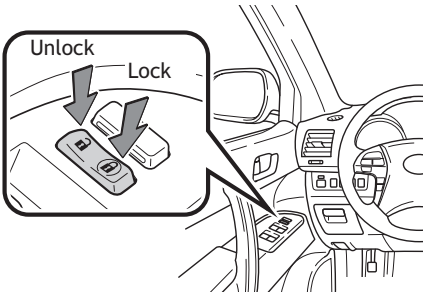

## Parking brake

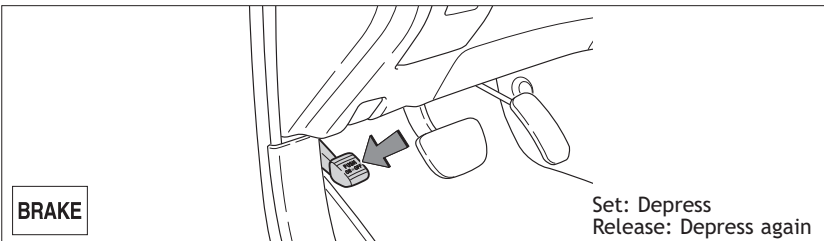

## Tilt and telescopic steering wheel

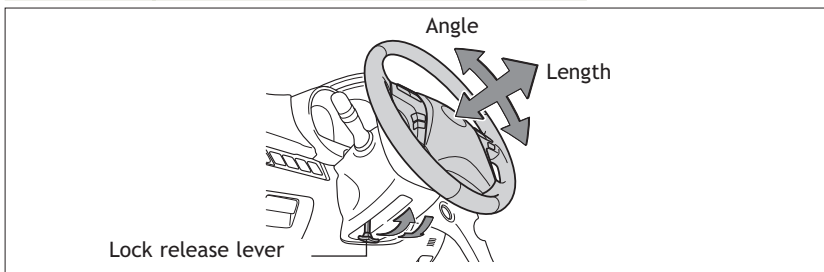

Hold wheel, push lever down, set angle and length, and return lever.

**Note:** Do not attempt to adjust while the vehicle is in motion.

## Moonroof (if equipped)

### Sliding operation

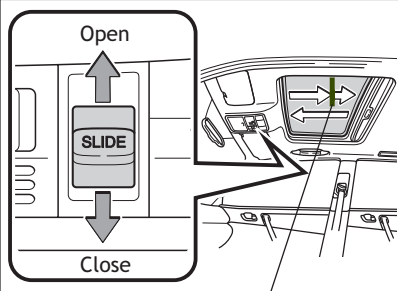

Recommended driving position to minimize wind noise.

### Tilting operation

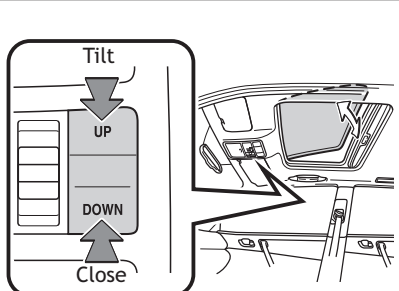

## Door-Power back (if equipped)

### Instrument panel

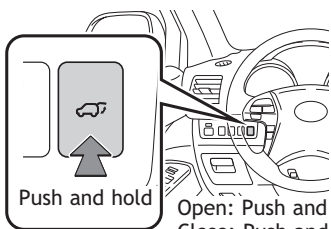

Open: Push and hold  
Close: Push and hold again

### Back door (close only)

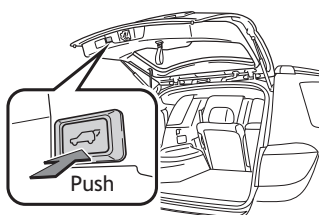

**NOTE:** If battery is disconnected, the power back door needs to be reinitialized. Refer to the *Owner's Manual* for more details.

## Seat adjustments-Front

### Manual seat

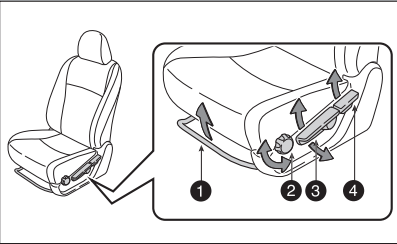

### Power seat

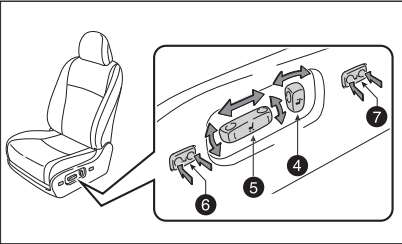

- 1 Seat position (forward/backward)
- 2 Seat cushion angle
- 3 Height crank (driver side only)
- 4 Seatback angle
- 5 Seat position, cushion angle and height
- 6 Driver seat leg support (if equipped)
- 7 Lumbar support (driver side only)

## Seat adjustments-Rear

### Second row seat

#### Without third seat

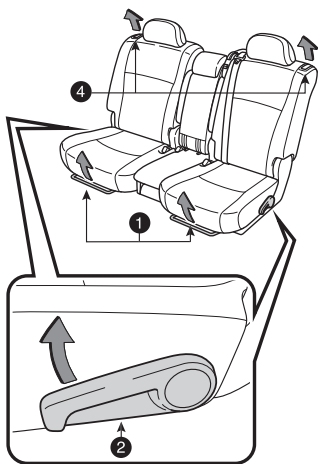

#### With third seat

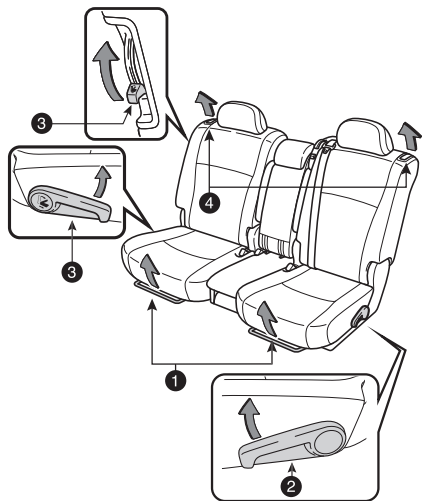

- 1 Seat position (forward/backward)
- 2 Seatback angle
- 3 Third seat access lever
- 4 Seatback release

Refer to the *Owner's Manual* for more details.

### Seats-Head restraints

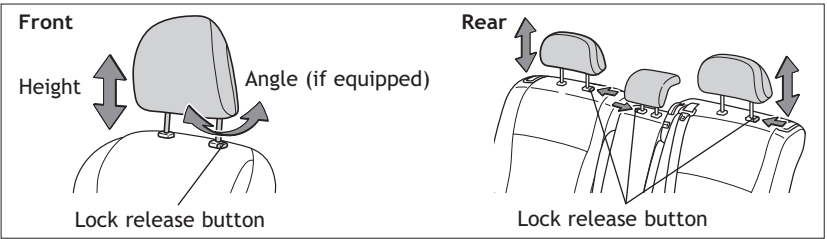

### Seats-Removing Center-Stow™ second row seat

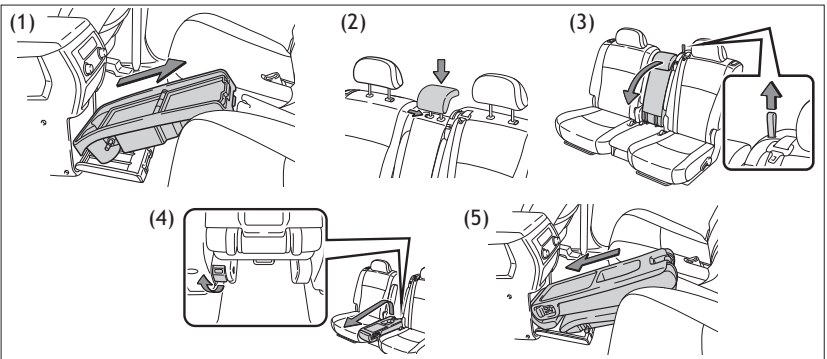

- (1) Remove the second row console from the front center console box.
- (2) Lower the center head restraint.
- (3) Pull the strap, then fold down the seatback.
- (4) Pull the lever behind the second center seat and lift the rear of the seat to remove.
- (5) Stow the seat in the front center console box.

**NOTE:** The second-row console can now be installed between the second row seats.

### Seats-Stowing third row seats (if equipped)

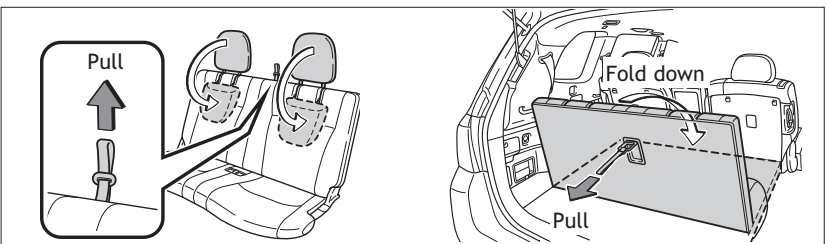

Refer to the *Owner's Manual* for more details.



## Seats-Folding down second row seats (if equipped)

From outside

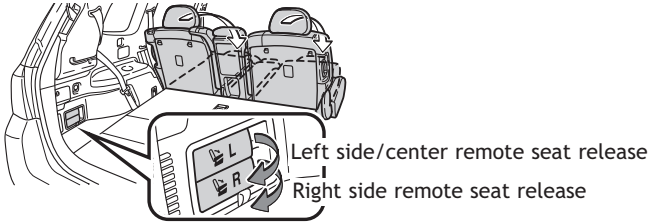

From inside

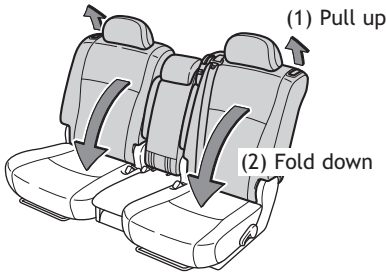

## Windshield wipers & washers

Front

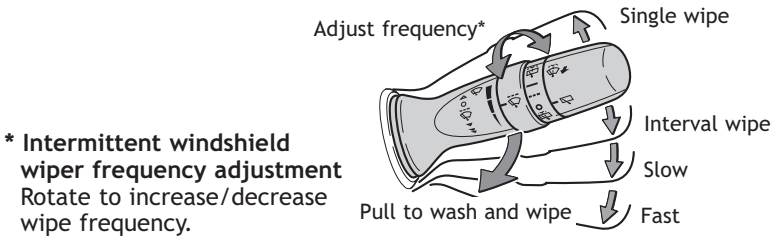

Rear

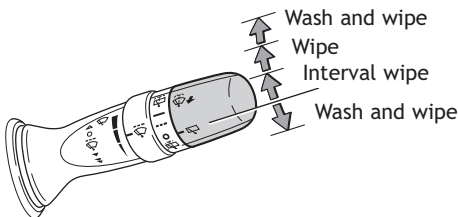

## Lights & turn signals

### Headlights

**With DRL OFF switch**

**Without DRL OFF switch**

Headlights  
Parking lights  
Auto  
DRL OFF

Auto  
Headlights  
Parking lights

High beam  
High beam flasher  
Low beam

- Daytime Running Light system (DRL) (if equipped) Automatically turns on the turn signal lights at a reduced intensity.
- Automatic light cut off system Automatically turns lights off after a delay of 30 seconds.

### Front fog lights (if equipped)

Turn

Front fog lights come on only when the headlights are on low beam.

### Turn signals

Right turn  
Lane change  
Lane change  
Left turn

Turn signals operate as follows:

- Right turn
- Lane change
- Lane change
- Left turn

## Power outlets-12V DC

Instrument panel (with seat heater)

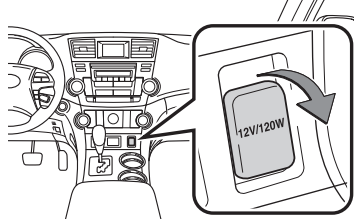

Instrument panel (without seat heater)

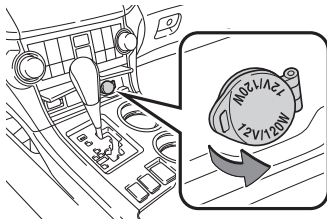

Center console

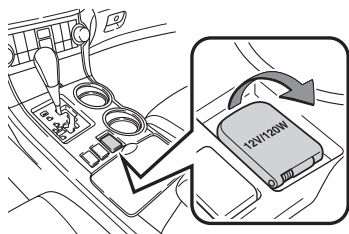

Luggage compartment

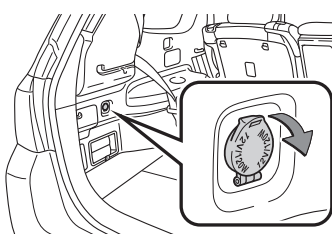

Key/Engine switch must be in the "ACC" or "ON" position to be used.

## Power outlets-115V AC (if equipped)

ON/OFF switch

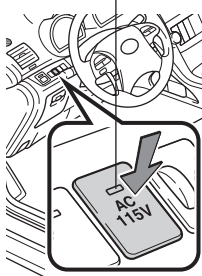

Beside second row seat

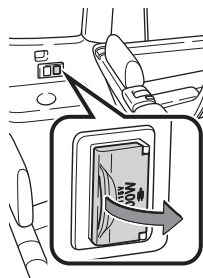

Key/Engine switch must be in the "ON" position to be used.

## Multi-information display (if equipped)

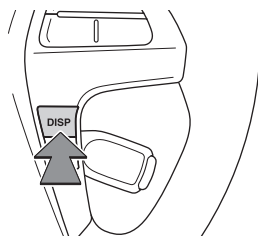
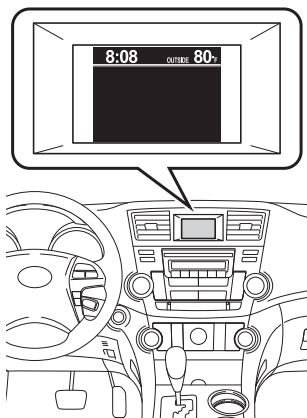

Push "DISP" to change information in the following:

- (1) Average gas mileage after refueling
- (2) Current gas mileage
- (3) Miles left on remaining fuel
- (4) Driving distance from engine start
- (5) Average gas mileage
- (6) Average gas mileage history

Push and hold "DISP" to set up the displays and the rearview monitor displays.

## Windows-Power

Driver side

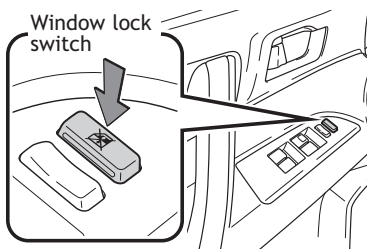
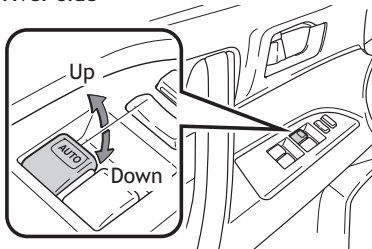

**Automatic operation (Driver's window only)** Push the switch completely down or pull it completely up and release to fully open or close. To stop window midway, lightly push the switch in the opposite direction.

**Window lock switch** Deactivates all passenger windows. Driver's window remains operable.

## Telephone controls (Bluetooth®) (if equipped)

Audio unit

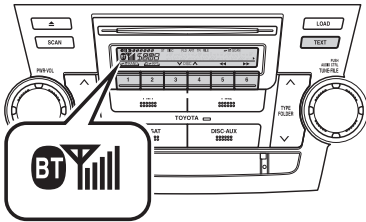

Microphone

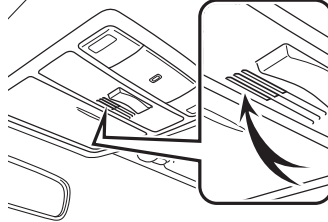

Steering wheel telephone controls

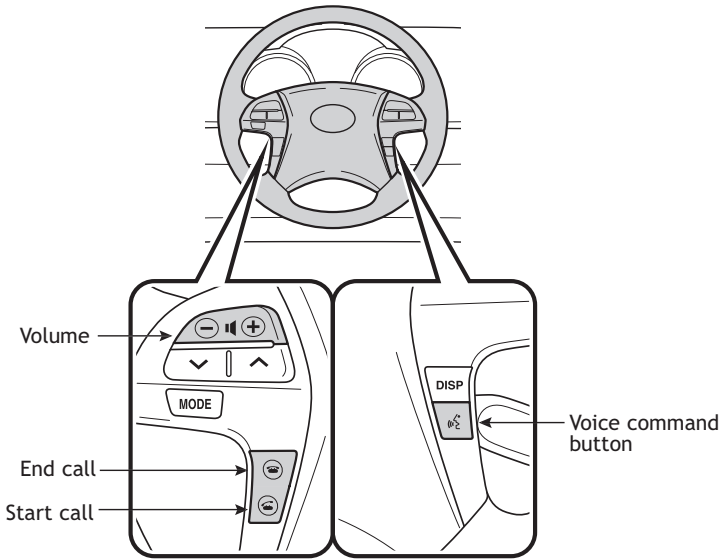

Bluetooth® technology allows dialing or receipt of calls without taking hands from the steering wheel or using a cable to connect the telephone and the system.

Refer to “Hands-free phone system (for cellular phone),” Section 3-4 in the *Owner’s Manual* for more details.

## Air Conditioning/Heating

### Front manual Air Conditioning

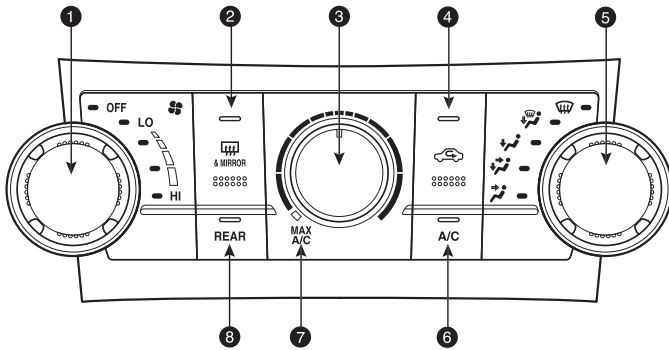

- 1 Fan speed
- 2 Outside rearview mirror (if equipped)/Rear window defogger
- 3 Temperature selector
- 4 Fresh or recirculated cabin air
- 5 Airflow vent  
In “” or “” mode, use fresh air (“” indicator OFF) to reduce window fogging.
- 6 Air Conditioning ON/OFF  
Use fresh air to quickly cool interior, then change to recirculate for cooler air.
- 7 Use for quick cooling. MAX A/C changes air intake to recirculate.
- 8 Rear Air Conditioning ON/OFF

### Rear manual Air Conditioning (if equipped)

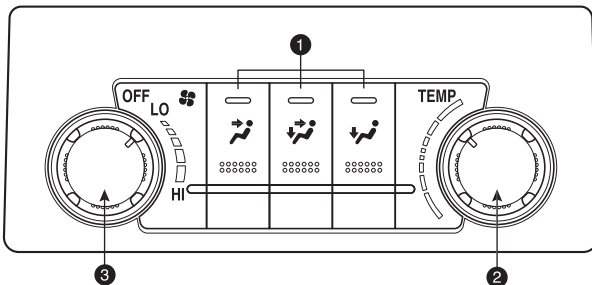

- 1 Airflow vent
- 2 Temperature selector
- 3 Fan speed

## Front automatic Air Conditioning

With rear Air Conditioning

Without rear Air Conditioning

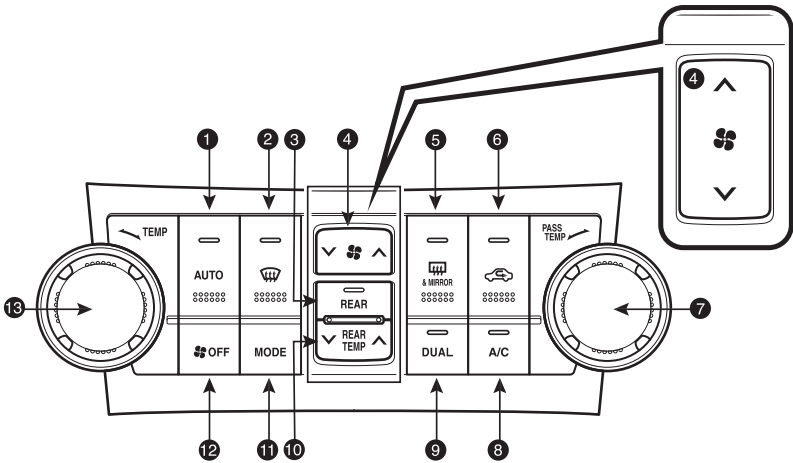

- 1 Automatic climate control ON  
Adjusting the temperature setting will cause the airflow vents, air intake and fan to adjust automatically.
- 2 Windshield airflow/defogger
- 3 Rear Air Conditioning ON/OFF
- 4 Fan speed
- 5 Outside rearview mirror (if equipped)/Rear window defogger
- 6 Fresh or recirculated cabin air
- 7 Temperature selector (front passenger side)
- 8 Air Conditioning ON/OFF
- 9 "DUAL" button  
Indicator ON: Separate temperature settings for driver, front passenger and rear passengers.  
Indicator OFF: Synchronize temperature settings for driver and all passengers.
- 10 Temperature selector (rear passenger)
- 11 Airflow vent  
In " " or " " mode, use fresh air ( " " indicator OFF) to reduce window fogging.
- 12 Climate control OFF
- 13 Temperature selector (driver side)

## Rear automatic Air Conditioning (if equipped)

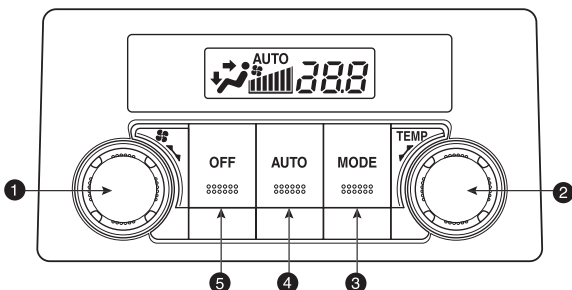

- 1 Fan speed
- 2 Temperature selector
- 3 Airflow vent
- 4 Automatic climate control ON
- 5 Climate control OFF

## Seat heaters (if equipped)

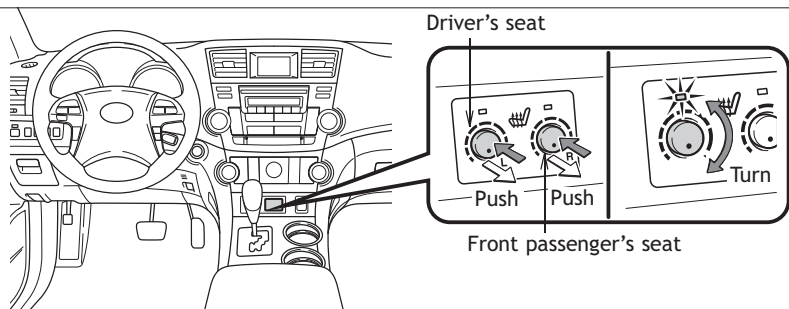

Push knob to pop the controller out. Turn clockwise for heater.

## Clock

Without multi-information display

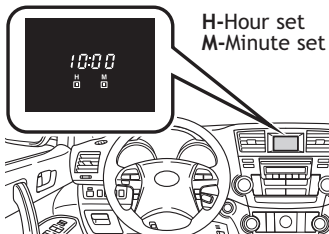

With multi-information display

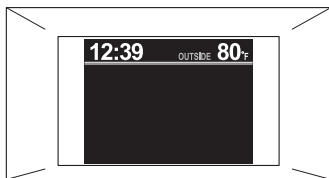

**With multi-information display** Press and hold “DISP” button. Select “CLOCK” on menu screen. Adjust as indicated on screen.



## Cruise control

### Turning system ON/OFF

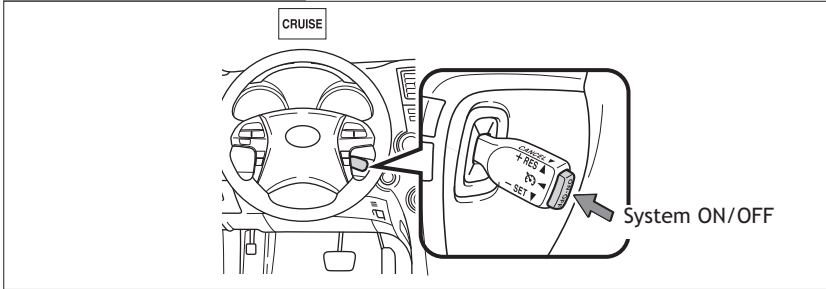

### Functions

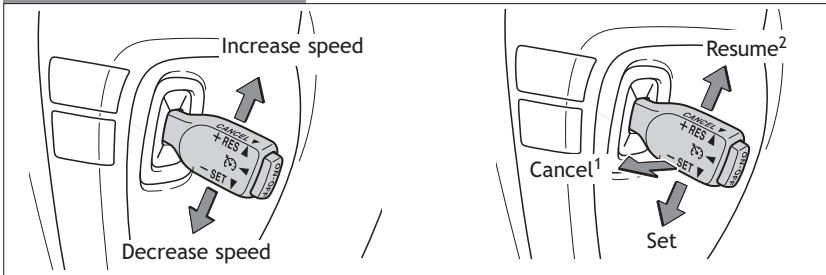

<sup>1</sup> The set speed may also be cancelled by depressing the brake pedal.

<sup>2</sup> The set speed may be resumed once vehicle speed exceeds 25 mph.

## Garage door opener (HomeLink®)\* (if equipped)

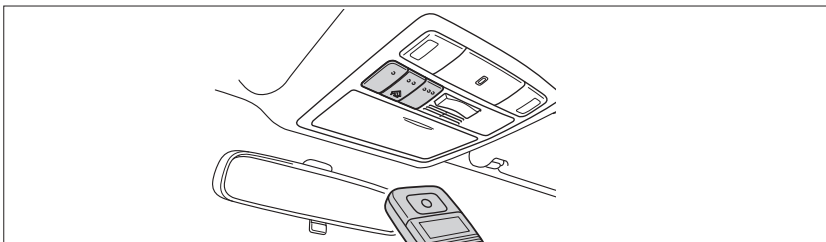

Garage door openers manufactured under license from HomeLink®\* can be programmed to operate garage doors, estate gates, security lighting, etc.

Refer to "Garage door opener," Section 3-7 in the *Owner's Manual* for more details.

For programming assistance, contact the Toyota Customer Experience Center at 1-800-331-4331, or visit <http://www.homelink.com>.

\* HomeLink® is a registered trademark of Johnson Controls, Inc.

## Audio

### Type 1

Preset buttons - functions in other modes indicated above number

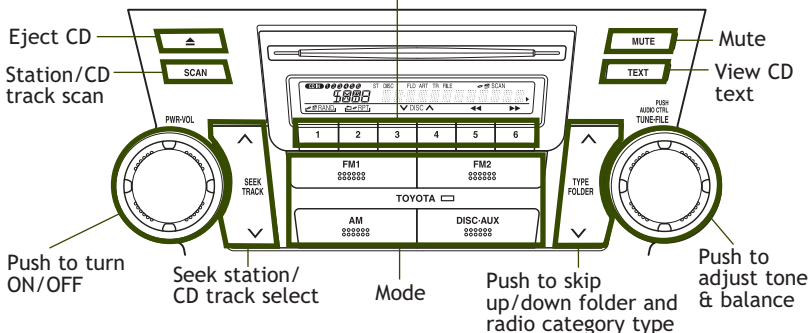

### Type 2 additional functions

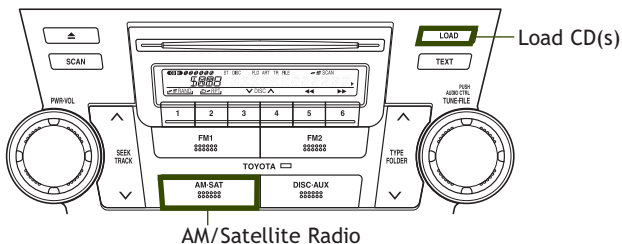

### Type 3 (with JBL speakers and Bluetooth® function)

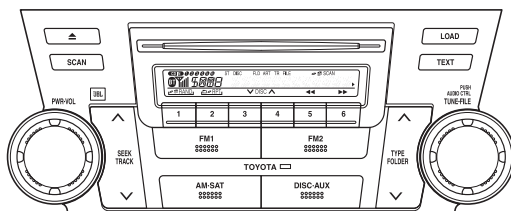

## CD PLAYER

To scan tracks on a disc Push and hold “SCAN.” Push again to hold selection.

### CD changer (Types 2 and 3 only)

- To load one disc Push “LOAD” and insert one disc.
- To load multiple discs Push and hold “LOAD” until you hear a beep. Insert one disc. Shutter will close and then re-open for next disc.

To select a file (MP3/WMA only) Turn “TUNE-FILE.”

To select a folder (MP3/WMA only) Push either side of “FOLDER.”

## RADIO

**To preset stations** Tune in the desired station and hold down a preset button (1-6) until you hear a beep. Push desired preset button (1-6) to select.

**To scan stations** Push and hold “SCAN” to scan preset stations. Push again to hold selection.

## AUX audio jack

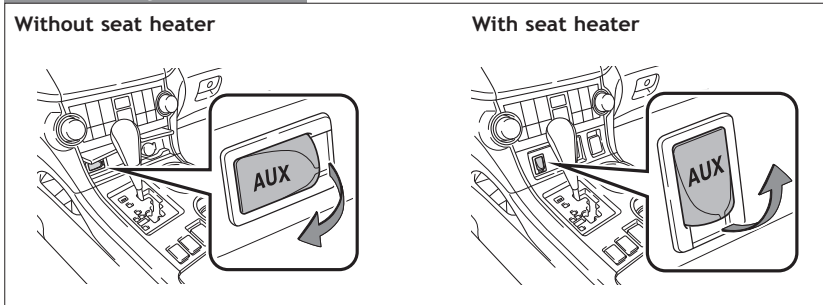

By inserting a mini plug into the AUX audio jack, you can listen to music from a portable audio device through the vehicle's speaker system while in AUX mode.

## Steering wheel controls (if equipped)

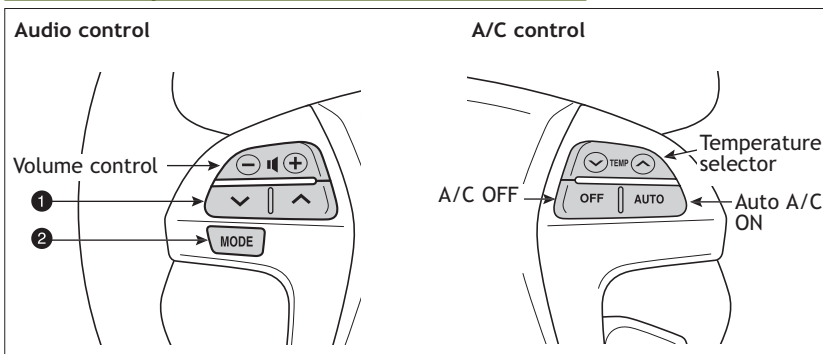

### ① “V A”

-In **radio mode** Push to select a preset station; push and hold to seek the next strong station.

-In **CD mode** Push to skip up or down to next/previous track.

### ② “MODE”

Push to turn audio ON and select an audio mode. Push and hold to turn the audio system OFF.

## Rear seat entertainment system (if equipped)

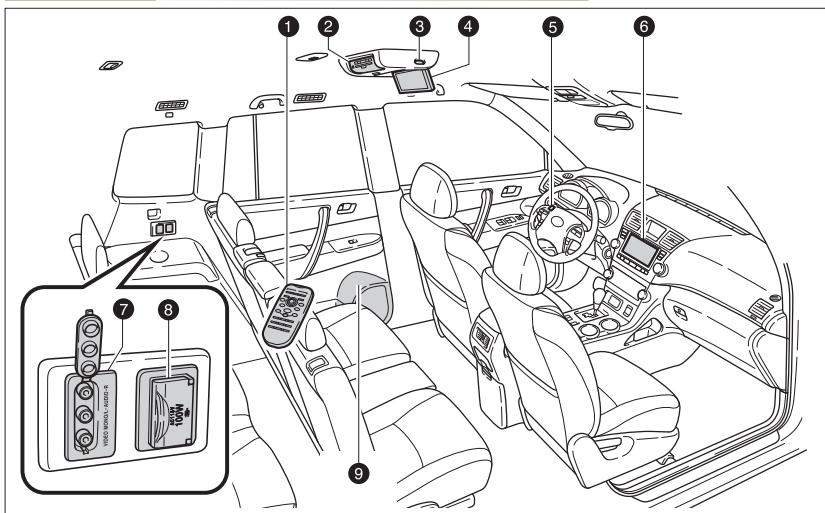

- 1 Remote control
- 2 DVD player
- 3 Headphone volume control and headphone jacks
- 4 DVD screen
- 5 115V AC Power outlet ON/OFF switch
- 6 Front audio system
- 7 A/V input adapter
- 8 115V AC Power outlet
- 9 Wireless headphones

## Downhill Assist Control system (DAC) (if equipped)

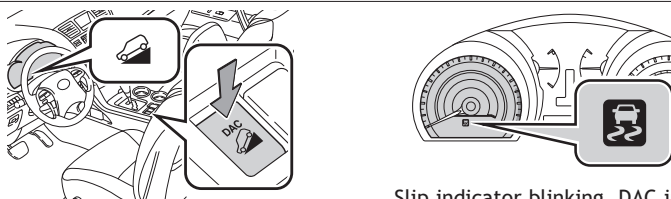

DAC indicator blinking = DAC not engaged

Slip indicator blinking, DAC indicator solid = DAC engaged

DAC helps the vehicle to descend steep hills while maintaining a low speed without brake pedal operation. Press the “DAC” button (system will engage only when shifter is in S1 or R mode). Pressing the button again will turn system off.

Refer to the *Owner’s Manual* for more details.

## Hill-start Assist Control (HAC)

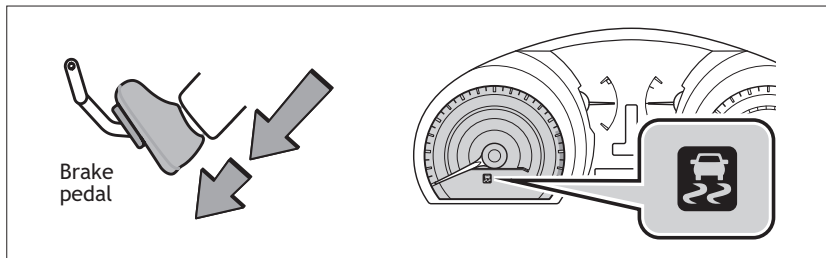

HAC helps prevent rolling backwards on an incline. To engage, push further down on brake pedal while at a complete stop until a beep sounds and slip indicator illuminates. HAC holds for approximately 2 seconds after releasing brake pedal.

Refer to the *Owner's Manual* for more details.

## Cup holders

### Front

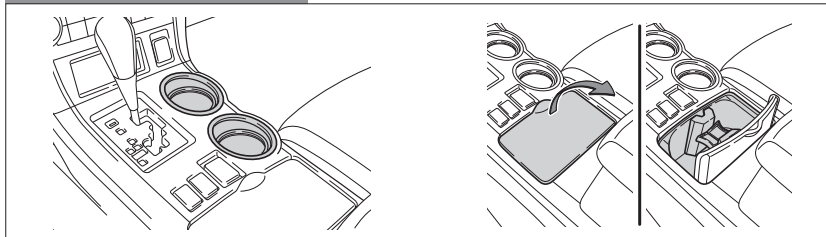

### Console box

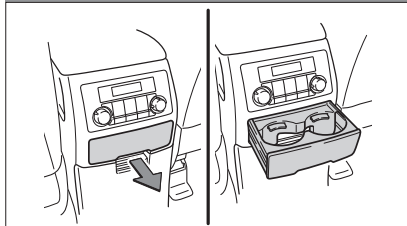

### Rear

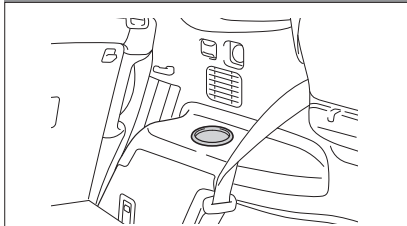

### Side table

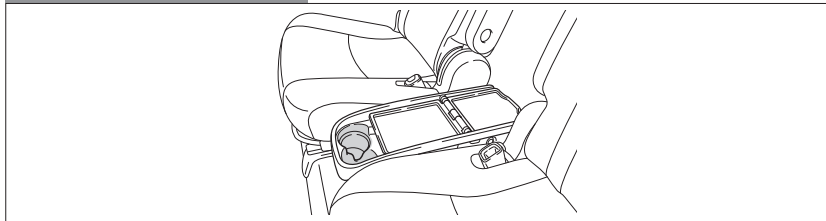

# SAFETY AND EMERGENCY FEATURES

## Seatbelts

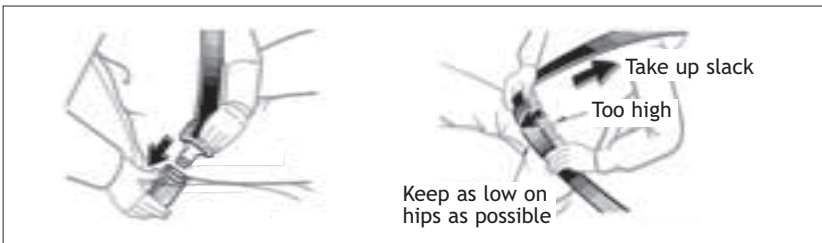

If belt is fully extended, then retracted even slightly, it cannot be re-extended beyond that point, unless fully retracted again. This feature is used to help hold child restraint systems securely.

To find more information about seatbelts, and how to install a child restraint system, refer to the *Owner's Manual*.

## Tire Pressure Monitoring (warning) System

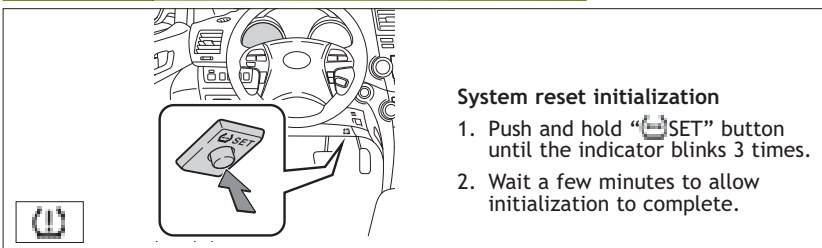

### System reset initialization

1. Push and hold “SET” button until the indicator blinks 3 times.
2. Wait a few minutes to allow initialization to complete.

After adjusting tire pressures, or after tires have been rotated or replaced, turn the ignition switch to “ON” and press and hold the “SET” button until indicator blinks three times. Let the vehicle sit for a few minutes to allow initialization to complete.

Refer to the load label on the door jamb or the *Owner's Manual* for tire inflation specifications.

If the tire pressure indicator flashes for more than 60 seconds and then remains on, take the vehicle to your local Toyota dealer.

**Note:** The warning light may come on due to temperature changes or changes in tire pressure from natural air leakage. If the system has not been initialized recently, setting the tire pressures to factory specifications should turn off the light.