

2009 Quick Reference Guide

V E N Z A

2009 Venza

This *Quick Reference Guide* is a summary of basic vehicle operations. It contains brief descriptions of fundamental operations so you can locate and use the vehicle's main equipment quickly and easily.

The *Quick Reference Guide* is not intended as a substitute for the *Owner's Manual* located in your vehicle's glove box. We strongly encourage you to review the *Owner's Manual* and supplementary manuals so you will have a better understanding of your vehicle's capabilities and limitations.

Your dealership and the entire staff of Toyota Motor Sales, U.S.A., Inc. wish you many years of satisfied driving in your new Venza.

! A word about safe vehicle operations

This *Quick Reference Guide* is not a full description of Venza operations. Every Venza owner should review the *Owner's Manual* that accompanies this vehicle.

Pay special attention to the boxed information highlighted in color throughout the *Owner's Manual*. Each box contains safe operating instructions to help you avoid injury or equipment malfunction.

All information in this *Quick Reference Guide* is current at the time of printing. Toyota reserves the right to make changes at any time without notice.

INDEX

OVERVIEW

Engine maintenance	9
Fuel tank door release and cap	8
Hood release	8
Indicator symbols	4-5
Instrument cluster	4
Instrument panel	2-3
Keyless entry^{1,2}	6
Light control-Instrument panel	9
Smart Key system^{1,2}	7

FEATURES/OPERATIONS

Air Conditioning/Heating	16-17
Audio	18-19
Auto lock functions¹	11
Automatic Transmission	10
Cruise control	20
Customizable features	23
Garage door opener (HomeLink®) ³	21
Lights^{1,2} & turn signals	14-15
Moonroof	13
Multi-information display (clock)²	22
Parking brake	10
Power outlets-12V DC	21
Power outlet-120V AC	21
Rear seat entertainment system	20
Seat adjustments-Front	11
Seat adjustments-Rear	11
Seat heaters	16
Seats-Head restraints	12
Seats-Folding rear row seats	12
Tilt and telescopic steering wheel	10
Telephone controls (Bluetooth®)	23
VSC OFF button	17
Windows-Power	13
Windshield wipers & washers	15

SAFETY AND

EMERGENCY FEATURES

Door locks^{1,2}	24
Doors-Child safety locks	25
Seatbelts	24
Seatbelts-Shoulder belt anchor	24
Spare tire & tools	25
Tire Pressure Monitoring (warning) System	24

¹ Visit your Toyota dealer for information on customizing this feature.

² Programmable by customer. Refer to the Owner's Manual for instructions and more information.

³ HomeLink® is a registered trademark of Johnson Controls, Inc.

OVERVIEW

Instrument panel

Steering wheel controls

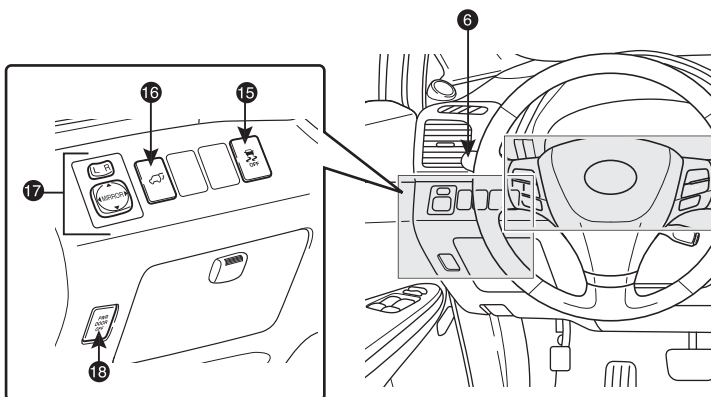
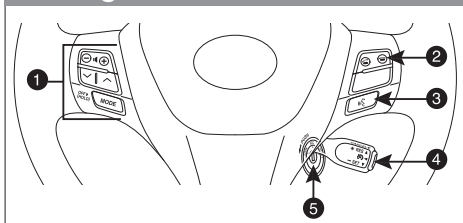

- 1 Steering wheel audio controls
- 2 Telephone controls^{1,2}
- 3 Voice command button^{1,2}
- 4 Cruise control
- 5 Engine switch (standard key)¹
- 6 Headlight, turn signal and front fog light¹ controls
- 7 Wiper and washer controls
- 8 “ENGINE START STOP” switch (Smart Key)¹
- 9 Multi-information display
- 10 Audio system²
- 11 Emergency flasher button
- 12 Multi-information display switches

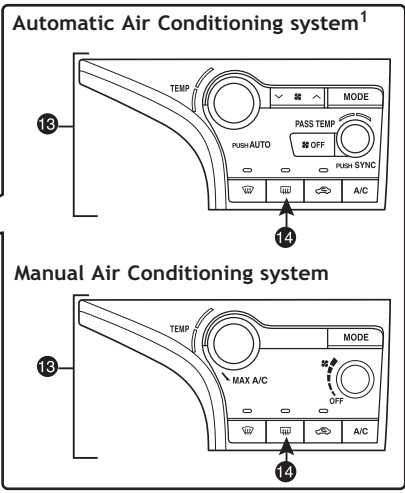
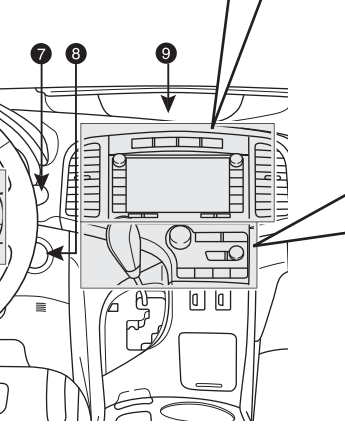
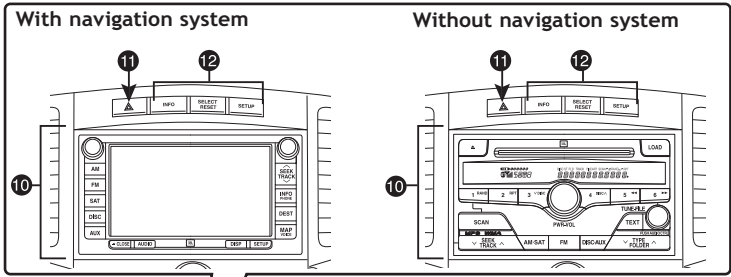

- 13 Air Conditioning controls
- 14 Outside rearview mirrors¹/Rear window defogger button/Windshield wiper de-icer¹
- 15 VSC/TRAC OFF switch
- 16 Power back door switch¹
- 17 Power rearview mirror controls
- 18 Power back door main switch¹

¹ If equipped

² Vehicles with navigation system: for details, refer to the “Navigation System Owner’s Manual.”

Instrument cluster

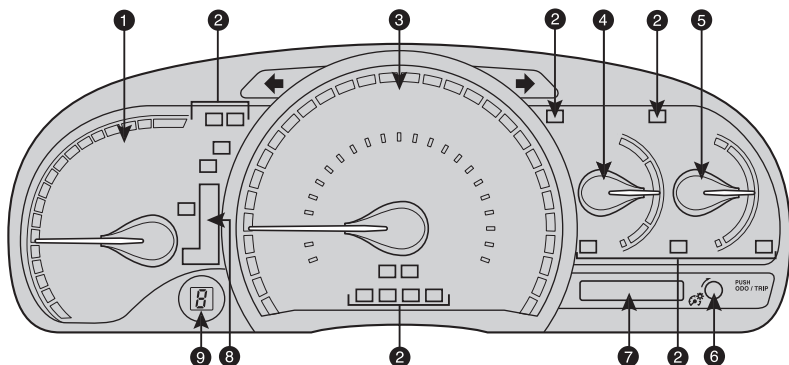

- ❶ Tachometer
- ❷ Service indicator and reminder
- ❸ Speedometer
- ❹ Fuel gauge
- ❺ Engine coolant temperature
- ❻ Odometer/Trip meter and trip meter reset button/Instrument panel light control
- ❼ Odometer and two trip meters
- ❽ Automatic Transmission shift position indicator
- ❾ Automatic Transmission shift range display

Indicator symbols

For details, refer to “Indicators and warning lights,” Section 2-2, 2009 Owner’s Manual.



Brake system warning¹



Driver seatbelt reminder¹
(alarm will sound if speed is over 12 mph)



Front passenger seatbelt reminder¹
(alarm will sound if speed is over 12 mph)



Charging system warning¹



AIR BAG ON and AIR BAG OFF indicator

























Malfunction/Check Engine indicator¹



Active torque control 4WD system warning¹

¹ If indicator does not turn off within a few seconds of starting engine, there may be a malfunction. Have vehicle inspected by your Toyota dealer.

² If this light flashes, refer to “Cruise control,” Section 2-4, 2009 Owner’s Manual.

-  Electric power steering system warning¹
-  Low windshield washer fluid level warning¹
-  Smart Key system warning¹
-  Low fuel level warning¹
-  Open door warning¹
-  Airbag SRS warning¹
-  Master warning¹
-  Low Tire Pressure Warning¹
-   Headlight low/high beam indicator
-  Turn signal indicator
-  Fog light indicator
-  Slip indicator
-  **SET** Cruise control indicator²
-  **ABS** Anti-lock Brake System warning¹
-  **AUTO** Automatic high beam indicator³
-  Security indicator
-  **OFF** Vehicle Stability Control OFF indicator
-  **TRAC OFF** Traction Control OFF indicator
-  Low Engine oil pressure warning¹
-  Automatic headlight leveling system warning¹
-  **MAINT REQD** Engine oil replacement reminder¹

³ For details, refer to "Headlight switch," Section 2-3, 2009 Owner's Manual.

Keyless entry

Locking operation

Without Smart Key system



With Smart Key system



Push



Unlocking operation

Without Smart Key system



With Smart Key system



Push ONCE: Driver door
TWICE: All doors



NOTE: If a door is not opened within 60 seconds of unlocking, all doors will relock for safety.

Panic button

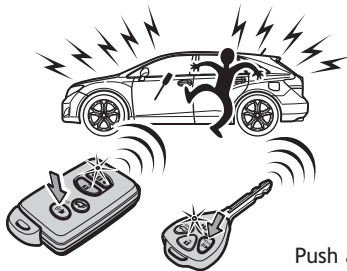

Push and hold



Smart Key system (if equipped)

Start function

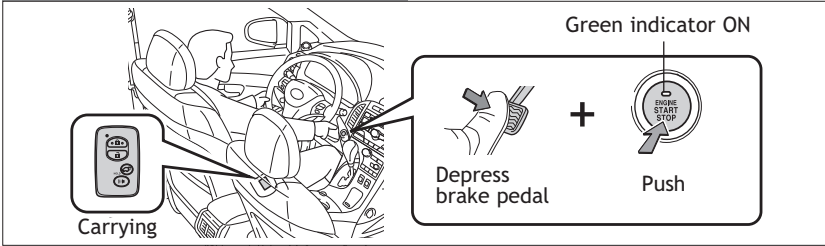

NOTE: Gear shift lever must be in Park and brake pedal depressed.

Power (without starting engine)

Without depressing the brake pedal, pressing the “ENGINE START STOP” switch will change the operation mode in succession from:

ACCESSORY

Accessories such as the radio will operate.

ON

Power ON; the engine not running.

OFF

All systems OFF.

Locking operation

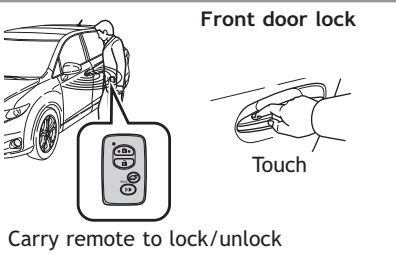

Unlocking operation

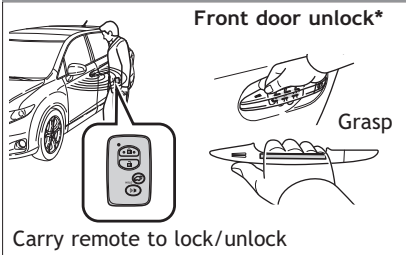

Back door lock/unlock

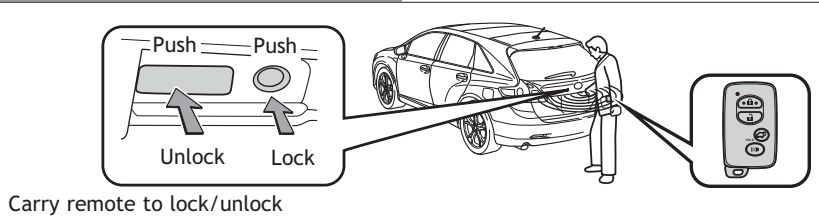

* Driver door unlocking function can be programmed to unlock driver door only, or all doors. Grasping passenger door handle will unlock all doors.

NOTE: Doors may also be locked/unlocked using remote.

Fuel tank door release and cap

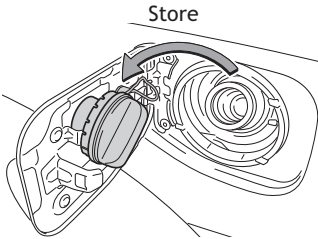
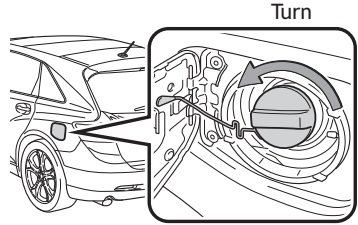
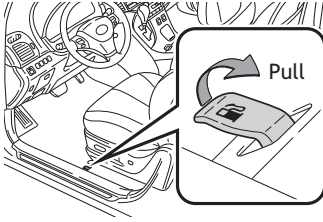

NOTE: Tighten until one click is heard. If the cap is not tightened enough, Check Engine “” indicator may illuminate.

Hood release

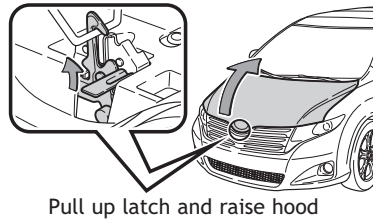
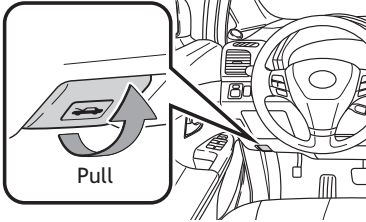

Engage support rod

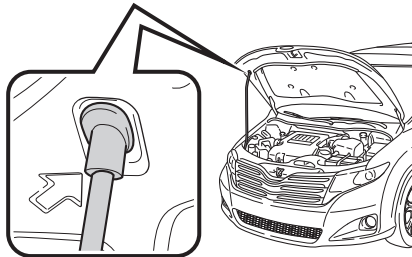

Light control-Instrument panel

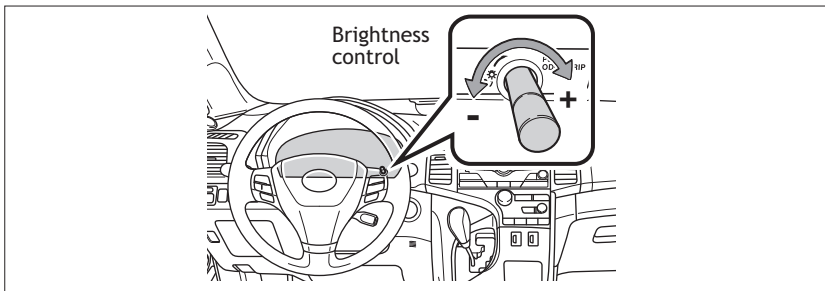

Engine maintenance

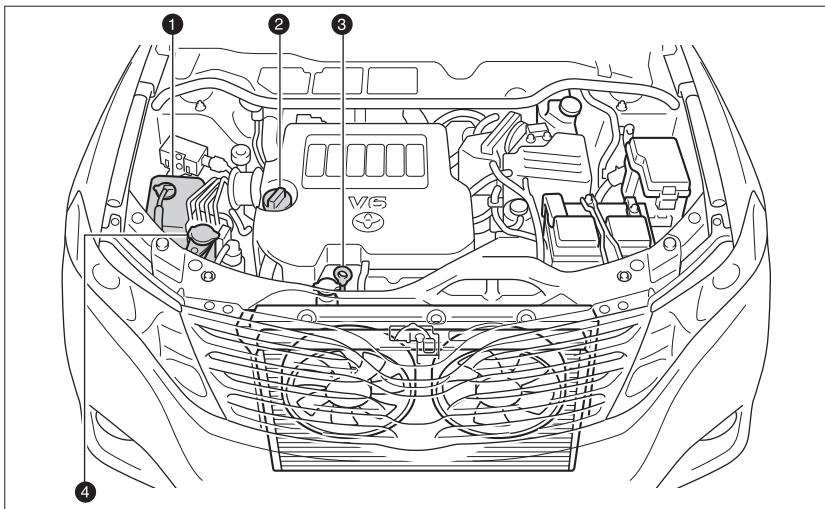

- ① Engine coolant reservoir
- ② Engine oil filler cap
- ③ Engine oil level dipstick
- ④ Windshield washer fluid tank

Note: Regularly scheduled maintenance, including oil changes, will help extend the life of your vehicle and maintain performance. Please refer to the “Owner’s Warranty Information Booklet,” “Scheduled Maintenance Guide” or “Owner’s Manual Supplement.”

FEATURES/OPERATIONS

Automatic Transmission

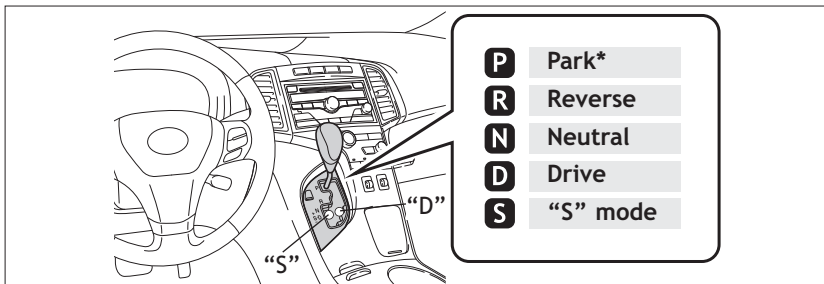

* The "ENGINE START STOP" switch/engine switch must be "ON" and the brake pedal depressed to shift from Park.

"S" (Sequential) mode

Shift the shift lever to "S" position from "D" position.

Floor shift type:

- + : Upshift (push and release)
- : Downshift (pull and release)

Downshifting increases power going uphill, or provides engine braking downhill. For best fuel economy during normal driving conditions, always drive with the shift lever in the "D" position.

Parking brake

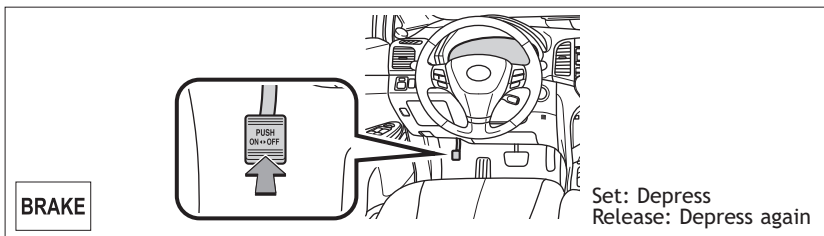

Tilt and telescopic steering wheel

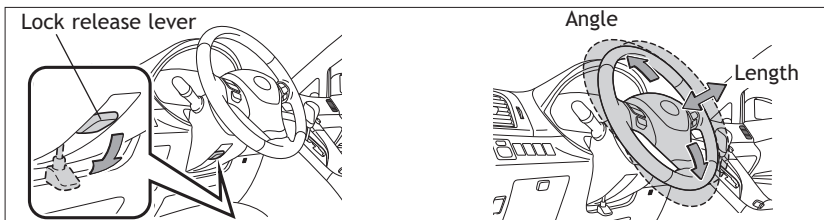

Hold wheel, push lever down, set angle and length, and return lever.

Note: Do not attempt to adjust while the vehicle is in motion.

Auto lock functions

Automatic door locks can be programmed to operate in two different modes, or turned OFF.

- Doors lock when shifting from Park.
- Doors lock when the vehicle speed is approximately 12 mph or higher.
- Doors unlock when shifting into Park.
- Doors unlock when the driver's door is opened within 10 seconds after turning the "ENGINE START STOP" switch or engine switch OFF.

Refer to the *Owner's Manual* for more details.

Seat adjustments-Front

Manual seat



Power seat (if equipped)

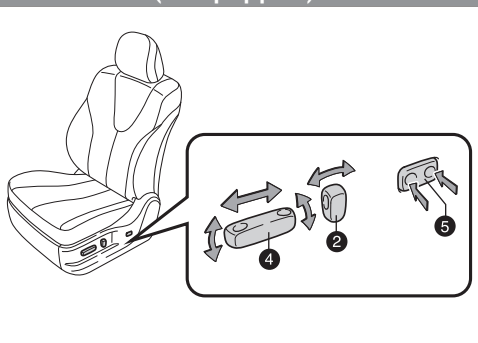

- ① Seat position (forward/backward)
- ② Seatback angle
- ③ Height crank (driver side only)
- ④ Seat position; cushion angle and height (driver side only)
- ⑤ Lumbar support

Seat adjustments-Rear

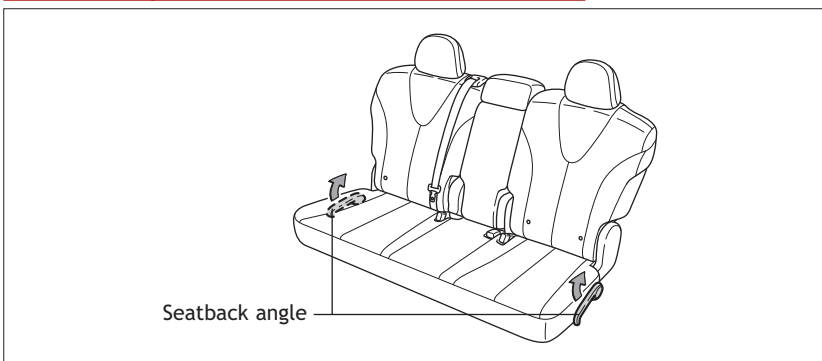

Refer to the *Owner's Manual* for more details.

Seats-Head restraints

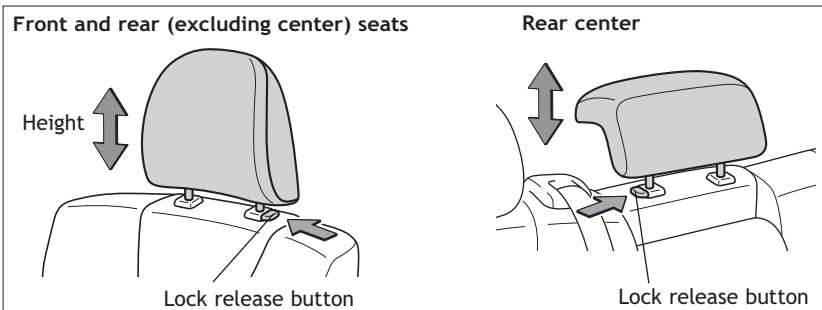

Seats-Folding rear row seats

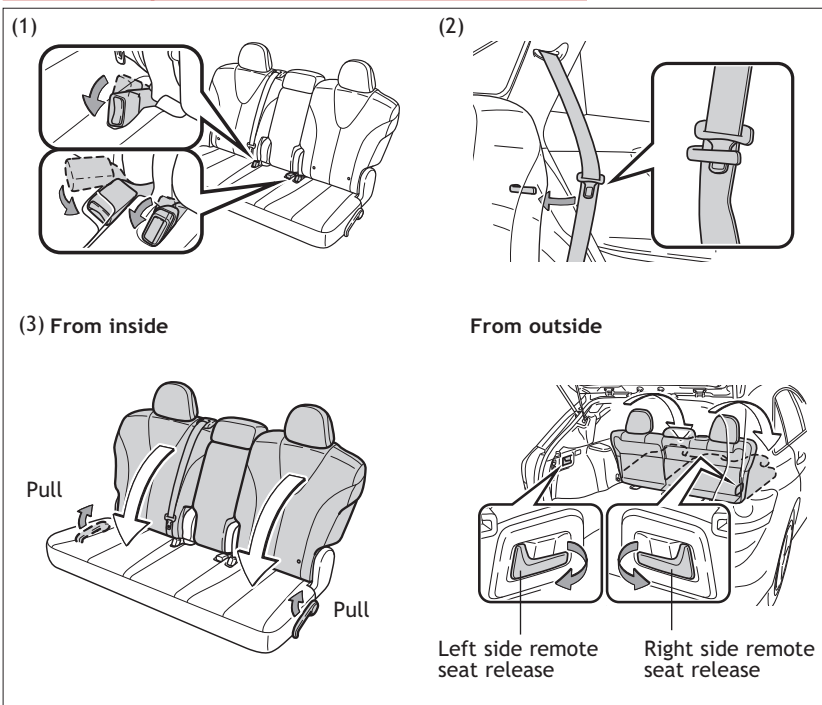

- (1) Stow the seatbelt buckles.
- (2) Hook the seatbelt to the seatbelt hangers.
- (3) Fold down the seatbacks.

Windows-Power

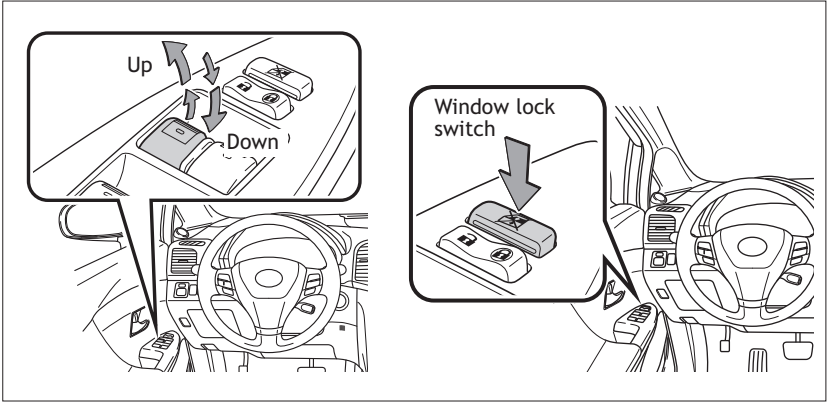

Automatic operation Push the switch completely down or pull it completely up and release to fully open or close. To stop window midway, lightly push the switch in the opposite direction.

Window lock switch Deactivates all passenger windows. Driver's window remains operable.

Moonroof (if equipped)

Sliding operation

Push once to open partway; again to open completely.

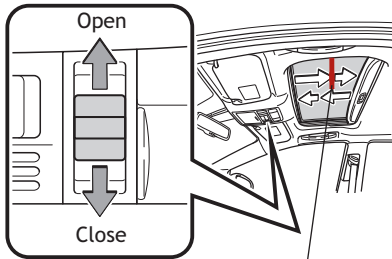

Recommended driving position to minimize wind noise.

Tilting operation

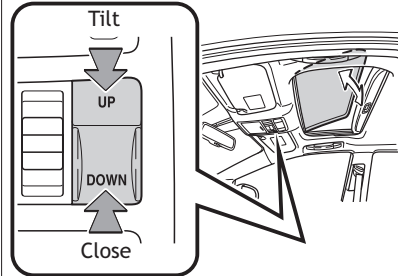

Lights & turn signals

Headlights

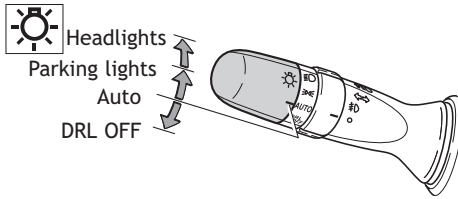

Without automatic high beam

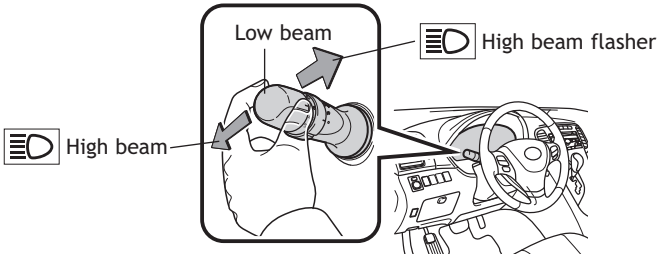

-**Daytime Running Light system (DRL)** Automatically turns on the headlights at a reduced intensity.

-**Automatic light cut off system** Automatically turns lights off after a delay of 30 seconds, or the lock switch on remote may be pushed after locking.

Automatic high beam (if equipped)

Activate*

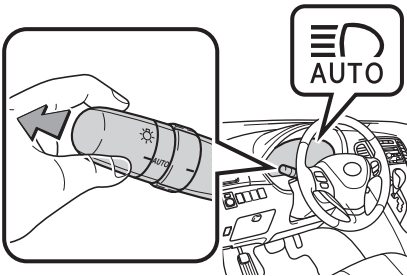

Manual high beam ON

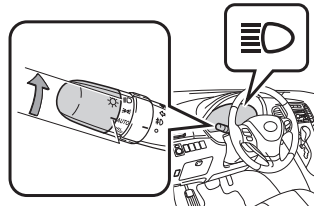

Deactivate

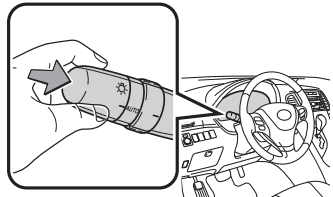

* Refer to the *Owner's Manual* for details on activating the automatic high beams.

Front fog lights (if equipped)

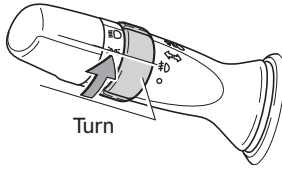

Front fog lights come on only when the headlights are on low beam.

Turn signals

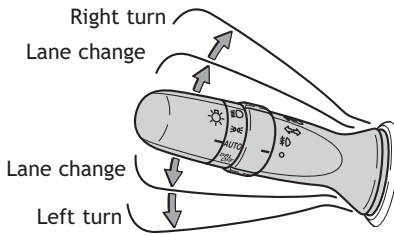

Windshield wipers & washers

Front

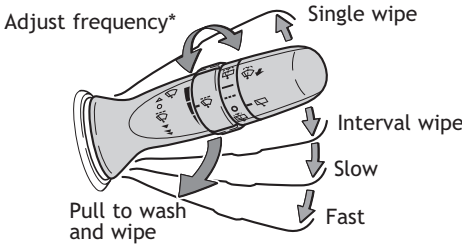

*** Intermittent windshield wiper frequency adjustment**
 Rotate to increase/decrease wipe frequency.

Rear

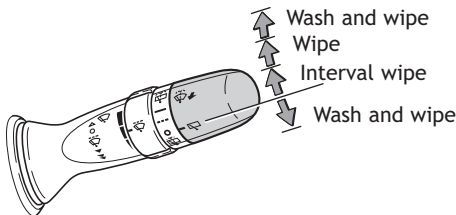

Seat heaters (if equipped)

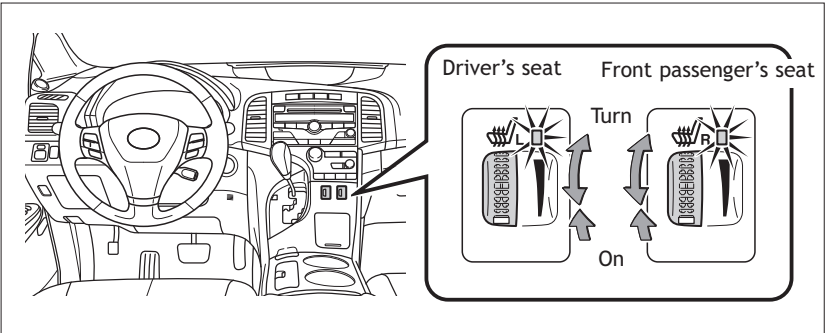

Air Conditioning/Heating

Manual Air Conditioning

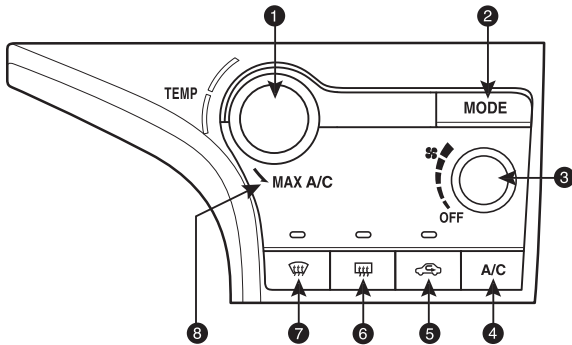

- 1 Temperature selector
- 2 Airflow vent
In “” mode, use fresh air (“” indicator OFF) to reduce window fogging. “” mode uses fresh air only.
- 3 Fan speed
- 4 Air Conditioning ON/OFF
Use fresh air to quickly cool interior, then change to recirculate for cooler air.
- 5 Fresh or recirculated cabin air
- 6 Rear window defogger/Windshield wiper de-icer (if equipped)
- 7 Windshield defogger
- 8 Select for maximum cooling. Air intake will automatically be set to recirculate. It is not possible to change intake to fresh, or to turn A/C OFF in this mode.

Automatic Air Conditioning (if equipped)

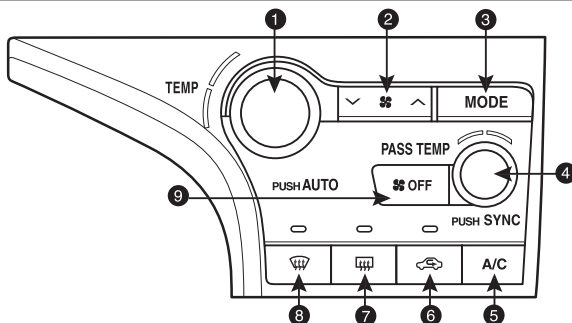

- 1** Push: Automatic climate control ON
Adjusting the temperature setting will cause the airflow vents, air intake and fan to adjust automatically.
Turn: Temperature selector (driver side)
- 2** Fan speed
- 3** Airflow vent
In “” mode, use fresh air (“” indicator OFF) to reduce window fogging. “” mode uses fresh air only.
- 4** Push: Dual operation ON/OFF
Separate temperature setting or synchronize temperature setting for driver and passenger.
Turn: Temperature selector (front passenger side)
- 5** Air Conditioning ON/OFF
- 6** Fresh or recirculated cabin air
- 7** Outside rearview mirror/Rear window defogger/Windshield wiper de-icer (if equipped)
- 8** Windshield defogger
- 9** Climate control OFF

VSC OFF button

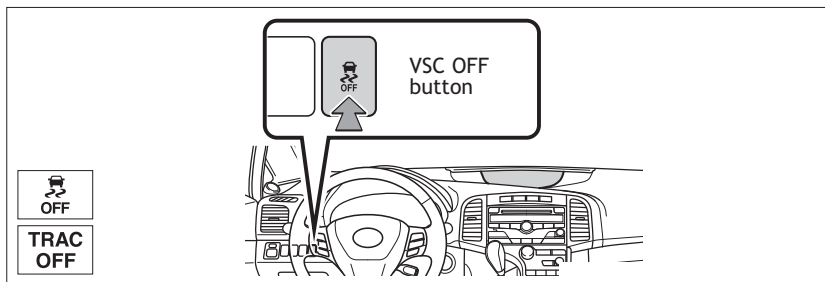

The VSC OFF button is used to switch between modes related to the TRAC and VSC functions.

Refer to Section 2-4 of the *Owner's Manual* for more information.

Audio

Type 1

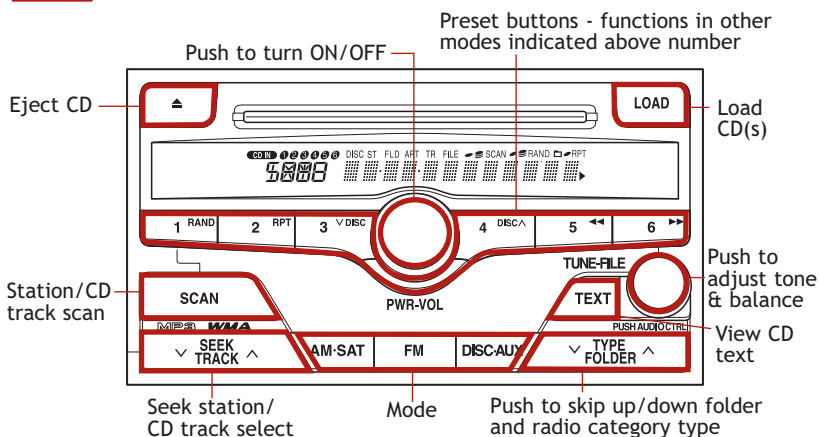

Type 2 with JBL

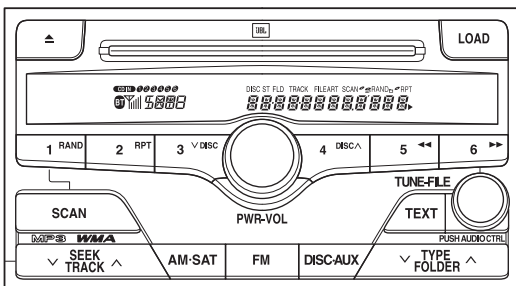

Type 3 with CD changer controller

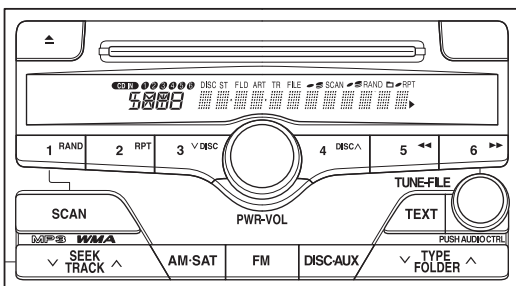

CD PLAYER

To scan tracks on a disc Push and hold “SCAN.” Push again to hold selection.

CD changer (Types 1 and 2 only)

-To load one disc Push “LOAD” and insert one disc.

-To load multiple discs Push and hold “LOAD” until you hear a beep.

Insert one disc. Shutter will close and then re-open for next disc.

To select a file (MP3/WMA only) Turn “TUNE-FILE” or either side of “SEEK TRACK.”

To select a folder (MP3/WMA only) Push either side of “TAPE FOLDER.”

RADIO

To preset stations Tune in the desired station and hold down a preset button (1-6) until you hear a beep. Push desired preset button (1-6) to select.

To scan stations Push and hold “SCAN” to scan preset stations. Push again to hold selection.

AUX audio jack

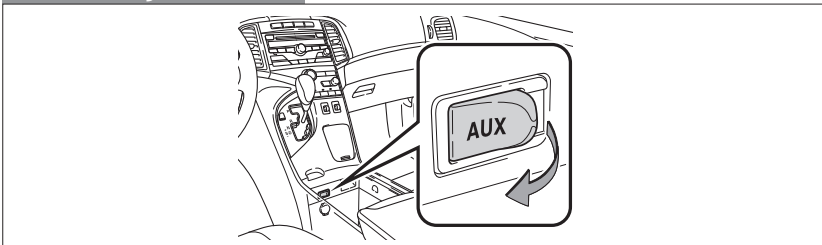

By inserting a mini plug into the AUX audio jack, you can listen to music from a portable audio device through the vehicle’s speaker system while in AUX mode.

Steering wheel switches

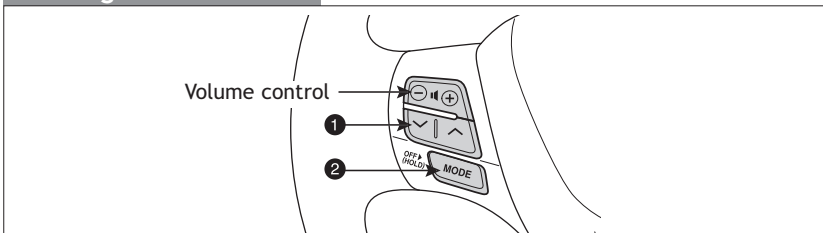

1 “V Λ”

-In radio mode Push to select a preset station; push and hold to seek the next strong station.

-In CD mode Push to skip up or down to next/previous track.

2 “MODE”

Push to turn audio ON and to select an audio mode. Push and hold to turn audio system OFF.

Rear seat entertainment system (if equipped)

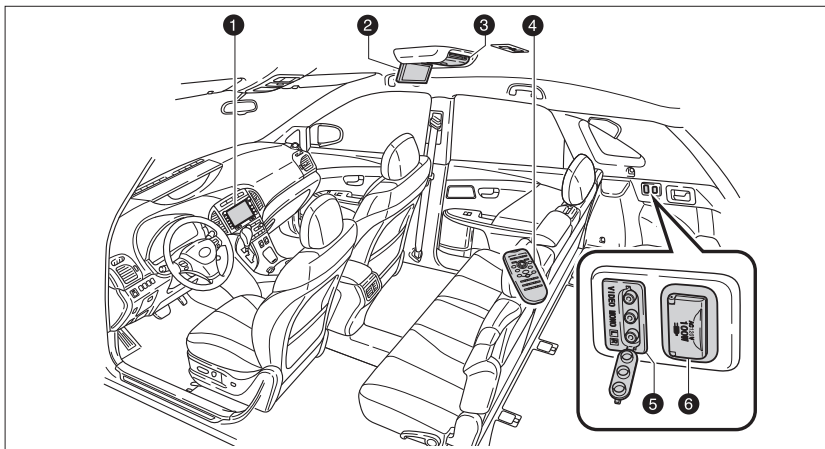

- 1 Front audio system
- 2 Display
- 3 DVD player
- 4 Remote controller
- 5 A/V input adapter
- 6 120V AC Power outlet

Cruise control

Turning system ON/OFF

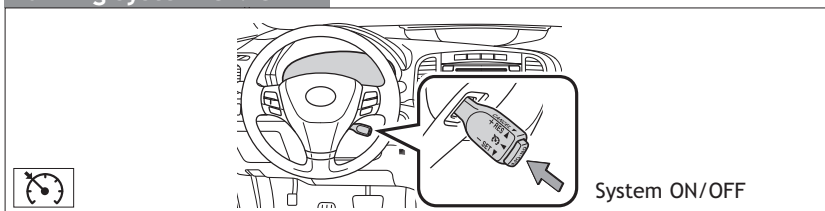

Functions

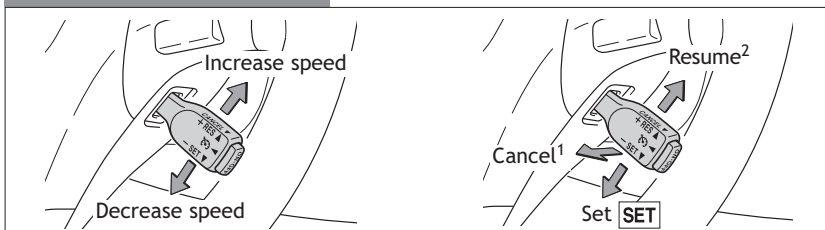

¹ The set speed may also be cancelled by depressing the brake pedal.

² The set speed may be resumed once vehicle speed exceeds 25 mph.

Power outlets-12V DC

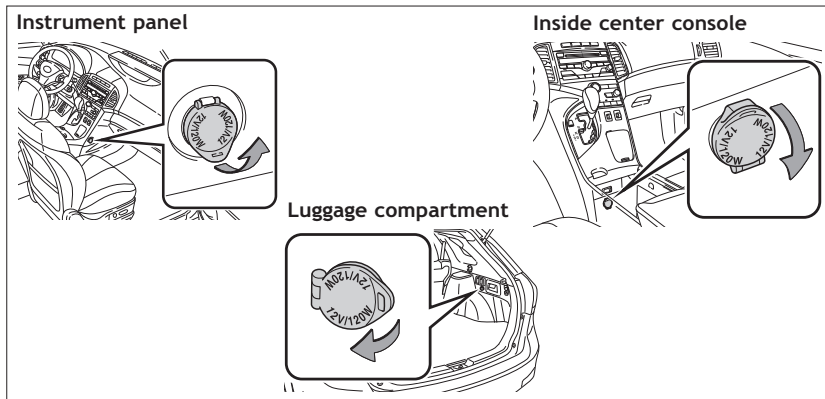

NOTE: Designed for car accessories. Engine switch/“ENGINE START STOP” switch must be in the ACCESSORY or ON position to be used.

Power outlet-120V AC (if equipped)

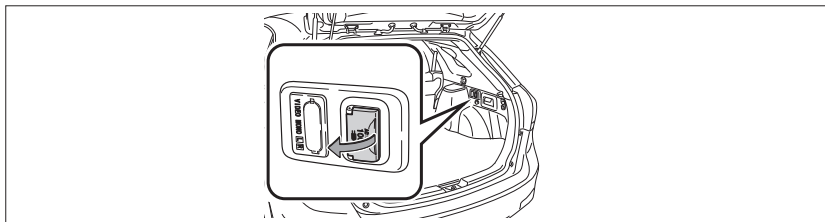

NOTE: Engine switch/“ENGINE START STOP” switch must be in the “ON” position to be used.

Garage door opener (HomeLink®)* (if equipped)

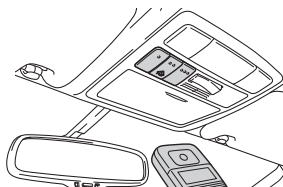

Garage door openers manufactured under license from HomeLink®* can be programmed to operate garage doors, estate gates, security lighting, etc.

Refer to “Garage door opener,” Section 3-7 in the *Owner’s Manual* for more details.

* HomeLink® is a registered trademark of Johnson Controls, Inc.

Multi-information display (clock)

TFT type*

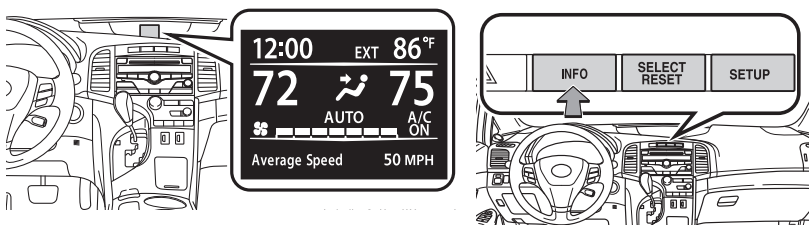

LCD type

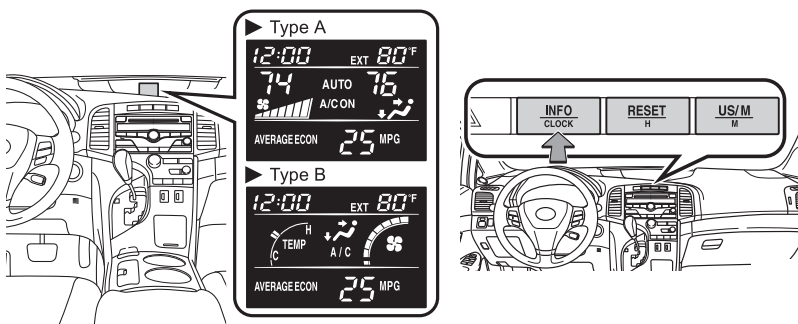

Push “INFO” or “INFO-CLOCK” to change information in the following:

- (1) Average fuel economy (AVERAGE ECON)
- (2) Current fuel economy (CURRENT ECON)
- (3) Distance to empty (RANGE)
- (4) Average speed (AVERAGE SPEED)
- (5) Trip timer (TFT type only)

Setting the clock

TFT type* (1) Press the “SETUP” button for the “Custom Settings” screen. (2) Select “Clock” on the Display Settings screen, and press the “SELECT RESET” button. (3) Press the “INFO” button to adjust the hours and the “SETUP” button to adjust the minutes. (4) Press the “SELECT RESET” button to set the clock.

LCD type (1) Press and hold the “INFO-CLOCK” button until part of the display begins to flash. (2) Press and hold the “RESET-H” button to adjust the hours and the “US/M-M” button to adjust the minutes. (3) Press the “INFO-CLOCK” button to complete the setting.

* On vehicles equipped with back-up camera

Telephone controls (Bluetooth®) (if equipped)

Audio unit

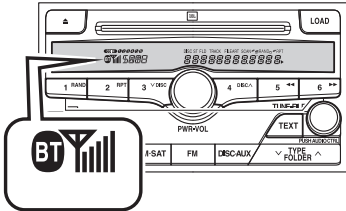

Microphone

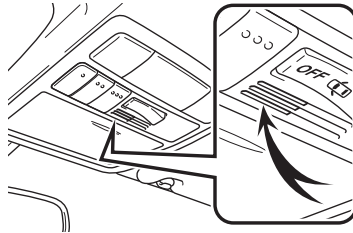

Steering wheel telephone switches

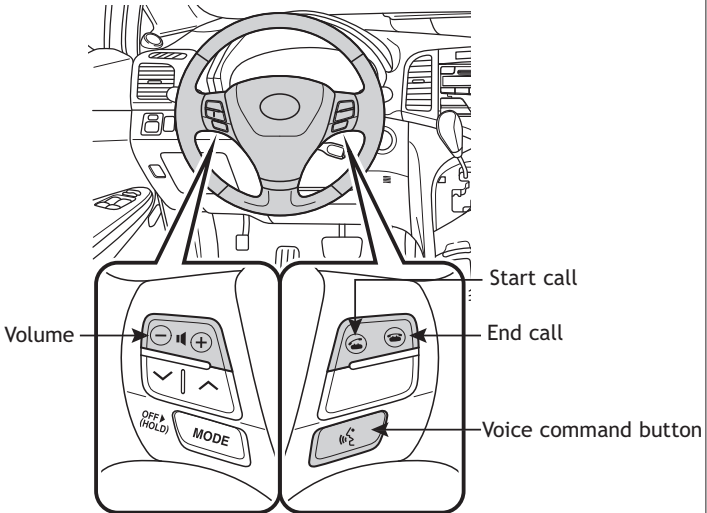

Bluetooth® technology allows dialing or receipt of calls without taking hands from the steering wheel or using a cable to connect the telephone and the system.

Refer to the *Navigation System Owner's Manual* or the *Owners Manual*.

Customizable features

If your vehicle has a TFT type* multi-information display, you will be able to customize certain electronic features. Press the "SETUP" button while stopped to access the "Custom Settings" screen.

Please see the *Owner's Manual* for details.

* On vehicles equipped with back-up camera

SAFETY AND EMERGENCY FEATURES

Door locks

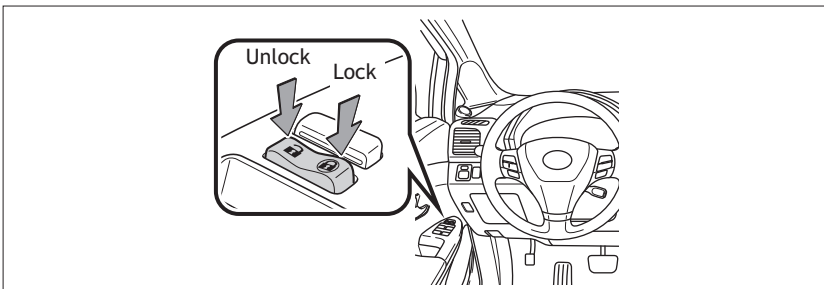

Seatbelts

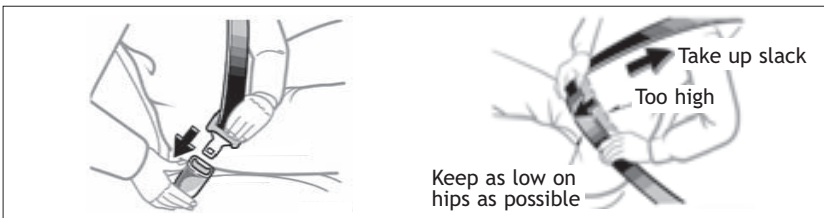

If belt is fully extended, then retracted even slightly, it cannot be re-extended beyond that point, unless fully retracted again. This feature is used to help hold child restraint systems securely.

To find more information about seatbelts, and how to install a child restraint system, refer to the *Owner's Manual*.

Seatbelts-Shoulder belt anchor

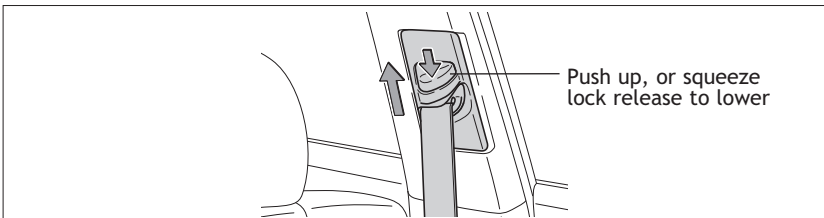

Tire Pressure Monitoring (warning) System

If tire pressure becomes critically low on any of the tires (excluding the spare), a  indicator will illuminate. Correctly adjusting tire inflation will turn off the light after a few minutes. If the light does not turn off, have the system checked by your Toyota dealer.

Refer to the *Owner's Manual* for more details.

Doors-Child safety locks

Rear door

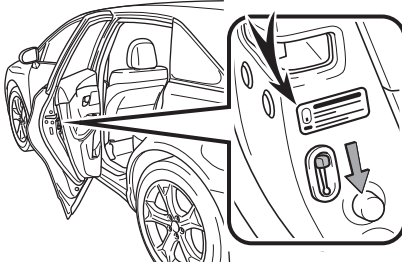

Moving the lever to “LOCK” will allow the door to be opened only from the outside.

Spare tire & tools

Tool location

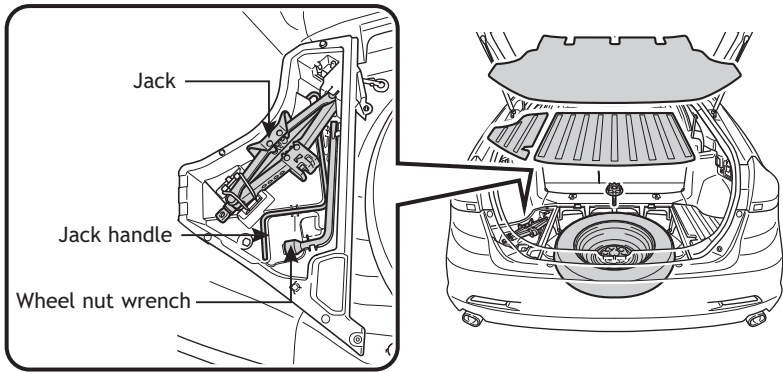

Removing the spare tire

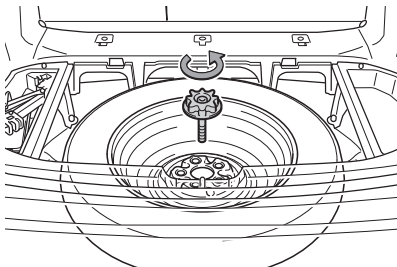

Loosen and remove the bolt

Refer to the *Owner's Manual* for tire changing and jack positioning procedures.



Customer Experience Center
1-800-331-4331